



Harry Potter



76431



LEGO® Builder



Get excited about our new packaging!

We're switching from plastic to paper-based packaging. That's why you might find a mix of paper and plastic in our boxes!

Nos nouveaux emballages vous emballeront !

Nous passons des emballages en plastique aux emballages à base de papier. C'est pourquoi vous pourriez trouver un mélange de papier et de plastique dans nos boîtes !

¡Te presentamos nuestros nuevos empaques!

Estamos sustituyendo las bolsas de plástico por bolsas con base de papel. ¡Por eso, puedes encontrar una mezcla de papel y de plástico en nuestras cajas!

[LEGO.com/sustainable-packaging](https://www.lego.com/sustainable-packaging)

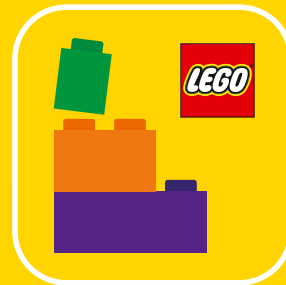

🔍 LEGO® Builder

BUILDER

Download on the
App Store

GET IT ON
Google Play

腾讯应用宝
安卓应用商店

Apple and the Apple logo are trademarks of Apple Inc., registered in the U.S. and other countries and regions. App Store is a service mark of Apple Inc. Google Play and the Google Play logo are trademarks of Google LLC. Tencent and the Tencent logo are trademarks of Tencent Inc.

🔍 LEGO.com/devicecheck

EN Ask parents' permission before going online | DE Eltern um Erlaubnis bitten, bevor du online gehst | FR Demande l'autorisation d'un parent avant d'aller en ligne | IT Chiedi il permesso ai tuoi genitori prima di andare online | ES Pídeles permiso a tus papás antes de conectarte a Internet | PT Pede autorização aos pais antes de acederes online | ZH 上网前应先征得父母的同意 | PL Poproś rodziców o zgodę, zanim wejdiesz do Internetu | CS Než půjdeš na internet, požádej rodiče o svolení | SK Skôr než pôjdeš na internet, vypýtaj si povolenie od rodičov | HU Kérj szülői engedélyt, mielőtt online csatlakoznál! | RO Cere permisiunea părinților înainte de a te conecta online | BG Поискайте разрешение от родител, преди да влезете онлайн | LV Pirms došanās tiešsaistē palūdz atļauju vecākiem | ET Enne Interneti kasutamist küsi vanematelt luba | LT Prieš prisijungdami prie interneto, atsklauskite tėvų

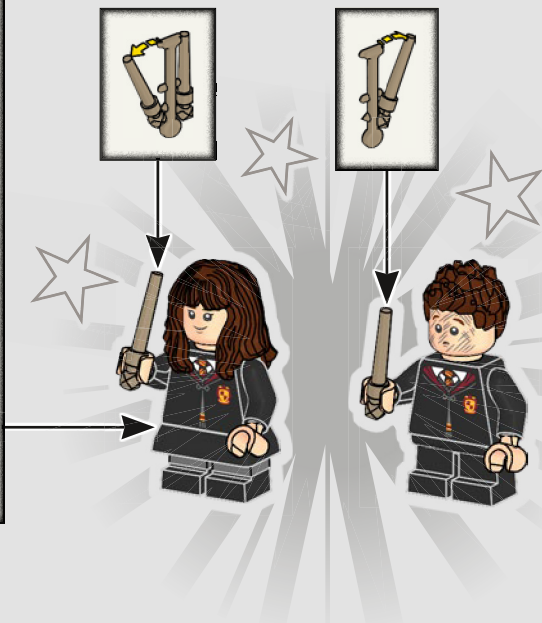
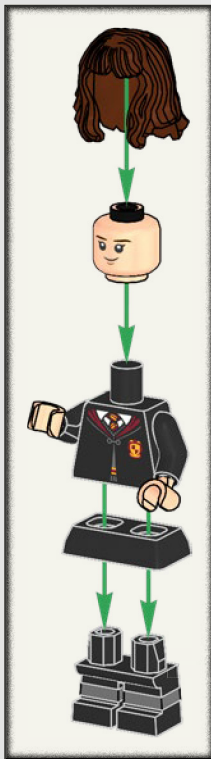

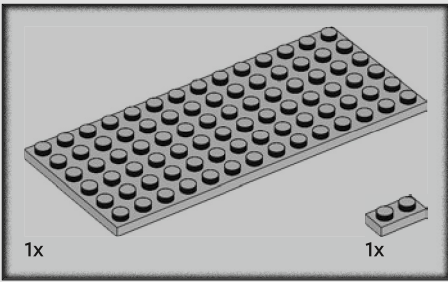

1

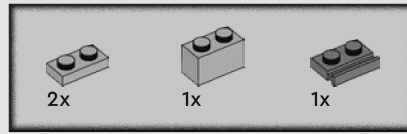
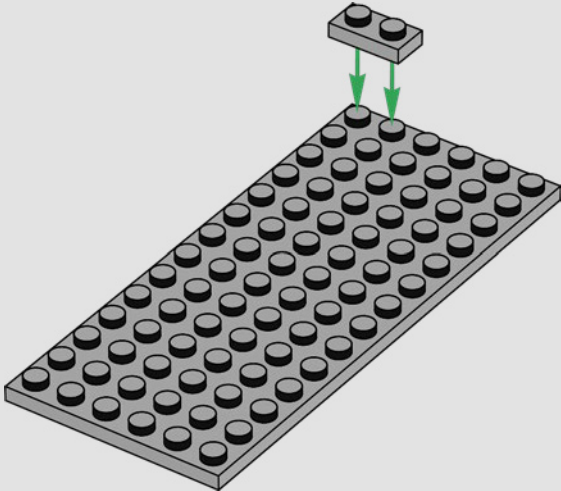

2

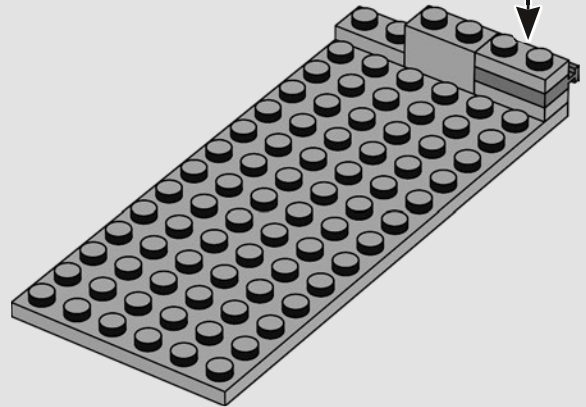
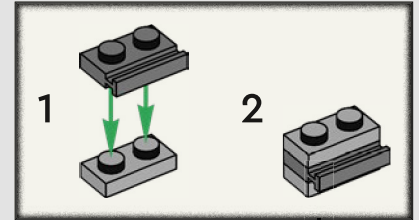

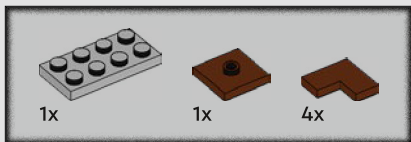

3

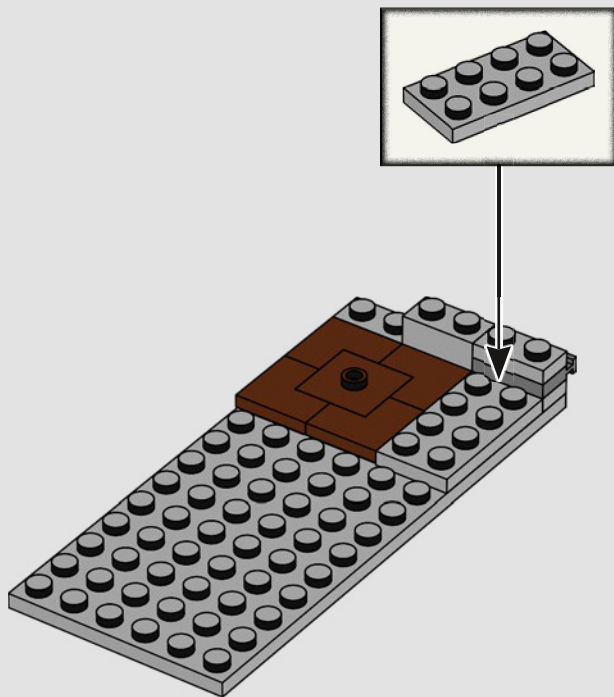

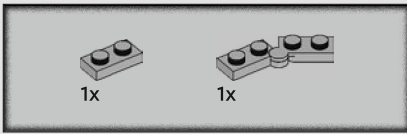

4

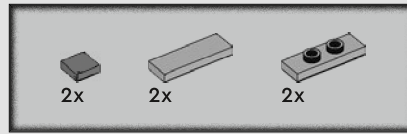
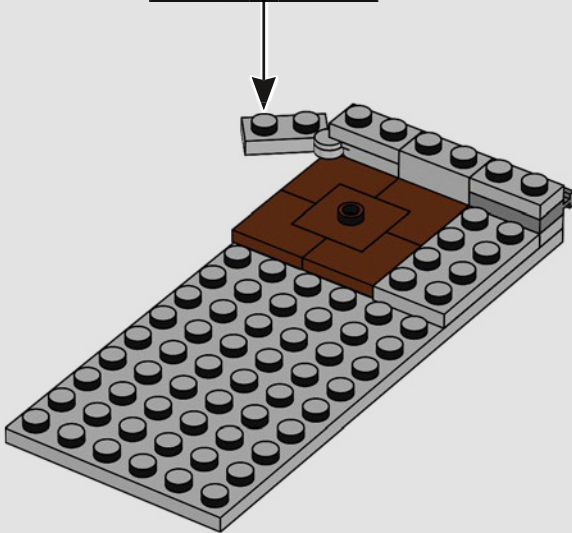
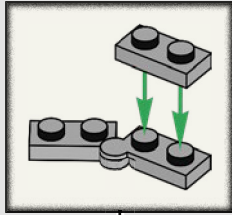

5

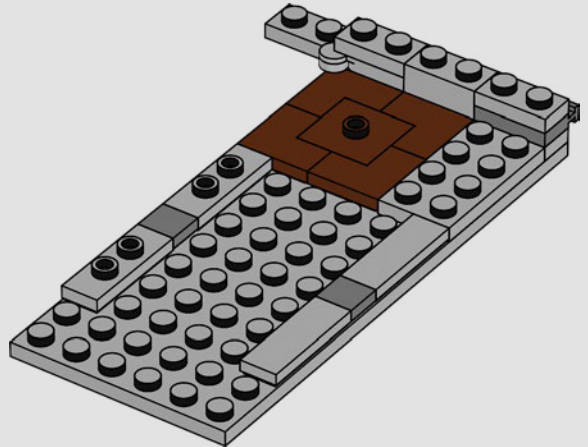

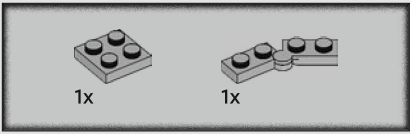

6

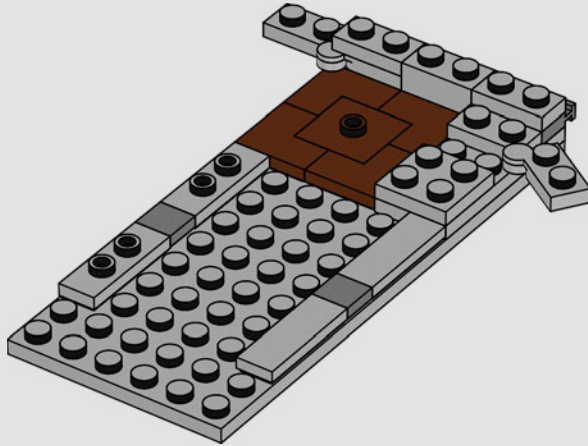

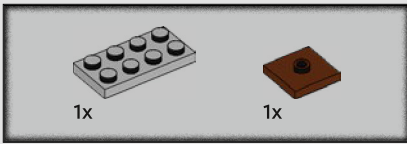

7

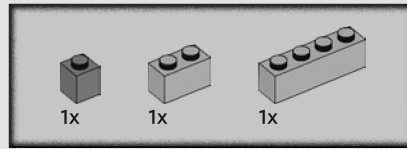
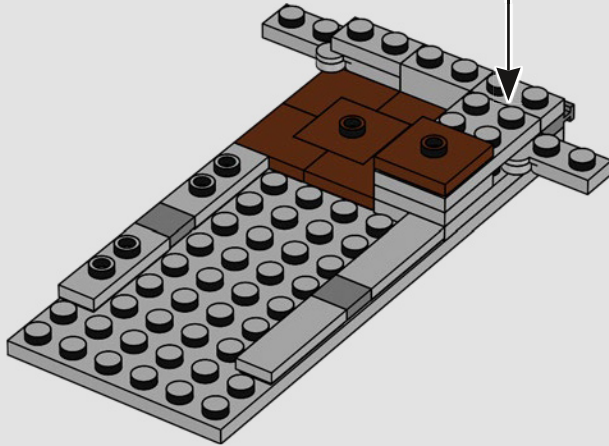
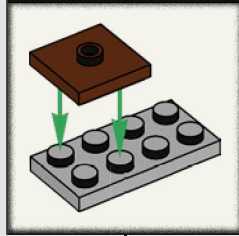

8

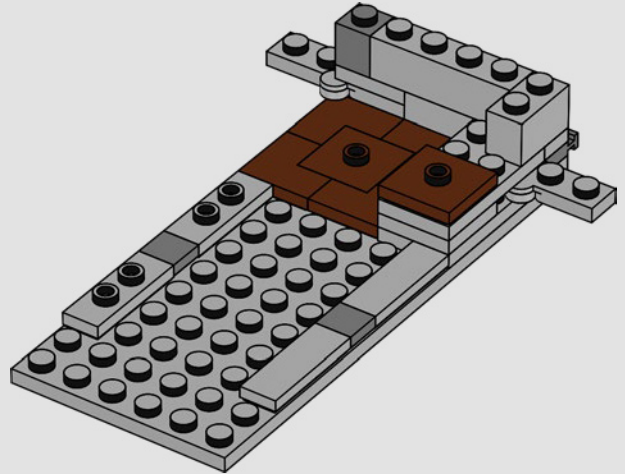

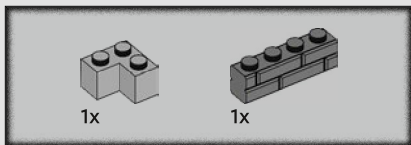

9

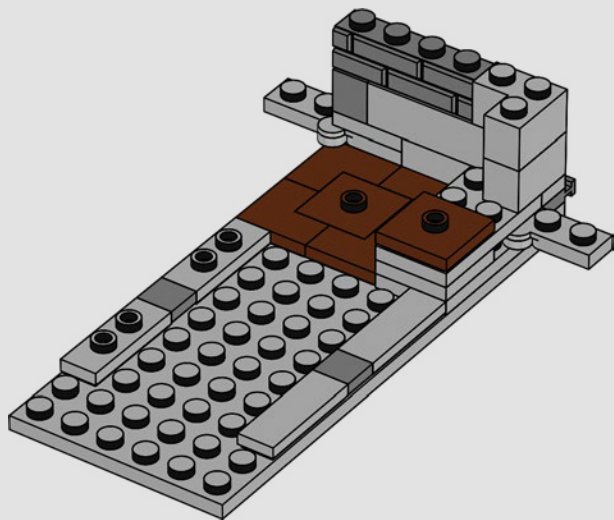

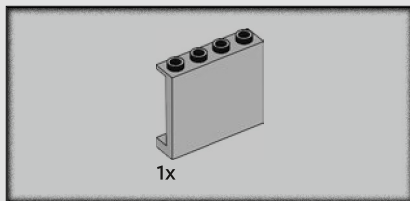

10

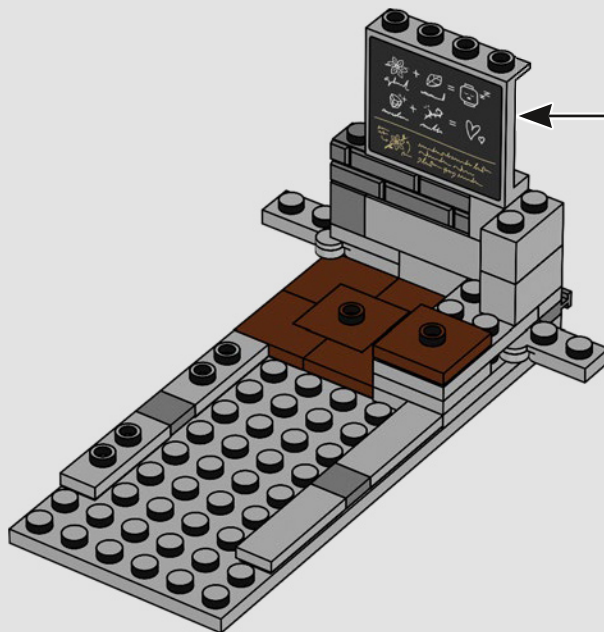
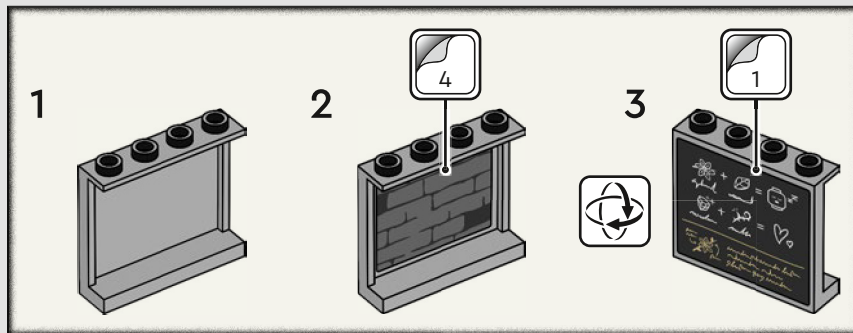

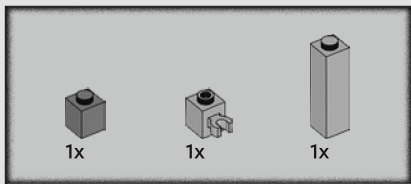

11

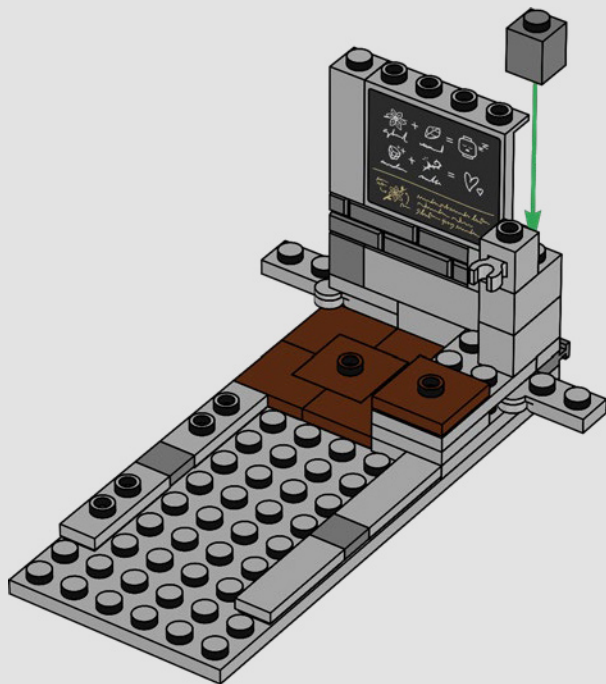

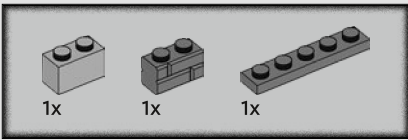

12

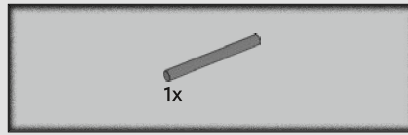
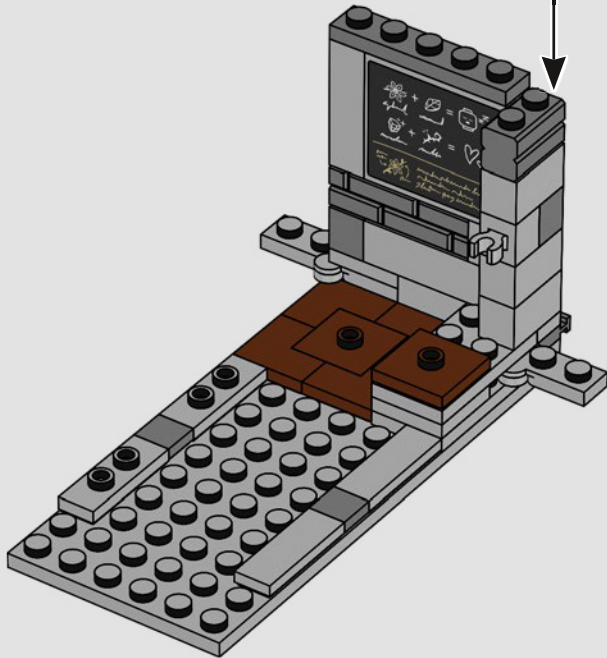
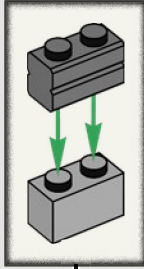

13

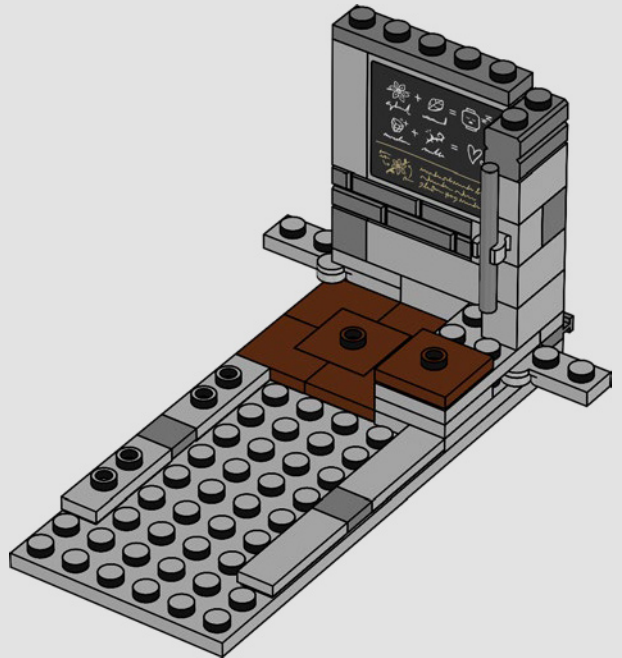

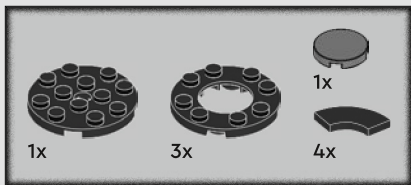

14

1

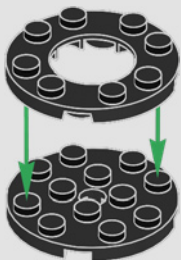

2

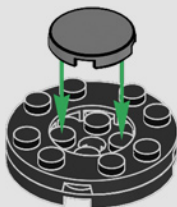

3

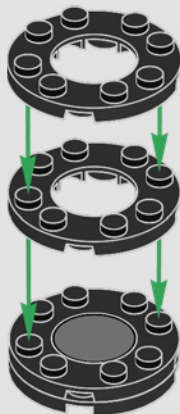

4

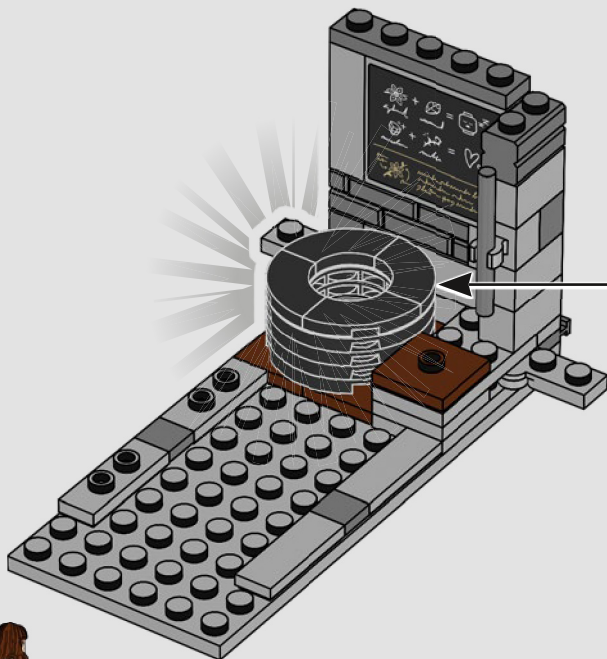
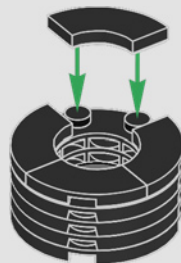

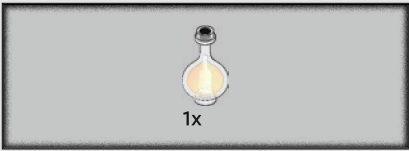

15

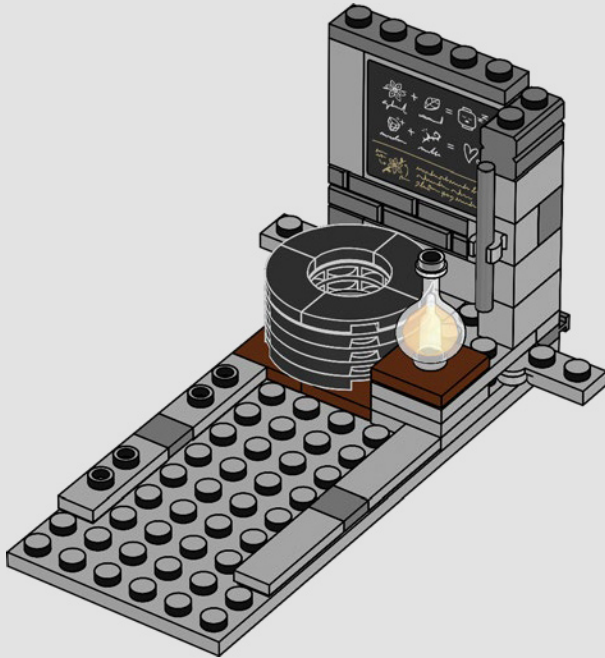

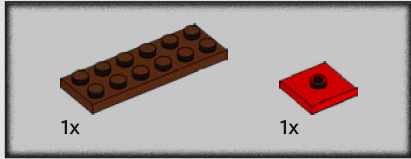
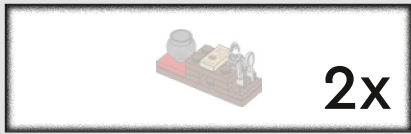

16

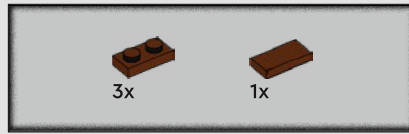
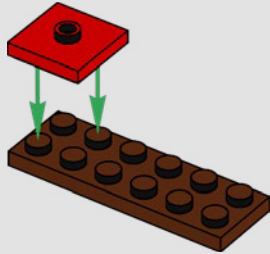

17

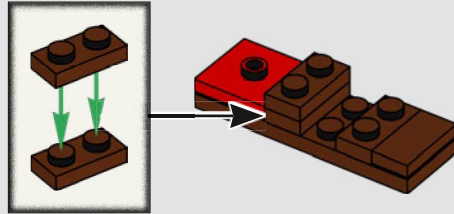

18

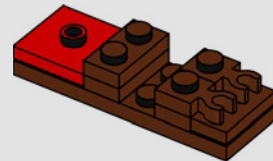

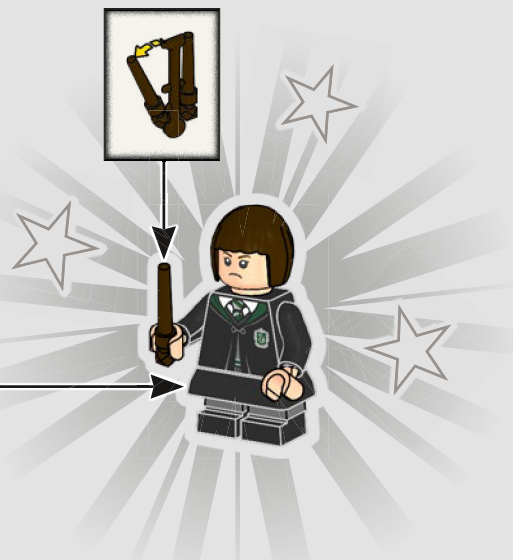
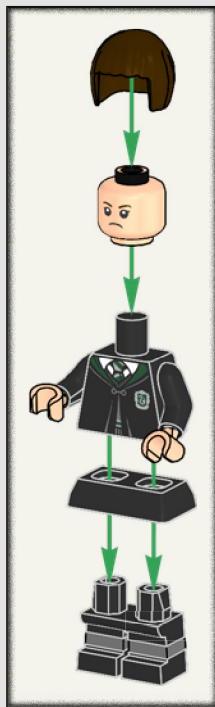

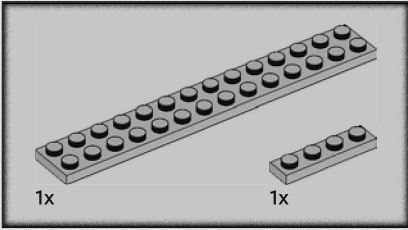
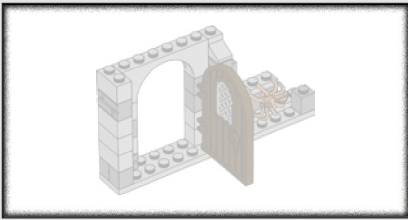

22

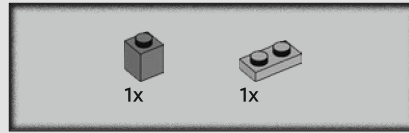
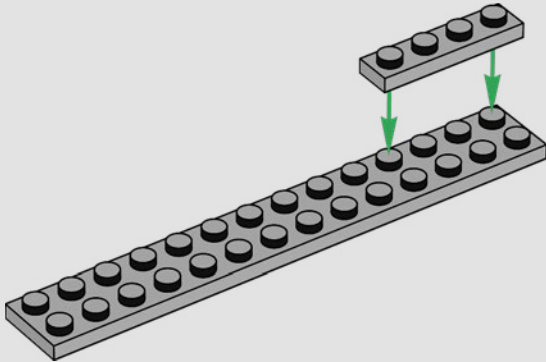

23

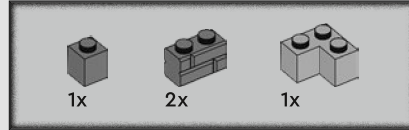
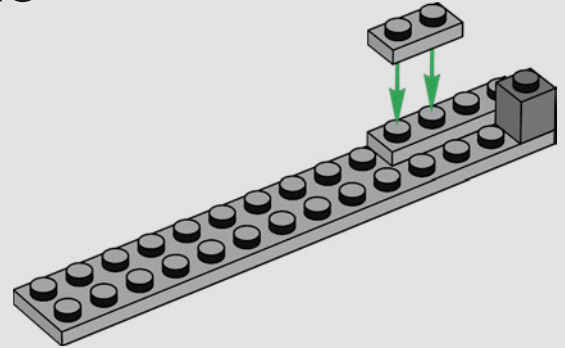

24

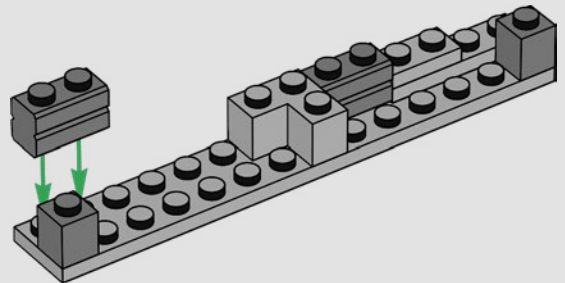

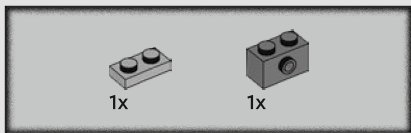

25

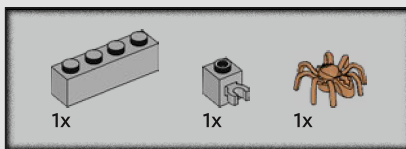
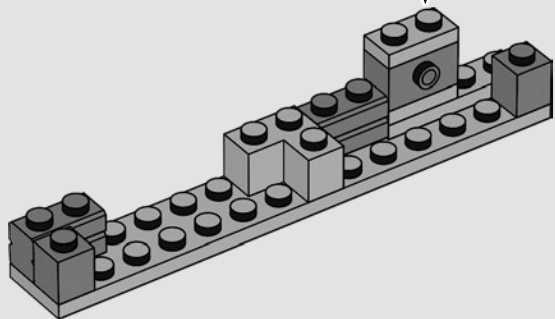
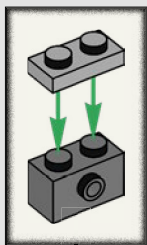

26

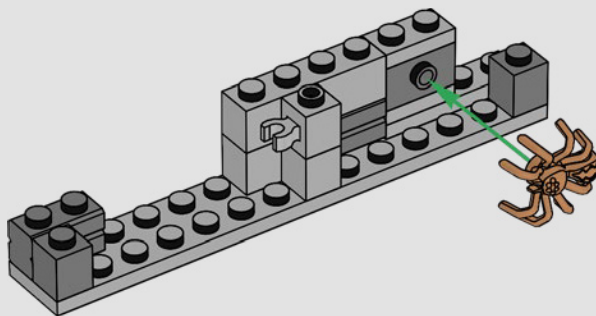

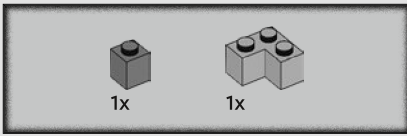

27

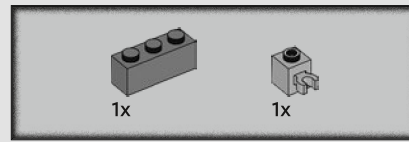
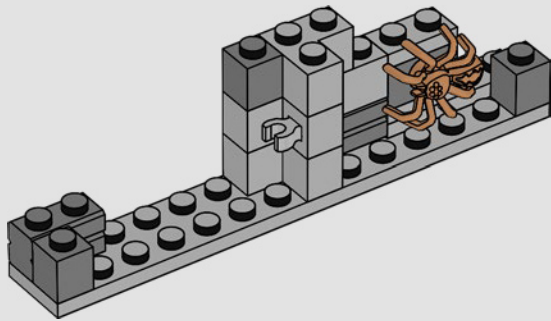

28

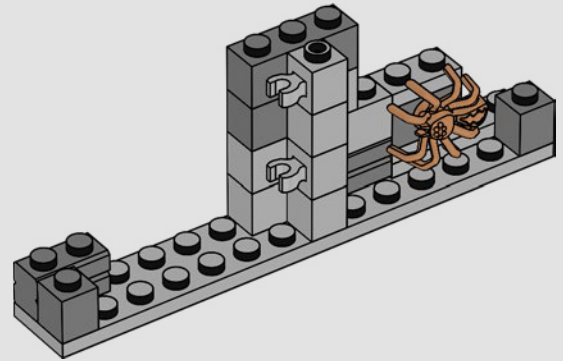

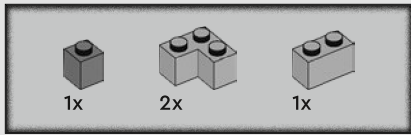

29

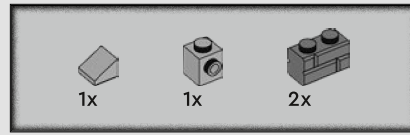
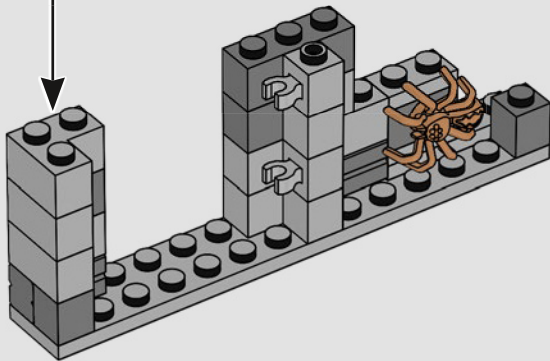
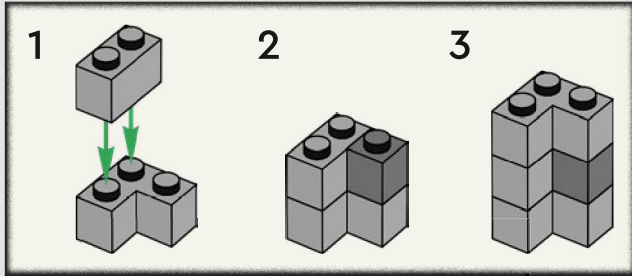

30

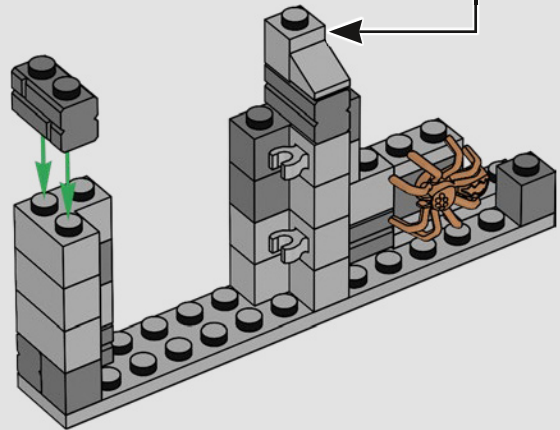
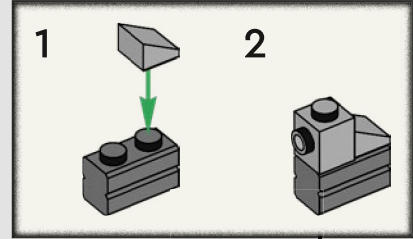

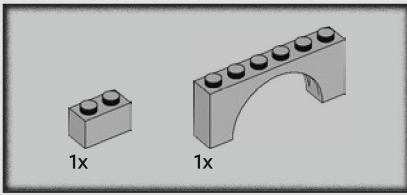

31

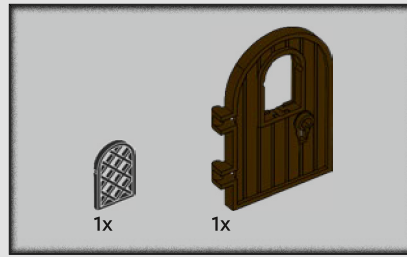
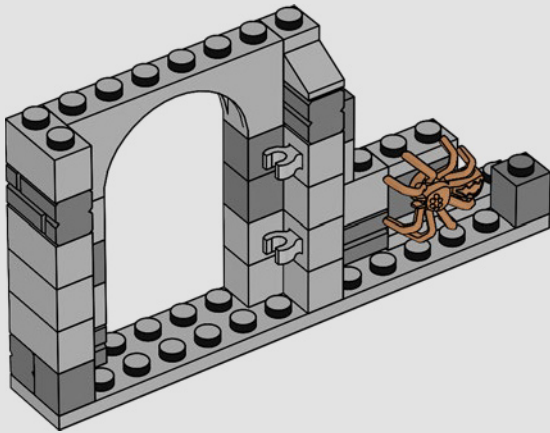

32

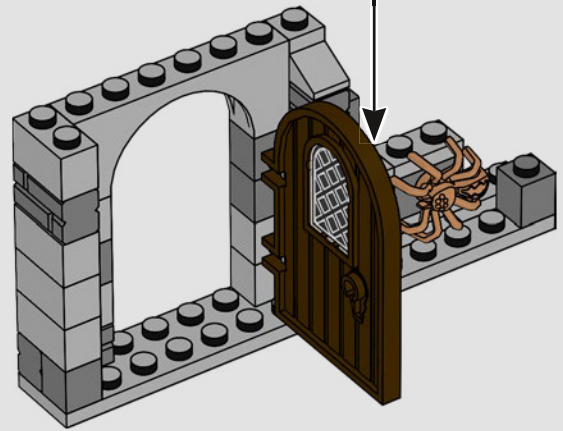
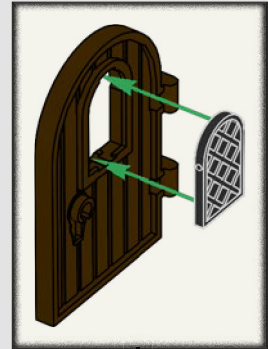

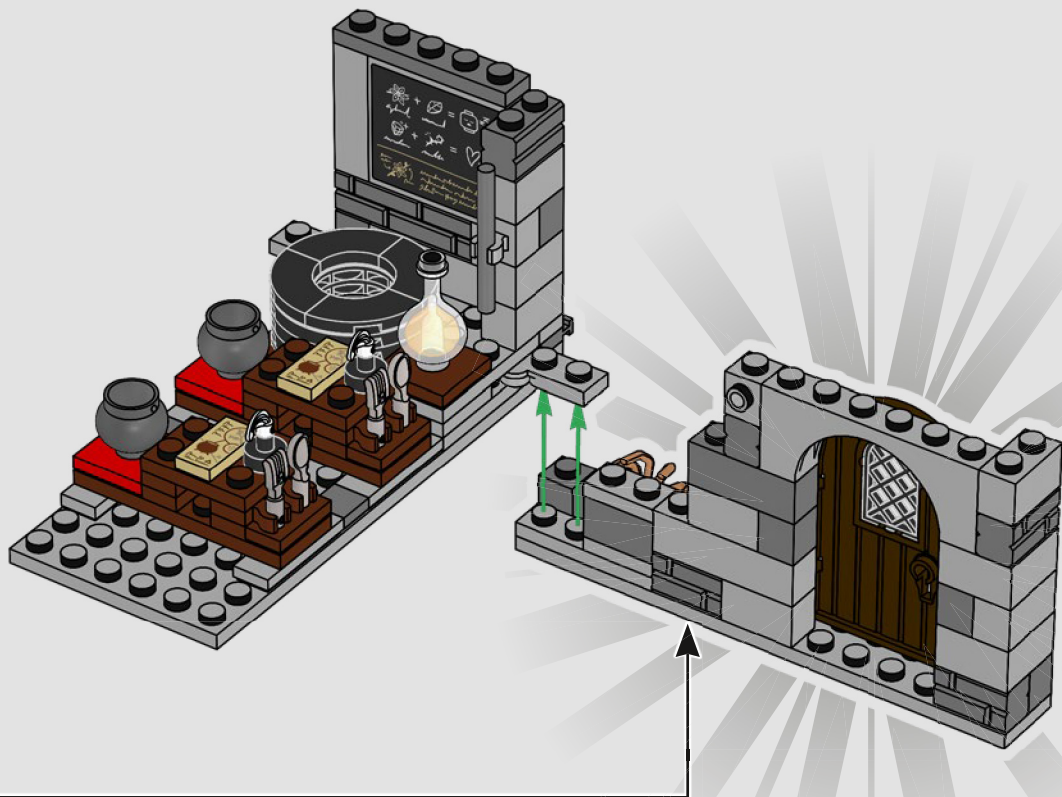

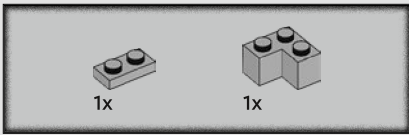

34

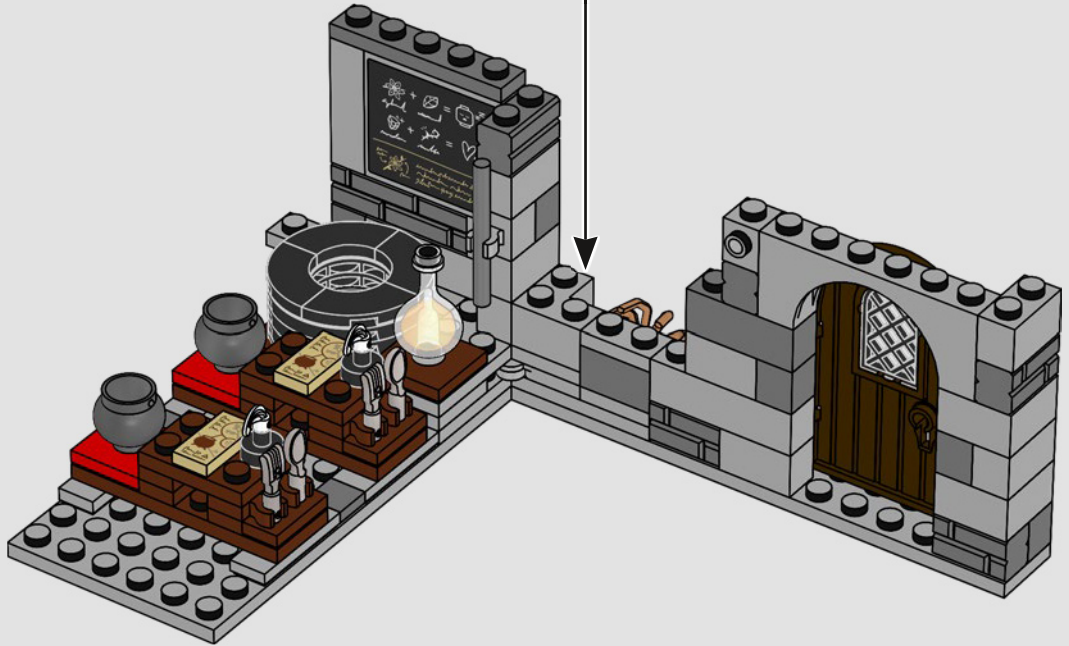
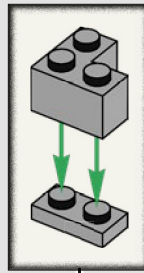

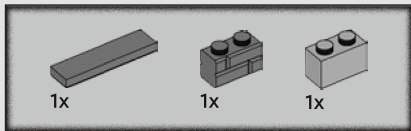

35

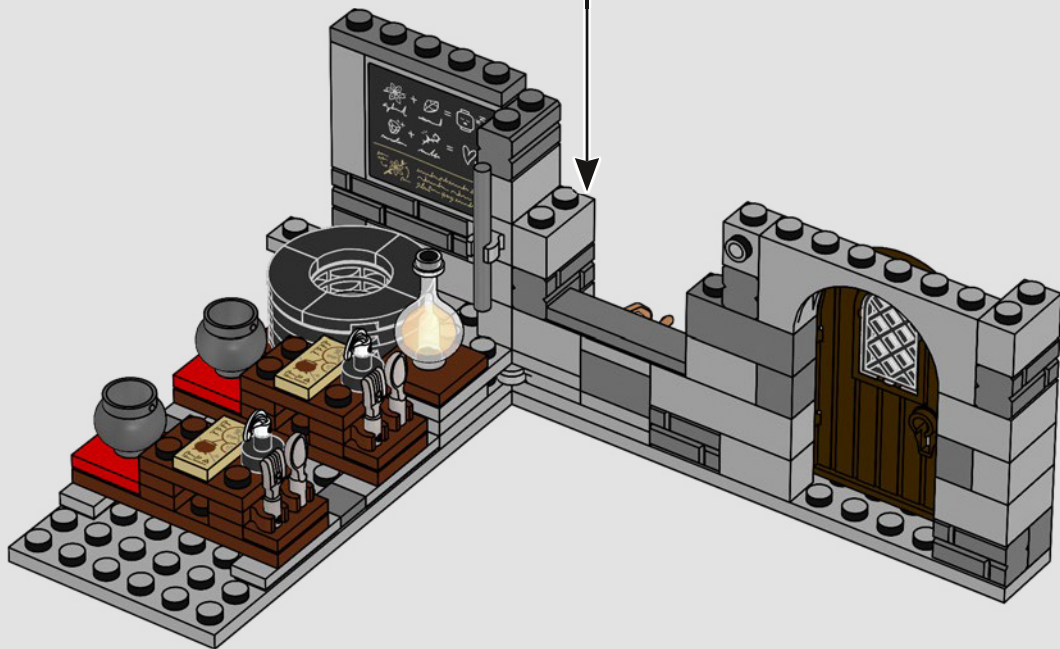
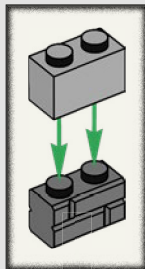

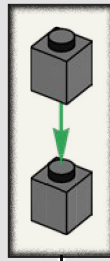
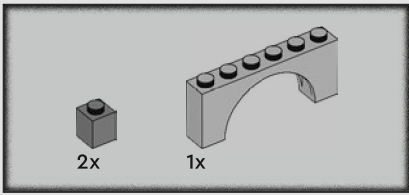

36

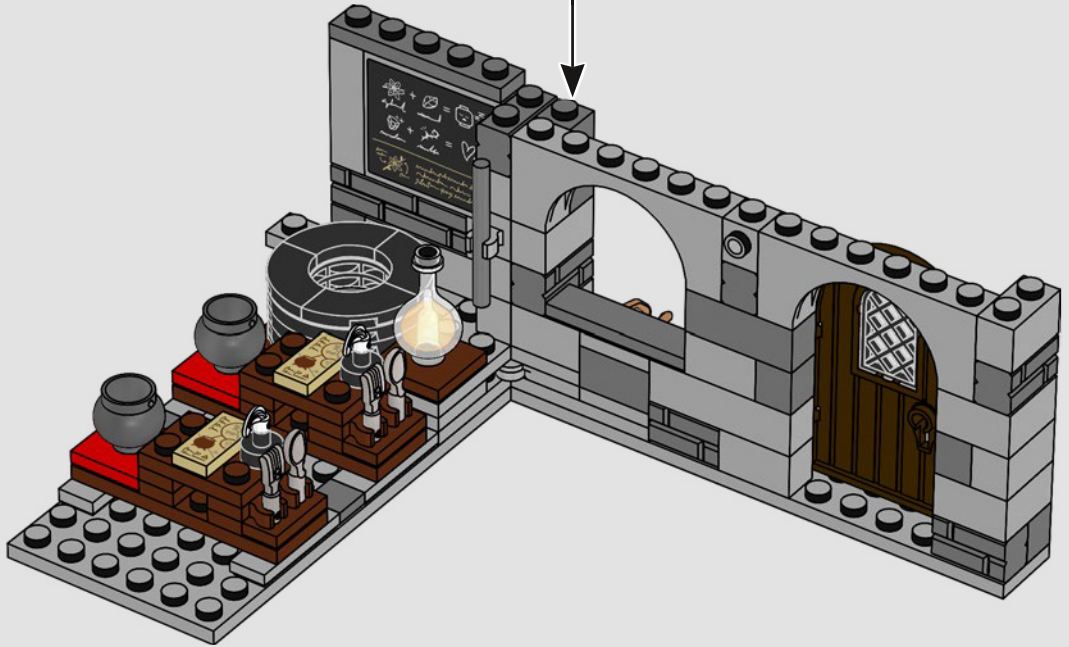

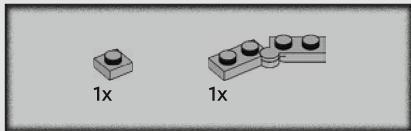

37



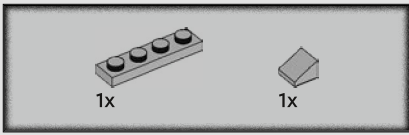

38



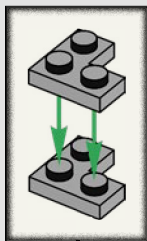
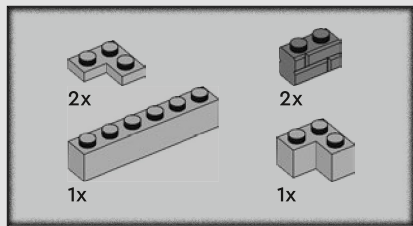

39

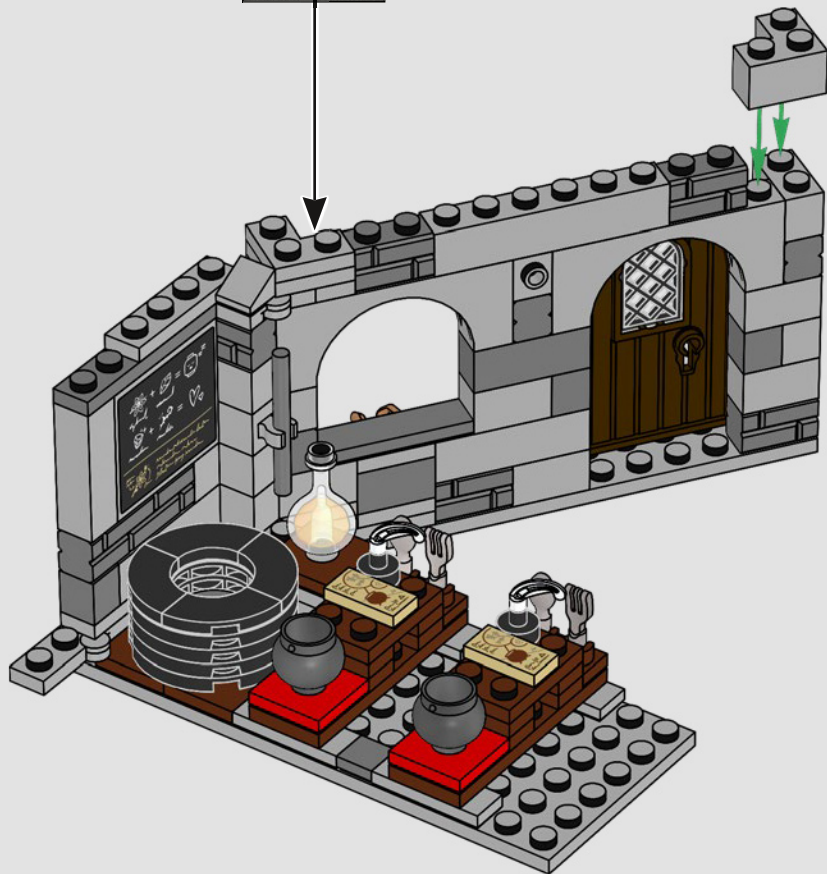

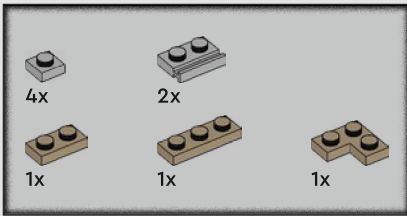

40

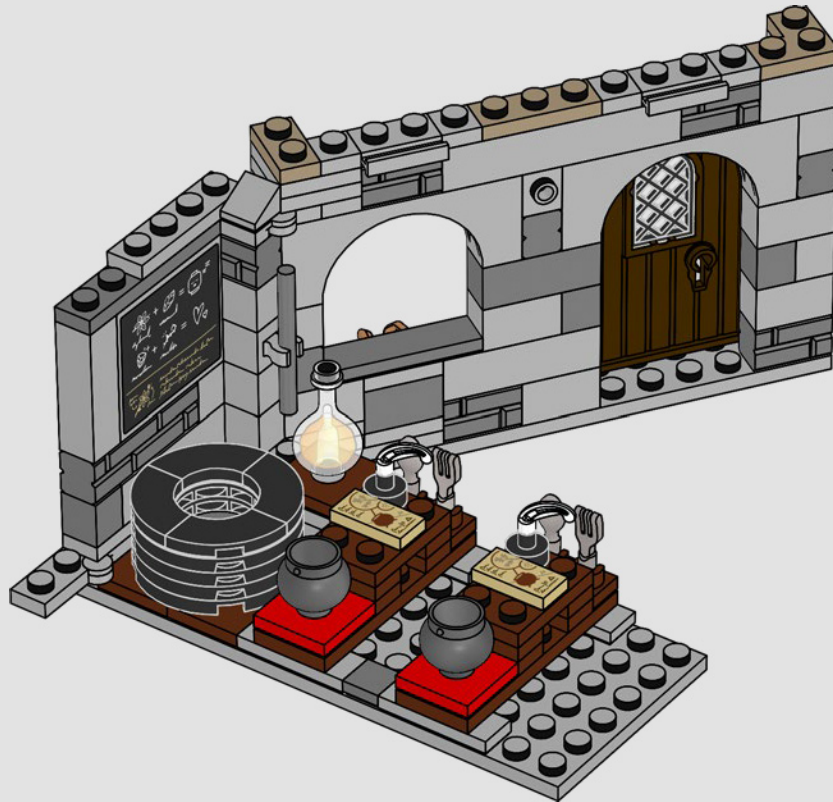

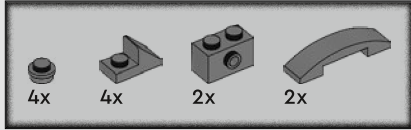

41

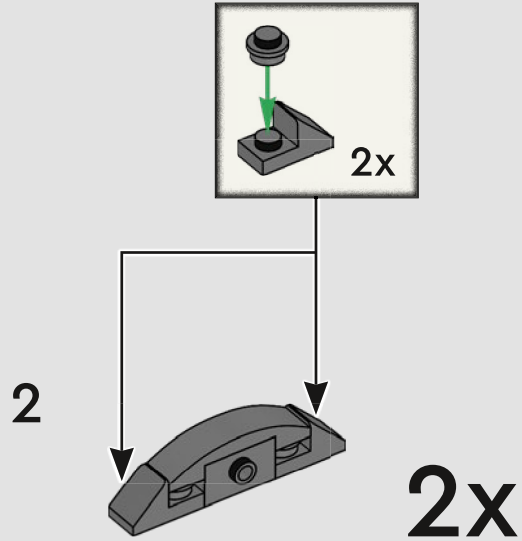
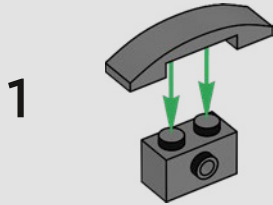

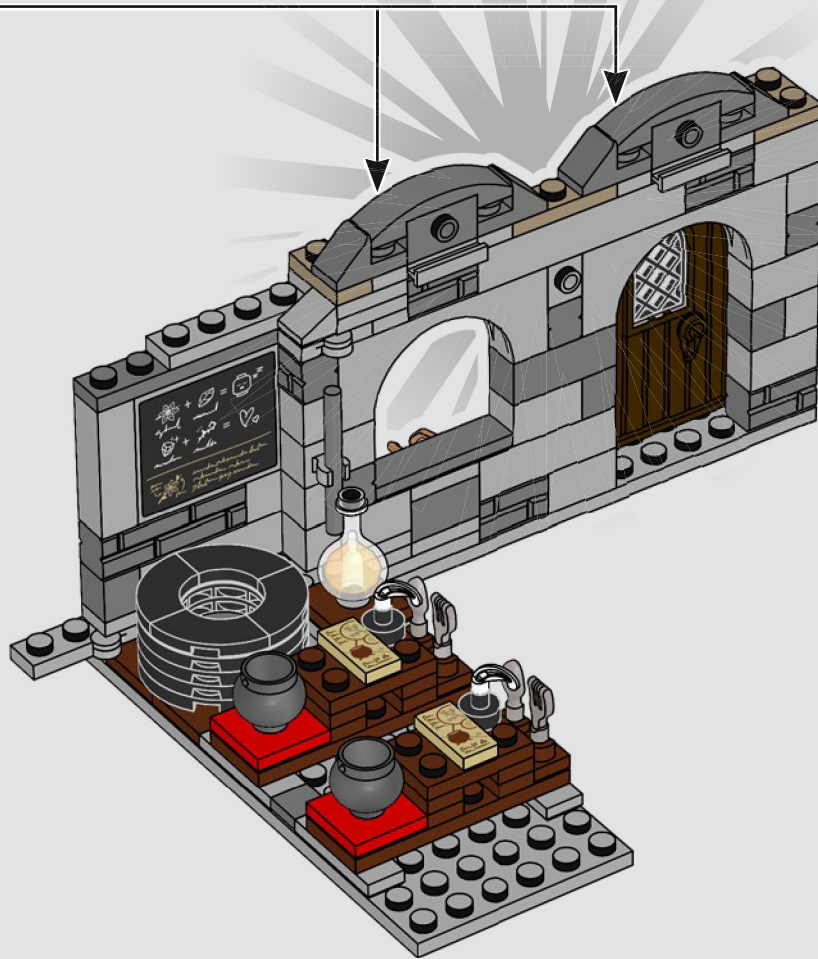

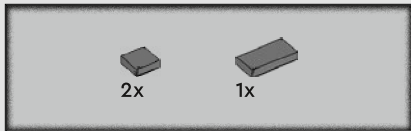

42

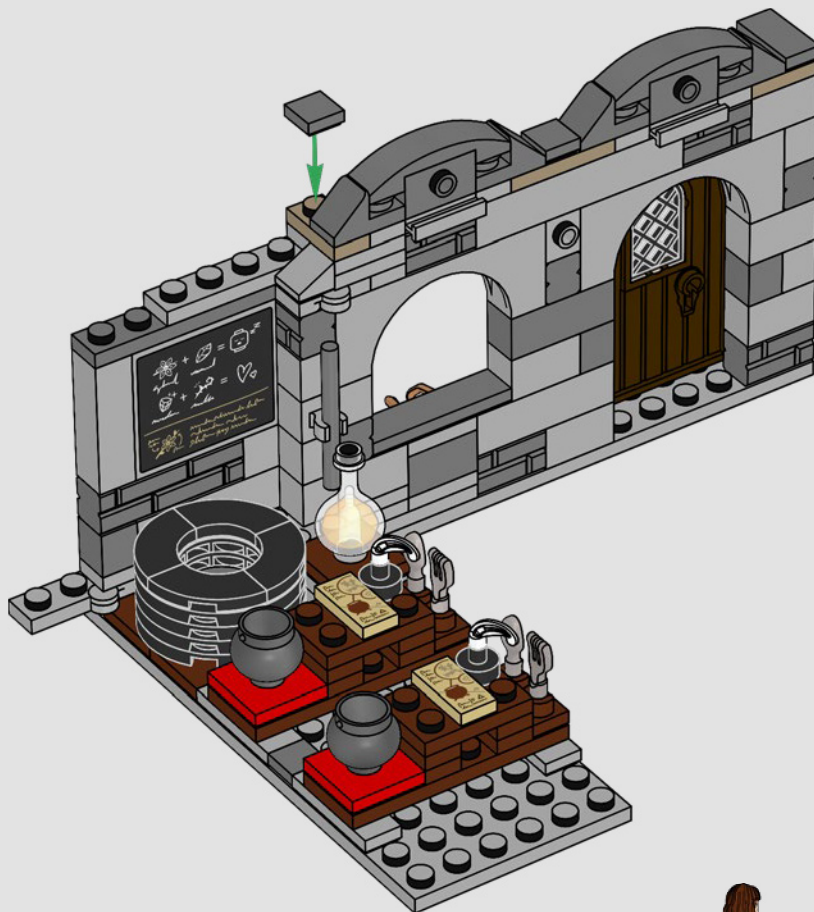

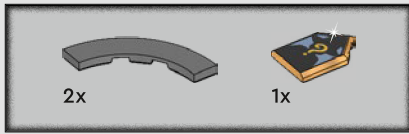

43

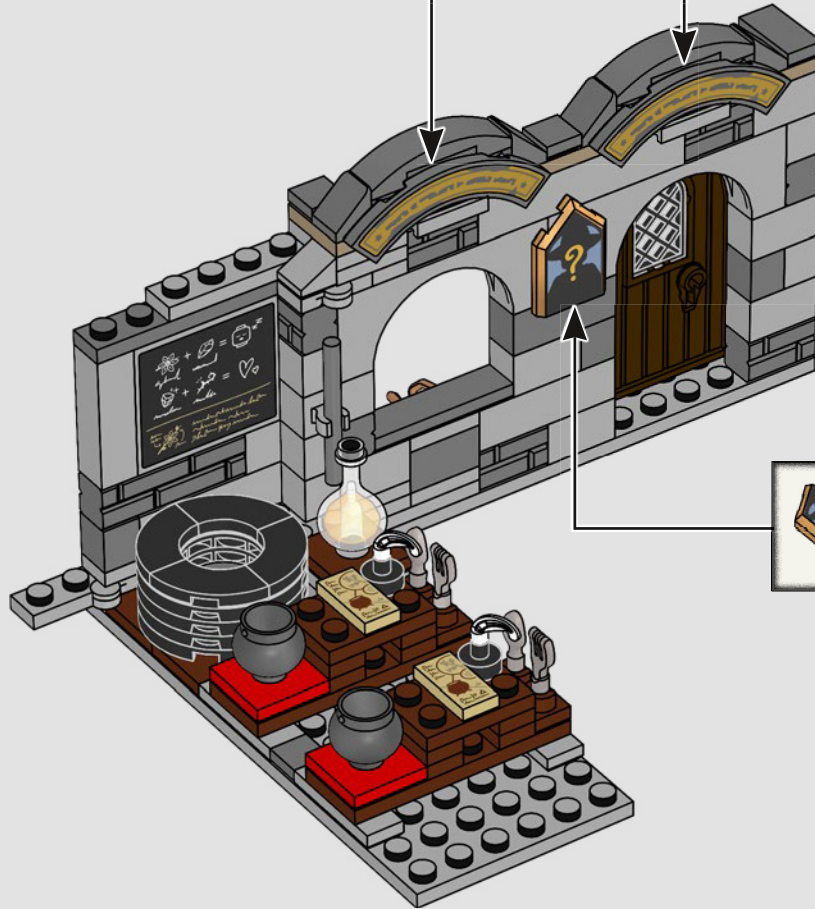
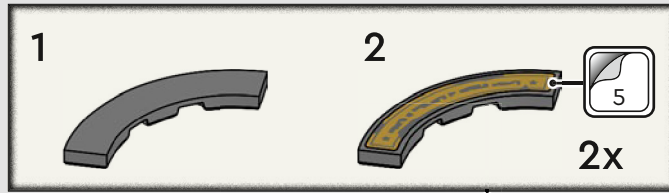

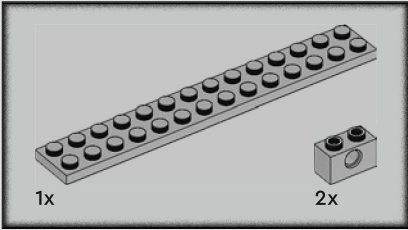
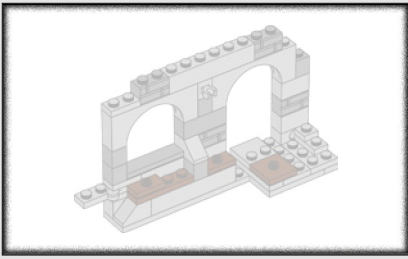

44

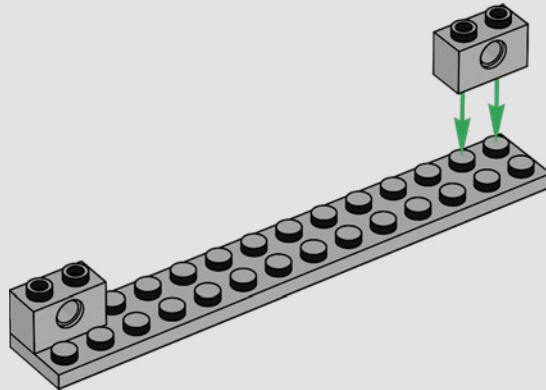

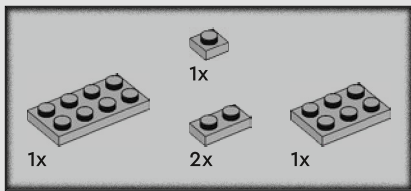

45

1

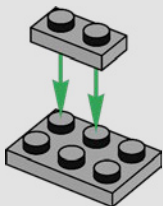

2

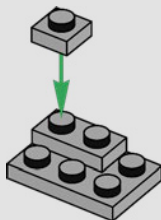

3

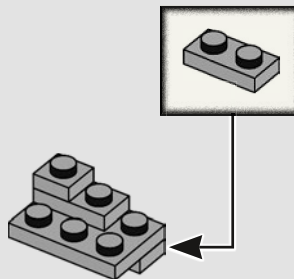

4

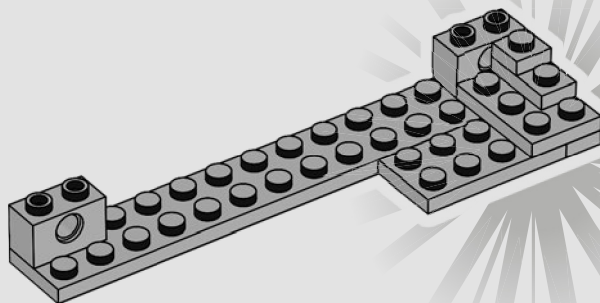
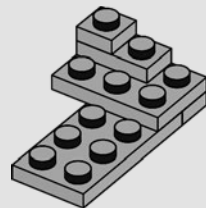

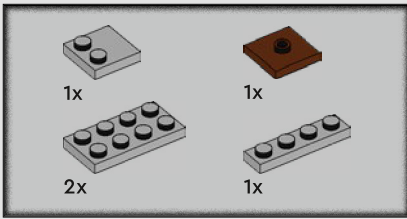

46

1

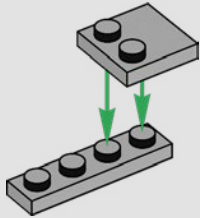

2

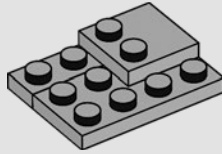

3

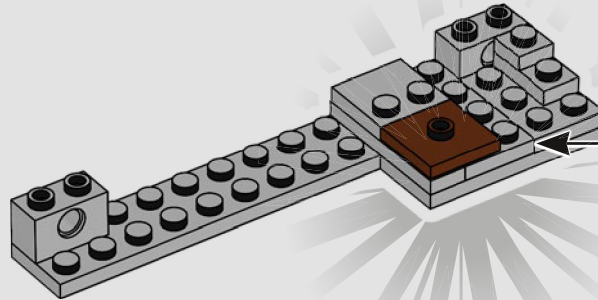
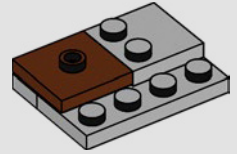

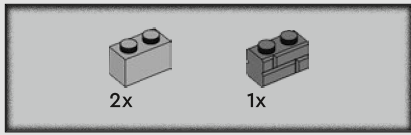

47

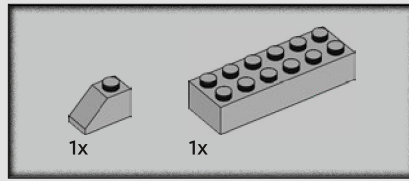
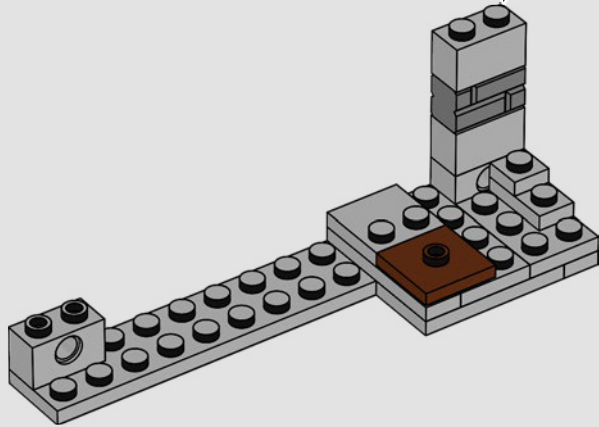
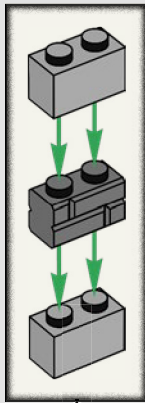

48

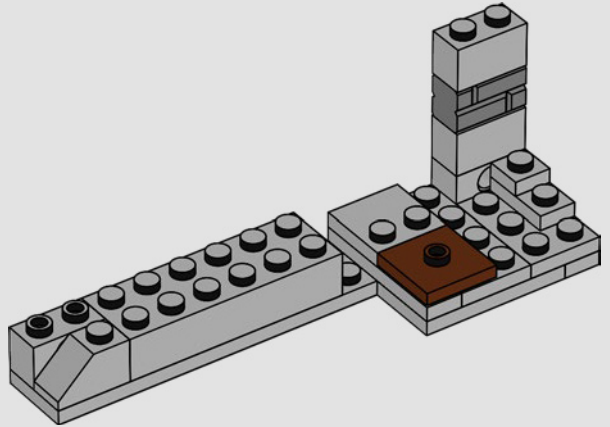

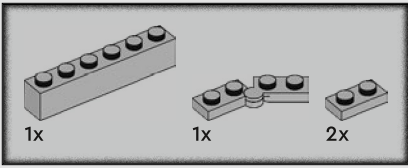

49

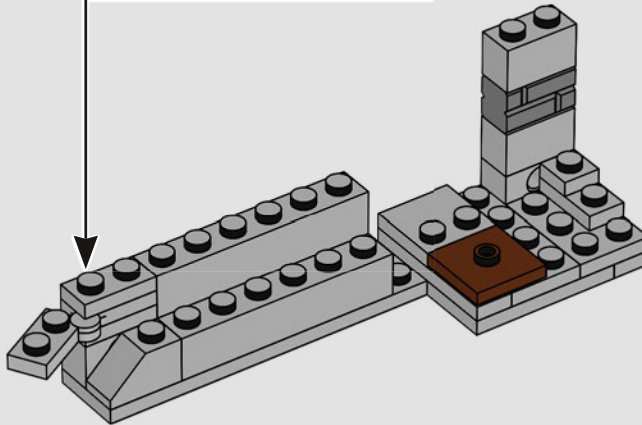
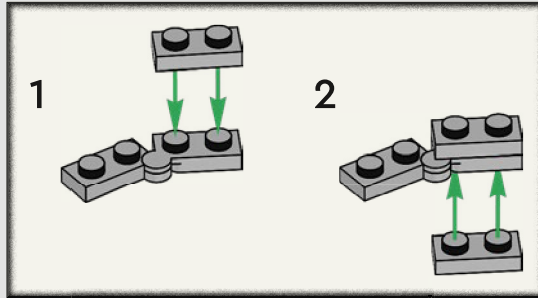

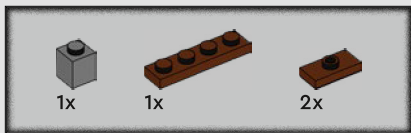

50

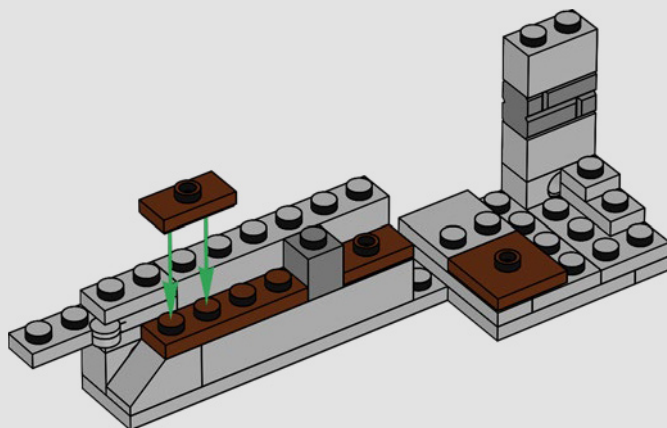

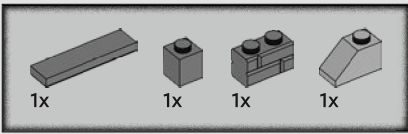

51

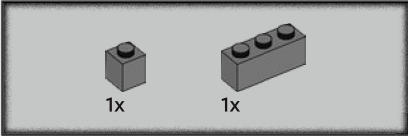
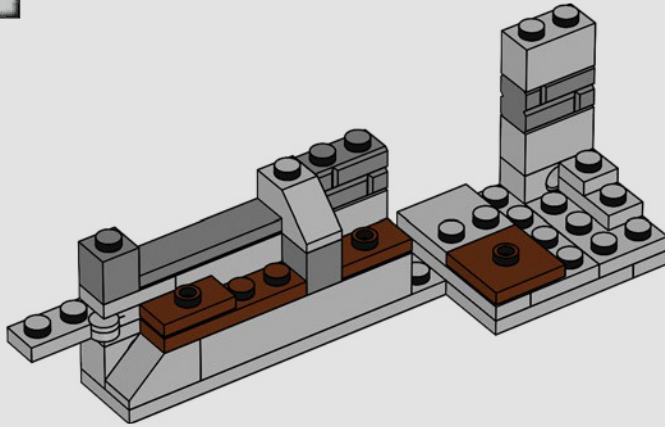

52

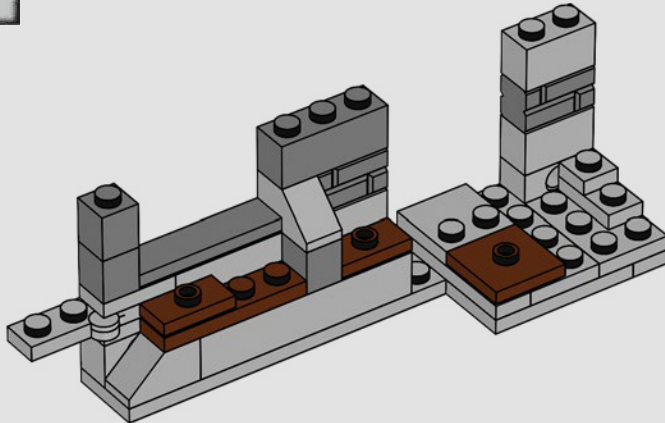

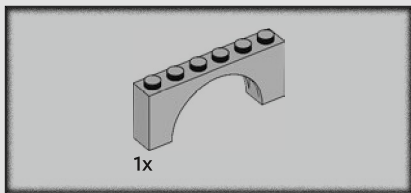

53

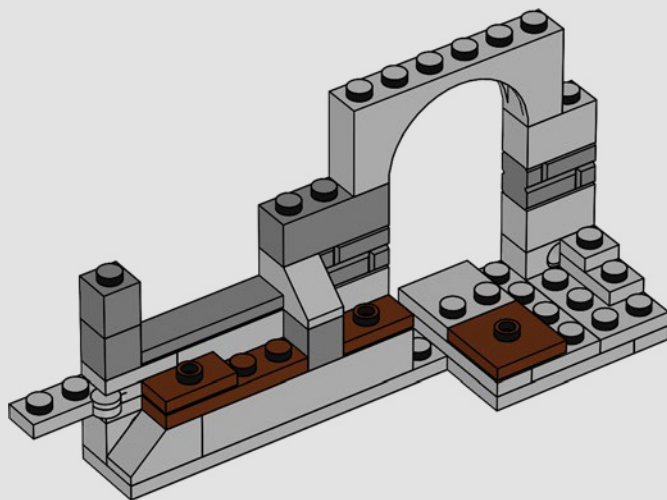

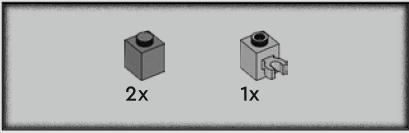

54

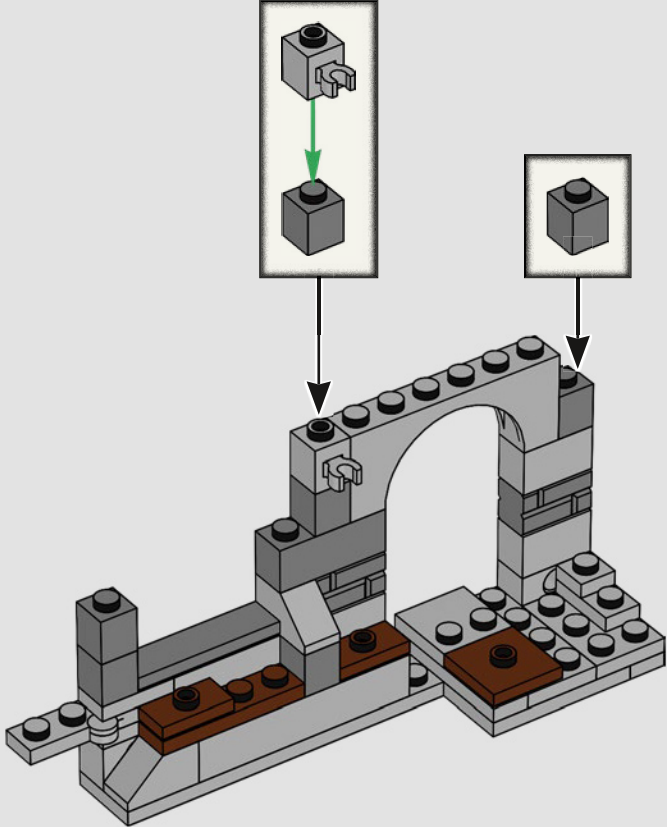

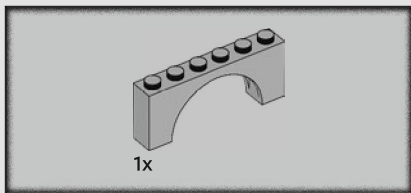

55

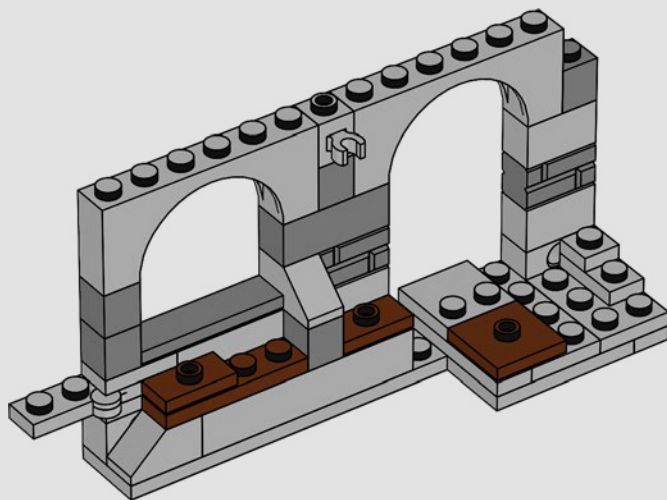

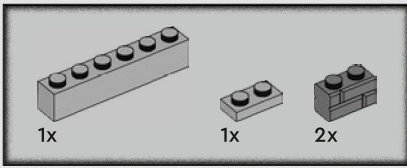

56

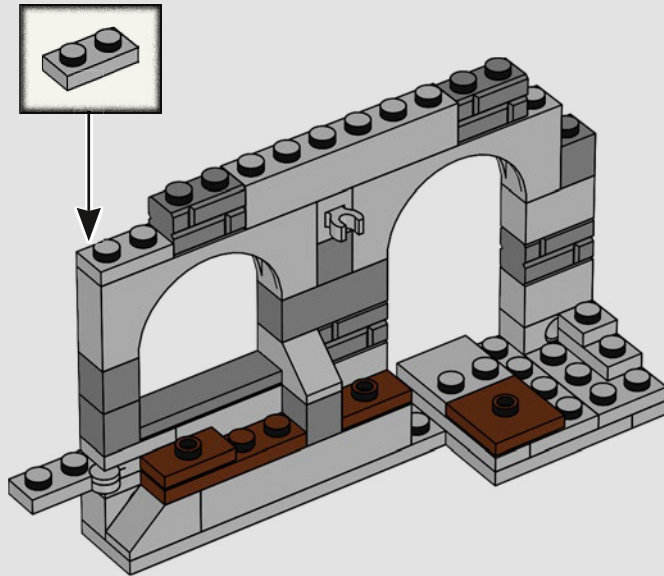

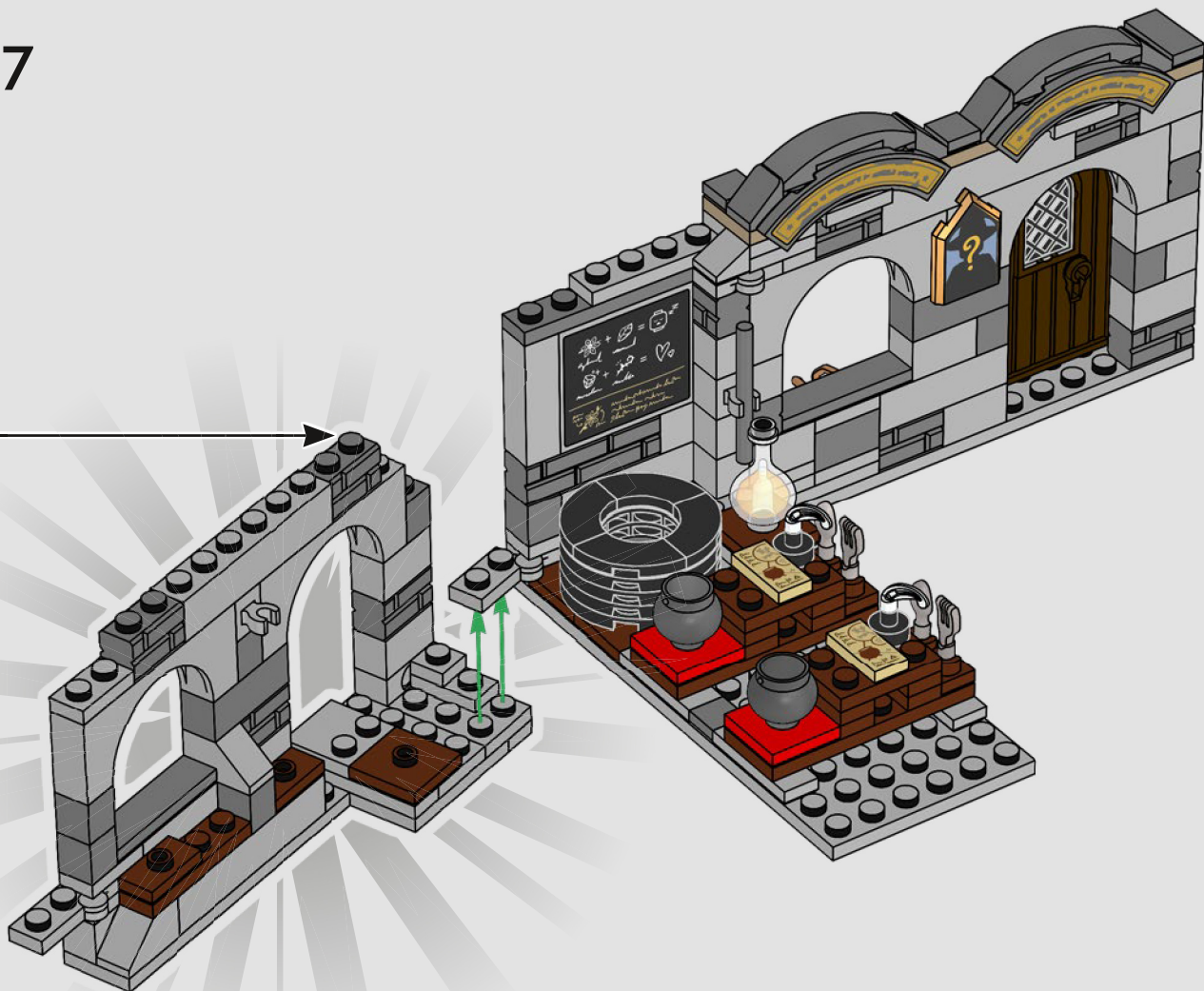

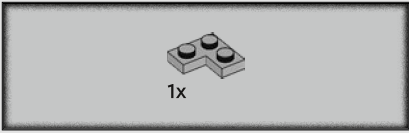

58

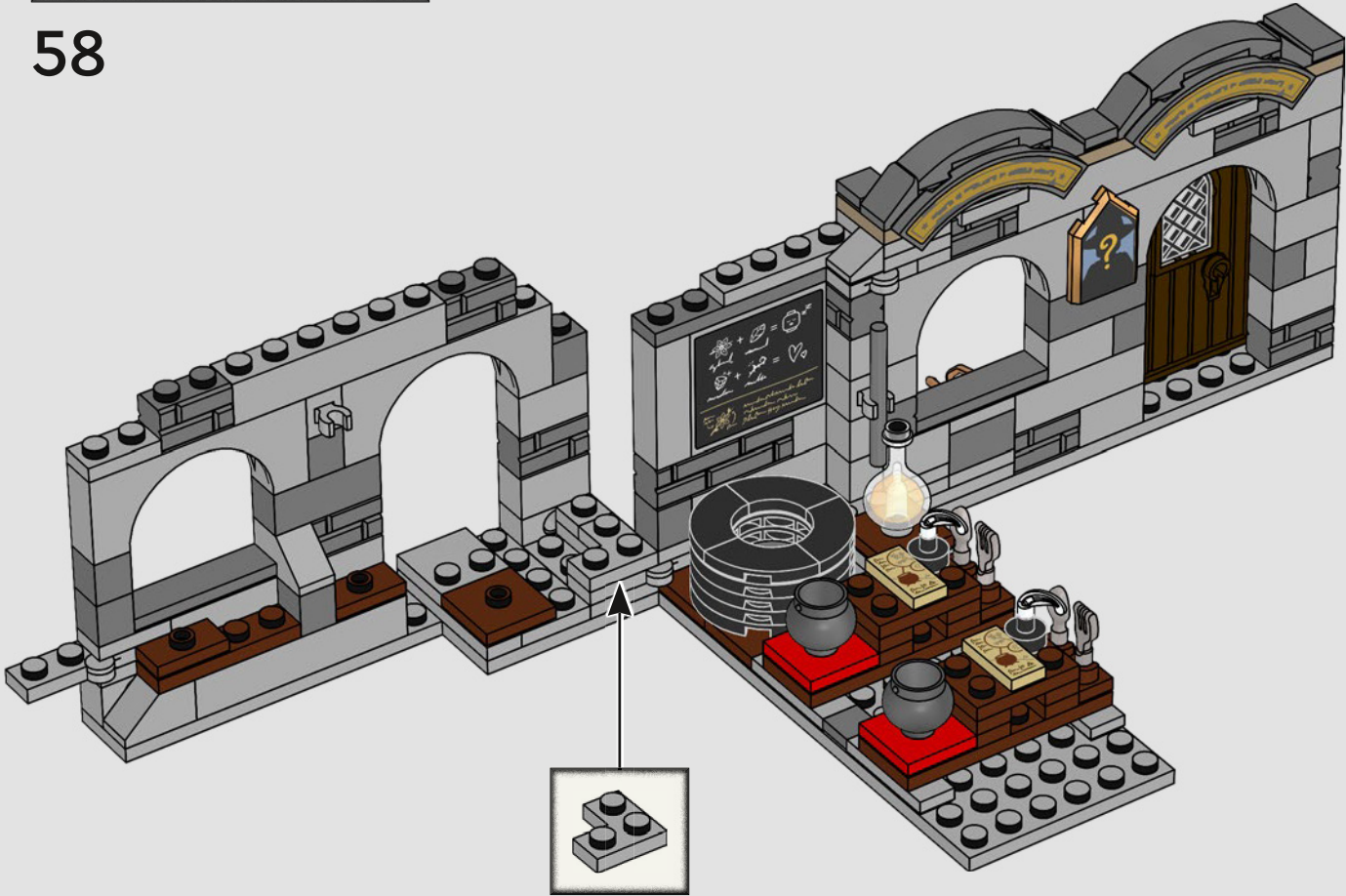

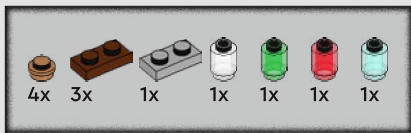

59

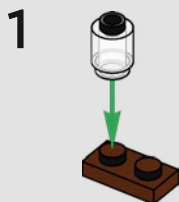

3



4

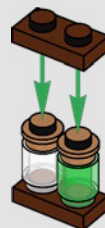

5



6



7



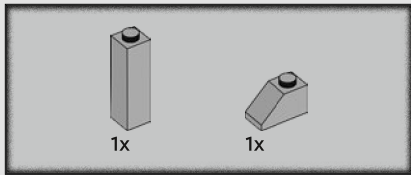

60

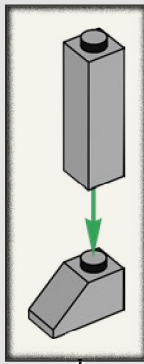

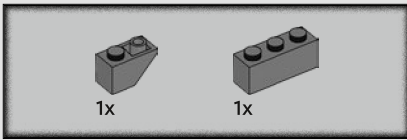

61

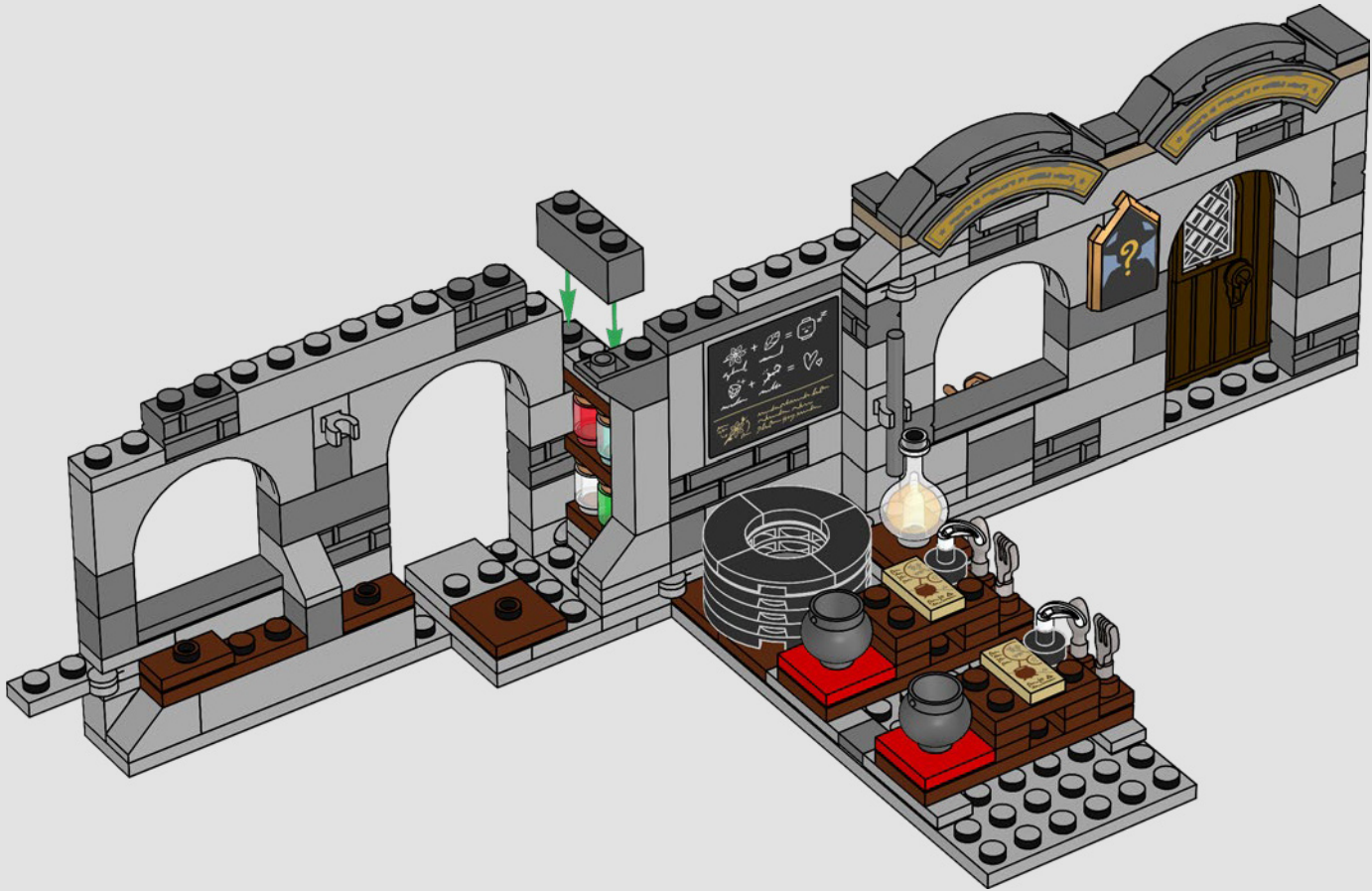

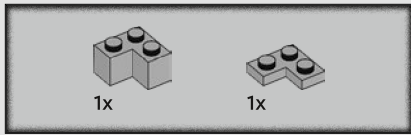

62



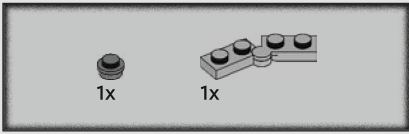

63



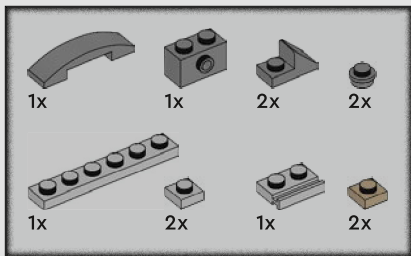

64

1

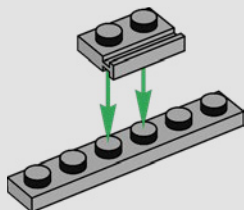

2

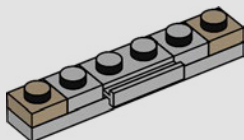

3

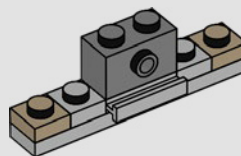

4

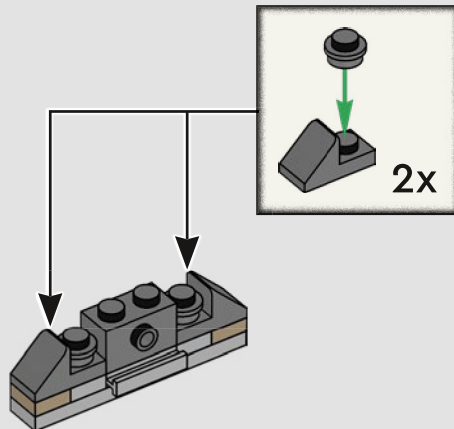

5

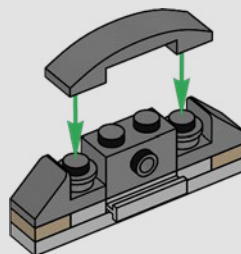

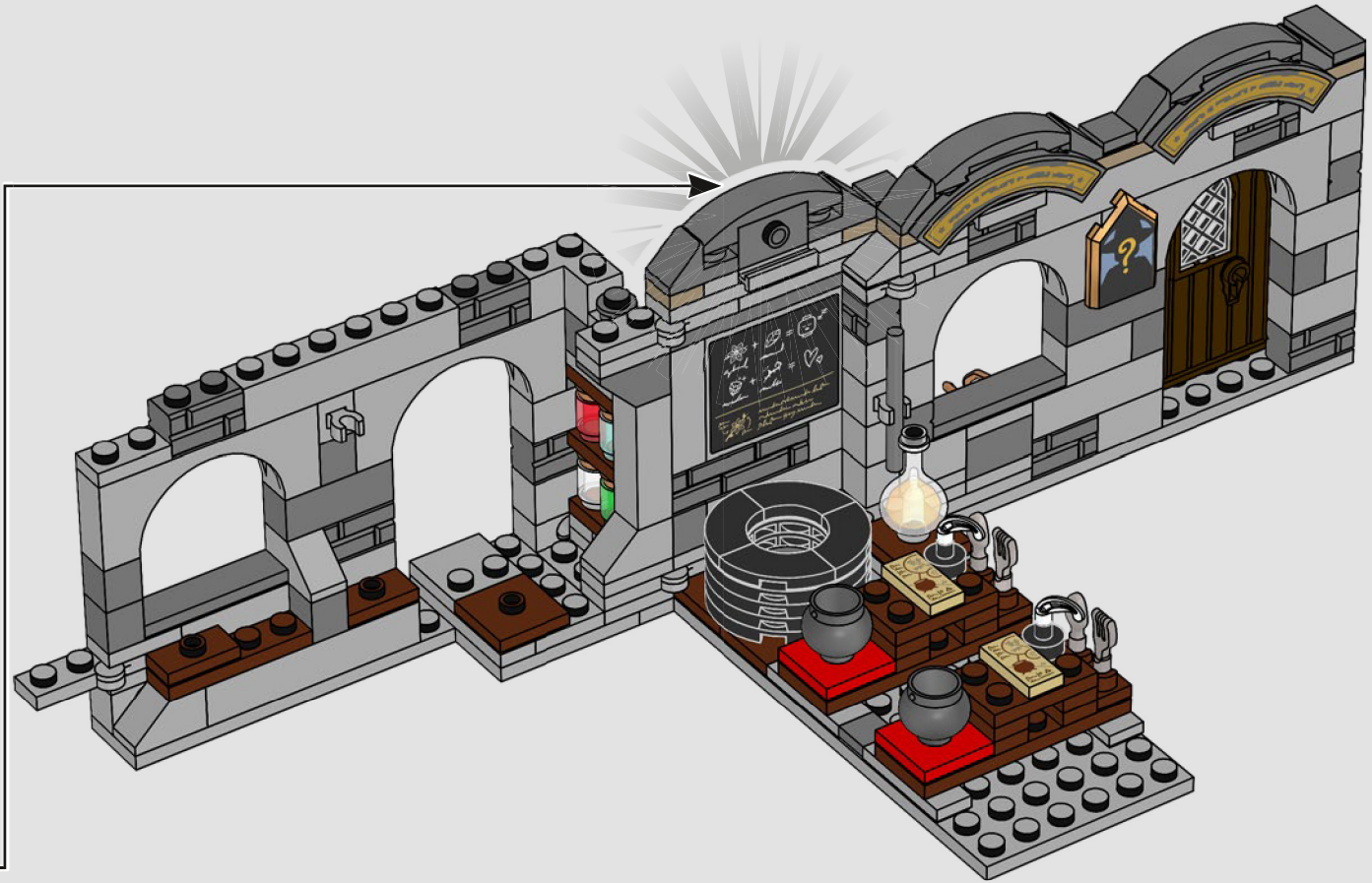

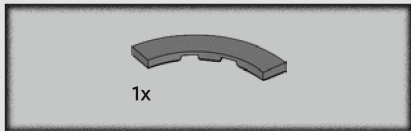

65

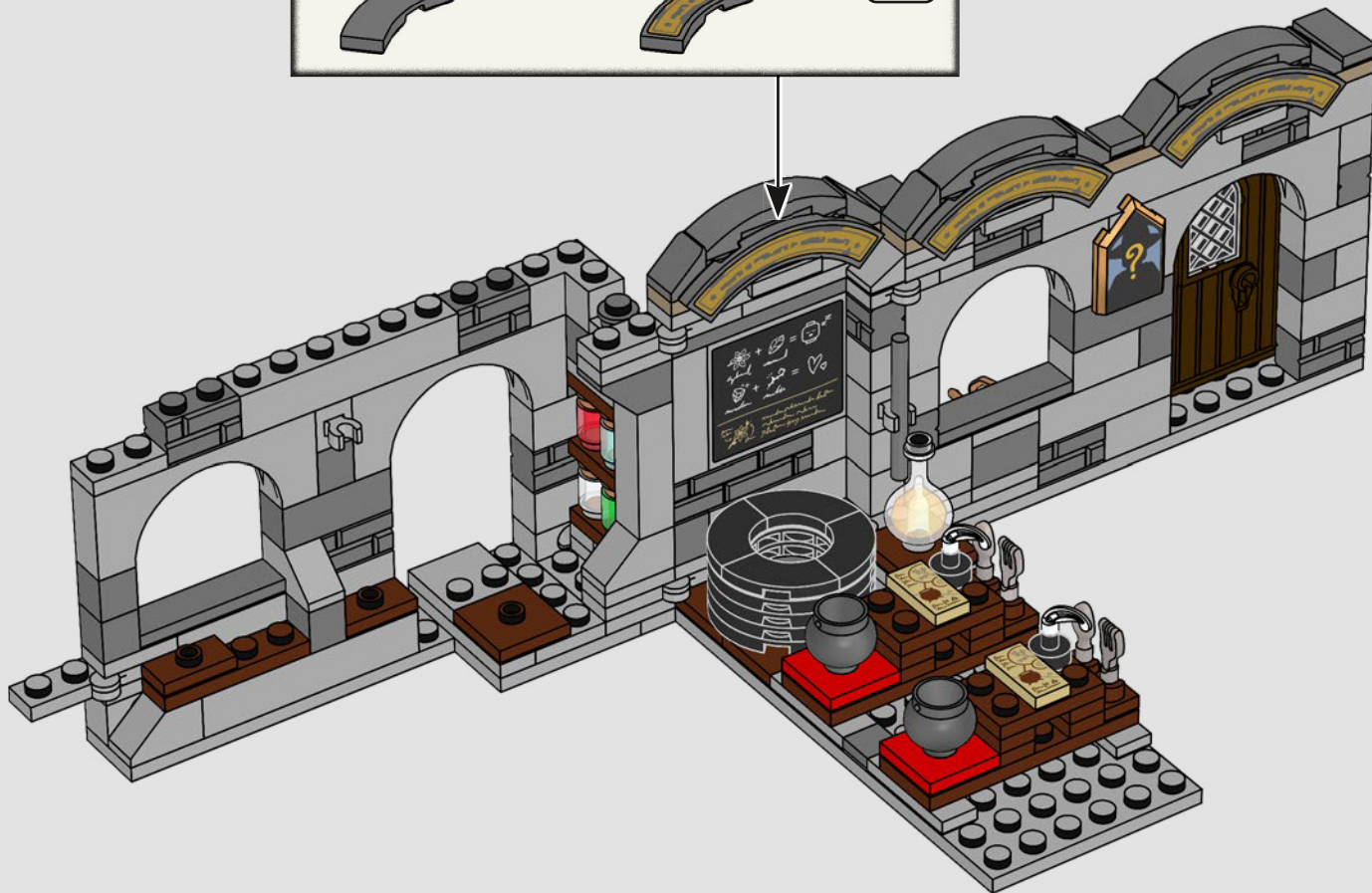
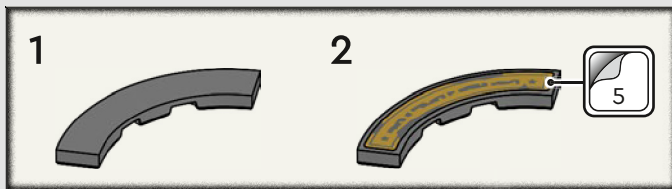

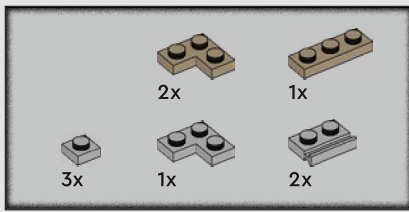

66

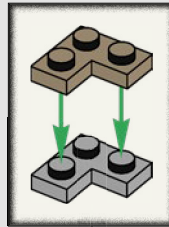

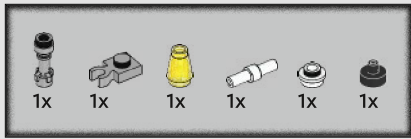

67

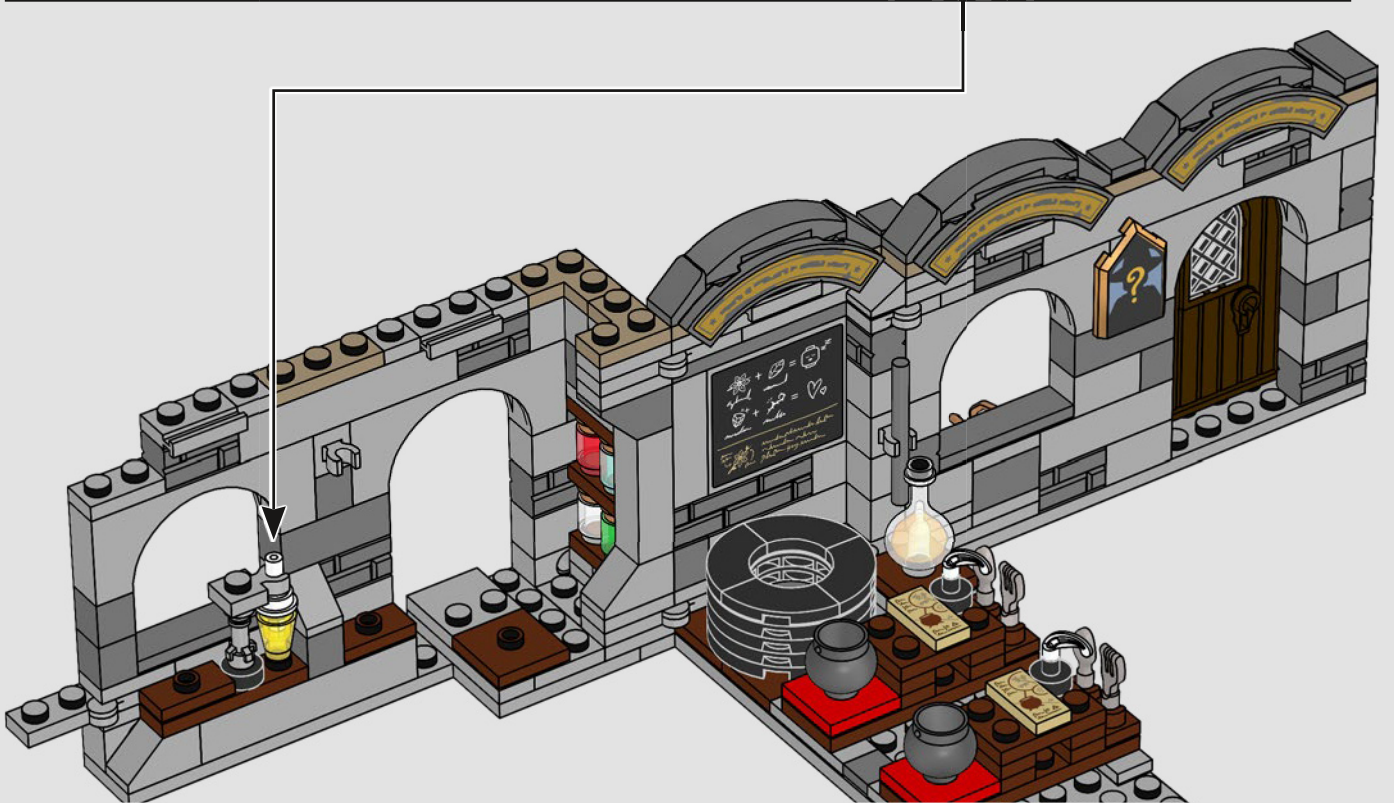
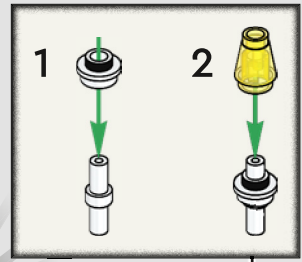
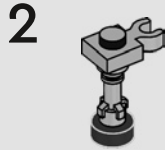
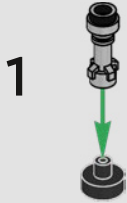



68



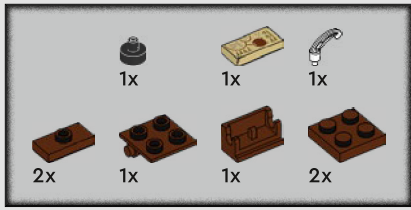

69

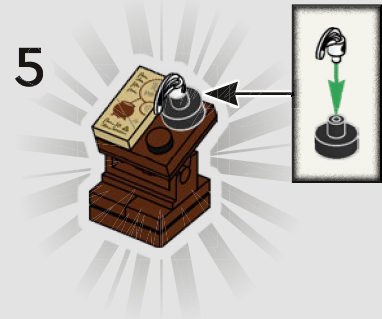
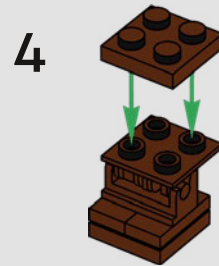
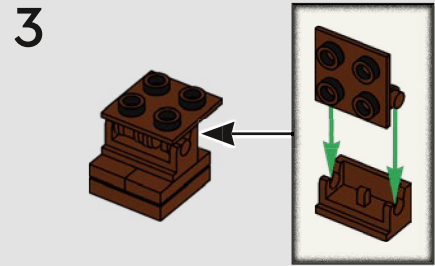
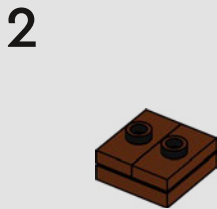
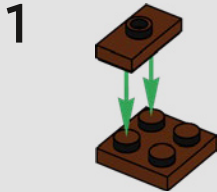

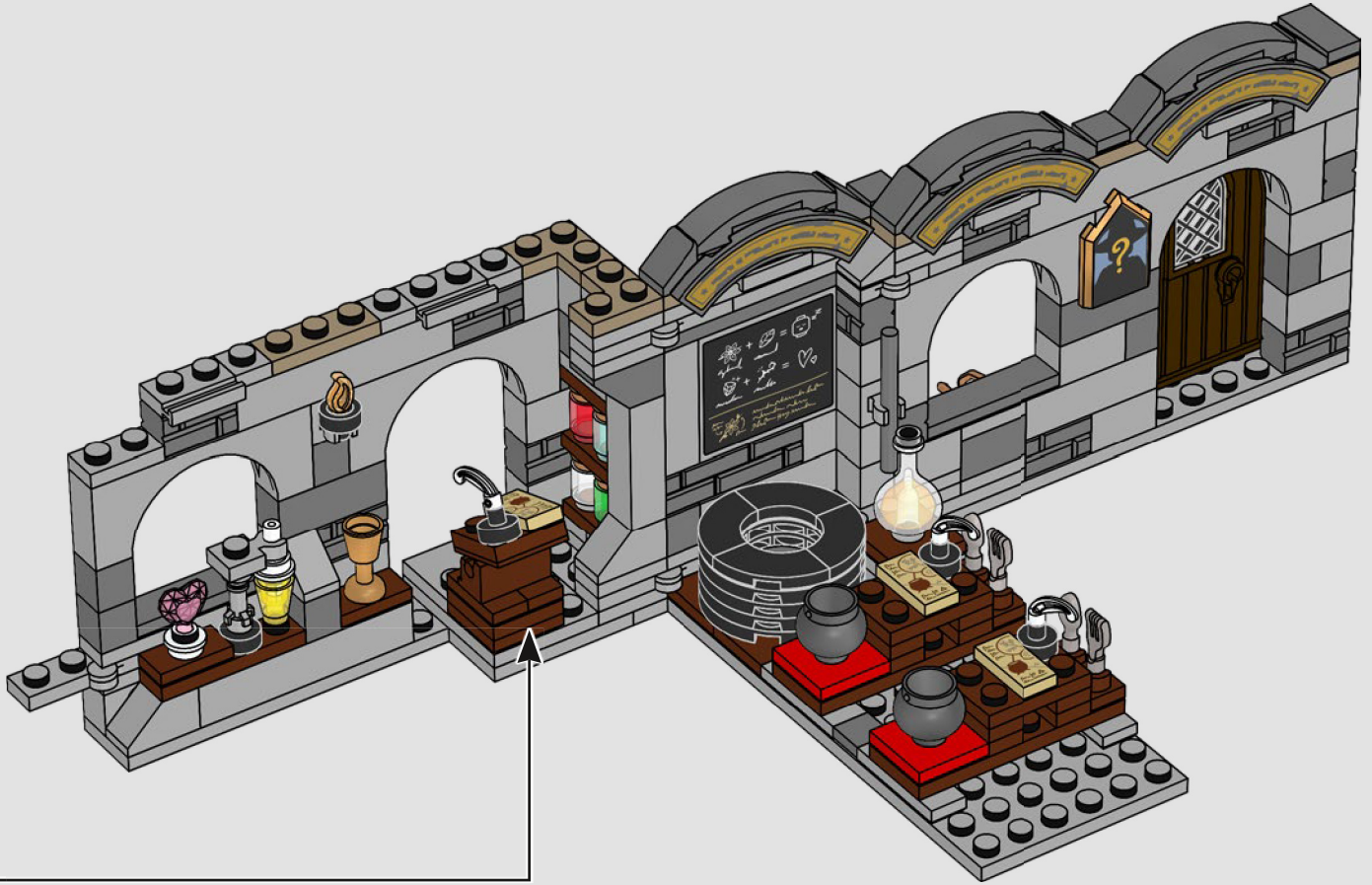

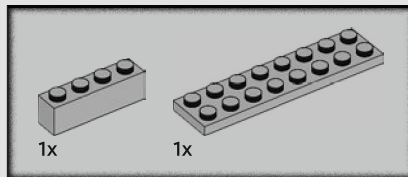
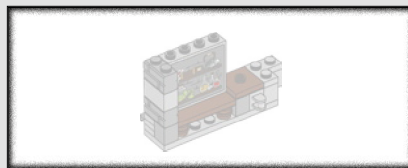

70

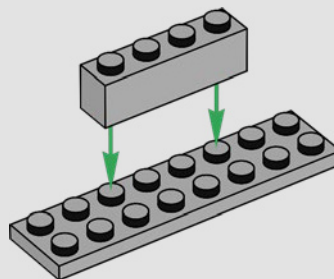

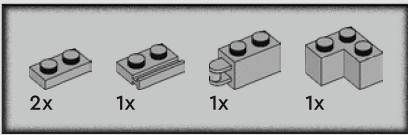

71

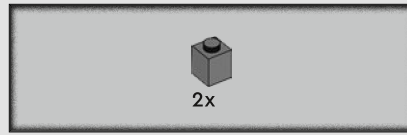
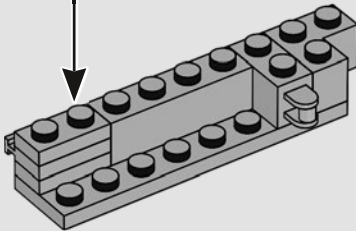
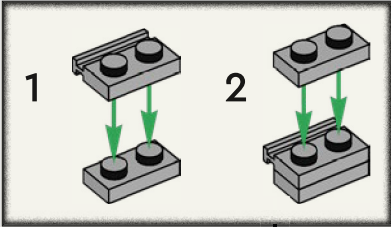

72

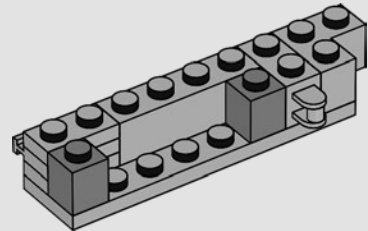

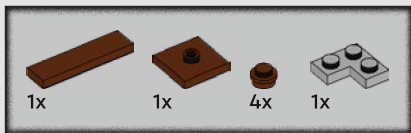

73

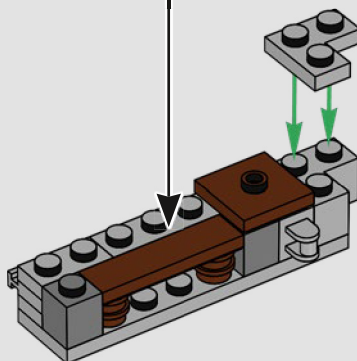
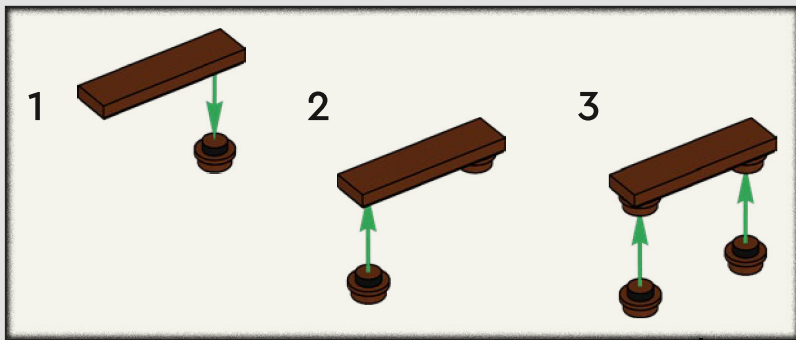

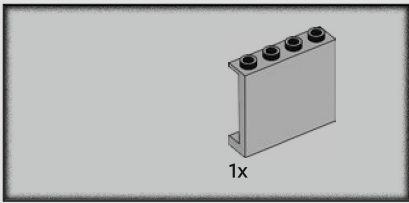

74

1

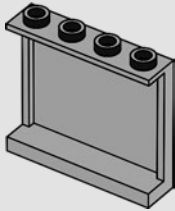

2

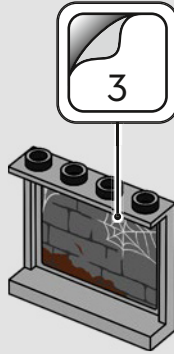

3

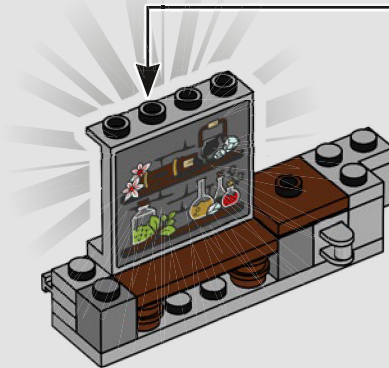

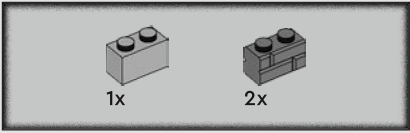

75

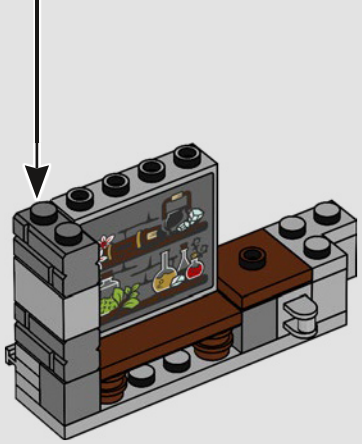
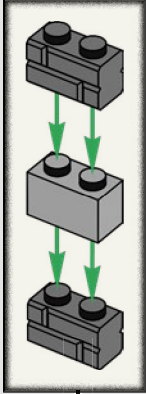

76

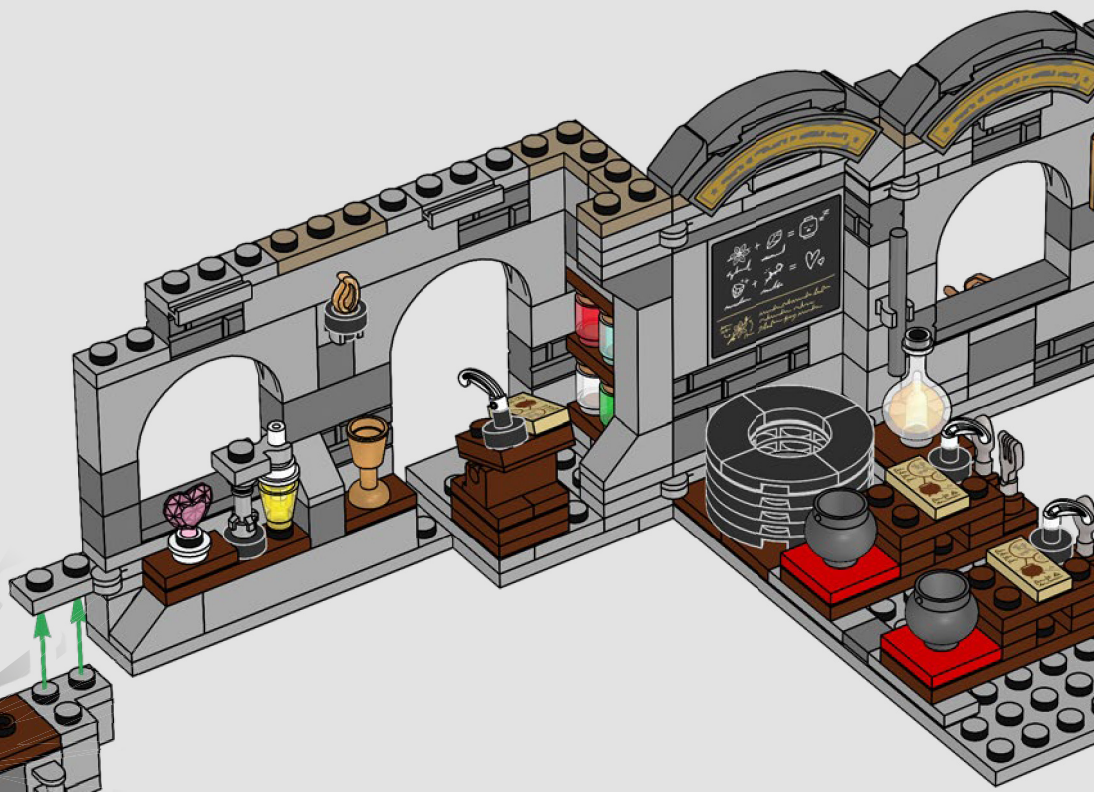



1x

77



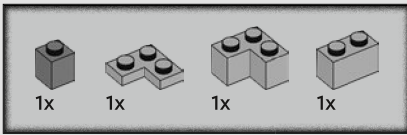

78

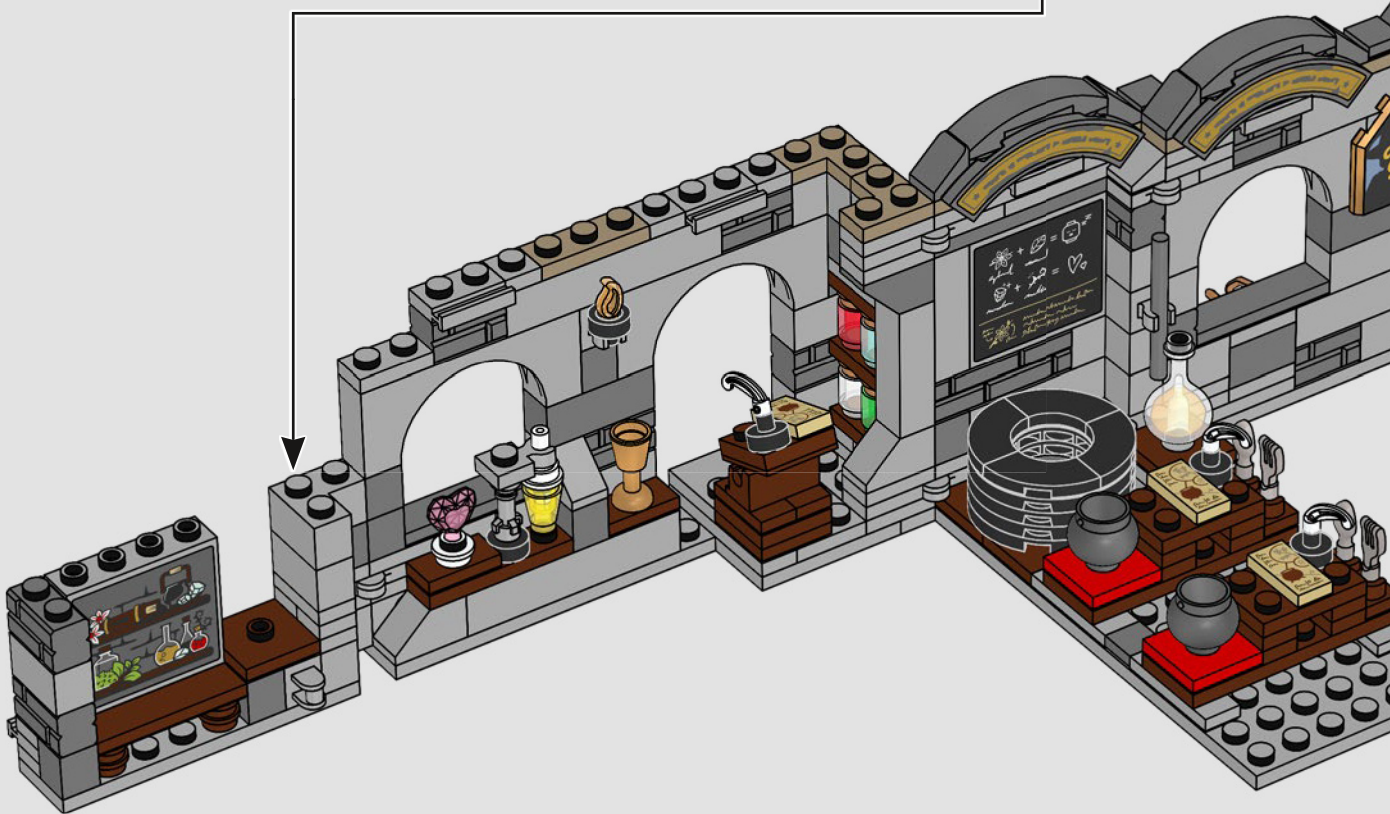
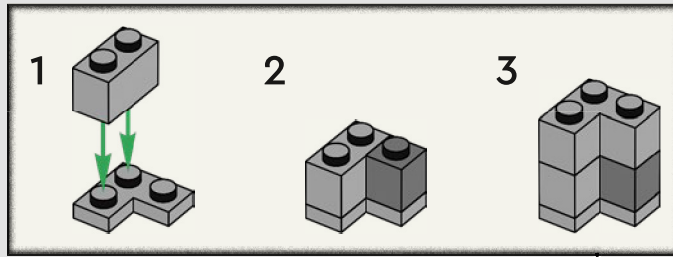

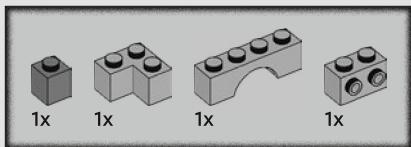

79

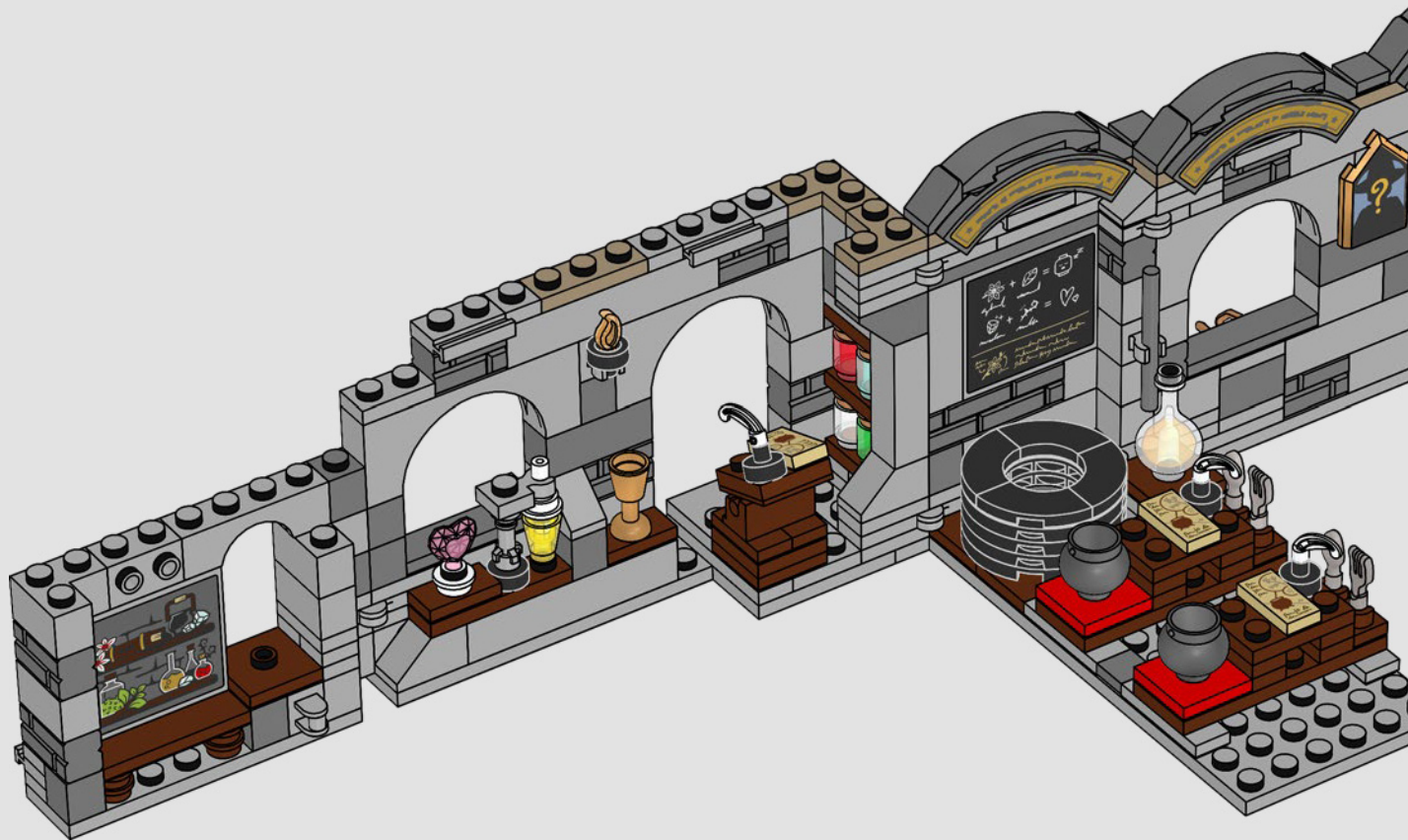

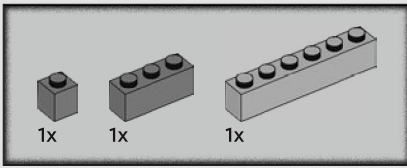

80

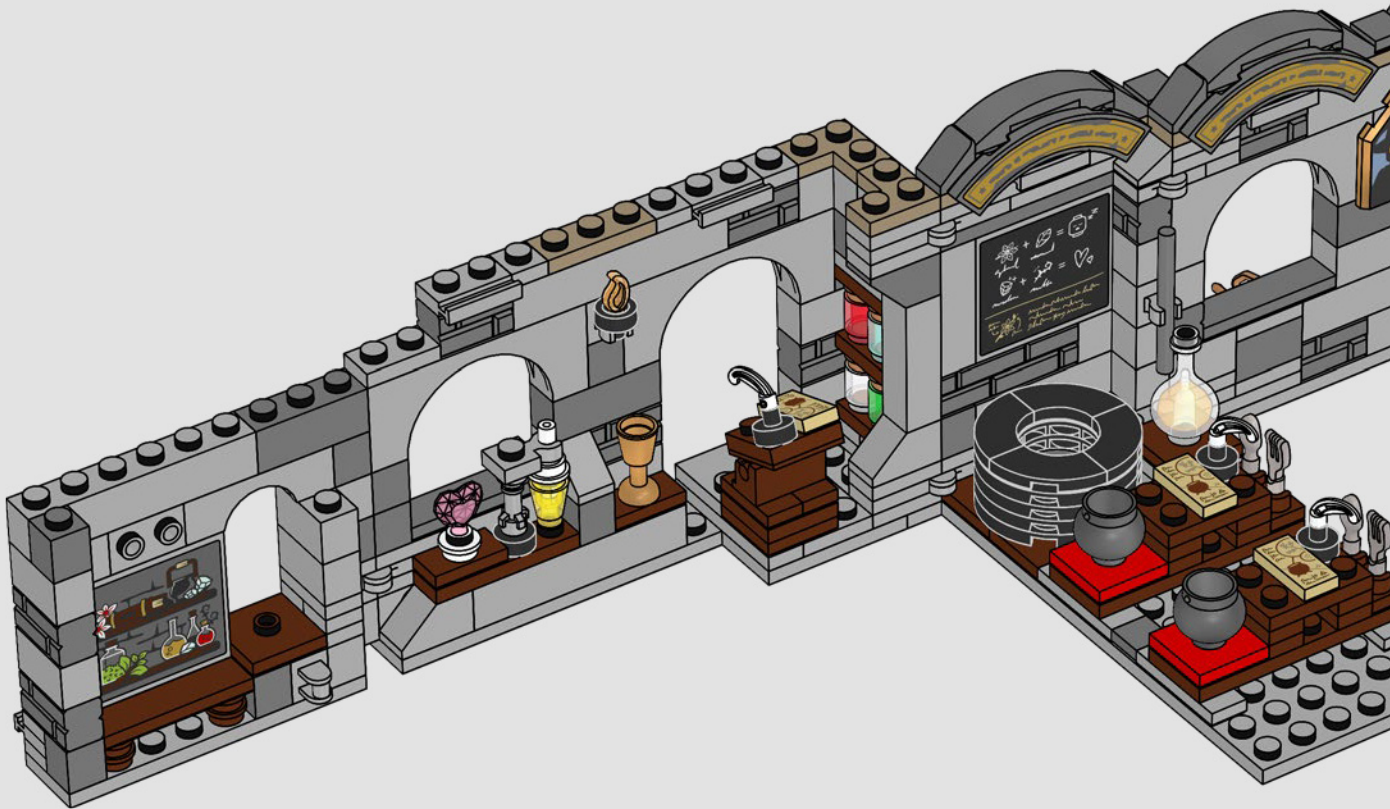

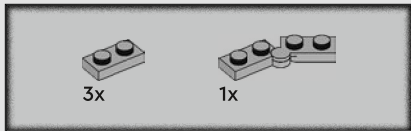

81

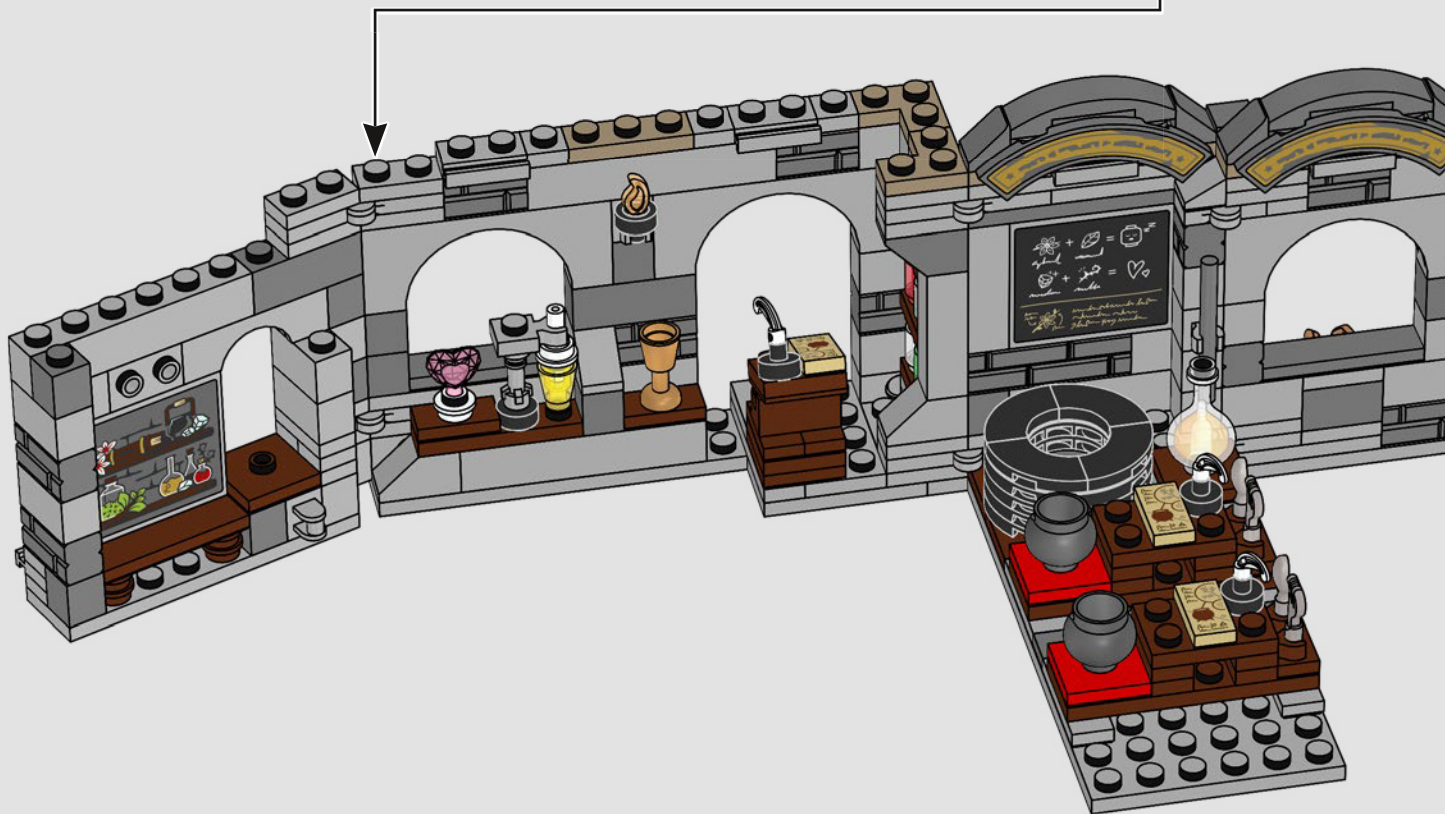
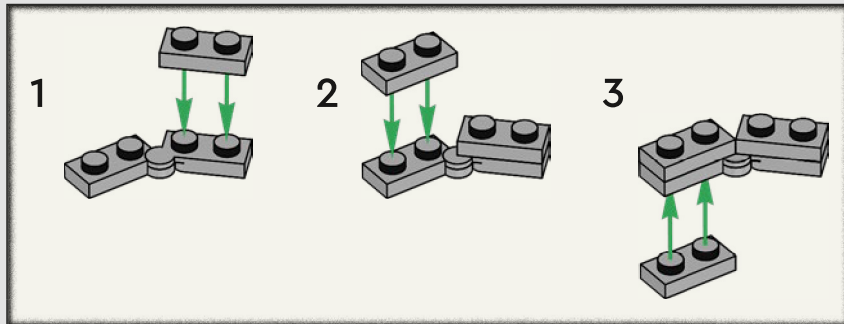

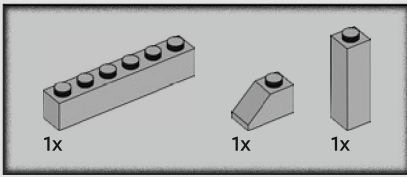

82

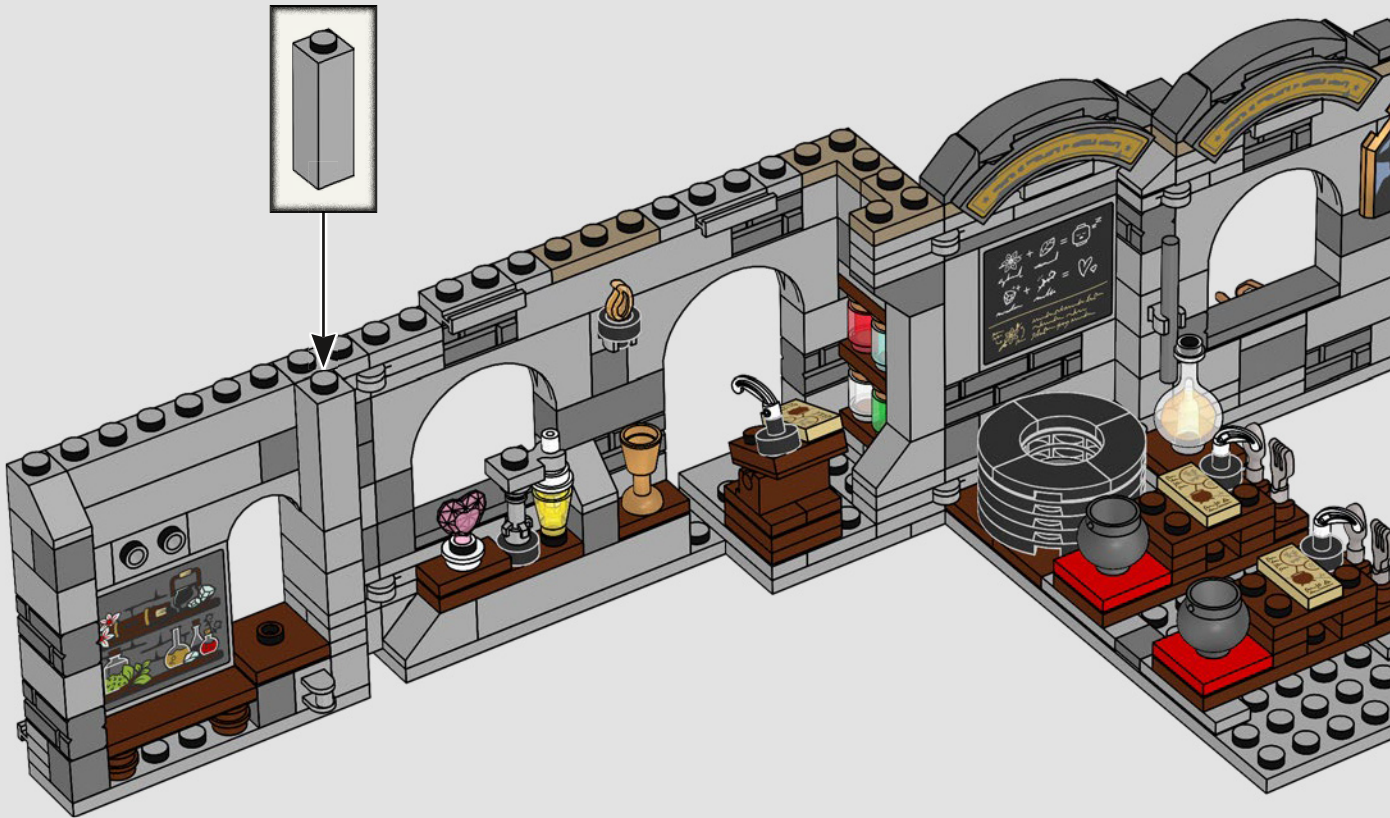

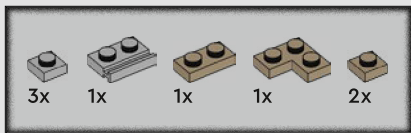

83

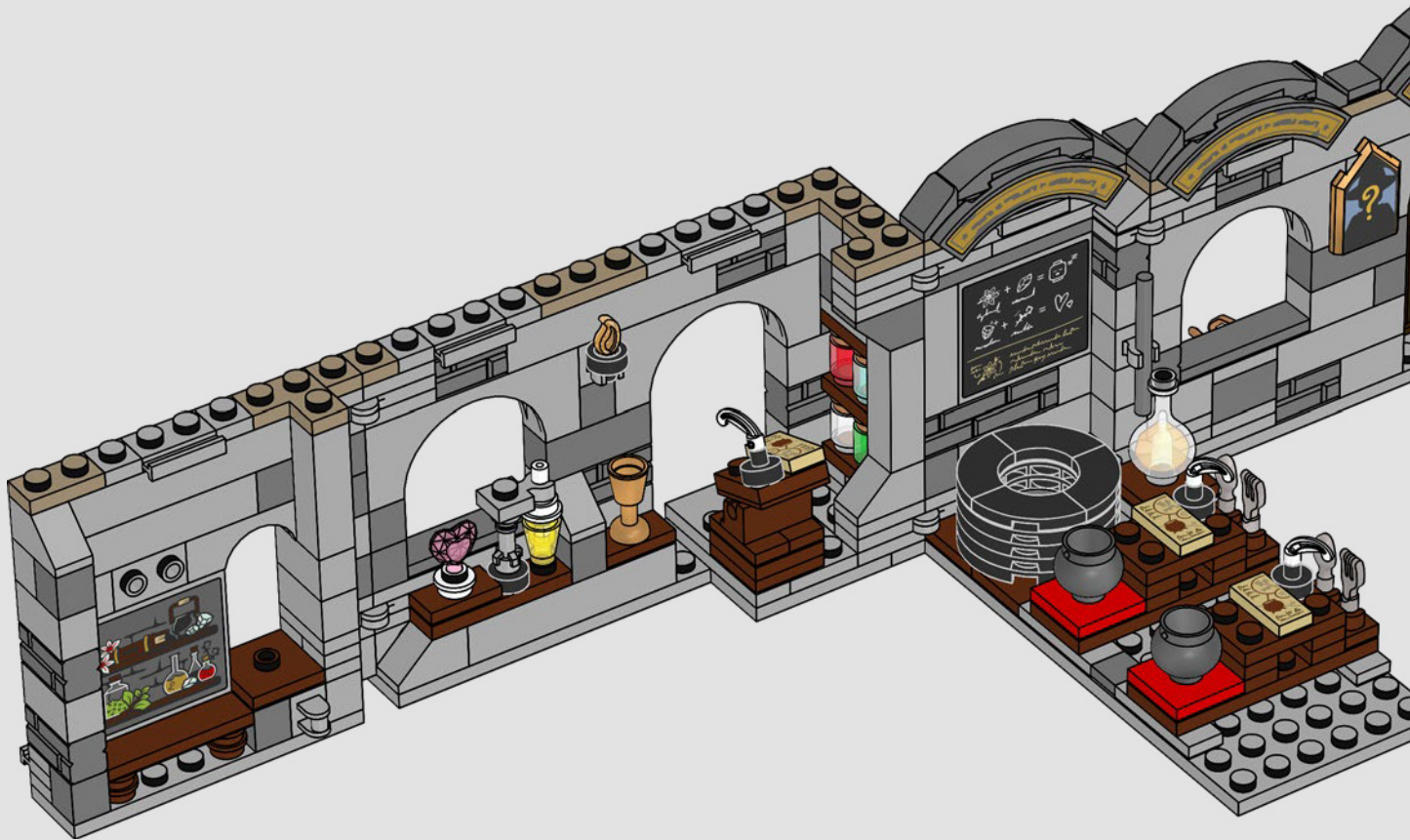

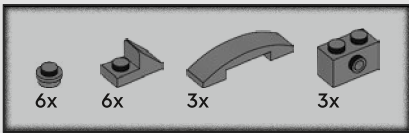

84

1

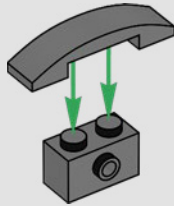

2

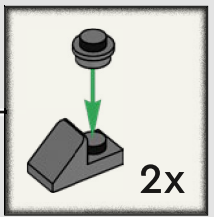
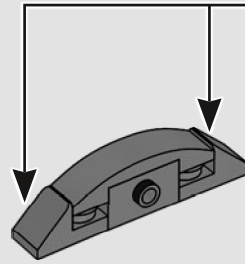

3x



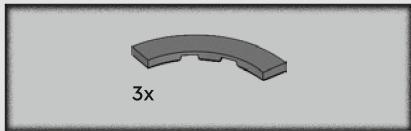

85

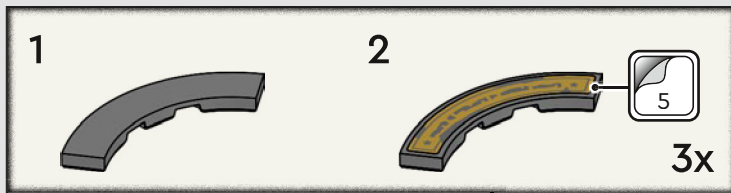

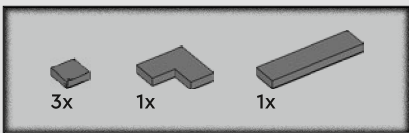

86



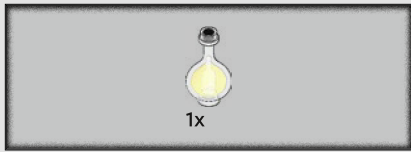

87



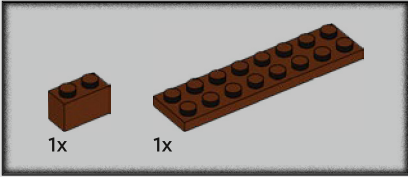

88

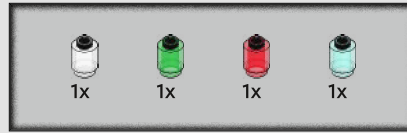
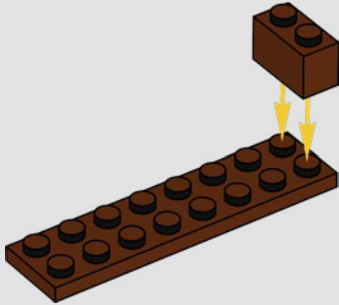

89

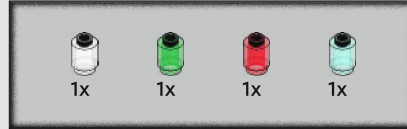
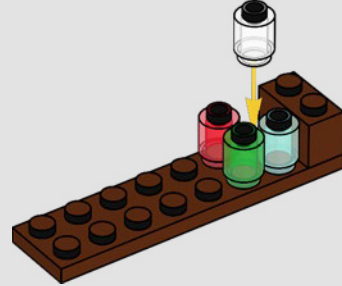

90

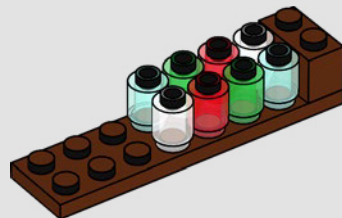

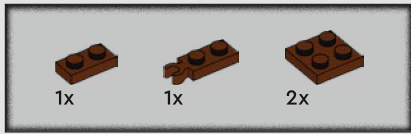

91

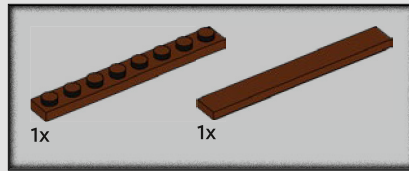
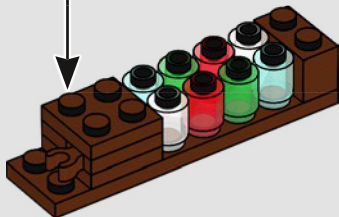
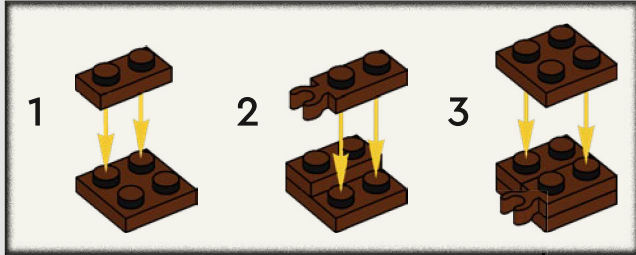

92

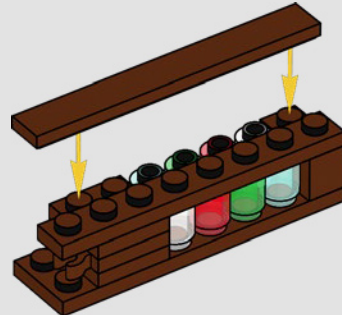

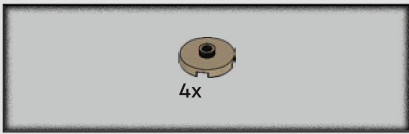

93

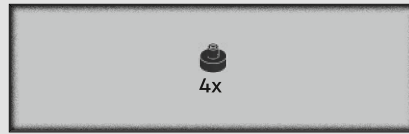
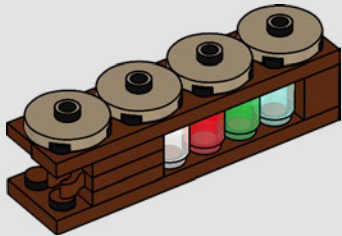

94

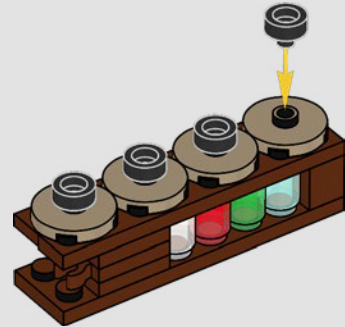

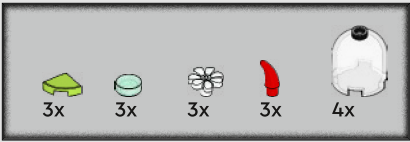

95

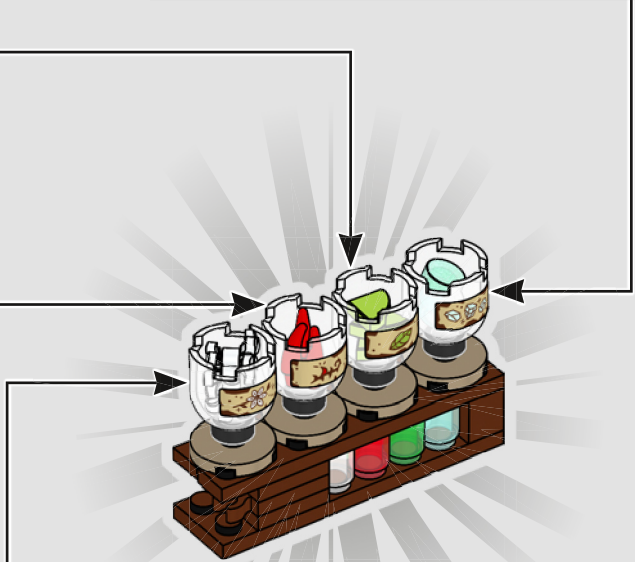
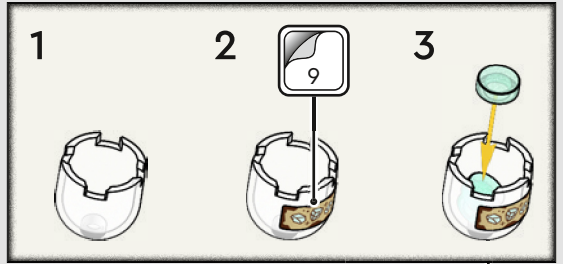
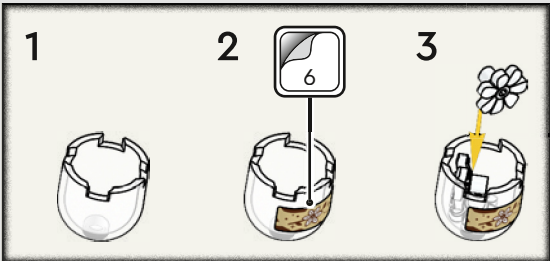
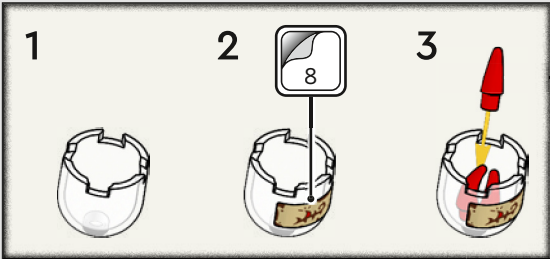
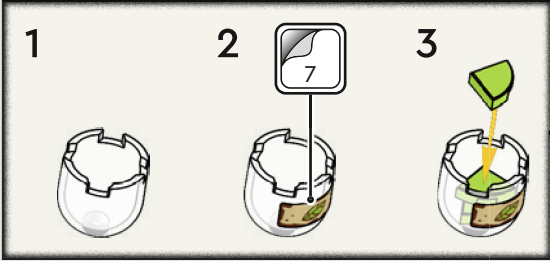





97



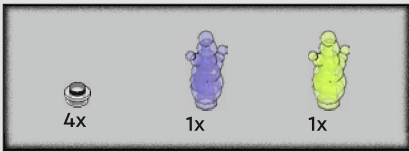

98

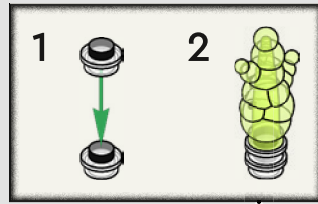











Harry Potter

WIZARDING
WORLD



76426



Each set sold separately and available for different periods of time

Les ensembles sont vendus séparément et à des périodes différentes.

Cada set se vende por separado y está disponible durante un cierto período de tiempo.



Build the most detailed
HOGWARTS™
CASTLE

Construisez
LE CHÂTEAU
DE POUDLARD
le plus détaillé

Construye
EL CASTILLO
DE HOGWARTS™
más detallado



76430

76431

9x
6186675

1x
6270027

1x
6173105

1x
4568933

1x
4596914

2x
6378773

1x
6308975

2x
6359881

4x
6191630

1x
6323536

2x
6353176

1x
6488941

94

3x
6167800

1x
4515350

1x
6270031

4x
4549436

4x
6132767

2x
4528604

4x
4550168

2x
6132768

1x
6270032

1x
6266865

1x
6254792

1x
4539481

3x
6061702

15x
4211399

1x
4558953

4x
6345426

1x
6296894

18x
4211398

2x
4211440

4x
4211614

10x
4211388

1x
6015344

7x
4211568

1x
6198932

7x
4211353

1x
6212077

11x
4211349

1x
4211397

2x
6211969

2x
4558169

1x
4211396

3x
4211445

1x
4211435

3x
4211394

2x
6059033

2x
4521921

6x
6416524

4x
4211395

4x
6106189

5x
4211393

1x
4211438

1x
4211795

1x
4211406

2x
4662161

1x
4293831

13x
4210633

18x
4211098

7x
4210848

1x
6056296

7x
6473748

14x
6000311

1x
4211096

12x
6069164

1x
4211052

1x
4543086

1x
6247784

4x
4211104

1x
6378143

3x
4211053

6x
4648256

1x
6055310

1x
6413109

6x
6458171

4x
4216581

1x
6112609

4x
6337003

1x
6403106

4x
6092590

1x
6186045

1x
4211149

4x
6221608

10x
4211150

2x
4211151

1x
6459597

4x
4565394

4x
4216695

1x
6167644

2x
4211189

1x
4211190

1x
4211194

2x
4211247

1x
4216945

1x
4585337

1x
4211211

3x
6211875

2x
6168642

3x
6406415

3x
6452532

1x
6357680

3x
6329369

3x
6270107

2x
6126048

1x
6486012

1x
6486013

1x
6235092

1x
6236271

4x
6240030

3x
6223655

4x
6286876

3x
6238673

3x
6238677

1x
6337597

1x
6357747

3x
6299900

3x
6238046

1x
6240042

1x
6475330

1x
6490873

1x
6477295

1x
6490522

1x
4505990

2x
6478297

4x
6167641

1x
6234805

2x
6363148

2x
6361354

2x
6363146

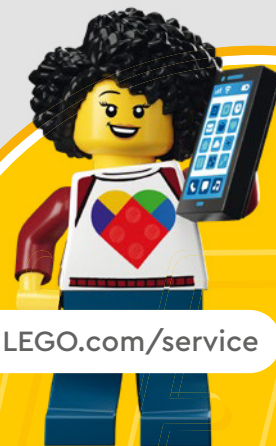

 [LEGO.com/service](https://www.LEGO.com/service)

FEEDBACK & REWARD



Scan this QR code or go to **LEGO.COM/PRODUCTSURVEY** and share your feedback about this LEGO® set. You will receive a free digital reward at the end of the survey via download link.



EN: FEEDBACK AND REWARD. Share your feedback and receive a free digital reward. **DE: FEEDBACK MIT BONUS.** Teile dein Feedback und erhalte einen digitalen Bonus geschenkt. **FR: AVIS ET RÉCOMPENSE.** Donnez votre avis et recevez une récompense numérique gratuite. **IT: DAI LA TUA OPINIONE E VINCI.** Condividi il tuo feedback e ricevi un premio digitale gratuito. **ES: RECOMPENSAMOS TU OPINIÓN.** Comparte tu opinión y recibe una recompensa digital gratis. **PT: DÊ O SEU FEEDBACK E GANHE RECOMPENSAS.** Partilhe o seu feedback e receba uma recompensa digital gratuita. **ZH: 反馈有奖。** 分享您的反馈意见, 获取免费数字奖励。 **PL: WYRAŻ OPINIĘ, ODBIERZ NAGRODĘ.** Podziel się swoją opinią i odbierz cyfrową nagrodę zupełnie za darmo. **CS: ODMĚNA ZA ZPĚTNOU VAZBU.** Podělte se o zpětnou vazbu a obdržíte bezplatnou digitální odměnu. **SK: ODMENA ZA SPÄTNÚ VÄZBU.** Podel'te sa o svoj názor a získajte bezplatnú digitálnu odmenu. **HU: VISSZAJELZÉS ÉS JUTALOM.** Oszd meg véleményed az ingyenes digitális jutalomért! **RO: FEEDBACK ȘI RECOMPENSĂ.** Trimite feedback și primește o recompensă digitală gratuită. **BG: ОТЗИВИ И НАГРАДИ.** Споделете вашите отзиви и получите безплатна дигитална награда. **LV: ATSAUKSMES UN BALVAS.** Sniedz savu atsauksmi un saņem bezmaksas digitālo balvu. **ET: TAGASISIDE JA PREEMIA.** Jaga oma tagasisidet ja saad kingituseks digitaalse preemia. **LT: ATSLIEPIMAI IR ATLYGIS.** Bendrinkite savo atsiliepiimą ir gaukite nemokamą skaitmeninį atlygį.

LEGO and the LEGO logo are trademarks of the/son des marques de commerce du/son marcas registradas de LEGO Group. ©2024 The LEGO Group.

WIZARDING WORLD and all related trademarks, characters, names, and indicia are © & ™ Warner Bros. Entertainment Inc.

Publishing Rights © JKR. (s24)