



ATLANTIS

7978



WARNING: CHOKING HAZARD.
Toy contains small parts and a small ball.
Not for children under 3 years.

1

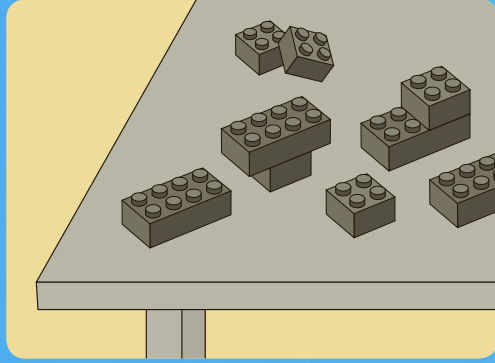
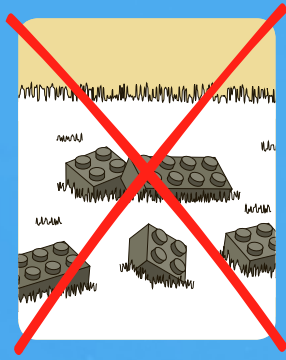

2

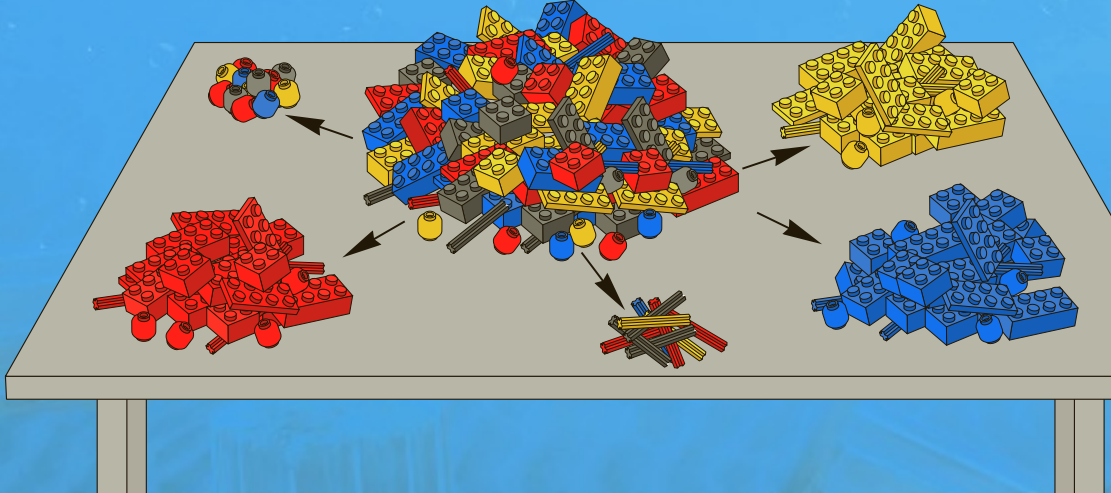

AVERTISSEMENT : RISQUE D'ÉTOUFFEMENT.
Le jouet contient des petites pièces ainsi qu'une petite boule.
Il ne convient pas aux enfants de moins de 3 ans.



ADVERTENCIA: PELIGRO DE ASFIXIA.

Juguete que contiene partes pequeñas y una pelota pequeña.
No recomendado para niños menores de 3 años.

3



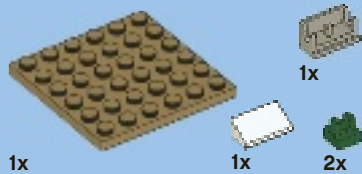

1

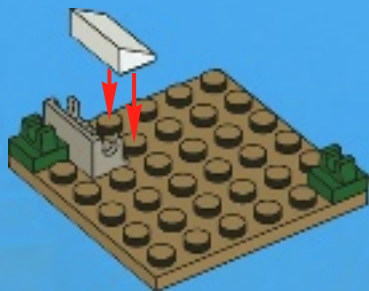

2

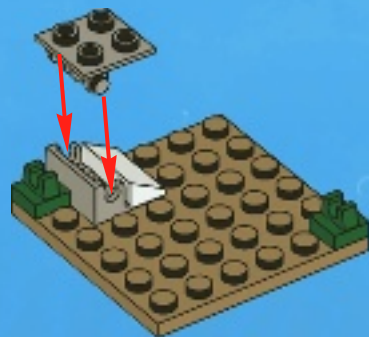



3

1



2

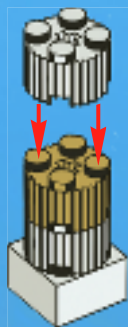

3



4

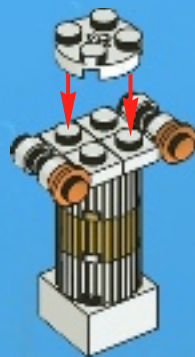



1x



1x

4

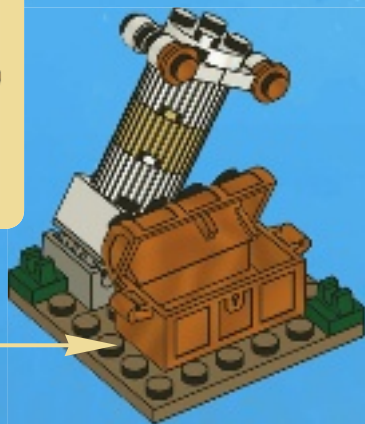
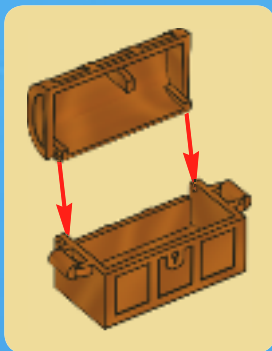



2x

5



1x



1x



1x

6





1x

1



1x

2

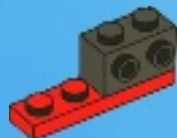

2x

3

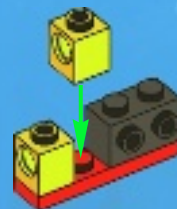



1x



1x

4

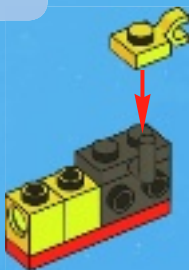

1x

5



1x



1x

6

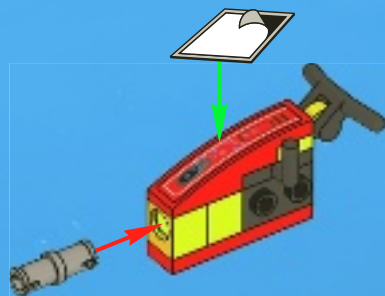

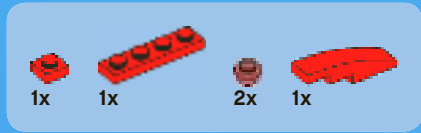

7

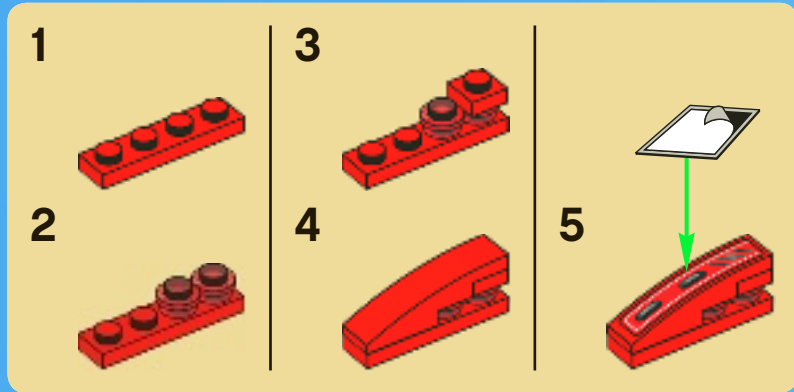

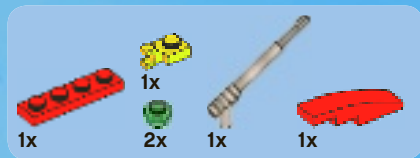

8

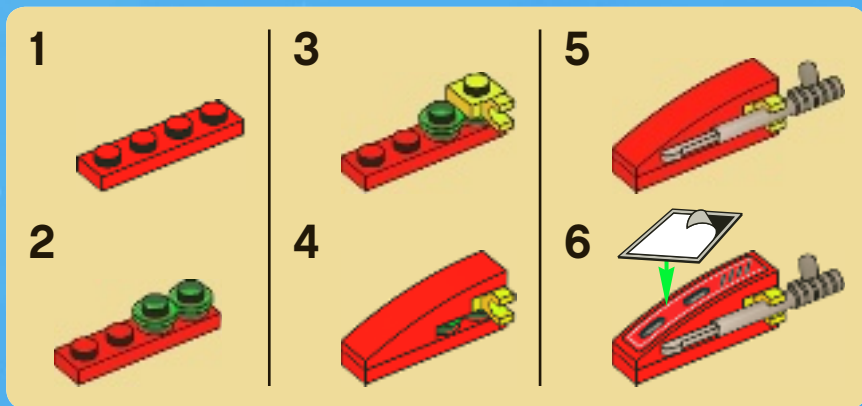



1x



1x



1x

9

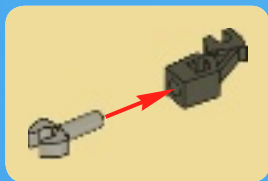

1x

1





2x

2

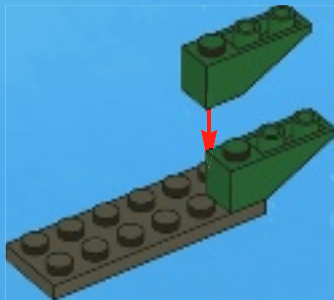

1x



1x

3

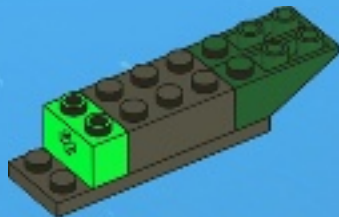



1x

4

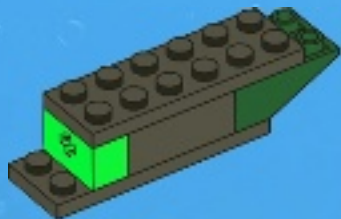

1x



2x

5

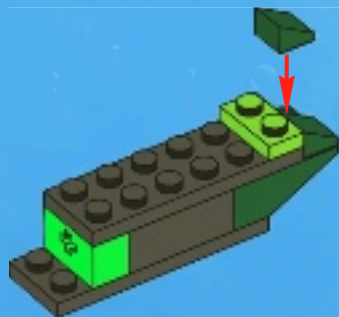



1x



4x

6

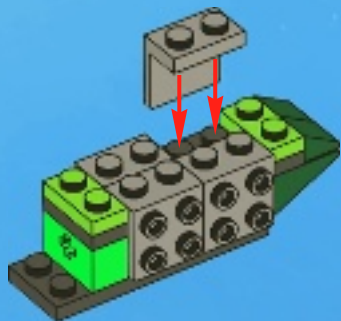

1x



1x

7

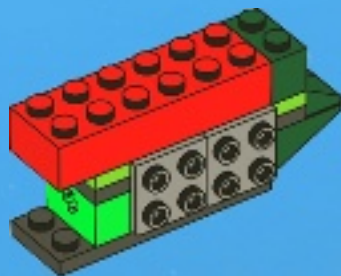



8

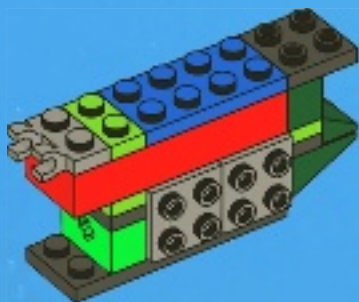

9

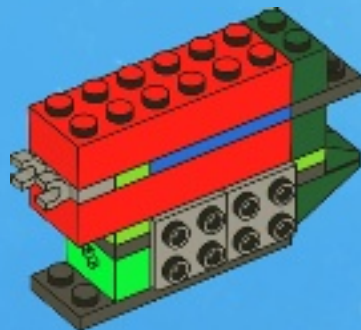



1x



1x



2x

10

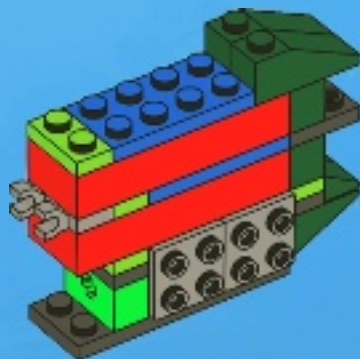

1x



1x

11

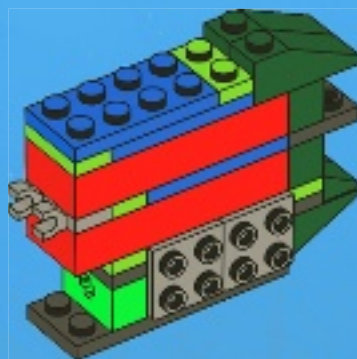



1x



2x

12

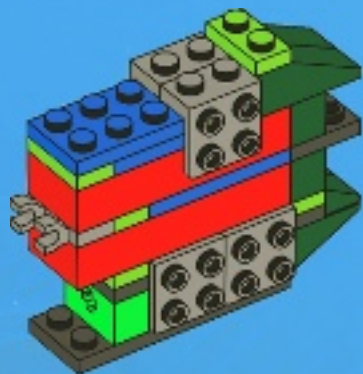

1x



2x

13

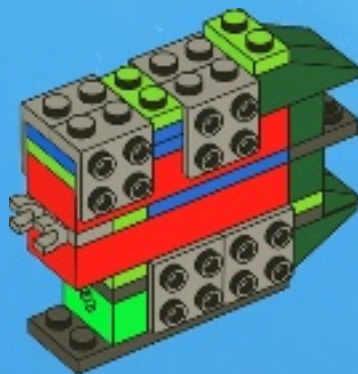



1x

14

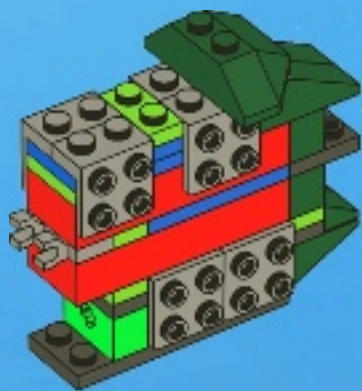

4x

15

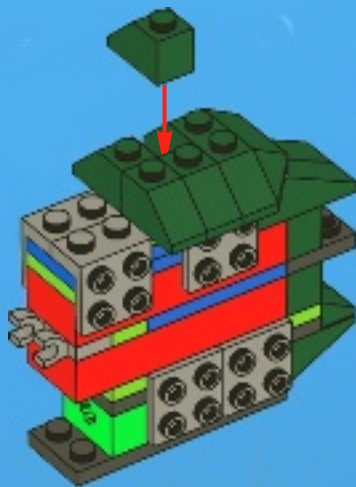



2x

16

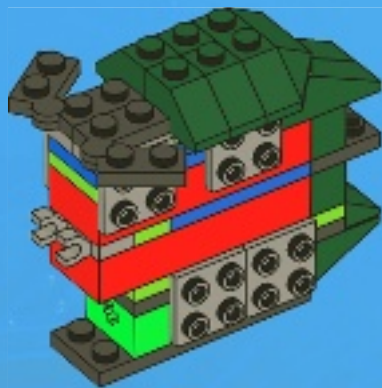

2x

17

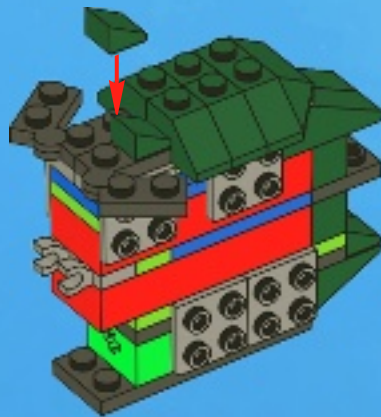

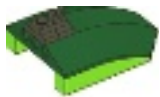

2x



1x

1



2x

2

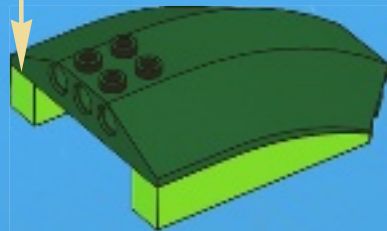
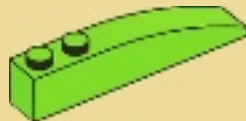



2x

3

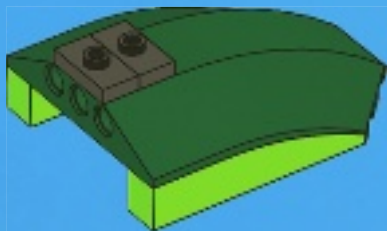

1x

4



2x

18

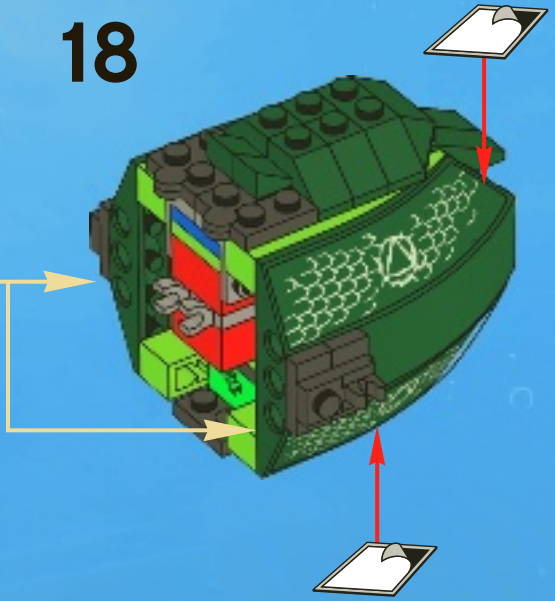

19

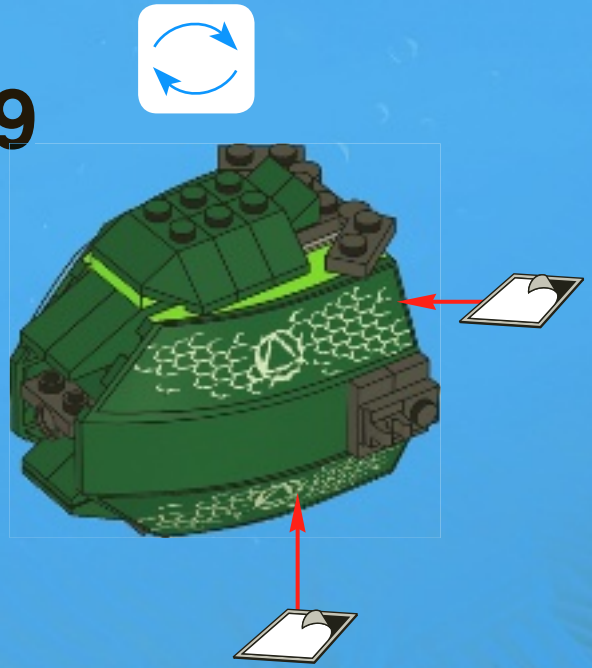

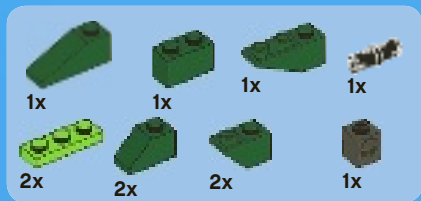

20

1



2



3

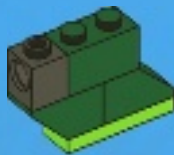

4

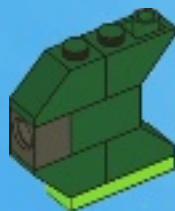

5



6

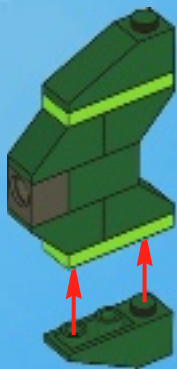

7

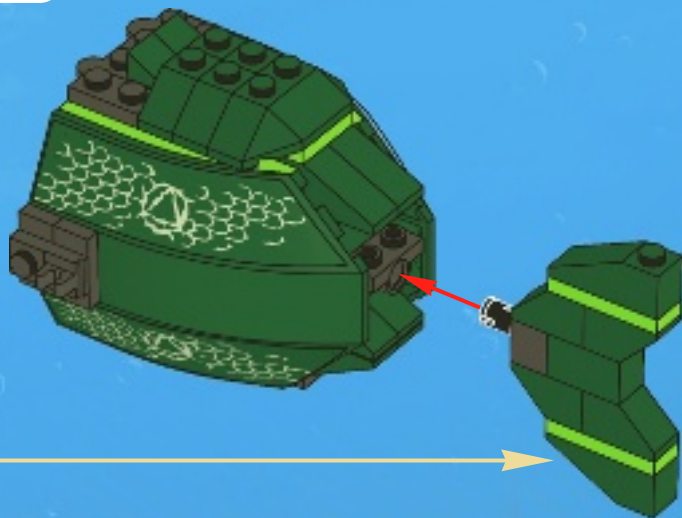



2x

21

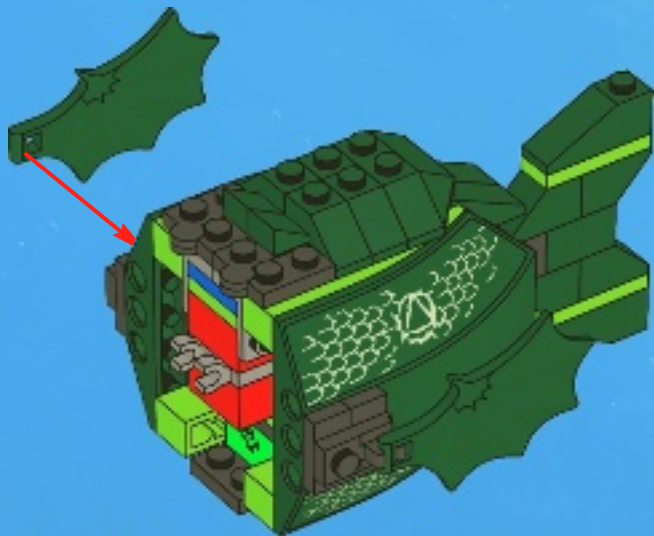



1x

1



2x

2



1x

3

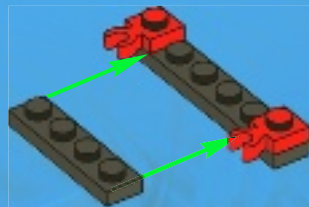



2x

4

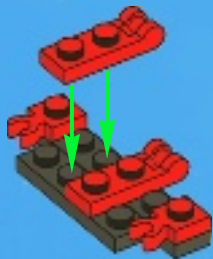

2x

5



2x

6



1x



1x

7

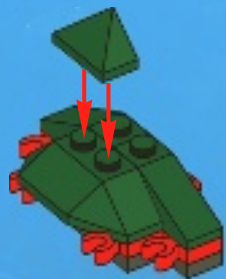



3x



1x

8



22

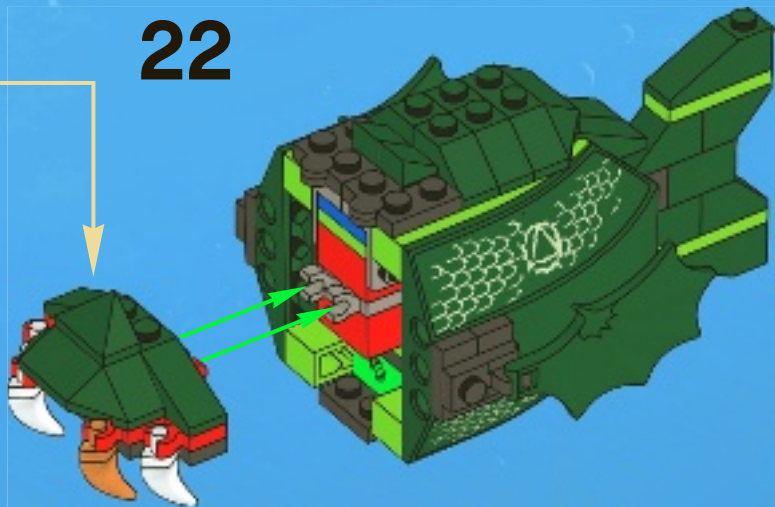



1x

1



2x

2





1x

3



1x

4





6x

5



2x

6





2x



2x

7

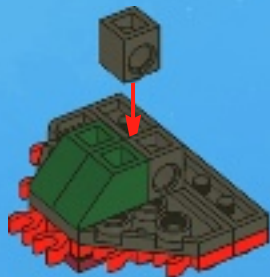

1x

8



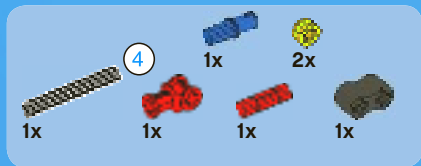

9

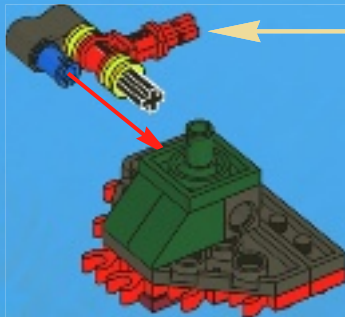
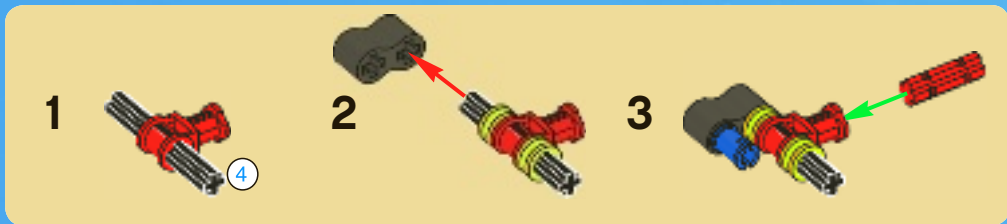



1x



1x

10

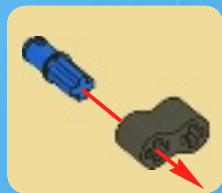

2x



4x

11



23

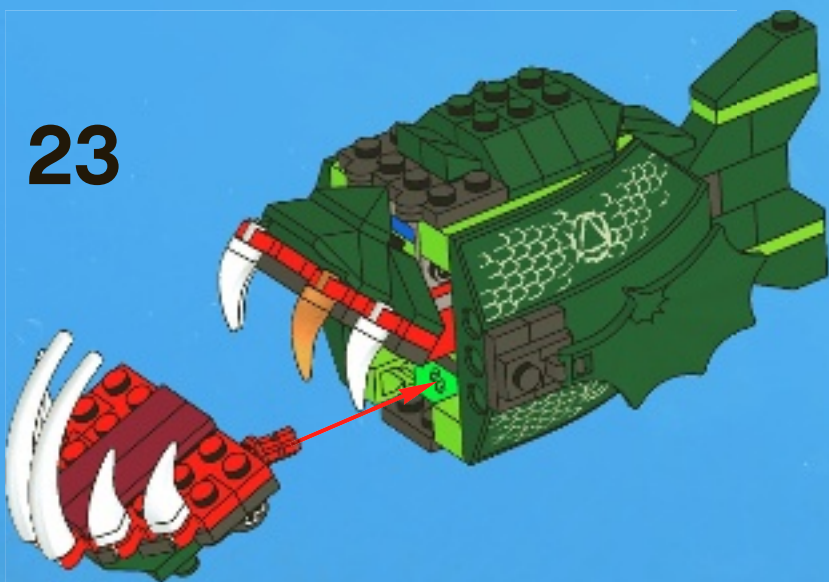



1x



1x

24



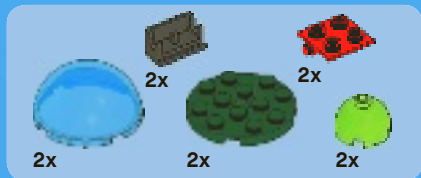

25

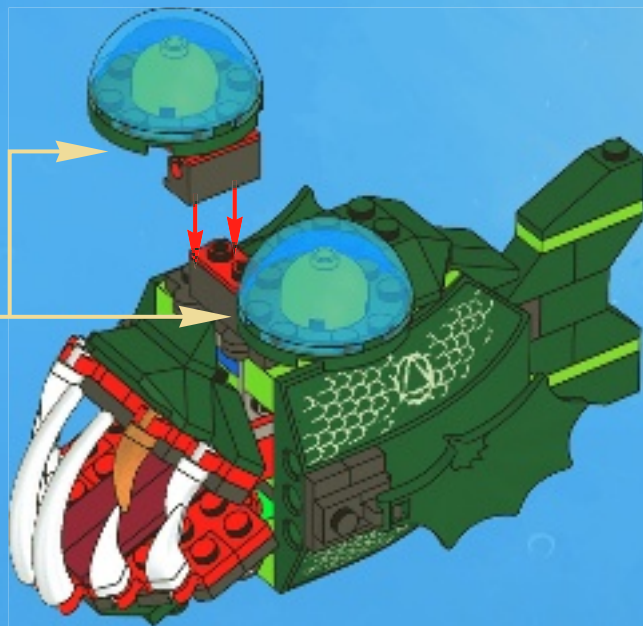
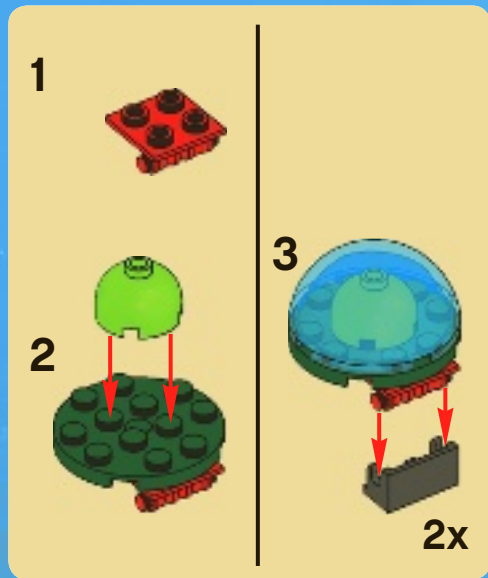



1x



1x

26

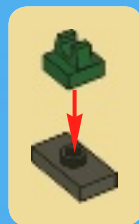



27

1

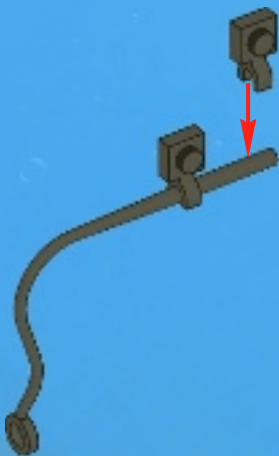

2



3

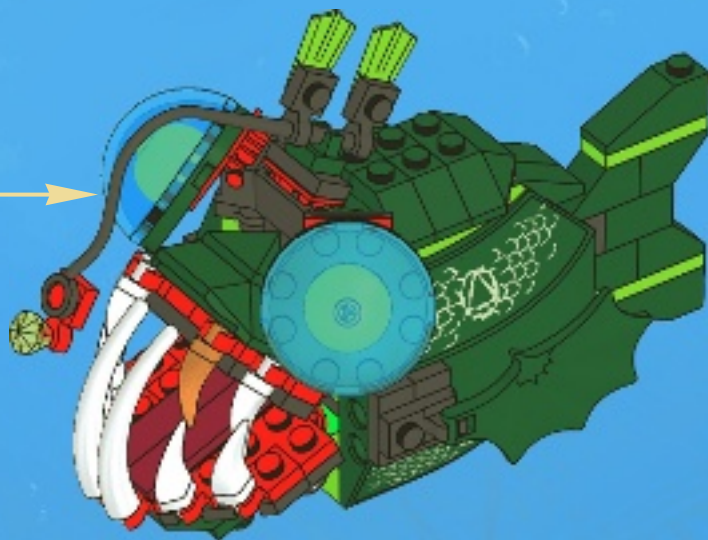
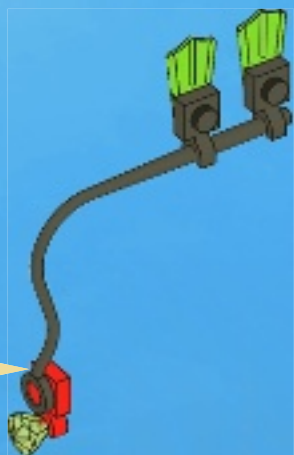

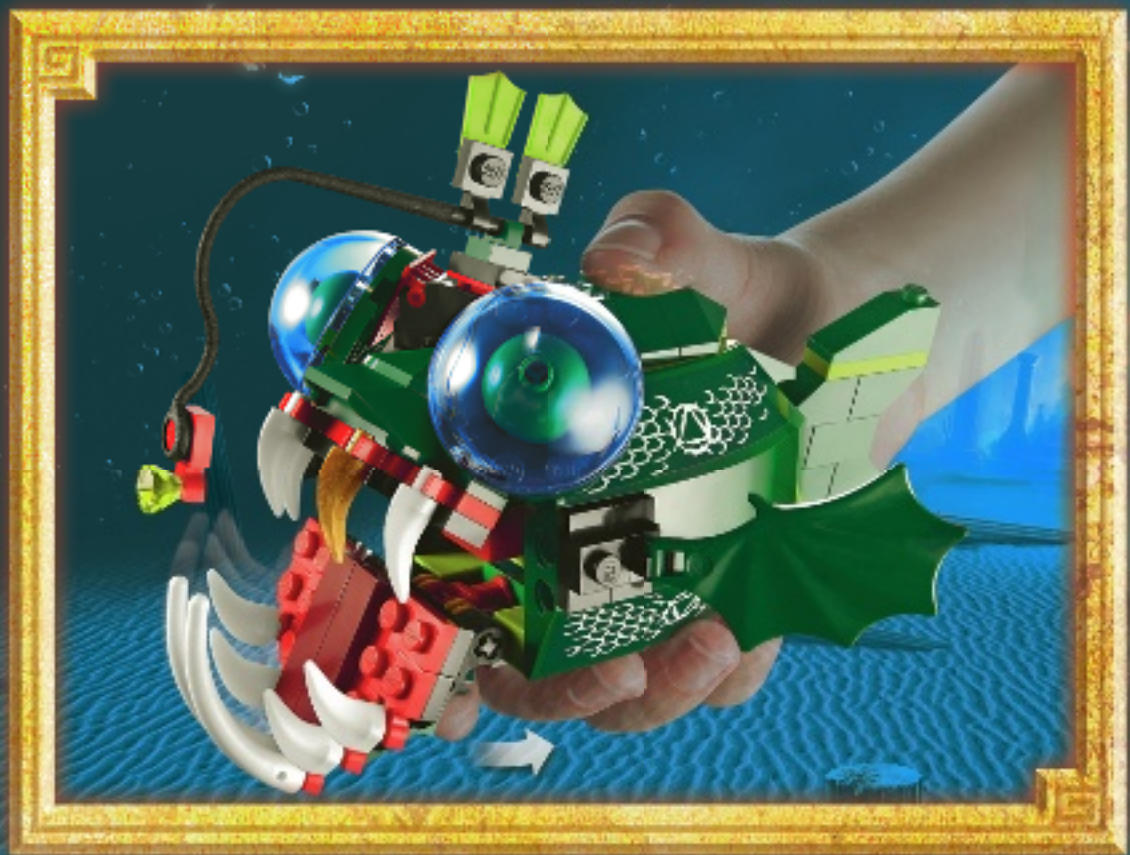



7977



7976



7978



7985



7984





7978



7977



7985



7984

7976



Customer Service

Kundenservice

Service Consommateurs

Servicio Al Consumidor

www.lego.com/service or dial



00800 5346 5555 :



1-800-422-5346 :





www.LEGOclub.com



LEGO® Club Email



LEGO® Club Magazine

SIGN UP ONLINE!

www.LEGOclub.com



00800 5346 5555*



1-866-534-6258 • 1-877-518-5346

US & Canada only

Outside continental

LEGO club
FREE! GRATIS! GRATUIT!

- * Freephone. Mobile charges may apply.
- * Numéro sans frais. Des frais peuvent s'appliquer avec les téléphones cellulaires.
- * Gebührenfrei. Kosten für Anrufe aus Mobilfunknetzen können abweichen.
- * Gratis telefonnummer vanaf vaste lijn.
- * Det er et gratis nummer, når du ringer fra fasttelefon.
- * Det är gratis, när du ringer från en fast telefon.
- * Numéro sans frais. Des frais peuvent s'appliquer avec les téléphones portables.



WIN!

Go to www.LEGOsurvey.com/product to fill out a survey for a chance to win a cool LEGO® Product.

No purchase necessary.

Open to all residents where not prohibited.



www.LEGO.com



www.LEGOsurvey.com/product

GEWINNE!

Nimm an der Umfrage auf www.LEGOsurvey.com/product teil und hab die Chance ein cooles LEGO® Produkt zu gewinnen!

Die Teilnahme am Gewinnspiel führt zu keinerlei Kaufverpflichtungen. Teilnahme in allen nicht ausgeschlossenen Ländern möglich.

WIN!

Ga naar www.LEGOsurvey.com/product, vul een enquêteformulier in en maak kans op een cool LEGO® product.

Geen aankoopverplichting. Iedereen mag deelnemen, uitgezonderd ingezetenden van landen waar een enquêteverbod geldt.

GAGNE!

Visite www.LEGOsurvey.com/product pour répondre à un questionnaire et avoir une chance de gagner un produit LEGO® très cool!

Aucune obligation d'achat. Ouvert à tous les résidents des pays autorisés.

当てよう!

www.LEGOsurvey.com/product にアクセスして、アンケートにご記入ください。当選者にはレゴ®製品を差し上げます。

お買い上げの必要はありません。禁止されていない限り、すべての皆様にご利用いただけます。