



MONKIE KID 悟空小侠™

80028



3

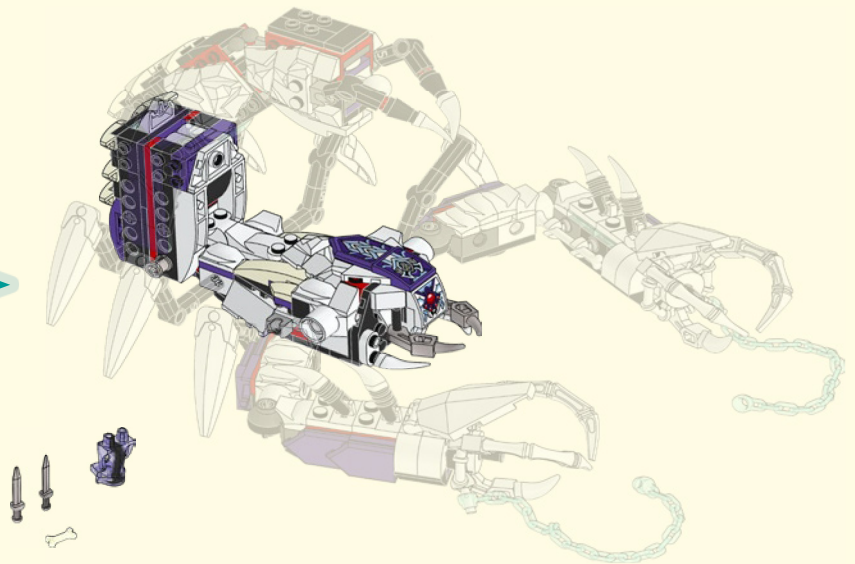
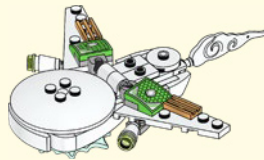

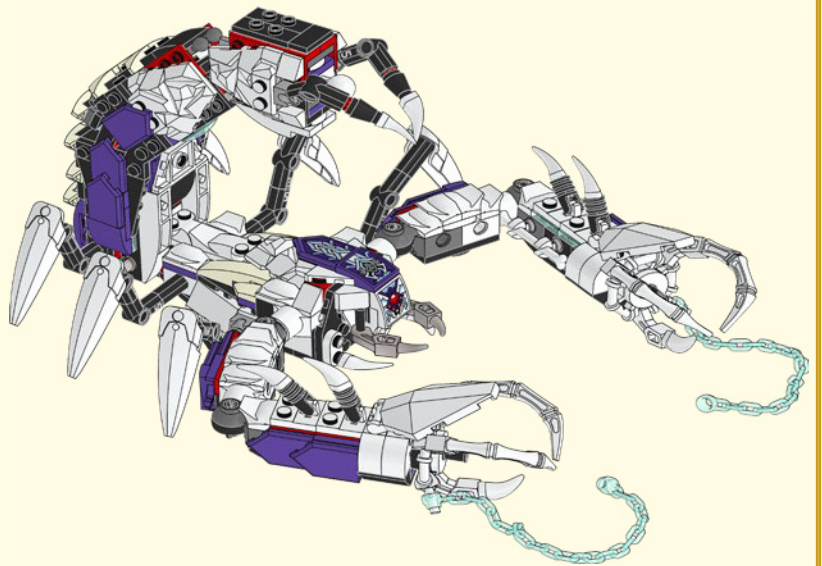
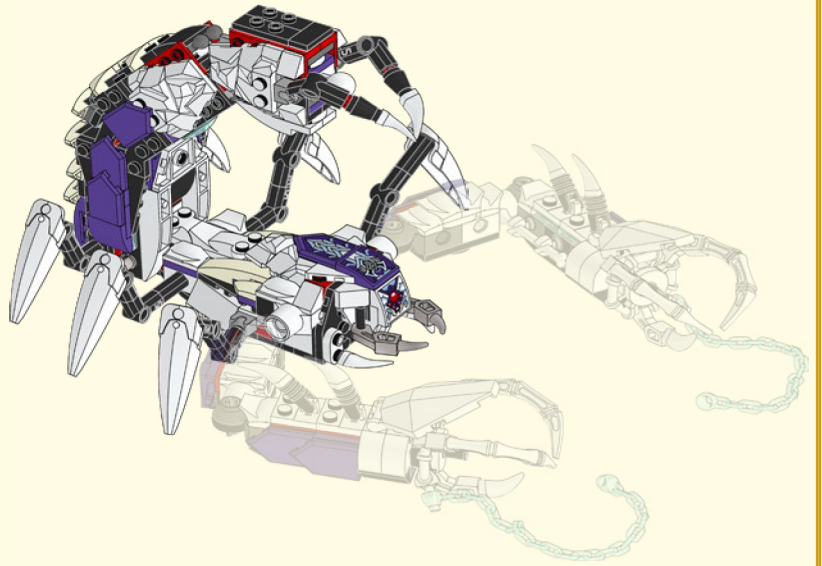





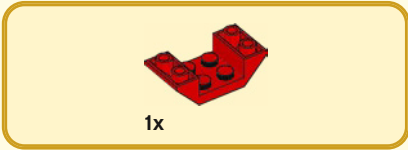

1

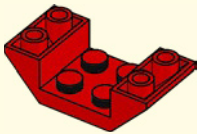

2

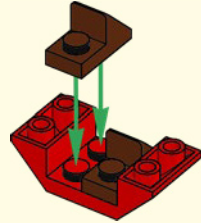

3

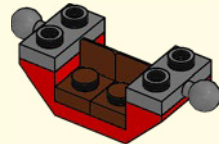

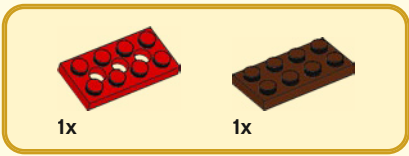

4

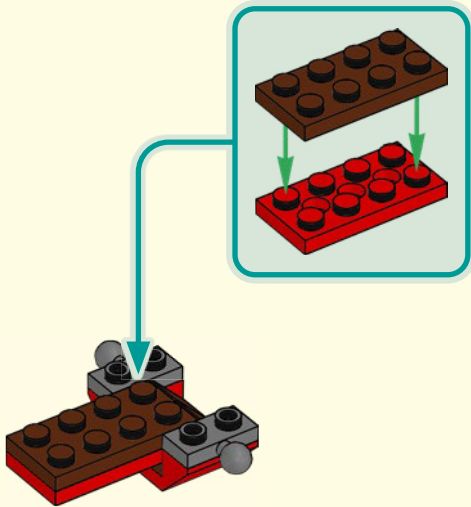

5

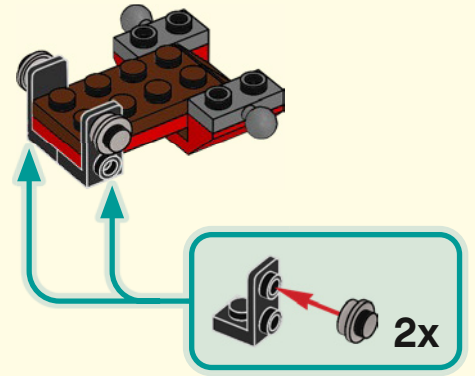

6

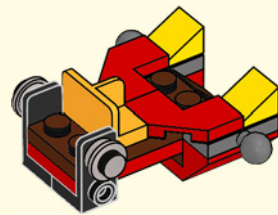



7

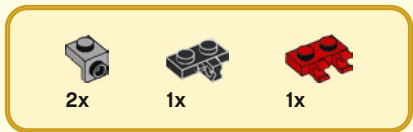
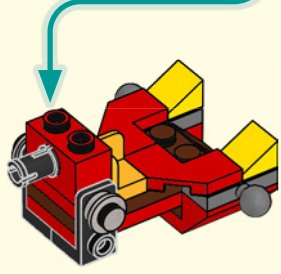
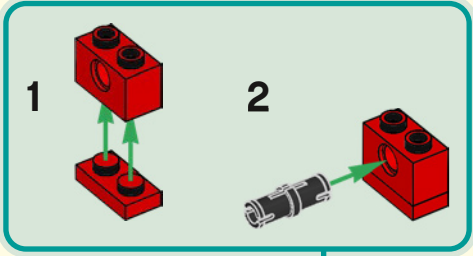

8

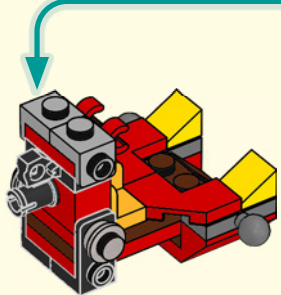
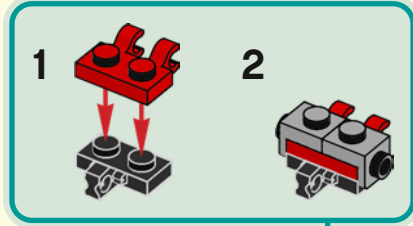

9

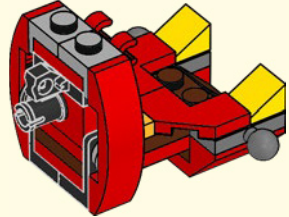



10

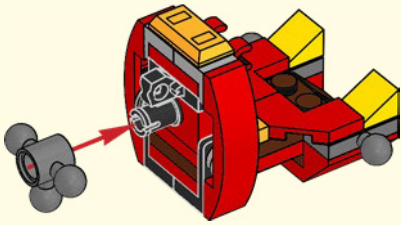

11

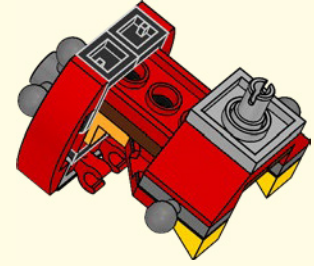

12

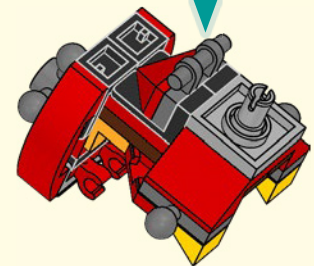
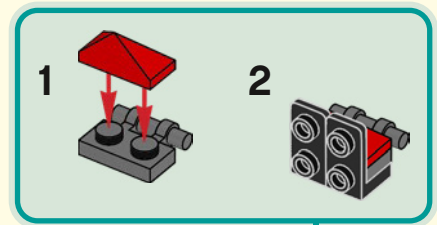

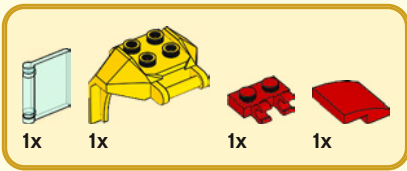

13

1

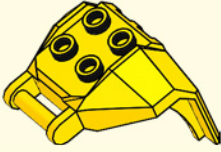

2

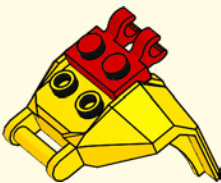

3

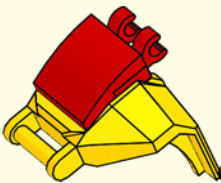

4

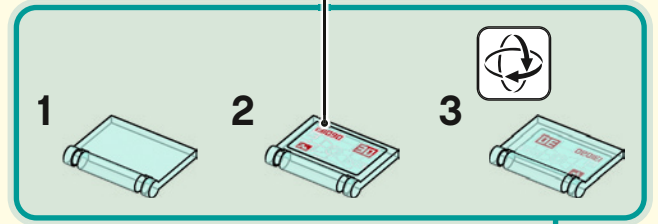
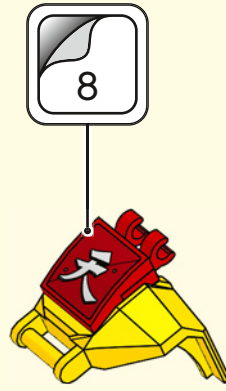

5

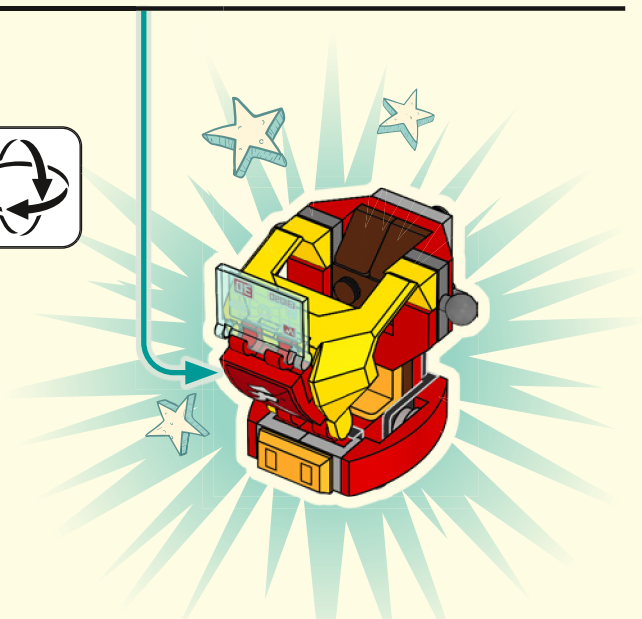

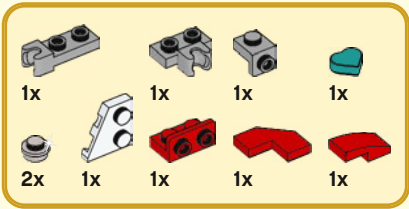

14

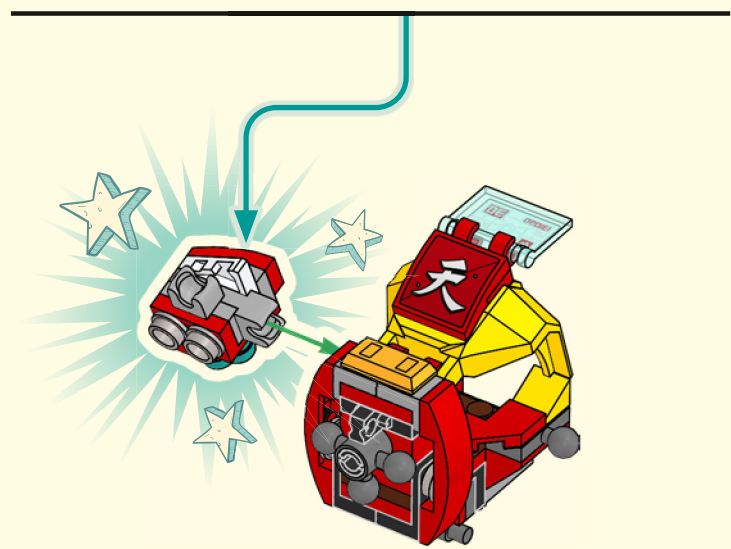
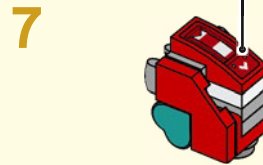
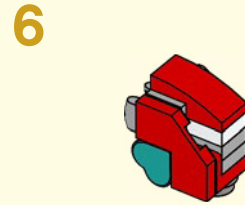
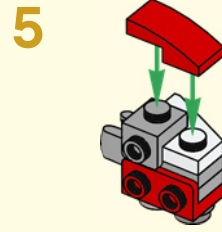
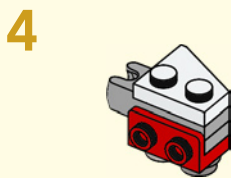
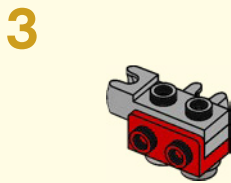
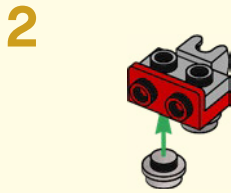
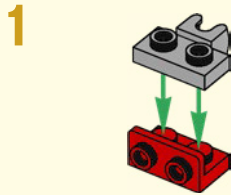

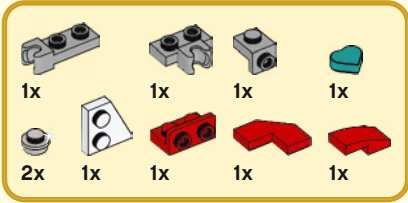

15

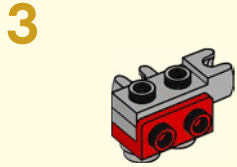
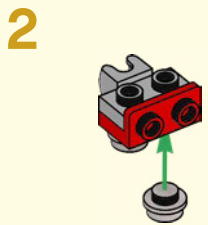
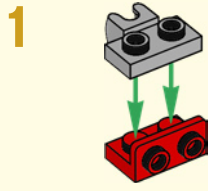

5

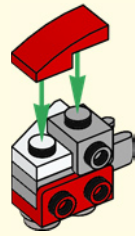

6

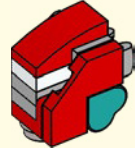

7

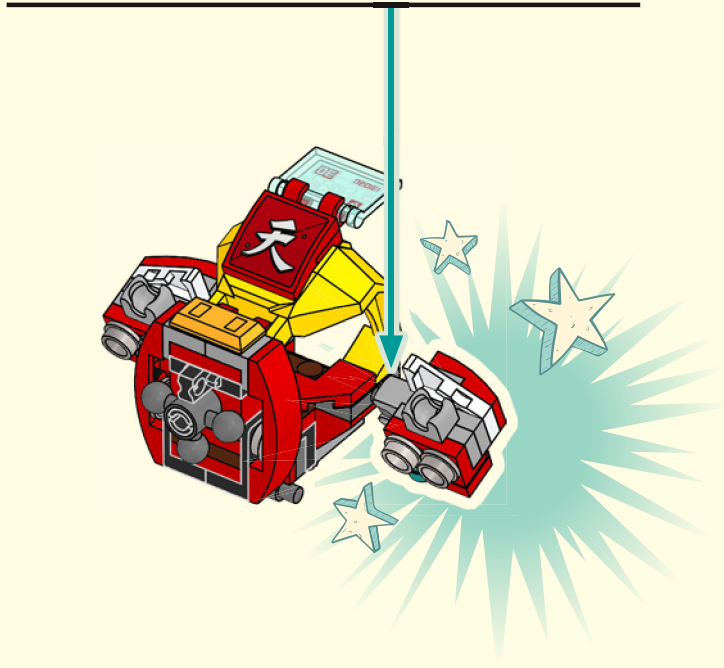



16

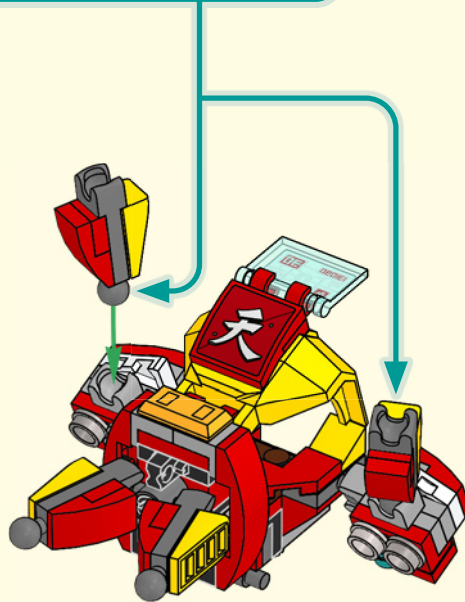
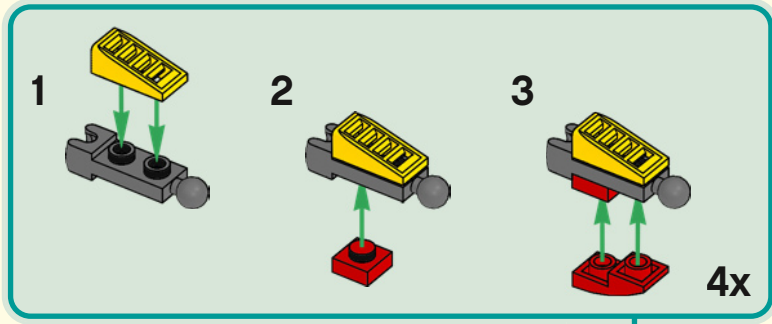

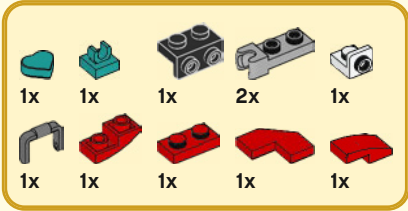

17

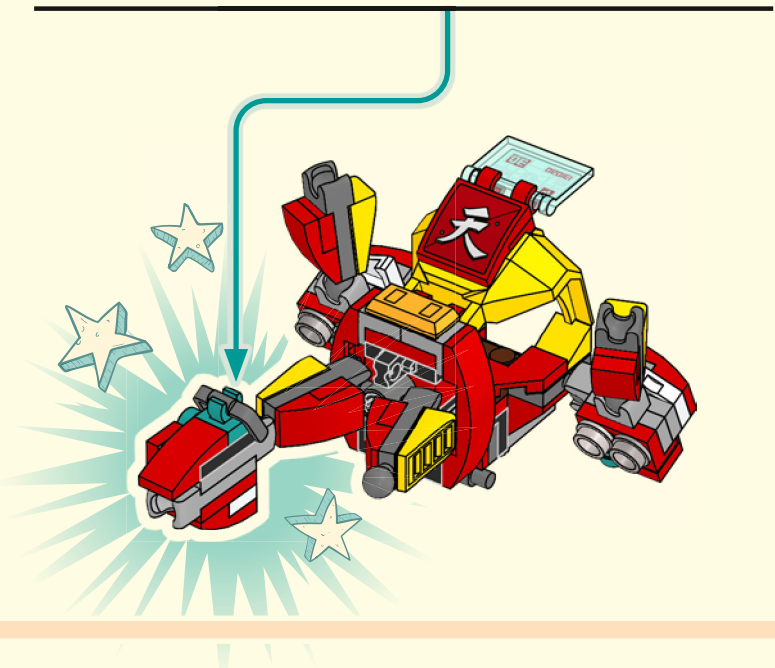
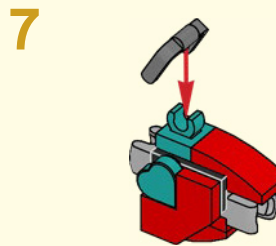
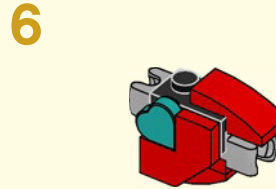
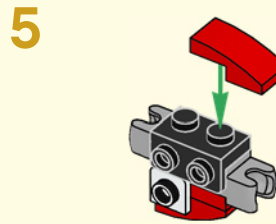
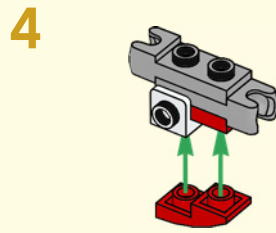
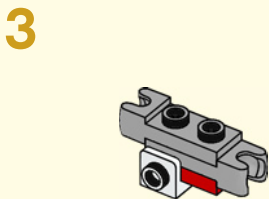
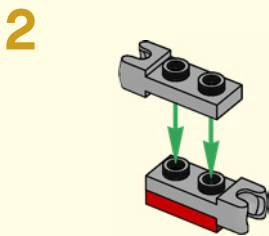
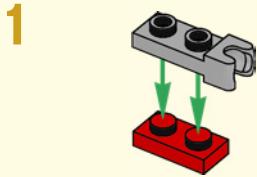

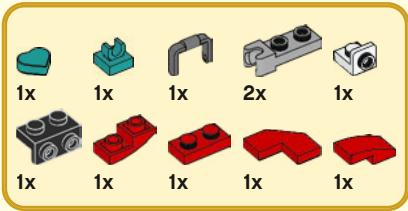

18

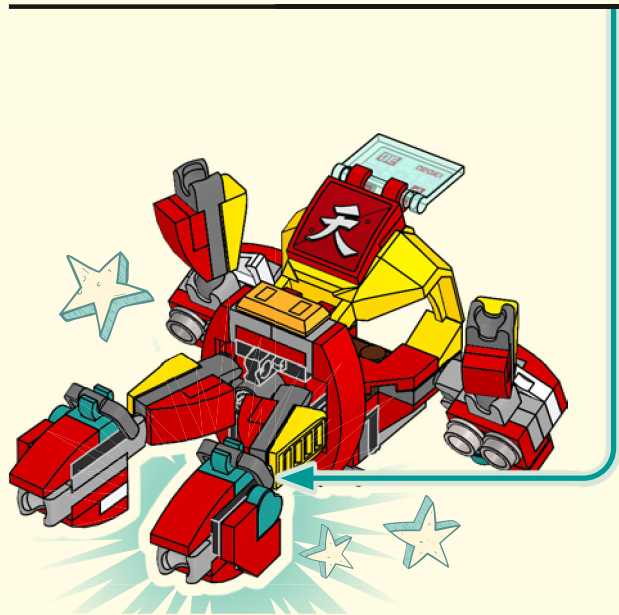
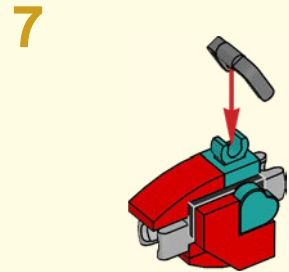
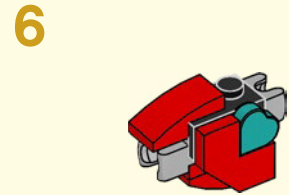
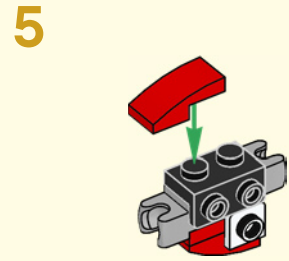
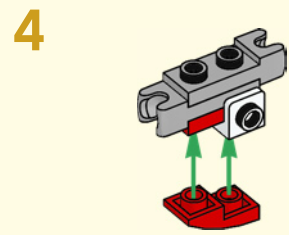
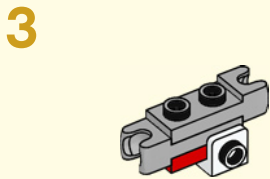
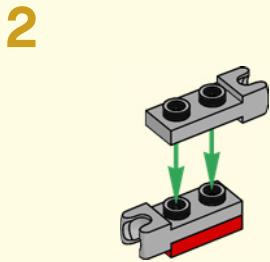
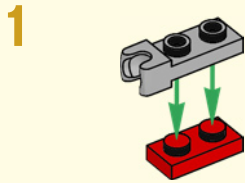



2x



2x



2x



2x



4x

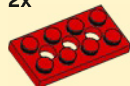

2x



2x



2x



2x

19

1

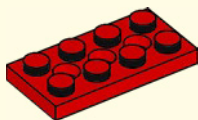

2

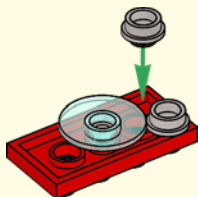

3

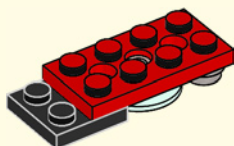

4

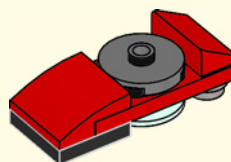

5



11



6

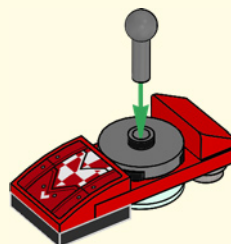

2x



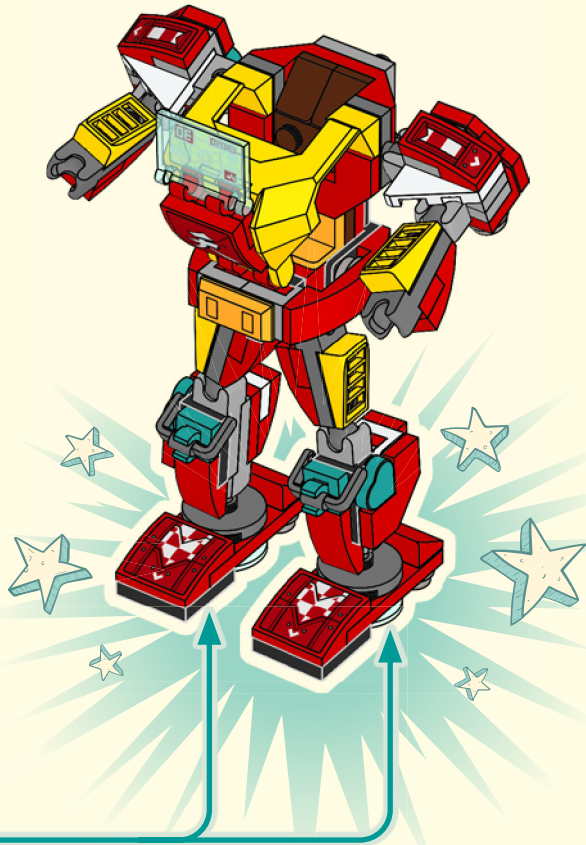



3x



3x

20

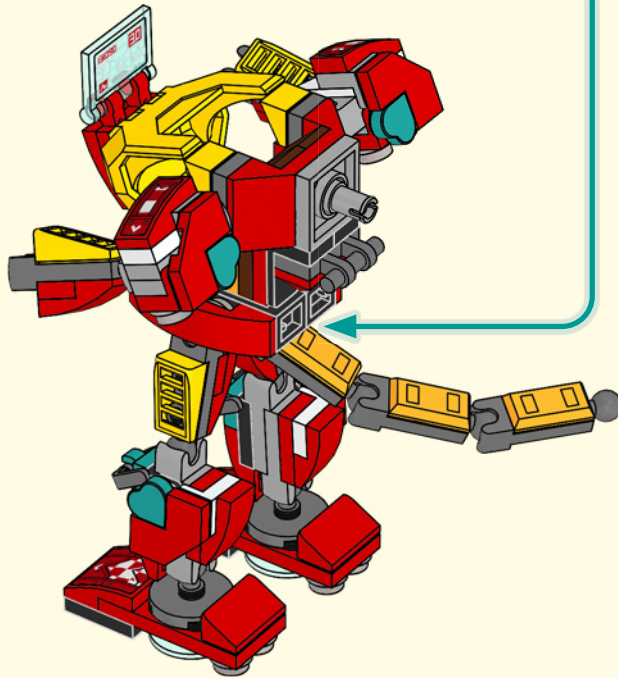
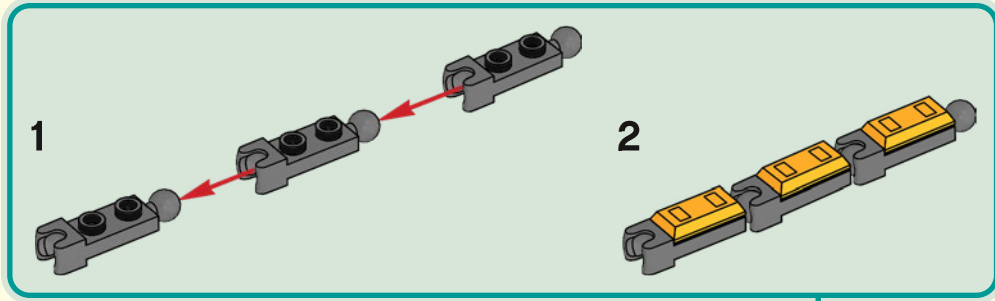



1x

1x

21

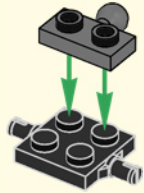

1x

22

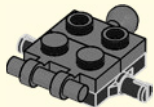

2x

23

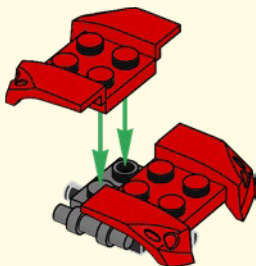

1x

24

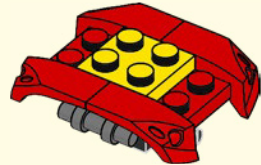

2x

25

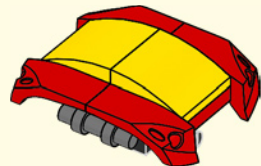

26

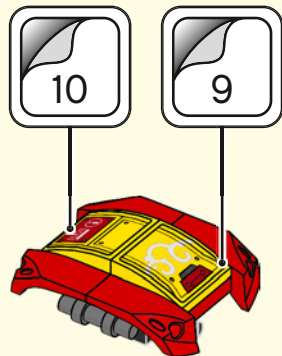



27

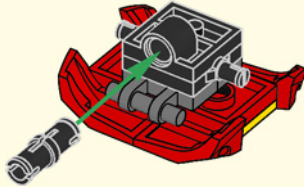

28

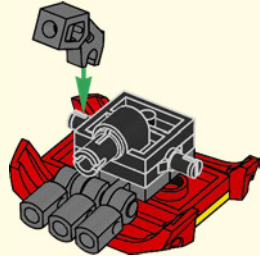

29

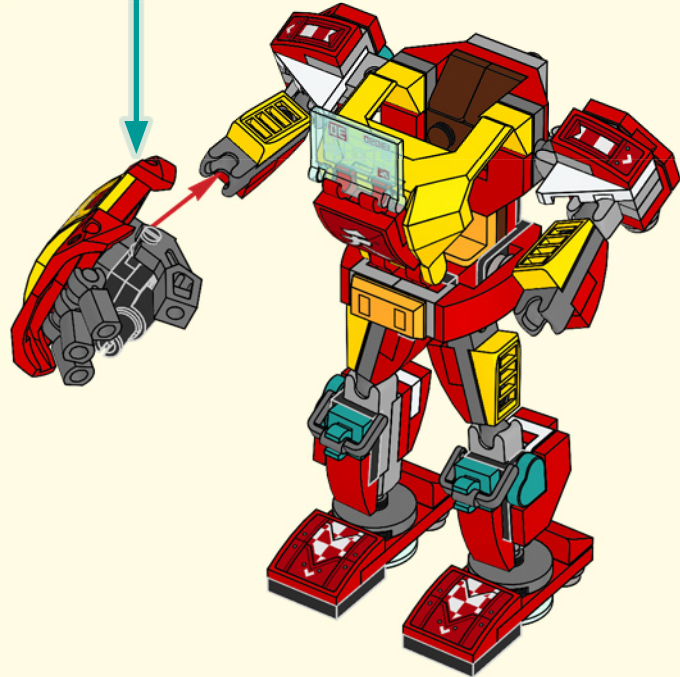

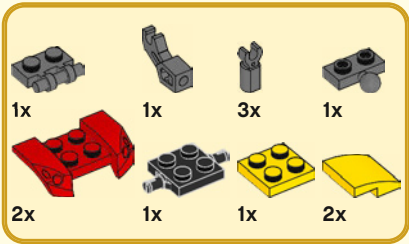

30

1

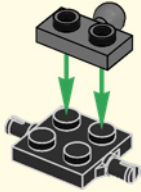

2

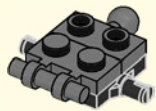

3

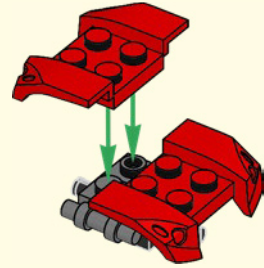

4



5

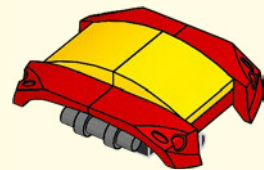

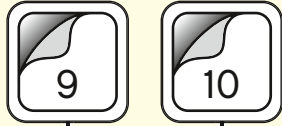

6



7

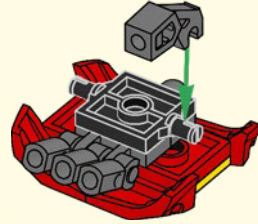

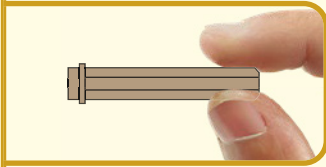
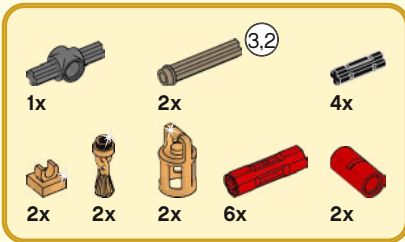
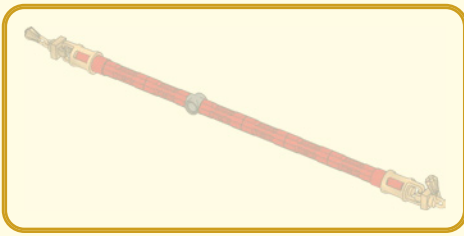

31

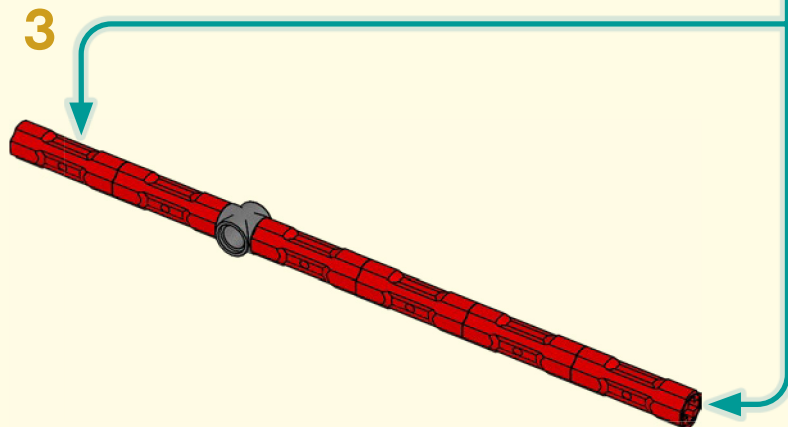
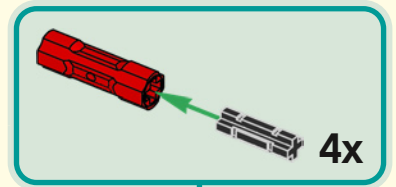
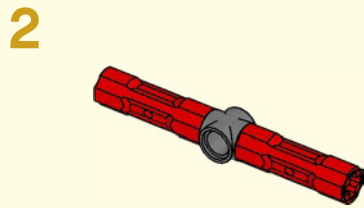
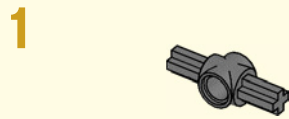

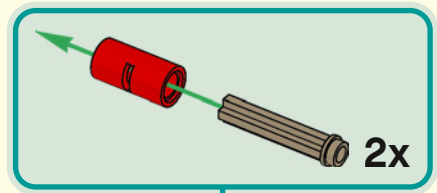

4

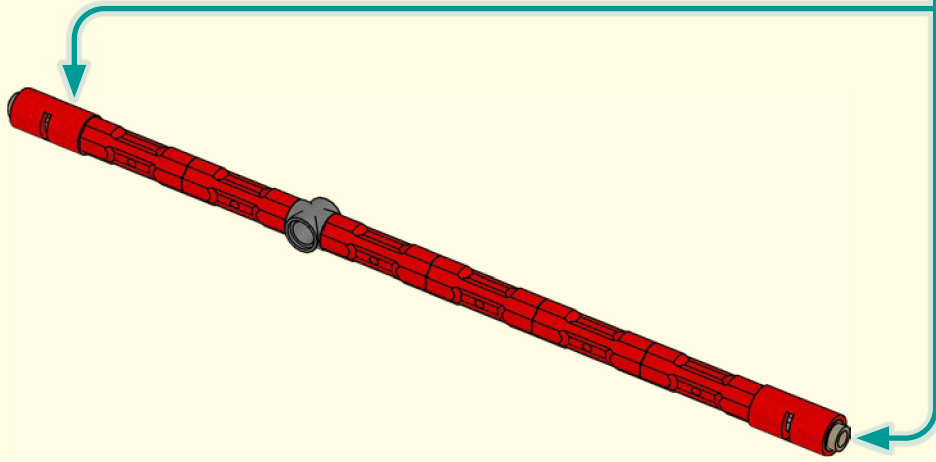

5

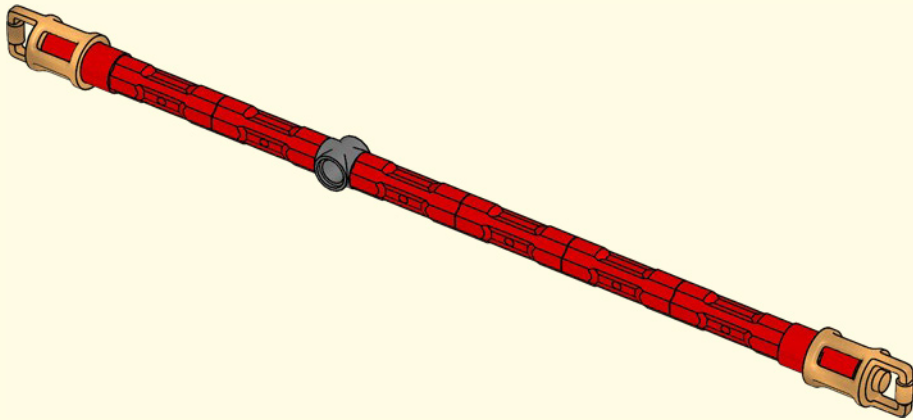

6

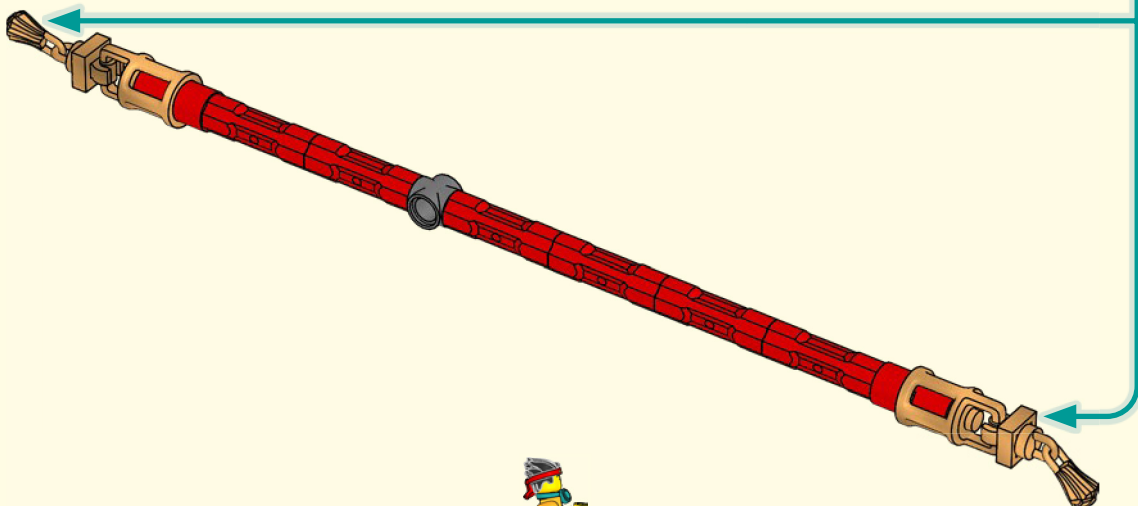
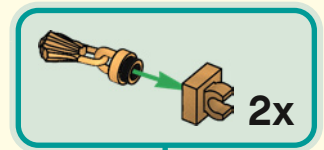



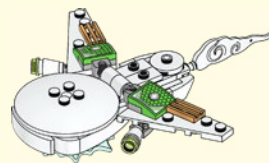

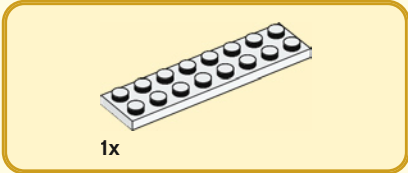
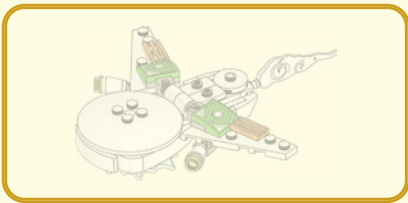

1x

1

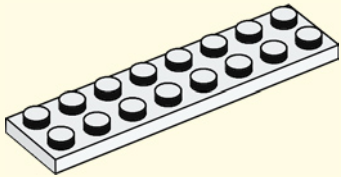

2x

4x

2

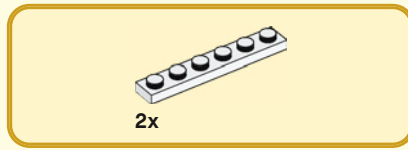
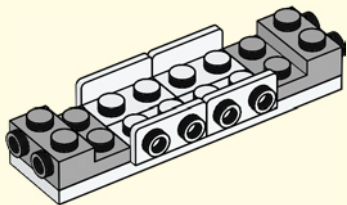

2x

3

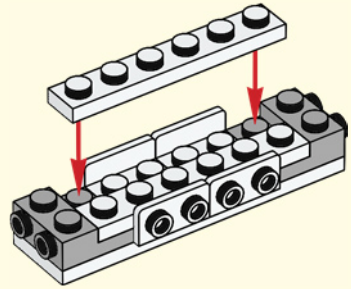

1x

1x

4

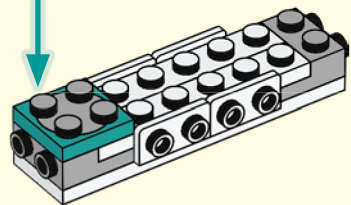
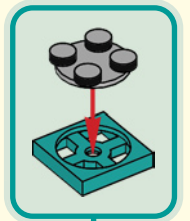

2x

1x

2x

5

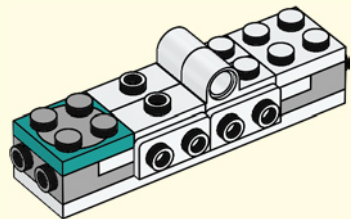



6

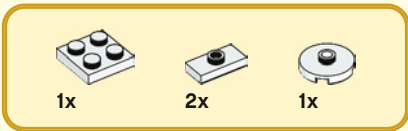
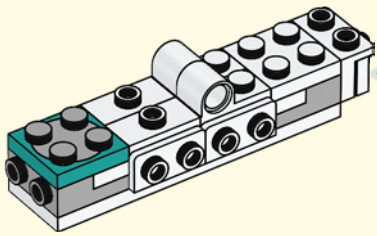
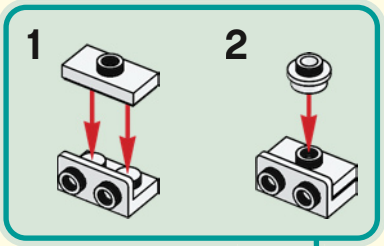

7

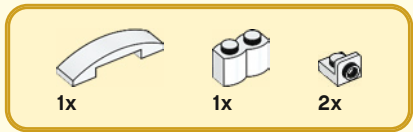
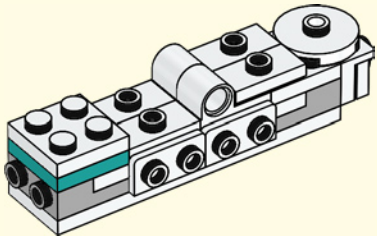

8

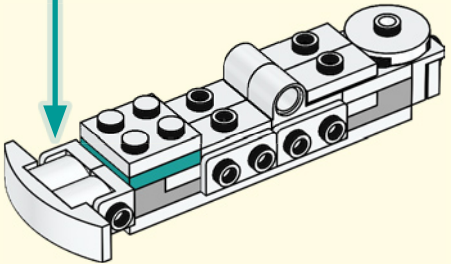
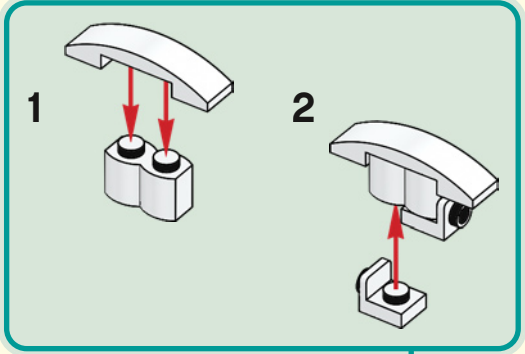

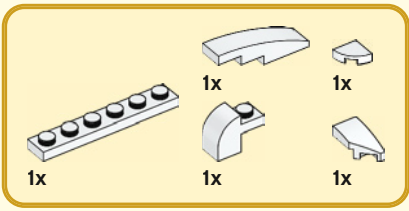

9

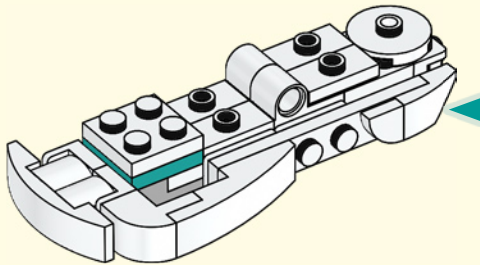
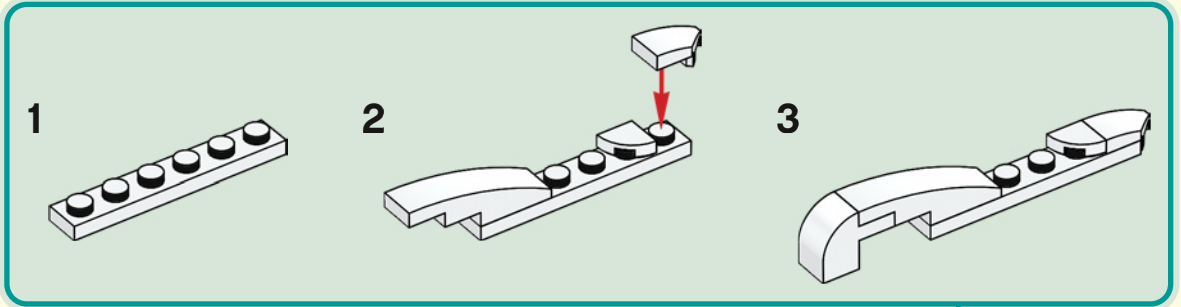

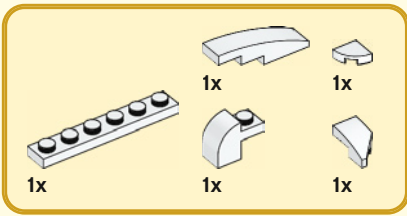

10

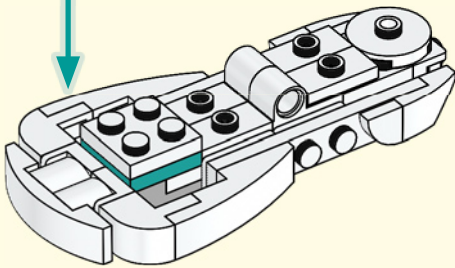
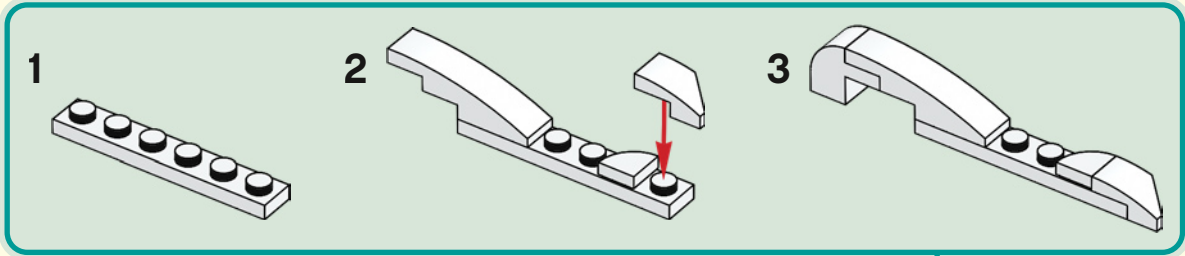

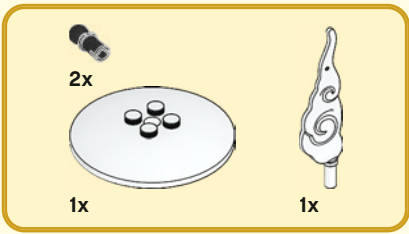

11

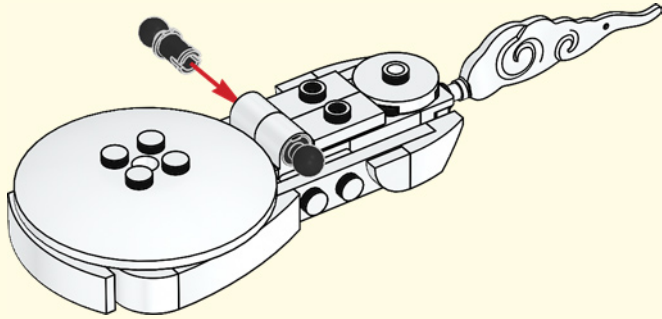

12

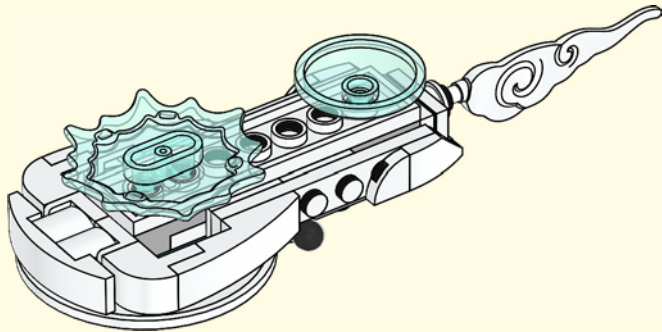

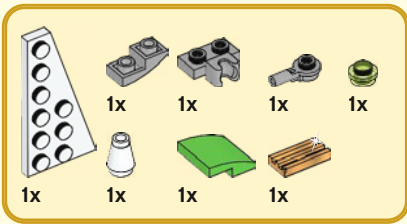

13

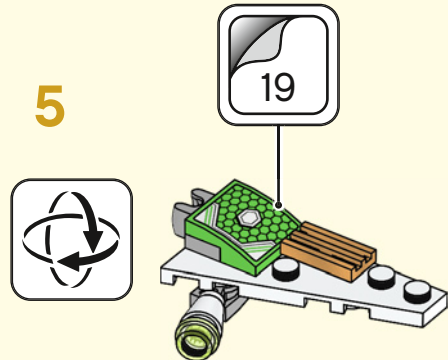
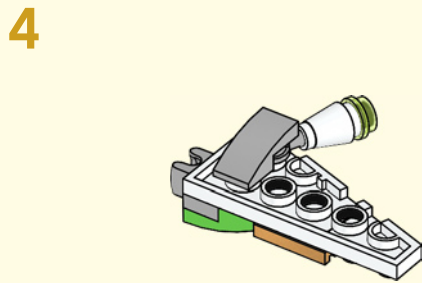
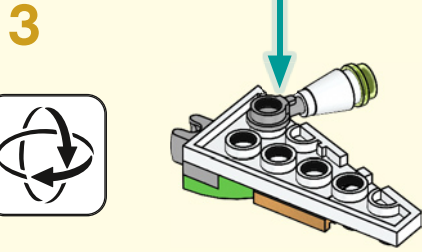
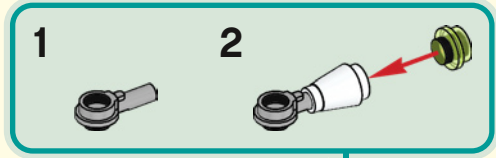
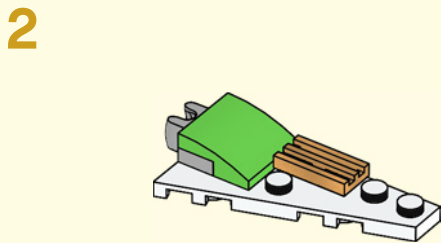
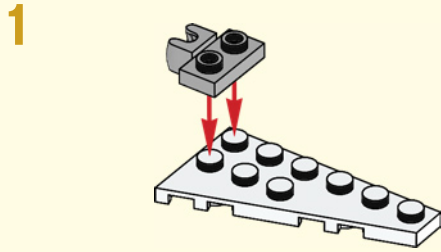

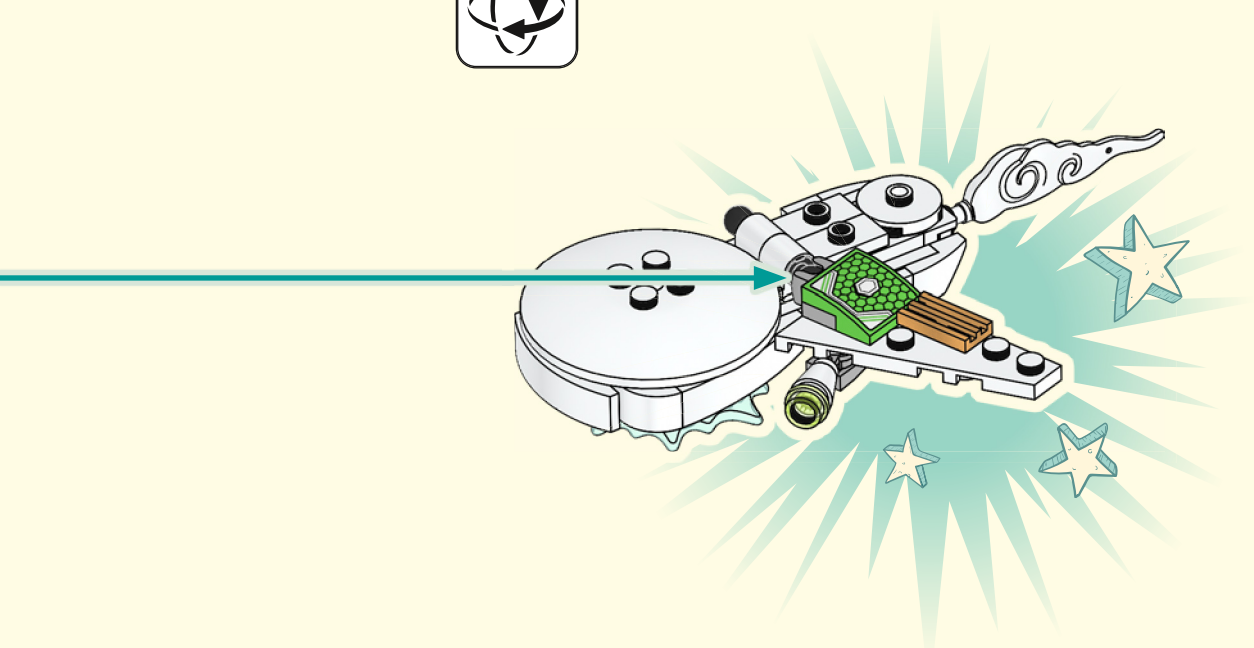

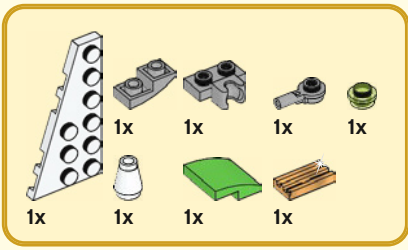

14

1

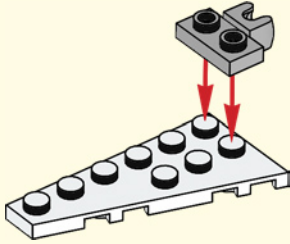

2

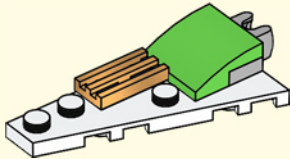

1



2

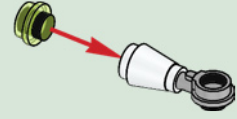

3

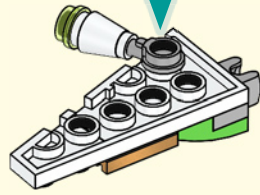

4

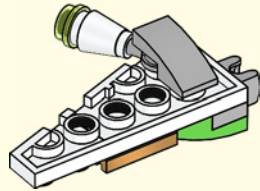

5

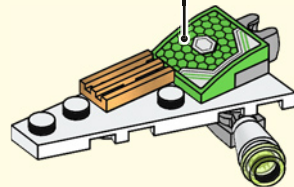
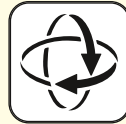

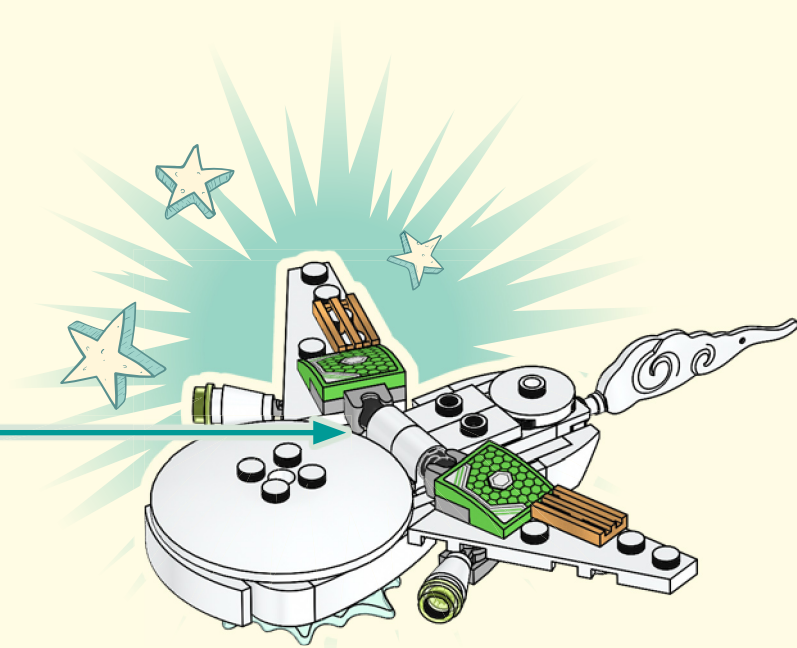

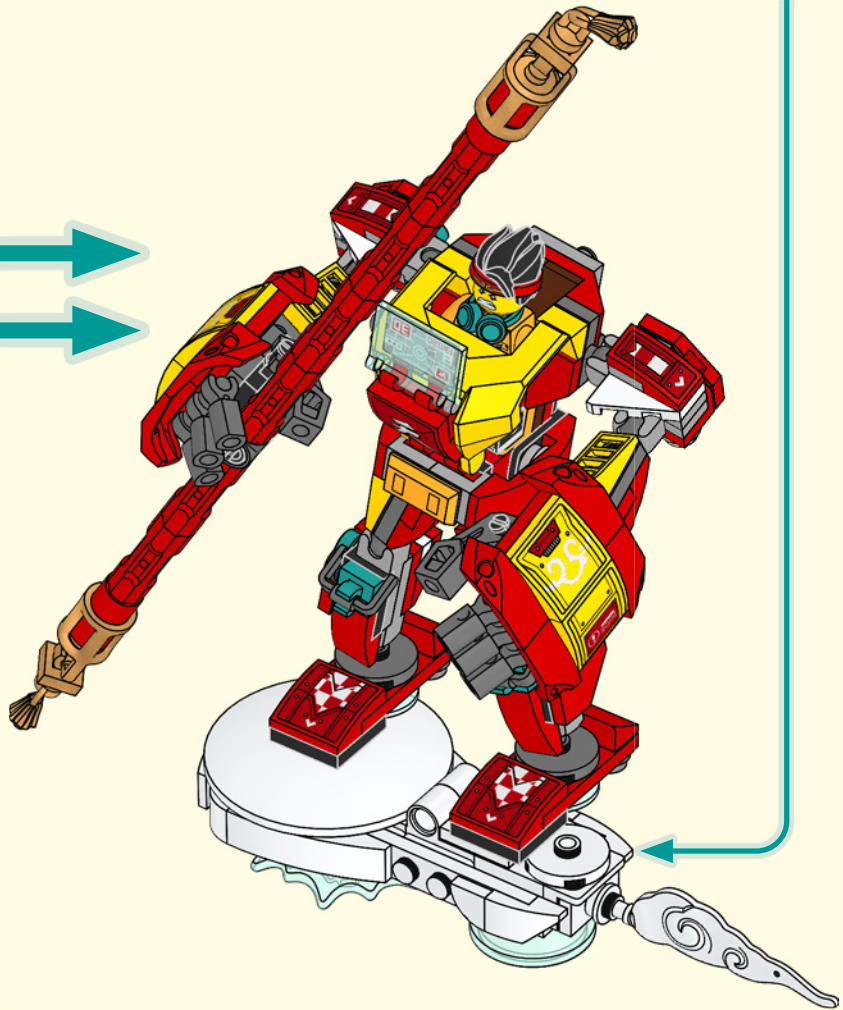
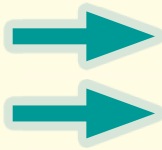
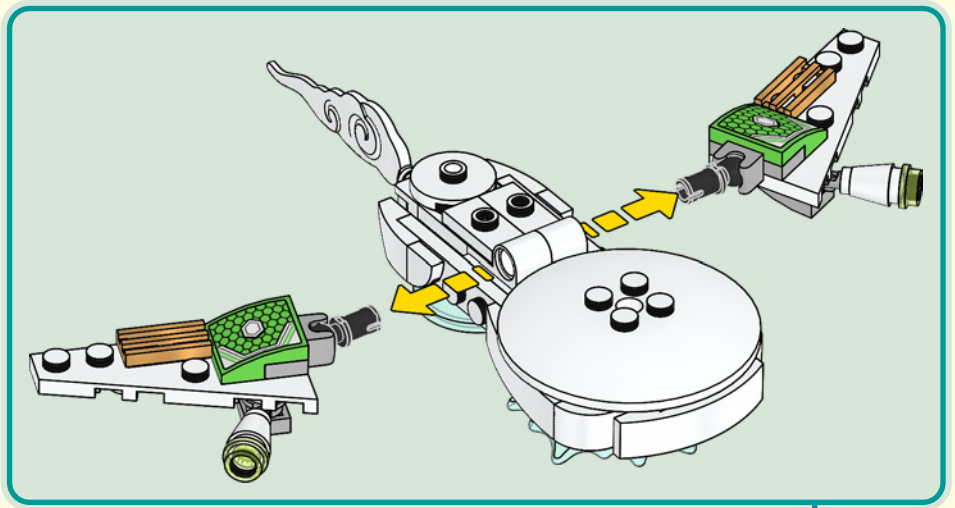

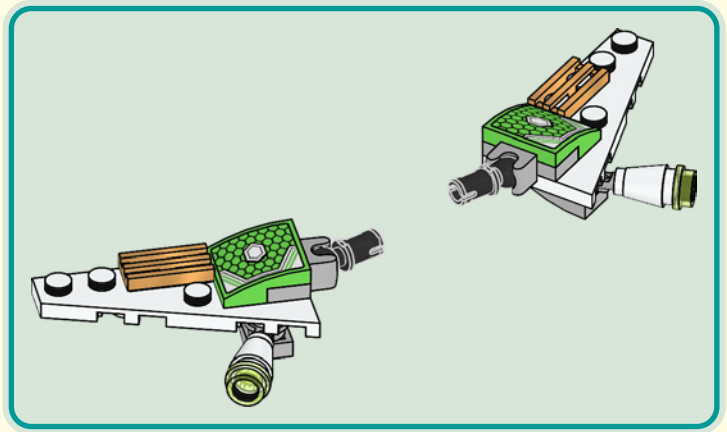
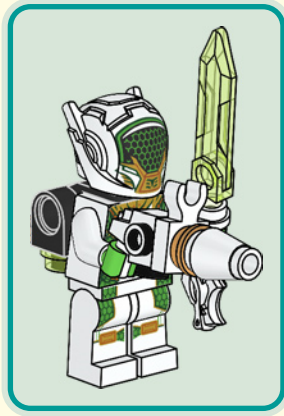

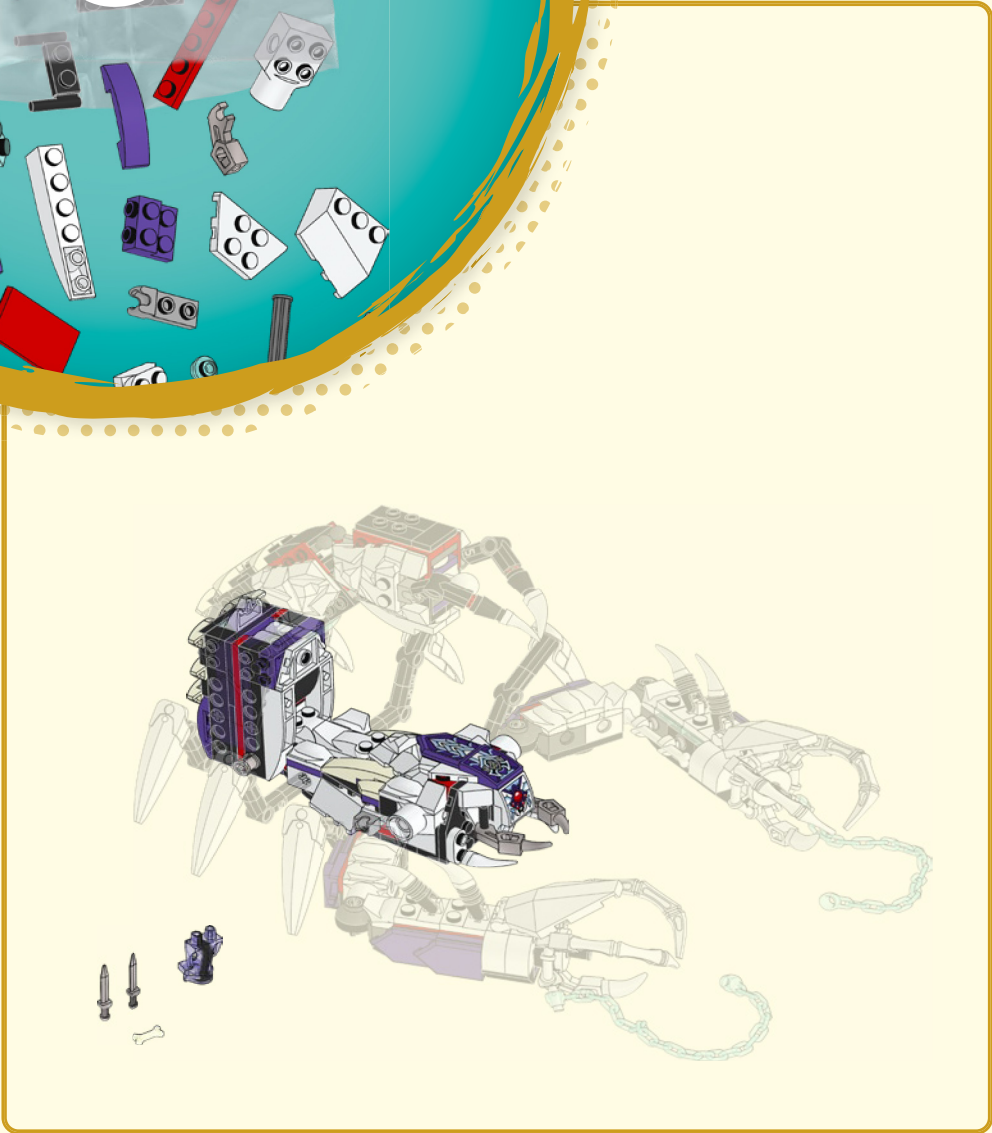

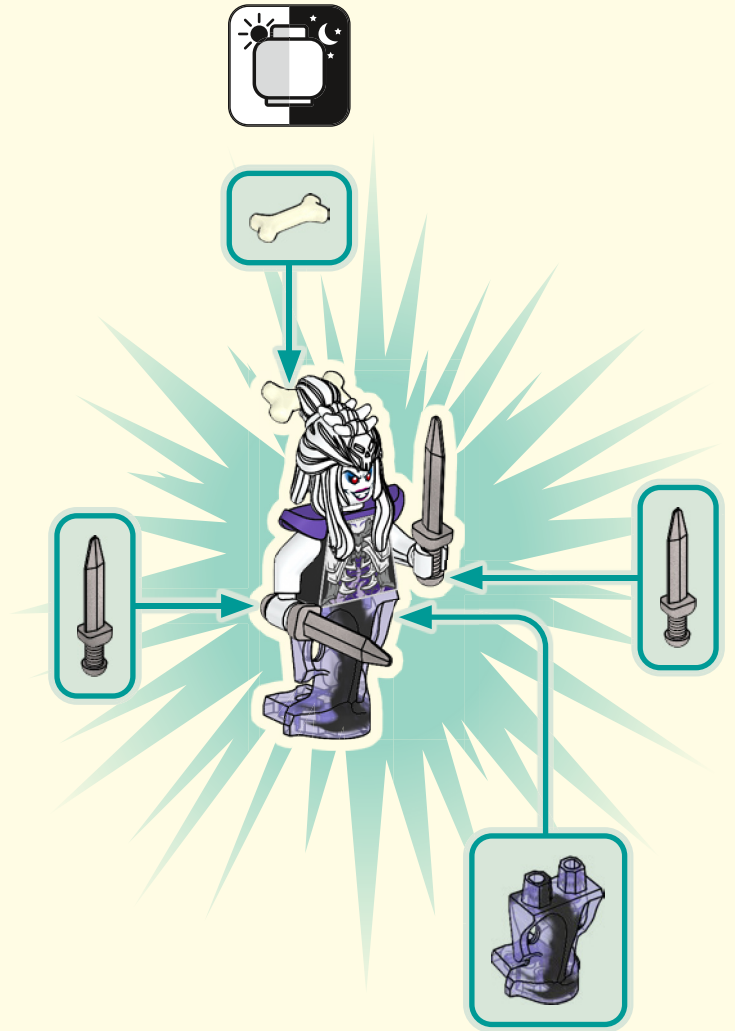
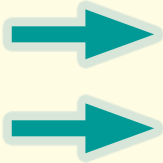

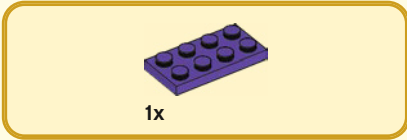
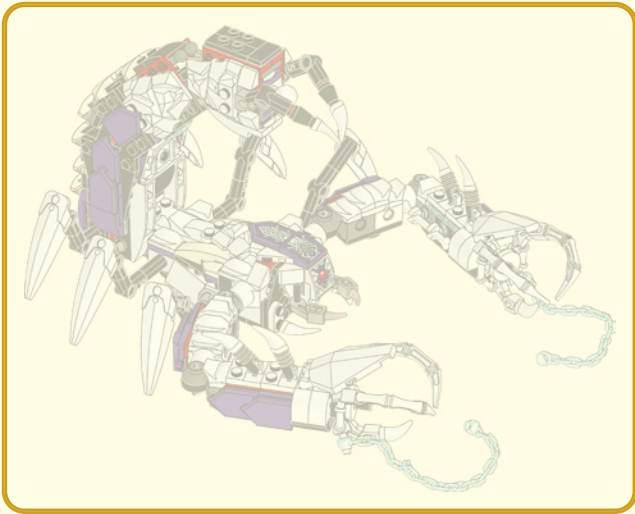

1

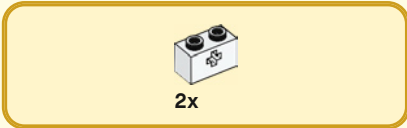
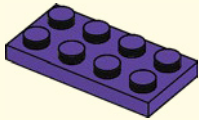

2

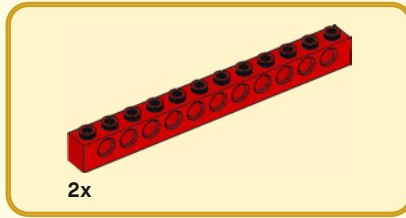
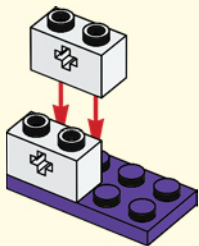

3

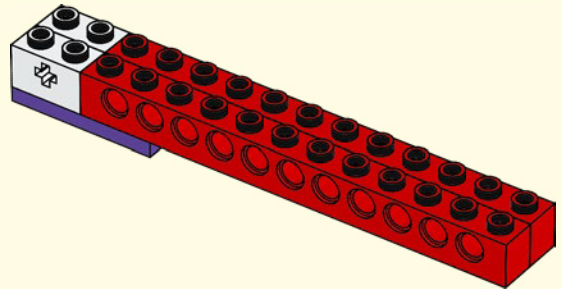



2x

4

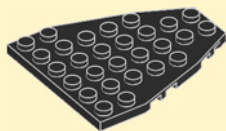
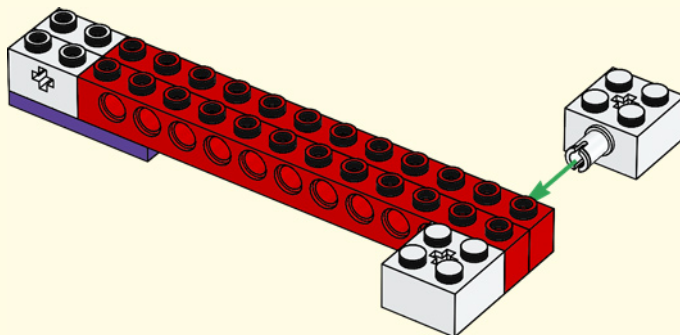

1x



1x

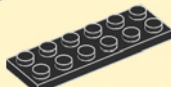

1x

5

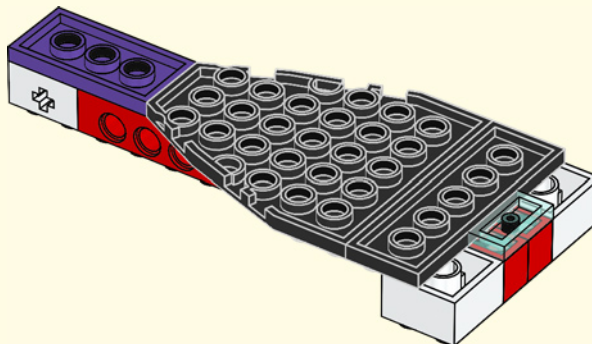



2x

6

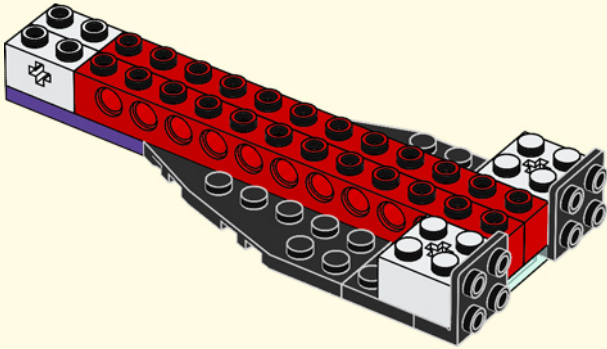

2x

7

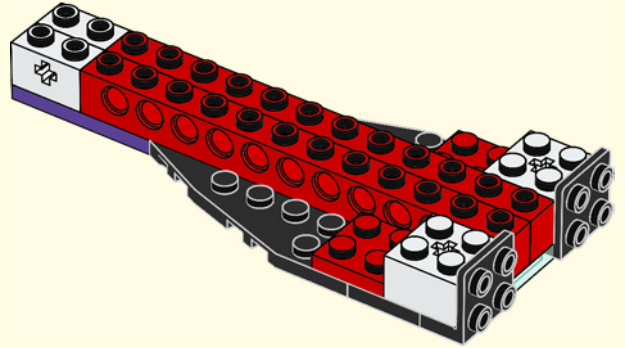

2x



2x

8

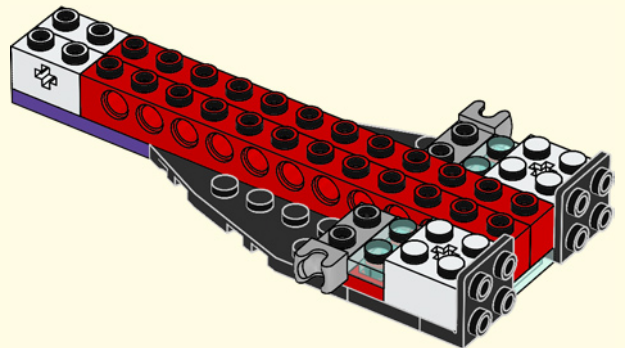



2x

9

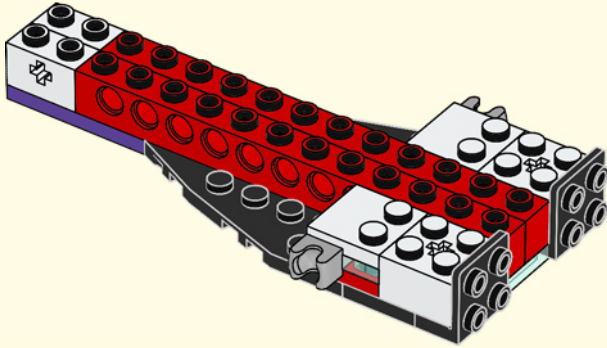

3x



1x



1x



1x

11

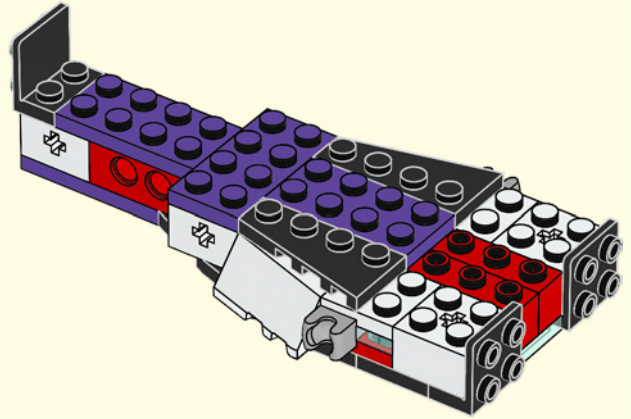

2x



1x

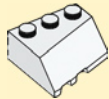

1x

10

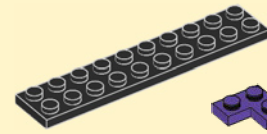
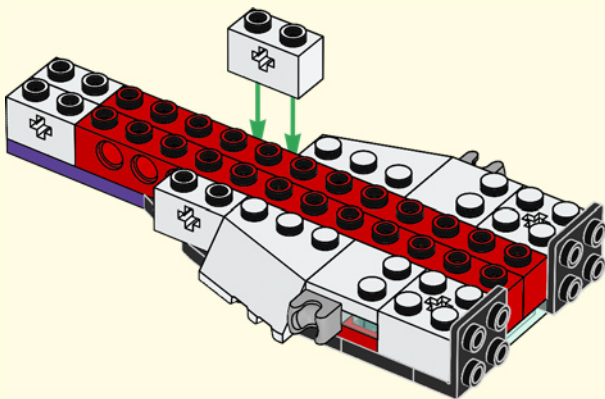

1x



2x



1x

12

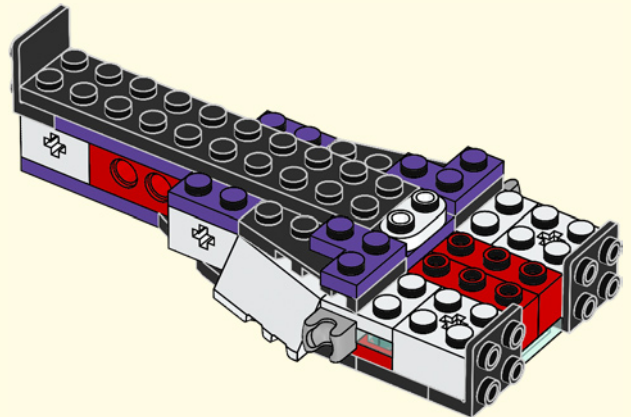



4x

13

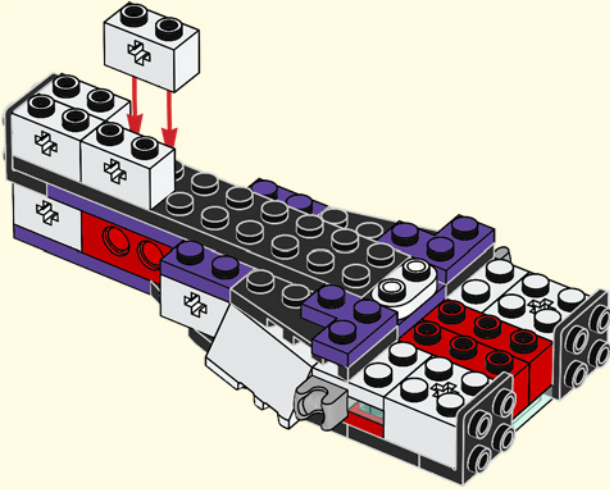

1x



1x



2x

15

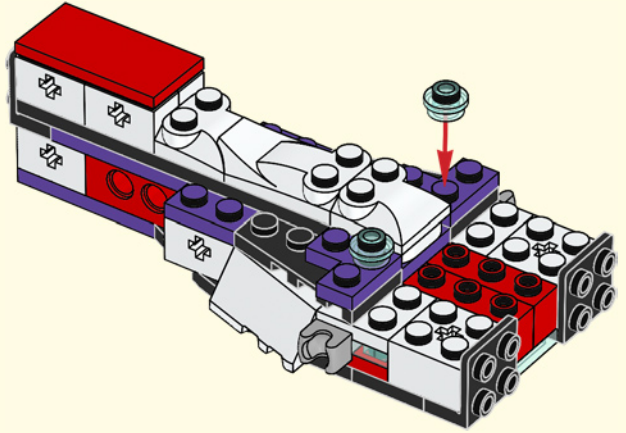

1x



1x

14

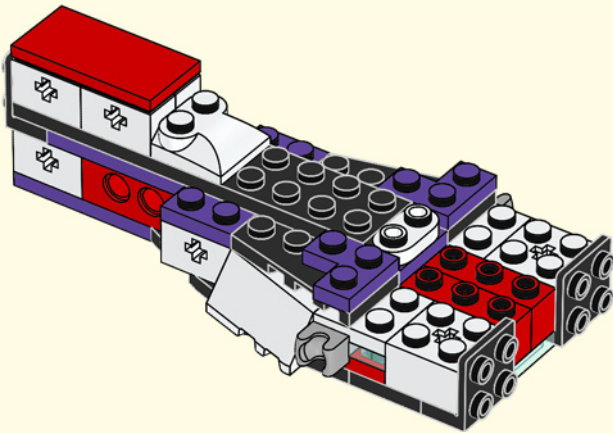

1x



1x



2x

16

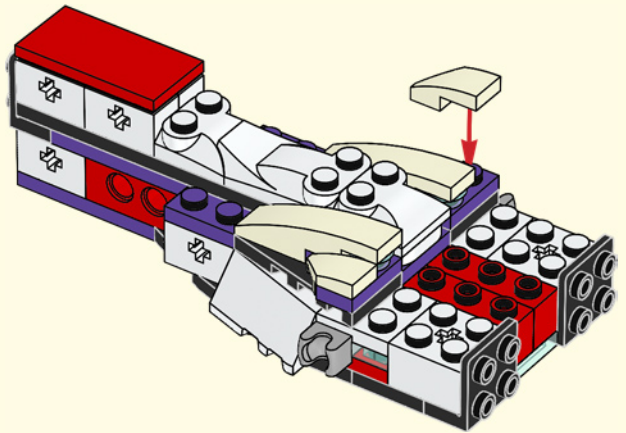

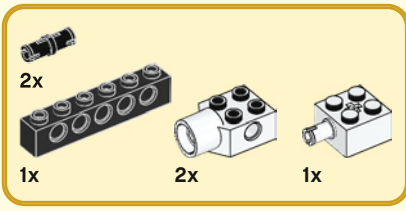

17

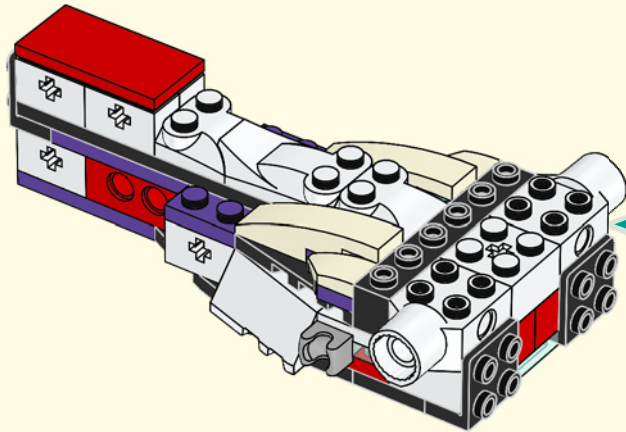
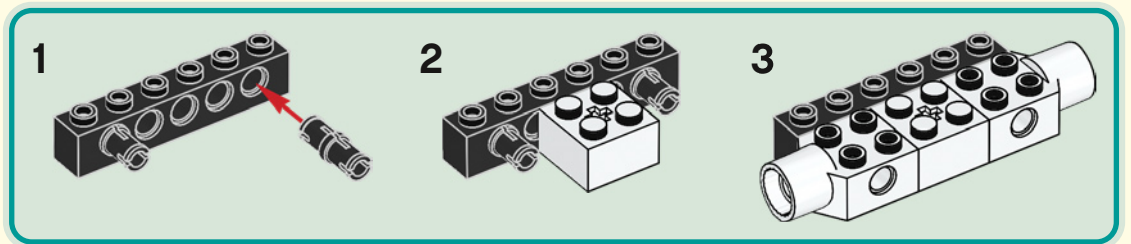

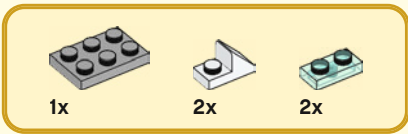

18

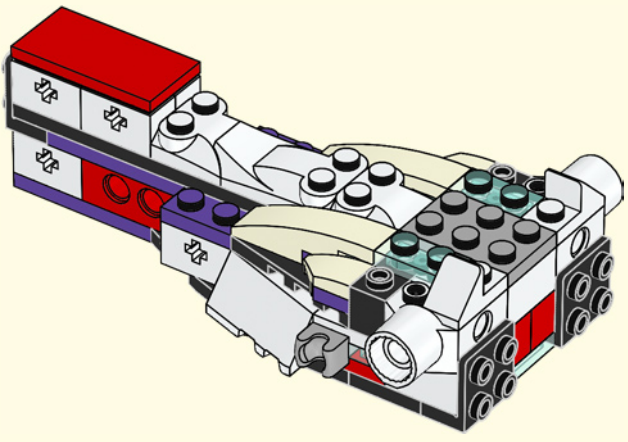

20

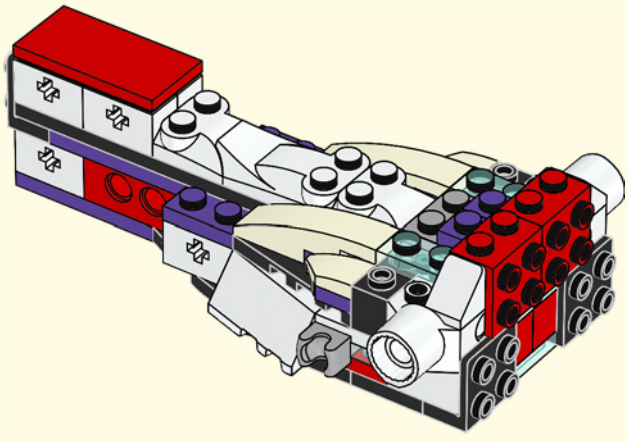

19

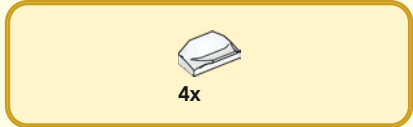
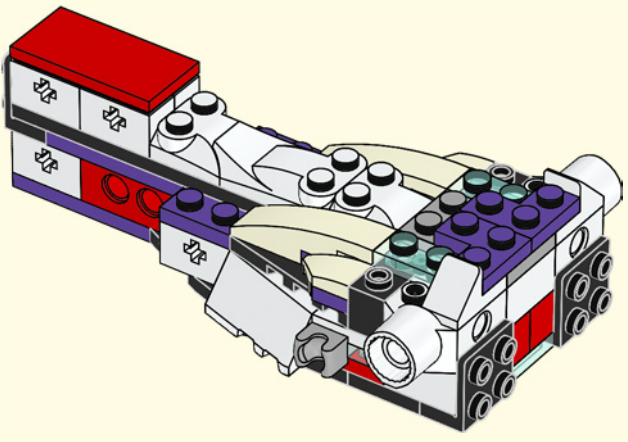

21

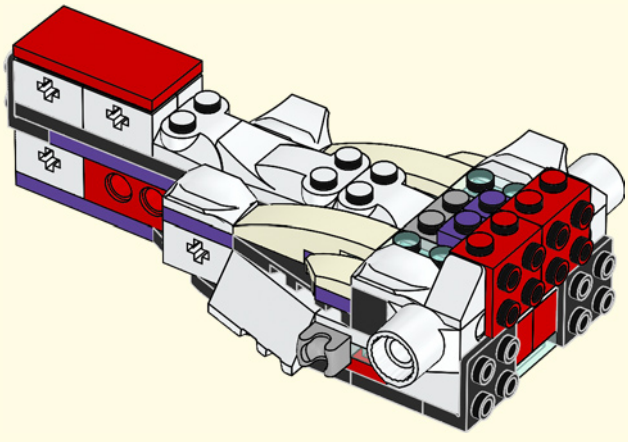

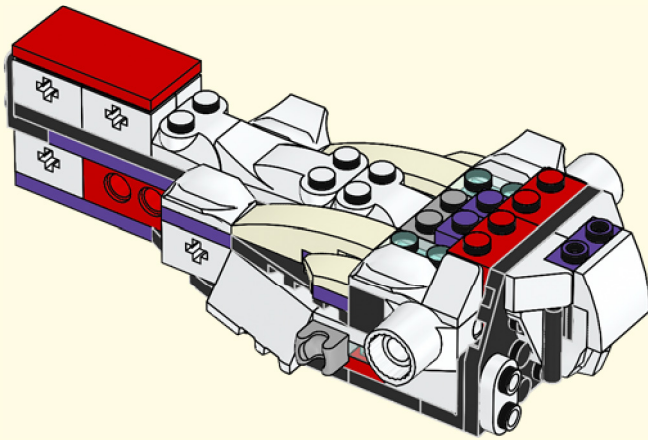

1x

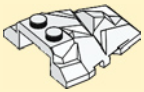

1x

23

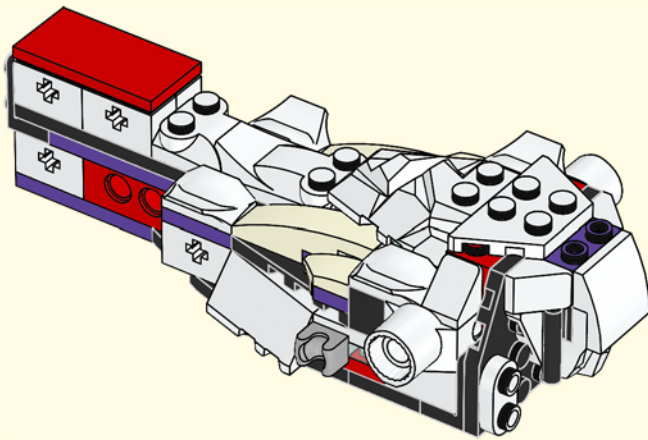

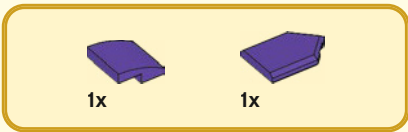

24

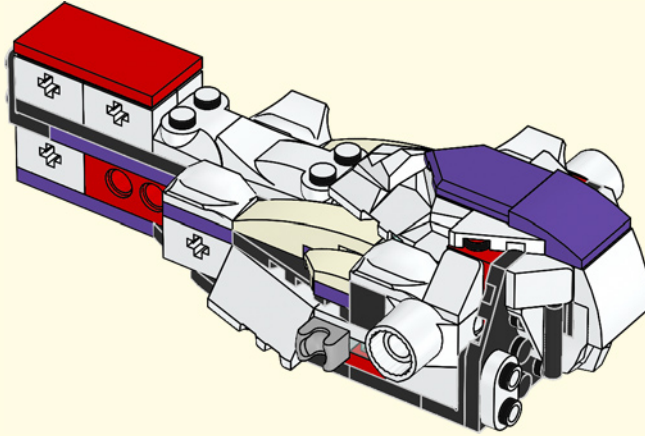

25

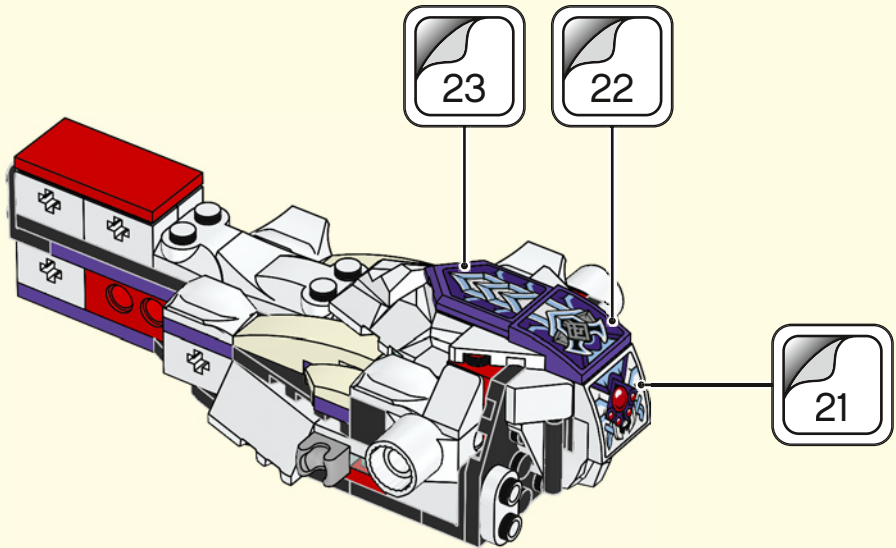



2x

26

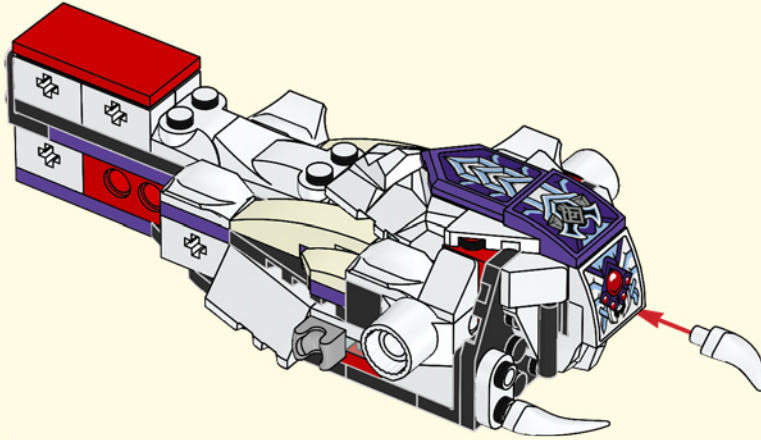

2x



2x

27

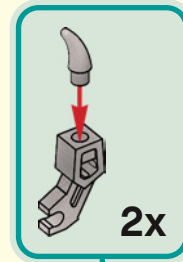

2x

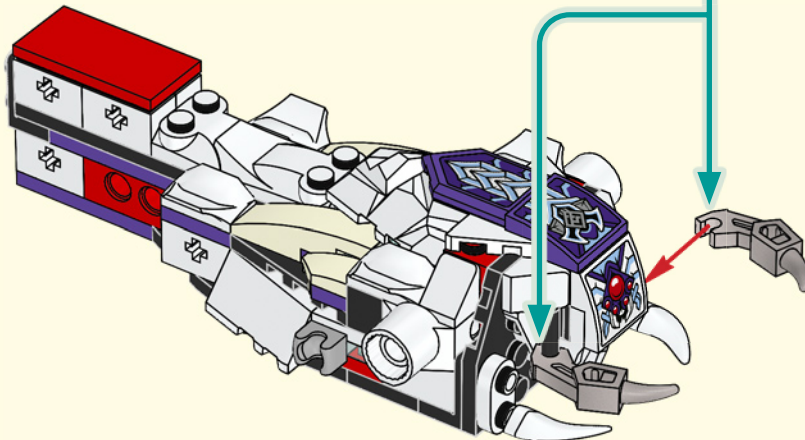

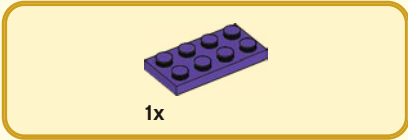

28

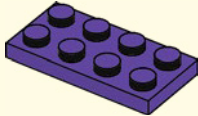

29

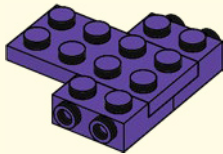

30

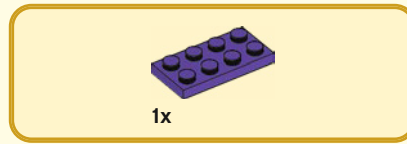
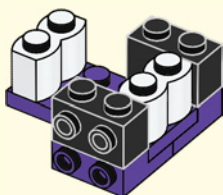

31

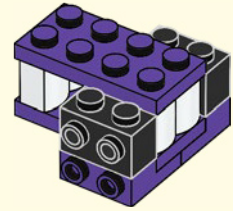

32

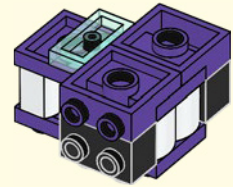
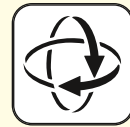

33

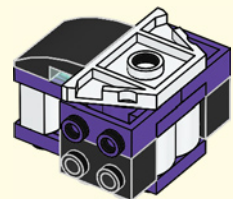

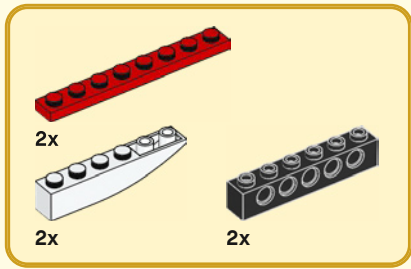

34

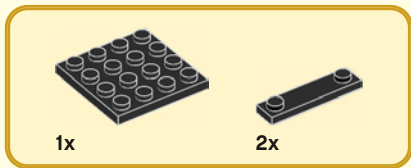
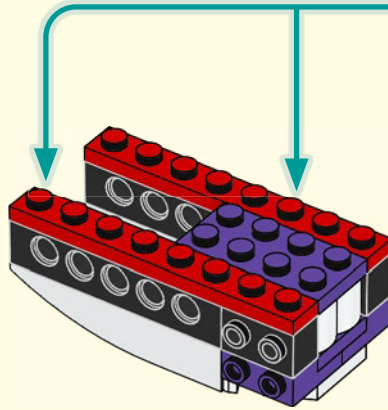
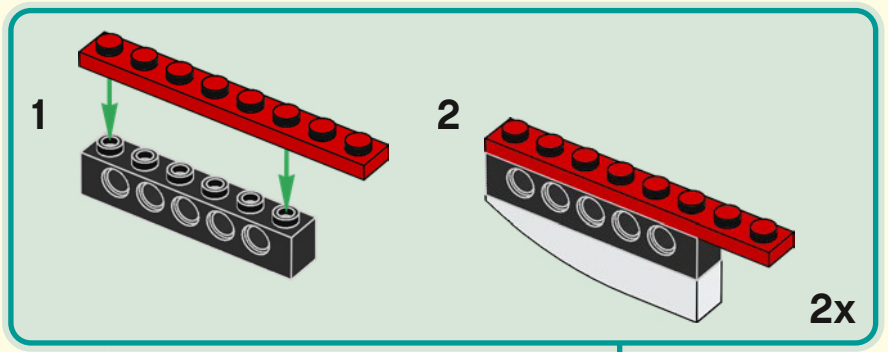

35

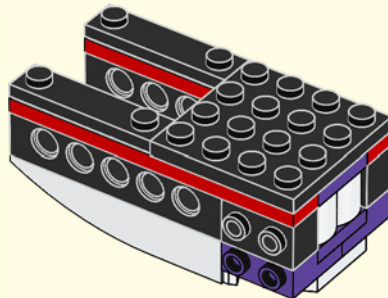

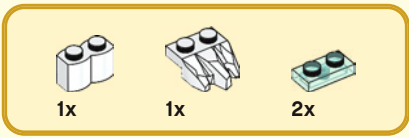

36

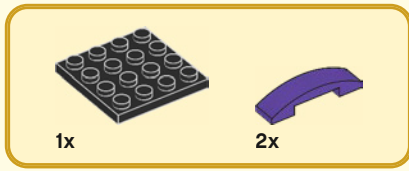
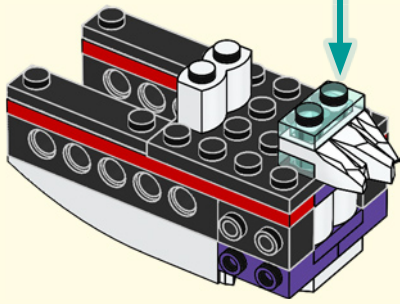
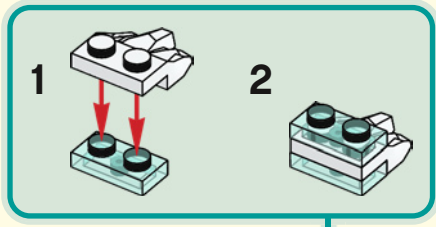

38

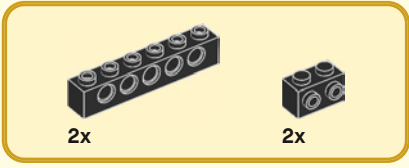
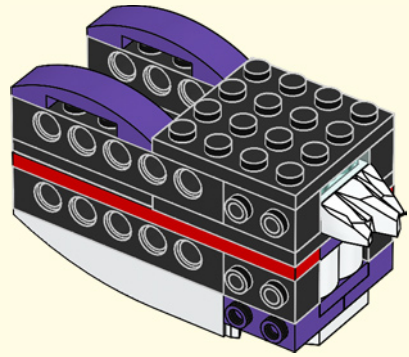

37

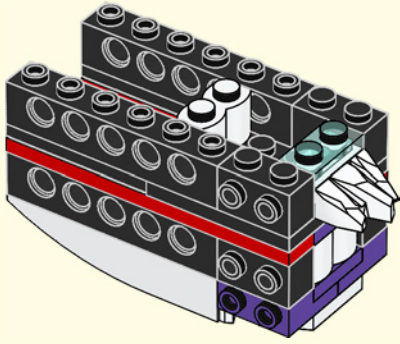

39

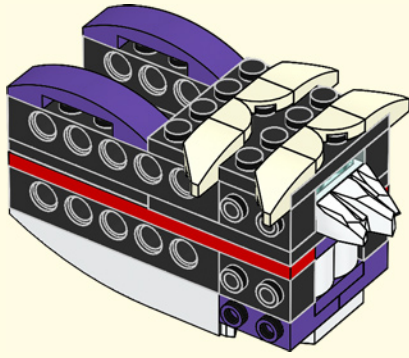

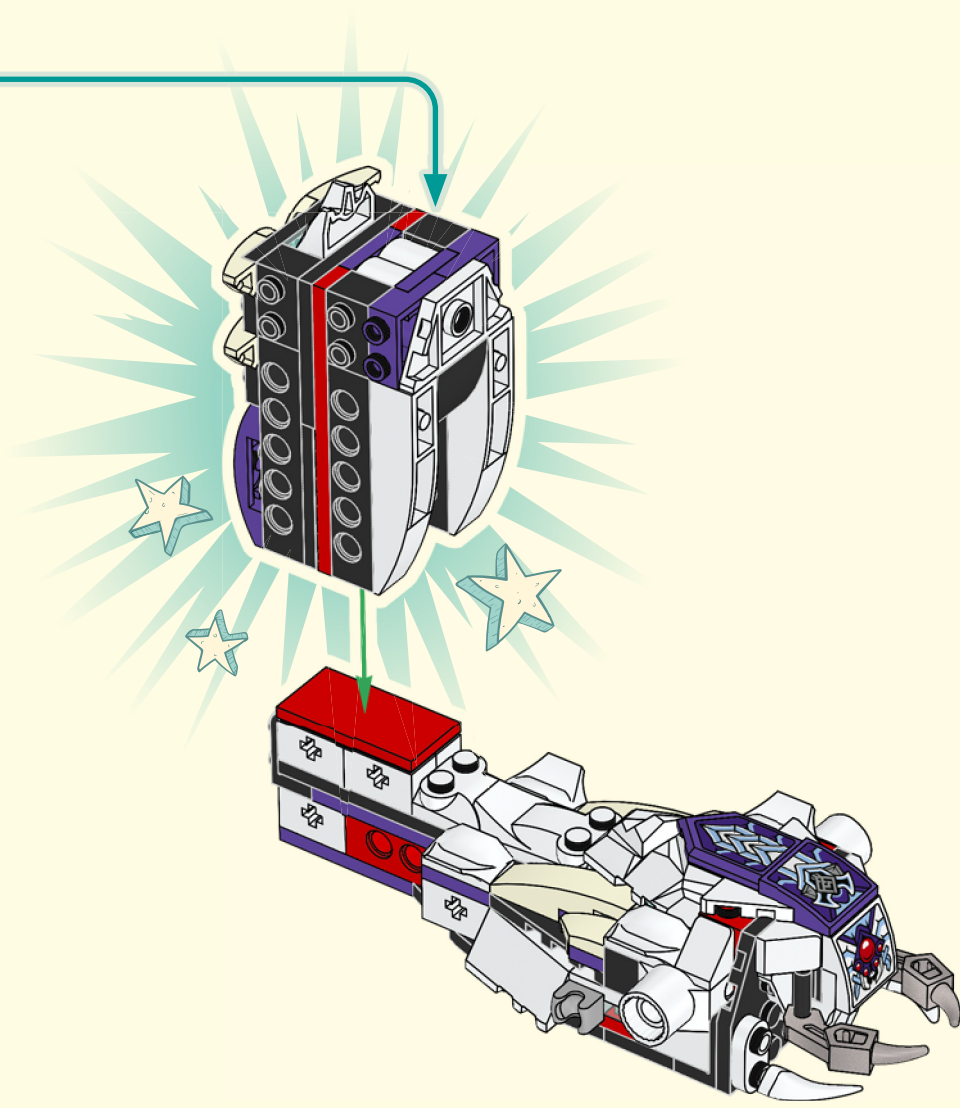



2x

41

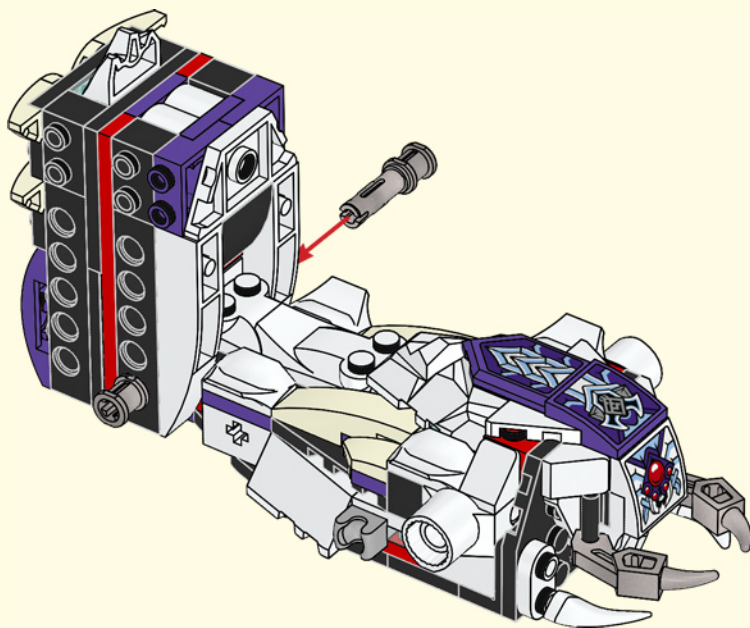

2x

42

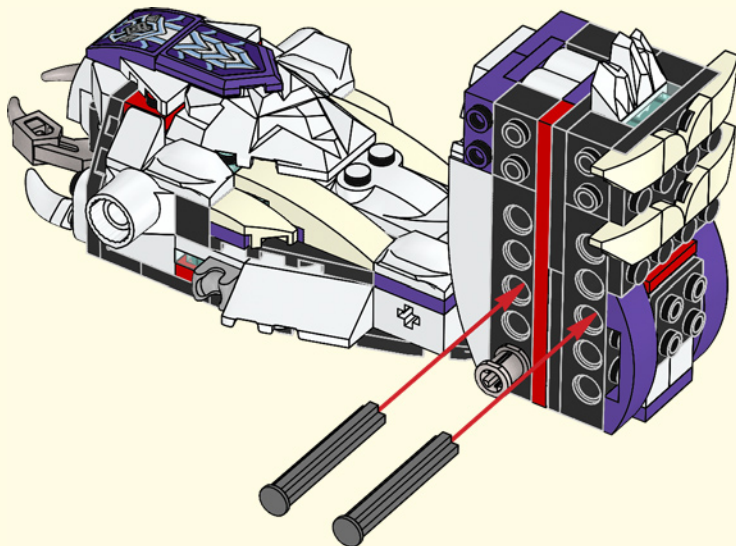
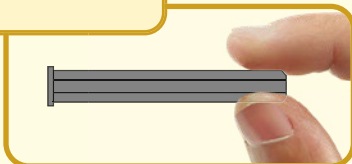

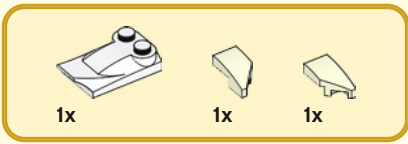

43

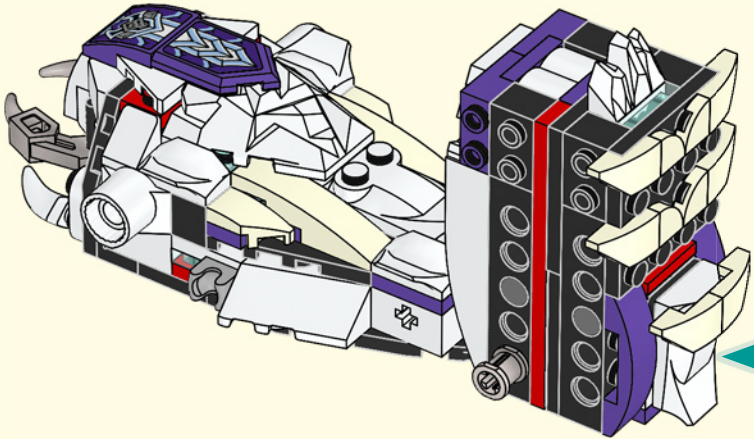
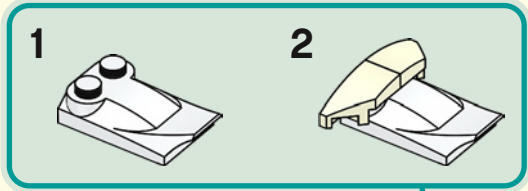

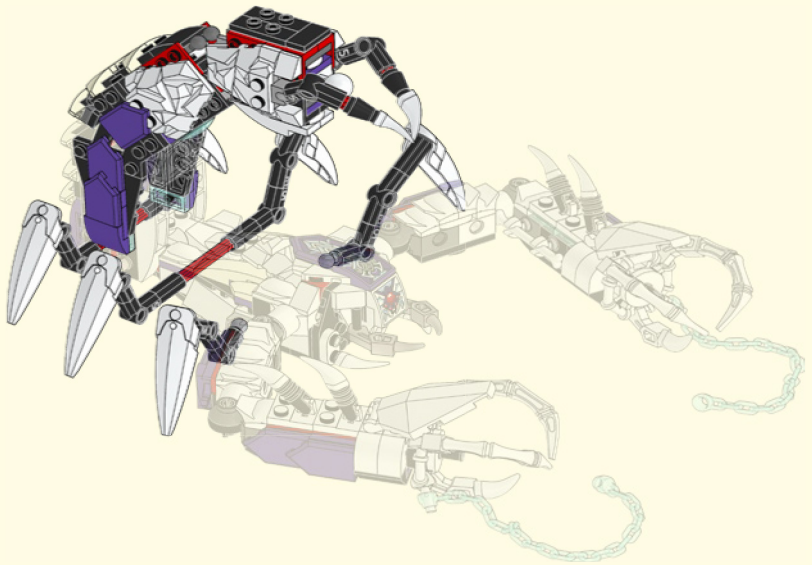

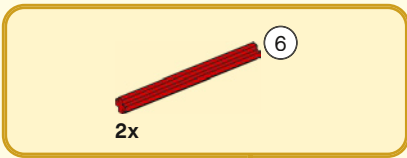

44

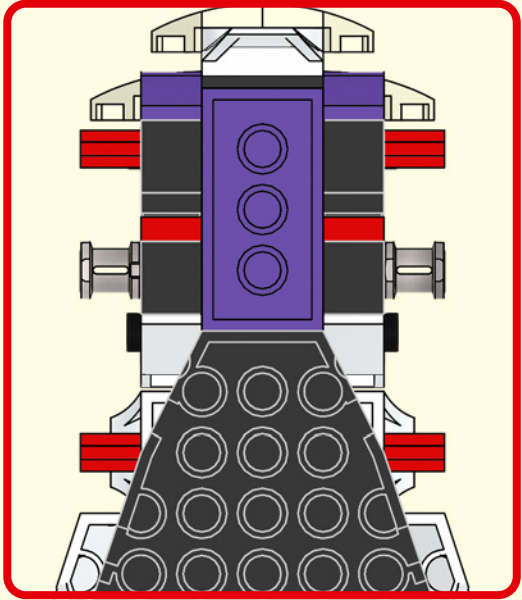
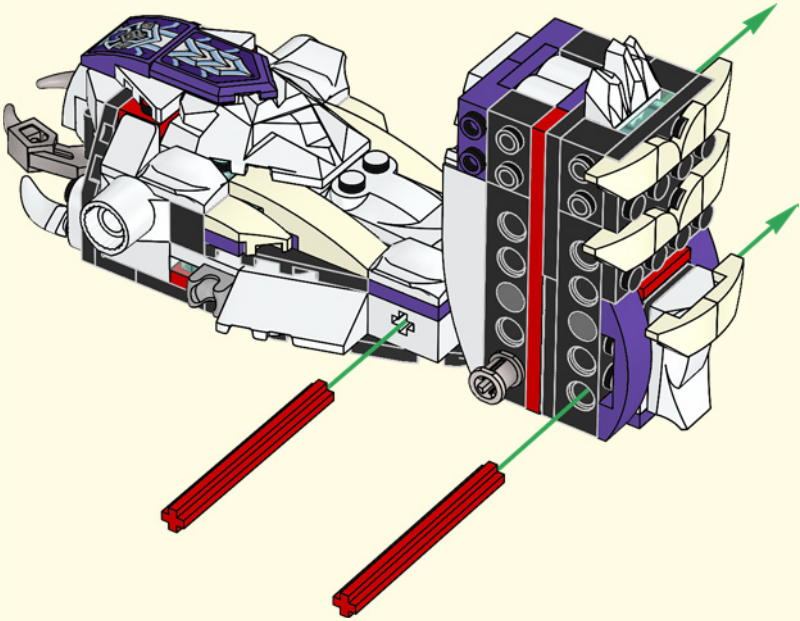
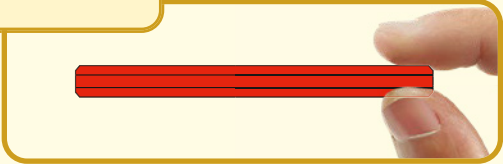

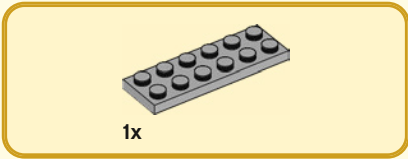
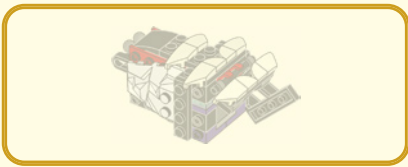

1x

45

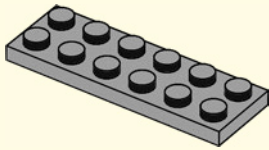

4x

2x

46

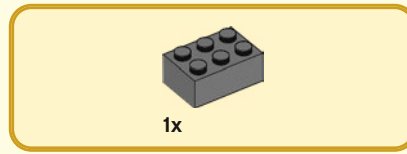
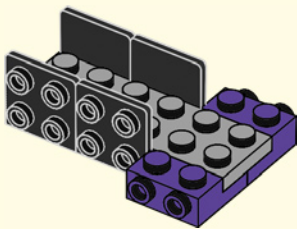

1x

47

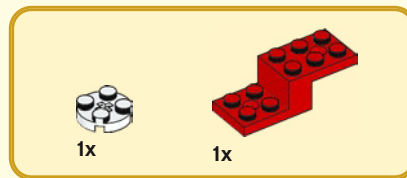
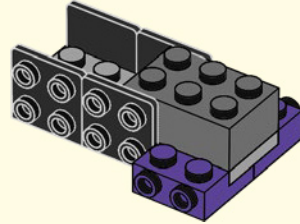

1x

1x

48

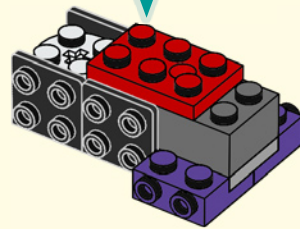
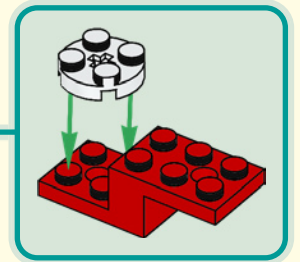



2x

49

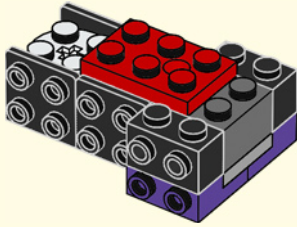

1x



2x

51

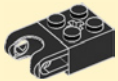
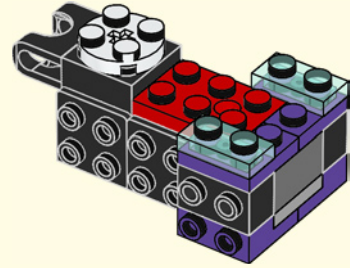

1x



2x

50

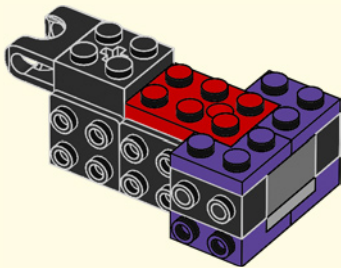

2x



1x



1x

52

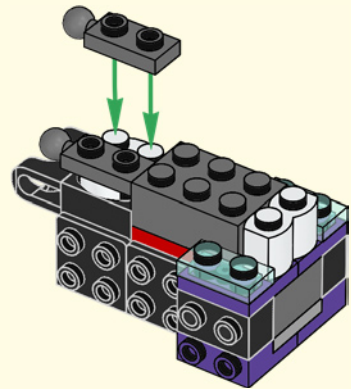



53

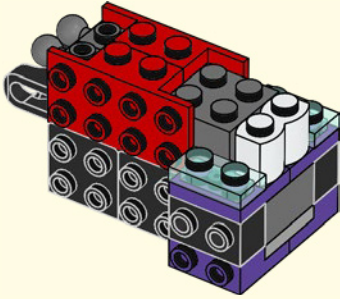

55

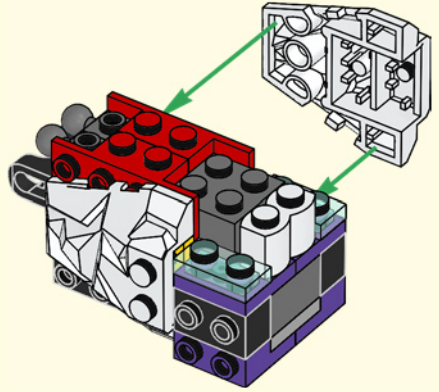

54

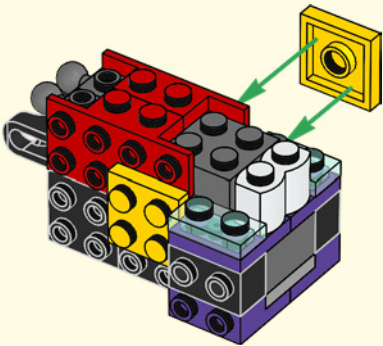

56

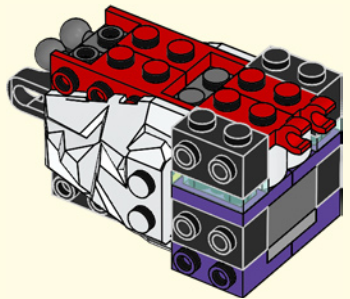



2x

57

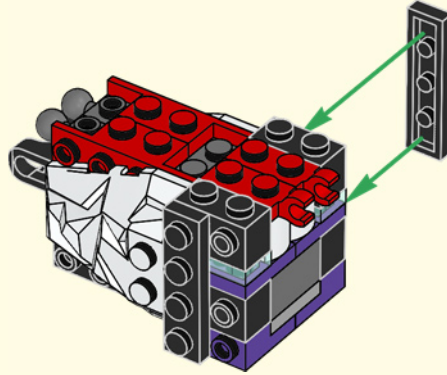

1x



1x



1x

58

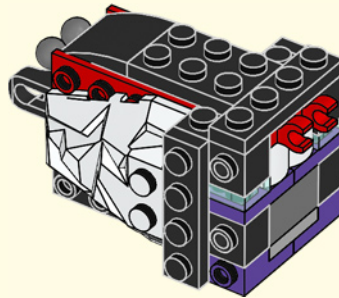

2x



2x



2x

59

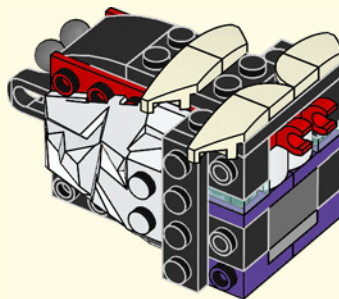

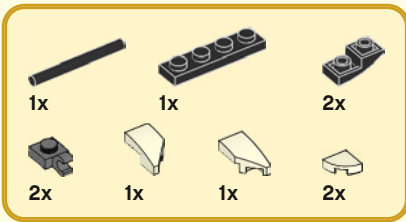

60

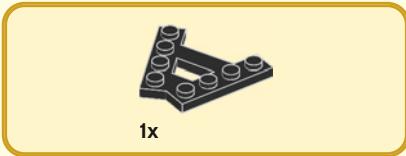
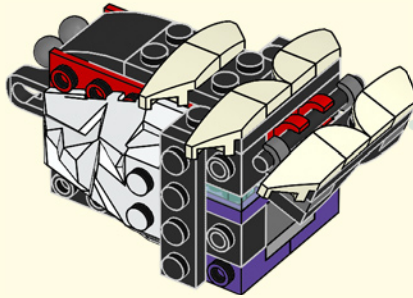
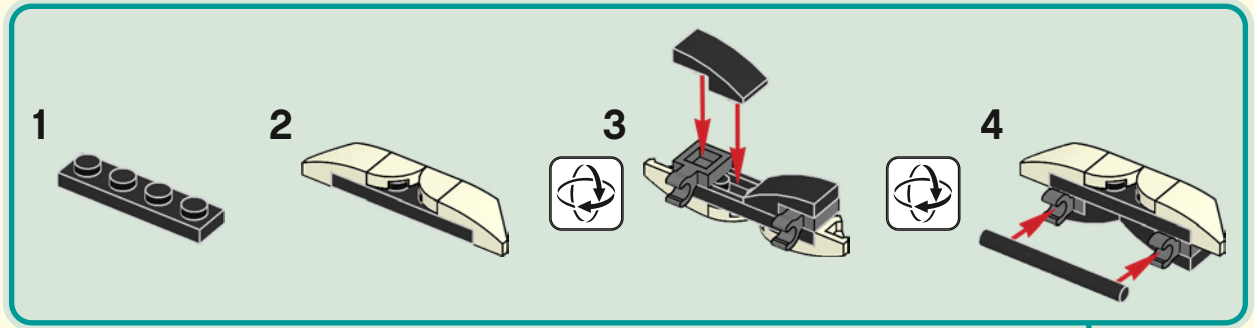

61

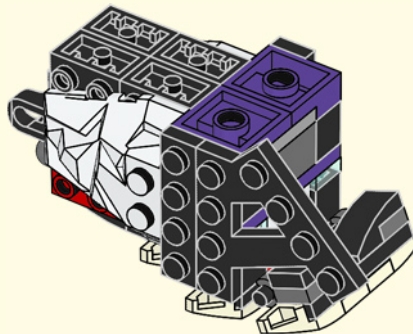



1x

62

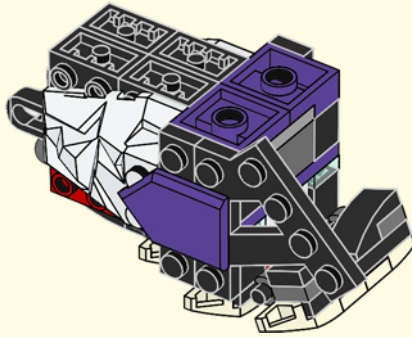

1x

63

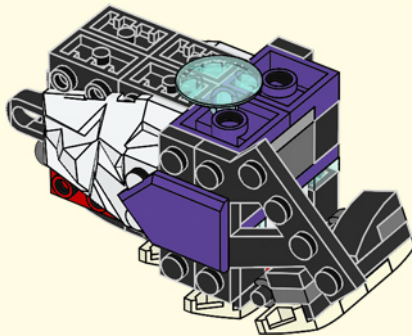

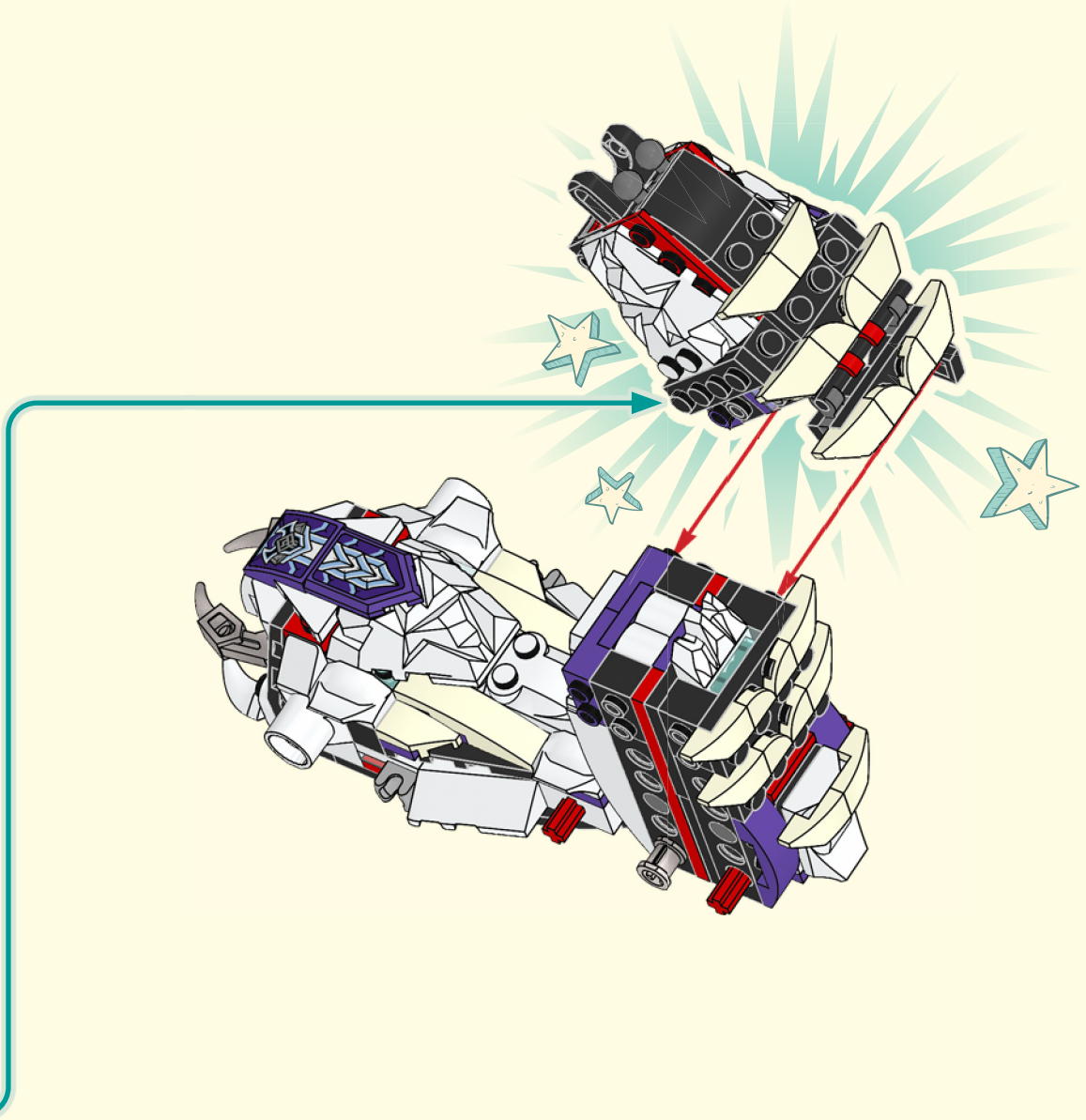

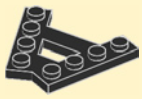

1x

65

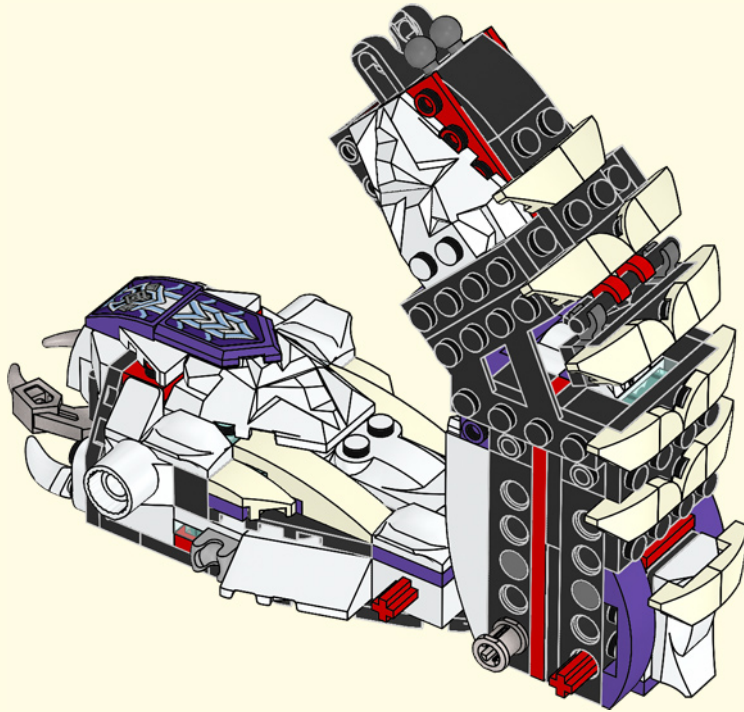



1x

66

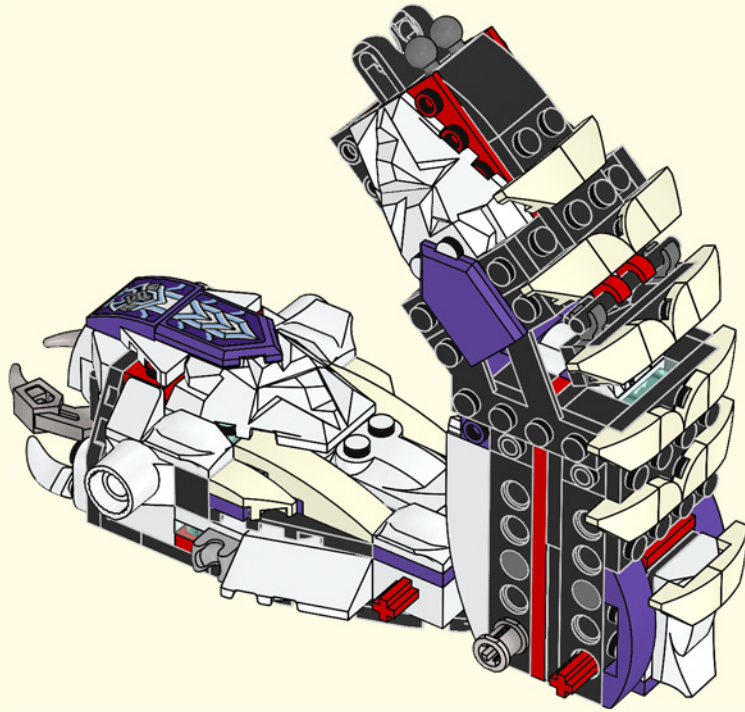

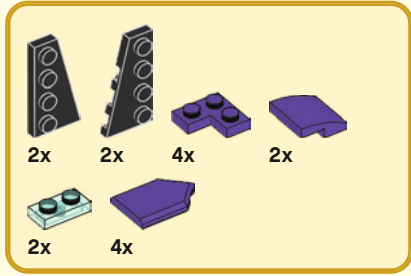

67

1

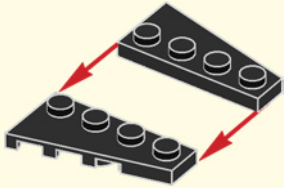

2

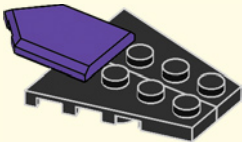

3

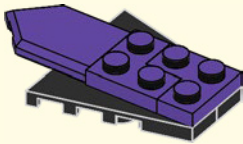

4

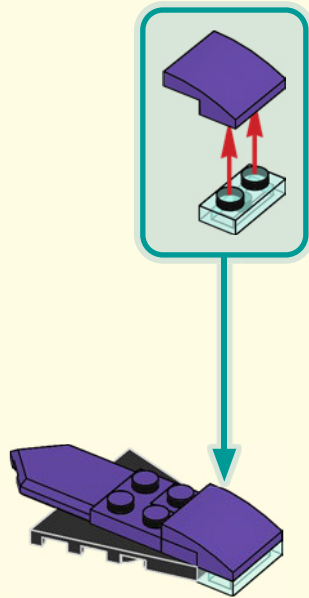

5

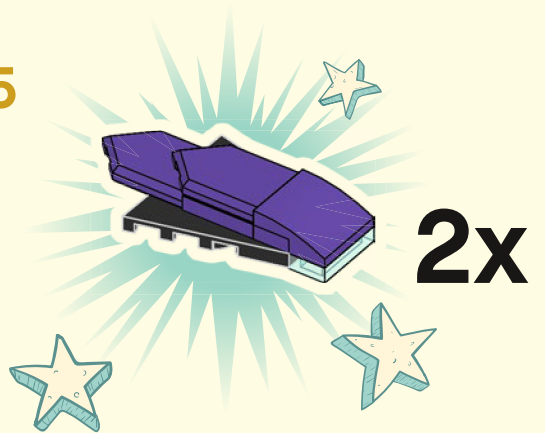

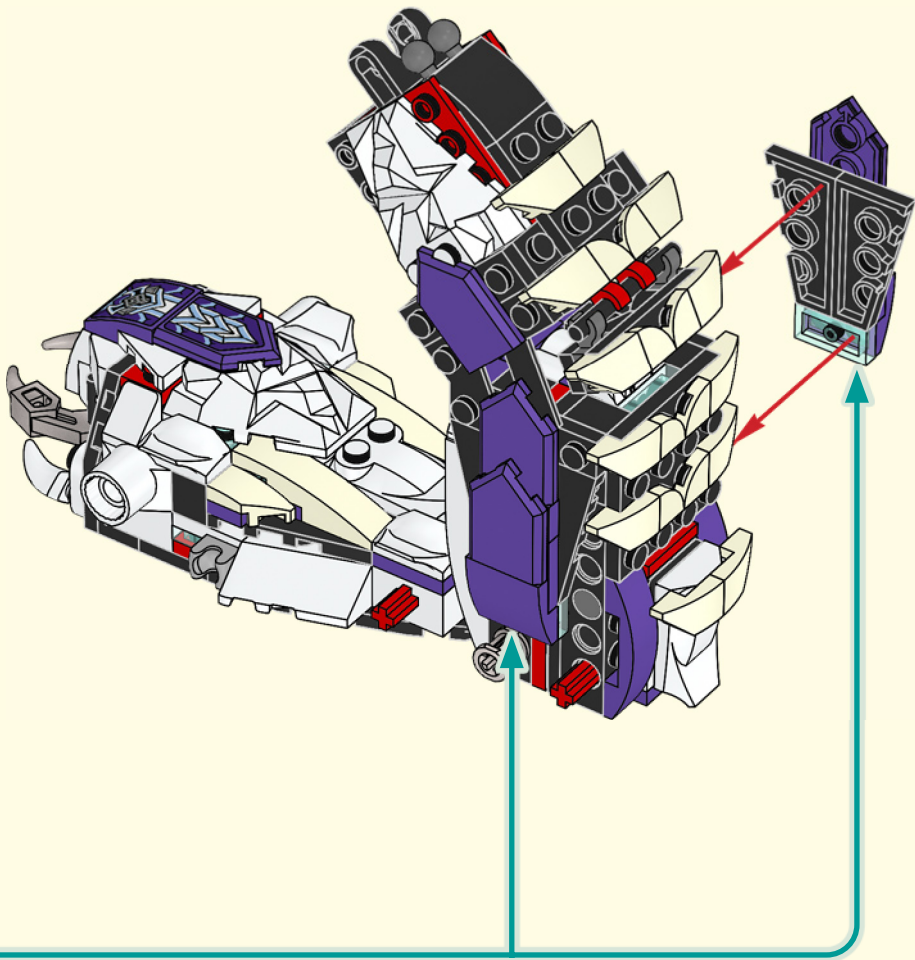



1x

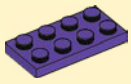

1x

68

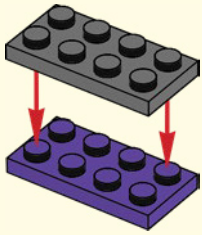

4x

69

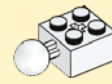
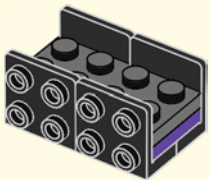

2x

70

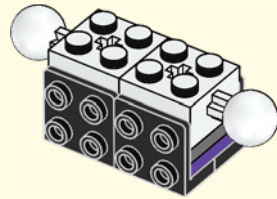

1x

71

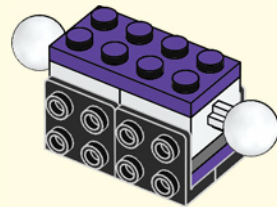



1x



2x

72

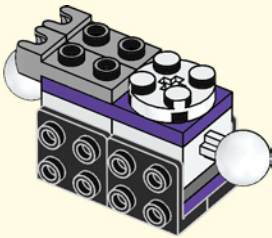

4x

74

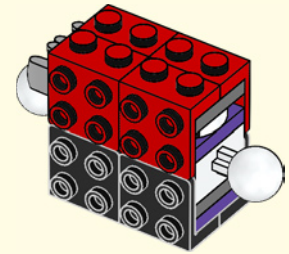

1x

73

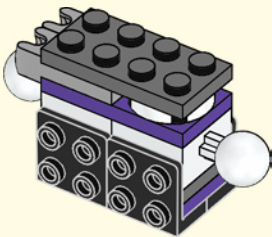

4x

75

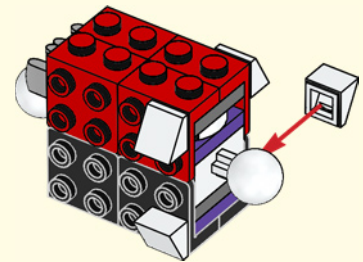



76

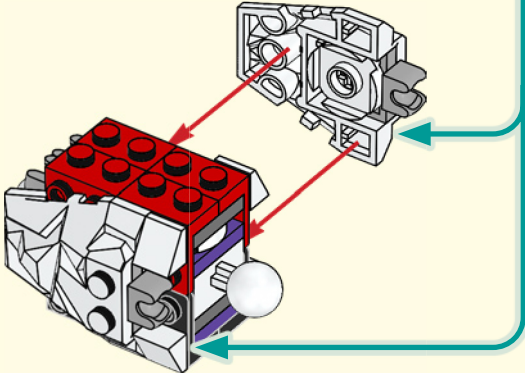
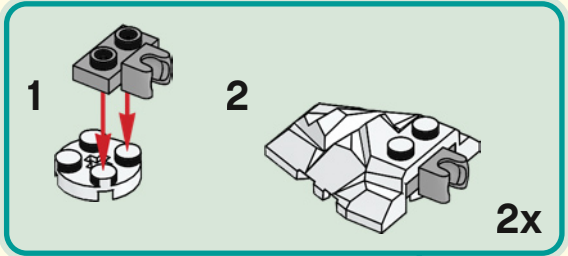

77

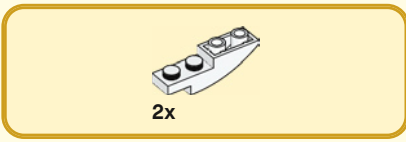
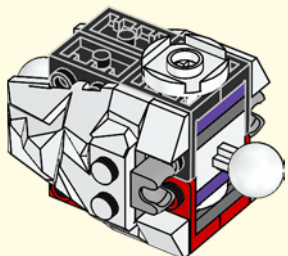

78

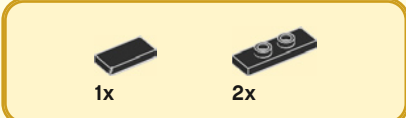
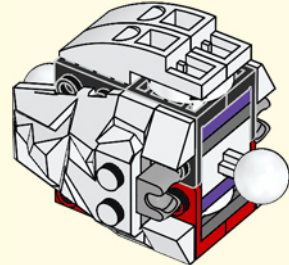

79

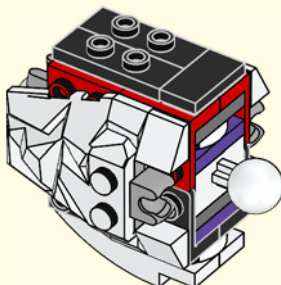

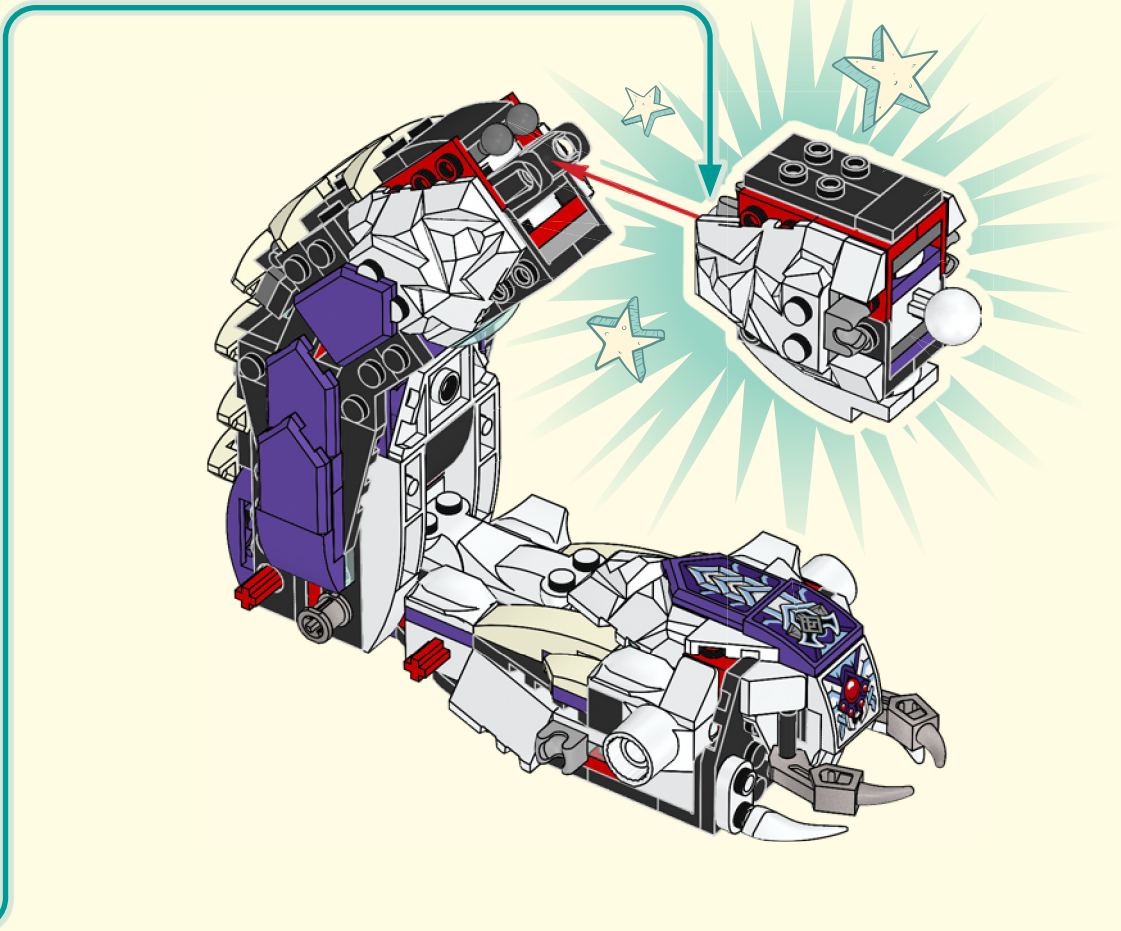

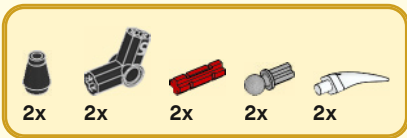

81

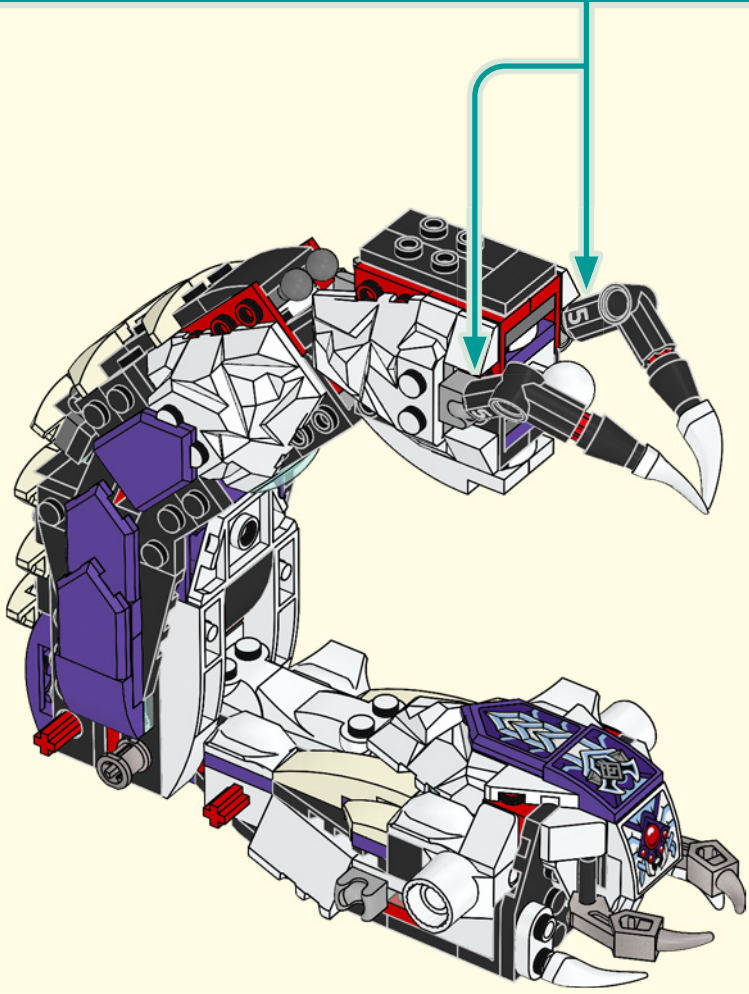
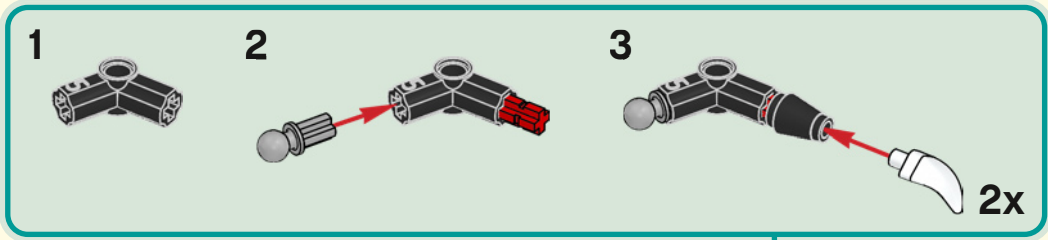



82

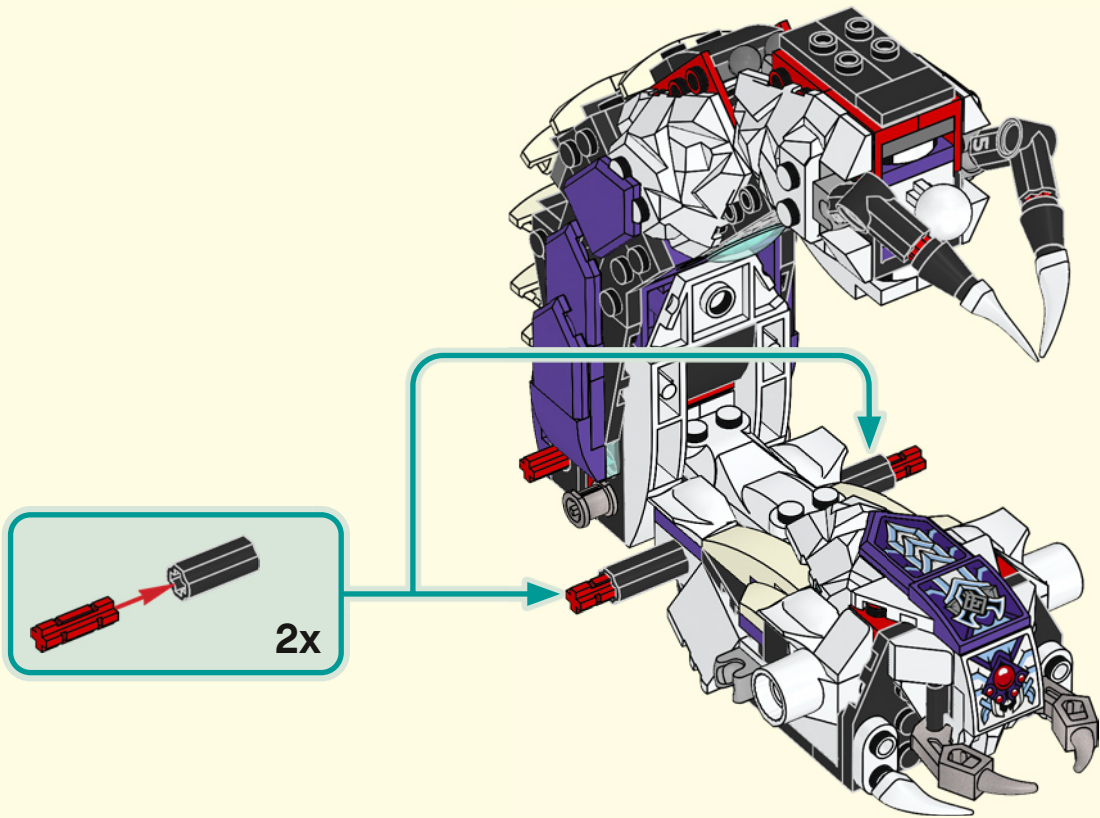



83

1

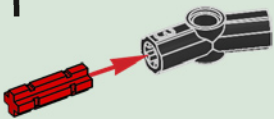

2



1:1

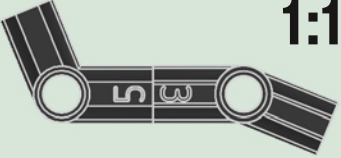

4x

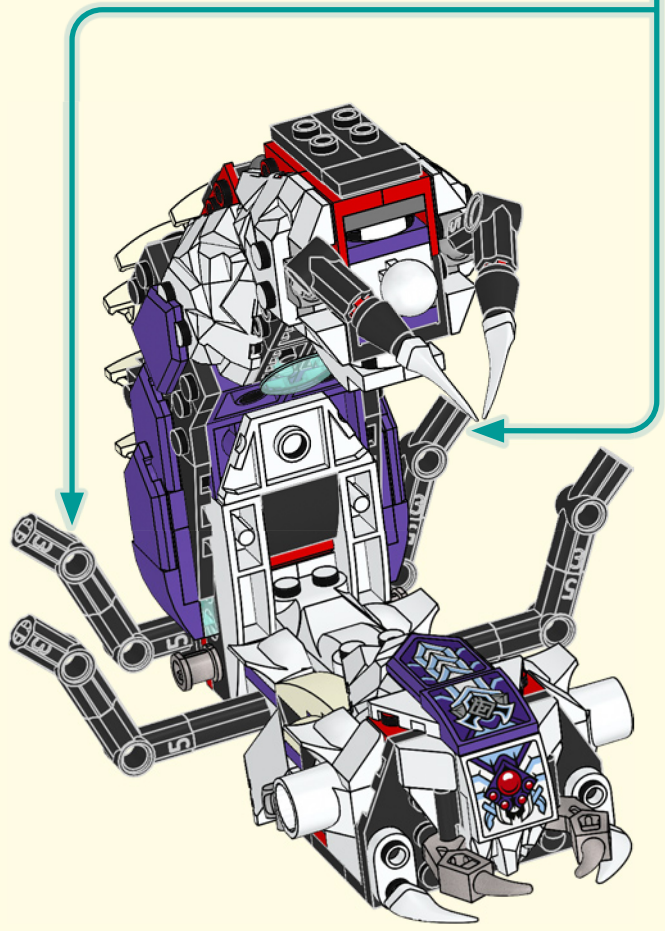



84

1

2

3

1:1

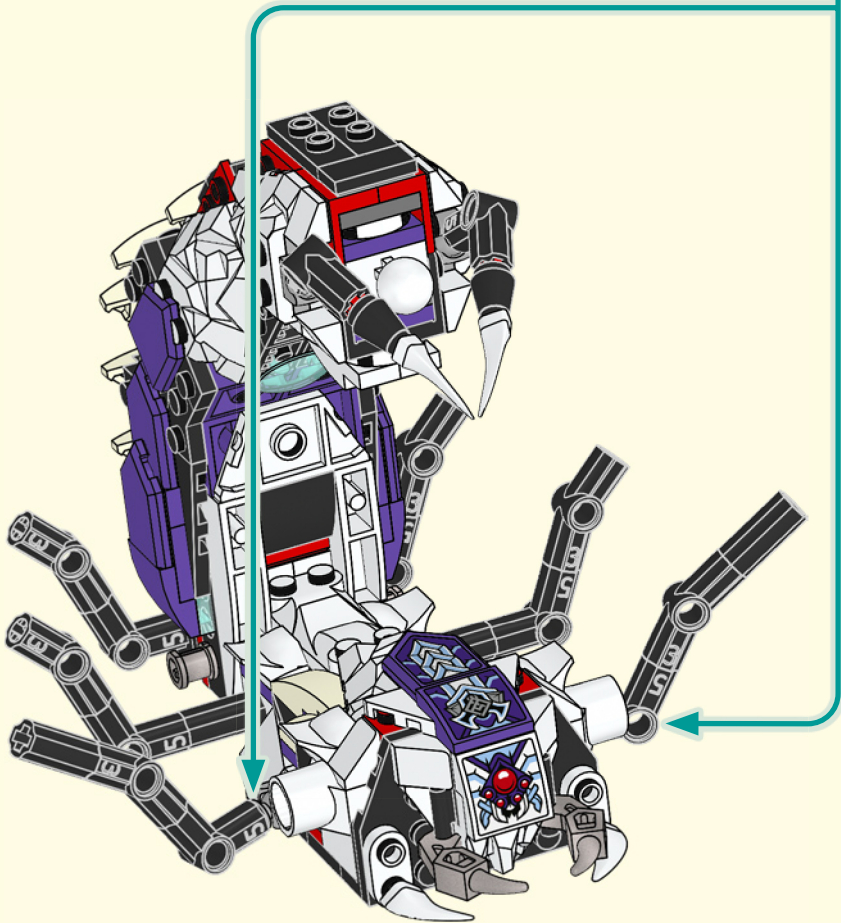

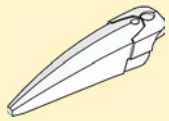

6x

85

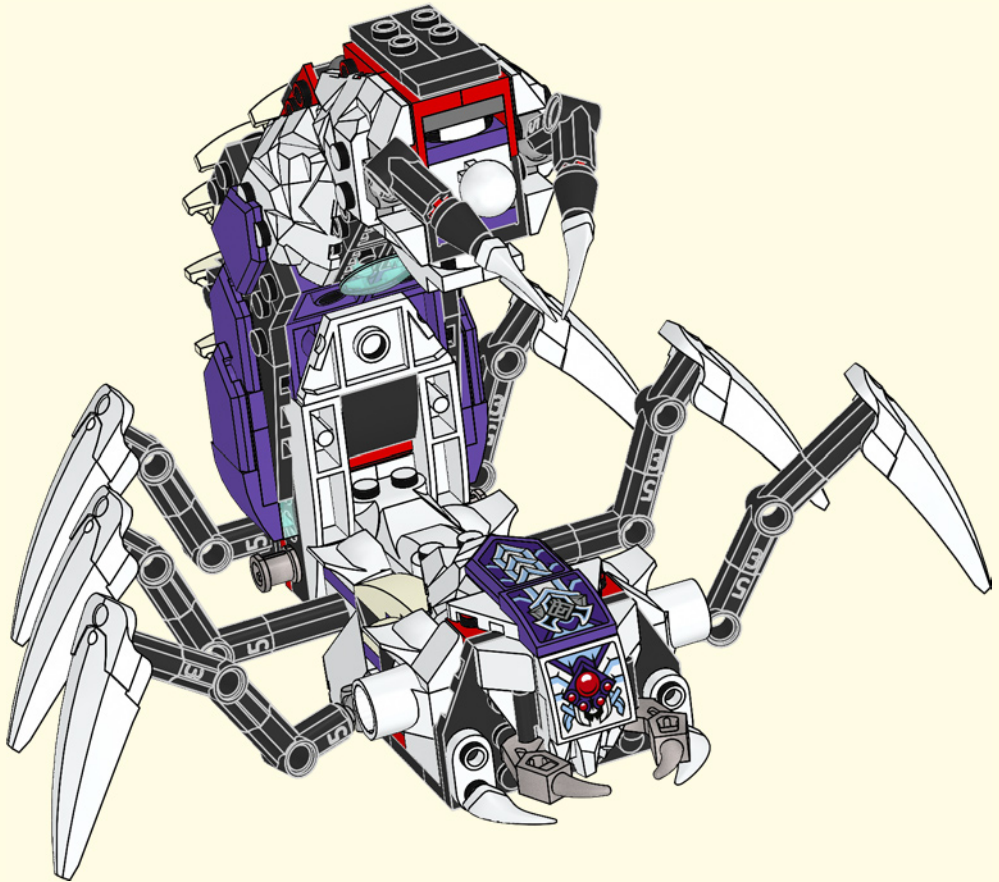

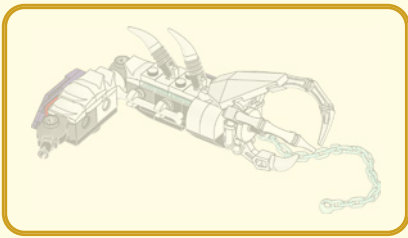

86

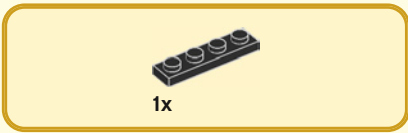
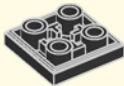

87

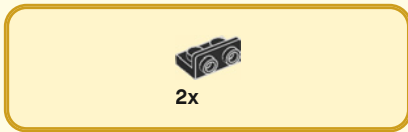
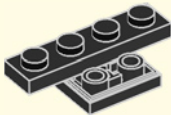

88

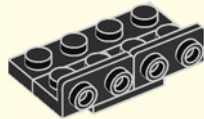

89

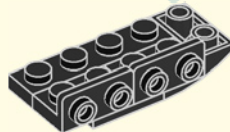
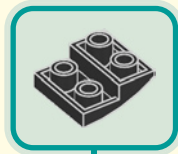



90

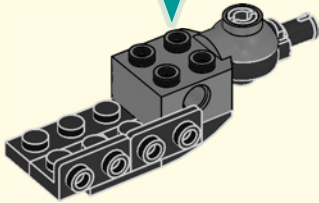
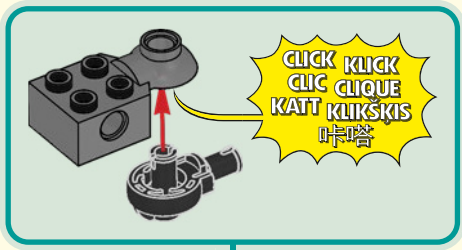

91

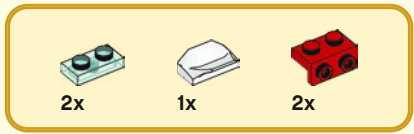
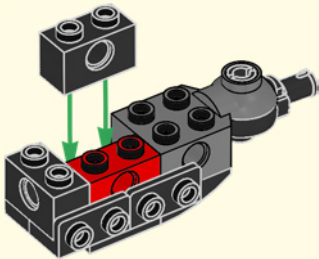

92

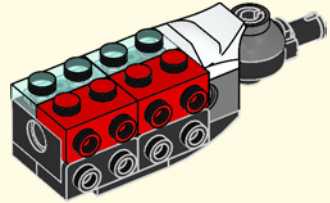

93

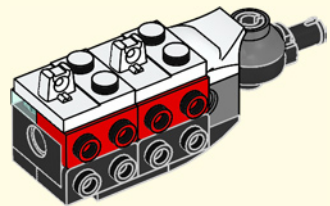

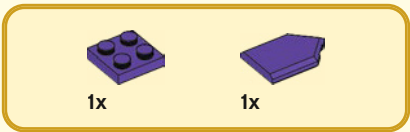

94

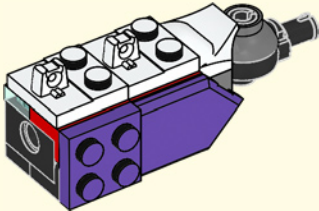

95

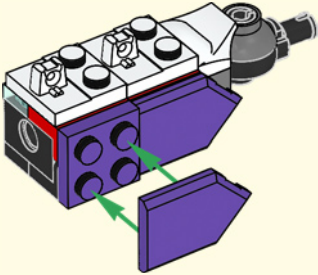

96

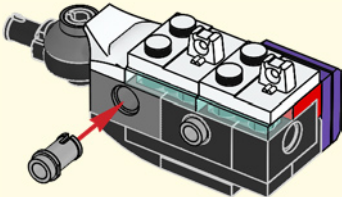



2x

97

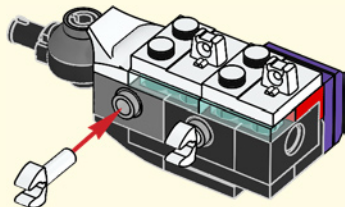

1x

98

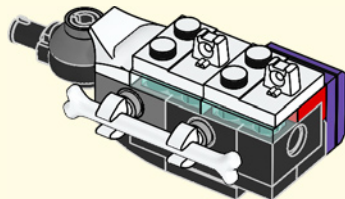

2x



2x

99



2x

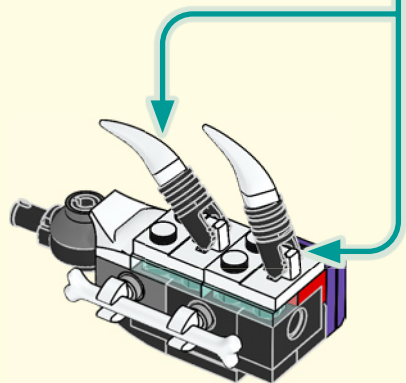

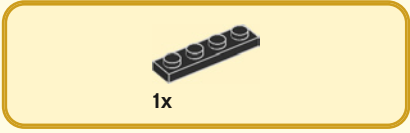

100

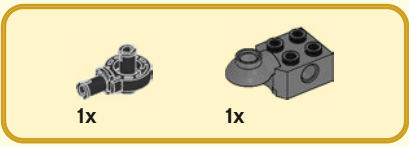
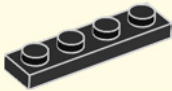

101

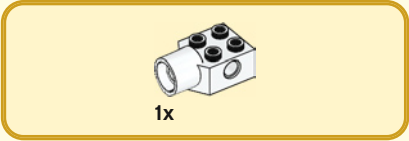
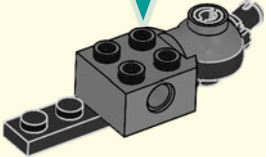
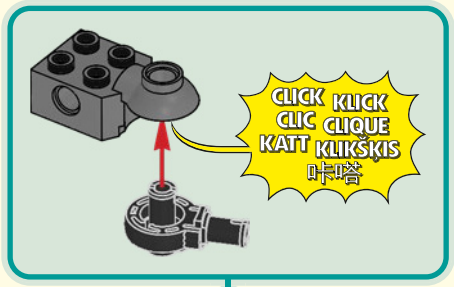

102

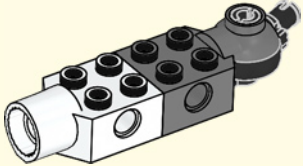



2x

103

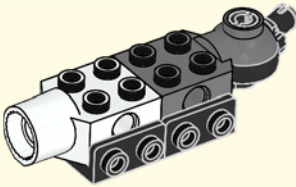

2x

105

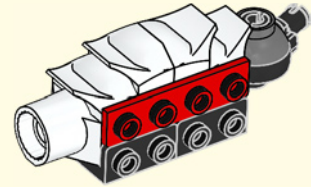

1x



1x



2x

104

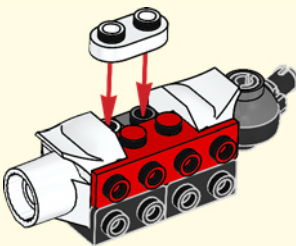

1x



1x

106

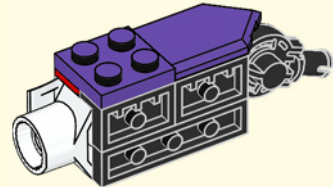



1x

107

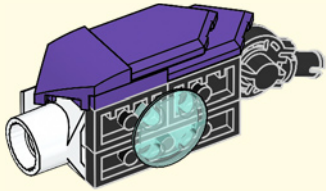

1x



1x

108

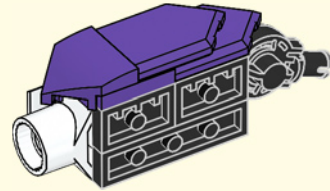

109

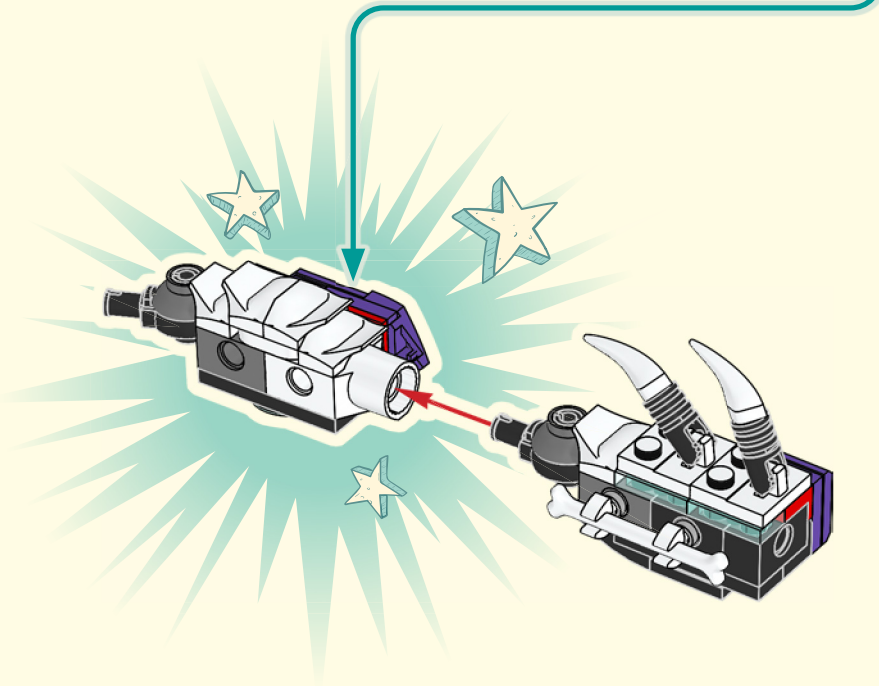

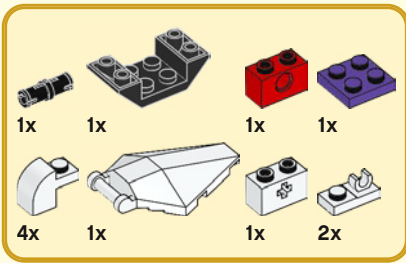

110

1

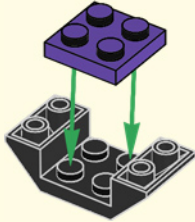

2

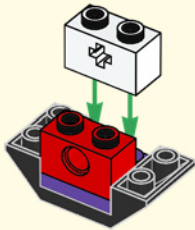

3

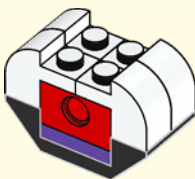

4

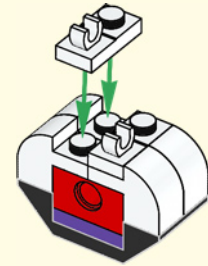

5

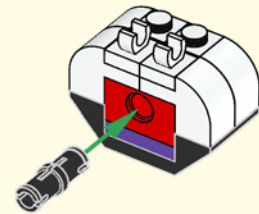

6

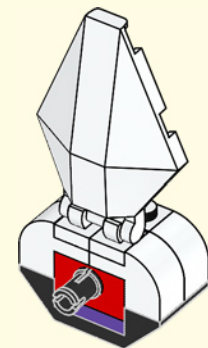

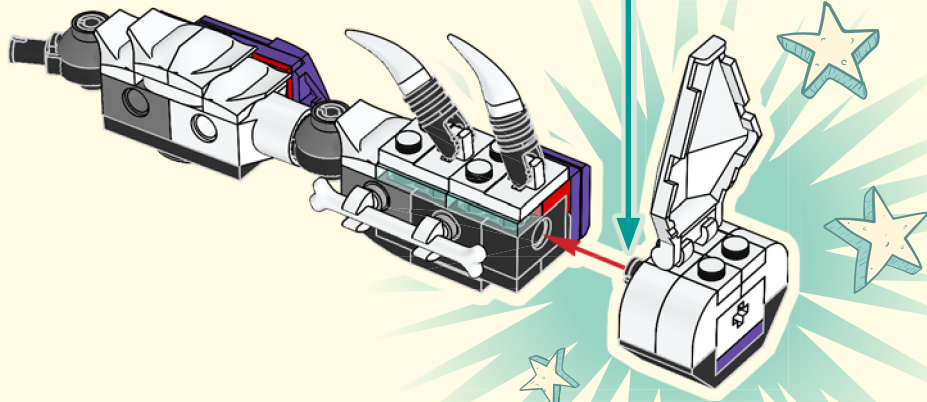

111

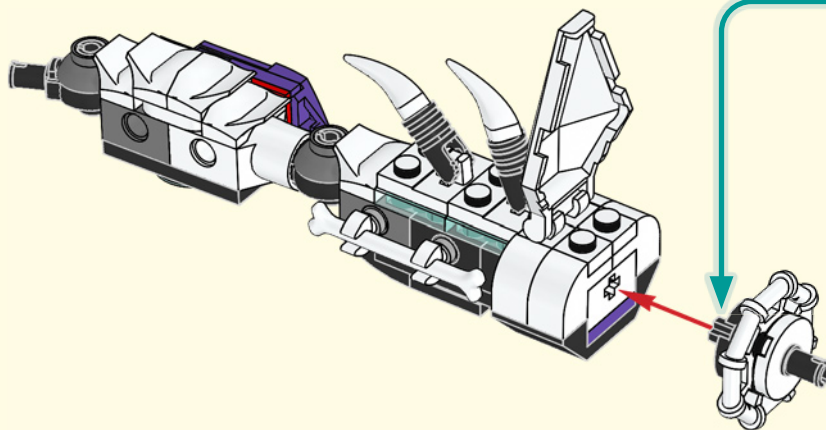
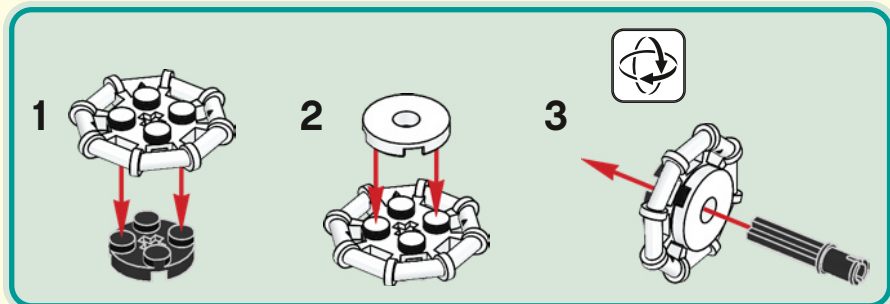

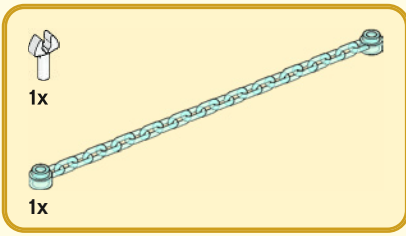

112

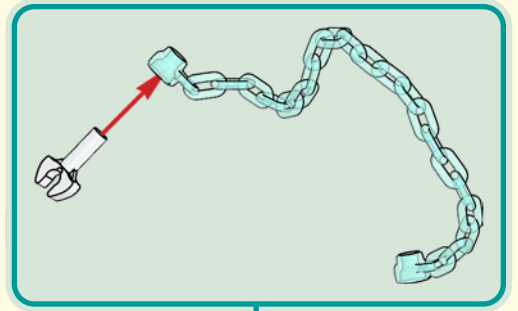
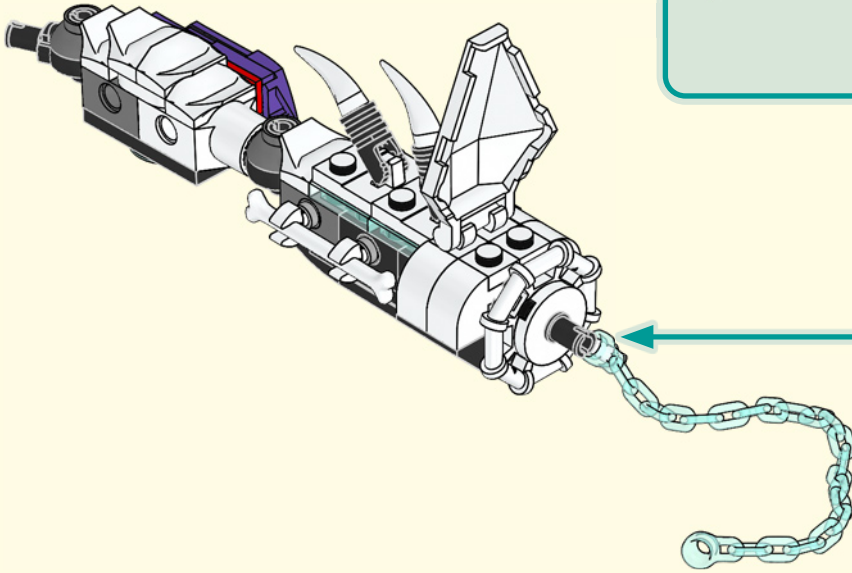

113

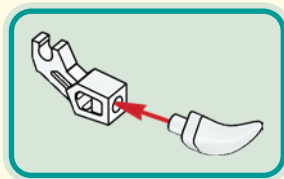
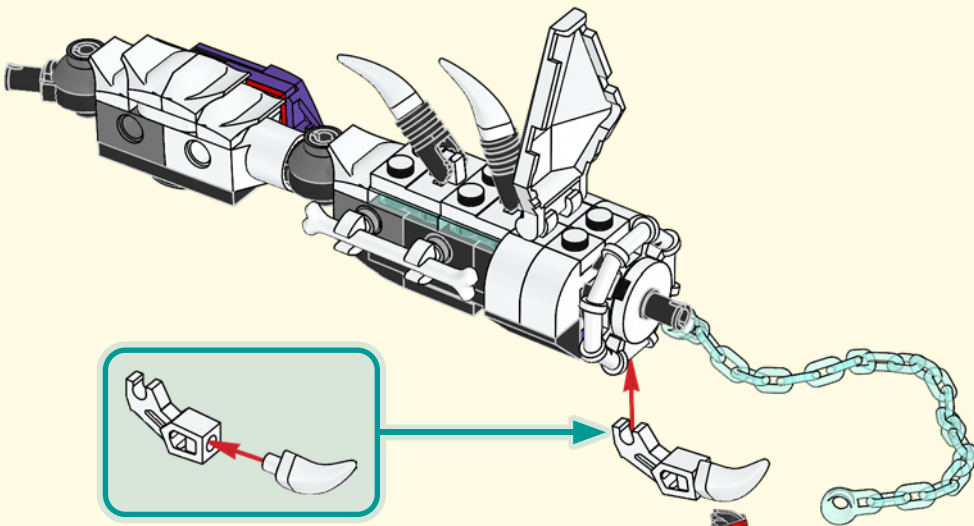

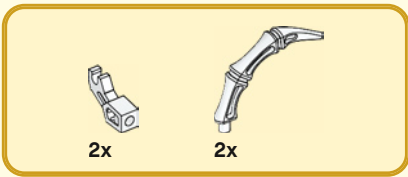

114

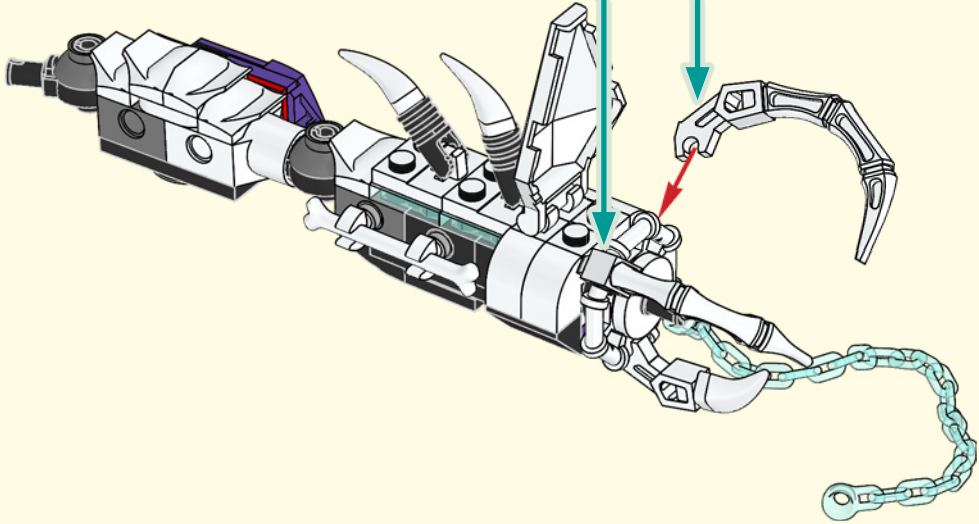
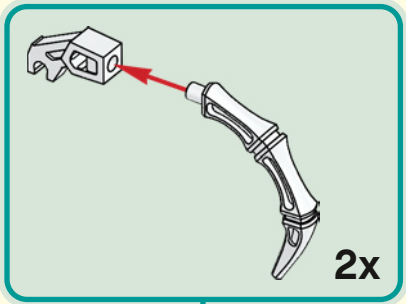

115

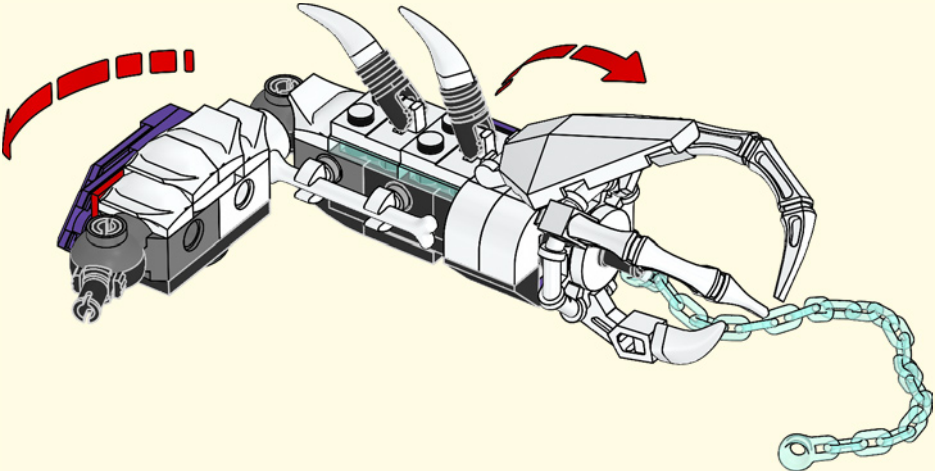

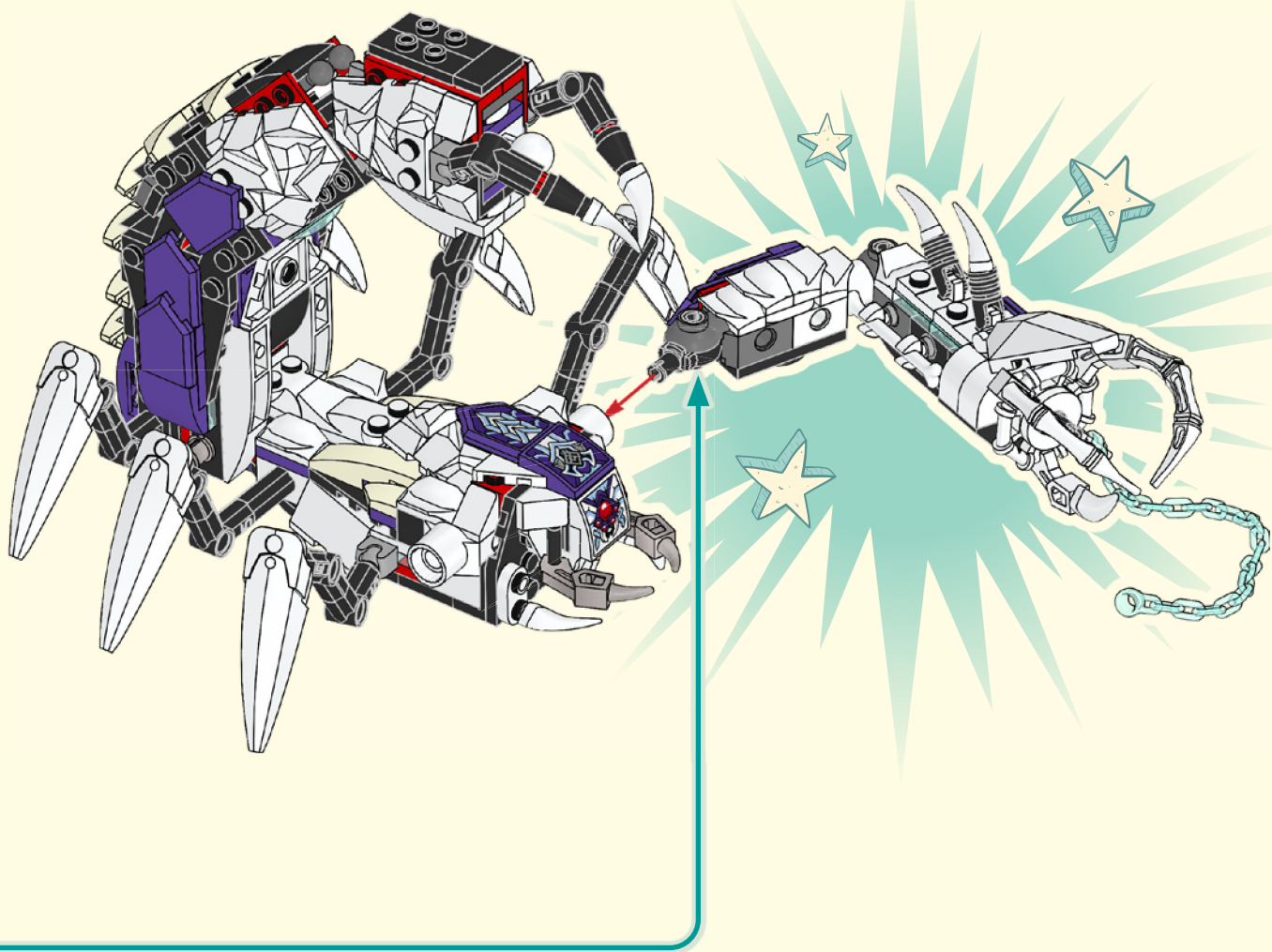

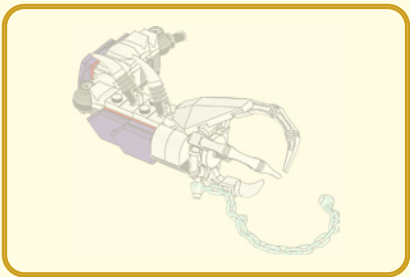

117

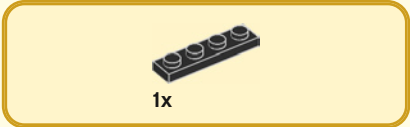
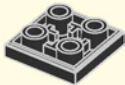

118

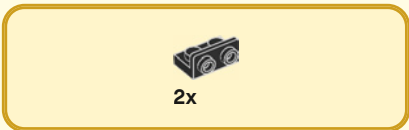
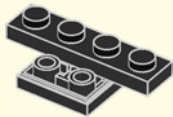

119

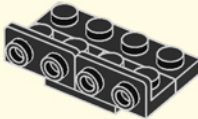

120

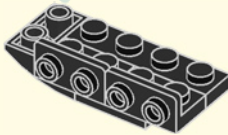
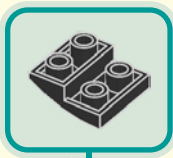



121

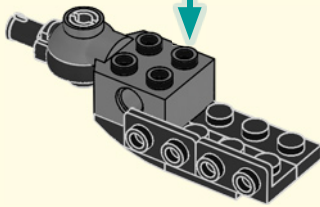

122

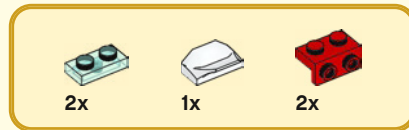
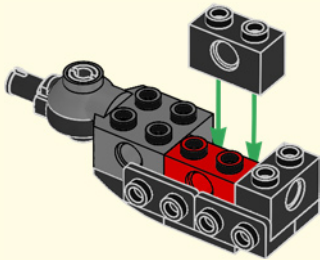

123

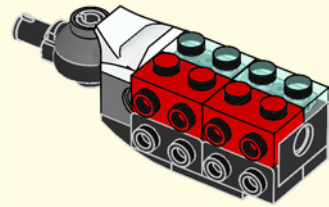

124

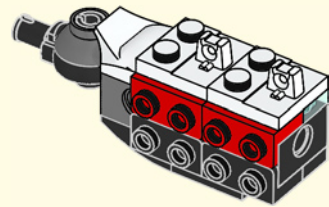

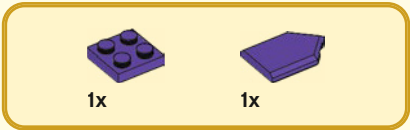

125

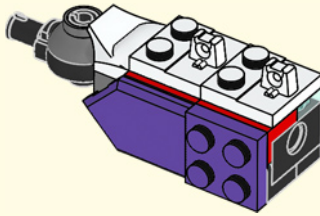

126

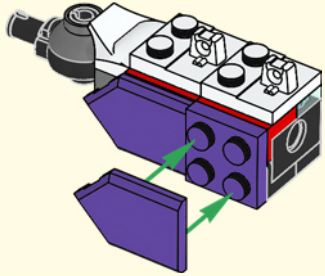

127

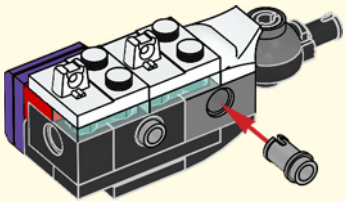



2x

128

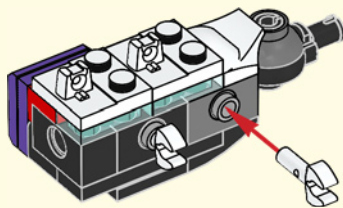

1x

129

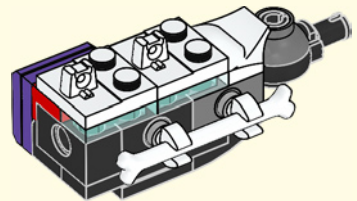

2x



2x

130

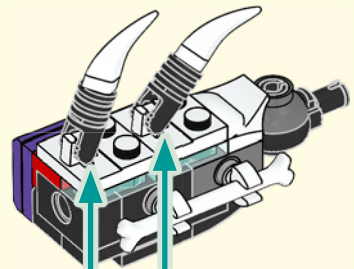

2x



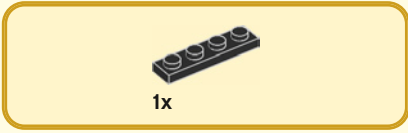
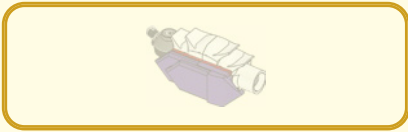

1x

131

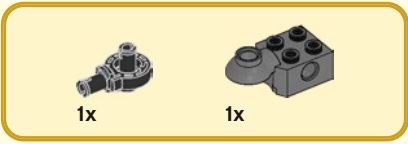
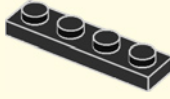

1x

1x

132

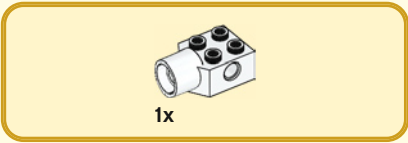
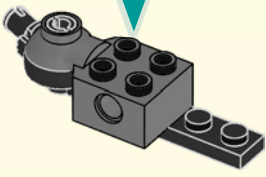
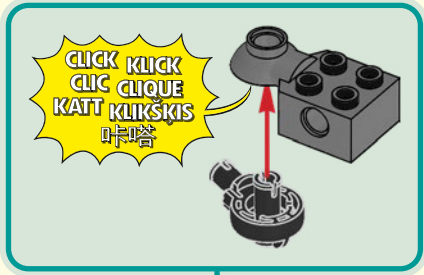

1x

133

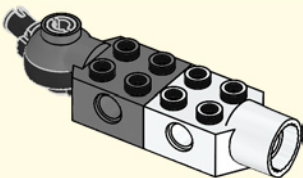



2x

134

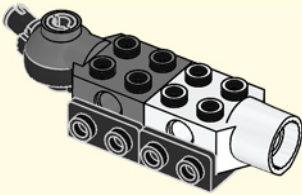

2x

136

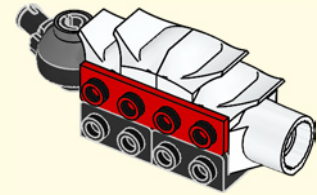

1x



2x



1x

135

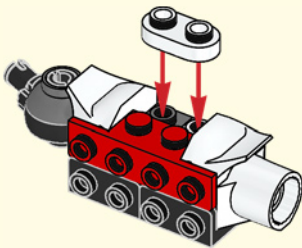

1x



1x

137

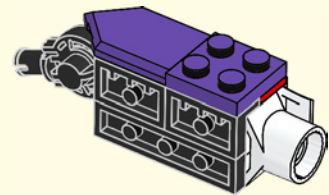



138

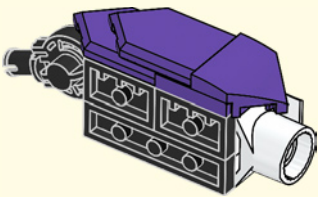

139

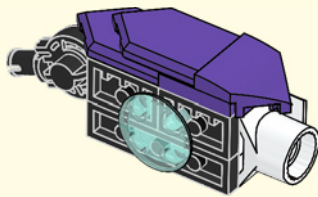

140

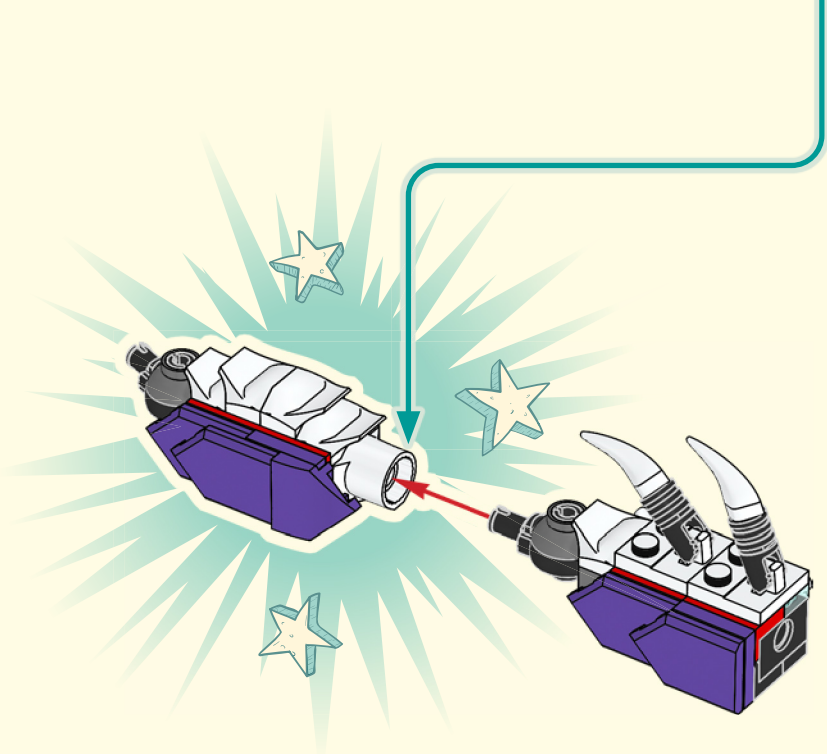

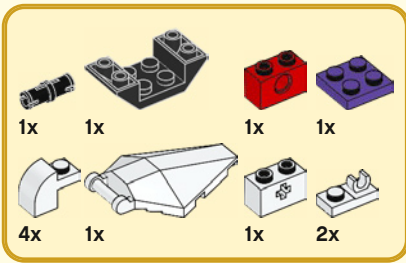

141

1

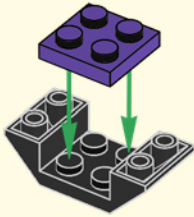

2

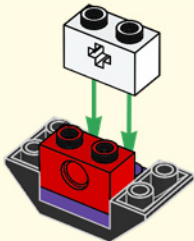

3

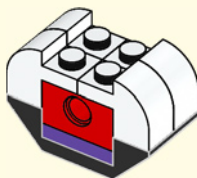

4

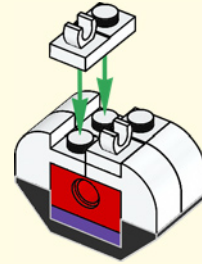

5

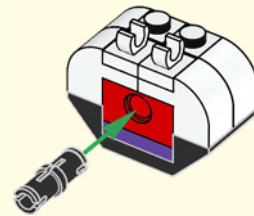

6

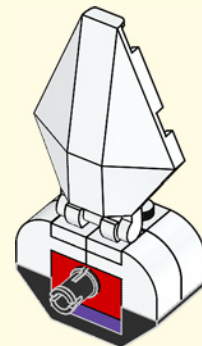

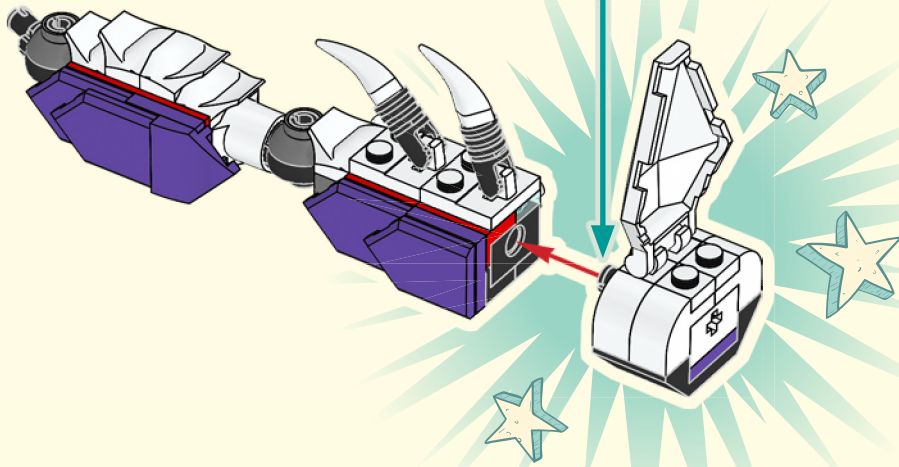

142

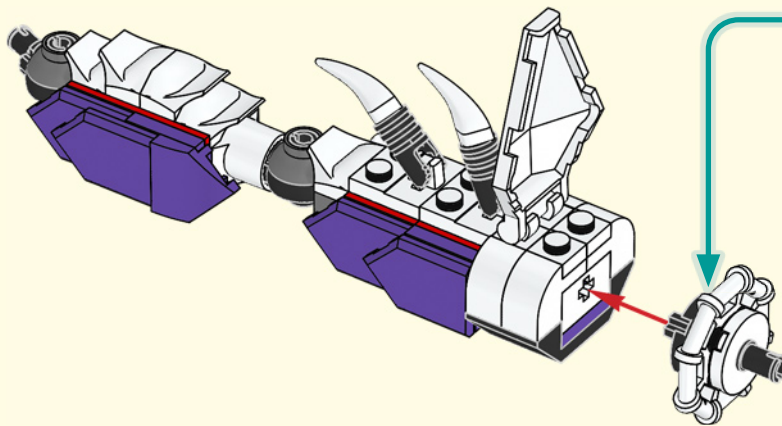
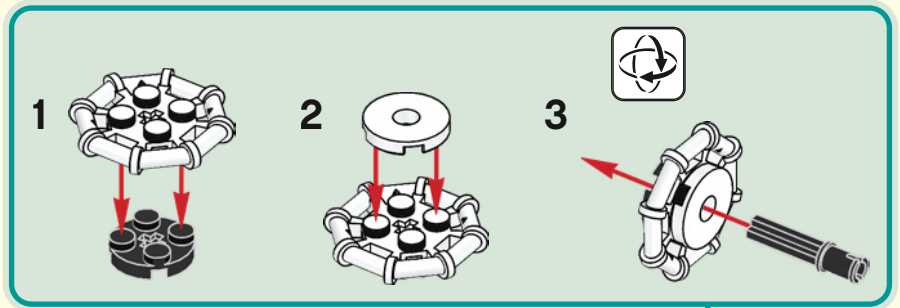



143

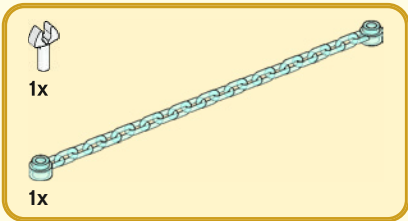
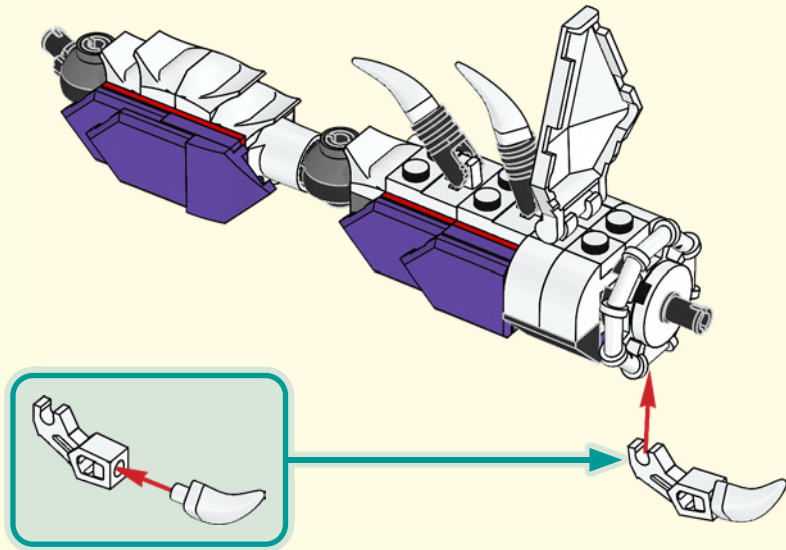

144

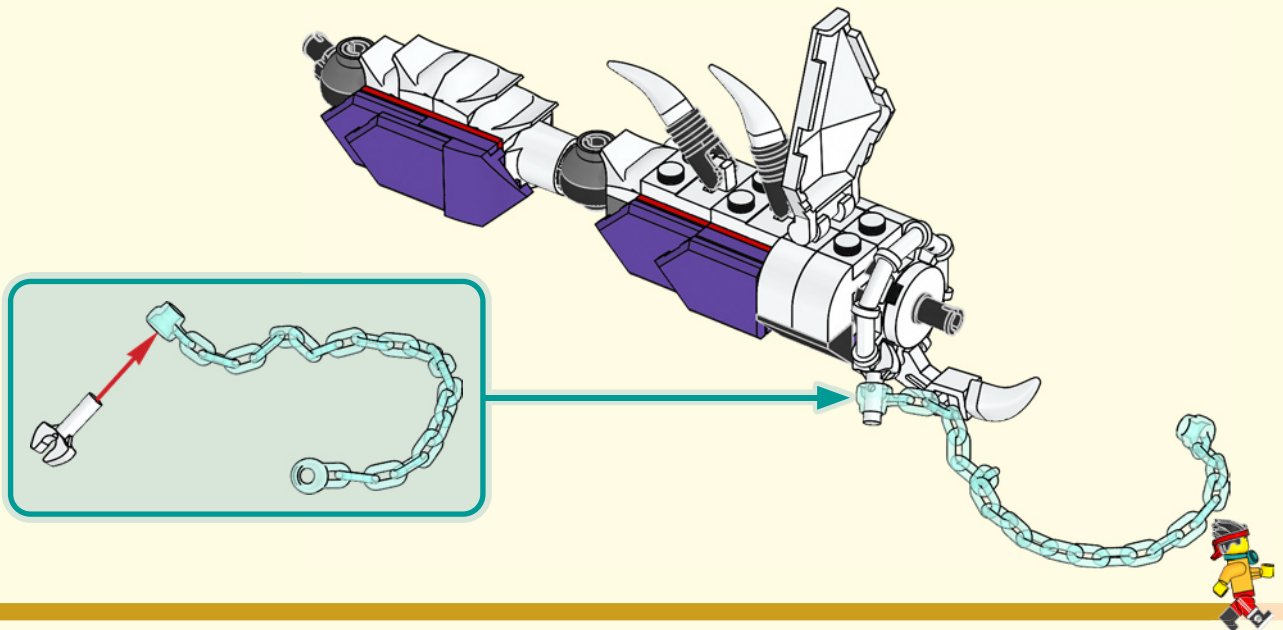

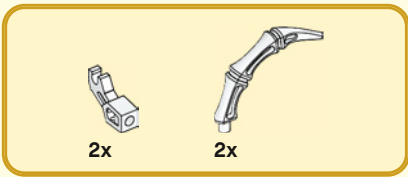

145

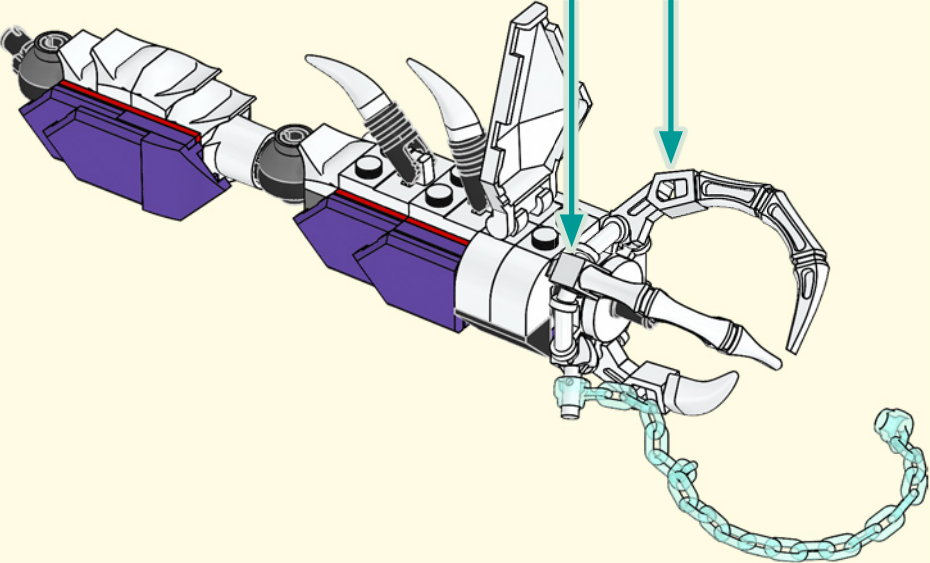
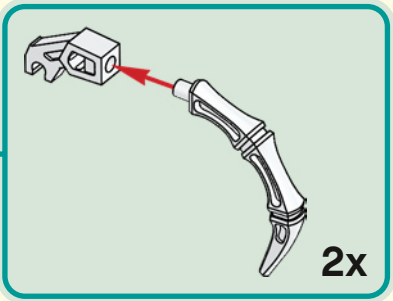

146

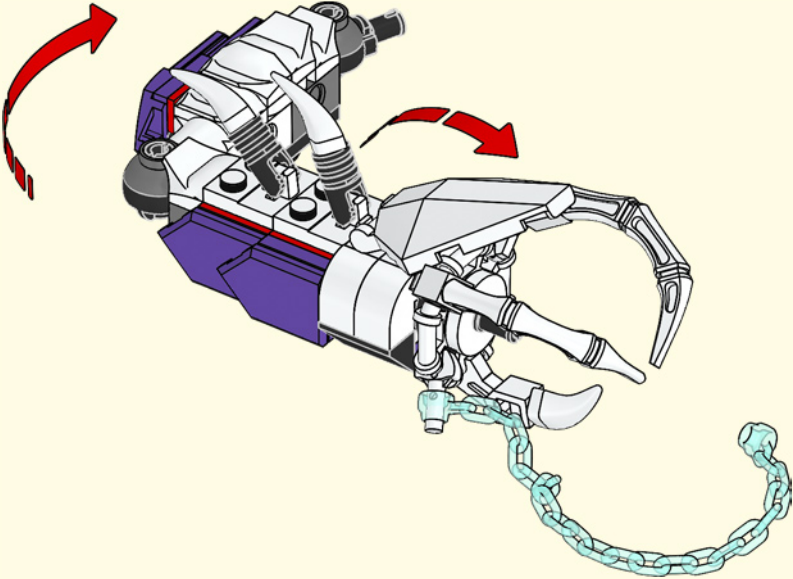

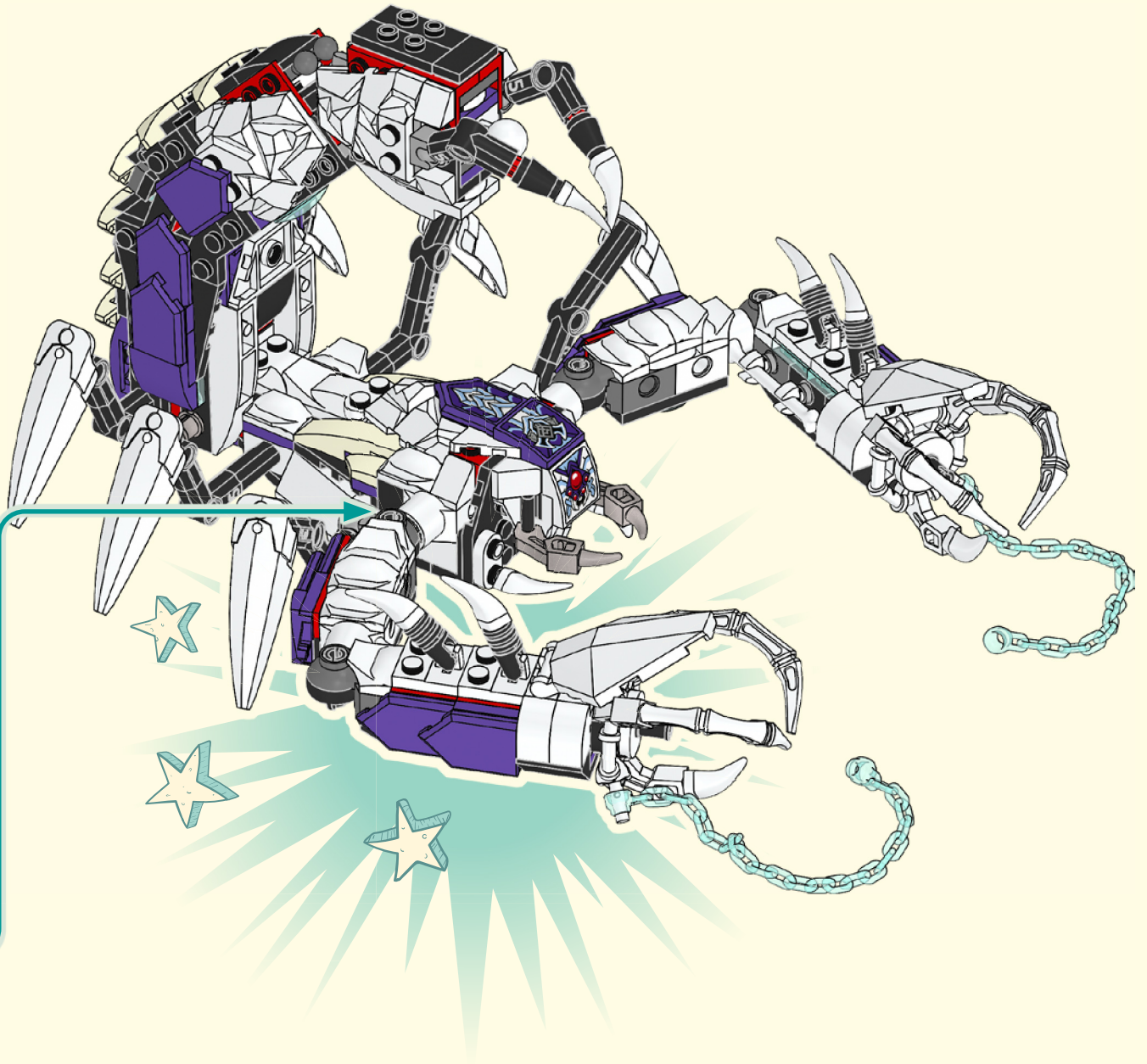

LEGO

MONKIE KID 悟空小侠™

À combiner pour former le modèle ultime

Combine into ultimate model
Kombiniere sie zu einem ultimativen Modell
Combine-les pour créer un incroyable modèle
Combinalo in un super modello
Combinálos y crea el modelo definitivo
Combina para obter o modelo supremo
Rakd össze egyetlen fantasztikus modellé!
Savieno, lai izveidotu neticami iespaidīgu modeli
合体进化机甲形态

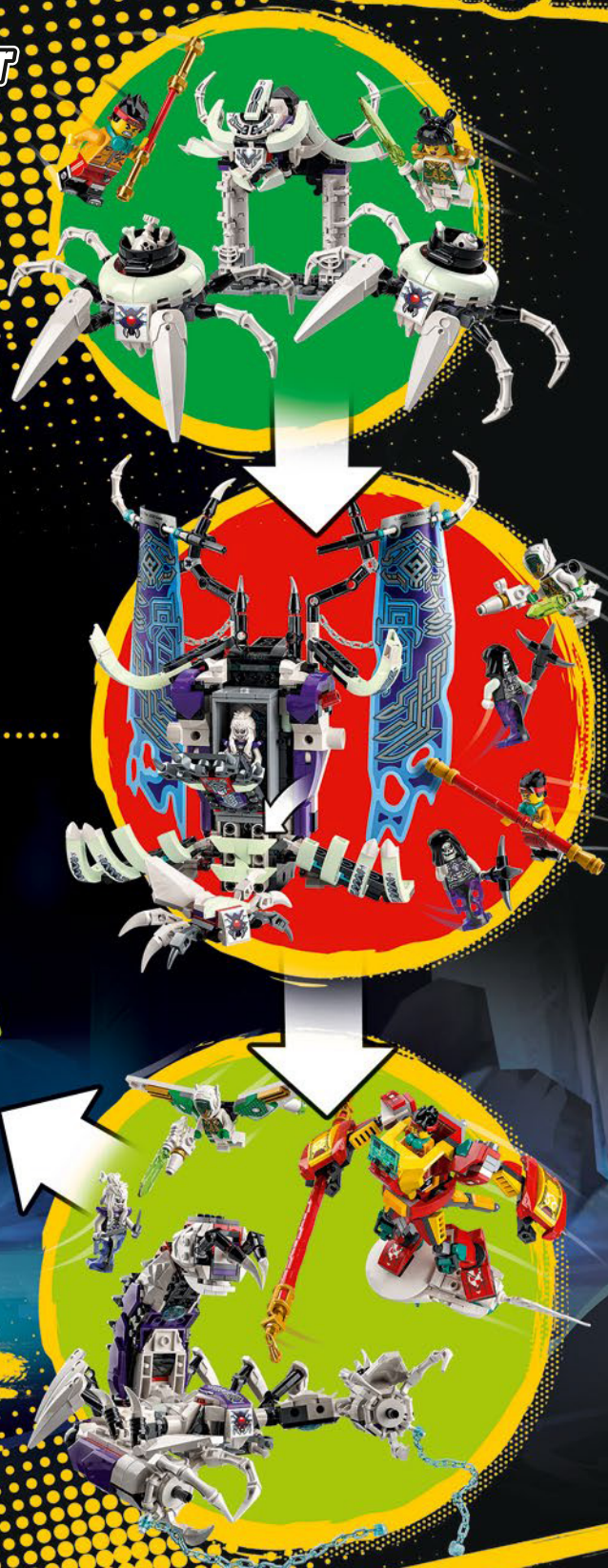
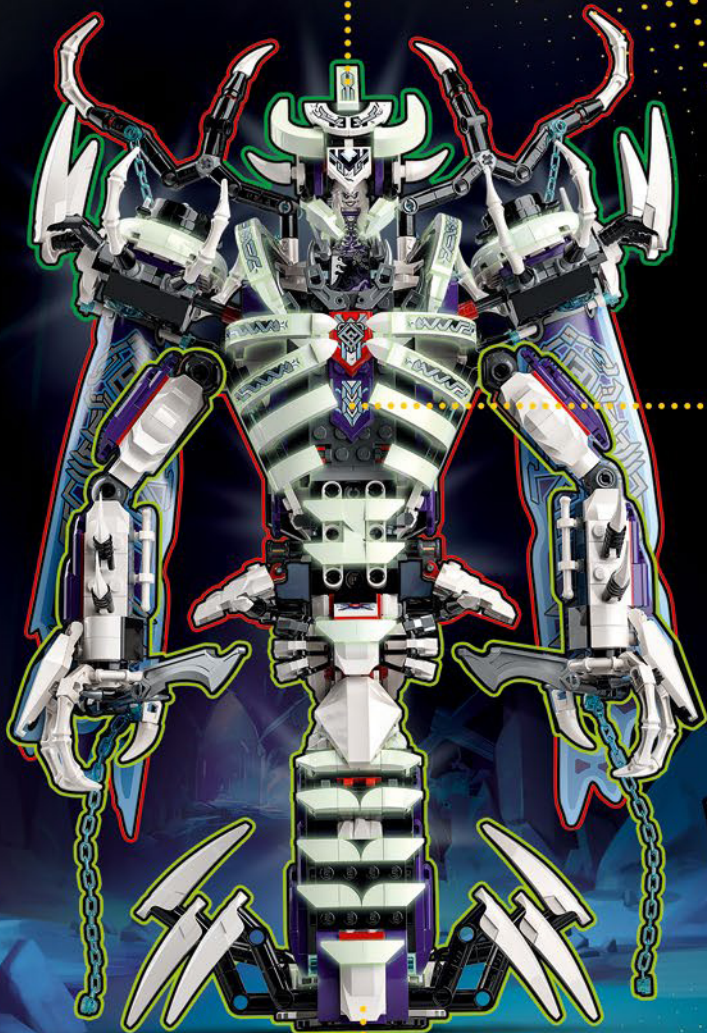

Combine into ultimate model

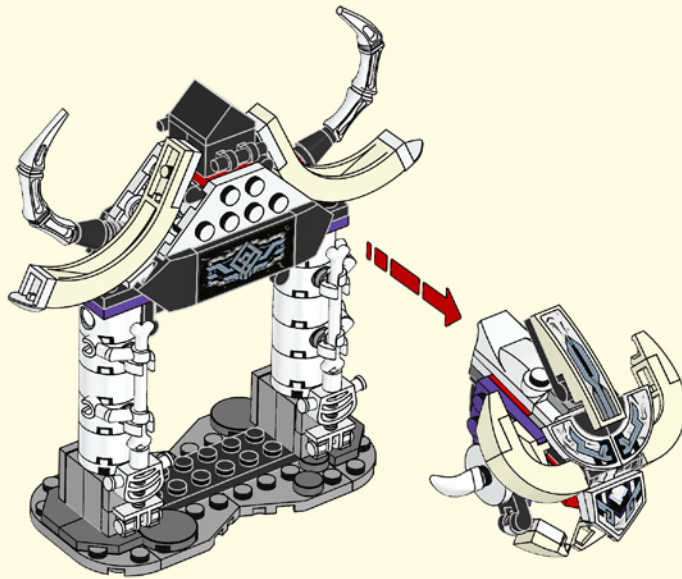
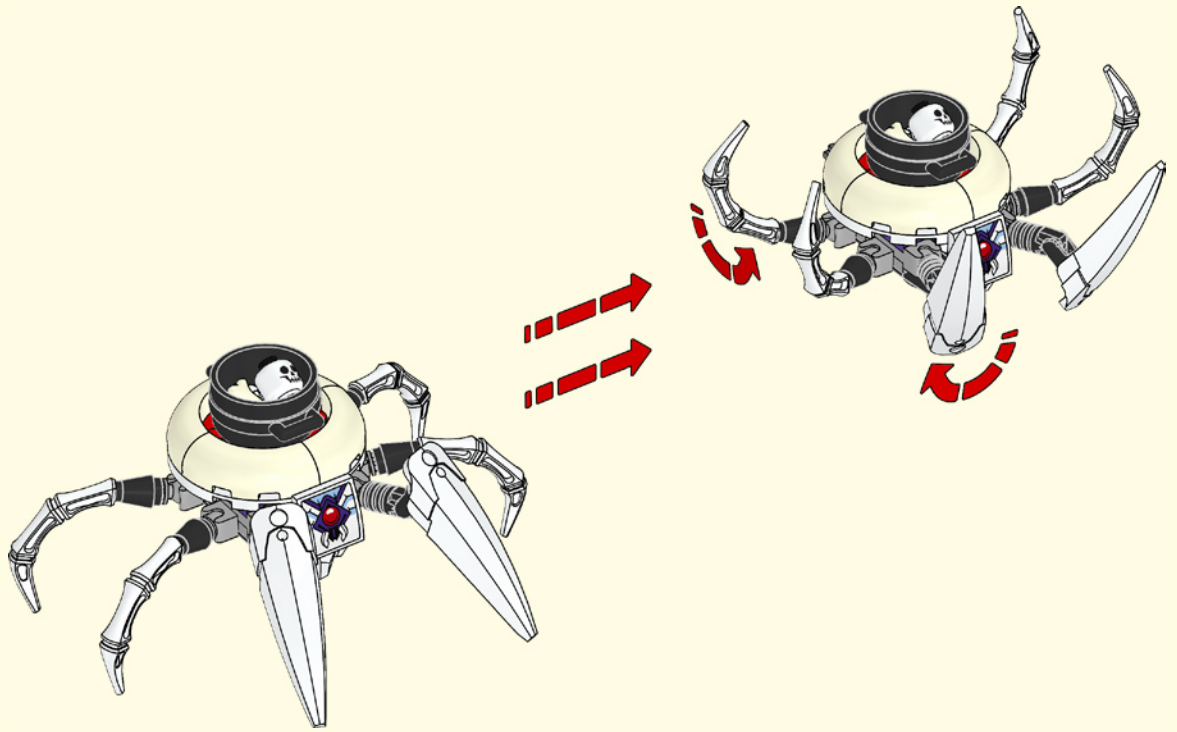

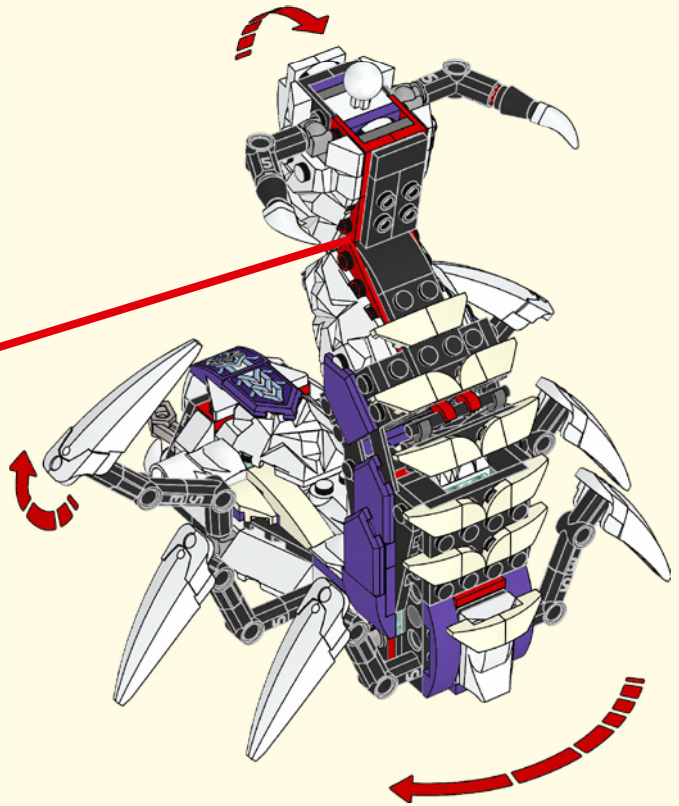
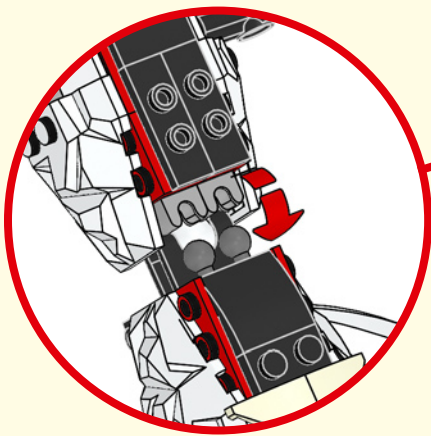
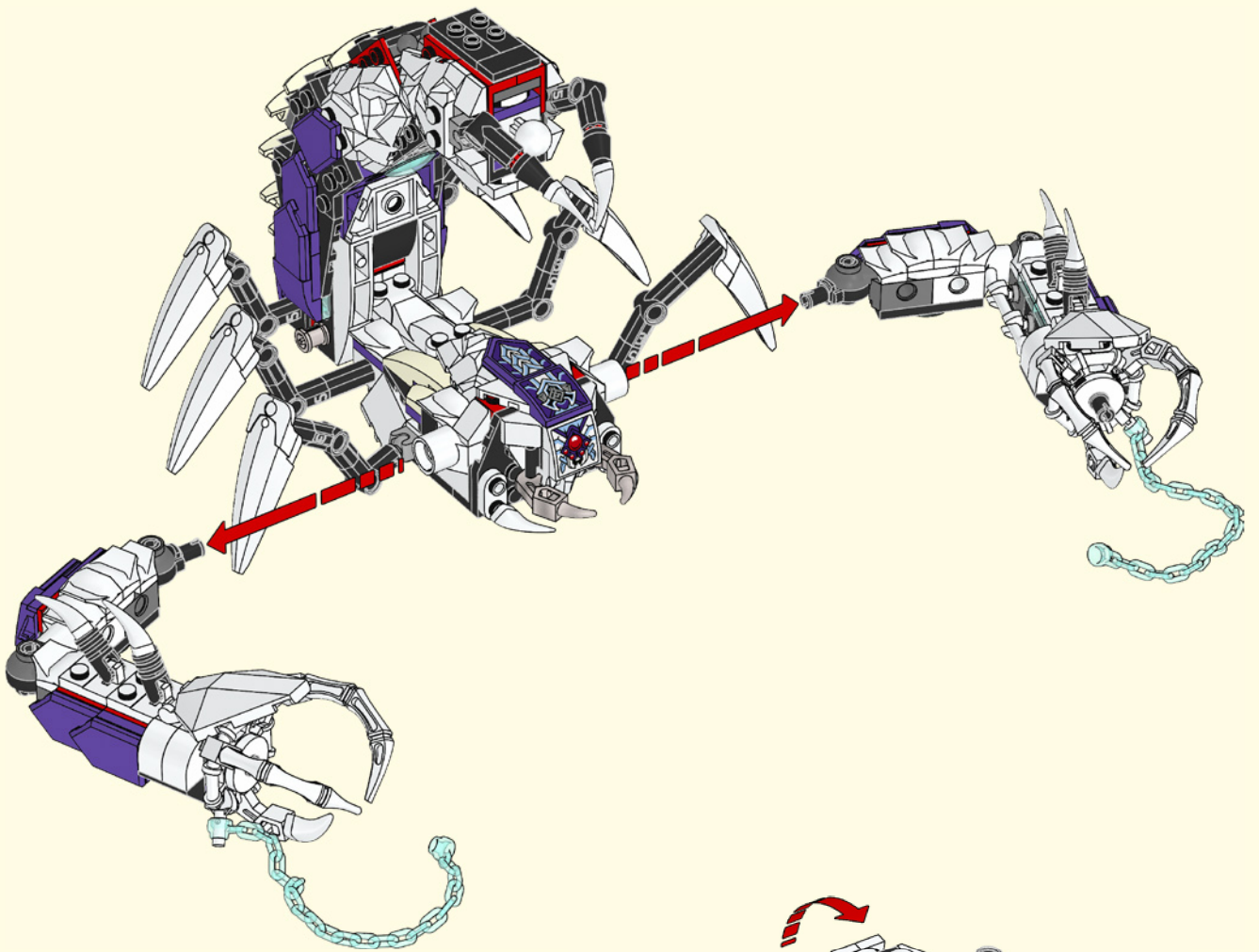

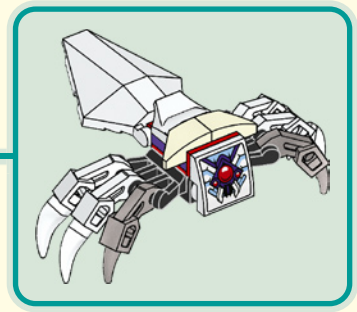
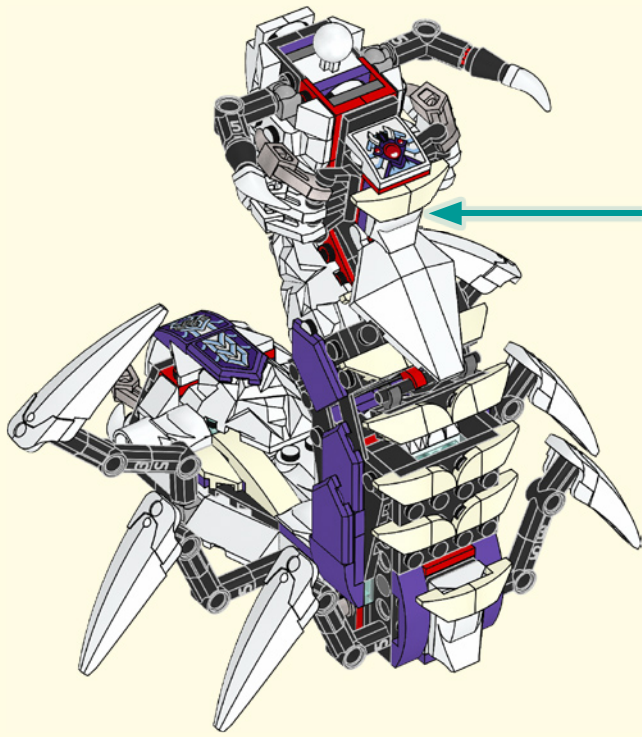

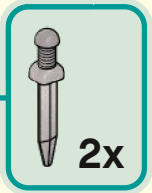
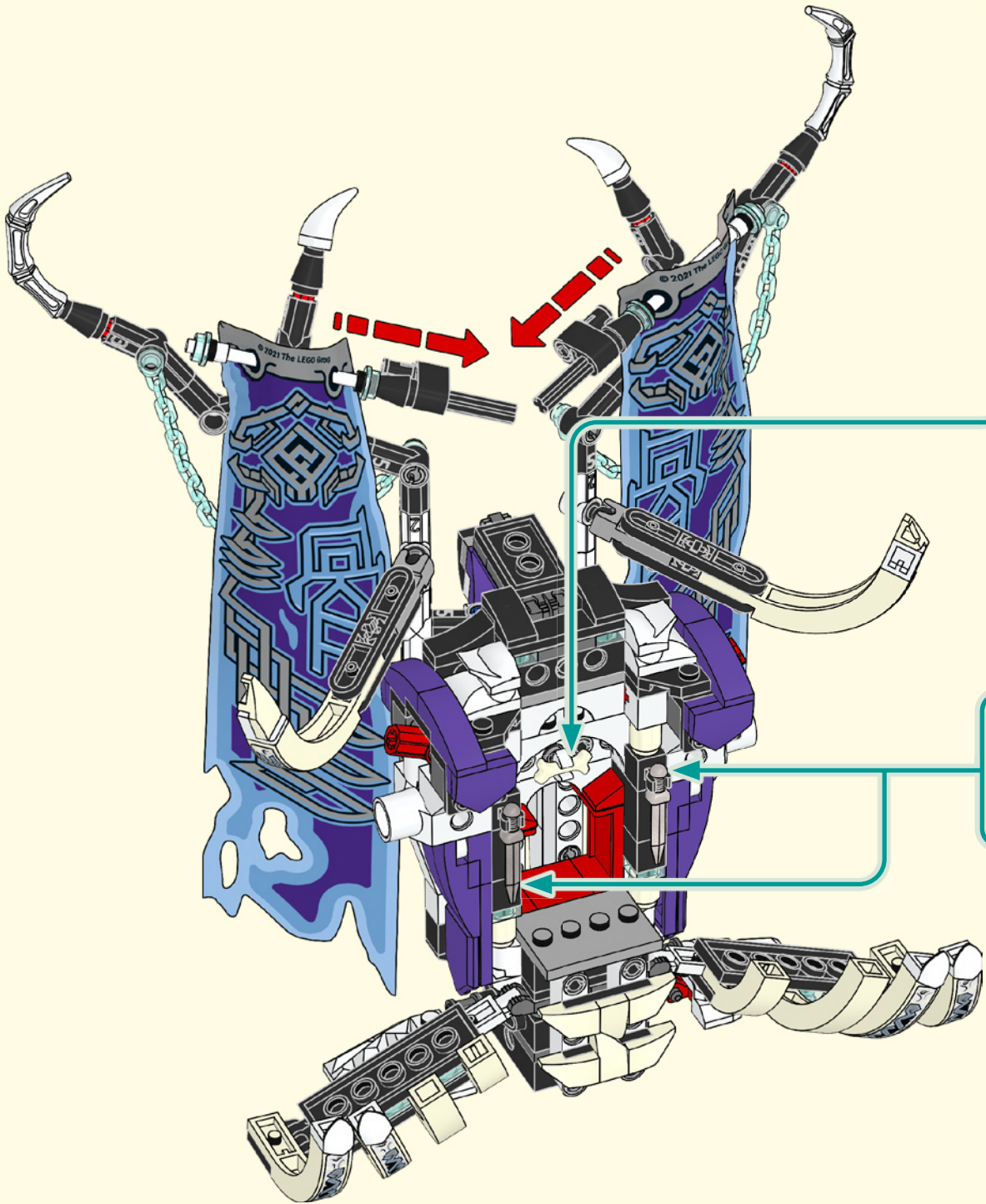

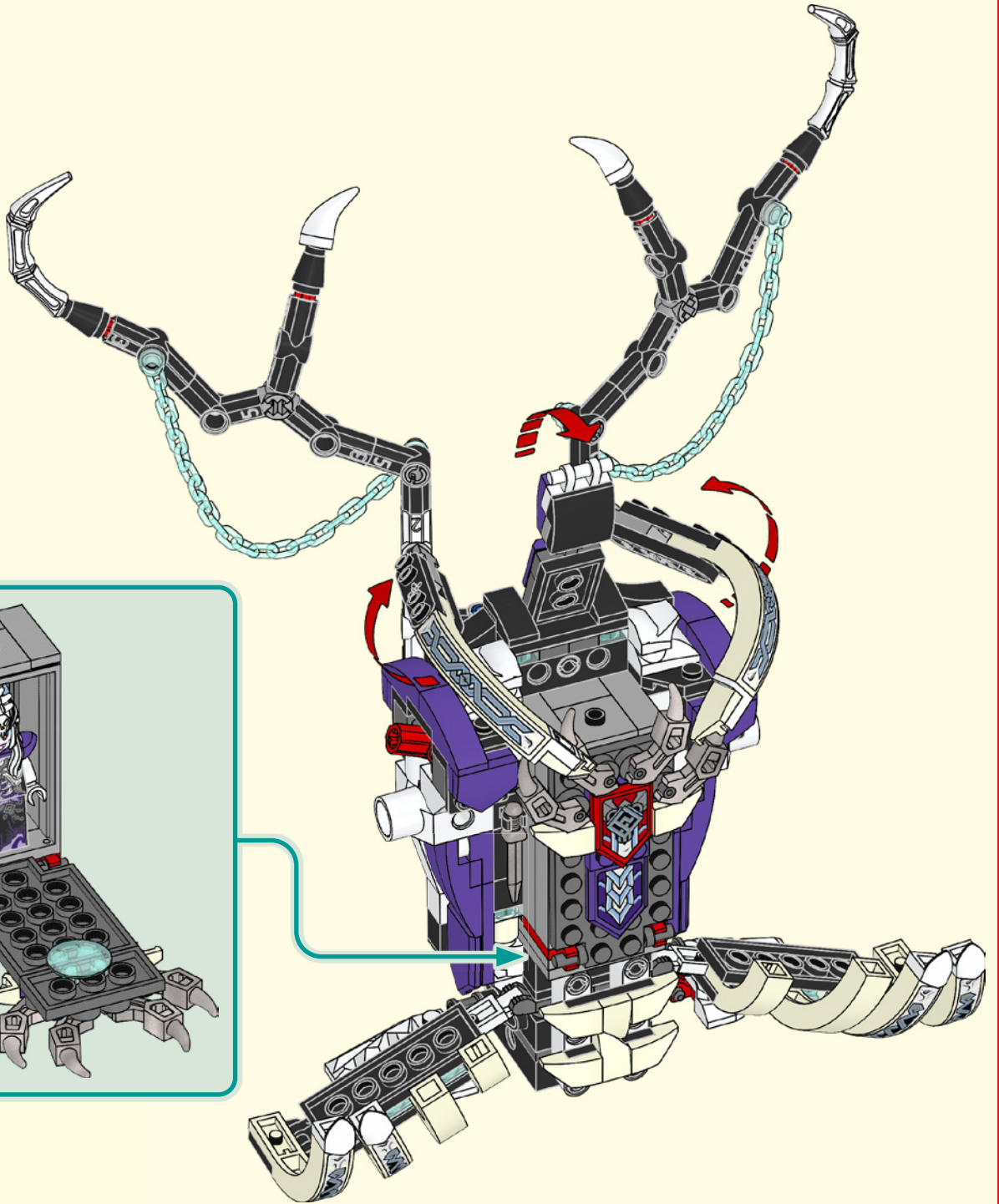

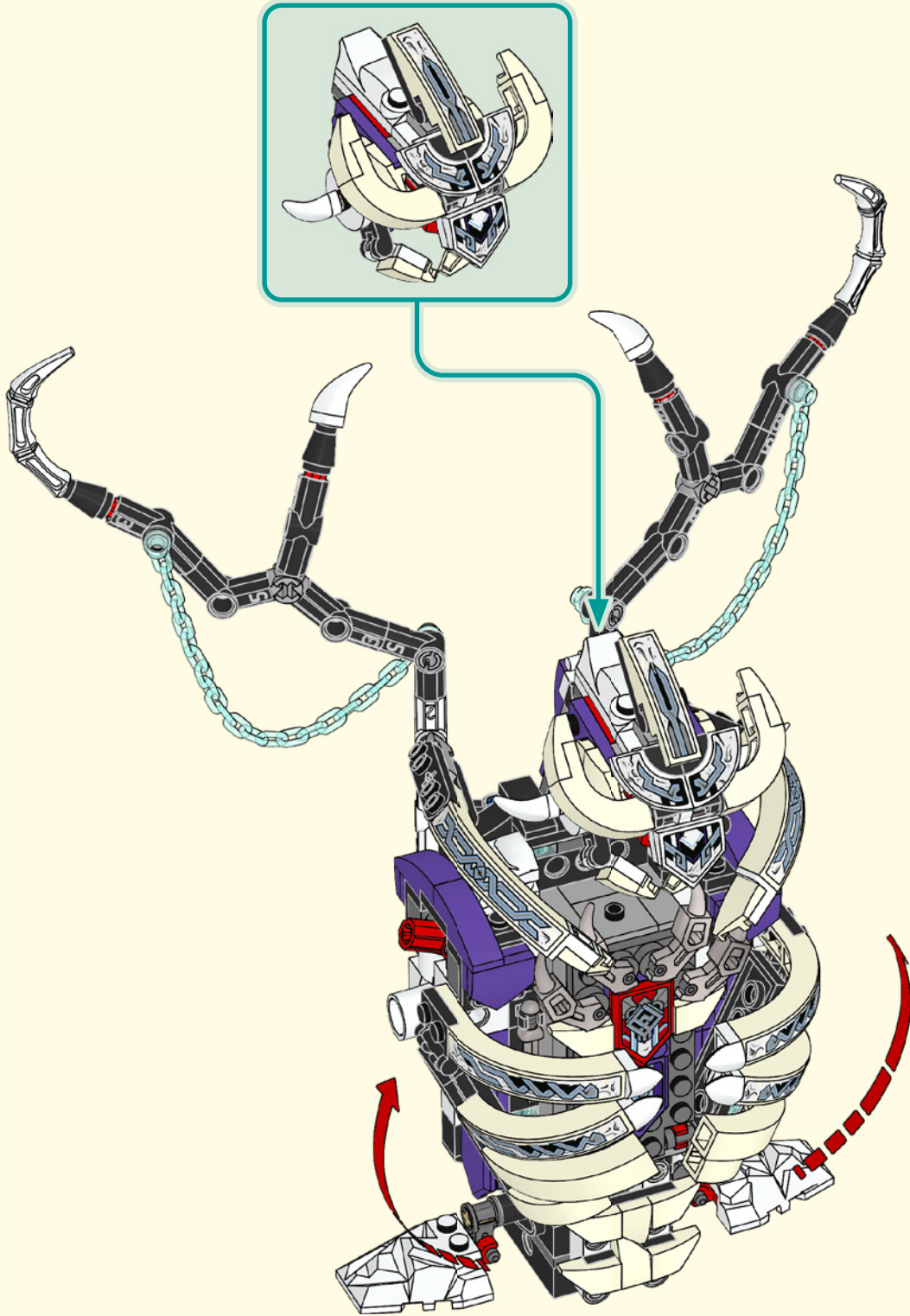

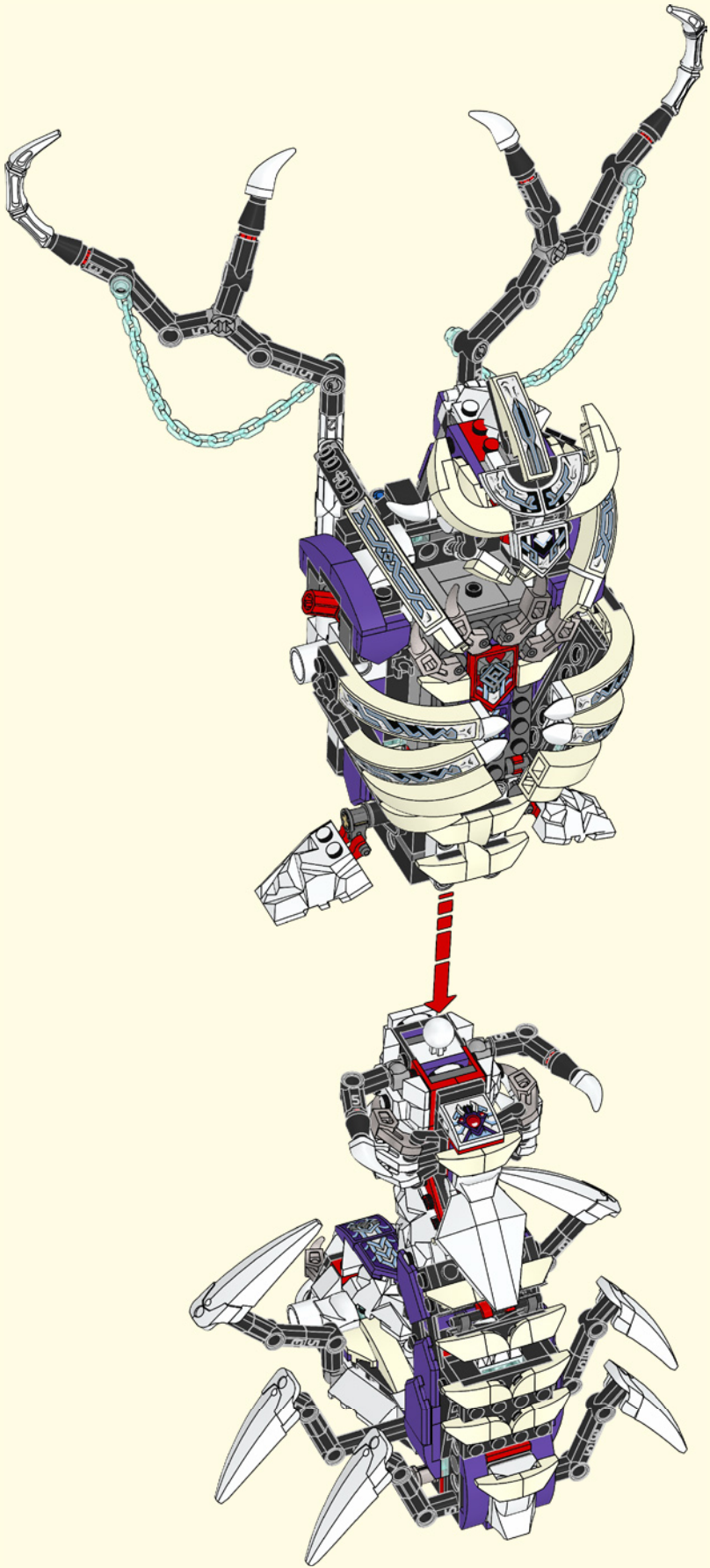

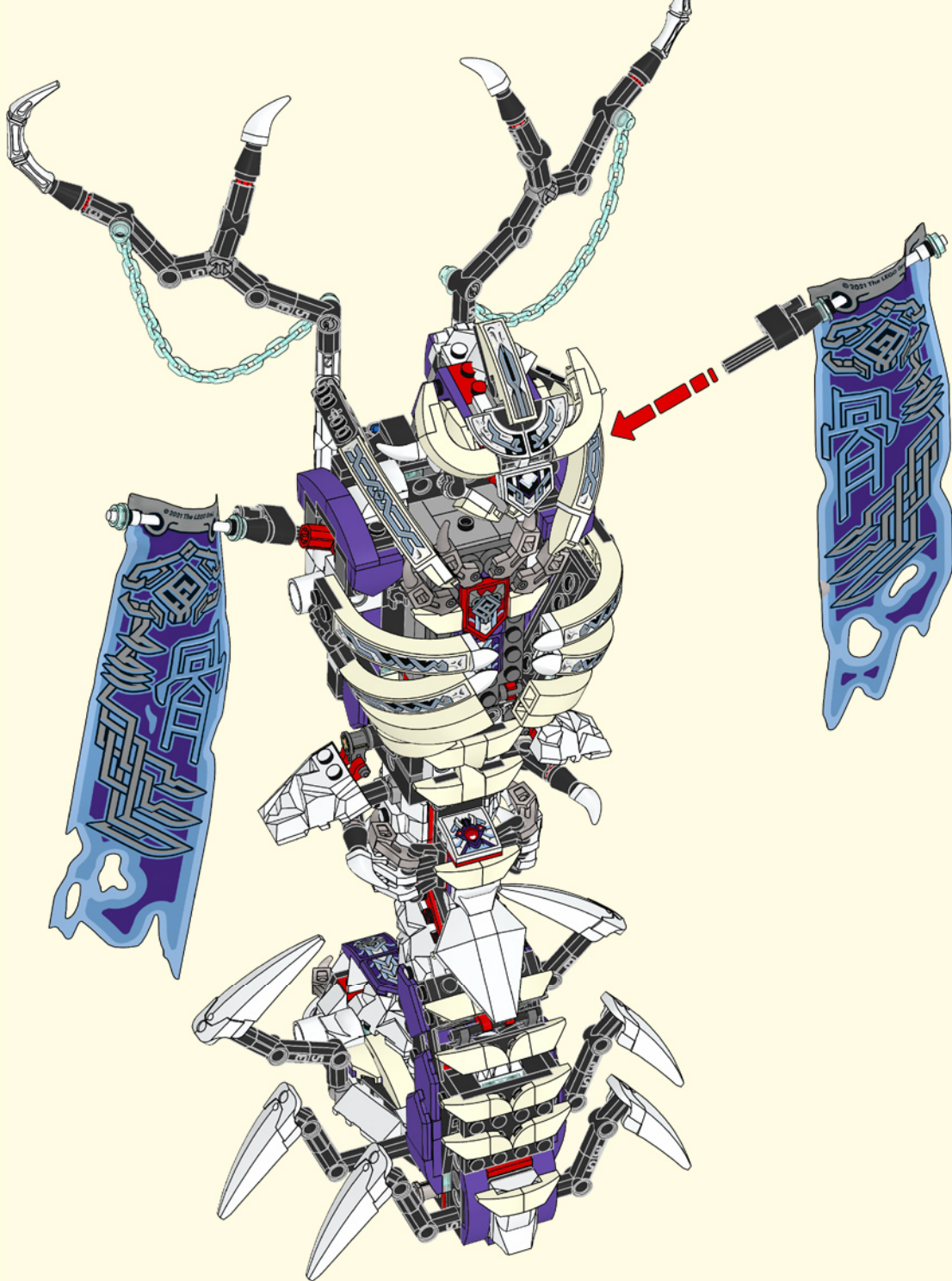
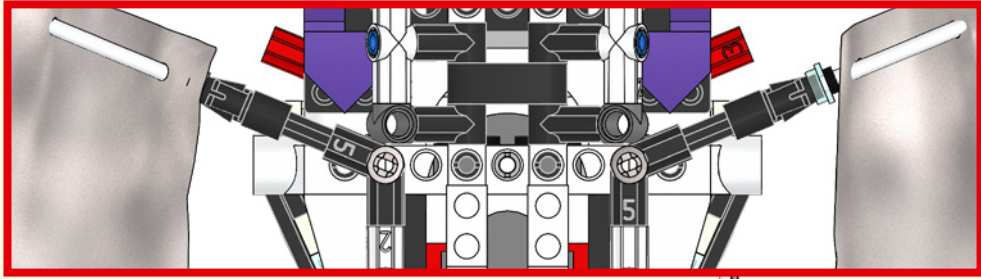

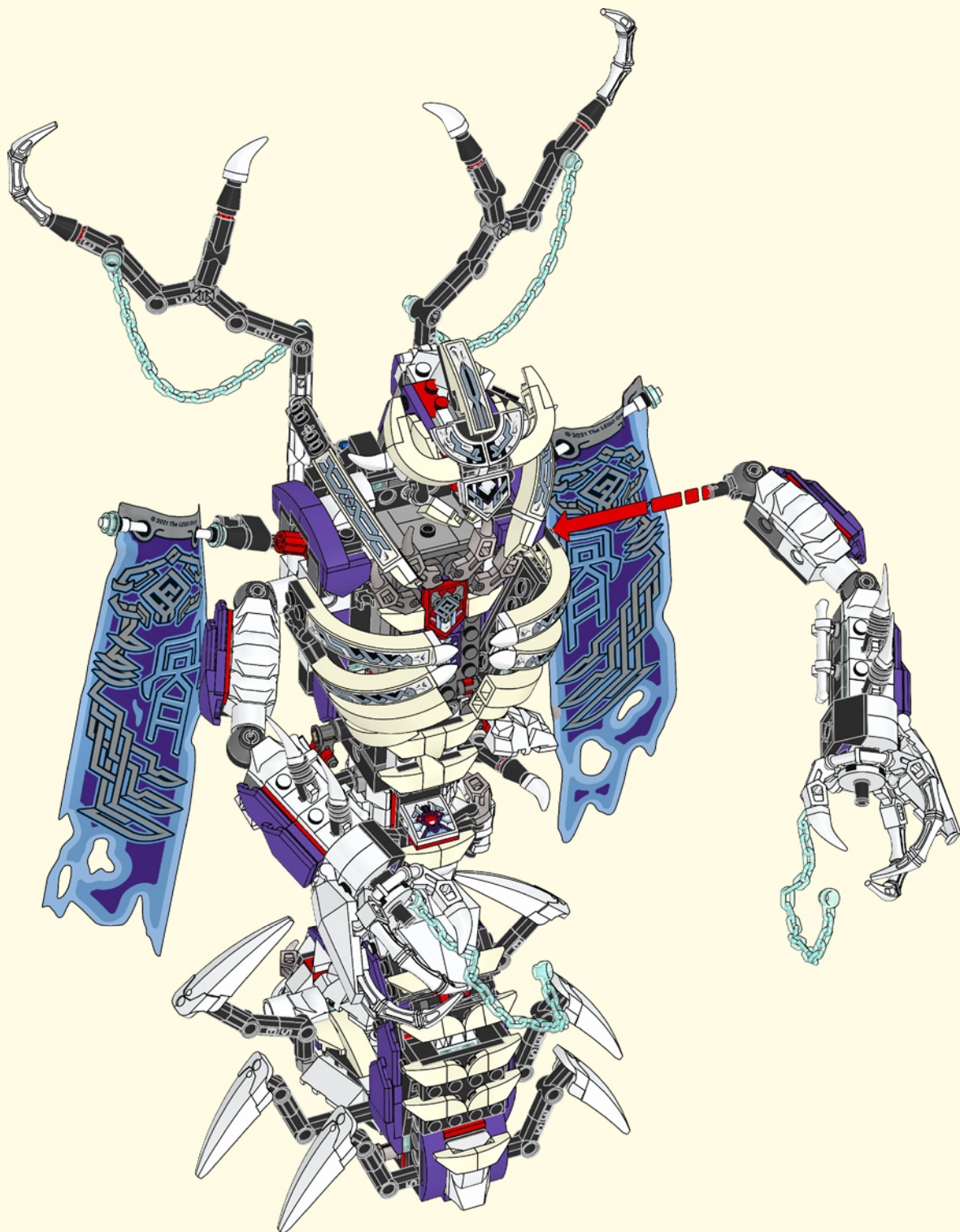

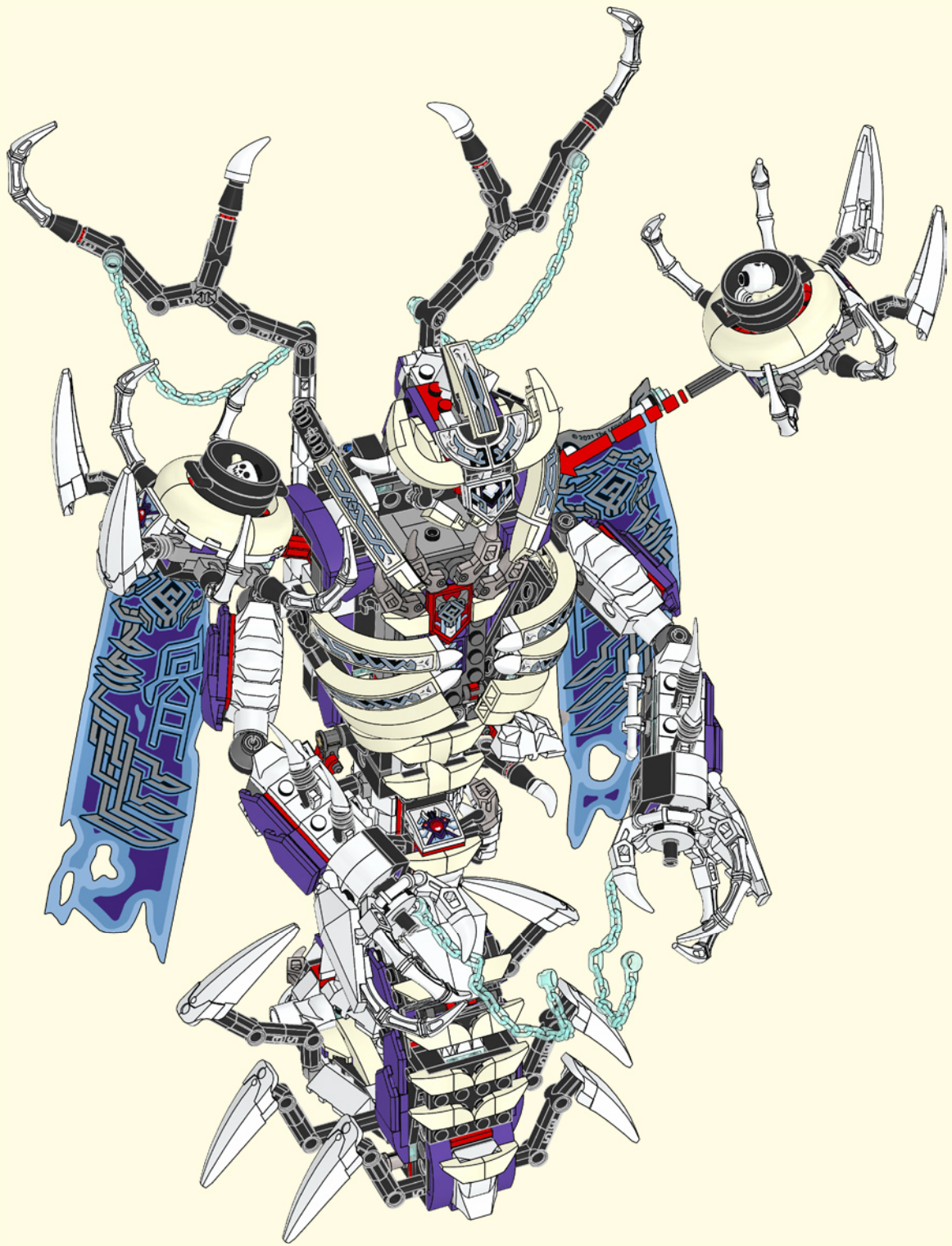

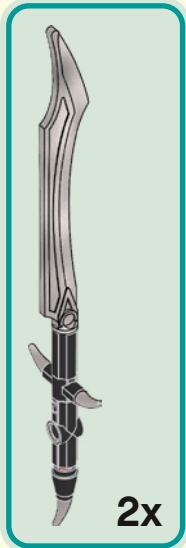
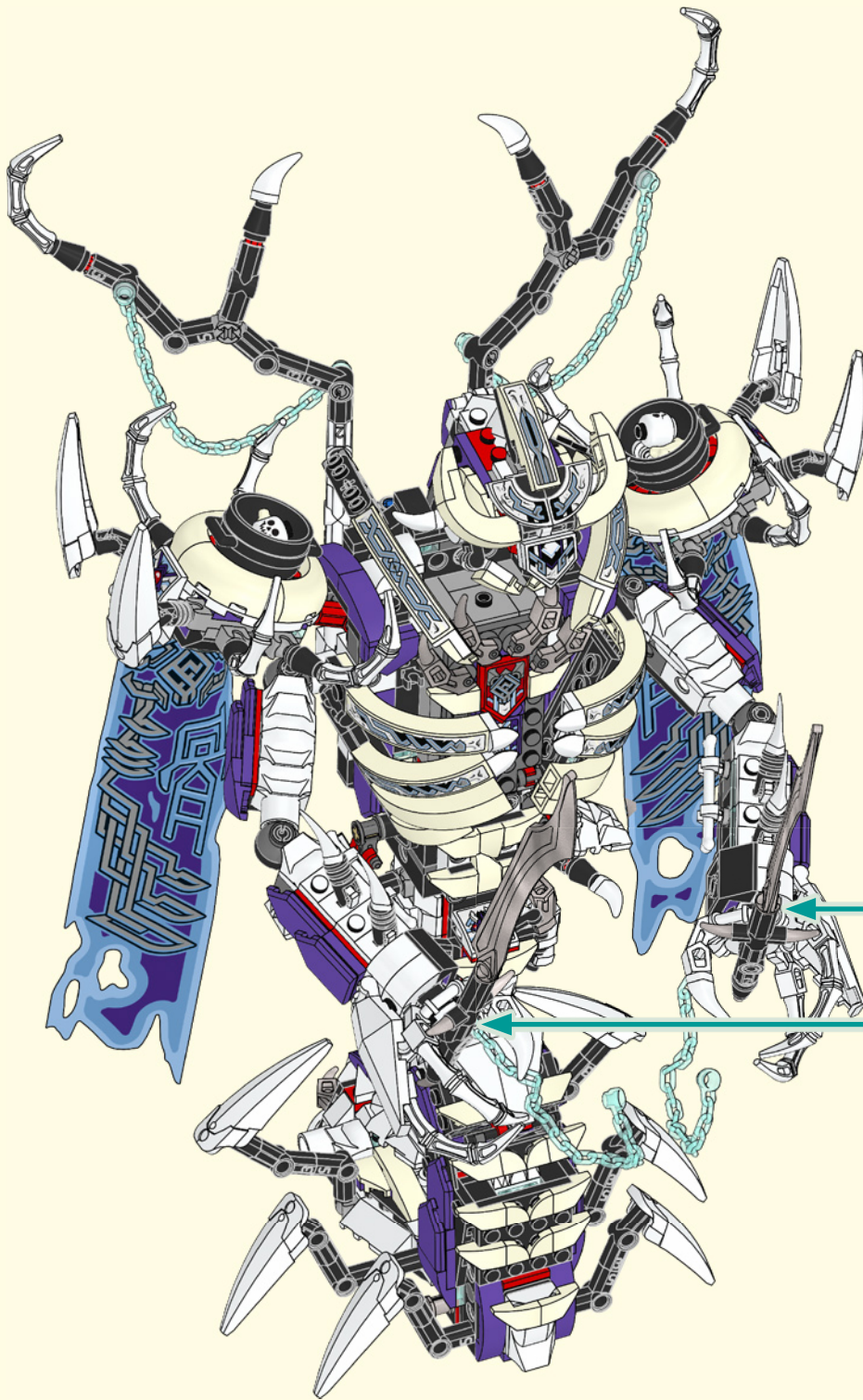

2x

80020



80019



80023



80021



80022

80024



80018



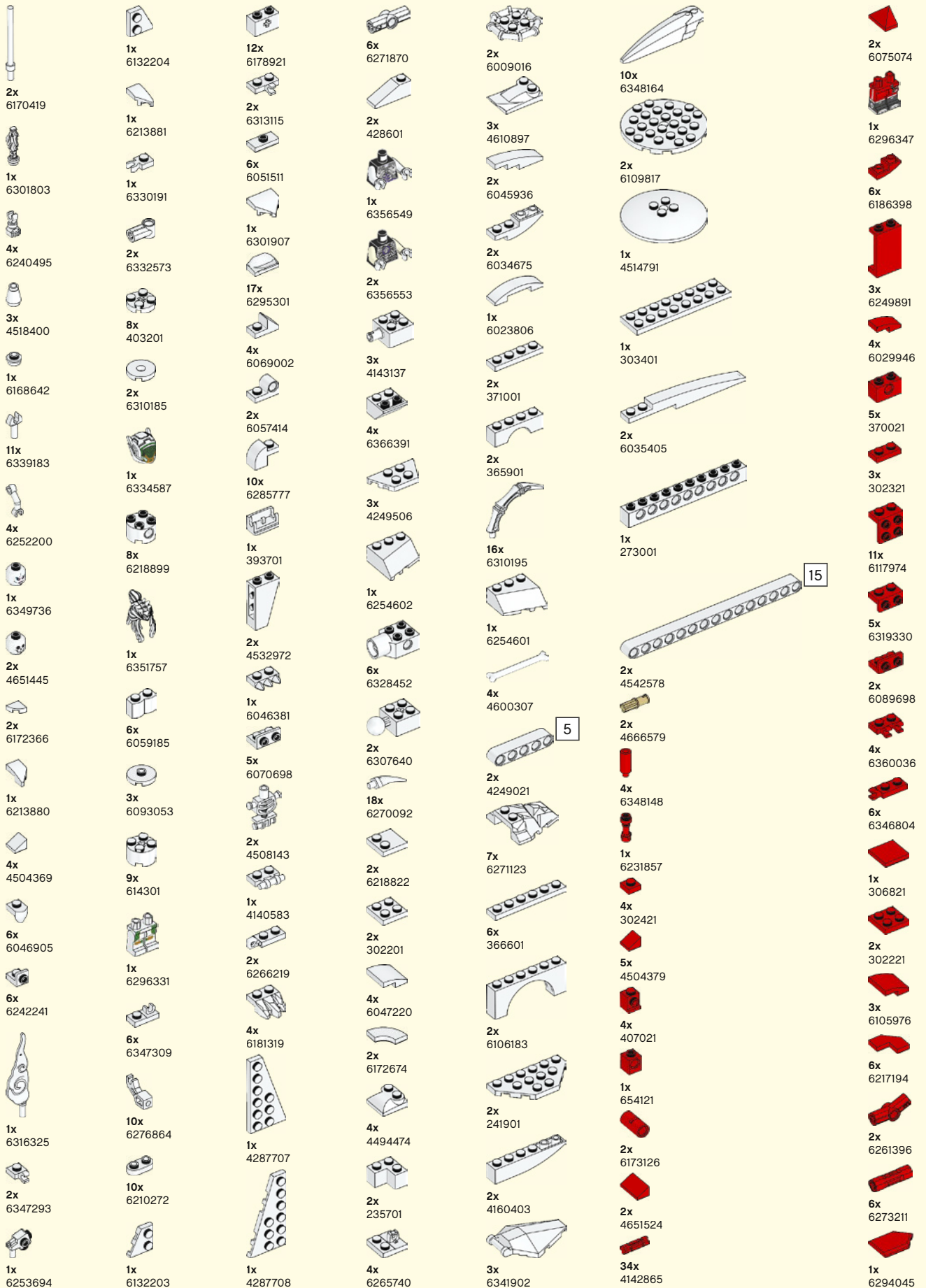



6

4





1x
6276848

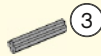

2x
4211815



16x
6043639



2x
4654577



2x
4558169



3x
4211396



1x
6356172



1x
6262961



1x
6170385



1x
6079461



2x
6105964



2x
4211452



1x
6245283

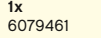

1x
6276870



1x
6240515



2x
6265669



2x
6265669

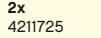

2x
6265669



2x
6265669



2x
6265669



2x
6265669



1x
6133805



4x
6236454



6x
4206482



2x
6299413



1x
6296303



1x
6334588



2x
4504381



4x
4540384



4x
302224



4x
6079007



1x
6356268



1x
6349463



4x
6293280



2x
6355014



1x
6296942



1x
6293265



6x
6336970



4x
6284596



4x
6271752



2x
6245283



2x
6276870



2x
6265669



2x
6056296



2x
6115080



2x
6360111



2x
6364352



2x
6005331



1x
6266248



6x
4210762



4x
6039479



2x
6265693



1x
6359227



3x
4210660



2x
6123814



4x
6177079



1x
6167281



4x
6267047



1x
6332623



7x
6039482



2x
4211105



4x
6279898



4x
4211065



4x
4211065



4x
6083620



2x
4508553



1x
6186825



1x
4595710



8x
4655695



6x
6351826



1x
6353889



4x
6182217



8x
6047422



12x
6167461



7x
6307235



19x
6245266



4x
6103449



2x
4225142



2x
6069012



4x
6346521



2x
6251900



13x
6030277



2x
6109819



2x
6109819



2x
6109819



3x
6250233



2x
6031821



2x
6075287



1x
4211186



2x
6138513



1x
6339329



1x
6301802



4x
6240206



2x
6274711



2x
4529247



3x
4523159



2x
6186672



2x
6283475



2x
6262138



2x
4490599



1x
6303532



10x
6283590



8x
6171733



2x
6245307



30x
6240222



30x
6240222



1x
6311467



1x
6244733



1x
6170187



1x
6334268



4x
6365807



10x
4633691



18x
6270108



8x
6262193



5x
6287673



2x
6093532



2x
4611883



2x
6350510



1x
6347505



1x
6347505



1x
6347505



1x
6347505



1x
6347505



1x
6347505



1x
6347505



1x
6347505



1x
6347505



1x
6347505



2x
6294553



2x
6322830



4x
6339147



2x
6349739



16x
6347942



10x
6347944



3x
6345509



8x
6348163



16x
6347943



4x
6348161



3x
6348767



10x
6347950



MONKIE KID 悟空小侠™



80026

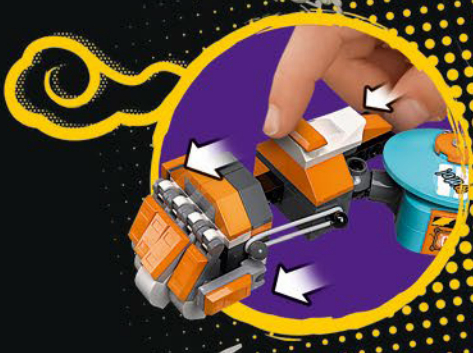

80025



**Brille
dans le noir**

**Glow
in the dark**

Glow in the dark
Leuchtet im Dunkeln
Brille dans la nuit
Si illumina al buio
Brilla en la oscuridad
Brilha no escuro
Világít a sötétben
Tumsa spid
可以在黑暗中发光

80028