



ATLANTIS

8079



1

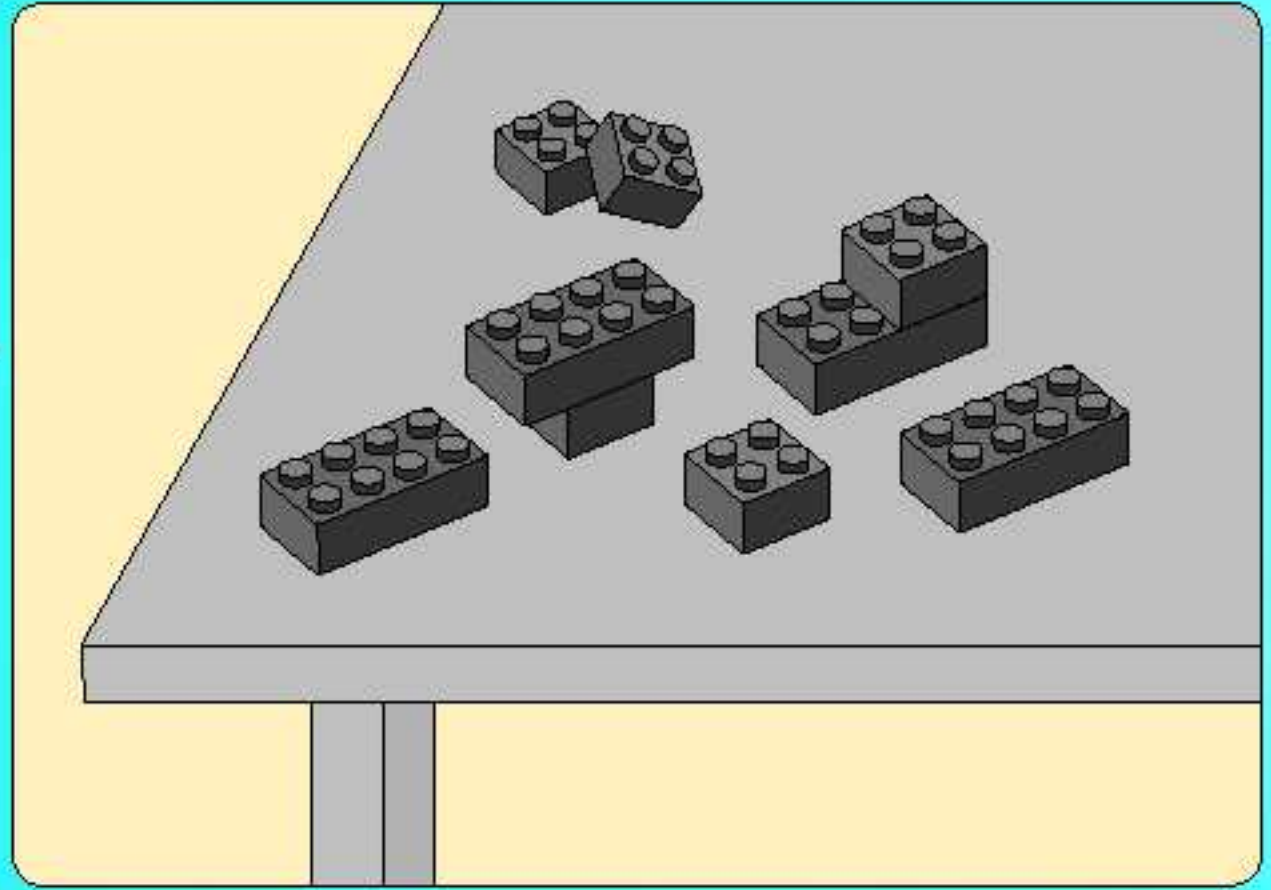
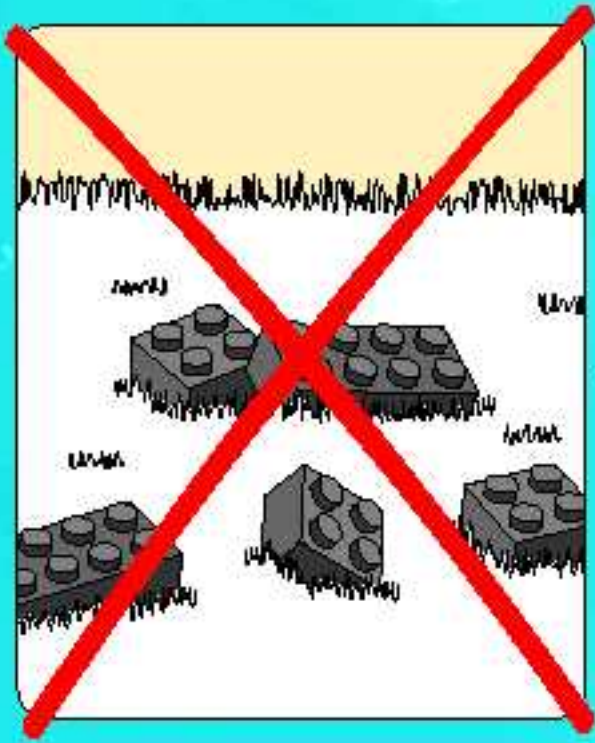

2



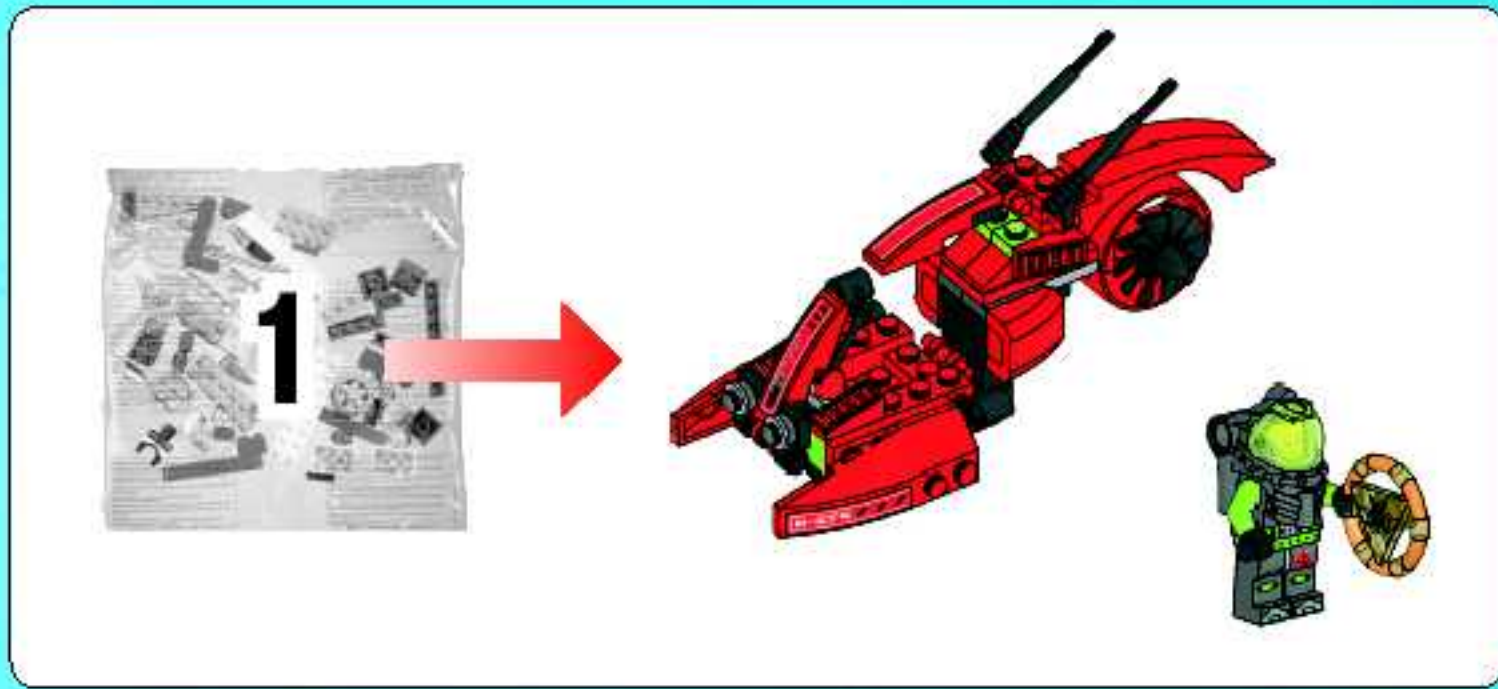

3

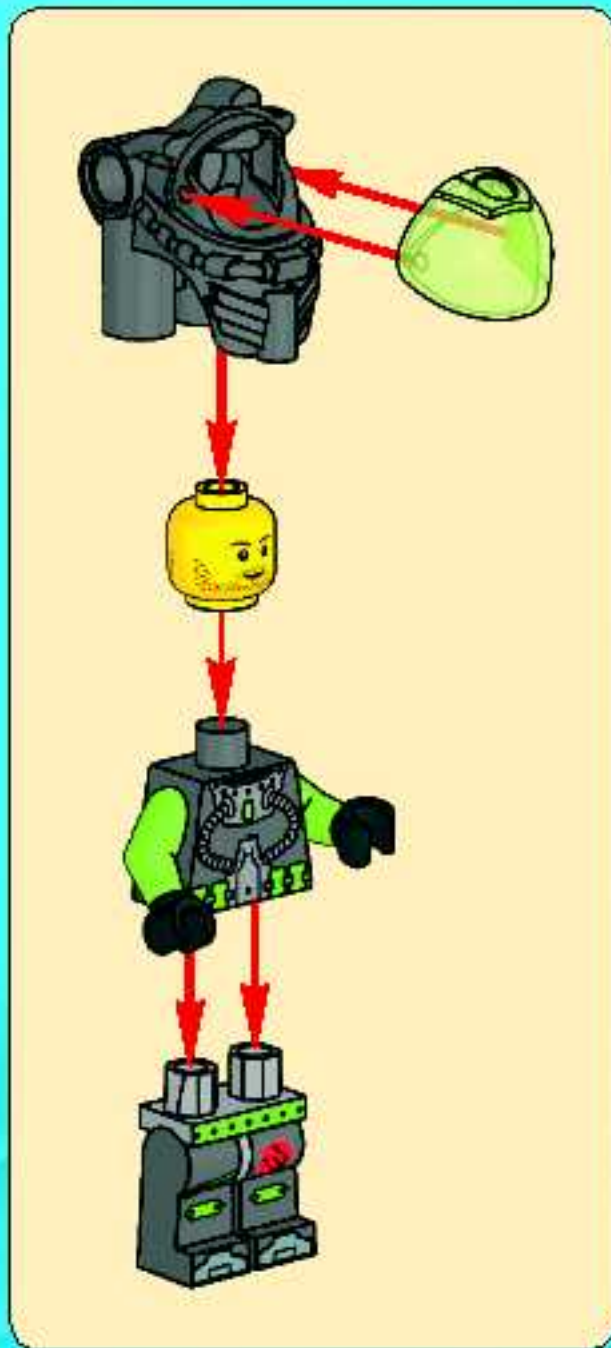

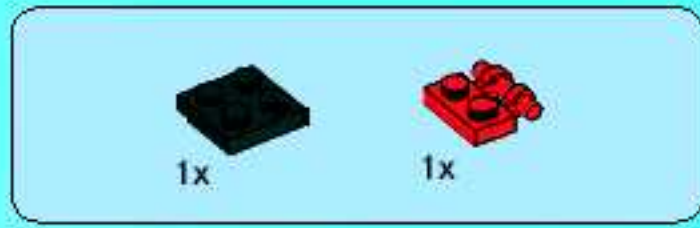

5

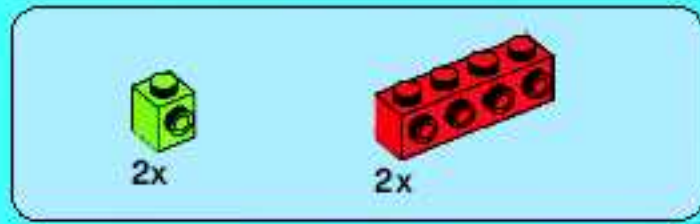
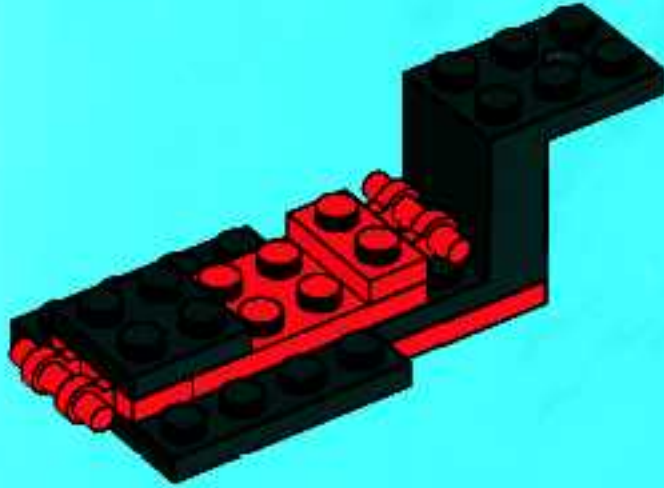

6

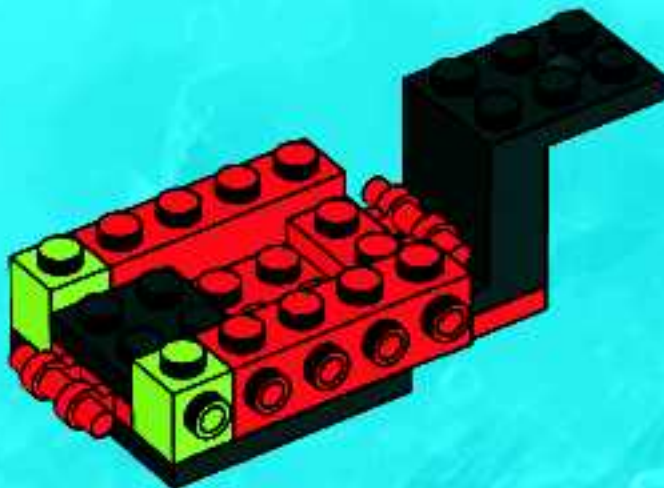

7

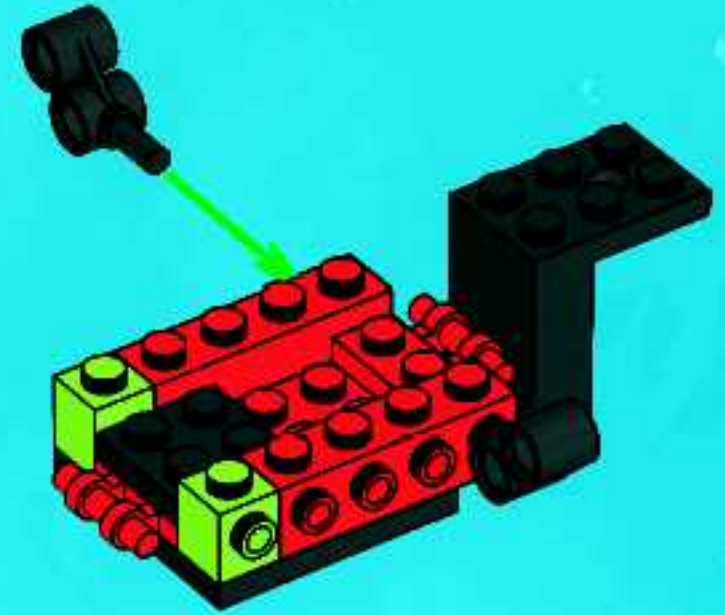

8

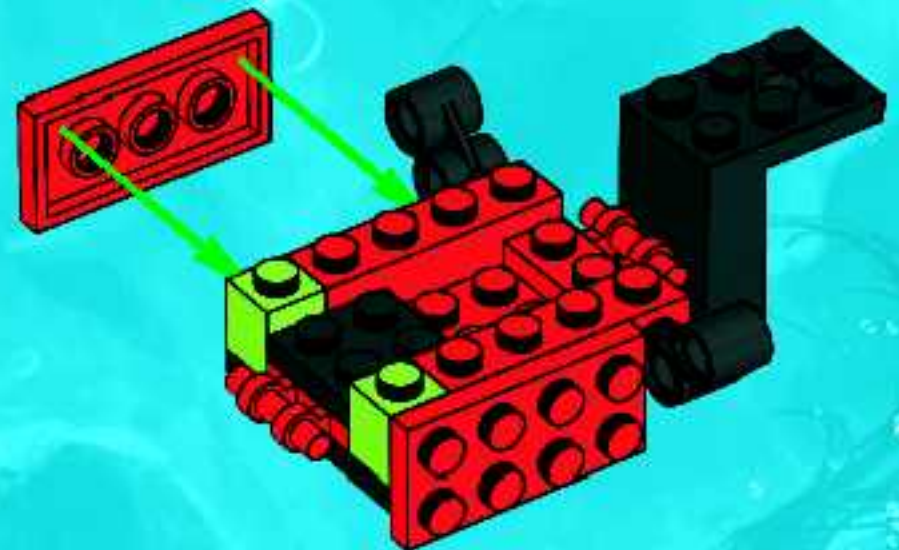

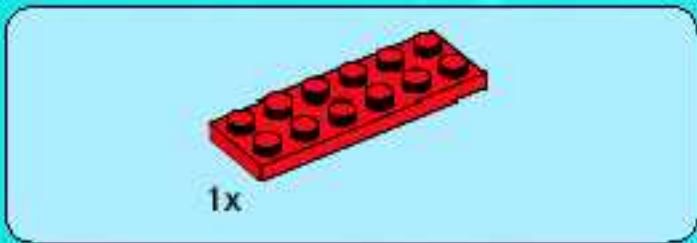
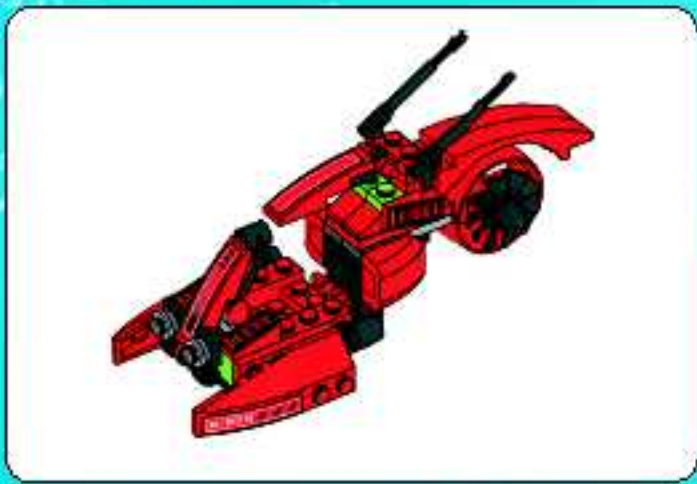

1

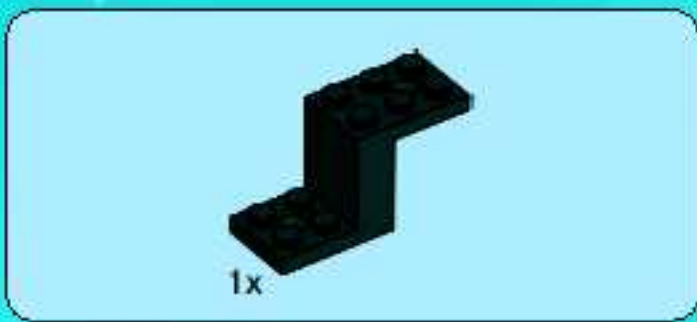

2

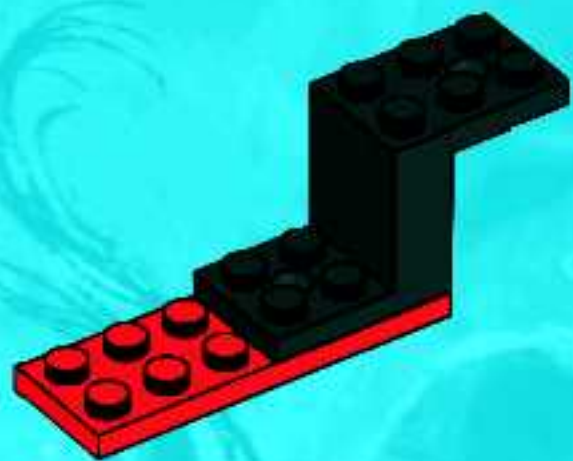

3

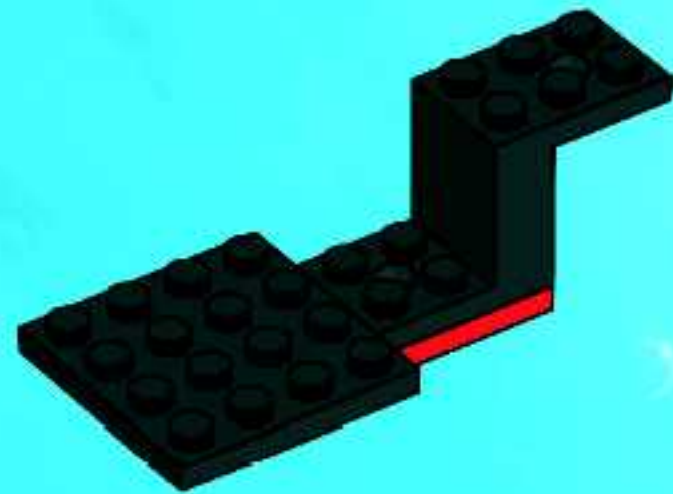

4

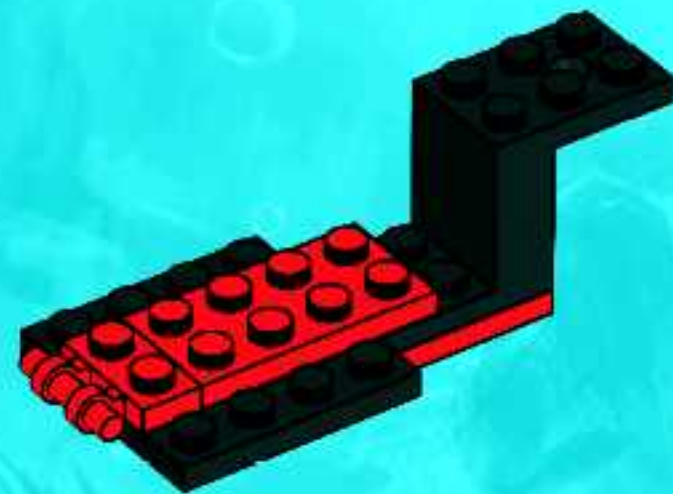



1x



1x

9

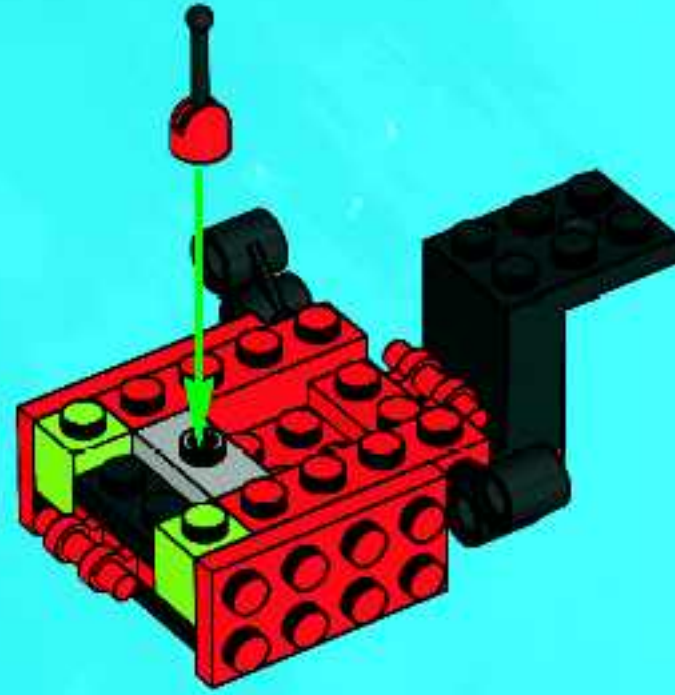

2x

10

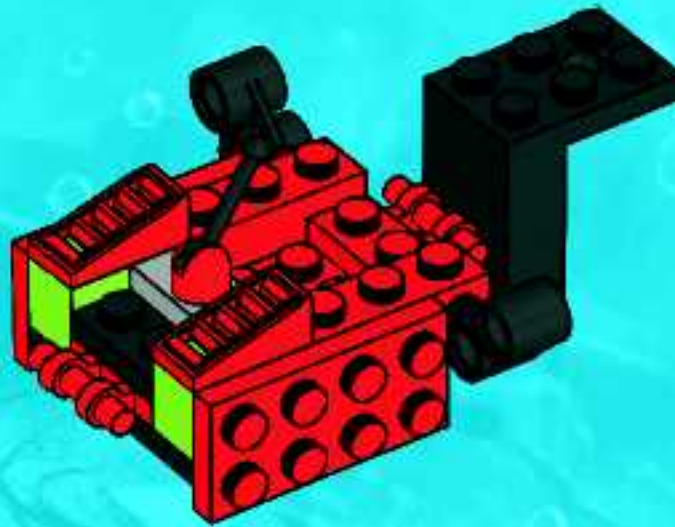

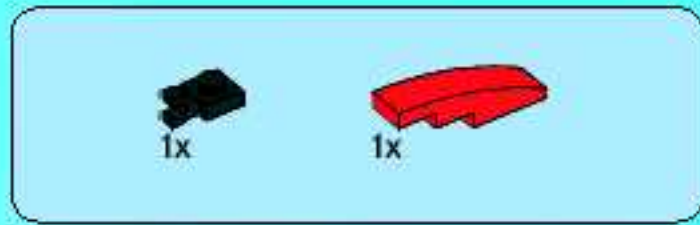

11

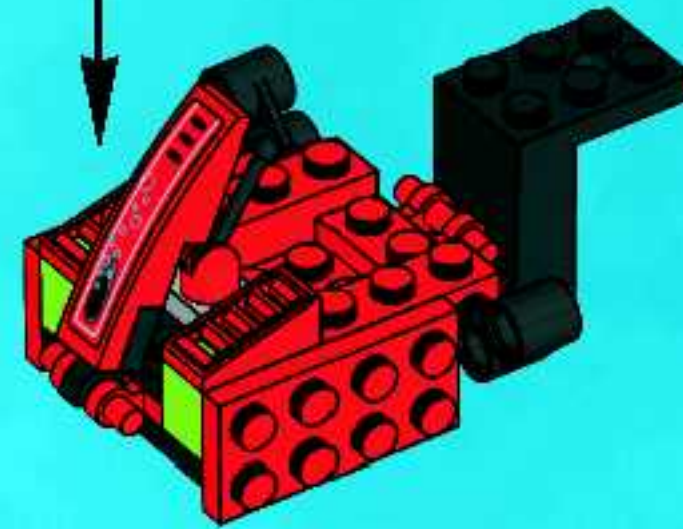
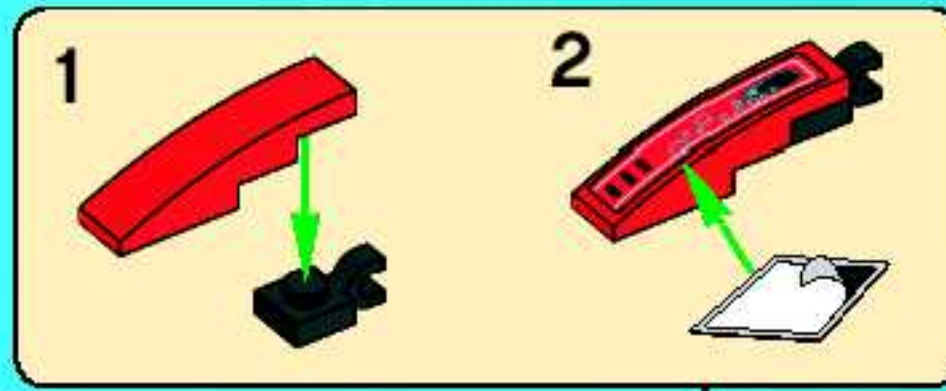

12

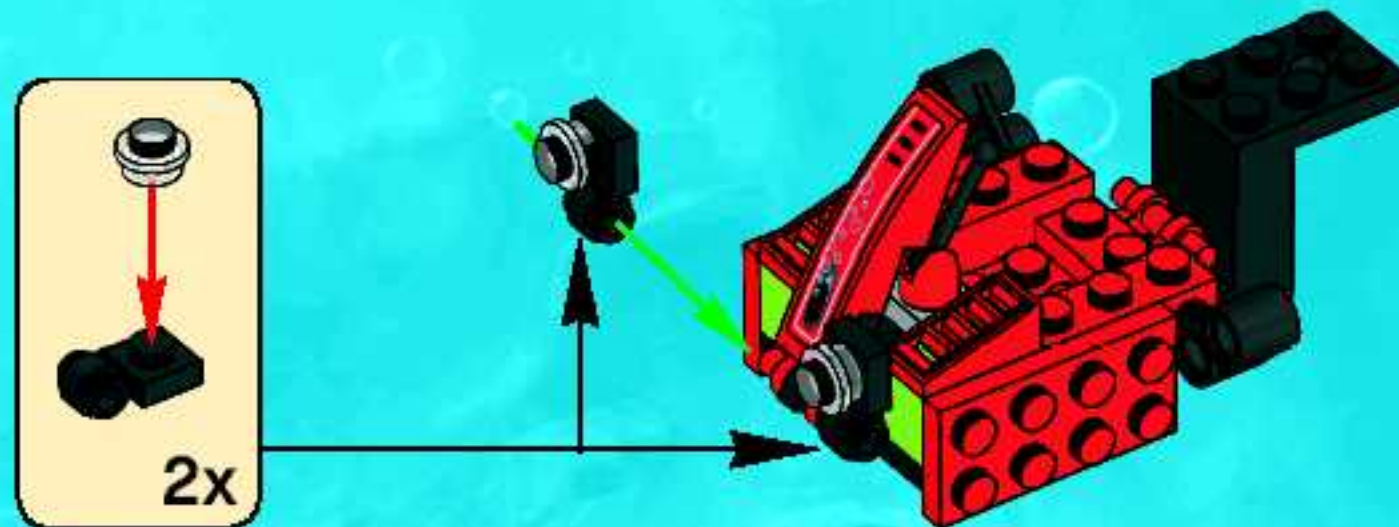

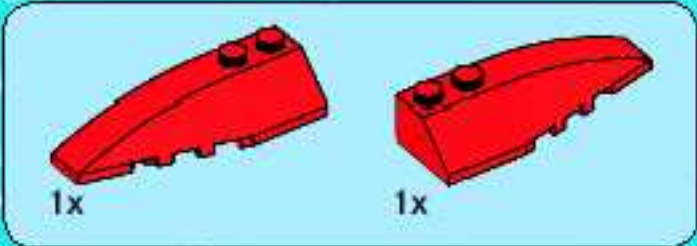

13

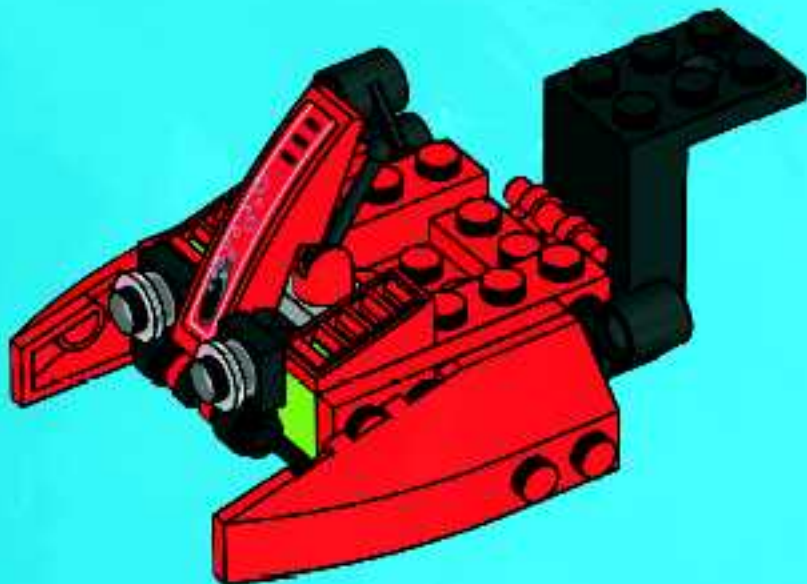

14

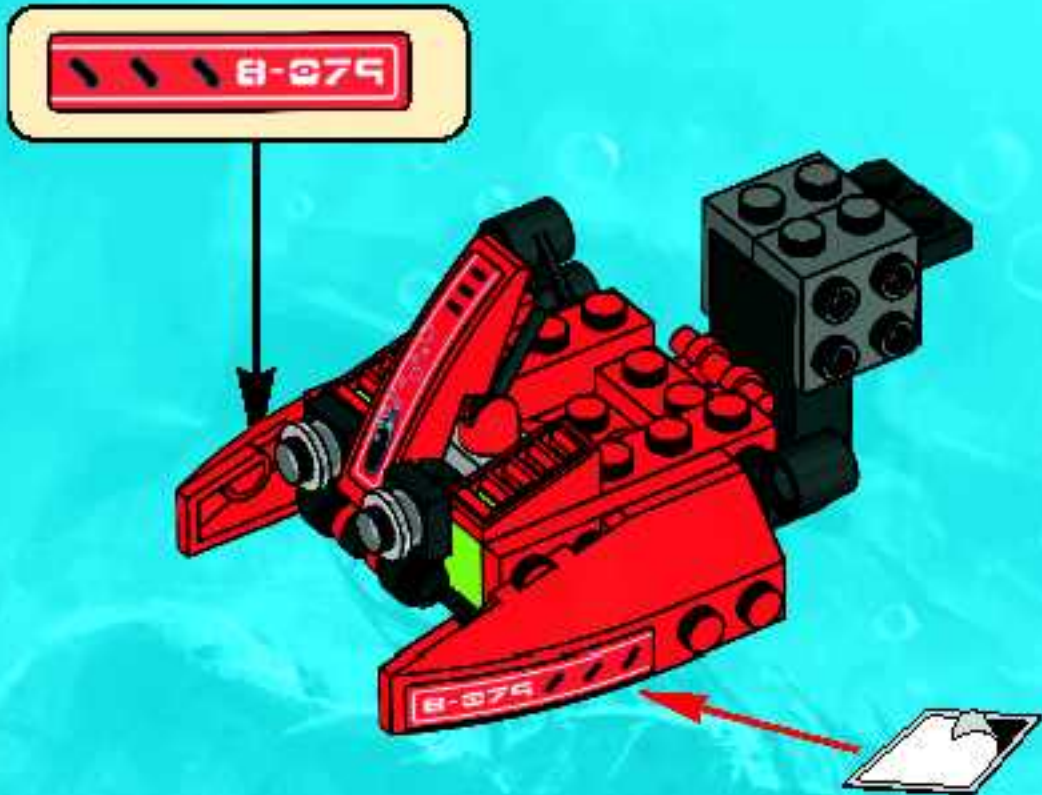

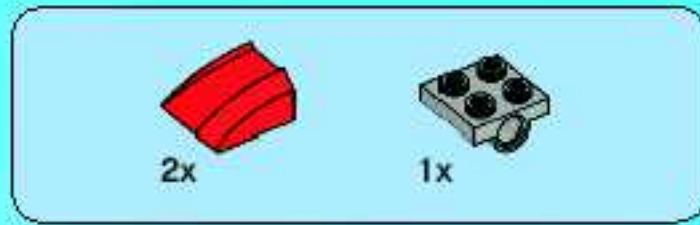

15

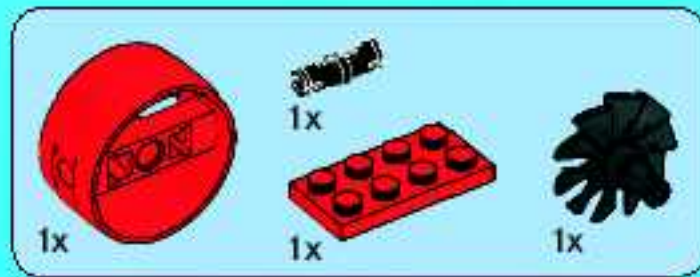
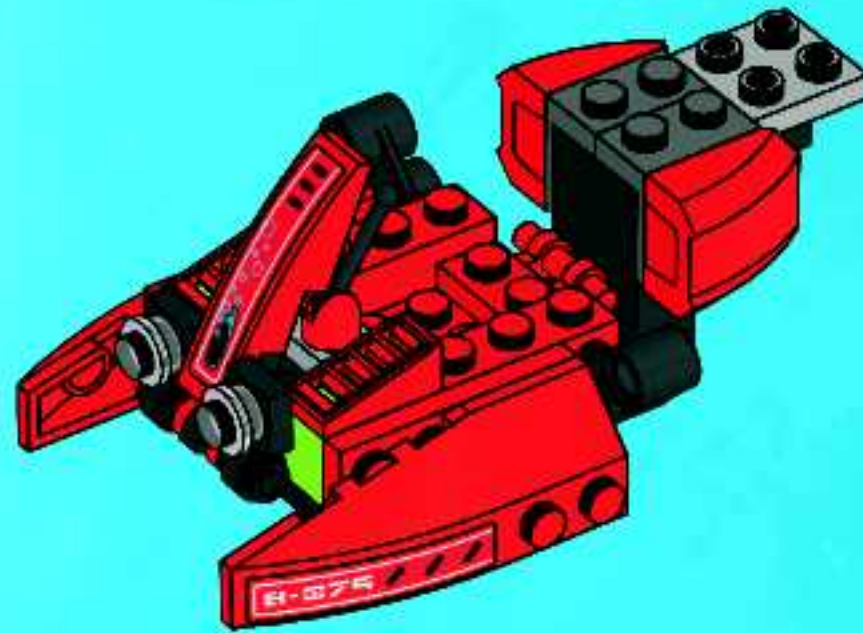

16

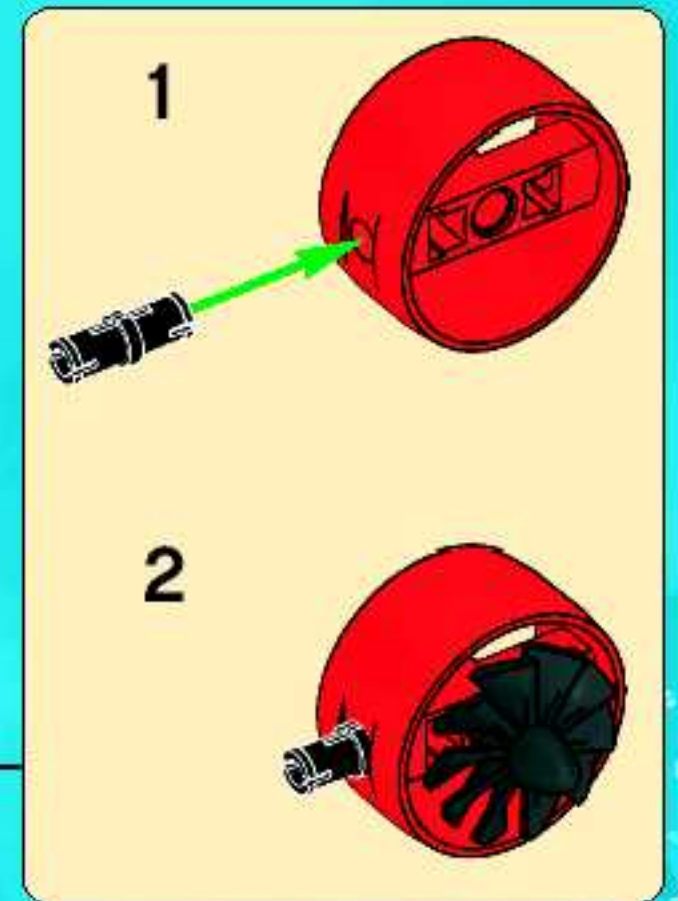
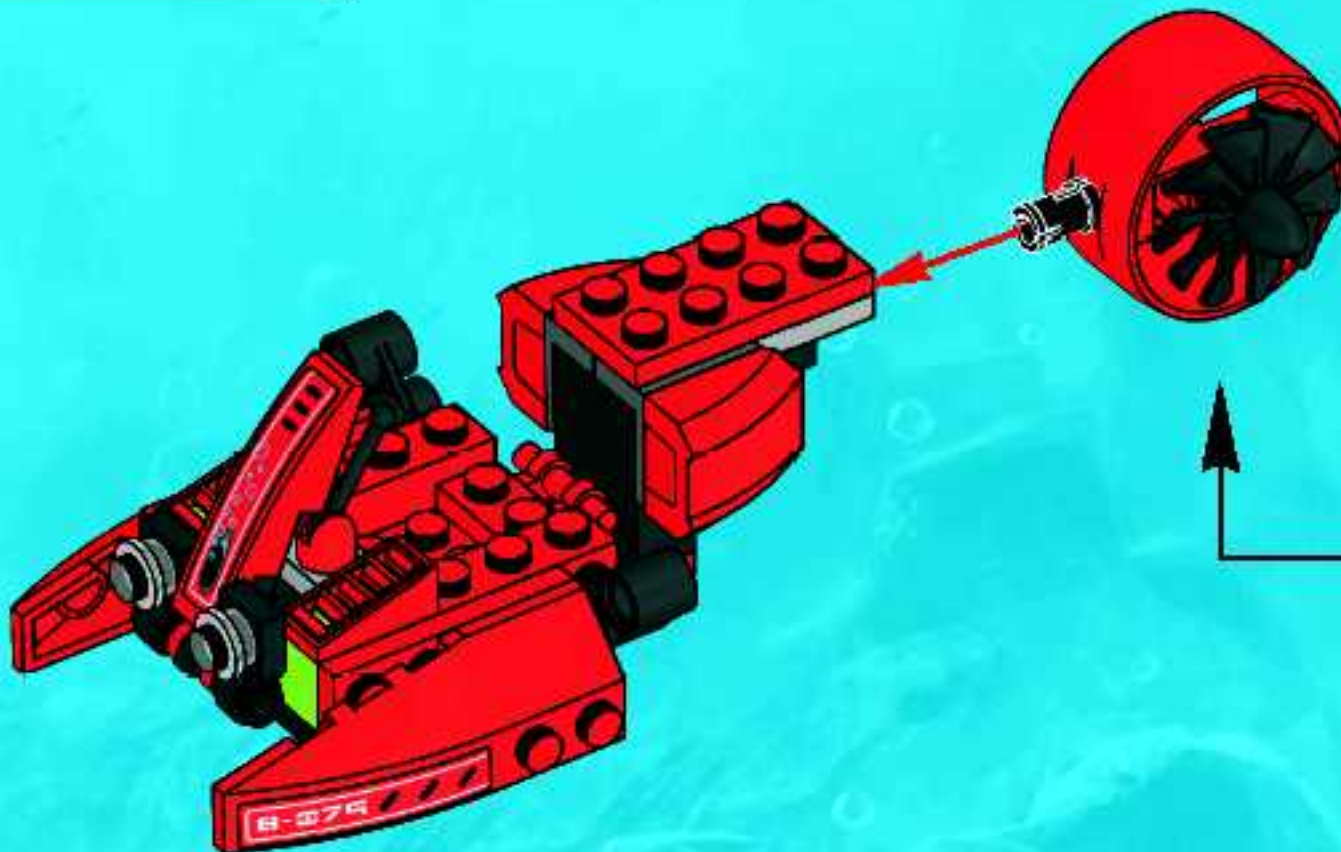



2x



4x

17

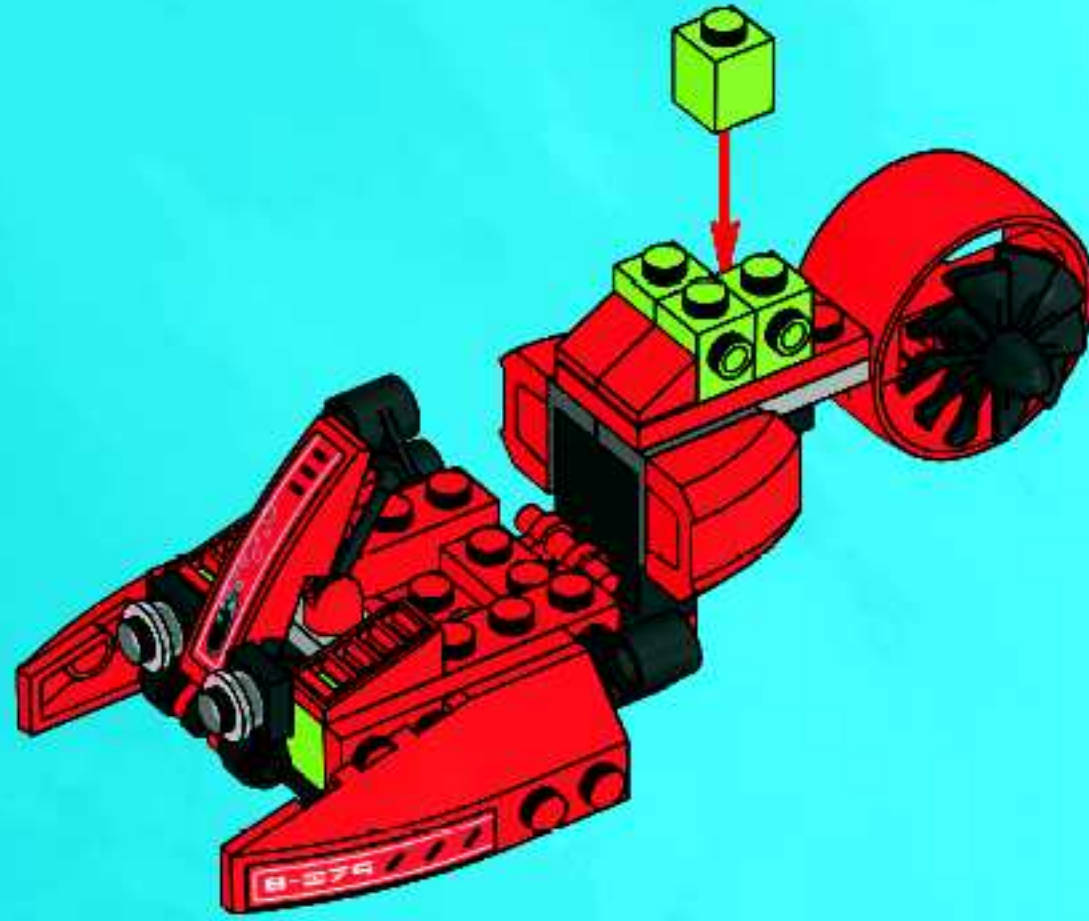

2x

18

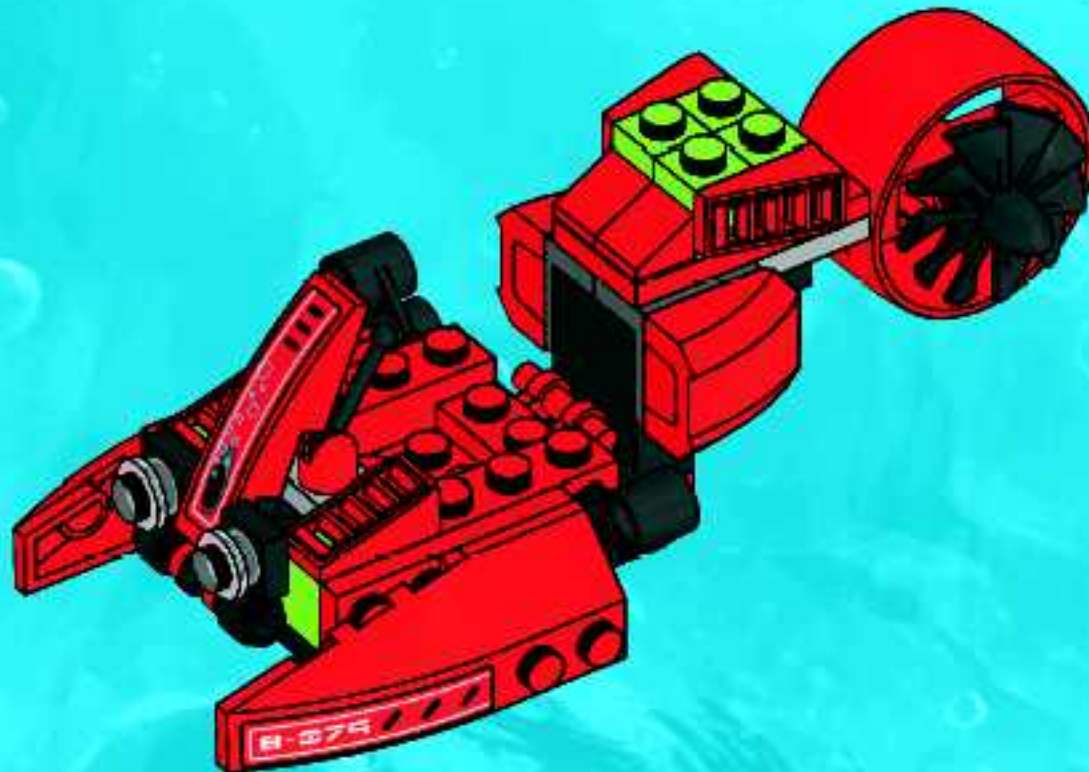

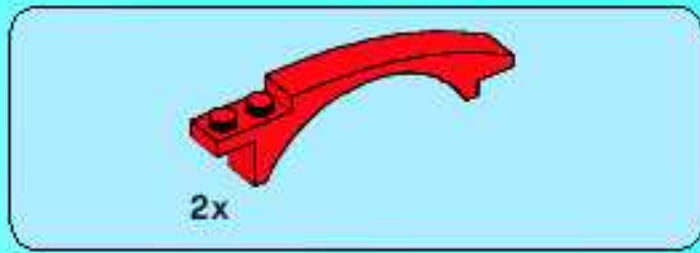

19

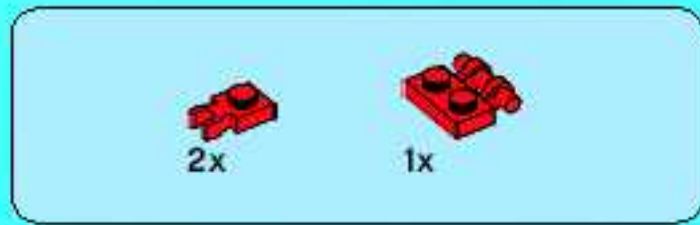
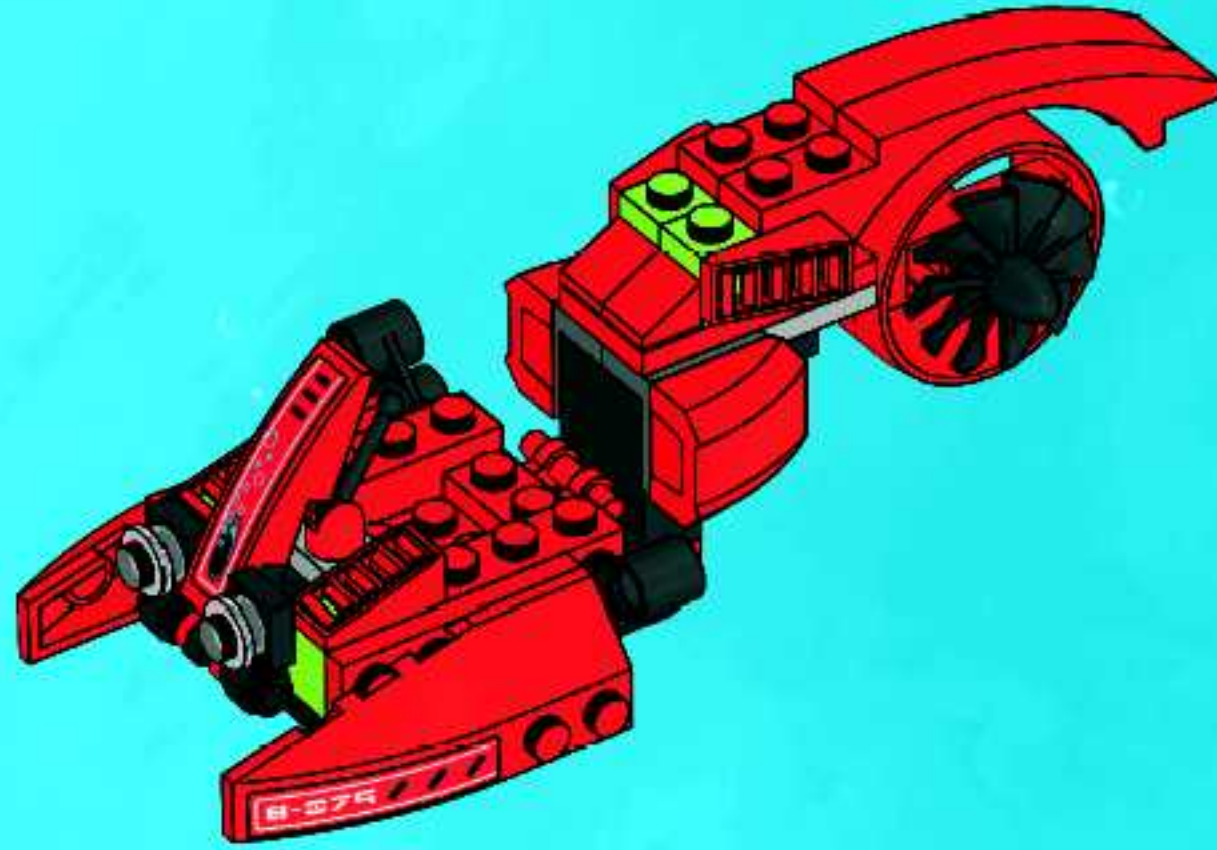

20

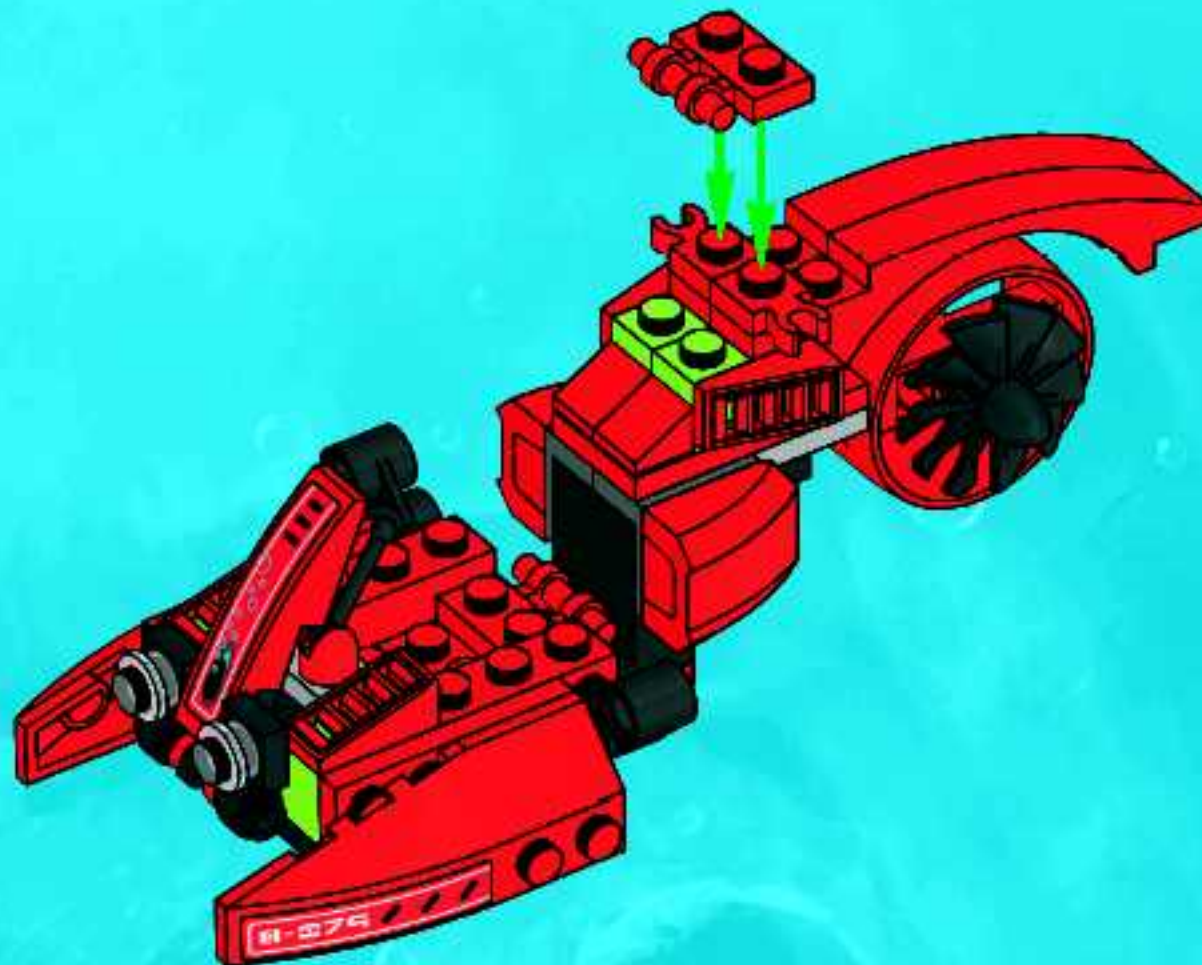



21

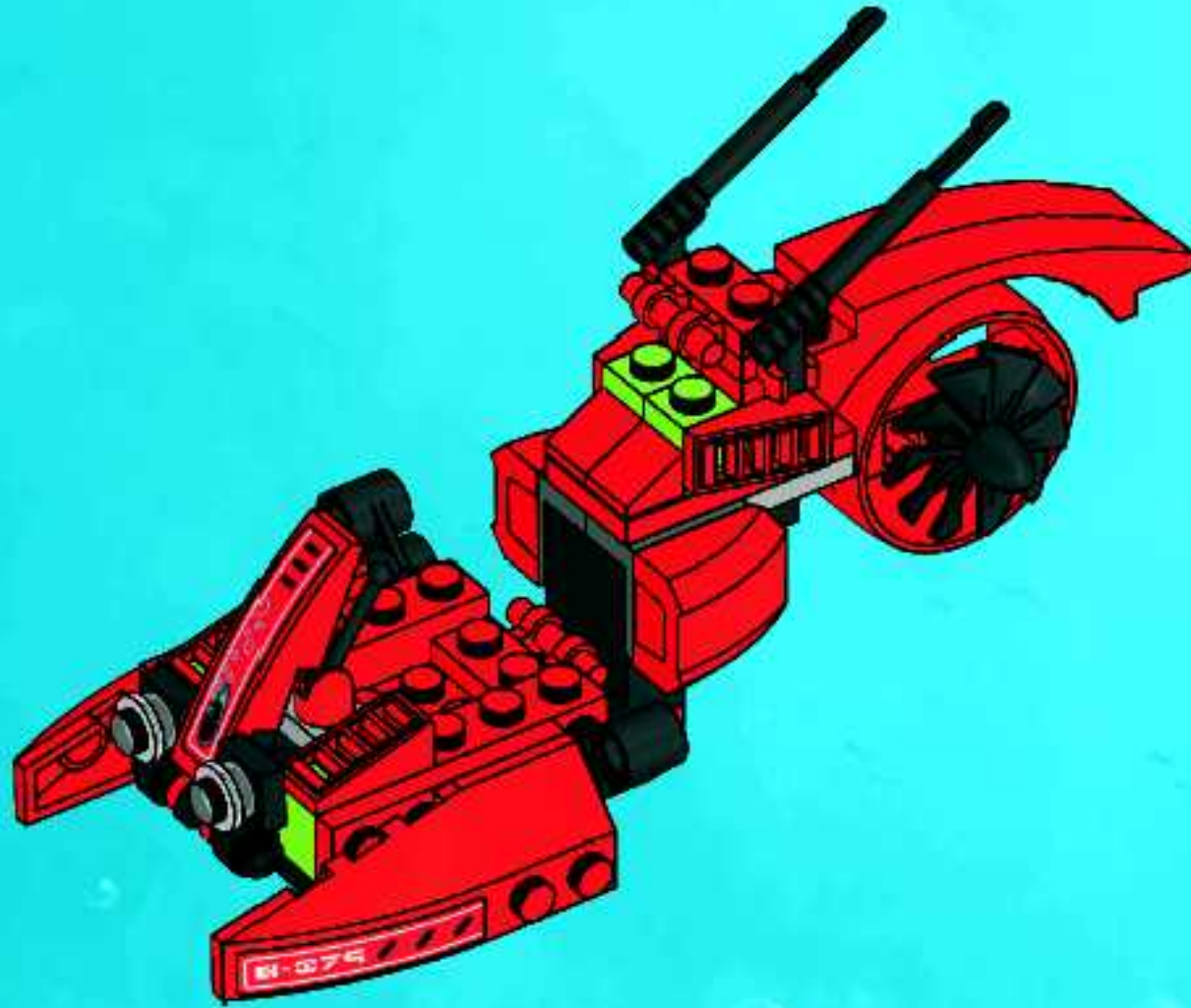



23

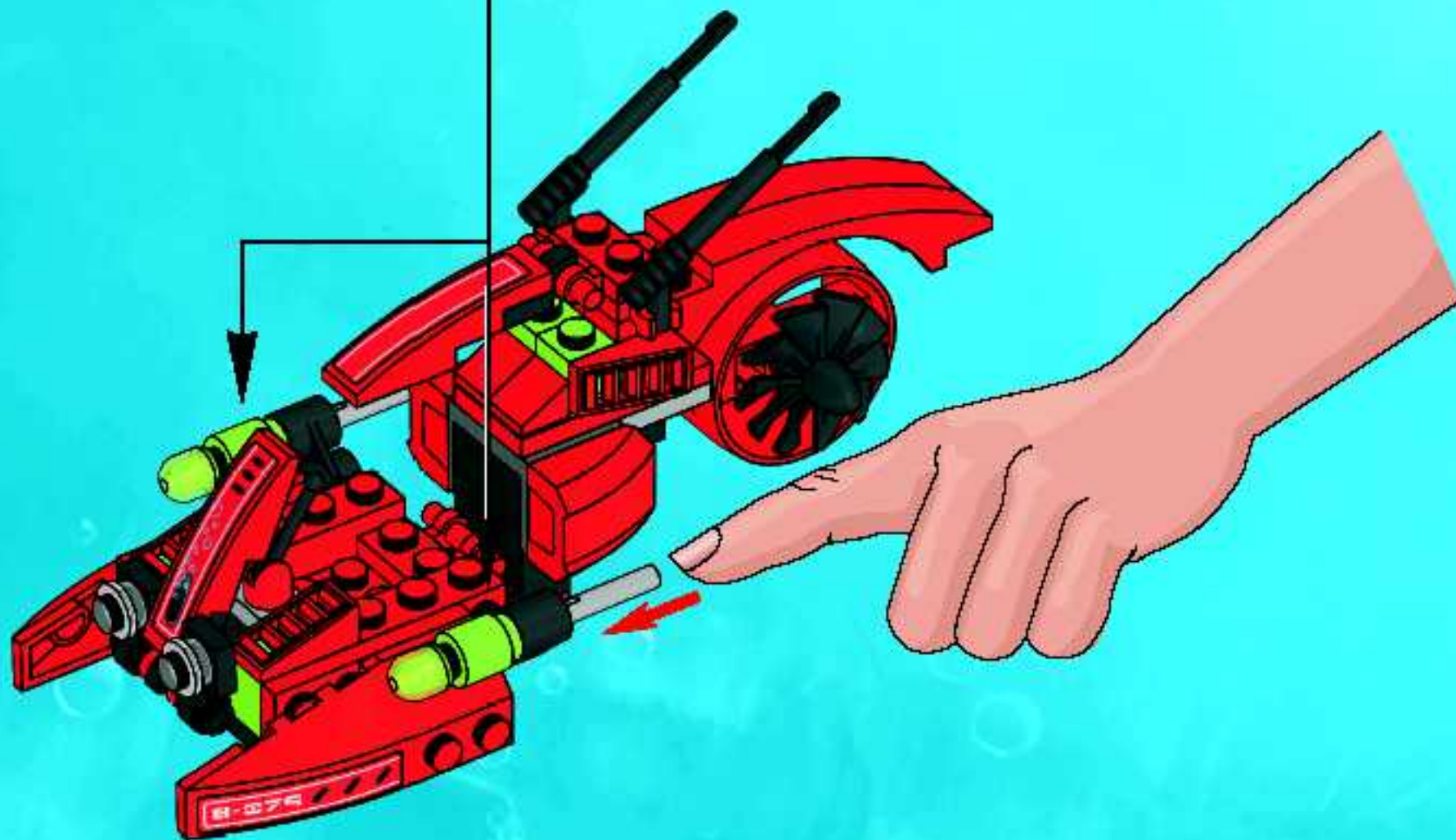
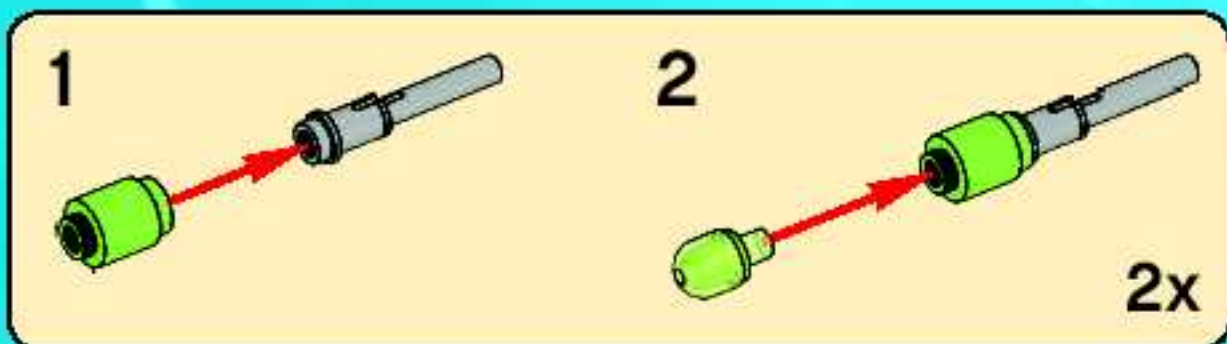

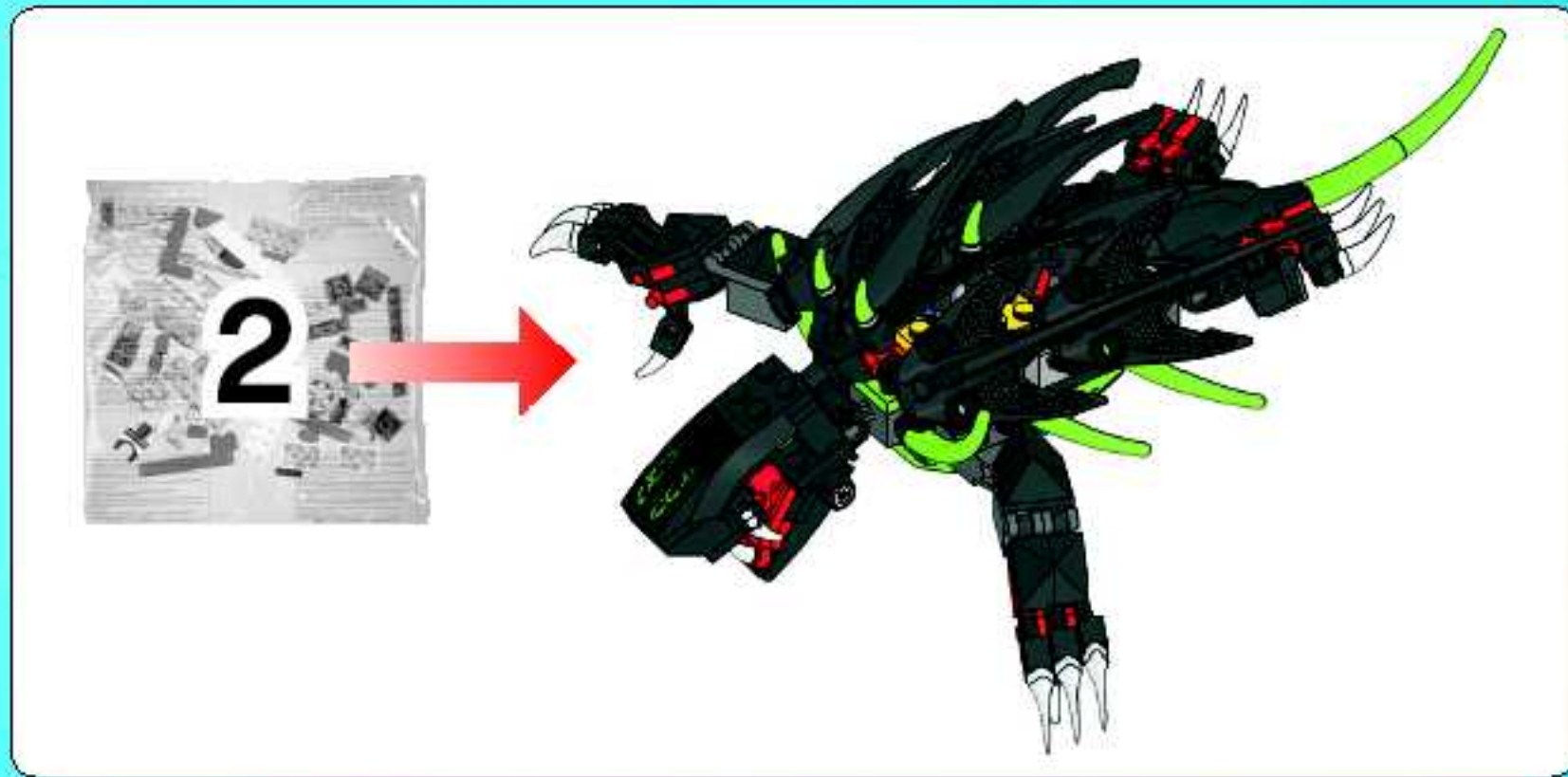

1



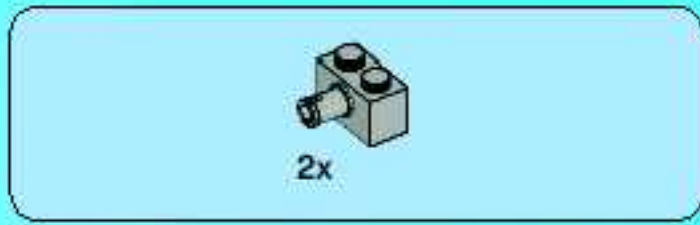

4

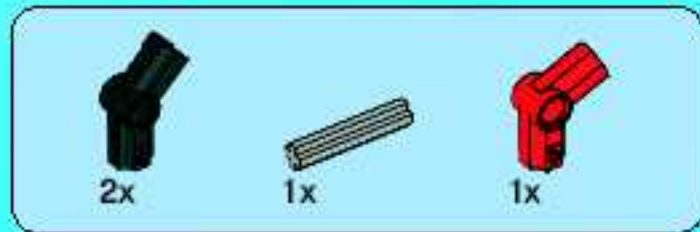
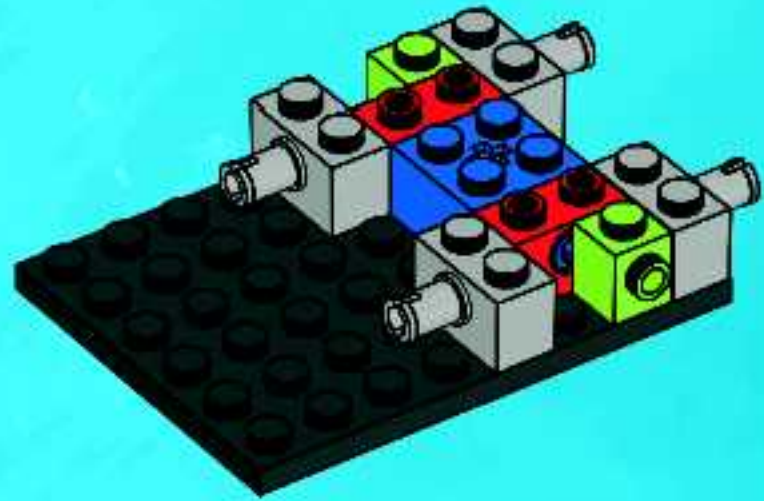

5

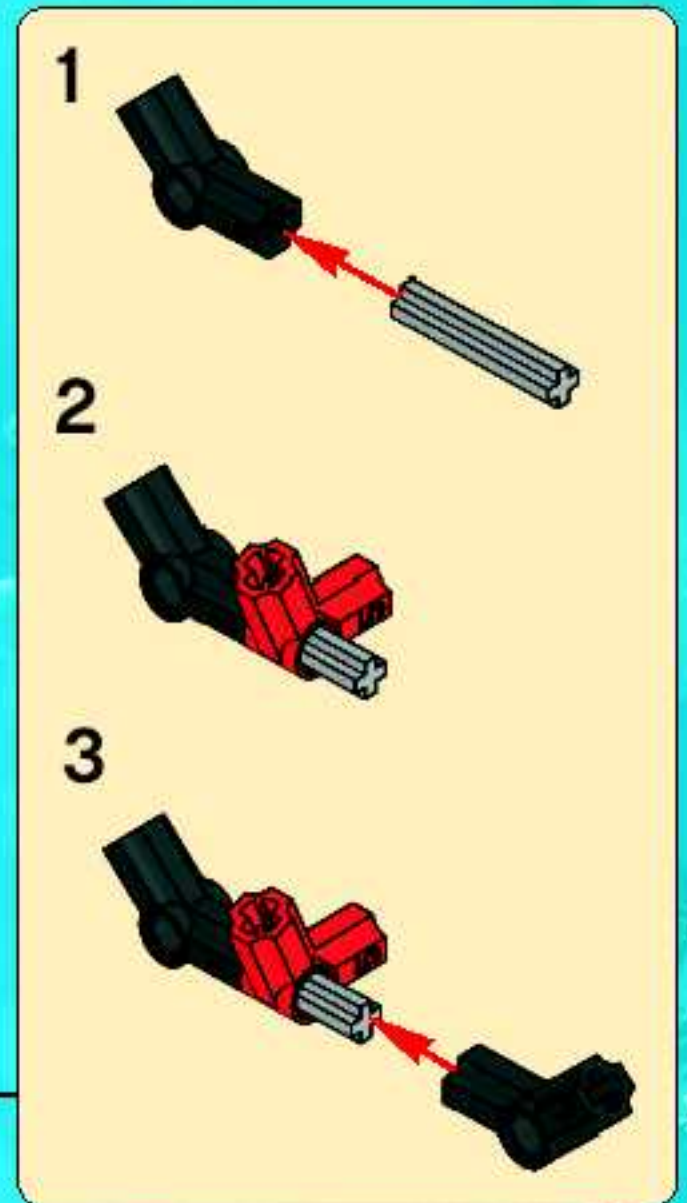
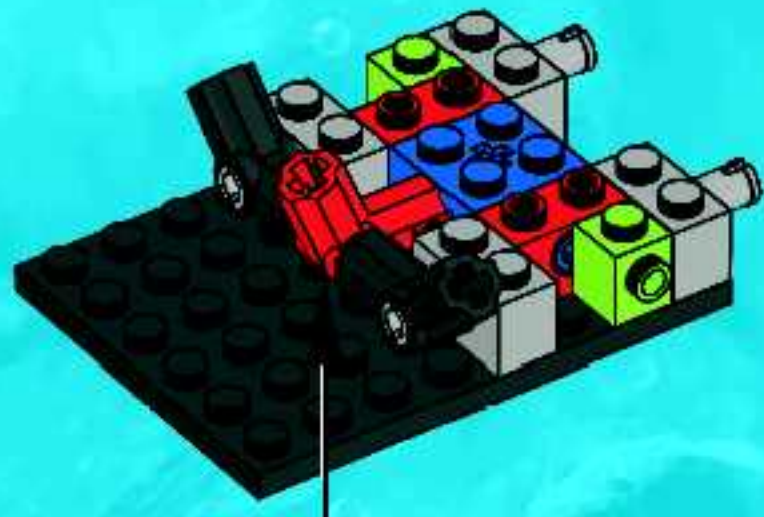



2

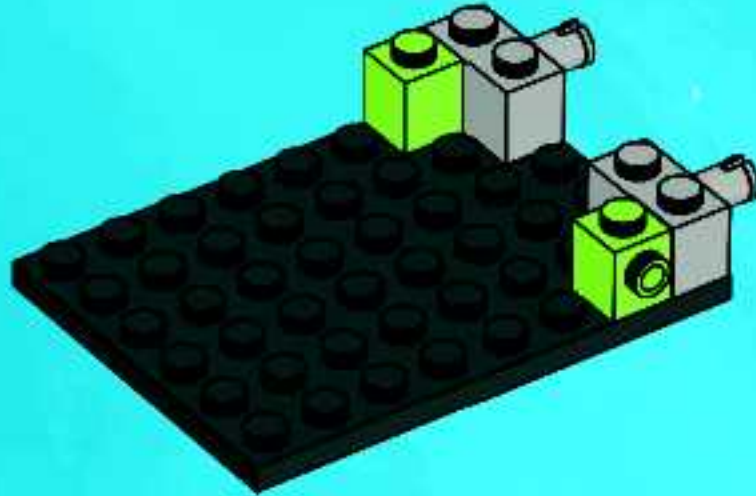

3

1

2

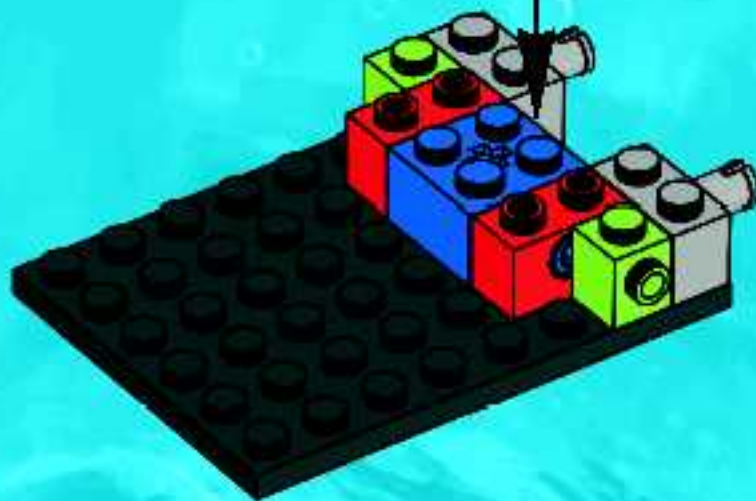
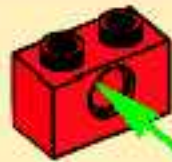



2x

6

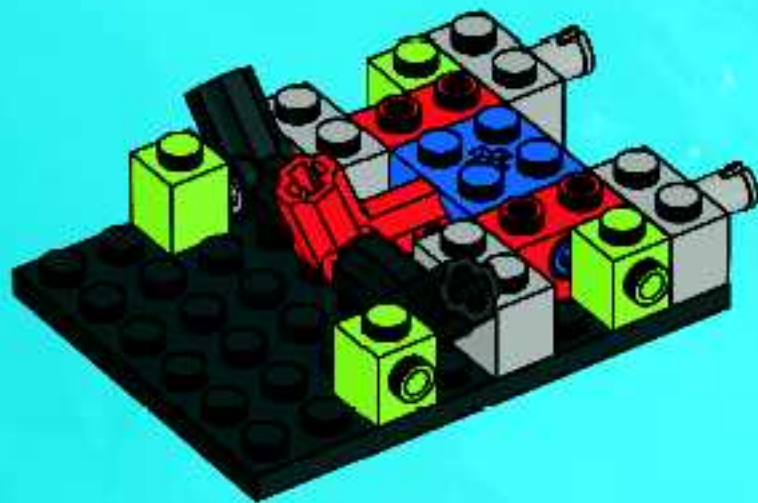

1x



2x

7





8

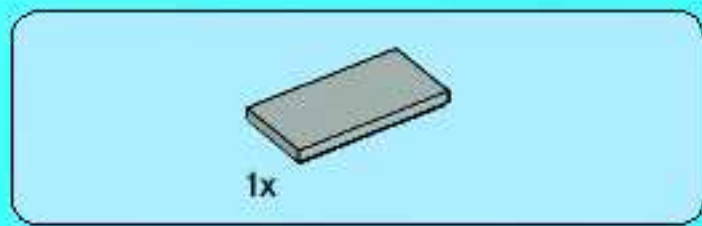
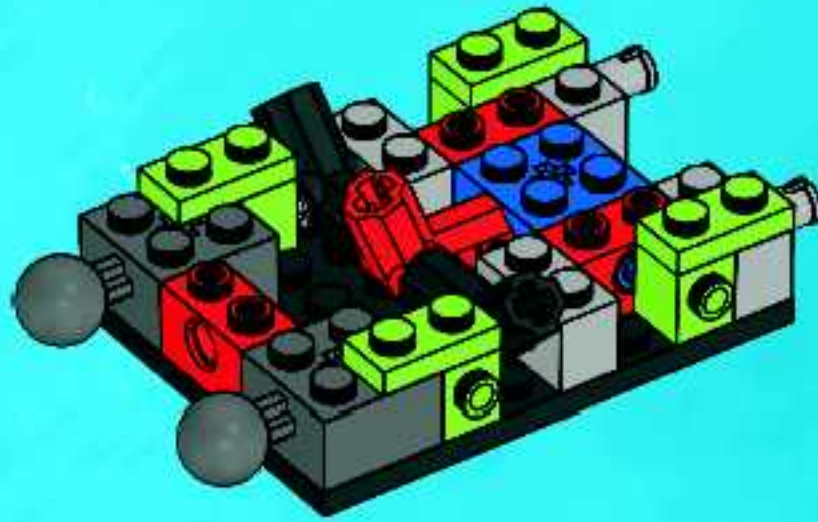

9

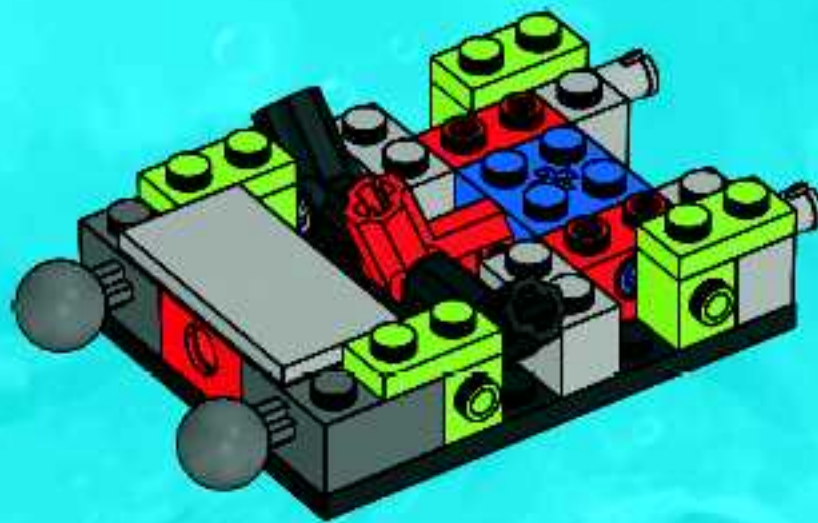

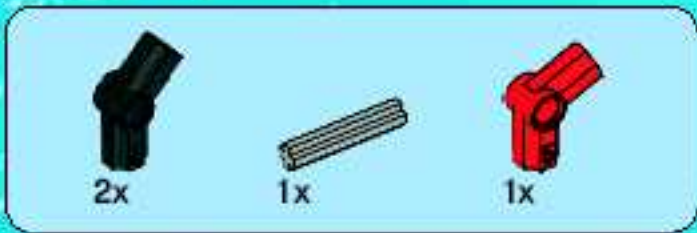

10

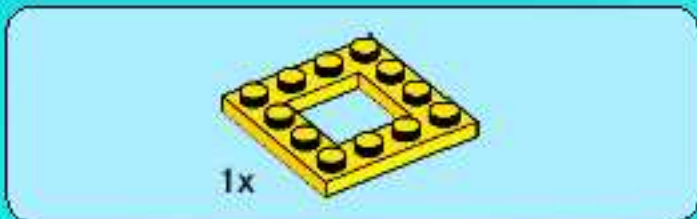
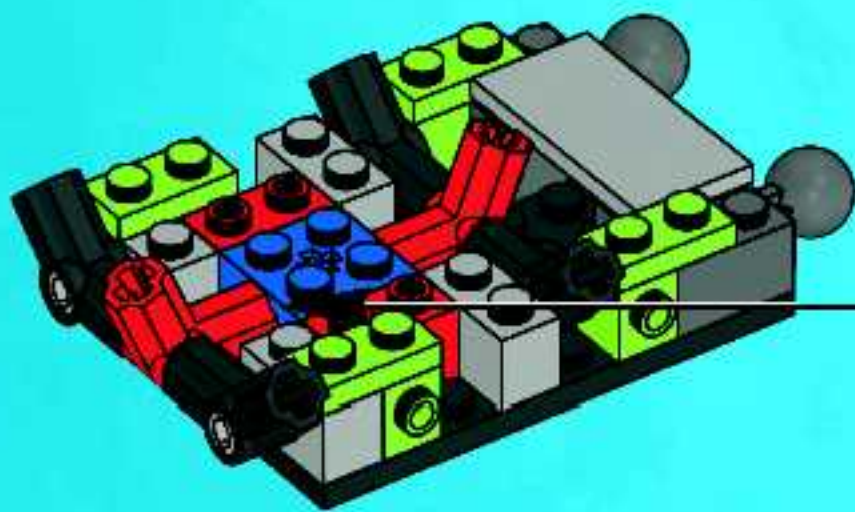
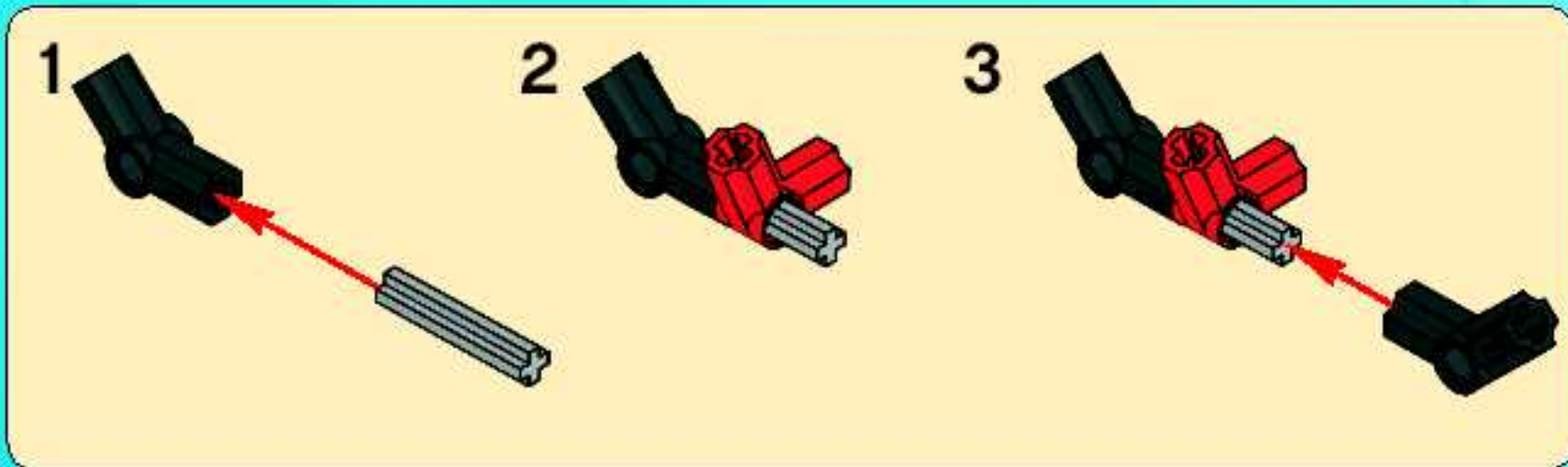

11

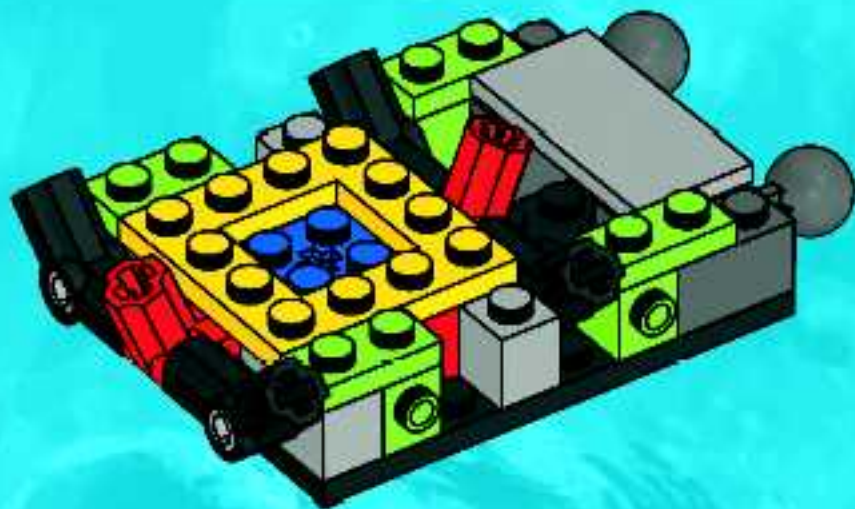

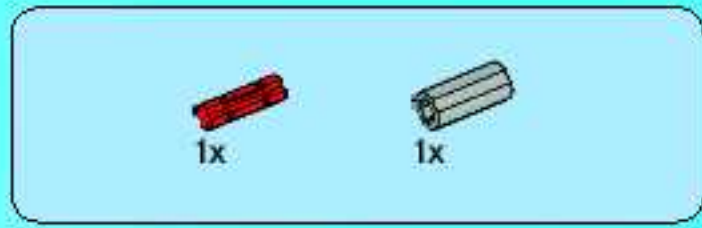

12

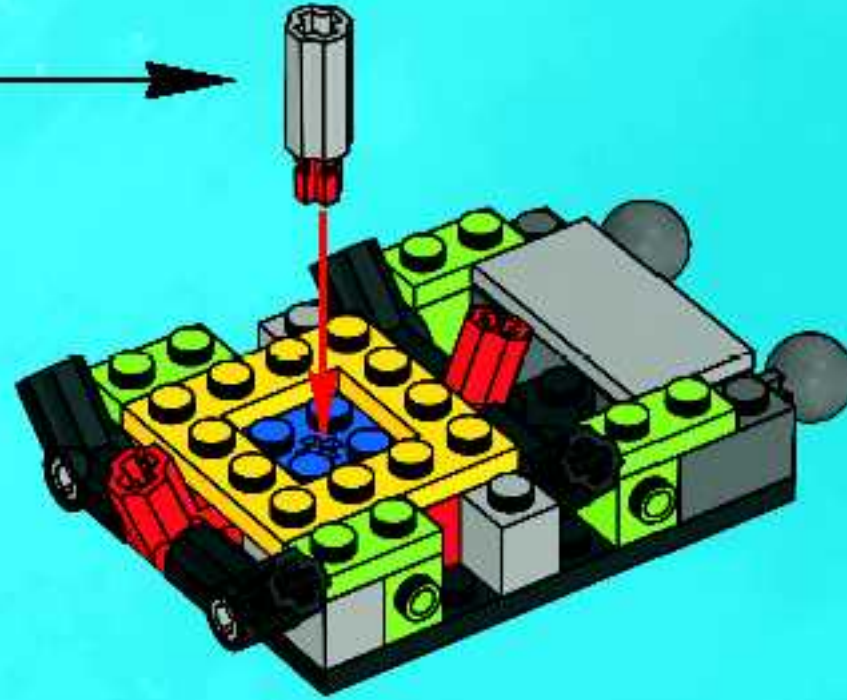
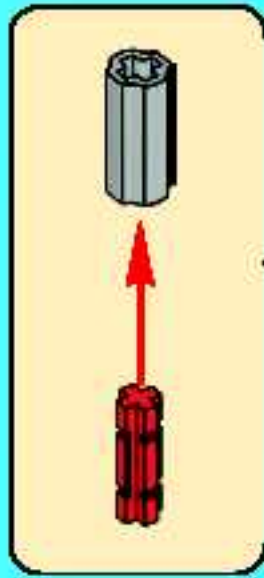

13

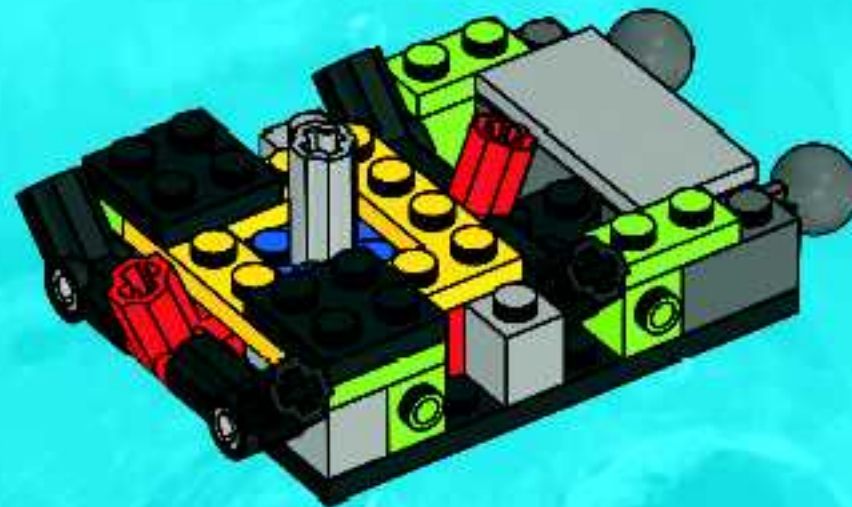

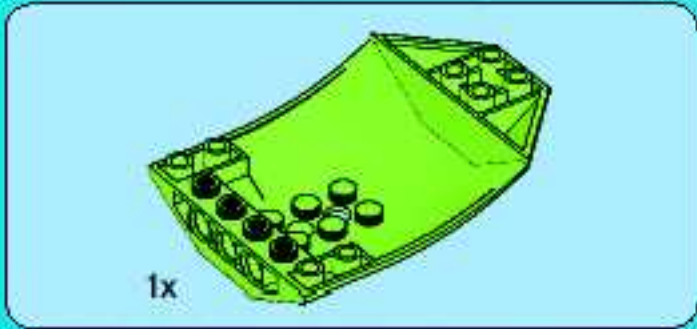
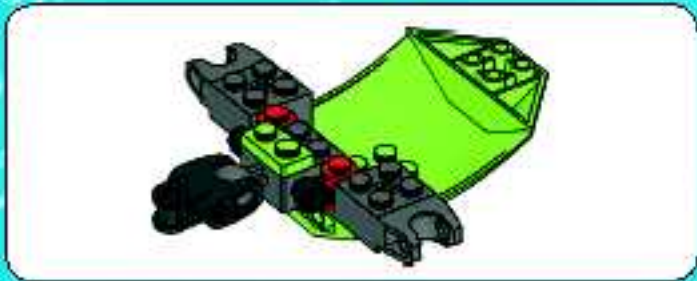

1

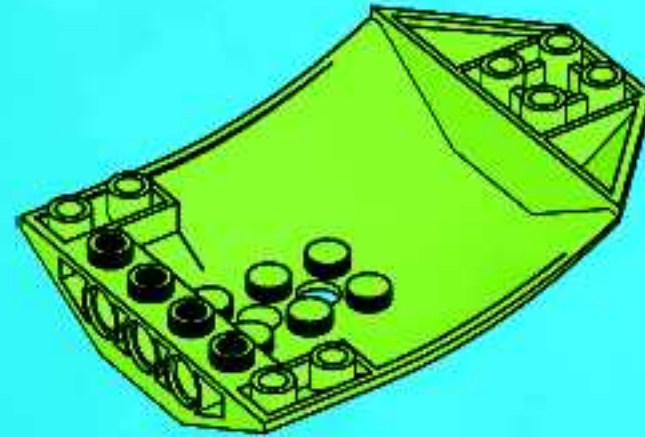

2

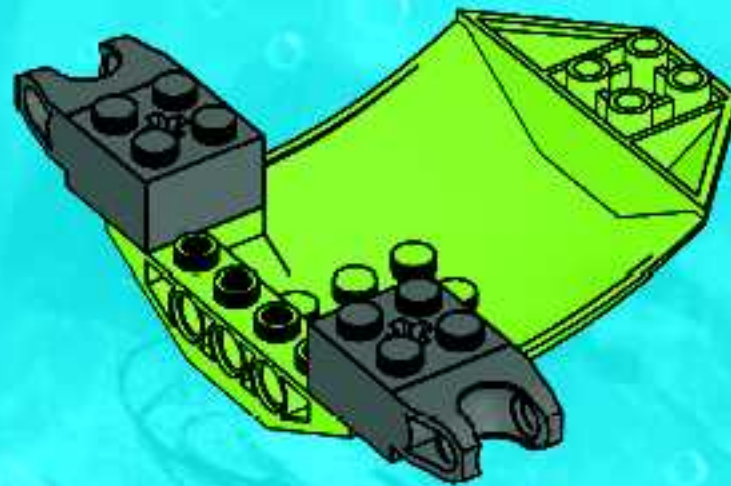



3

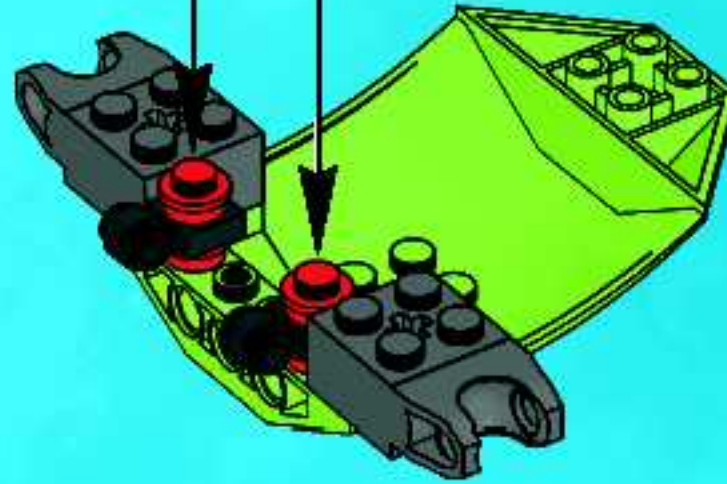
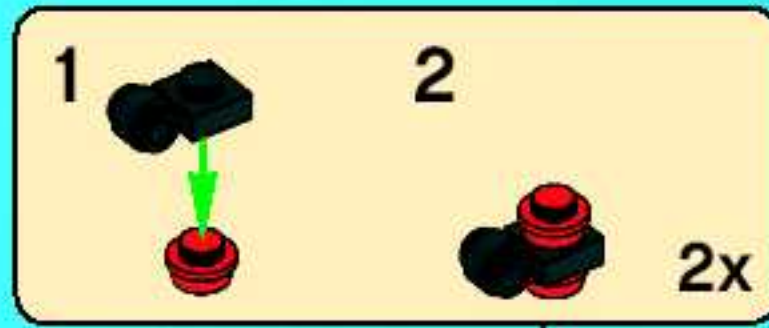

4

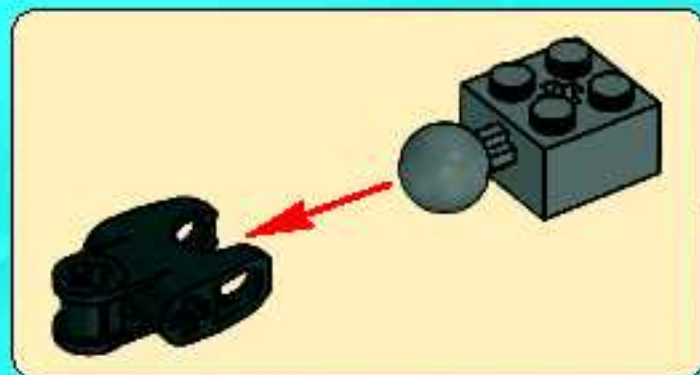



5



6

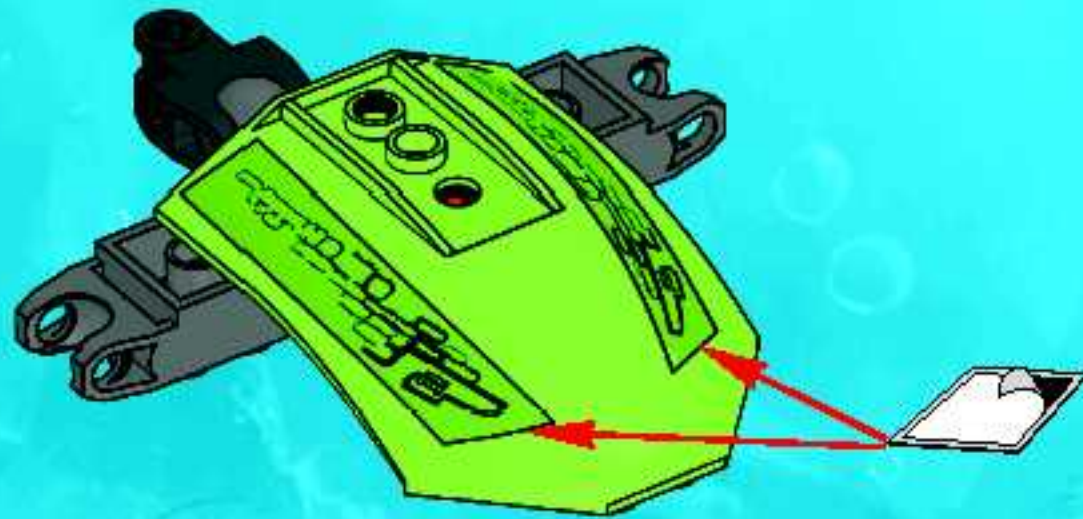

14

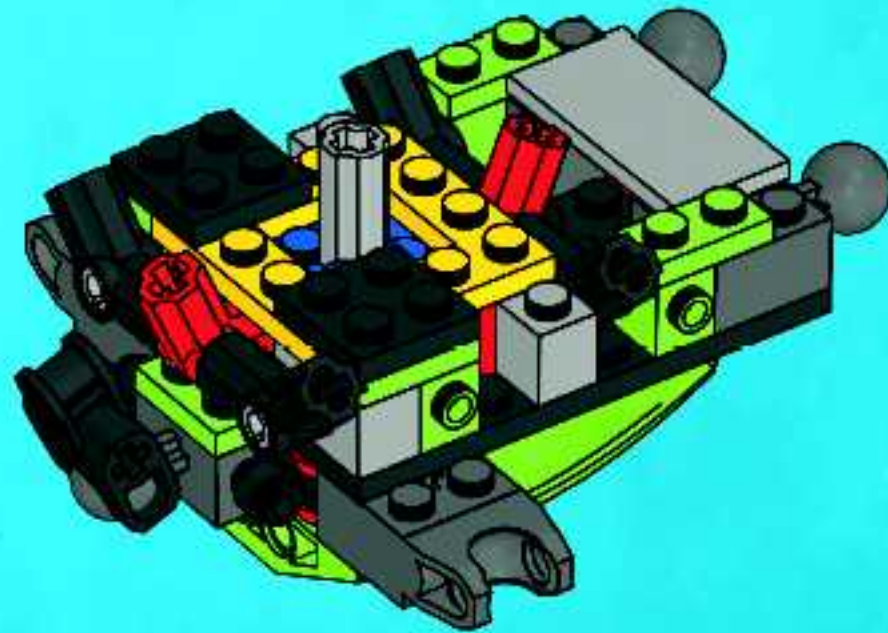
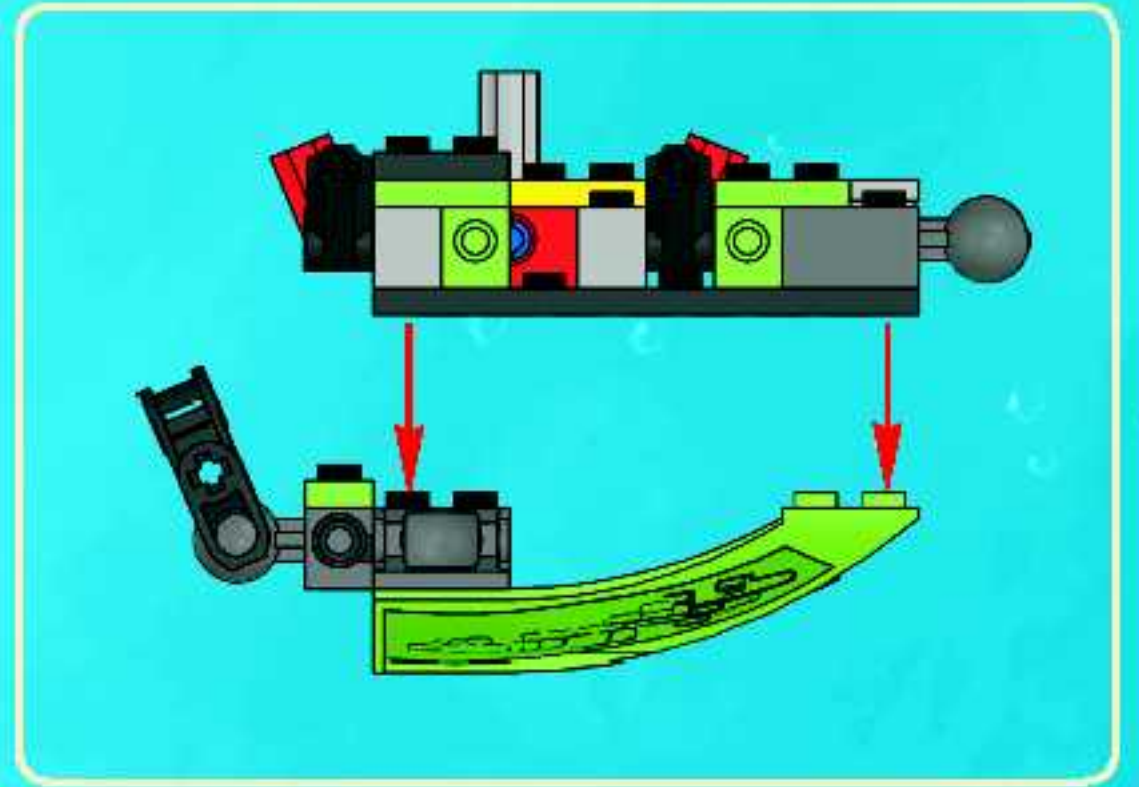



6x

15

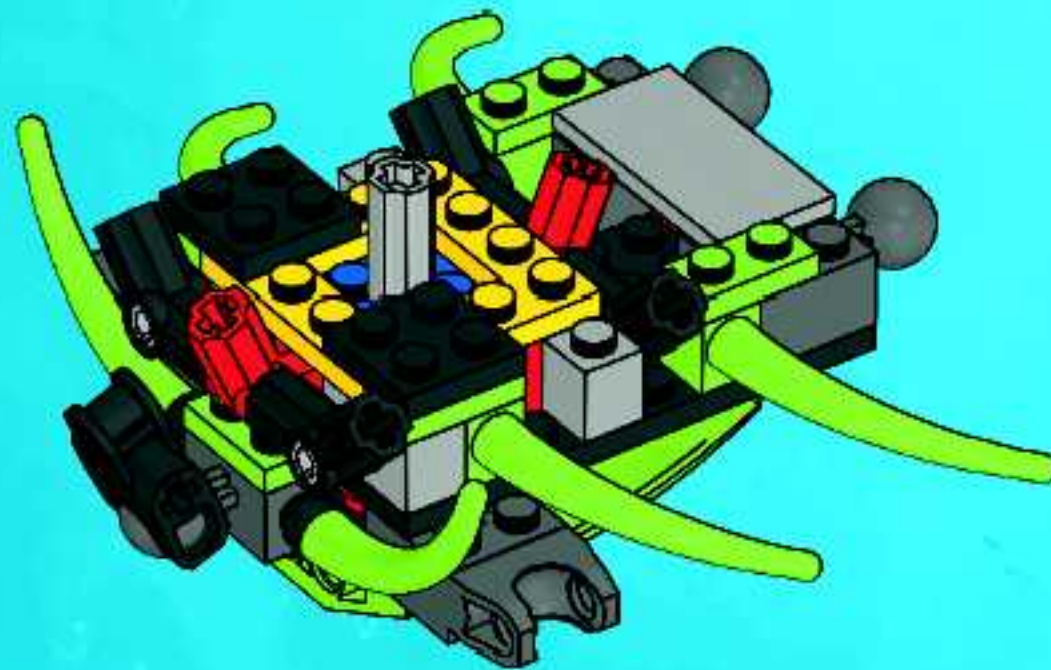

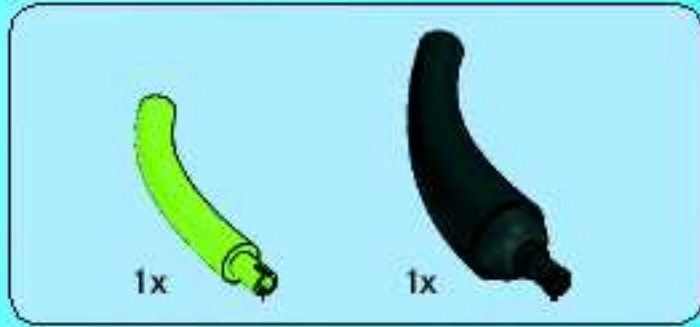

1

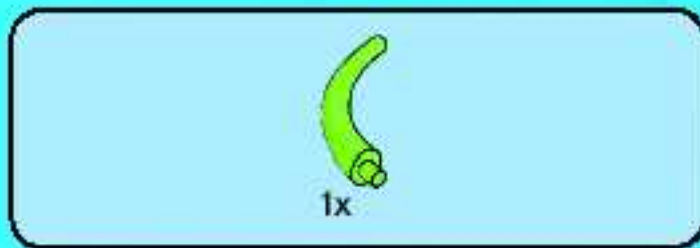
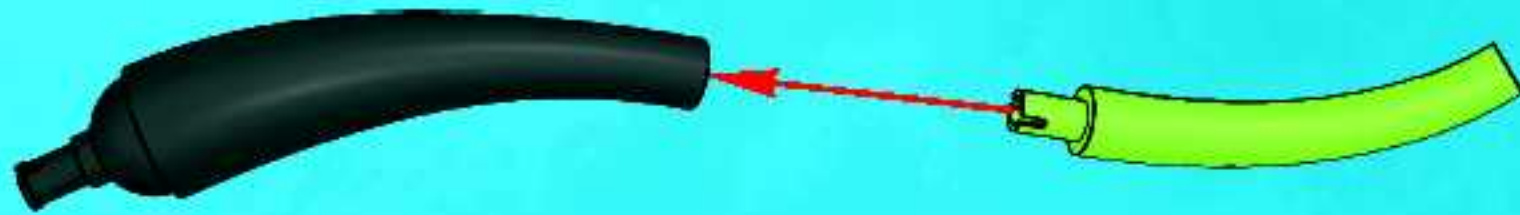

2

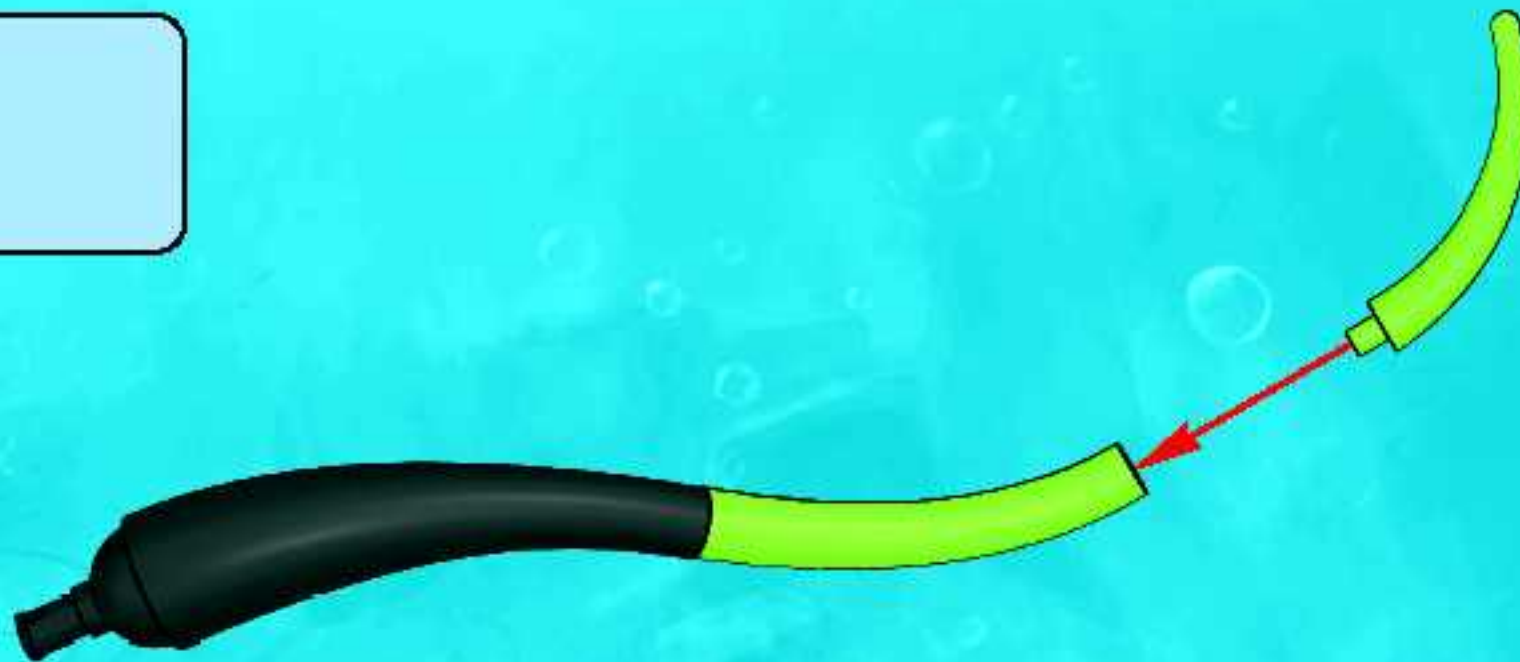

16

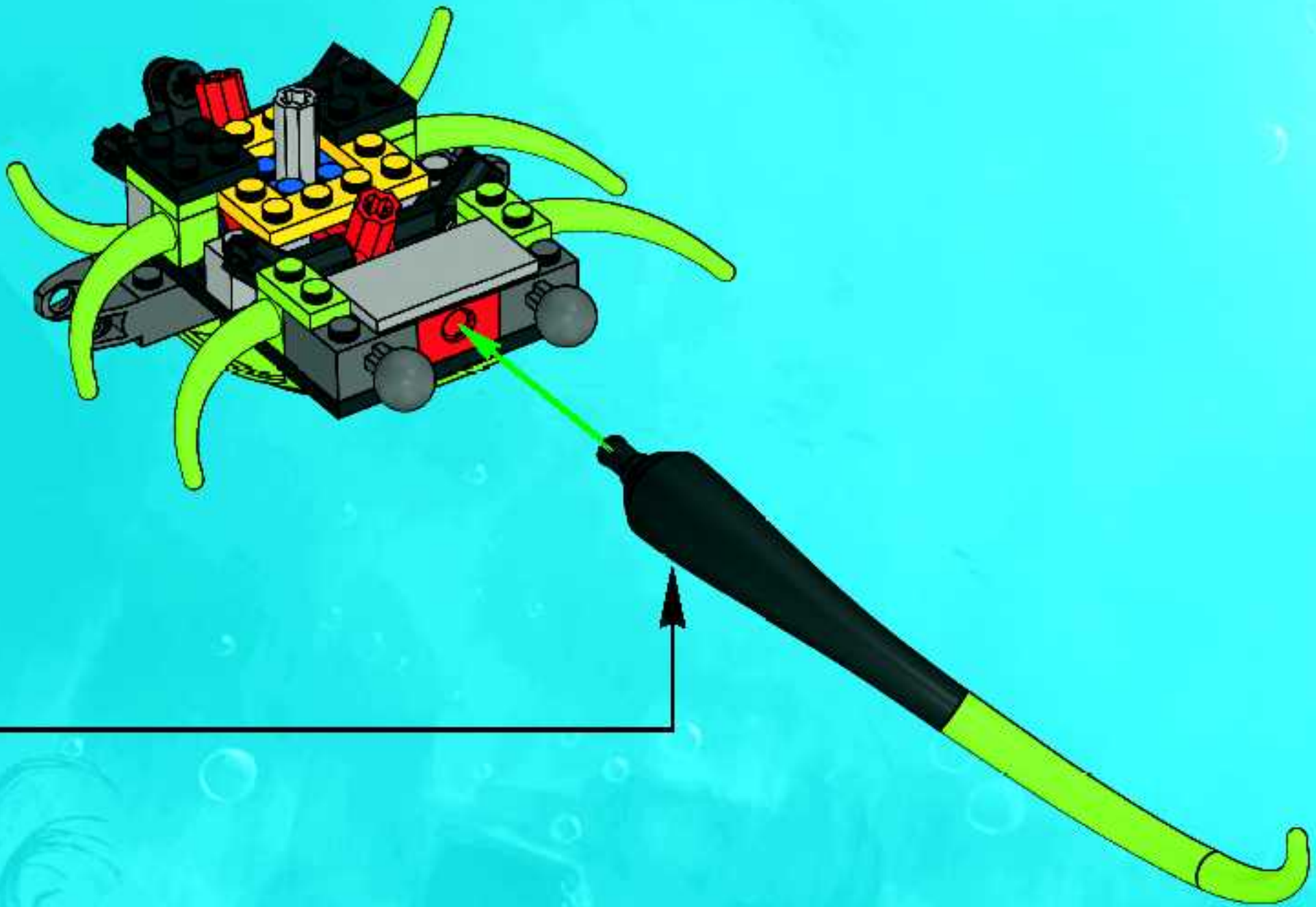

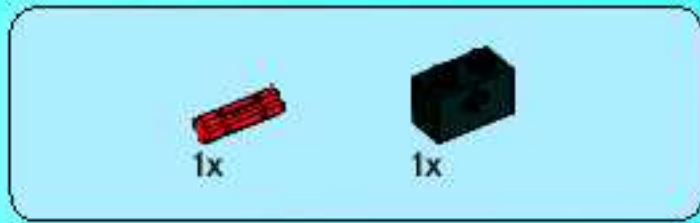

1

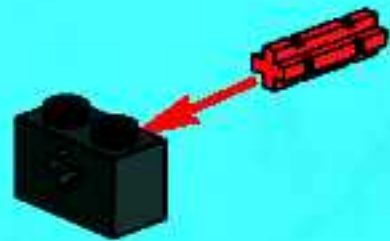

2



3





4

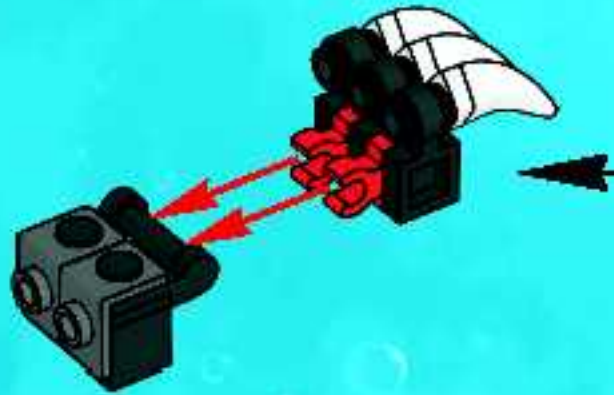
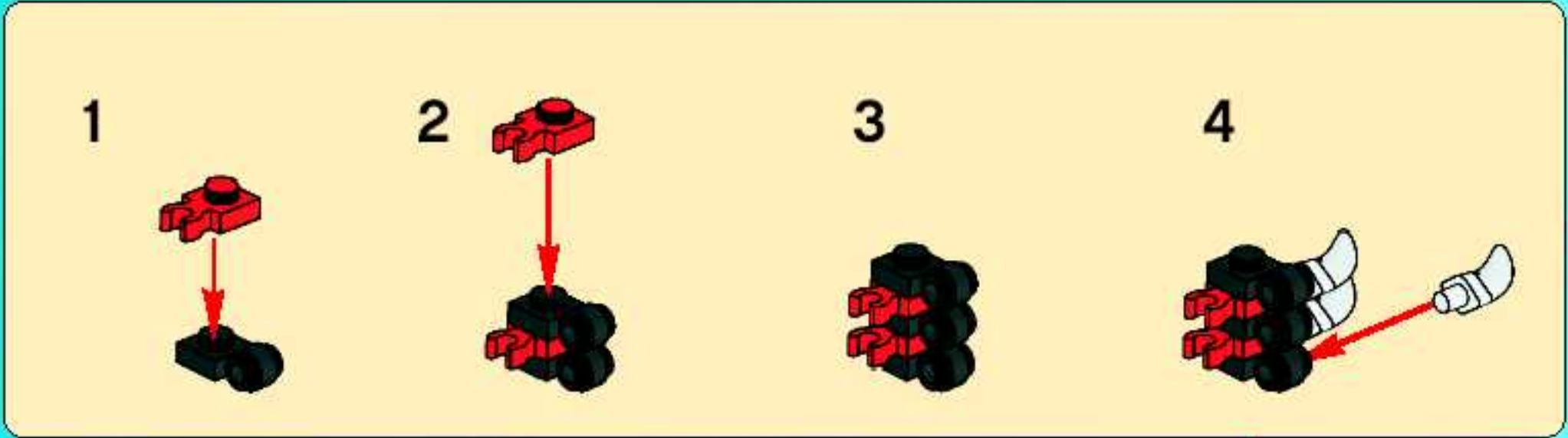



5



2x

17

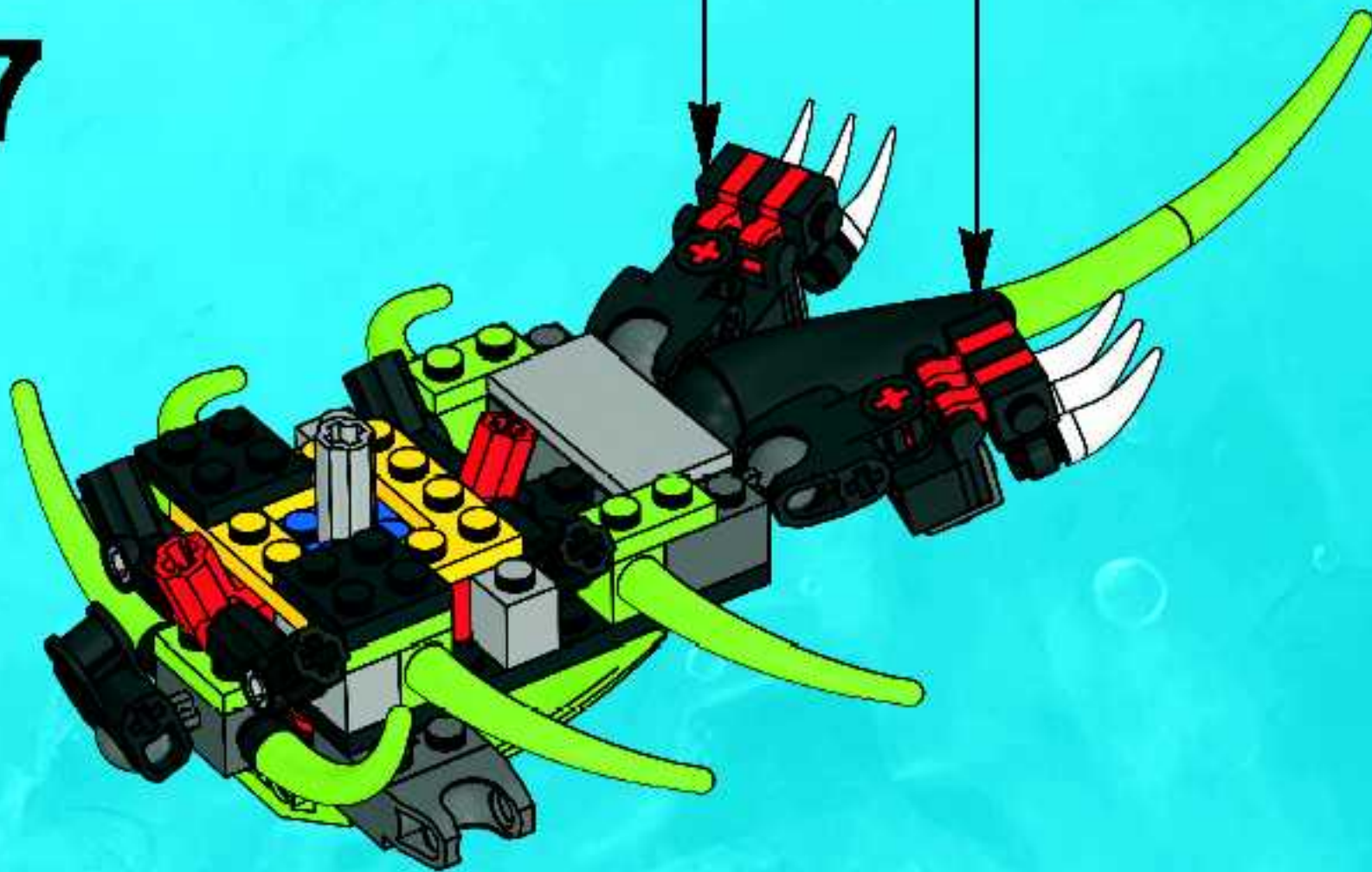

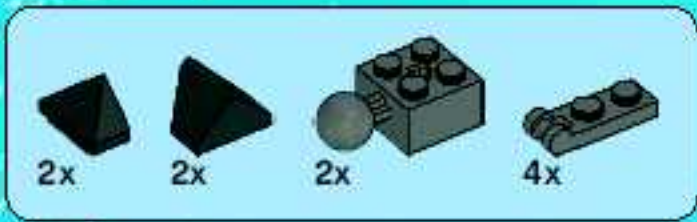

18

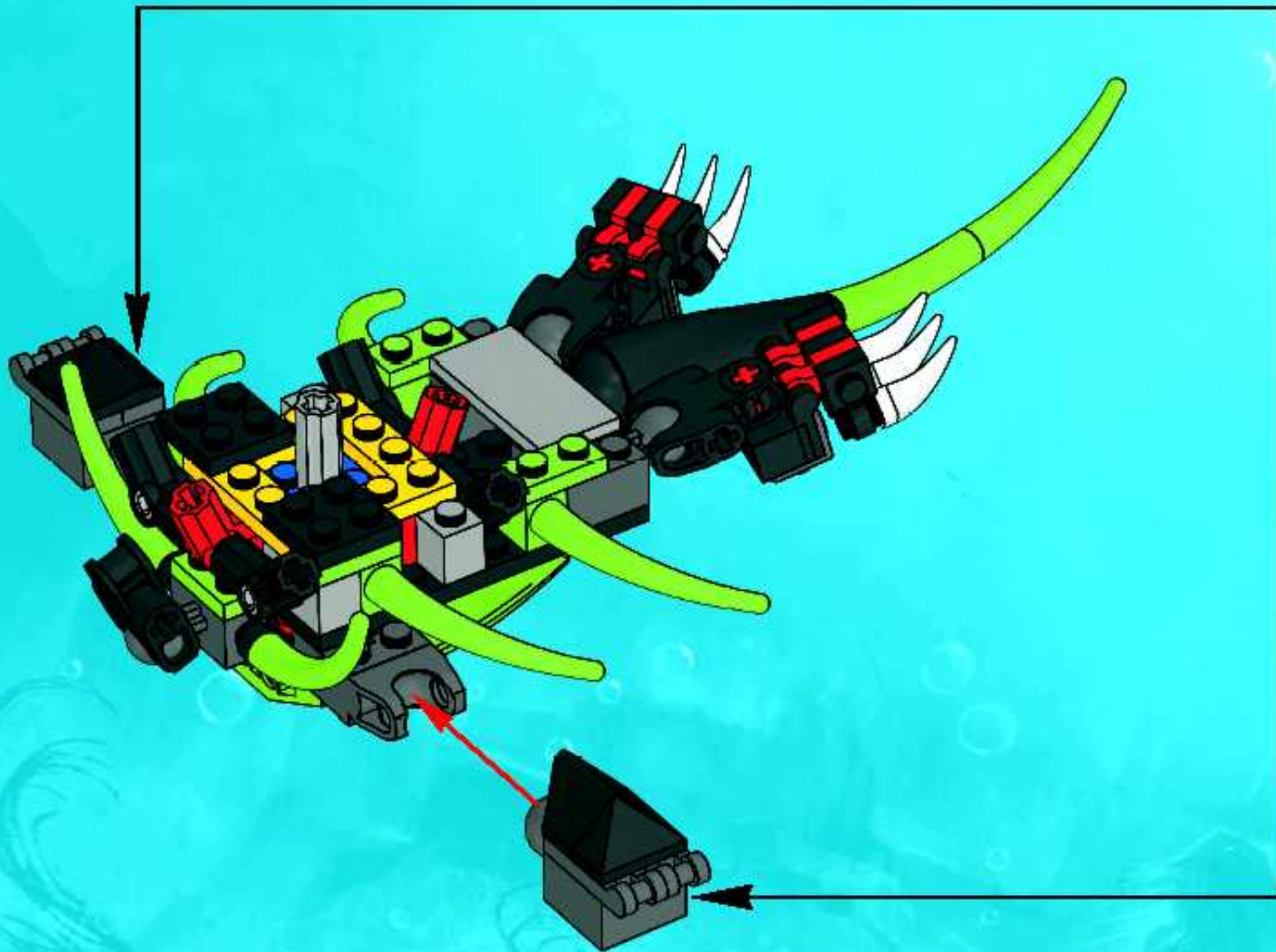
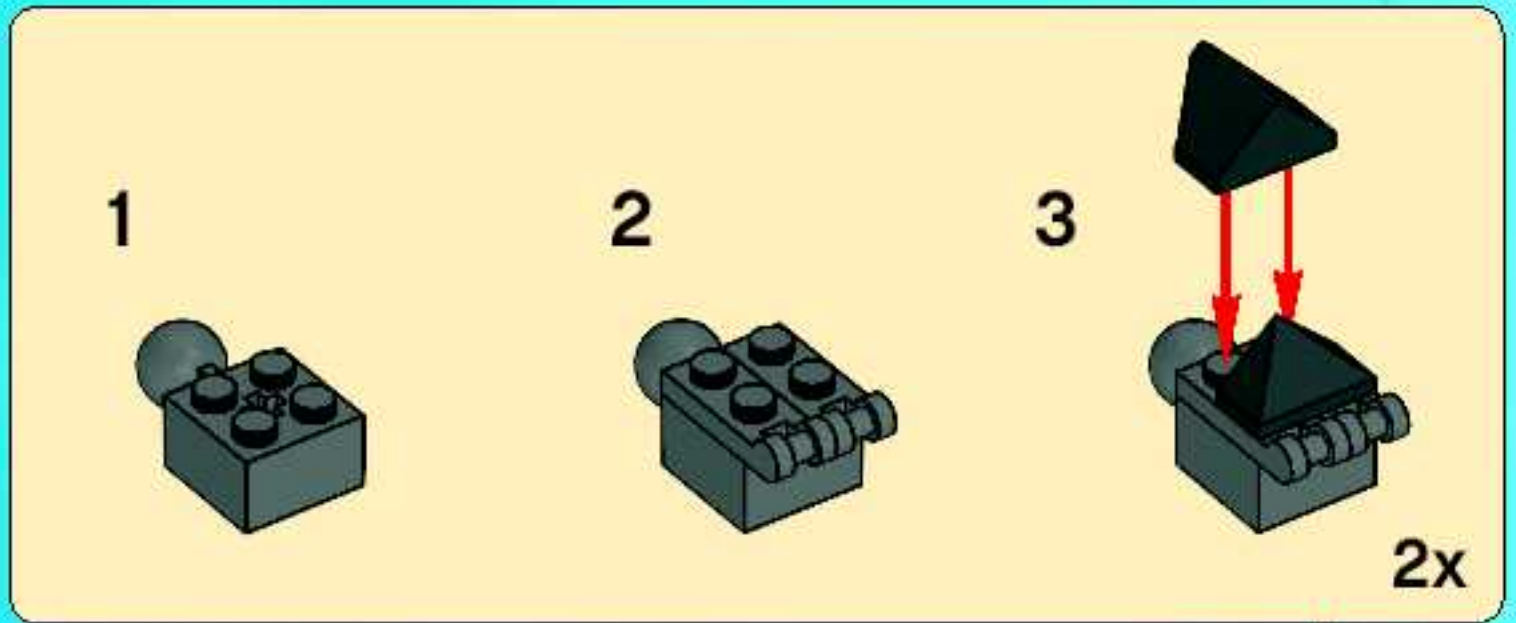



1

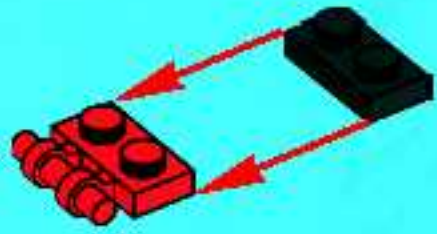

2



3



4





5



6

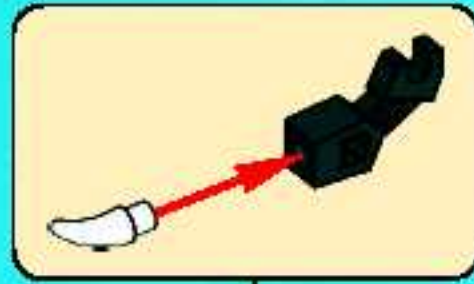

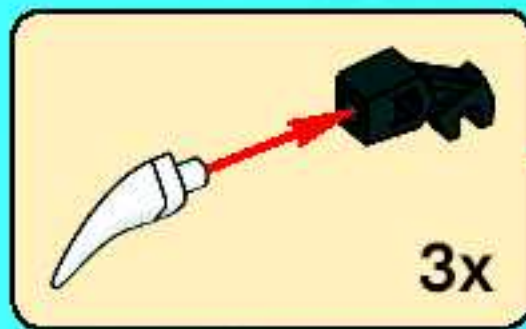

7



2x

19





1

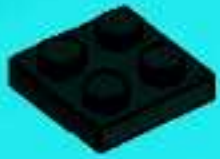

2

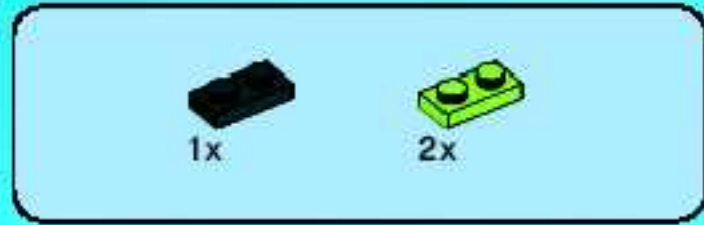

3

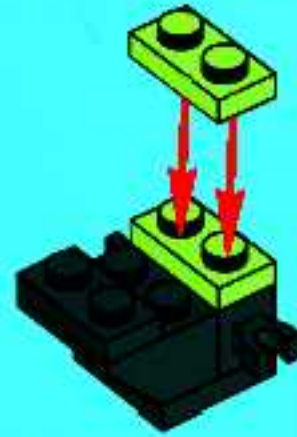

4





5



6

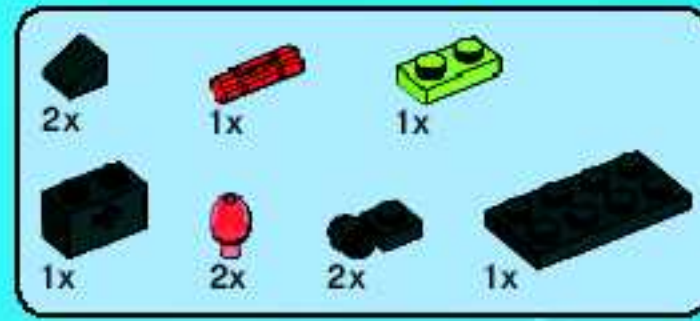

7

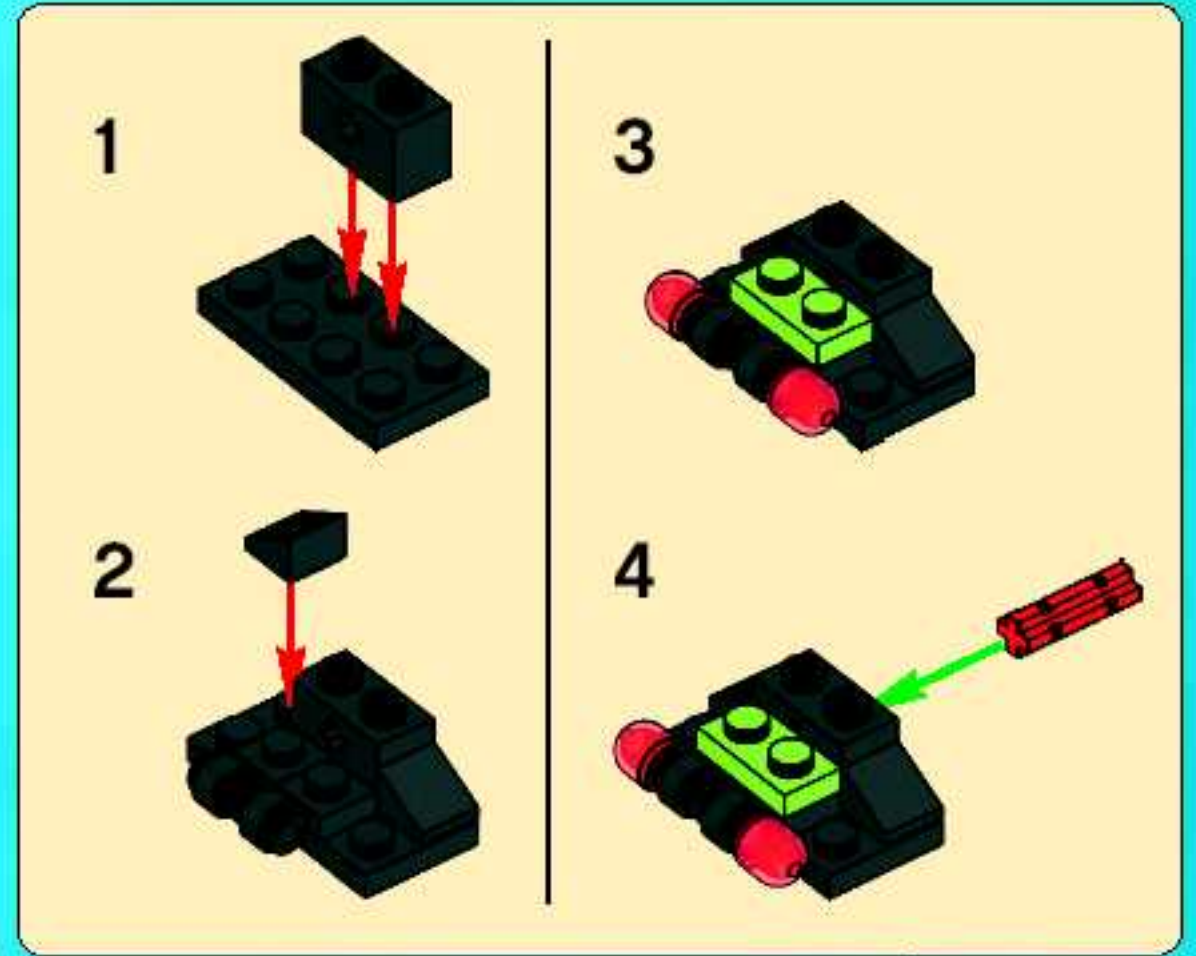

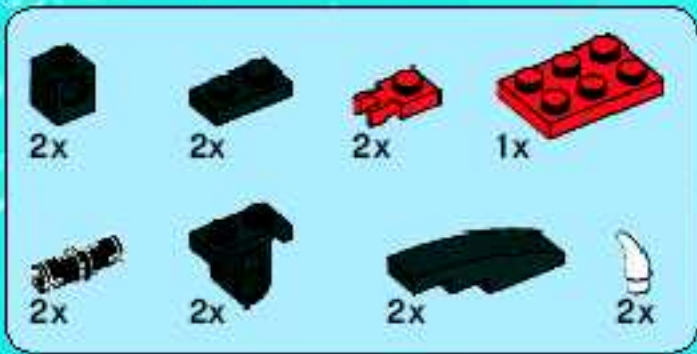

8

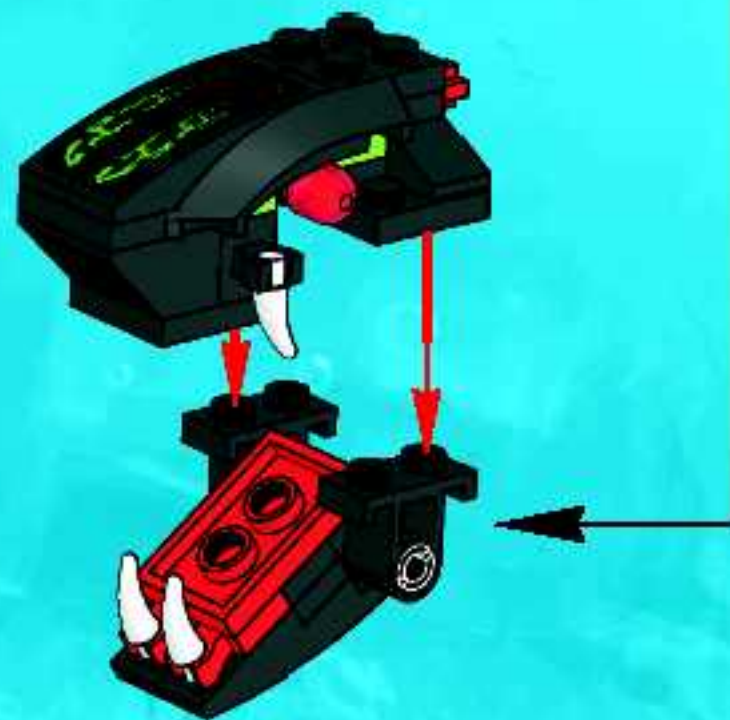
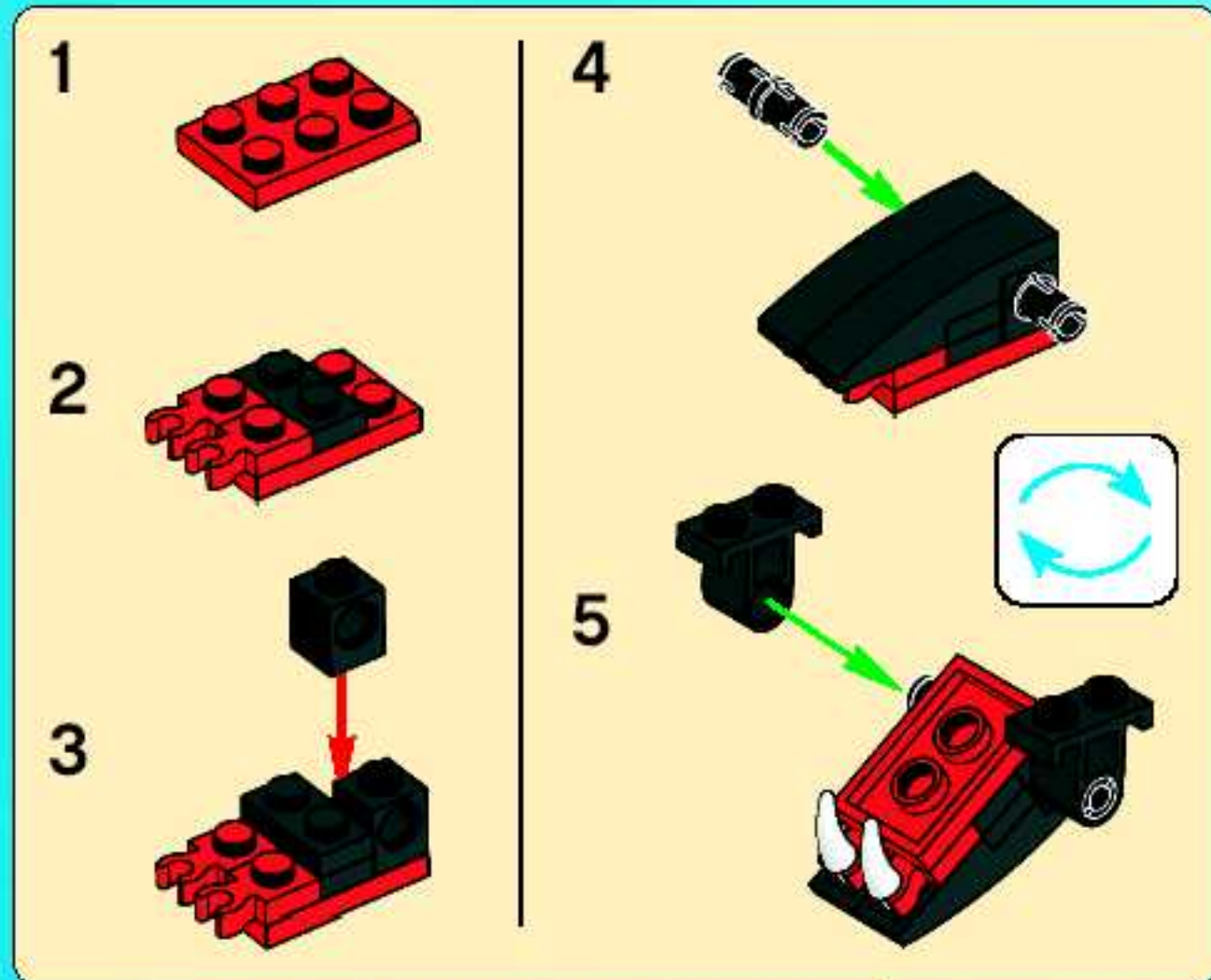

20

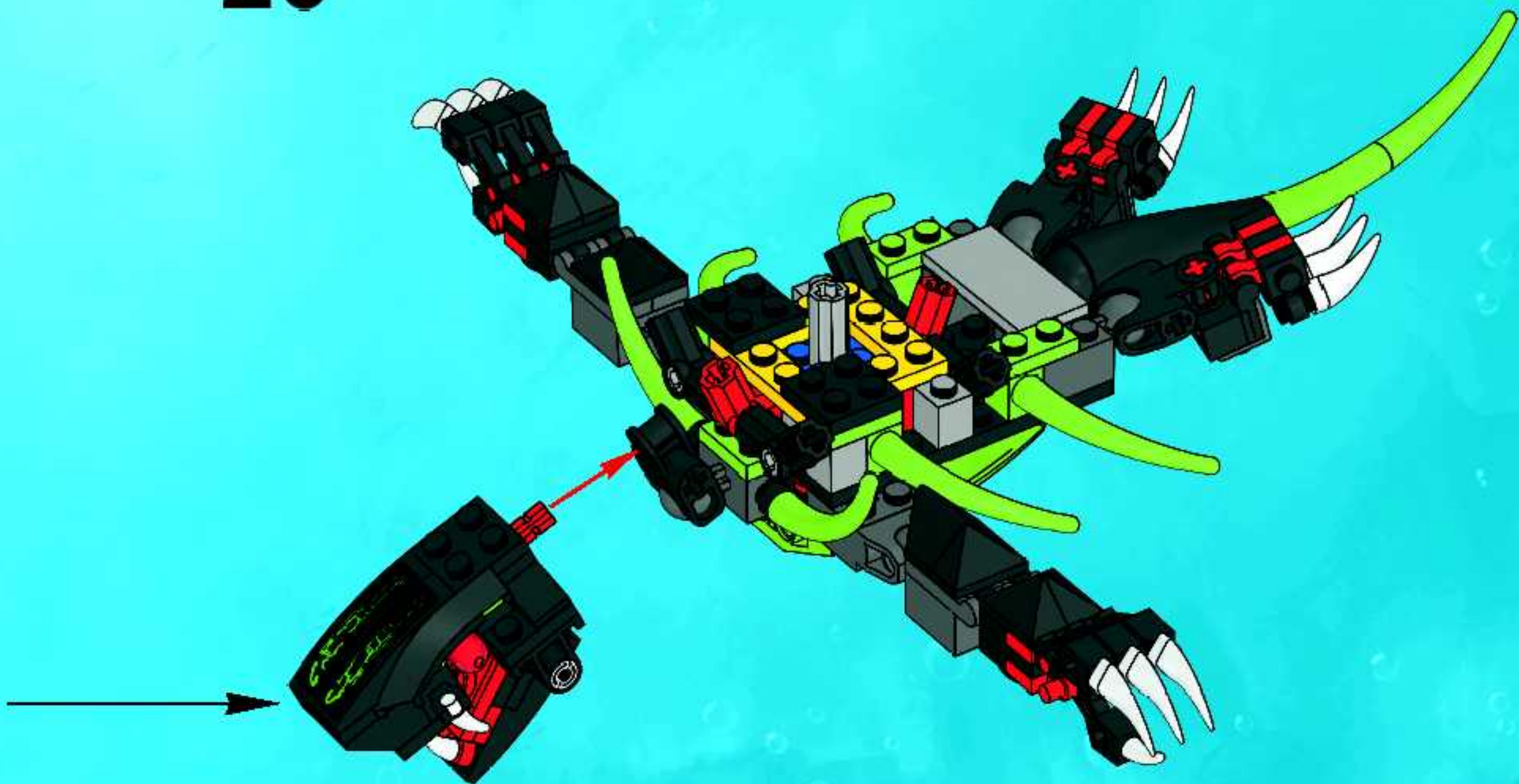



21



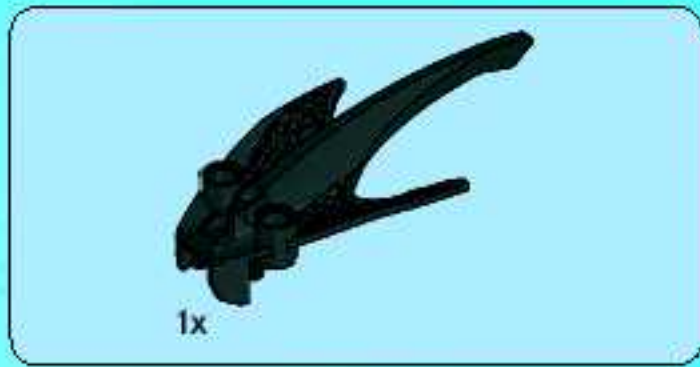

22





23





4x



4x

24



4x



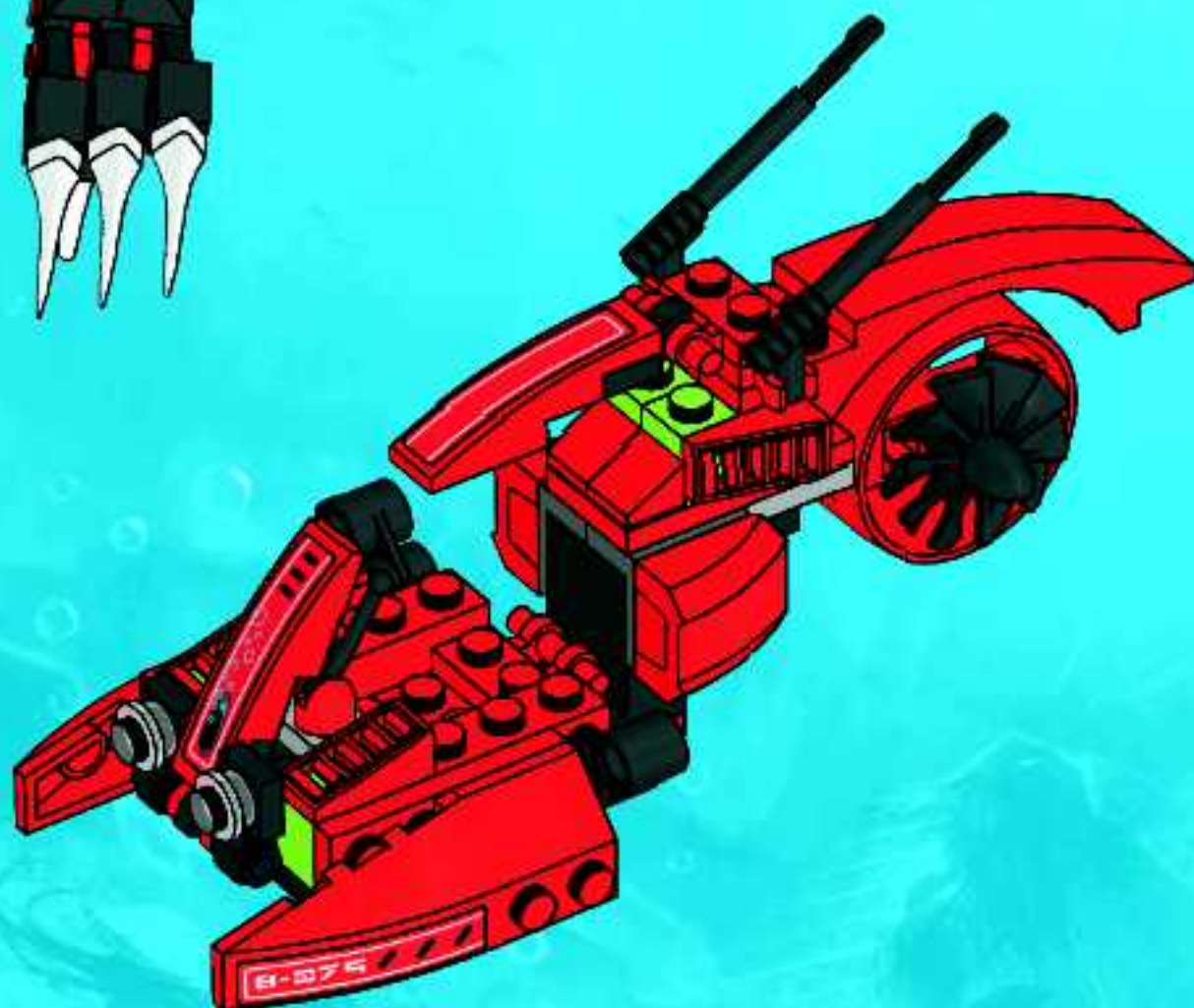



8056



8057



8058



8059



8060



8061



8075



8056



8057



8058



8059





ATLANTIS

8056



8058

8057



8059



8060



8061



8075



8061



8075



ATLANTIS.LEGO.COM



ATLANTIS



1

atlantis.lego.com/products/8058.aspx





ATLANTIS



6x
4568387

12x
4566256

2x
4157223

3x
370021

2x
4504379

4x
4540382

2x
4520782

1x
4286466

1x
4286467

1x
302121

4x
302021

1x
379521

8x
408521

7x
4140585

4x
614121

1x
74335

1x
4570494

2x
4144413

2x
4247772

4x
4142865

2x
4227544

1x
3000023

1x
4549896

1x
4570014

2x
4533771

3x
4233487

1x
4100423

2x
654126

2x
4504382

6x
304826

2x
4220539

1x
366026

4x
4522034

7x
302326

5x
302226

1x
302026

1x
4243819

1x
303626

2x
4517925

12x
408126

2x
4144023

2x
4225201

4x
4535739

2x
4278359

8x
4294996

2x
4562148

2x
4287672

1x
4506671

1x
4288241

1x
4525236

3x
4519244

7x
4563326

4x
4121610

3x
4121715

2x
3005740

2x
4497943

1x
4570662

2x
4570481

10x
4566860

2x
4212454

1x
4563327

8x
4164037

4x
4579250

7x
4508460

1x
4504566

4x
4211364

1x
4560183

1x
4211451

1x
4211359

2x
4520320

4x
4211483

1x
4512360

2x
4211815

1x
4570738

5x
4497253

2x
4524353

2x
4277928

4x
4521187

1x
4570036

1x
4563473

4x
4210469

1x
4568036

Customer Service

Kundenservice

Service Consommateurs

Servicio Al Consumidor

www.lego.com/service or dial



: 00800 5346 5555

: 1-800-422-5346

FREE! GRATIS! GRATUIT!



www.LEGOclub.com



00800 5346 5555*        

  1-866-534-6258 • 1-877-518-5346

US & Canada only

Canada seulement



VISIT THE WORLD'S
BIGGEST LEGO® SHOP!

www.LEGOshop.com

* Freephone. Mobile charges may apply. ** Numéri sans frais. Les frais peuvent s'appliquer avec les téléphones cellulaires. * Gebührenfrei. Kosten für Anrufe aus Mobilfunknetzen können anfallen. ** gratuits télécommunication via mobile. * Numéro gratuit. Les frais peuvent s'appliquer avec les téléphones portables. * Der ist gratis. Nur der Anruf aus Postbezirk.

YES! I want to join the LEGO® Club FREE! OUI! Je veux m'abonner au Club LEGO® GRATUITEMENT! Ja! Ich möchte Mitglied im kostenlosen LEGO® Club werden. Ja! Ik wil graag GRATIS lid worden van de LEGO® Club. Ja! Jeg ønsker å melde meg inn i LEGO® Club gratis! Ja! Jag vill gå med i LEGO® Club GRATIS!

First name - Prénom
Vorname - Voornaam
Fornavn - Förnamn

Last name - Nom de Famille
Name - Achternaam
Etternavn - Efternavn

Date of Birth - Date de naissance
Geburtsdag - Geboortedatum
Fødselsdato - Födelsedatum

Boy - Garçon
Junge - Jongen
Gutt - Pojke

Girl - Fille
Mädchen - Meisje
Jente - Flicka

Street - Adresse
Straße, Hausnr.
Straat, huisnr. - Adress

City - Ville
Ort - Woonplaats
Poststed - Postort

State
Prov.
County

Zip/Postcode - Code Postal
PLZ - Postcode - Postnummer

Country
Pays - Land

Please tick below if you would like to receive other communication from the LEGO Group. *S'il vous plait, indiquez ci-dessous si vous souhaitez recevoir d'autres communications de la part de la Compagnie LEGO, veuillez s.v.p. cocher ici.* Als u graag verdere informatie van de LEGO Groep wilt ontvangen, kruis dan a.u.b. dit vakje aan. Ich möchte über Produkte, Angebote, Aktionen und weitere interessante Themen von der LEGO Gruppe informiert werden* (bitte ankreuzen). Om du vill få annen informasjon fra LEGO Gruppen, sett kryss her. Hvis du ønsker å motta annen informasjon fra LEGO Gruppen, merker du av her.

Post - Poste
Per Post

Email - Courriel
Per E-Mail
E-Mail

Ich möchte über Produkte, Angebote, Aktionen und weitere interessante Themen von sonstigen LEGO Partnerunternehmen informiert werden* (bitte ankreuzen). Per Post Per E-Mail

Mail to: / Poster à:



BG29

LEGO® Club
P.O. Box 1157
Enfield, CT USA
06083-1157

Mail to:



BI09U

LEGO® Club
33 Bath Road
Slough SL1 3UF
United Kingdom

Per Post an:



BI09C

LEGO® Club
Postfach 14 15
D-36243 Niederaula

Stuur op naar:



BI09N

LEGO® Club
Postbus 40250
3504 AB Utrecht

Send til:



BI09O

LEGO® Club Norge
Postboks 58
1314 Vøyenenga

Skicka till:



BI09S

LEGO® Club Sverige
Ubox 841
202 29 Malmö

USA/Canada: The English language version of the magazine can only be mailed to addresses in the US, Canada, the UK, and Republic of Ireland. Club membership is valid for two years and includes free copies of the LEGO Club Magazine. In the US and Canada please allow up to 6 weeks for delivery of your first magazine. In the UK and Republic of Ireland please allow six to 14 weeks for delivery of your first magazine. By signing this form you consent the LEGO Club to use your child's data for LEGO mailings. The data will only be used for LEGO mailings and will not be sold, rented or otherwise disclosed to any company outside the LEGO Company except for disclosure to companies acting as our agents to help us provide services requested by the child. This coupon is valid for one free membership per person, group or organisation. Photocopied coupons are accepted. **FR** La version française du magazine peut être postée uniquement au Canada. L'abonnement est valide pour 2 ans et inclut des exemplaires gratuits du Magazine LEGO. Aux É.-U. et au Canada, allouer 6 semaines pour la livraison initiale. En remplissant ce formulaire, vous consentez à ce que LEGO utilise les informations de votre enfant pour des envois postaux de LEGO. L'information sera utilisée uniquement pour des envois postaux par LEGO et ne sera en aucun cas, vendue, louée, échangée ou divulguée à d'autres compagnies autres que la compagnie LEGO, à l'exception des compagnies affiliées qui nous procurent des services auxquels l'enfant en a fait la demande. **DE** Das deutschsprachige LEGO Club Magazin kann nur an Adressen in Deutschland, Österreich und der Schweiz verschickt werden. Die kostenlose Mitgliedschaft beinhaltet die Zusendung des LEGO Club Magazins und endet nach zwei Jahren. Mit der Anmeldung gehen Sie keine Verpflichtungen ein. Es kann bis zu drei Monate dauern, bis das erste Magazin zugestellt wird. Mit Ihrer Unterschrift erklären Sie sich damit einverstanden, dass die Daten Ihres Kindes zum Zweck einer LEGO Club Mitgliedschaft von der LEGO Gruppe gespeichert und verarbeitet werden. Die Daten werden vertraulich behandelt, nicht an Dritte weitergegeben und nicht veräußert. Externe Dienstleister erhalten Ihre Daten nur, soweit es für die Abwicklung von LEGO Kommunikation erforderlich ist. Wenn Sie von uns nicht mehr kontaktiert werden möchten, können Sie der Verwendung Ihrer Daten für Werbezwecke widersprechen unter: 00800 5346 5555 (Anruf gebührenfrei, Kosten für Anrufe aus Mobilfunknetzen können abweichen). * Die Einwilligungen kann ich jederzeit (insgesamt oder zu dem Teil) ohne Einfluss auf die LEGO Club Mitgliedschaft bei der LEGO Gruppe widerrufen. **NL** Het LEGO Club Magazine kan alleen worden gestuurd naar adressen in Nederland. Het lidmaatschap is 2 jaar geldig en geeft recht op toezending van het gratis LEGO Club Magazine. Het eerste magazine zal na 12 tot 14 weken toegestuurd worden. Het lidmaatschap kan op ieder moment opgezegd worden. Door dit formulier te tekenen geeft u de LEGO Club toestemming om bovenstaande gegevens te gebruiken voor het toesturen van LEGO mailings. Uw gegevens worden uitsluitend gebruikt voor mailings van LEGO en zullen niet worden verkocht, verhuurd of op welke wijze dan ook verstrekt aan derden buiten de LEGO Groep, uitgezonderd de organisaties die namens ons optreden om de service te verlenen waar uw kind om gevraagd heeft. **NO** Den norske utgaven av magasinet sendes kun til adresser i Norge. Medlemskap i klubben gjelder i 2 år og inkluderer gratisutgaver av LEGO Magazine. Påregnet opp til seks uker leveringstid for første magasin. Ved å undertegne dette skjemaet, gir du ditt samtykke til at LEGO Club kan bruke opplysningene om barnet ditt i LEGO forsendelser. Dataene vil utelukkende bli brukt i LEGO forsendelser og vil ikke bli solgt, utleid eller på annen måte gjøres tilgjengelig for selskaper utenfor LEGO gruppen, unntatt selskaper som er våre agenter og som hjelper oss å tilby tjenestene barnet etterspør. Dette skjemaet gjelder for ett gratis medlemskap per person, gruppe eller organisasjon. **SE** Den svenska versionen av tidningen kan endast skickas till adresser i Sverige. Club-medlemskapet är giltigt i 2 år och innefattar gratis exemplar av LEGO Club Magazine. Vänligen räkna med 6 veckor för leverans av din första tidning. Genom att skicka in det här formuläret godkänner du att LEGO Club använder barnets uppgifter för LEGO utskick. Uppgifterna kommer bara att användas för LEGO utskick och kommer inte att säljas, hyras ut eller vidarebefordras till något företag som inte tillhör LEGO Gruppen, med undantag av företag som agerar som våra ombud för att tillhandahålla tjänster som barnet har begärt. Den här kupongen gäller för ett gratis medlemskap per person, grupp eller organisation.

Parent's signature - Signature d'un parent - Unterschrift Erziehungsberechtigte/r

Handtekening ouders - Foreldres/Foresettes underskrift - Förälders/Förmyndares underskrift

Date

Datum

Date

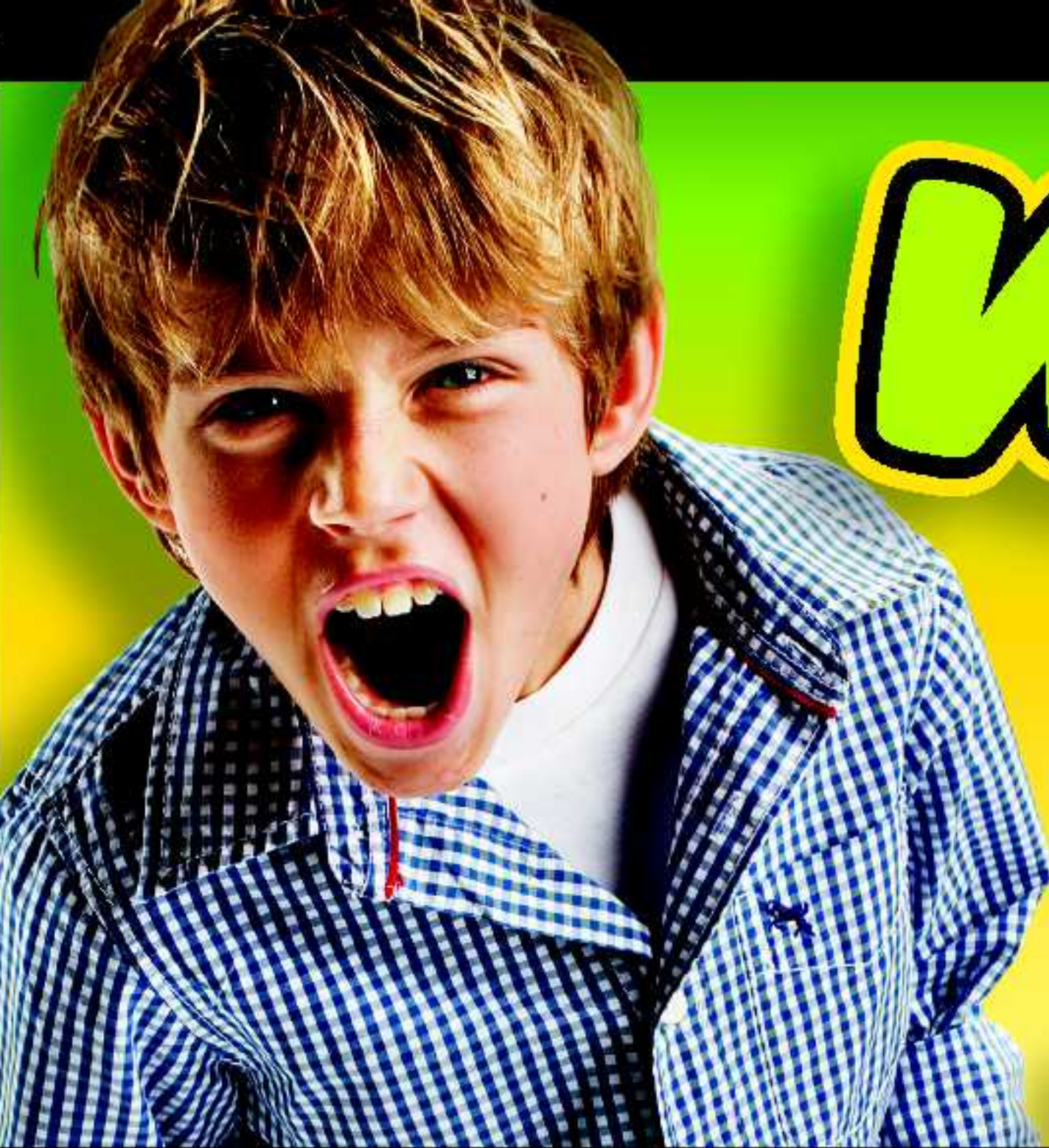

WIN!

Go to www.nielsen.com/LEGO
to fill out a survey for a chance
to win a cool LEGO® Product.
No purchase necessary.
Open to all residents where not prohibited.

 www.LEGO.com



www.nielsen.com/LEGO

GEWINNE! WIN!

Nimm an der Umfrage auf
www.nielsen.com/LEGO
teil und hab die Chance ein cooles
LEGO® Produkt zu gewinnen!

Die Teilnahme am Gewinnspiel führt zu keinerlei
Kaufverpflichtungen. Teilnahme in allen nicht
ausgeschlossenen Ländern möglich.

Ga naar www.nielsen.com/LEGO,
vul een enquêteformulier in en
maak kans op een
cool LEGO® product.

Geen aankoopverplichting.
Iedereen mag deelnemen, uitgezonderd
ingesloten landen
van landen waar een enquêteverbod geldt.

GAGNE! 当てよう!

Visite www.nielsen.com/LEGO
pour répondre à un questionnaire
et avoir une chance de gagner
un produit LEGO® très cool!

Aucune obligation d'achat.
Ouvert à tous les résidents des pays
autorisés.

www.nielsen.com/LEGOにアクセスして、アンケ
ートにご記入ください。当選者にはレゴ製品を
差し上げます。

お買い上げの必要はありません。
禁止されていない限り、すべての皆様にご利用いただけます。