

トクシユブタイ

EXOROBOROB

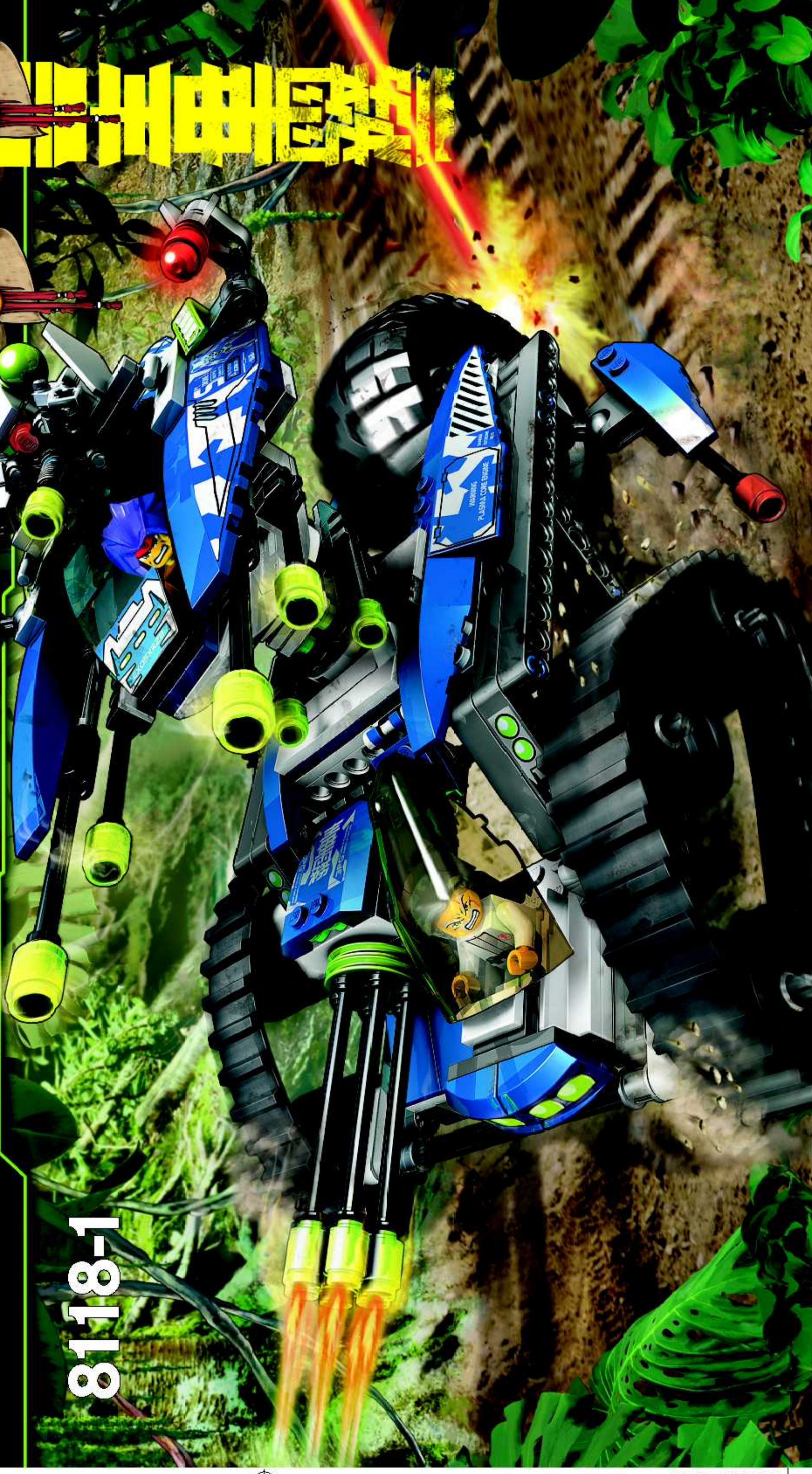

8118-1



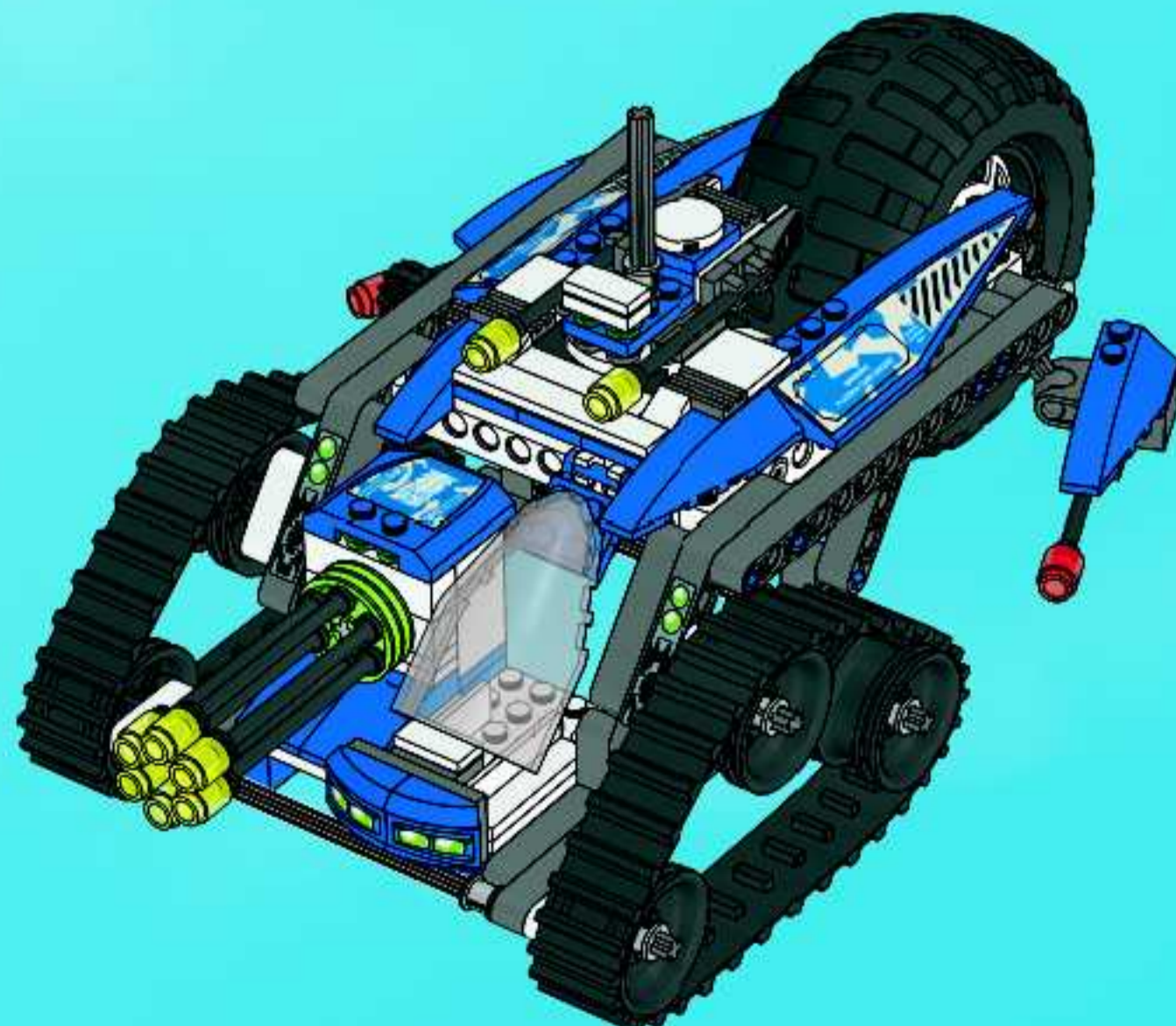
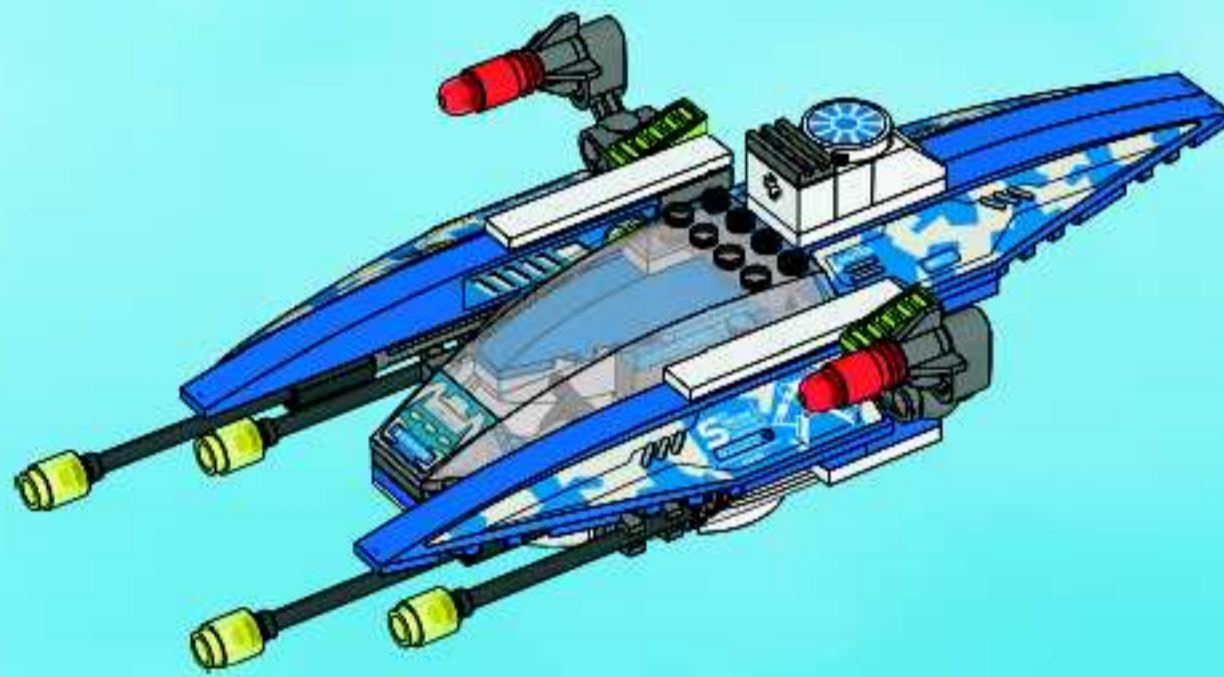

1

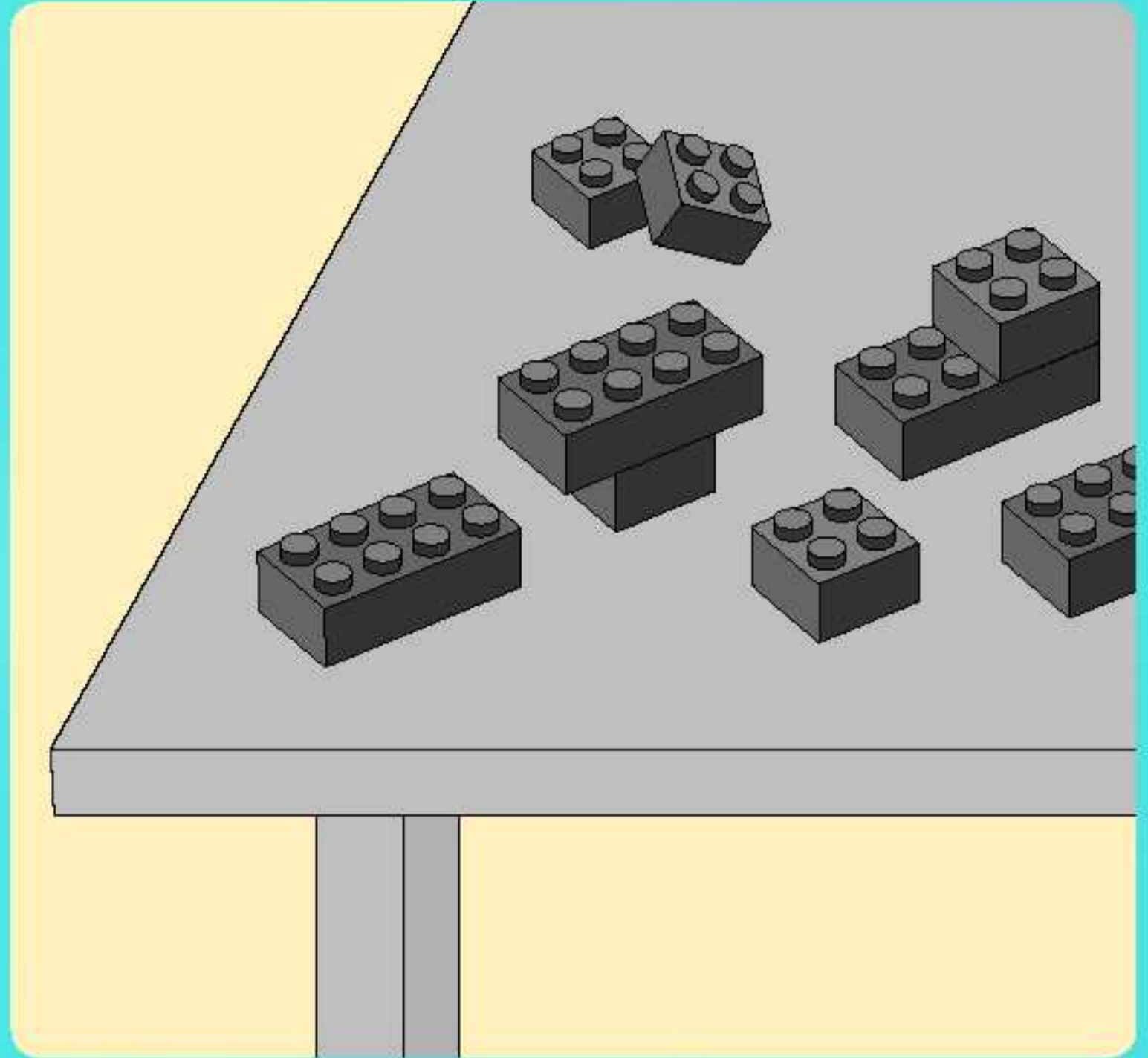
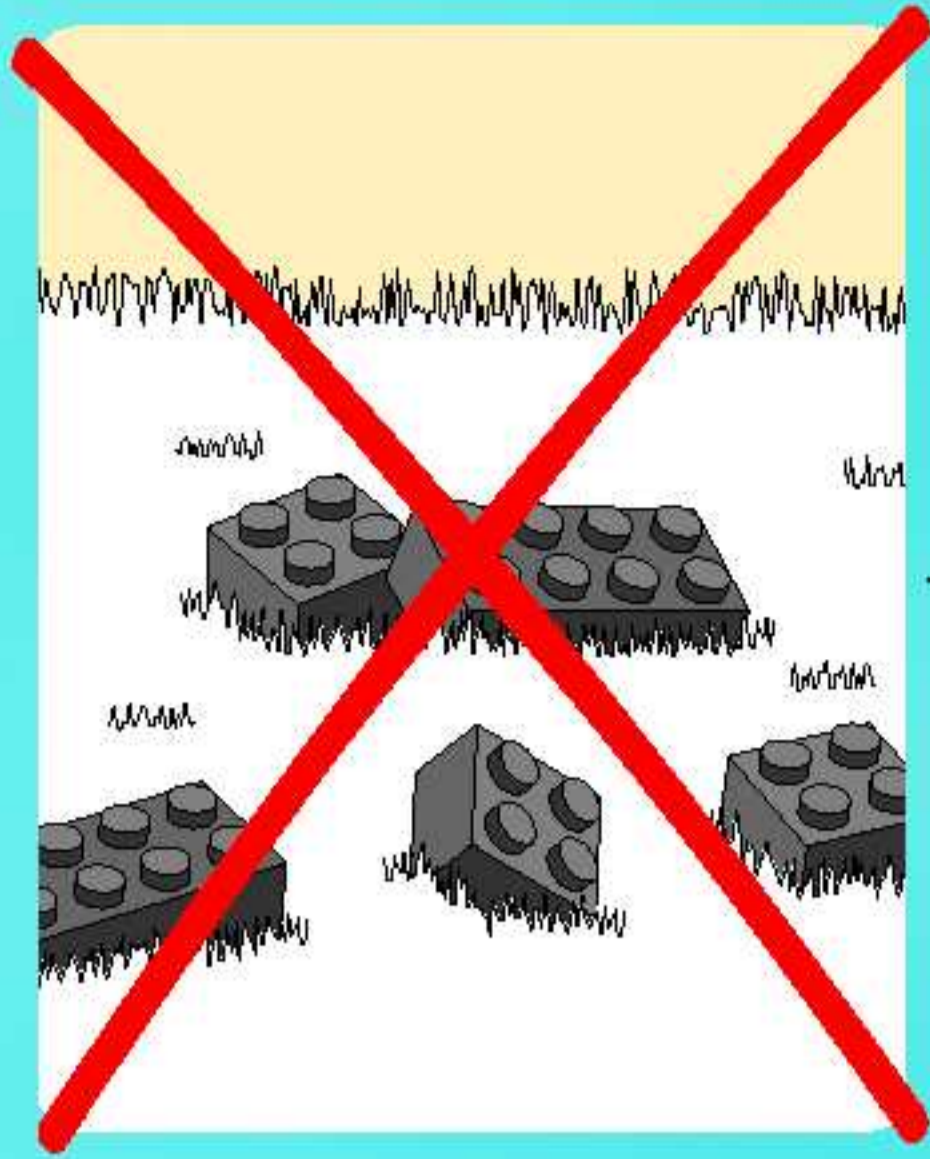

2



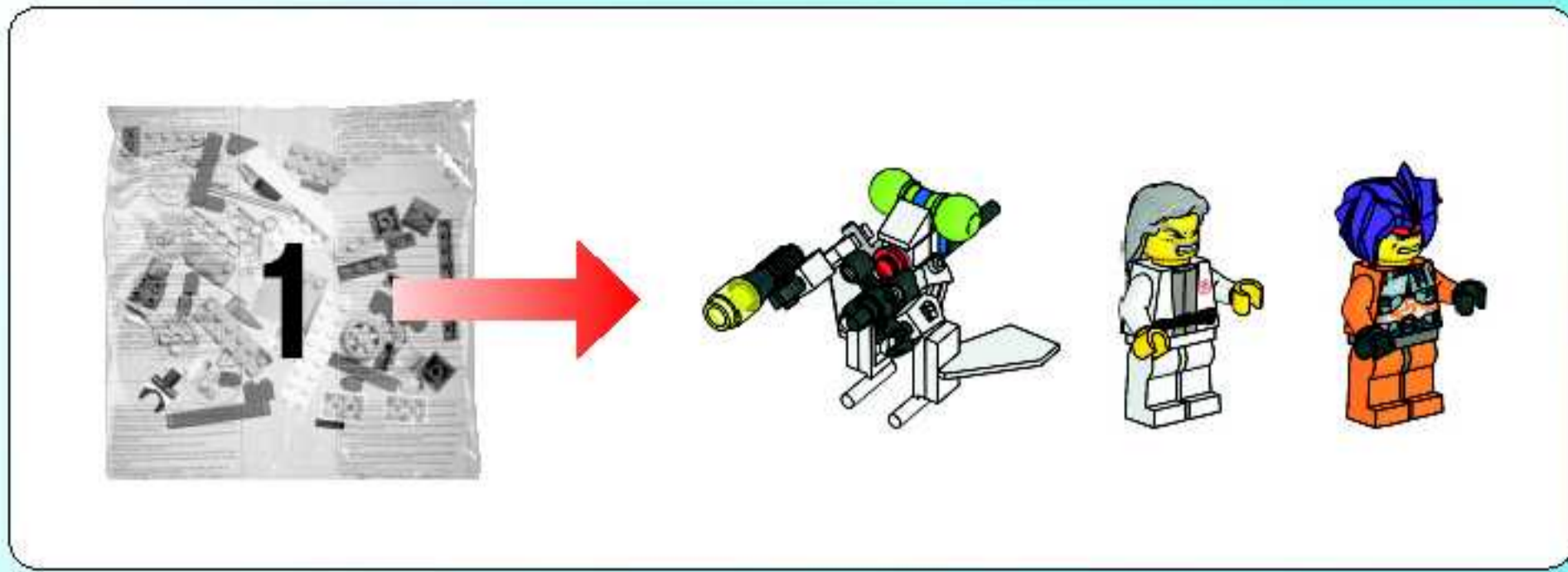

3

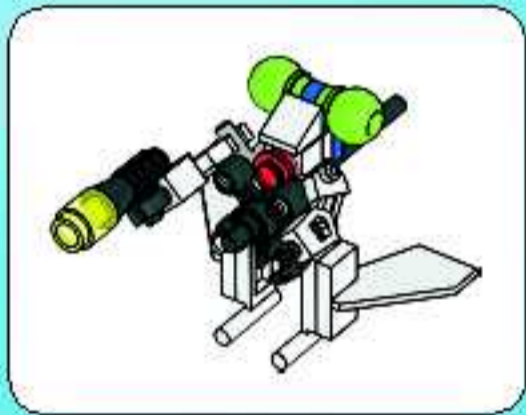
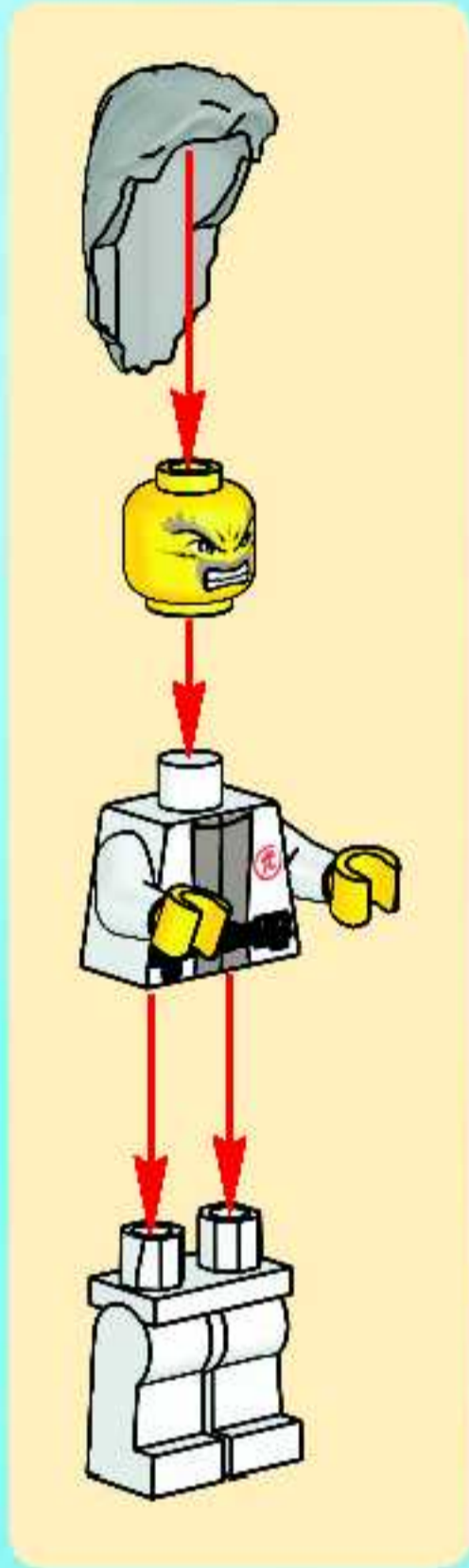

1

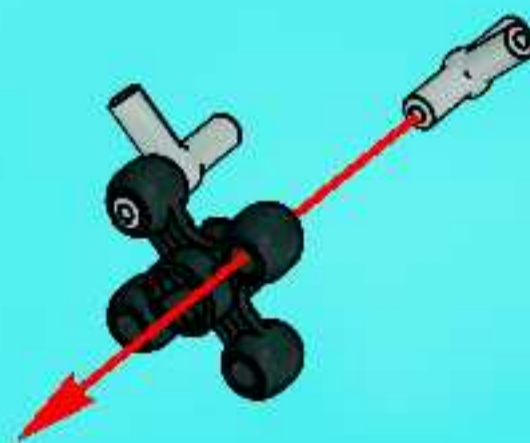

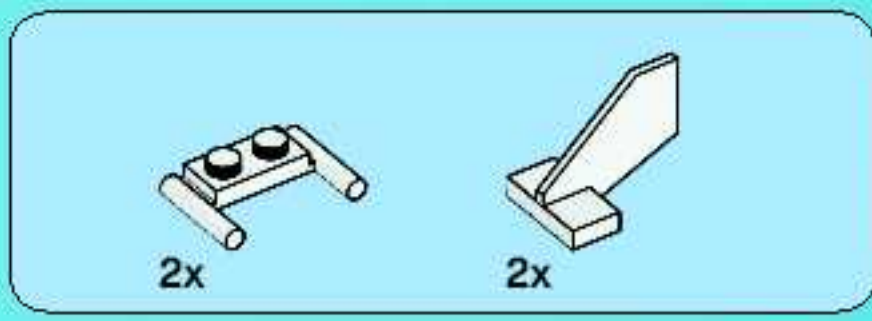

2

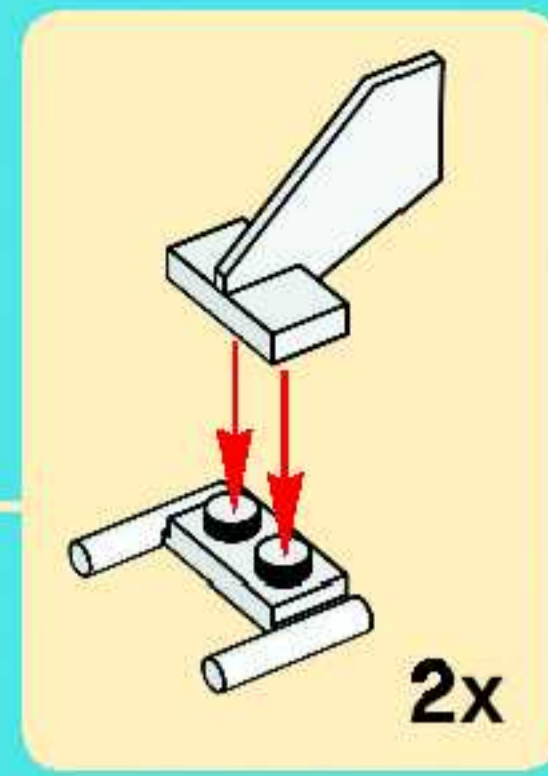
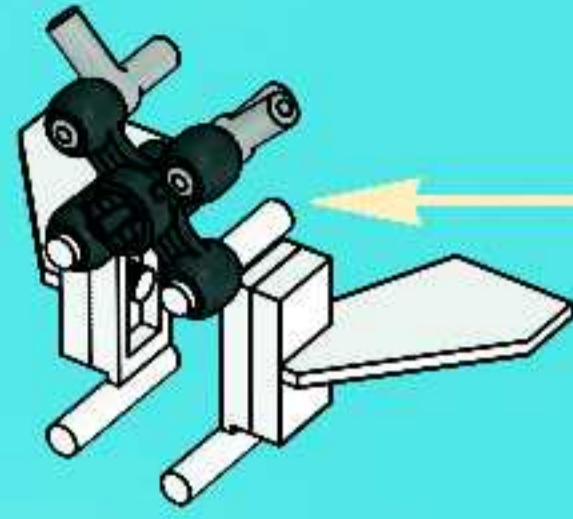

3

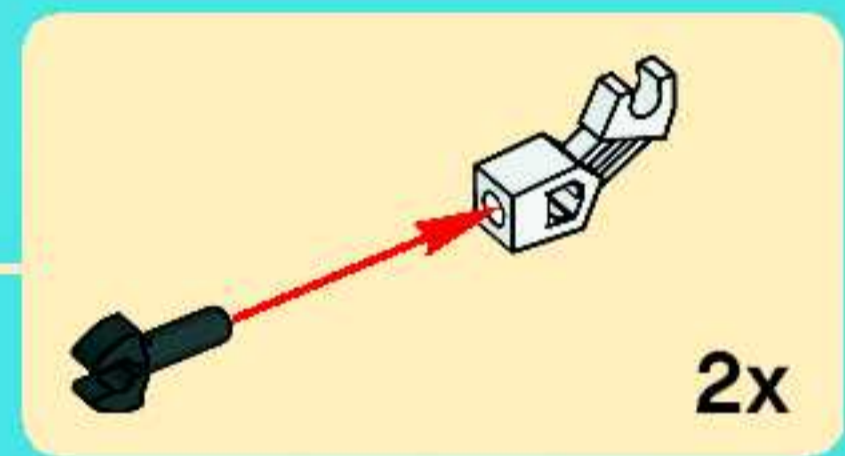
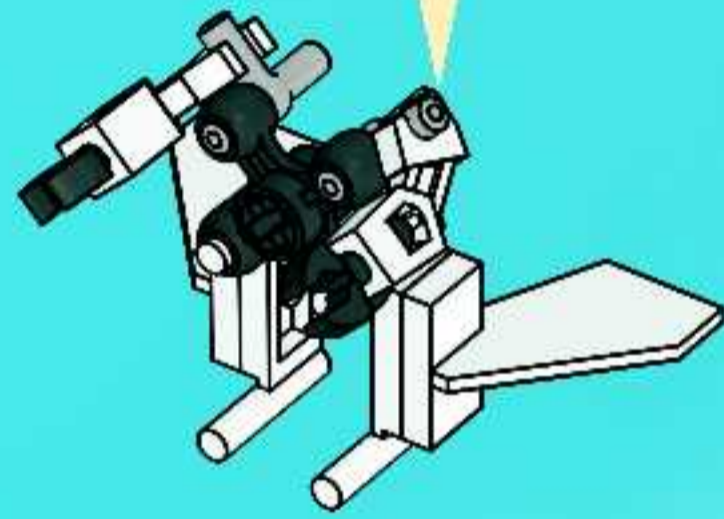

4

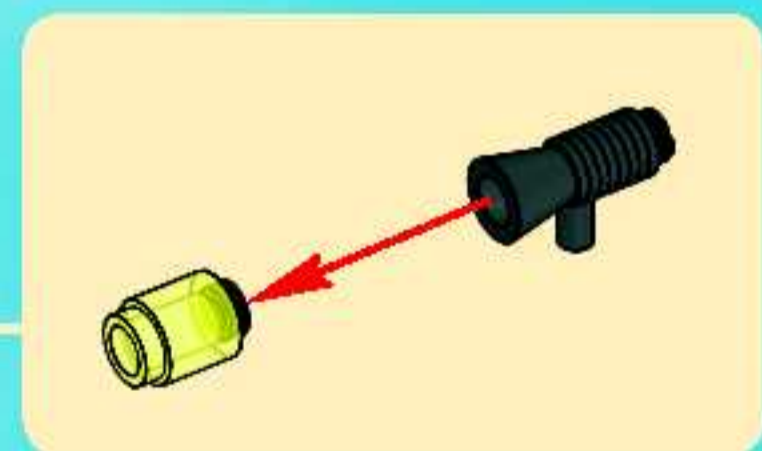
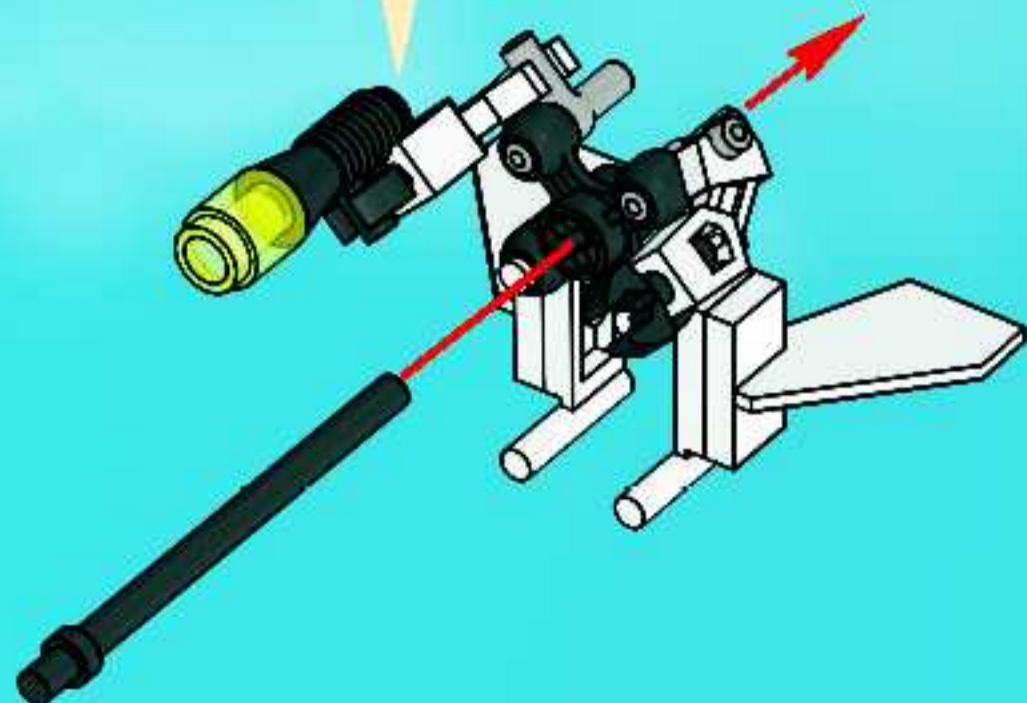

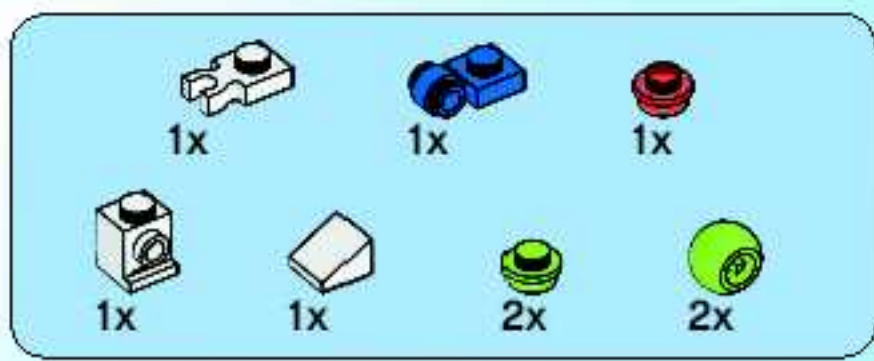

5

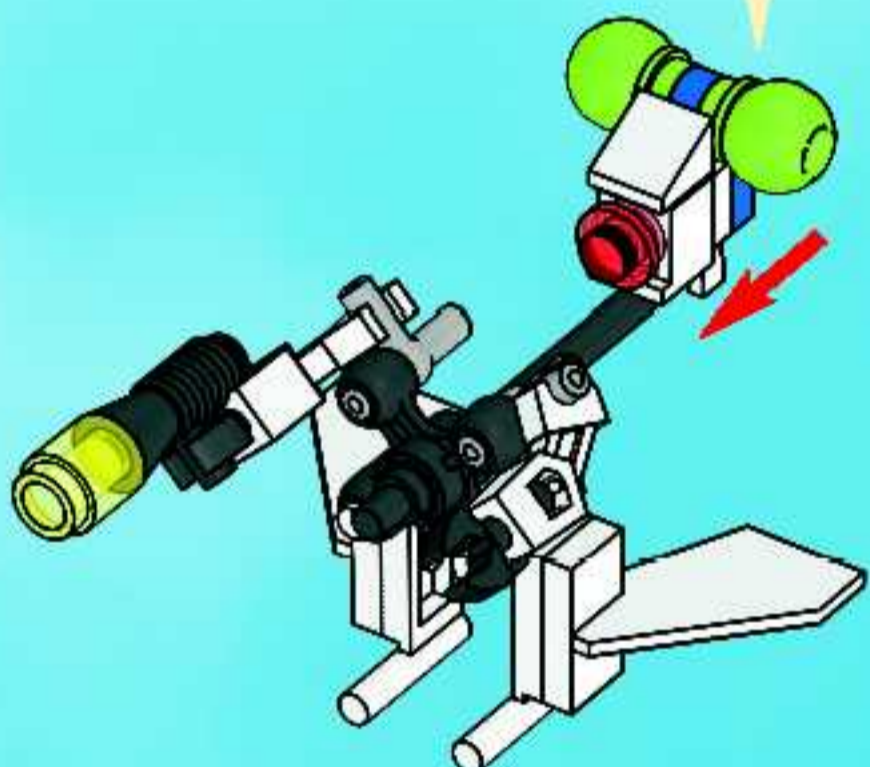
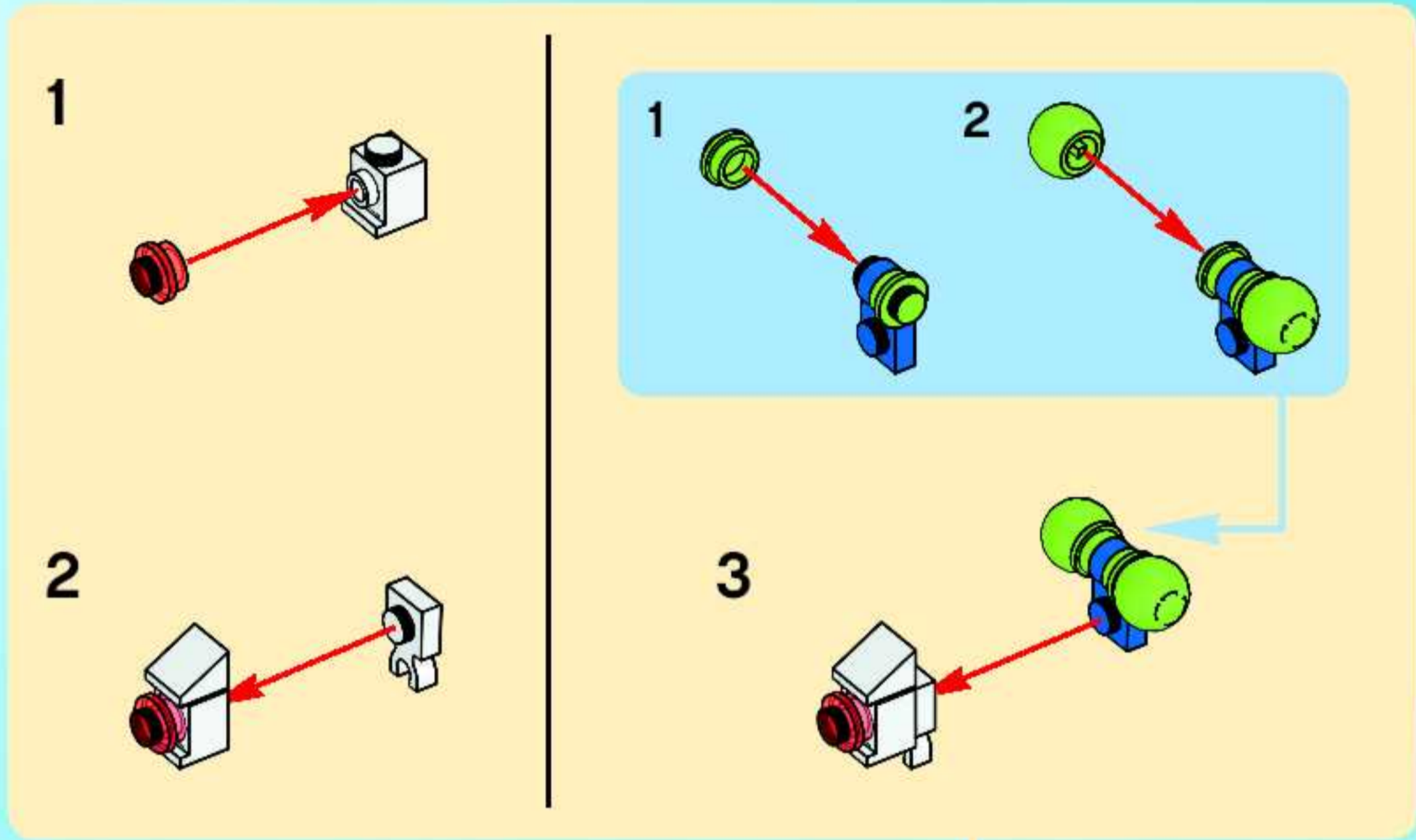

6

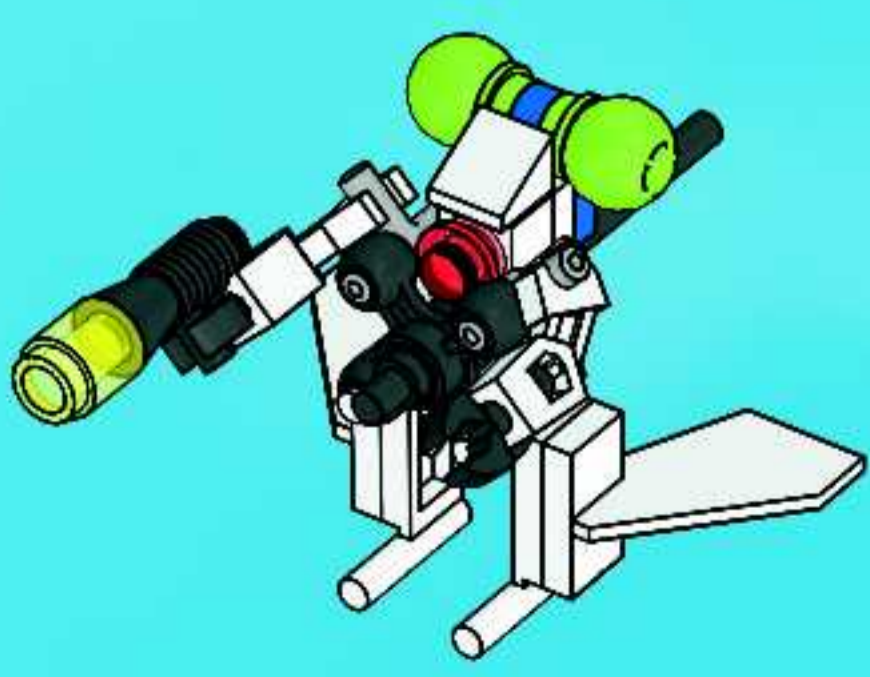

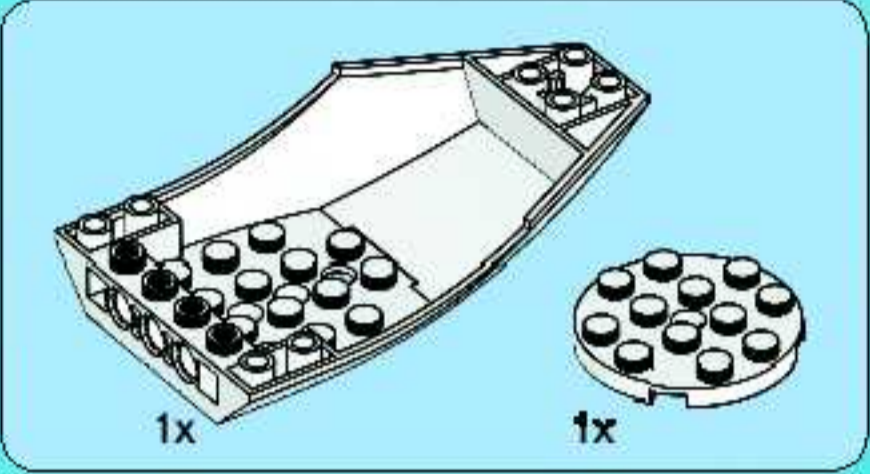
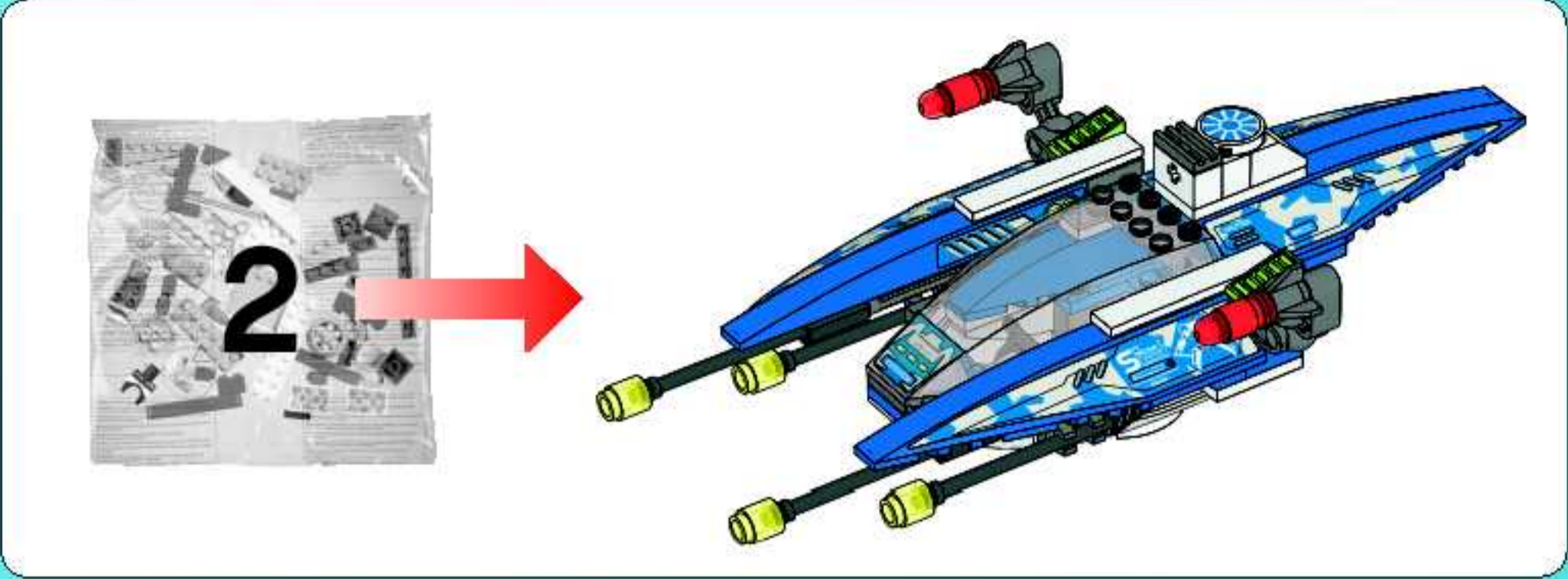

1

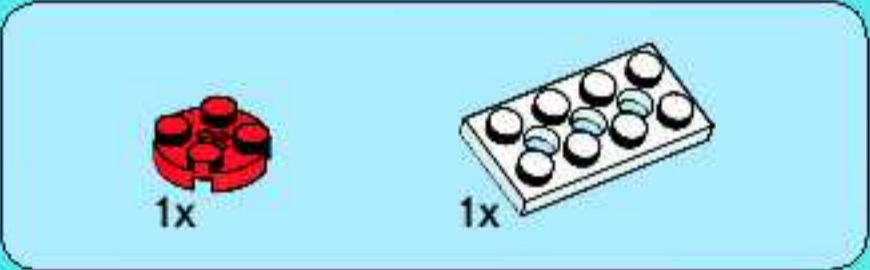
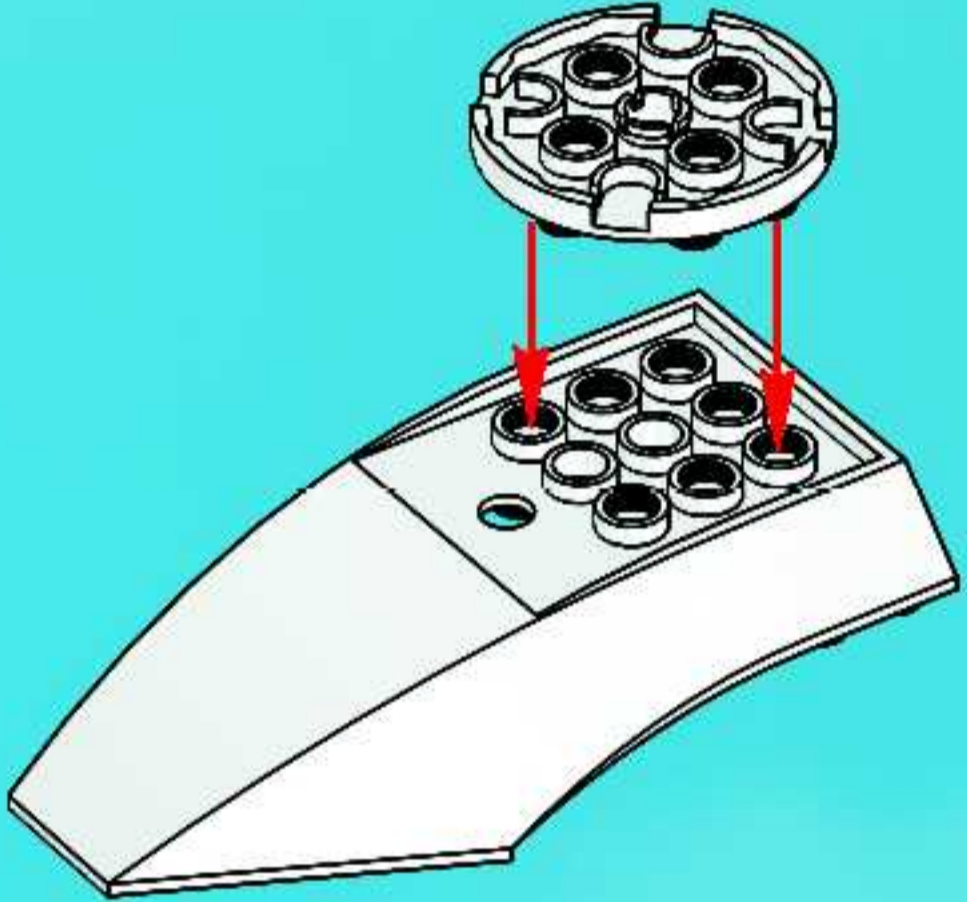

2

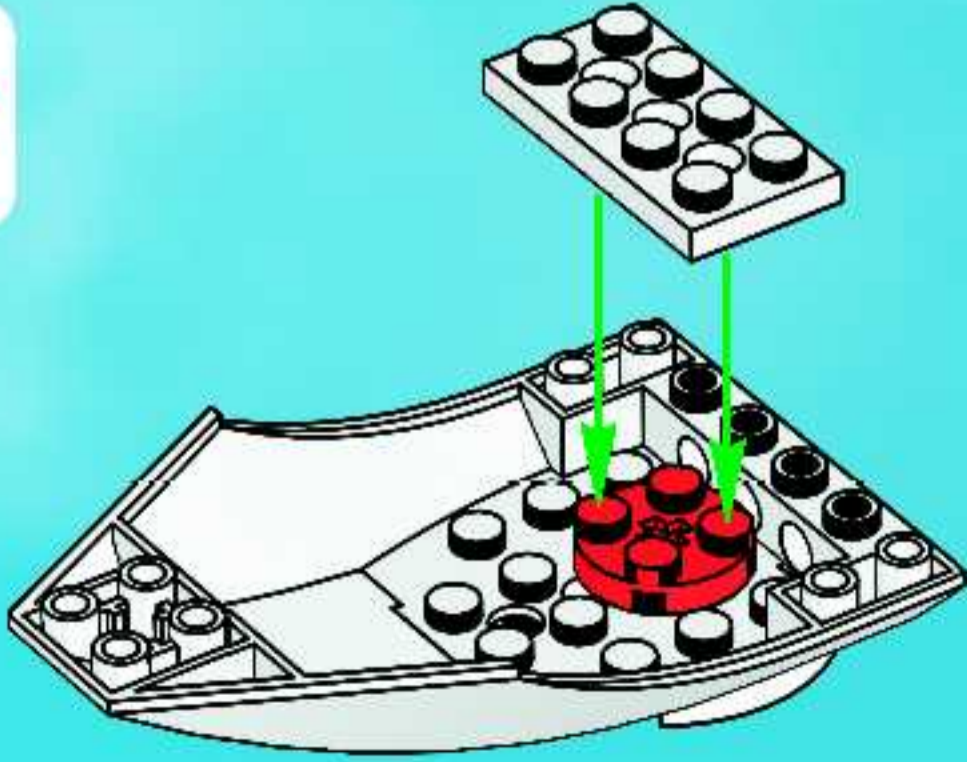

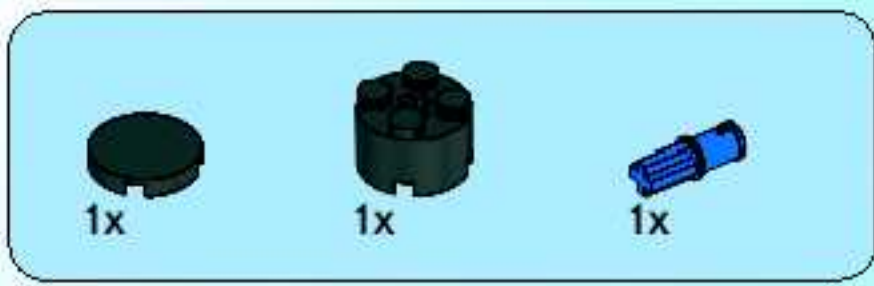

3

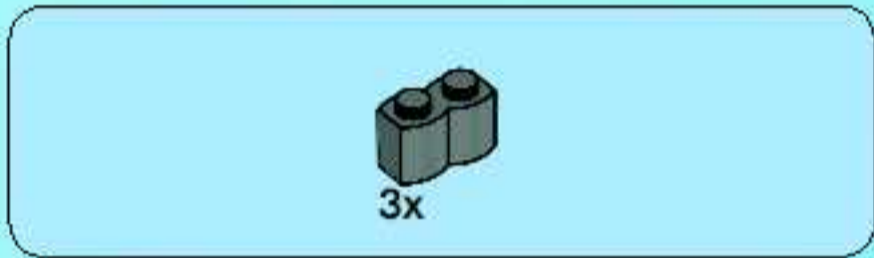
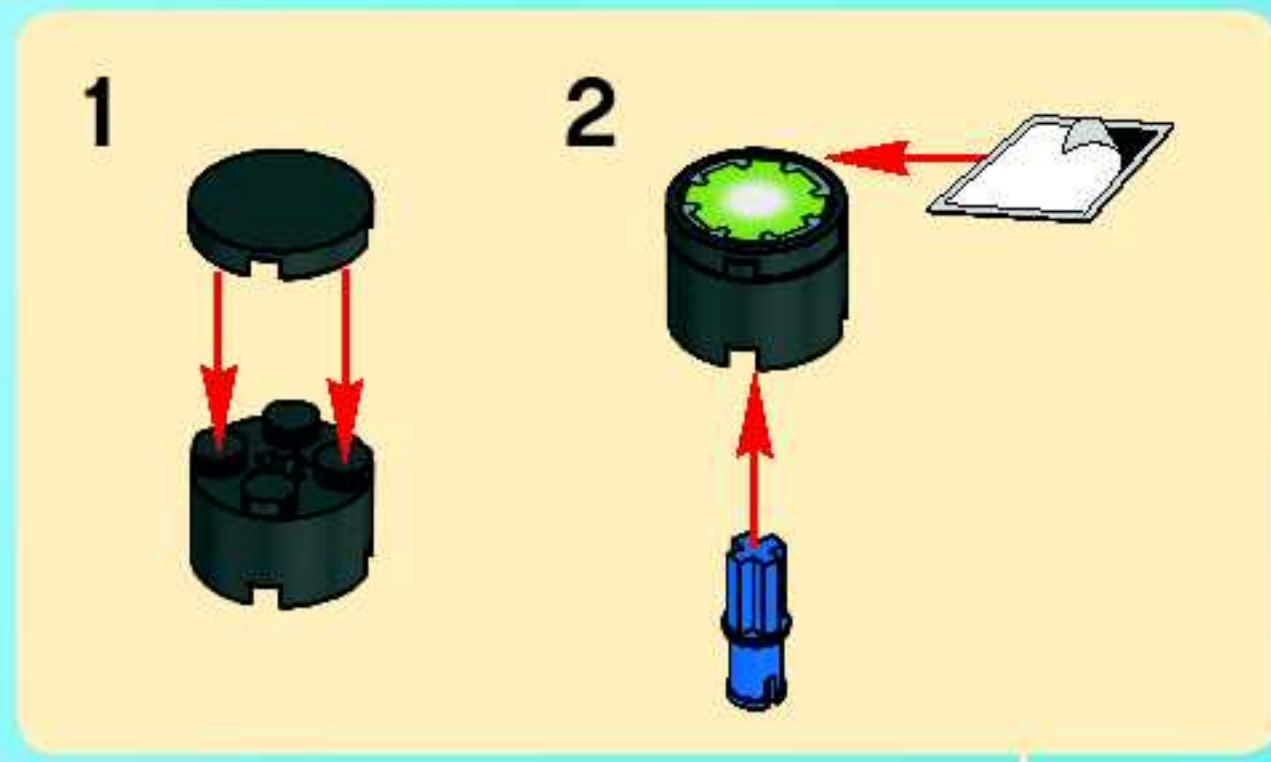

4

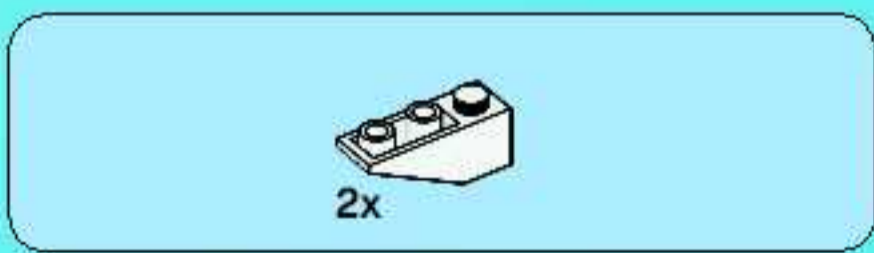

5

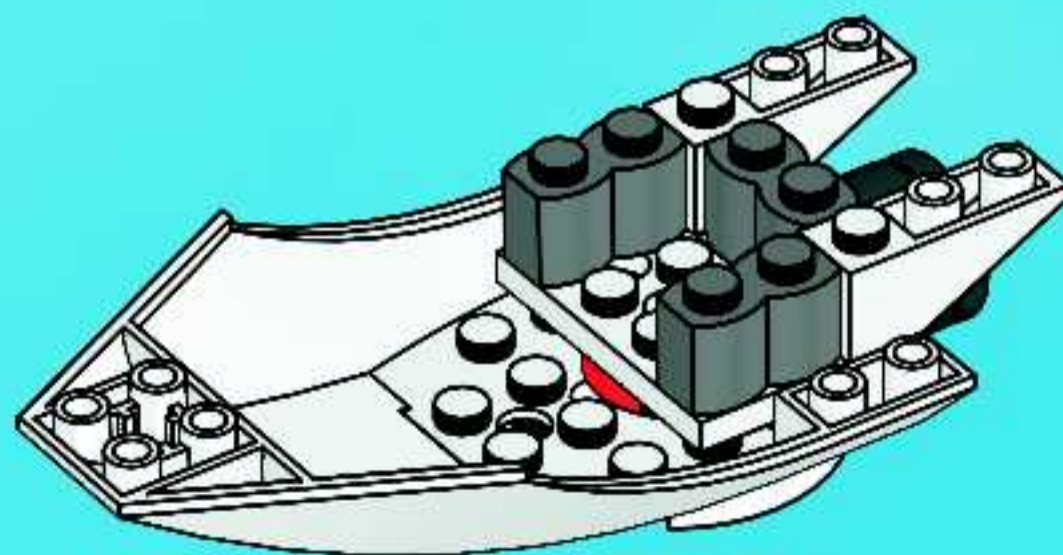

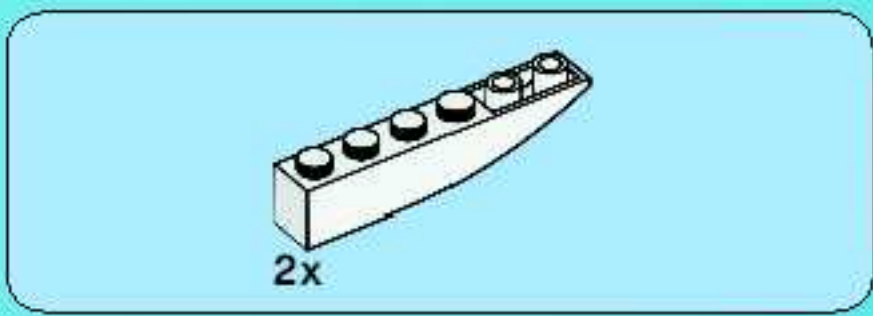

6

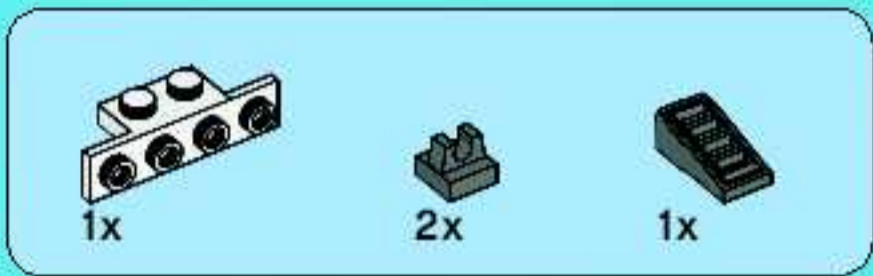
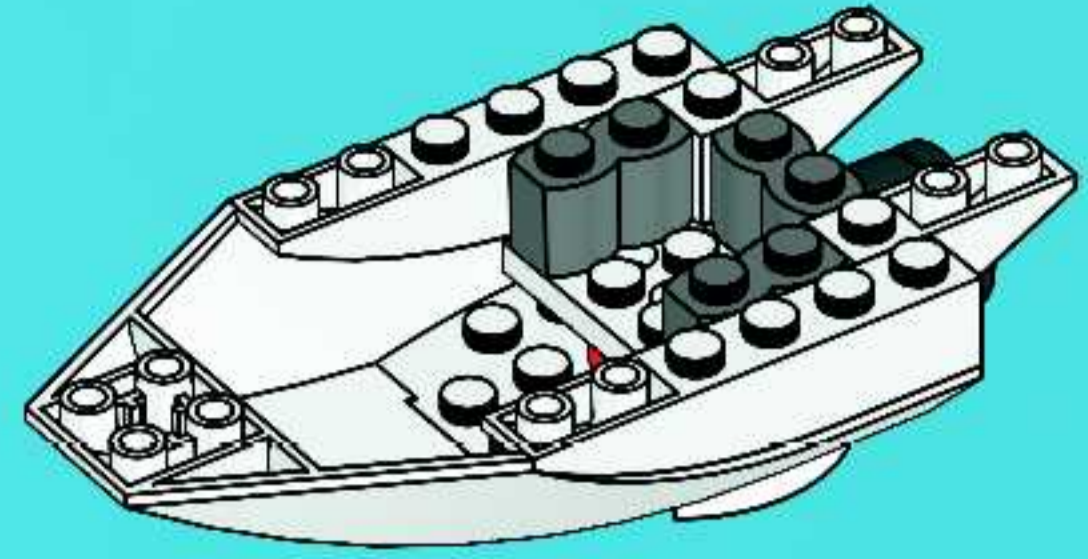

7

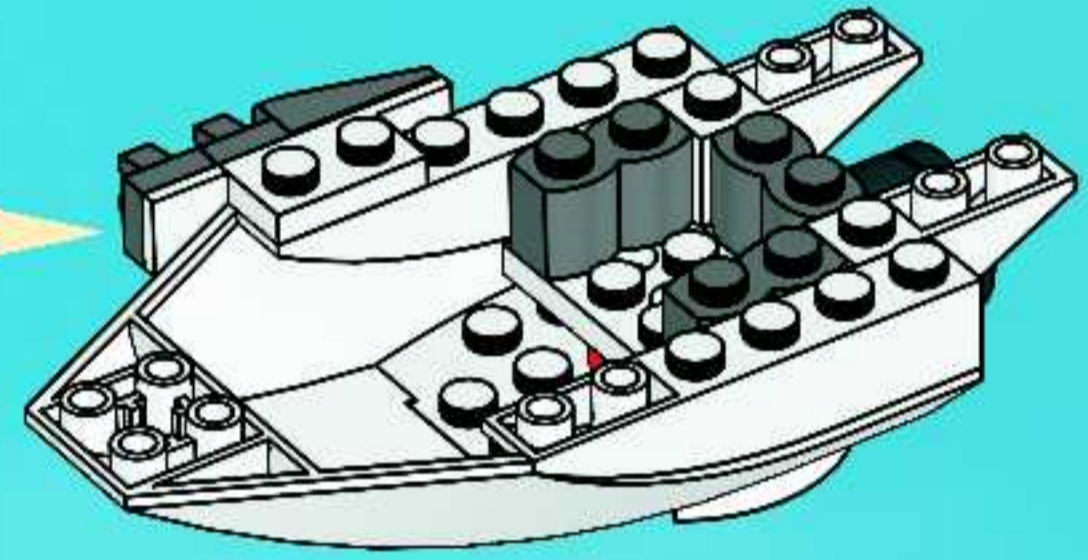
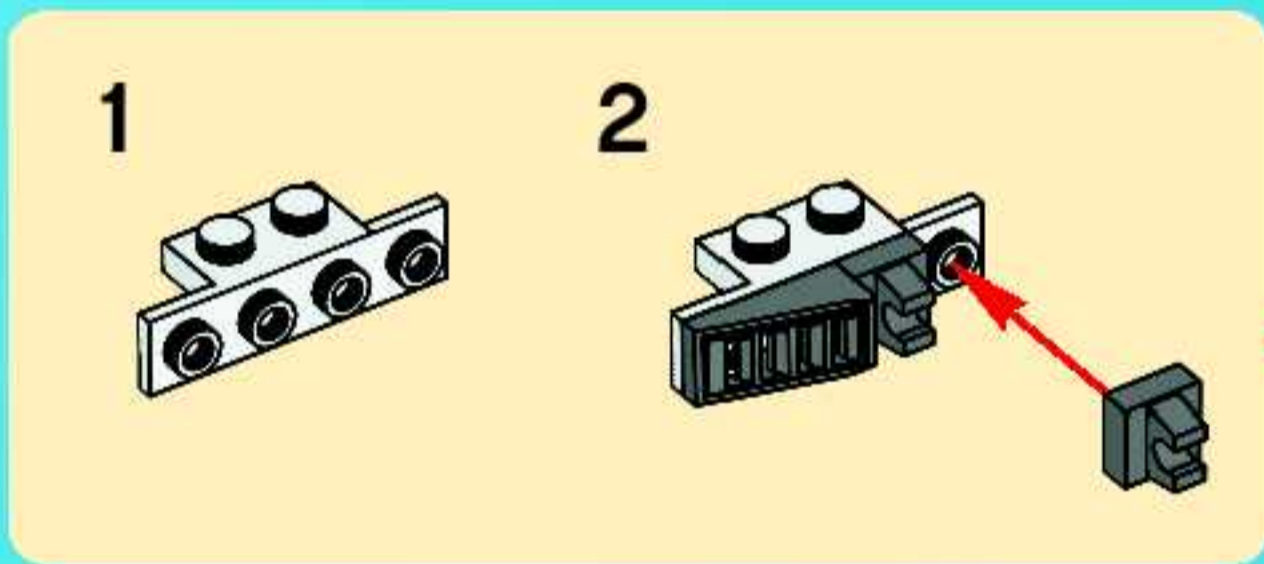

8

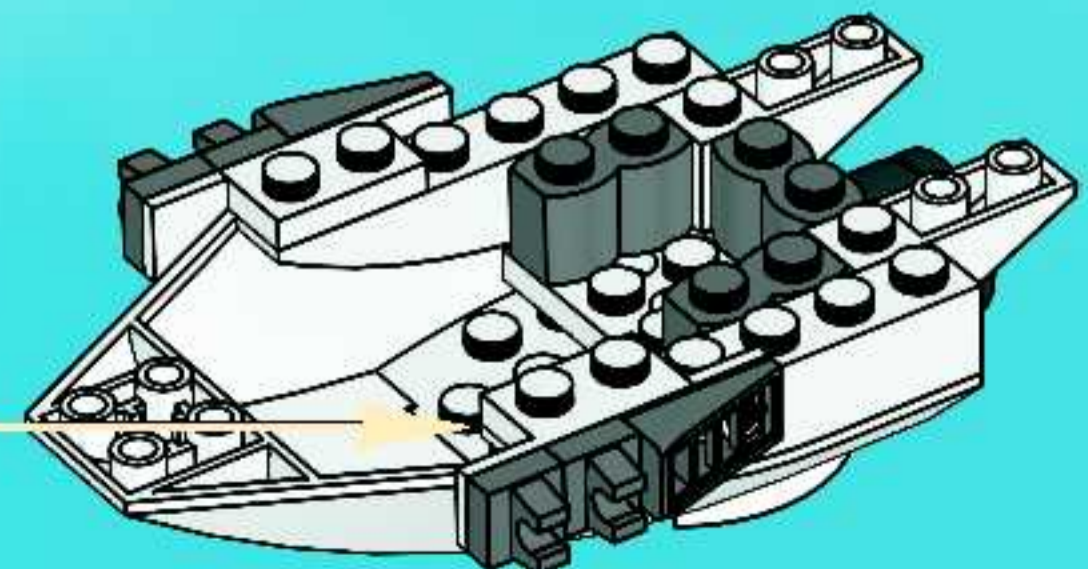
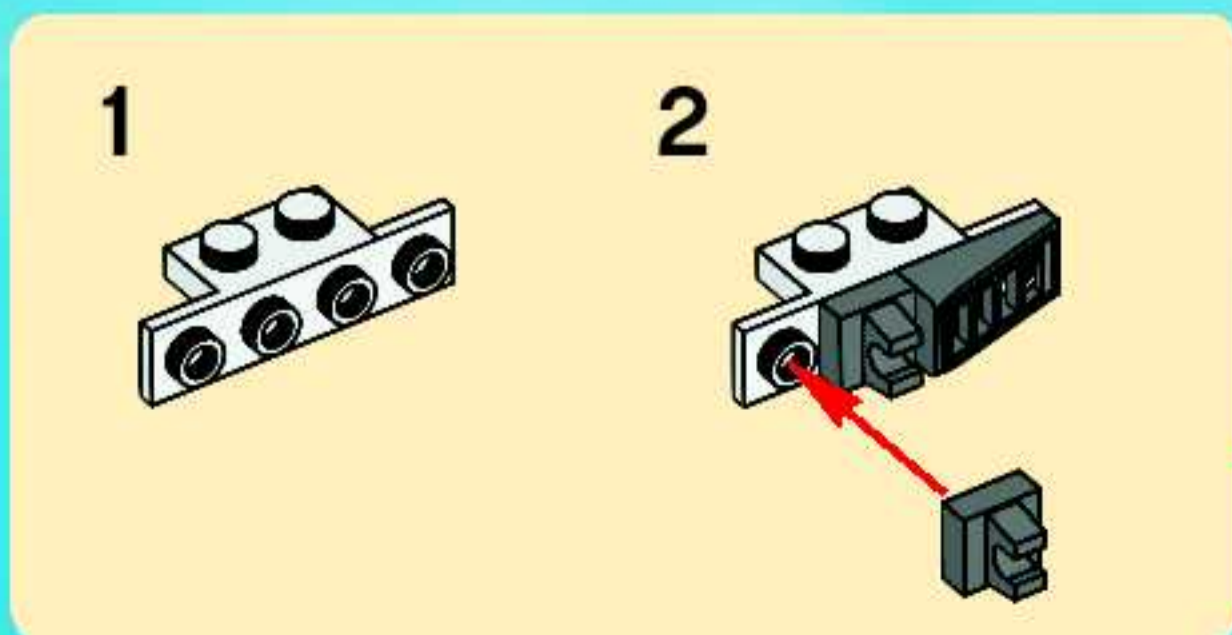

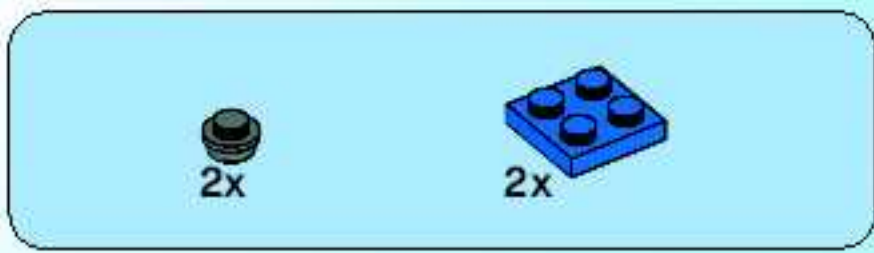

9

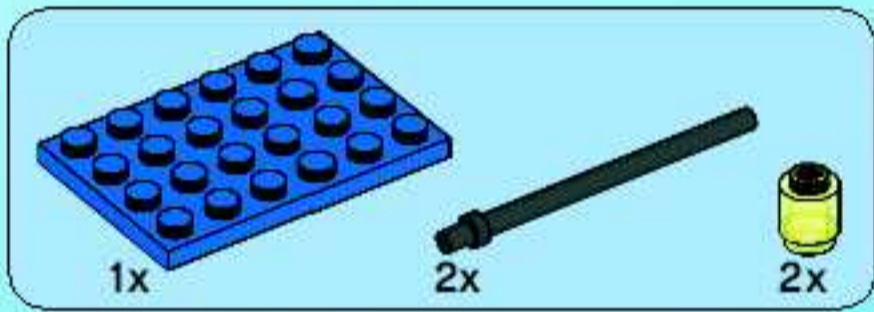
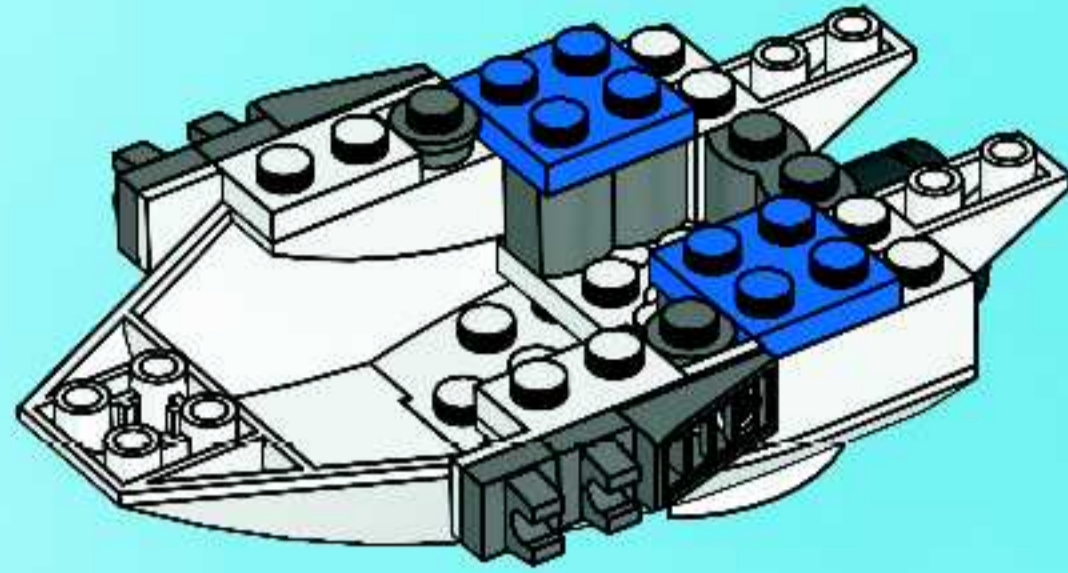

10

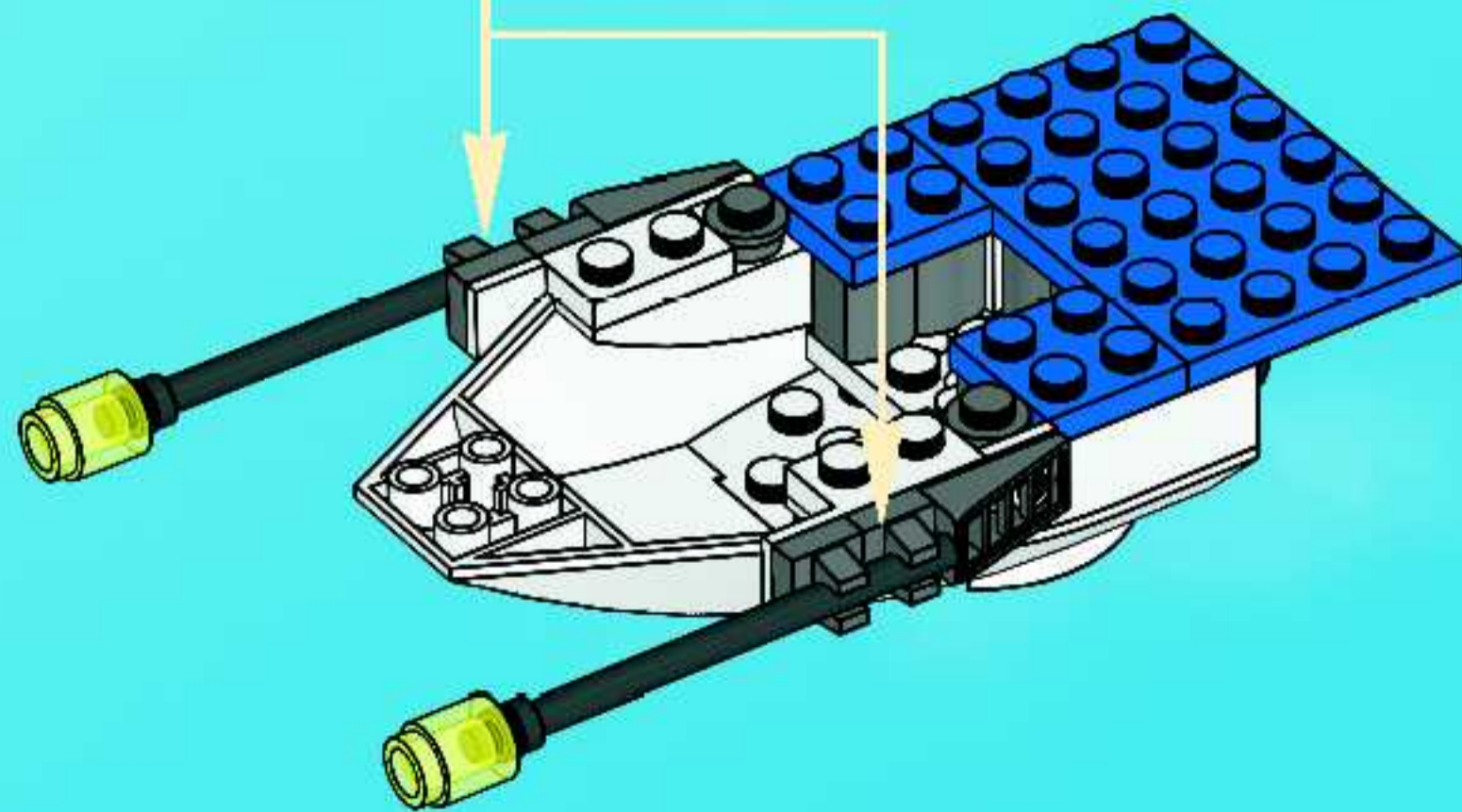
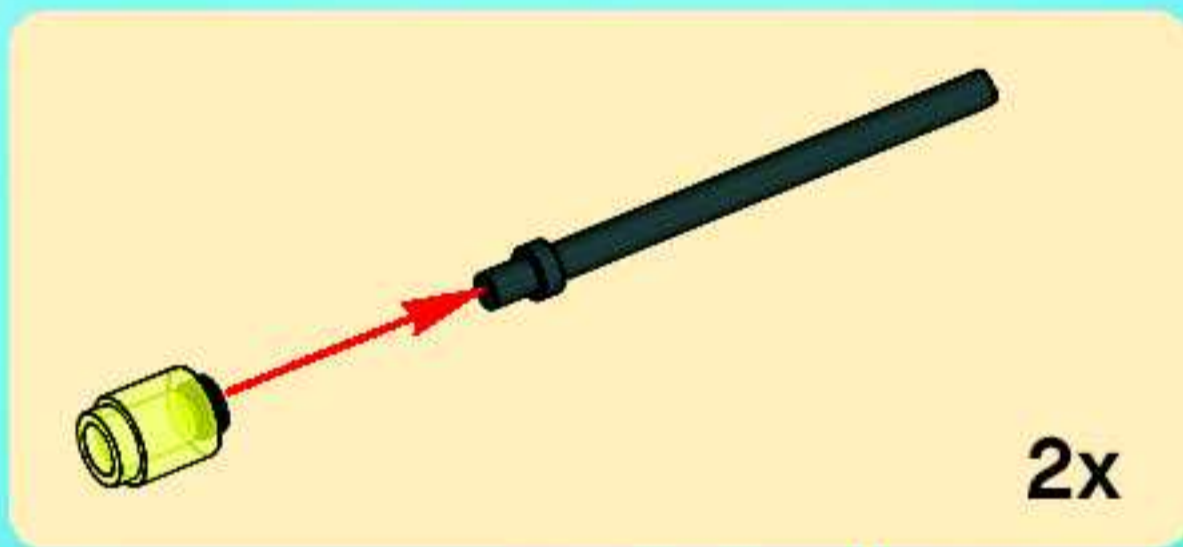

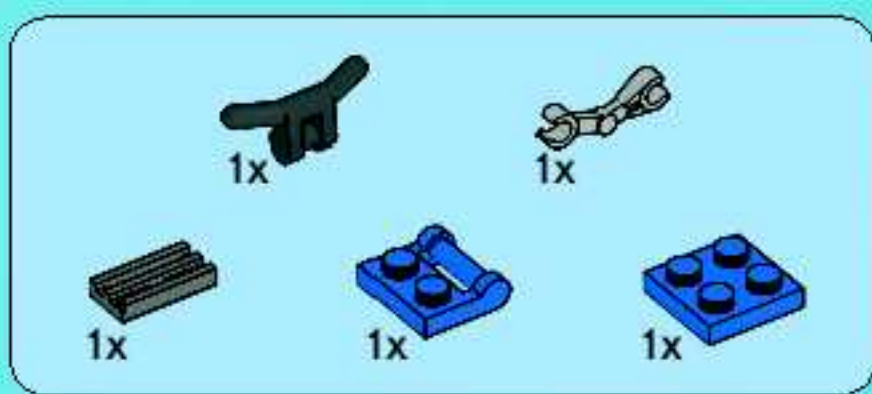

11

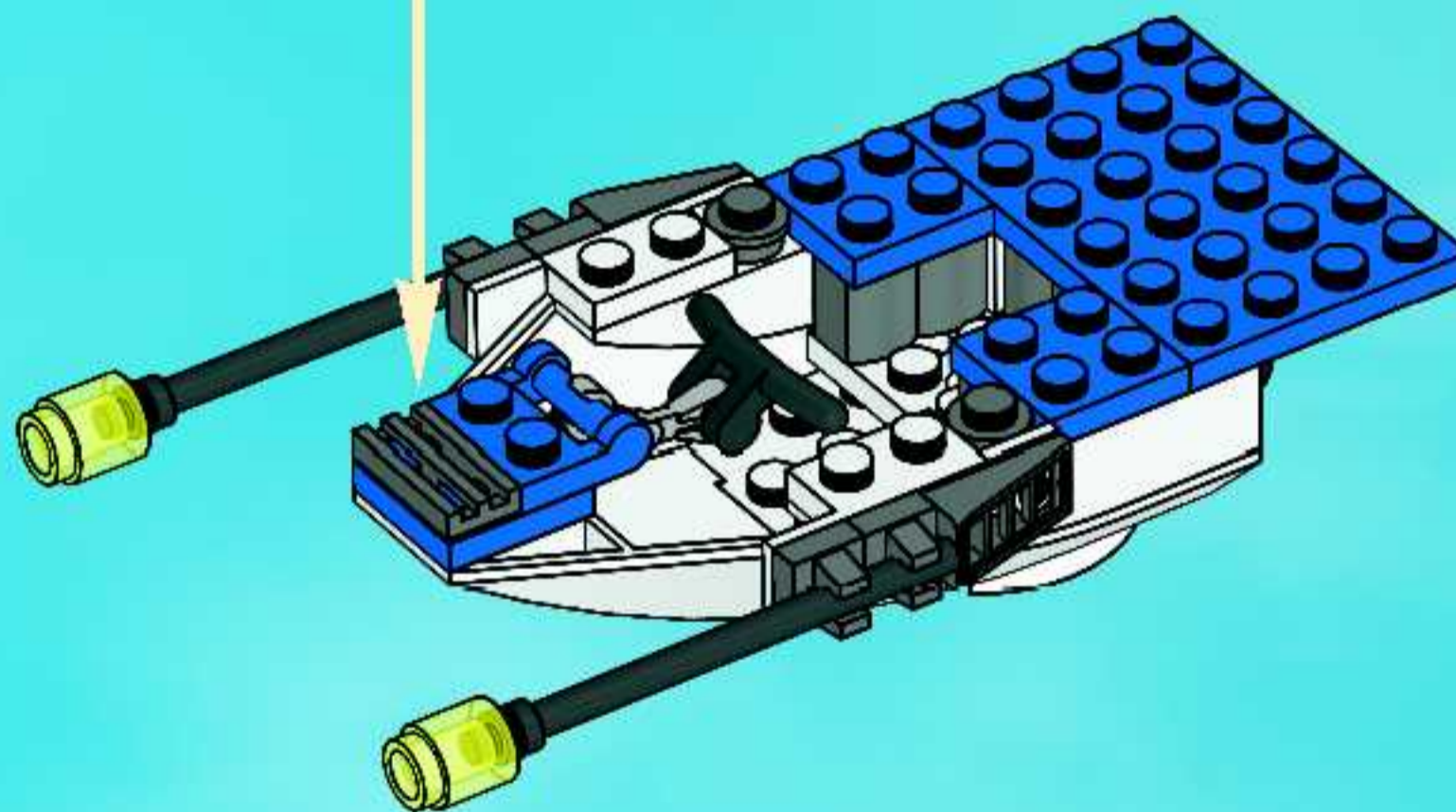
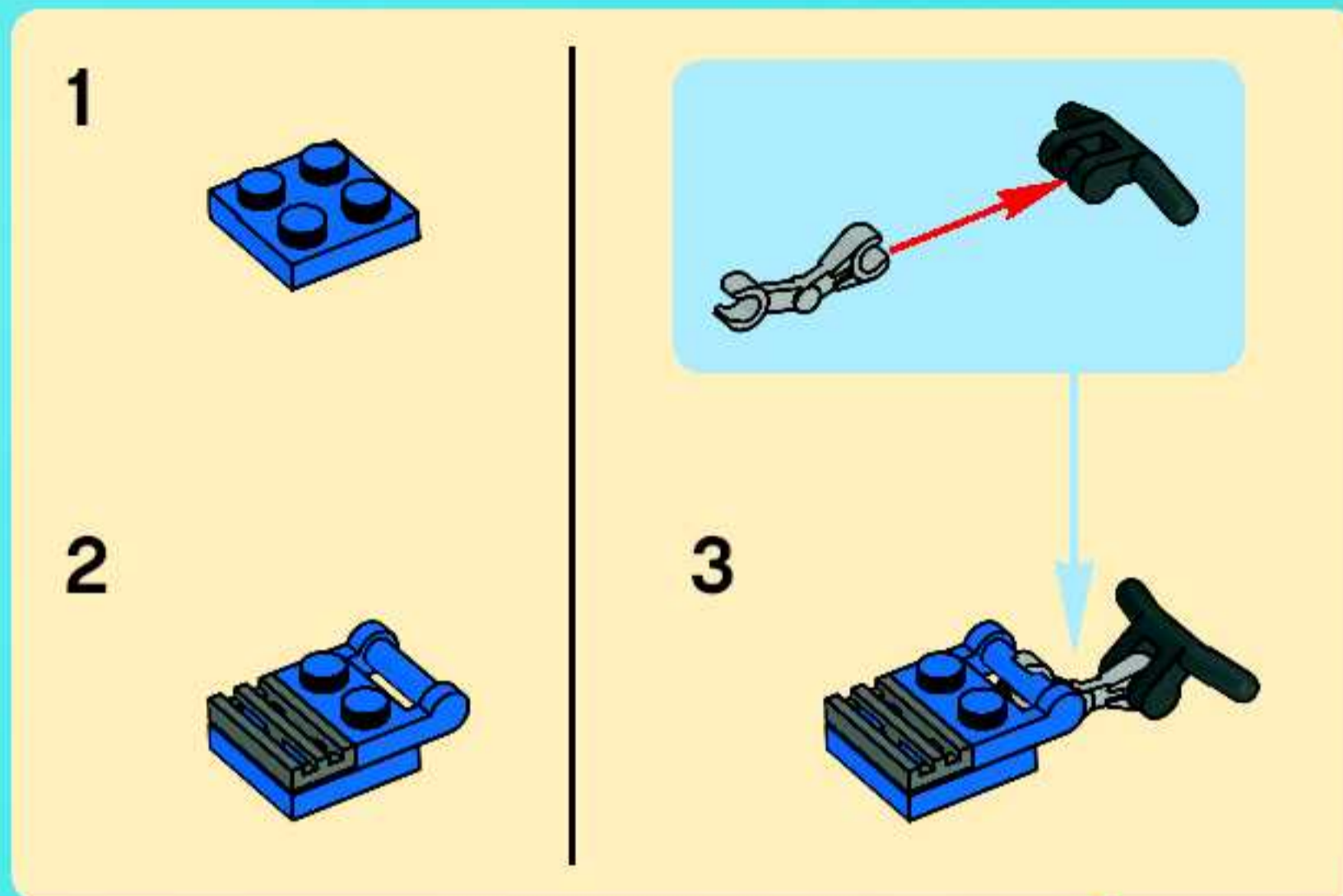

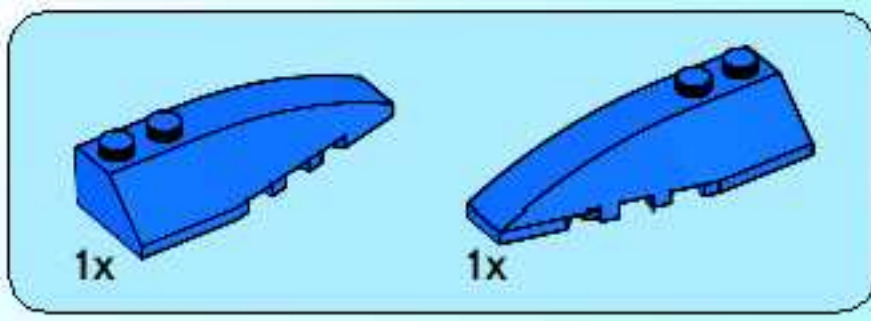

12

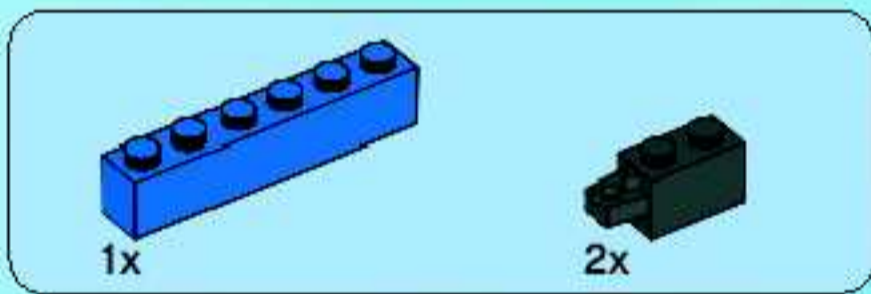
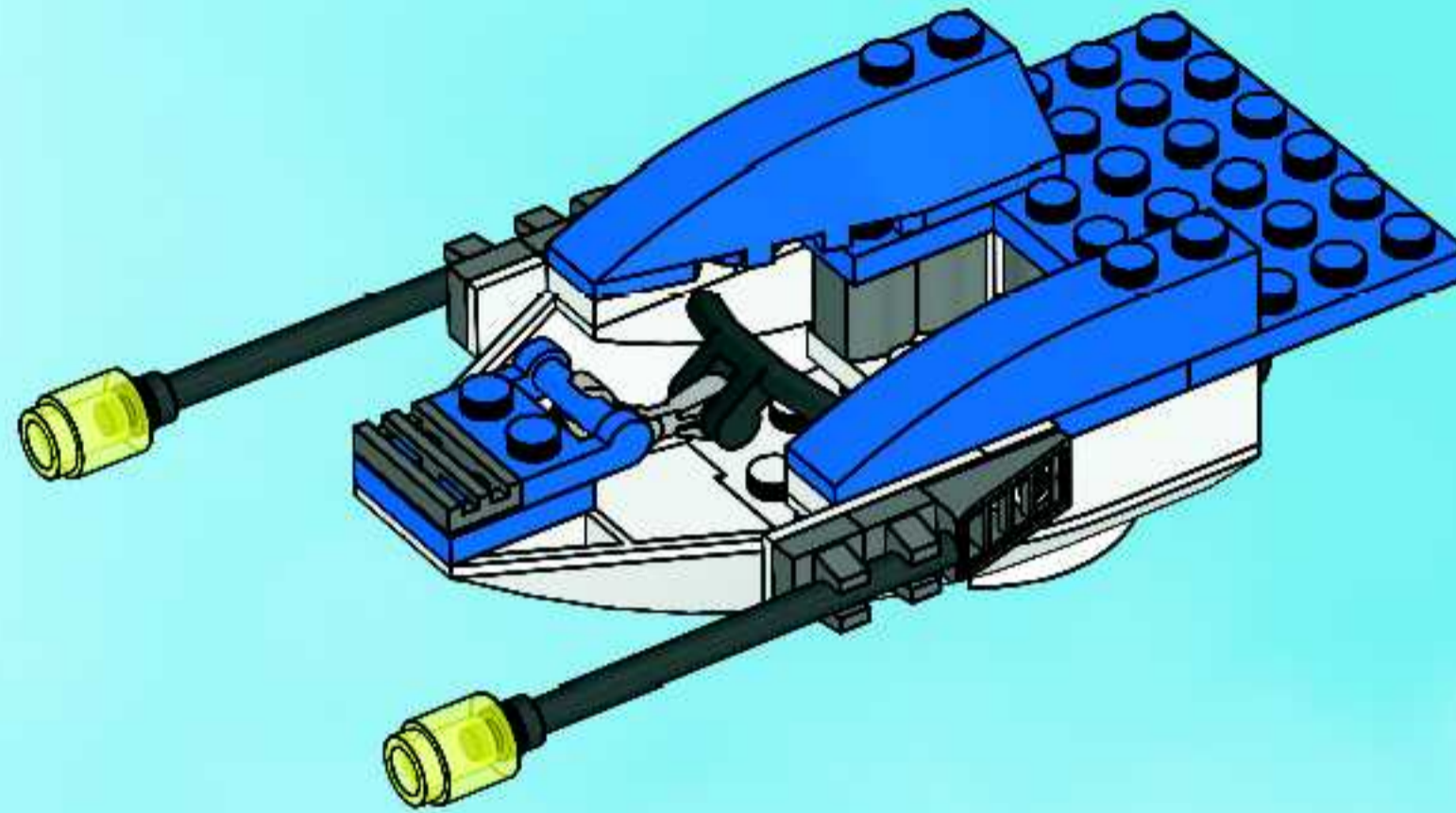

13

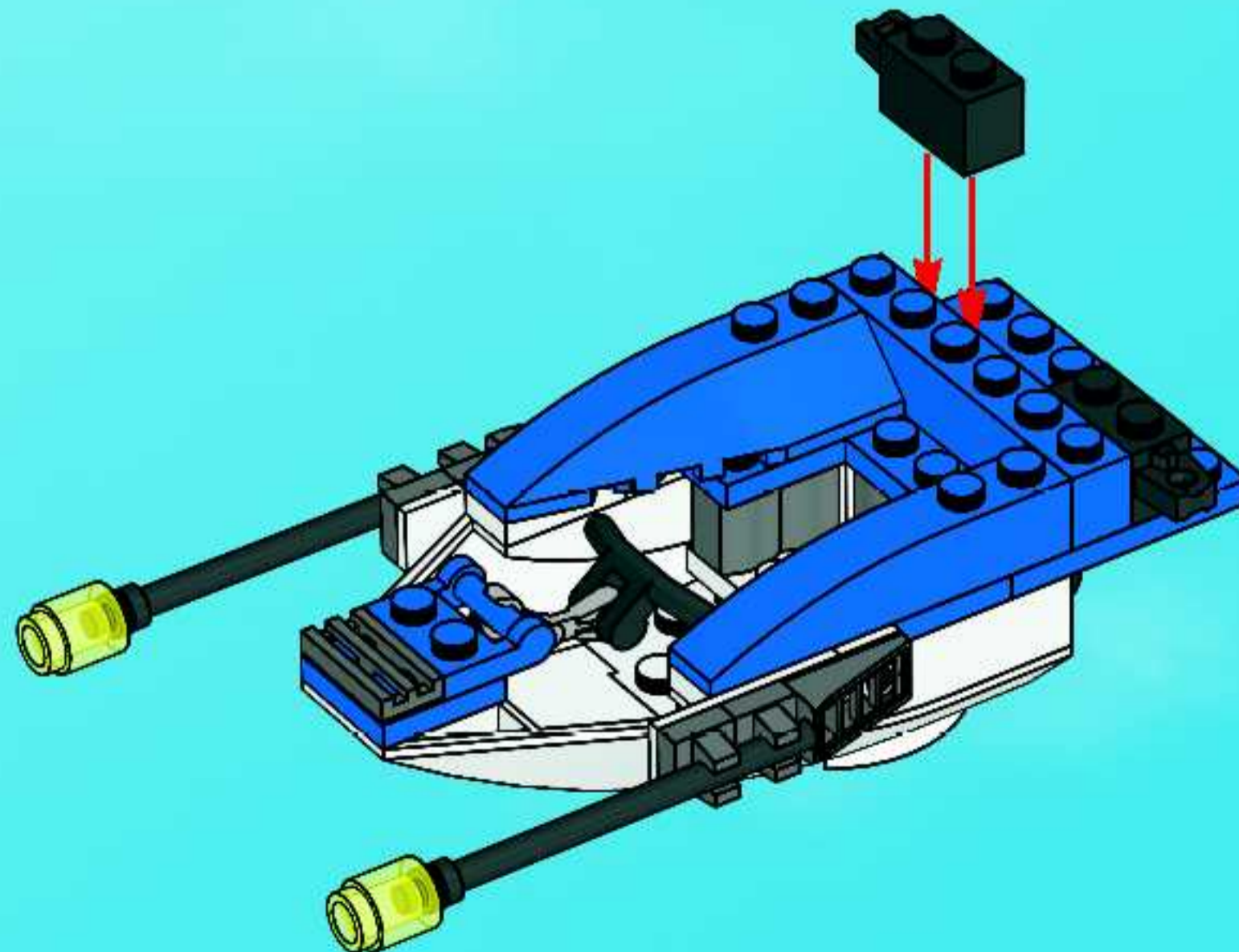



14

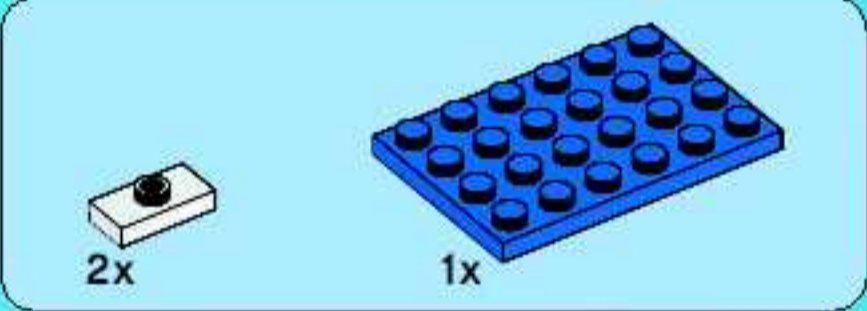
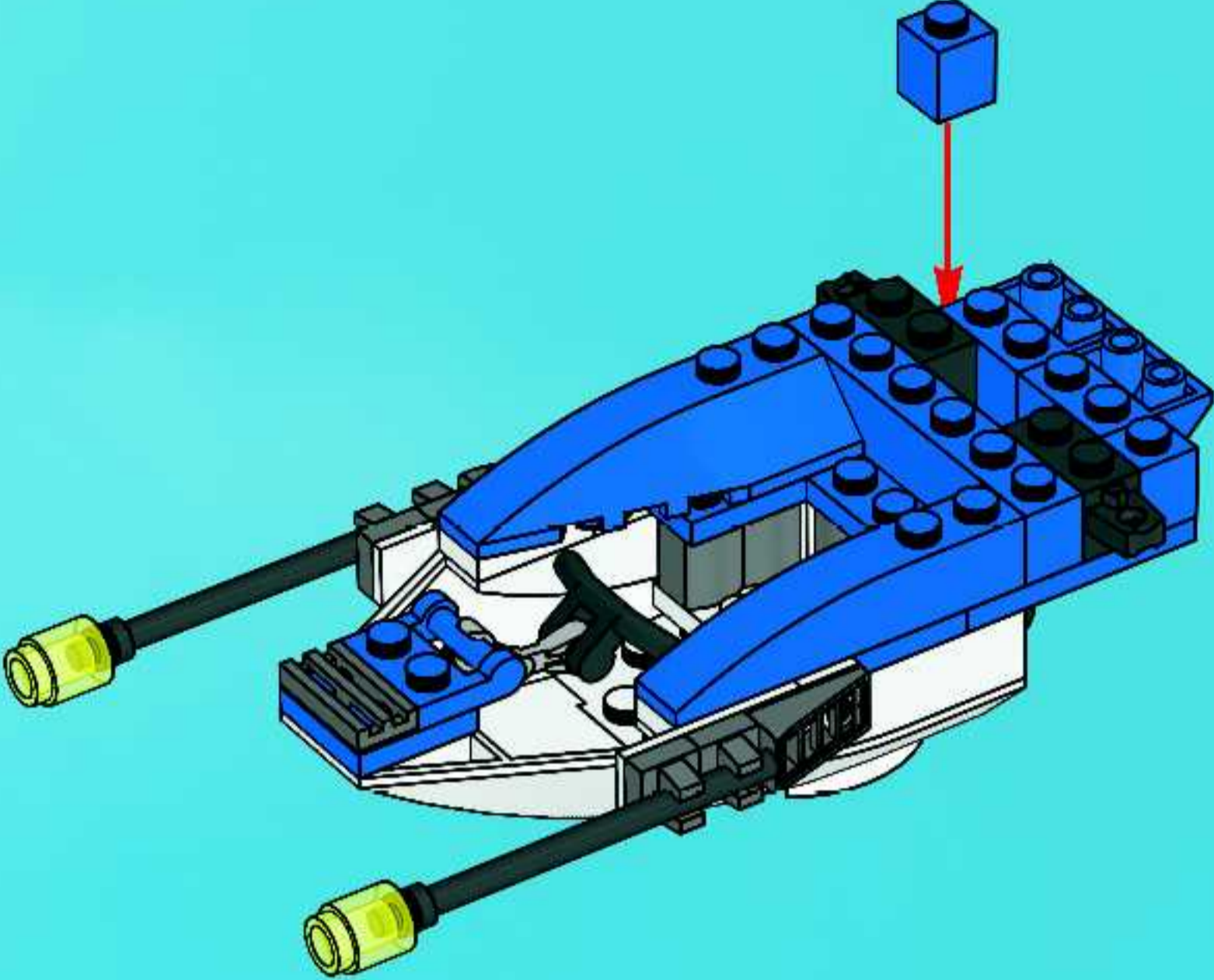

15

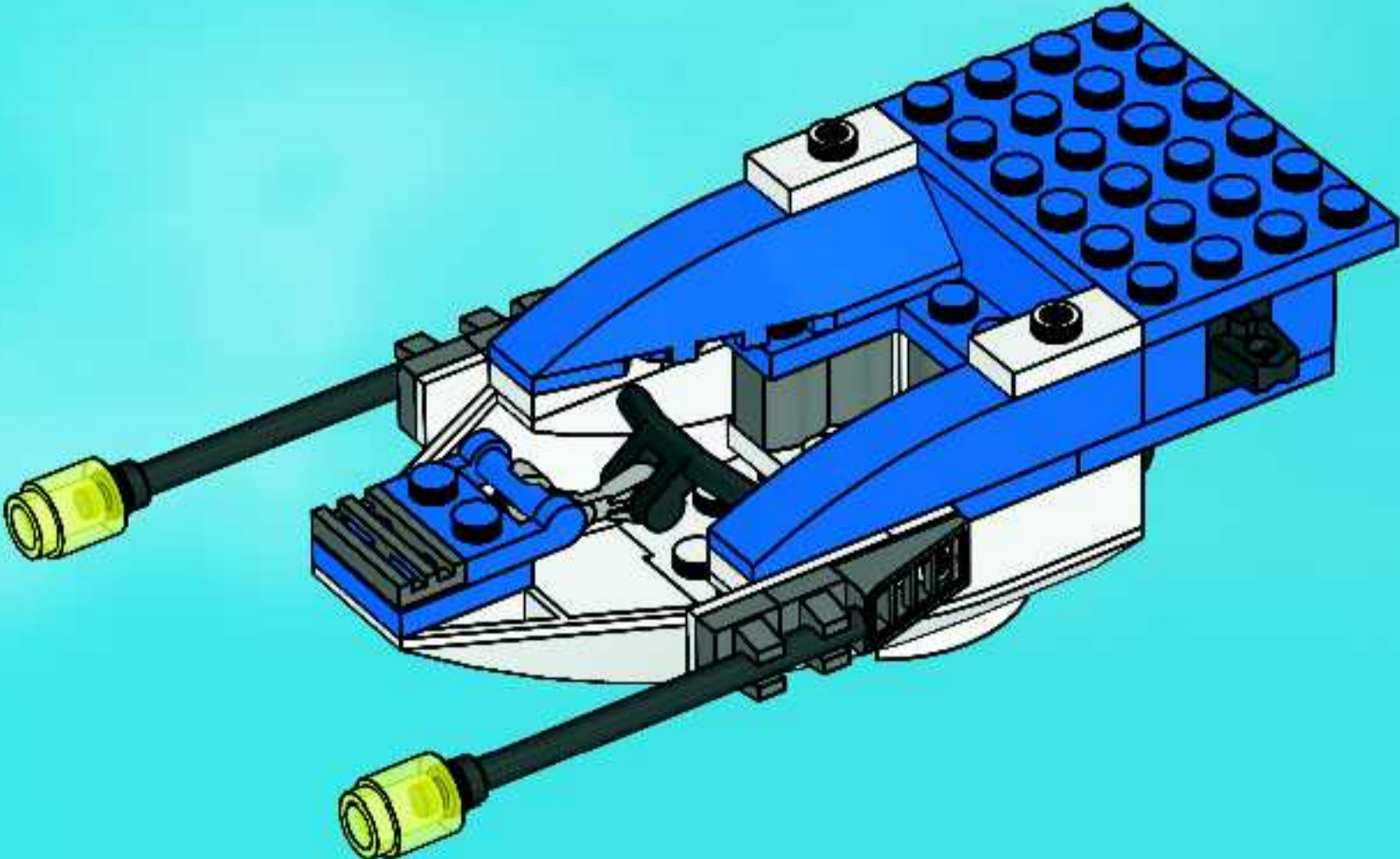

16

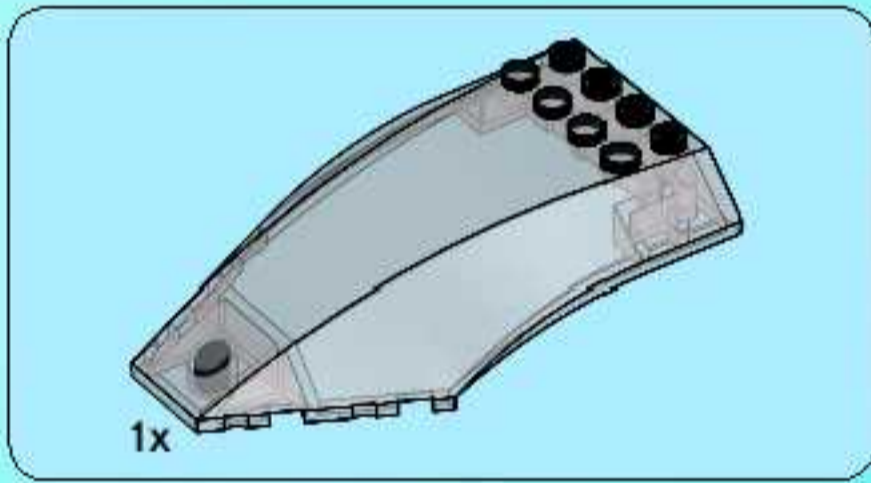
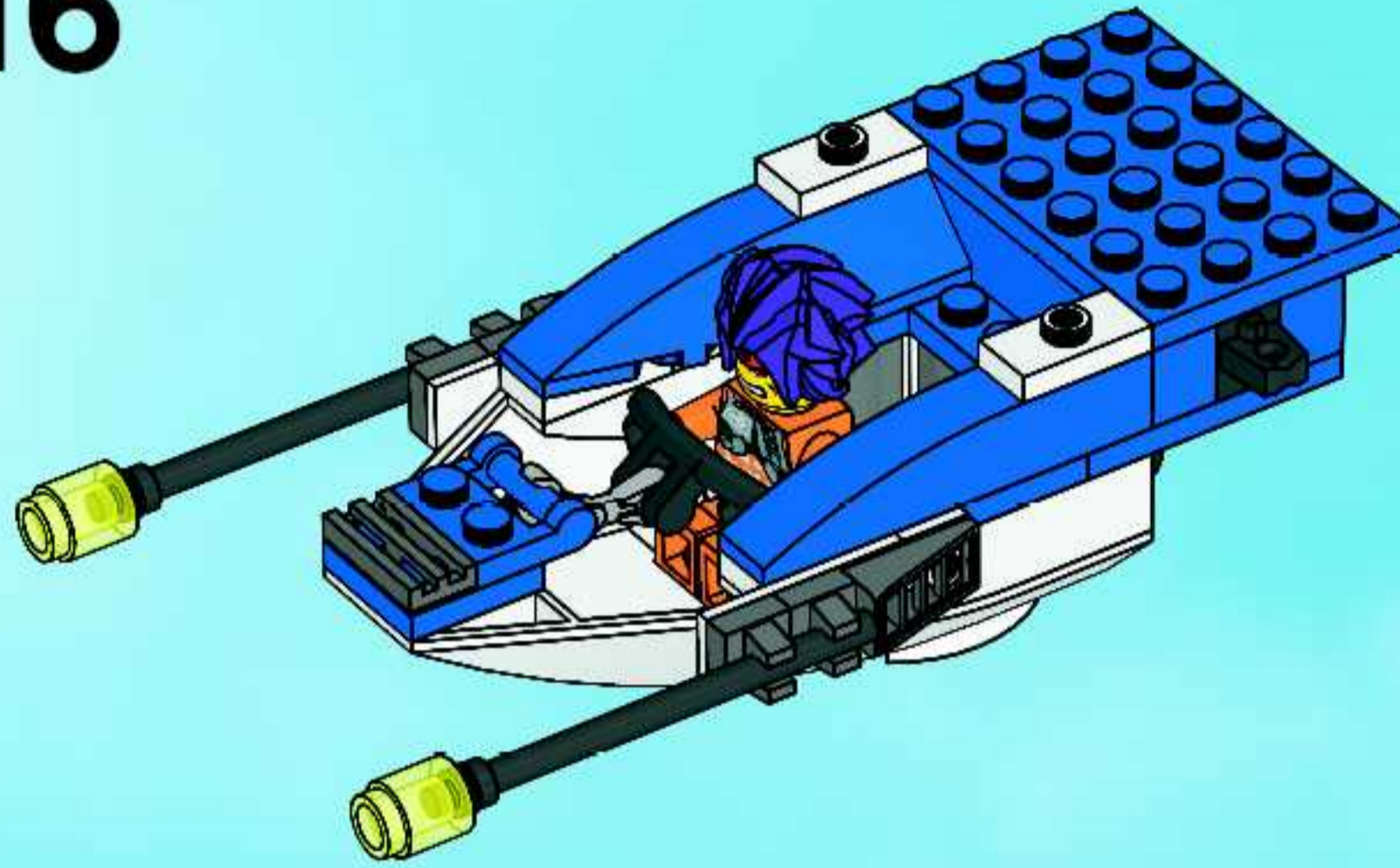

17

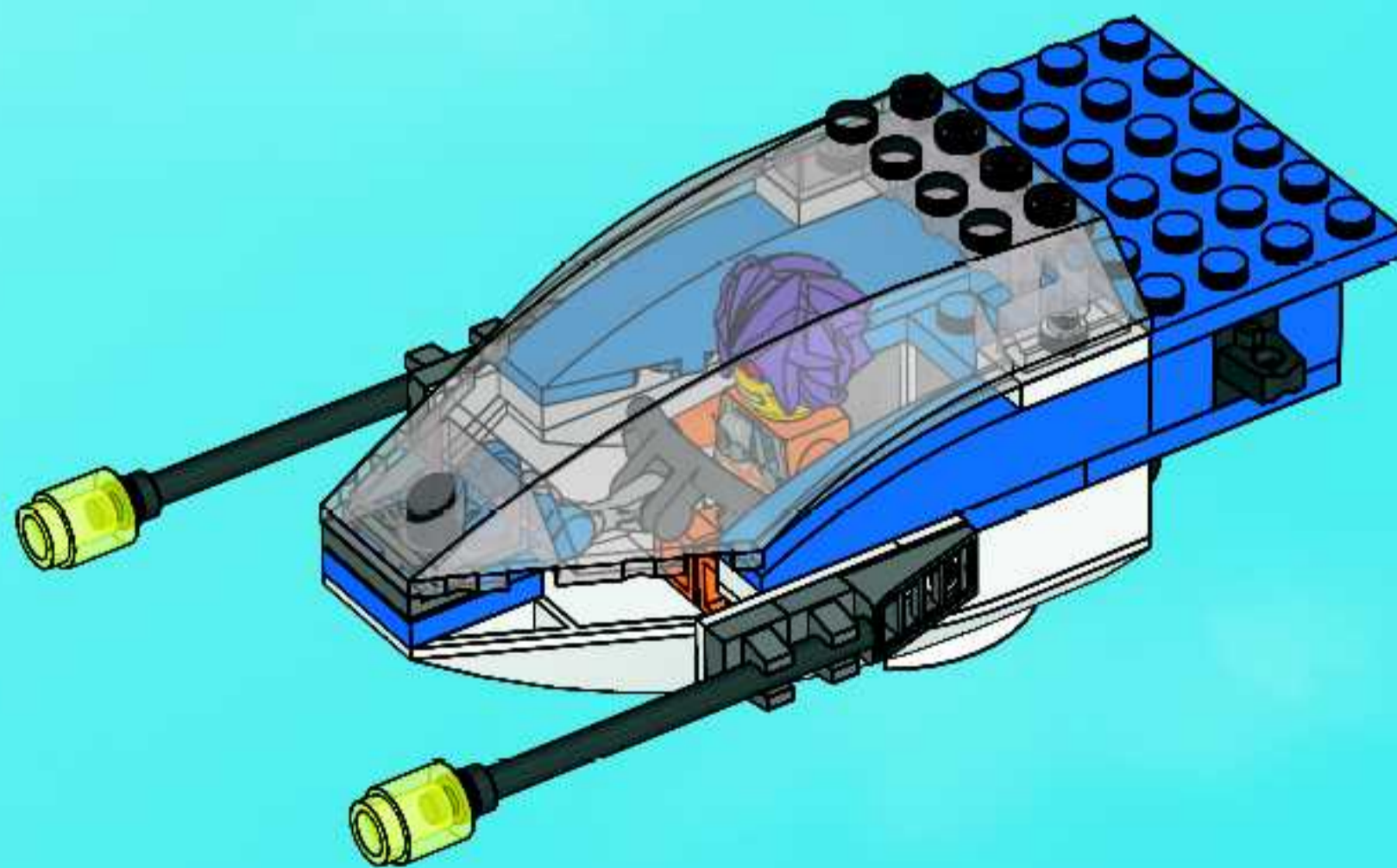

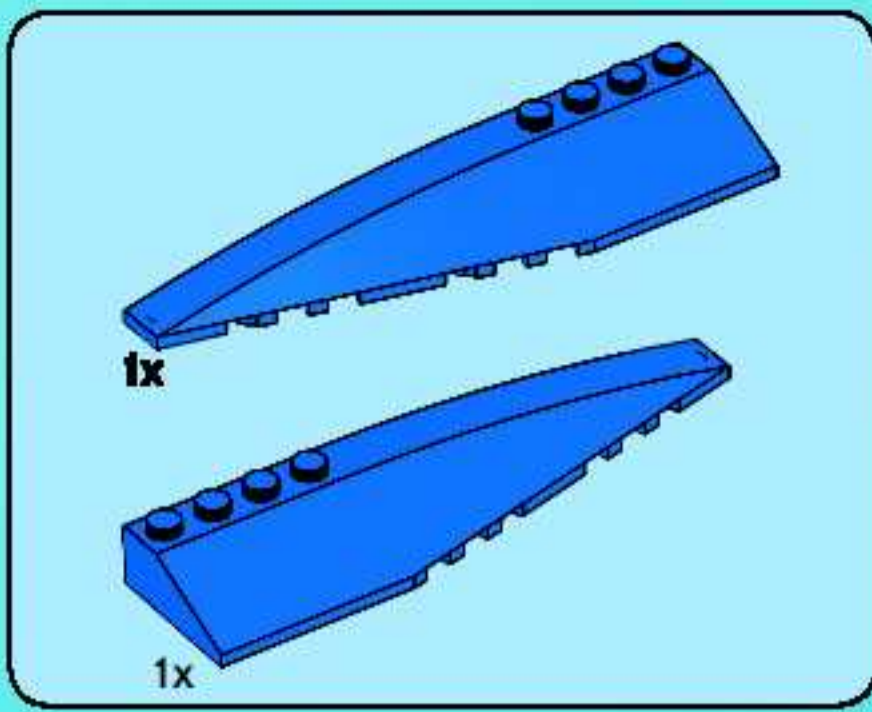

18

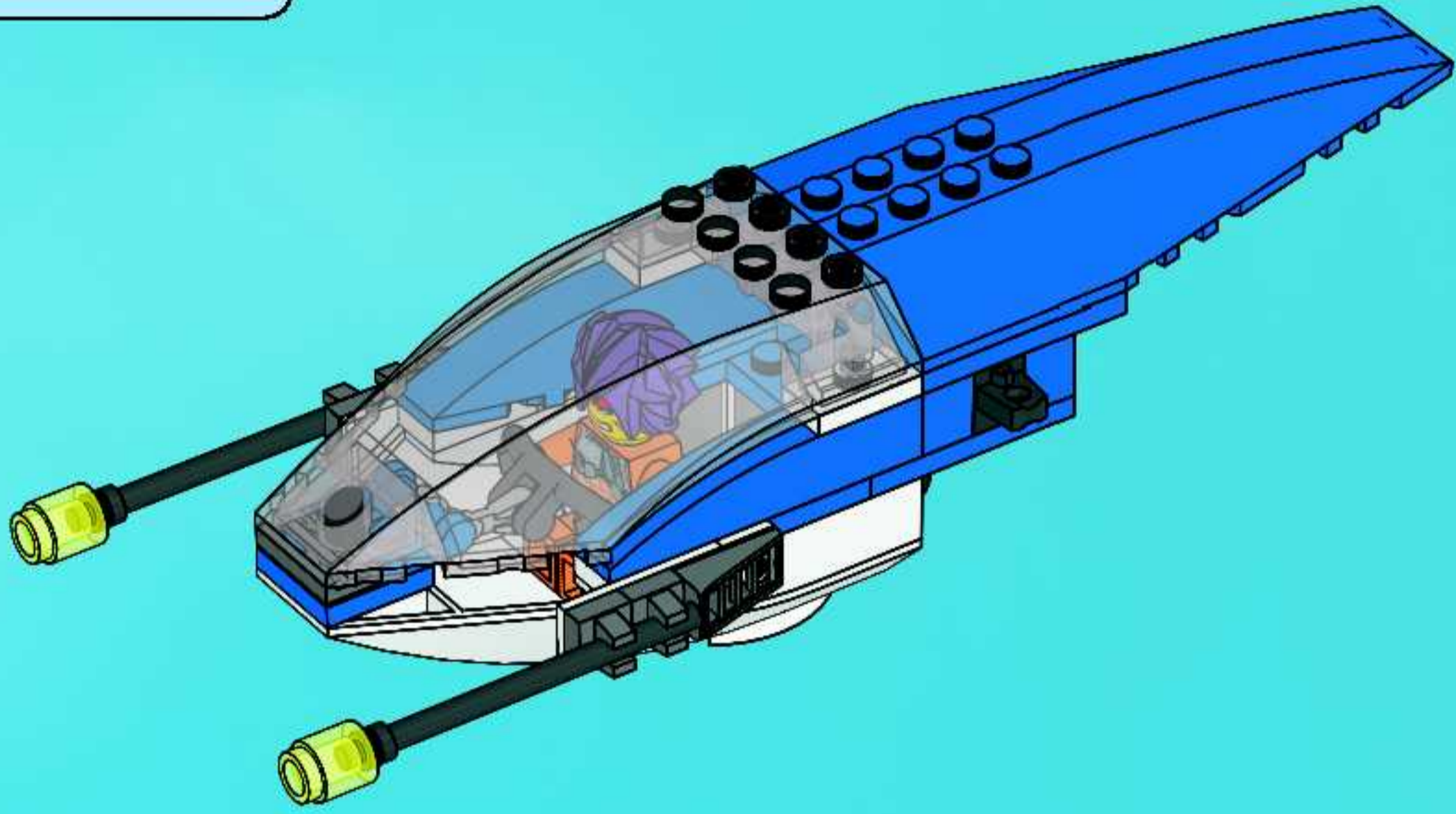

19

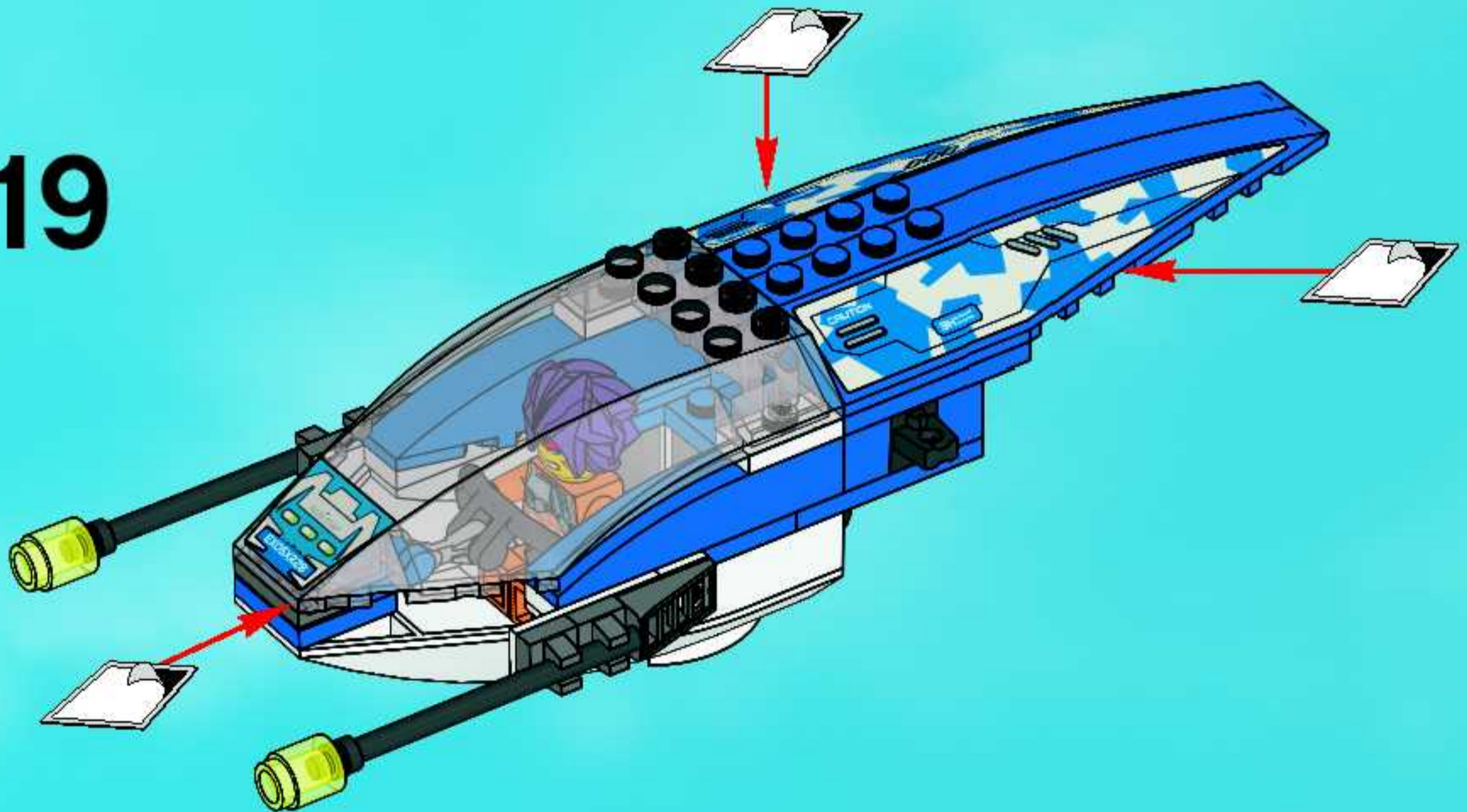

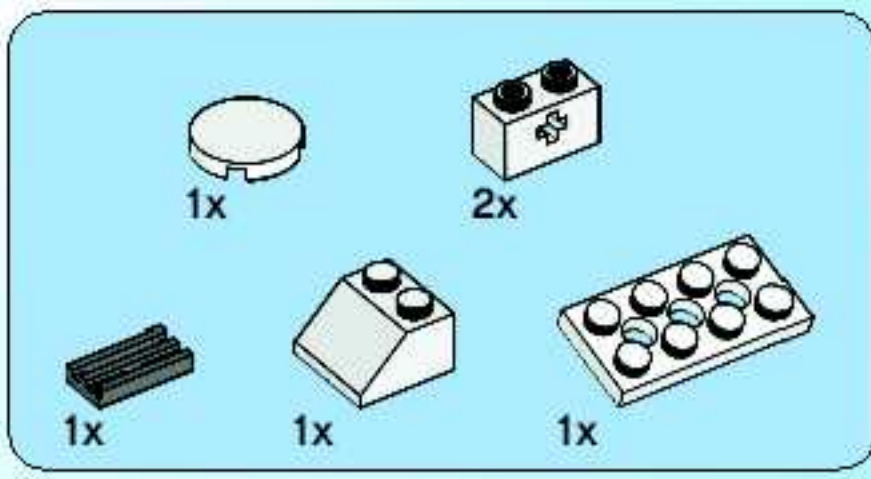

20

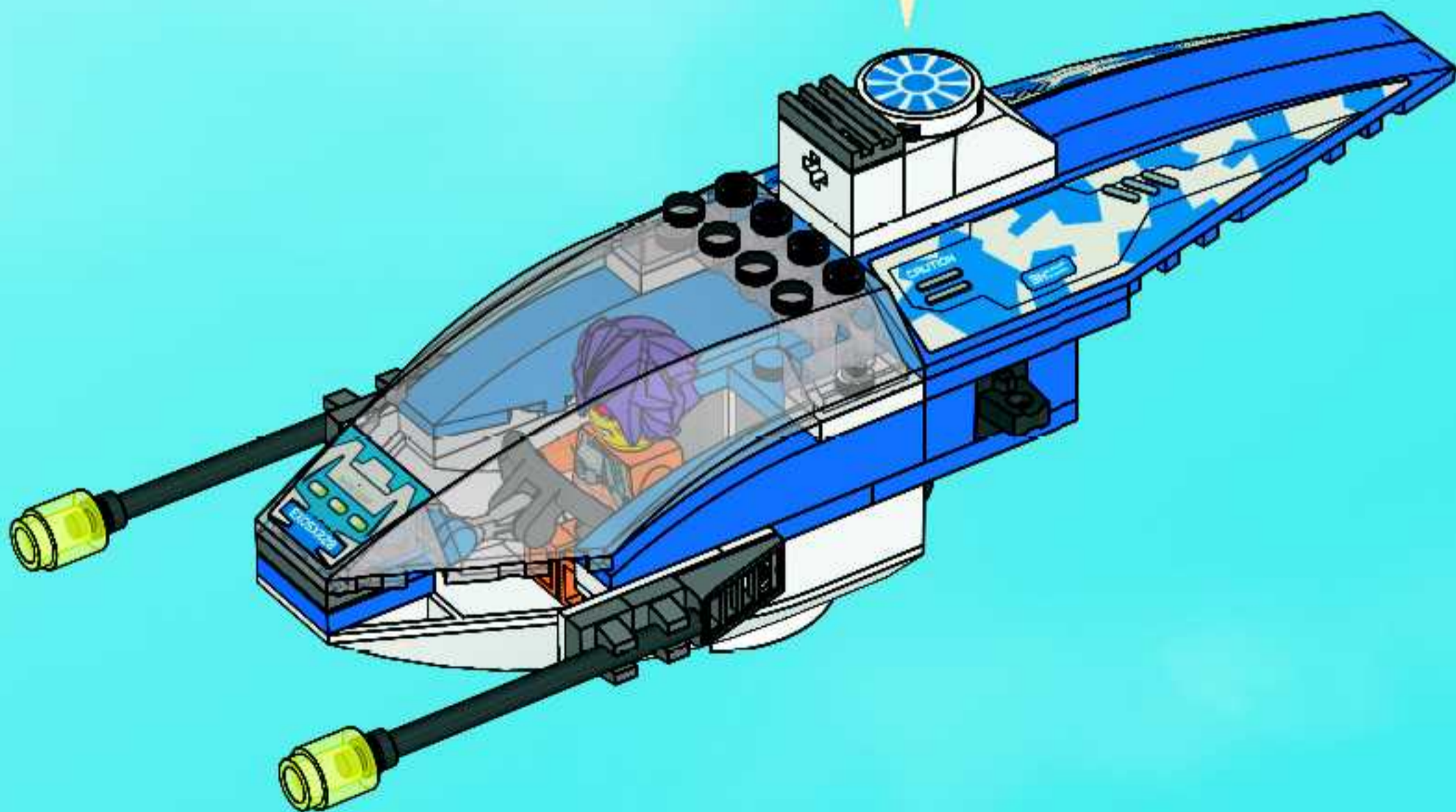
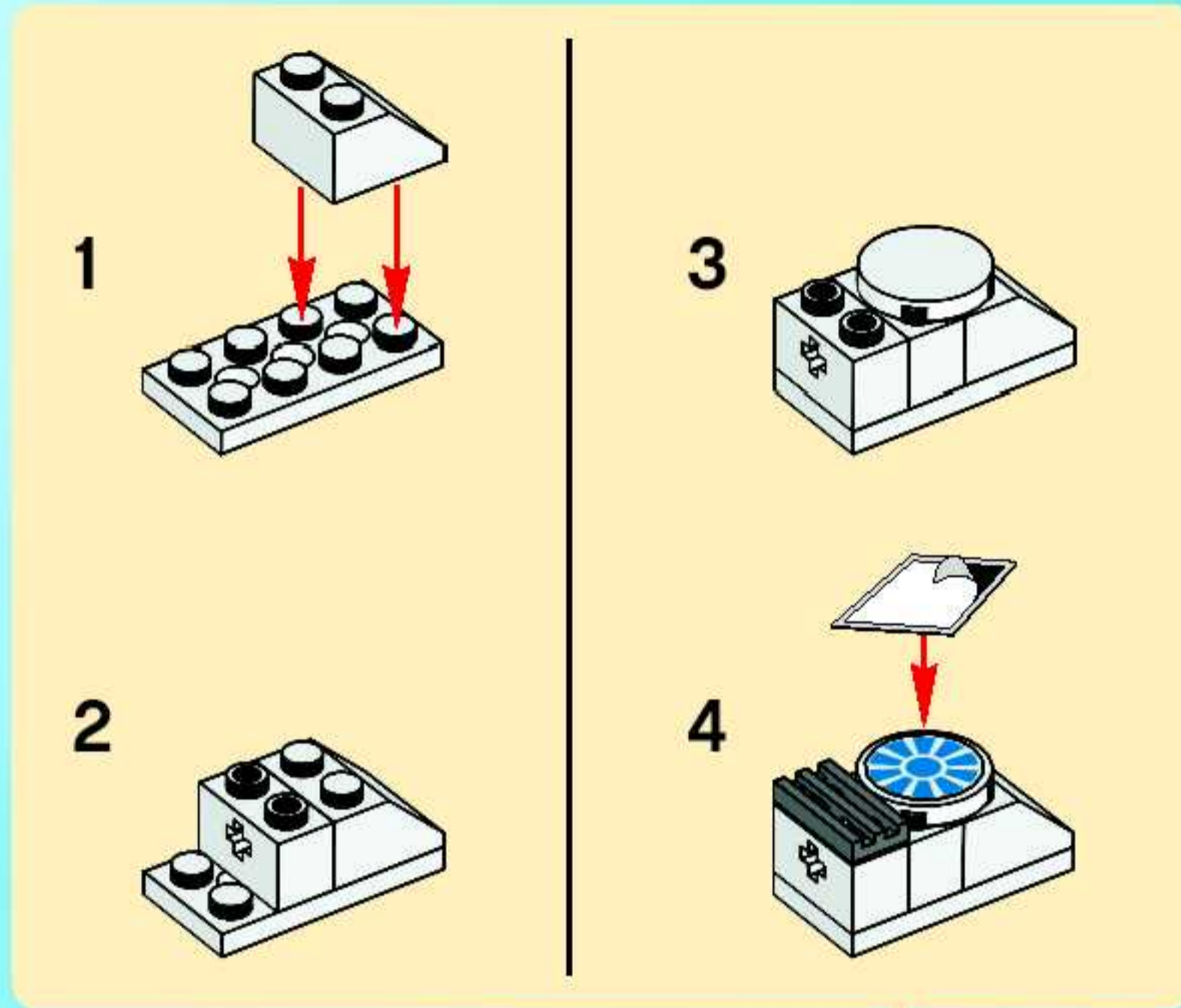

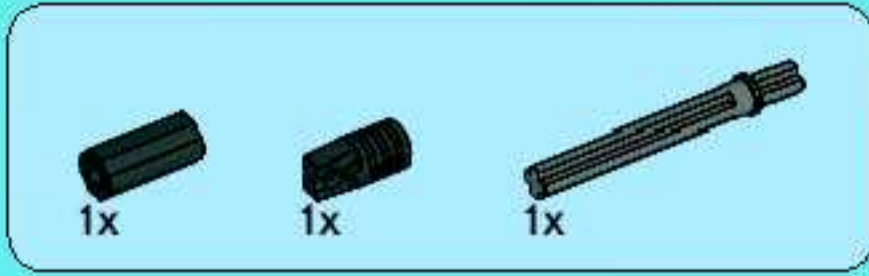
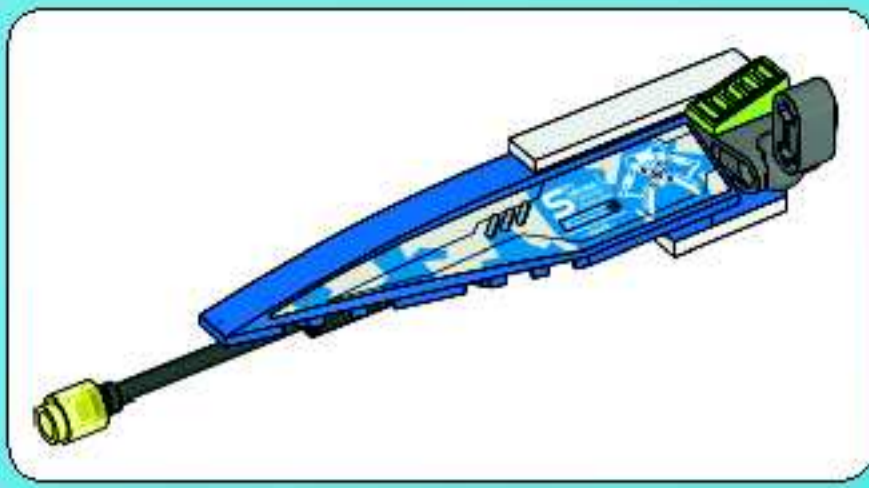

1

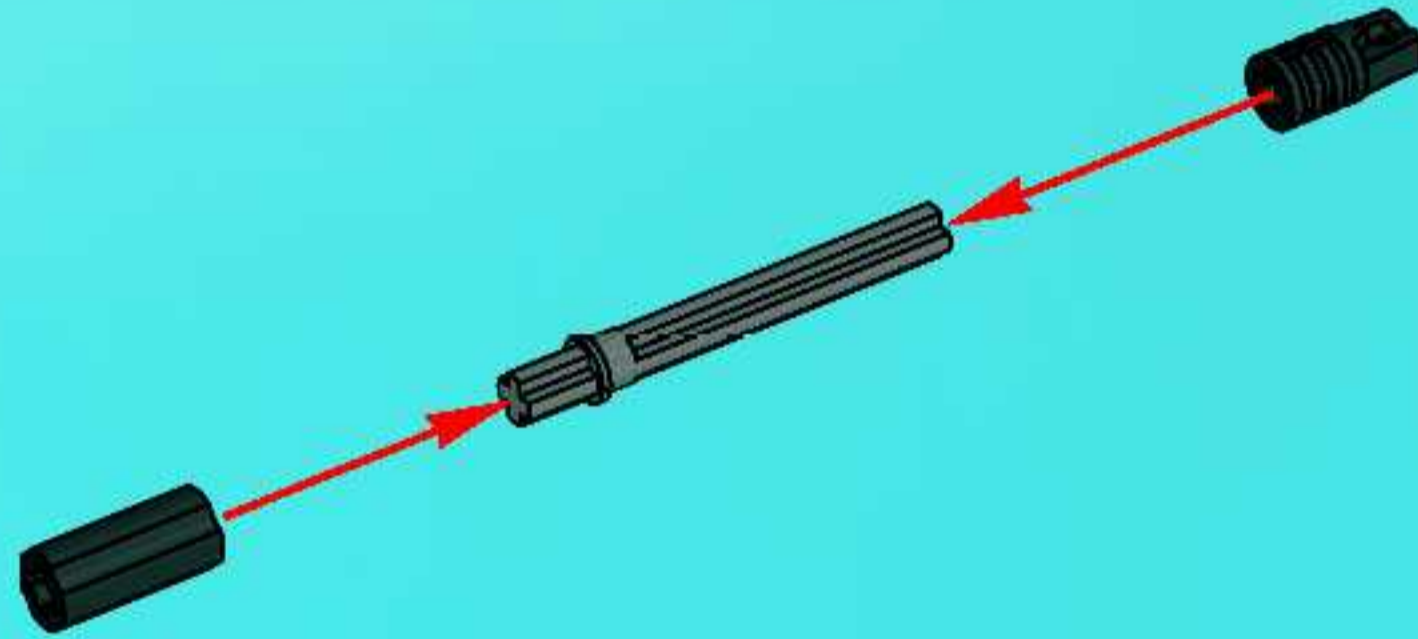

2

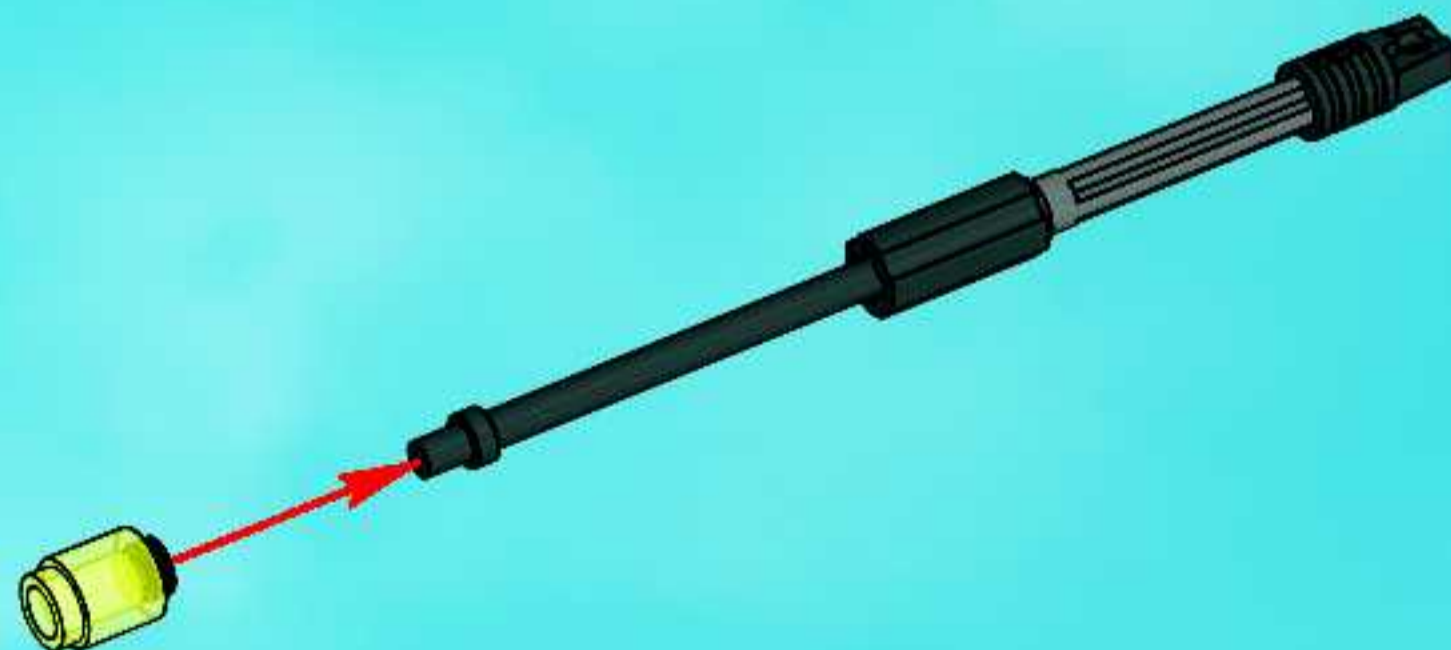

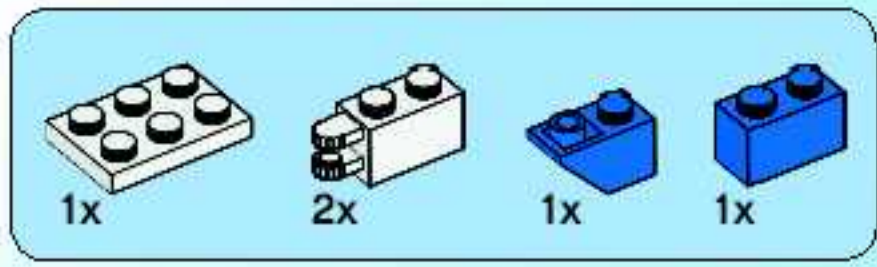

3

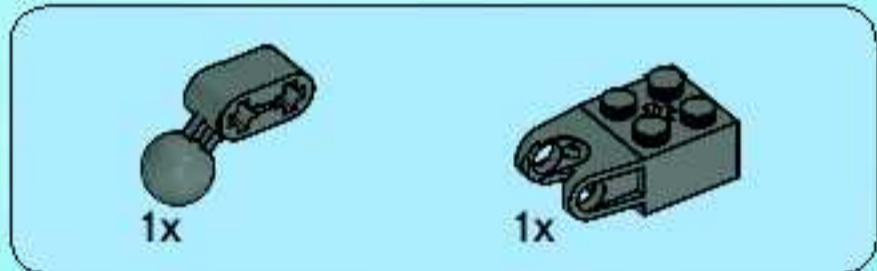
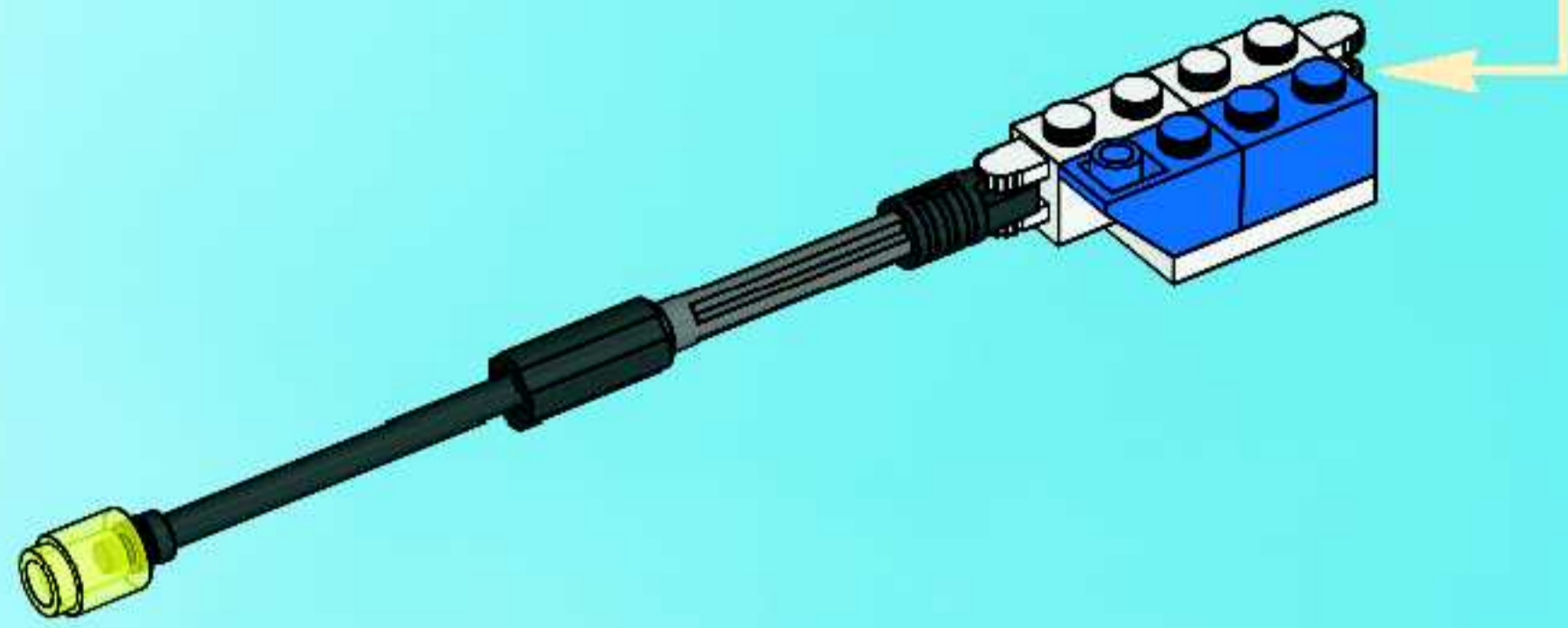
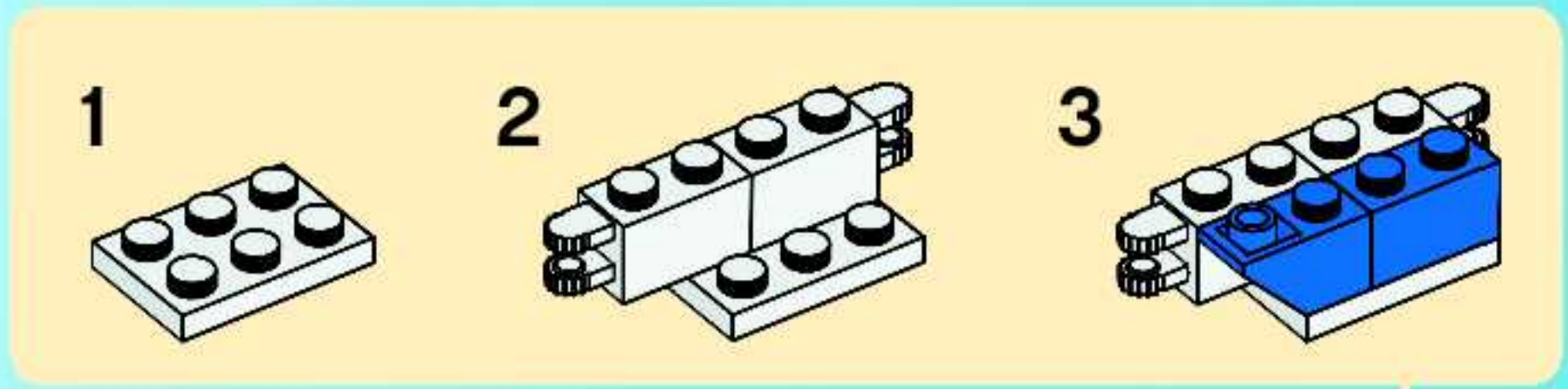

4

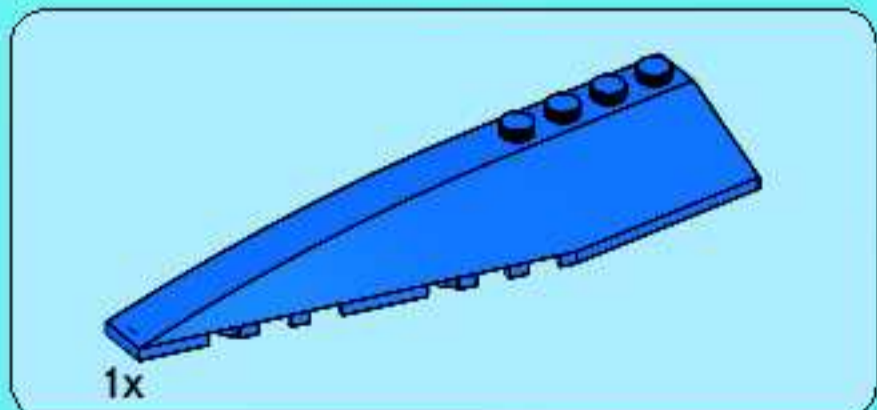
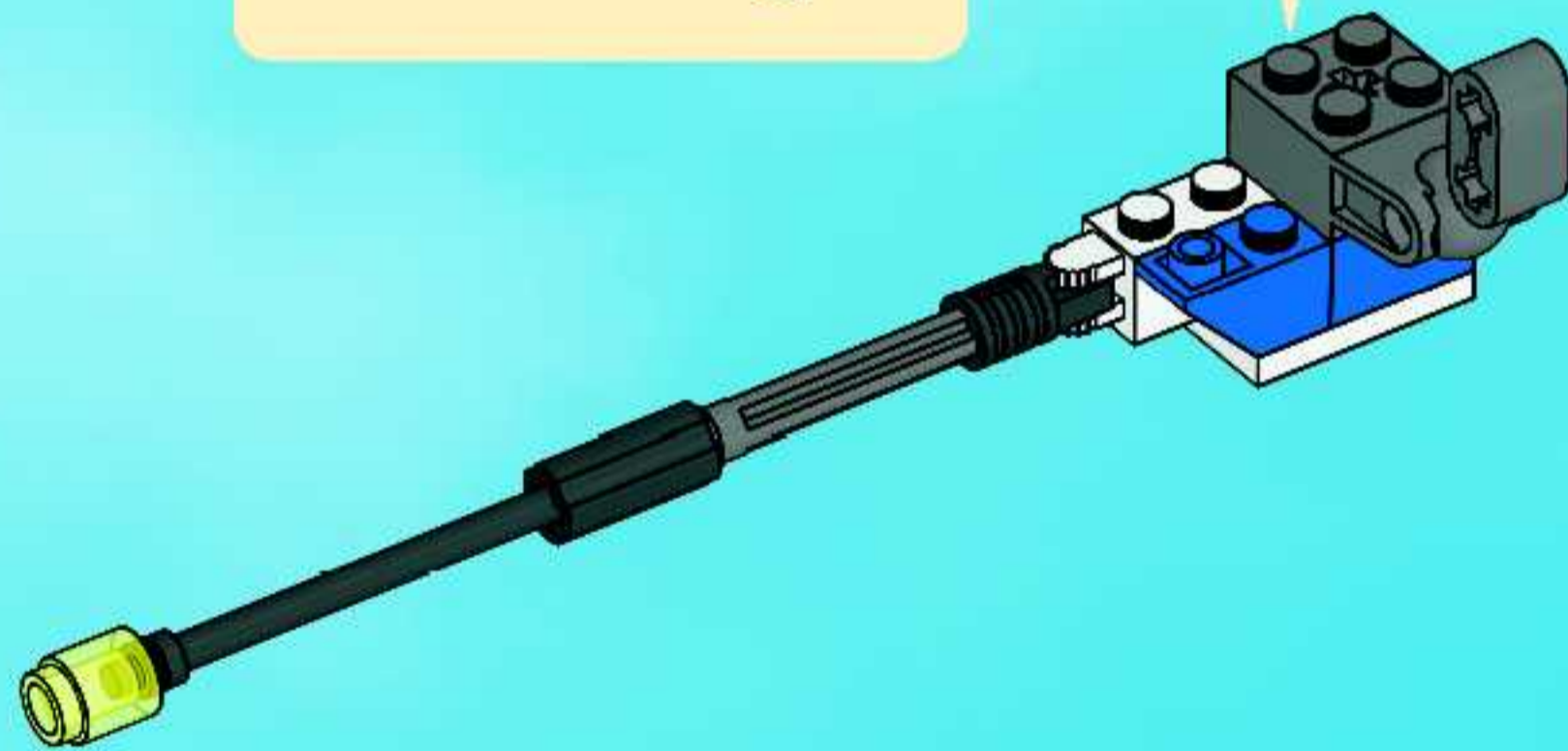
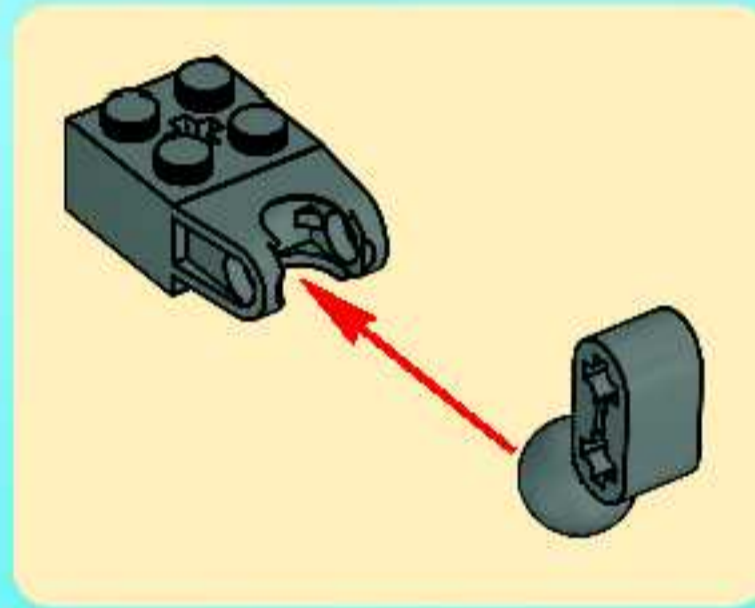

5

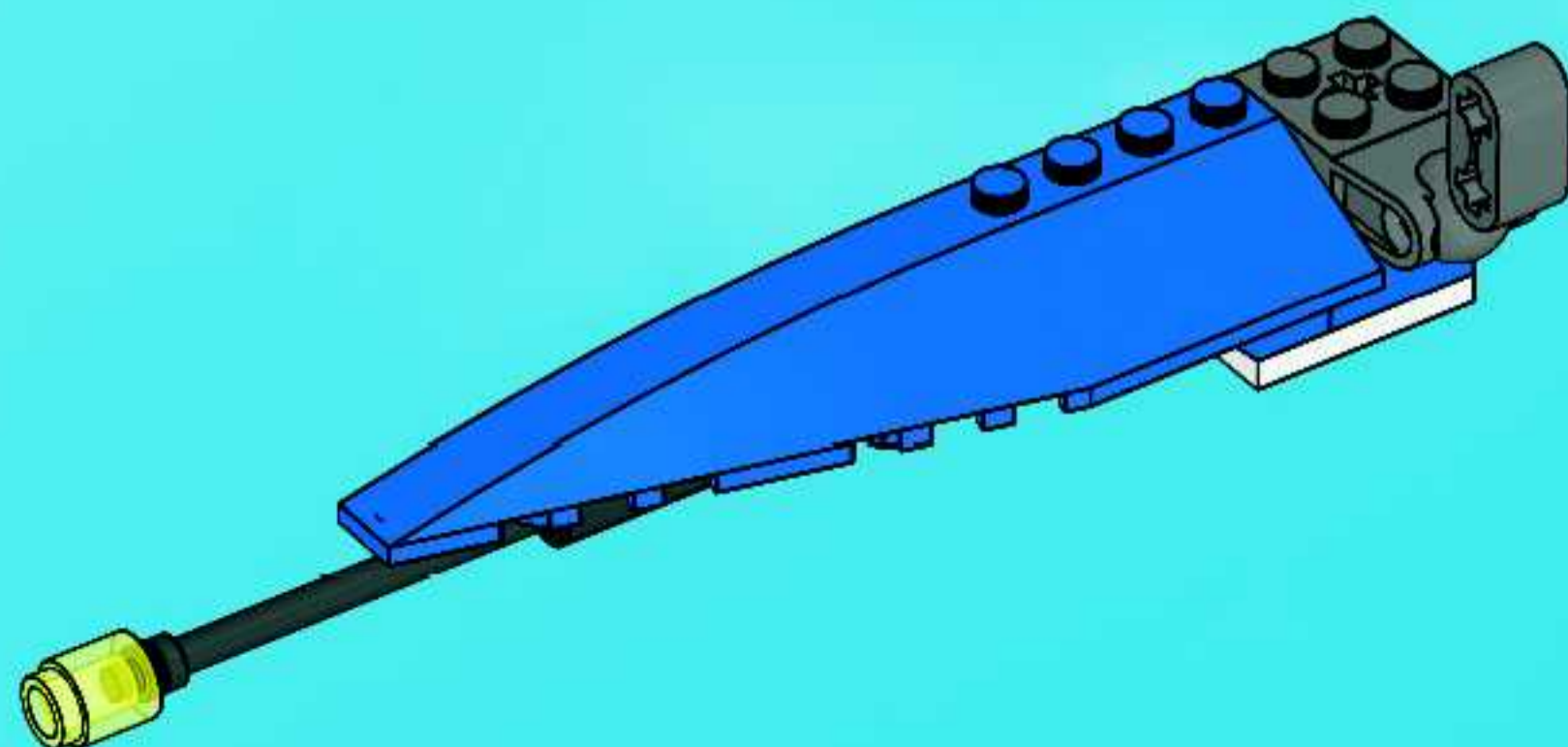

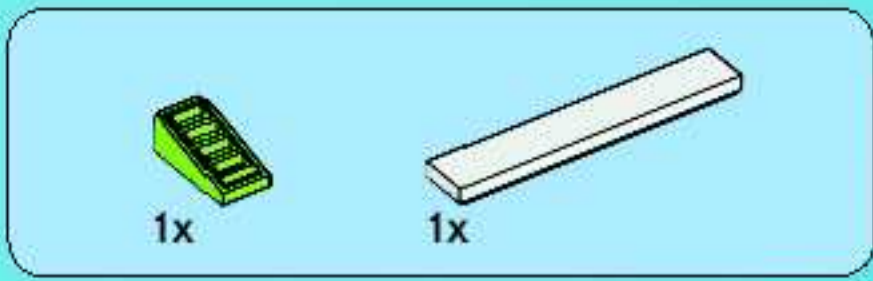

6

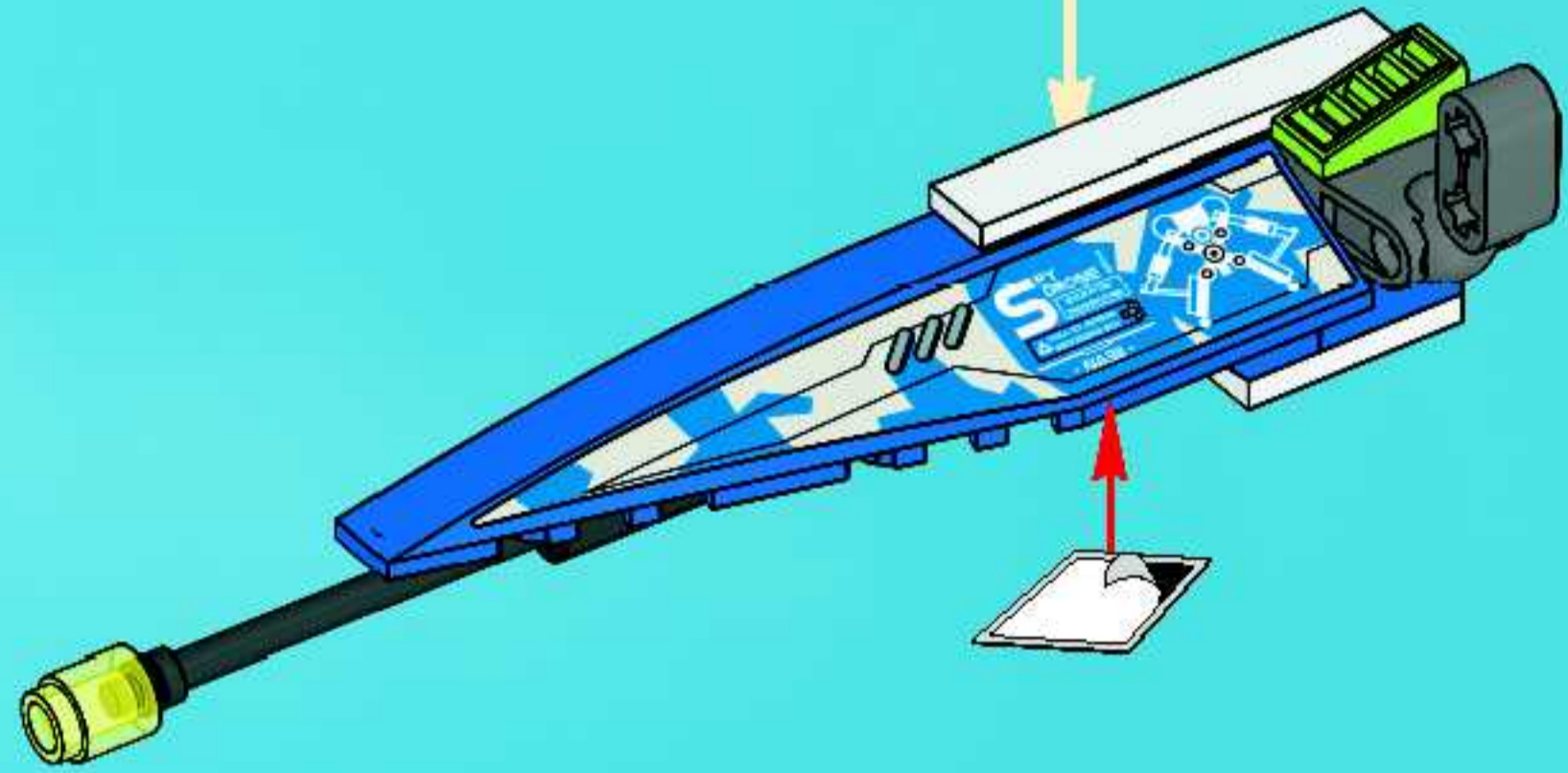
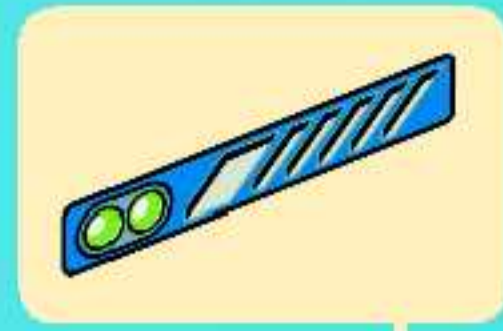

21

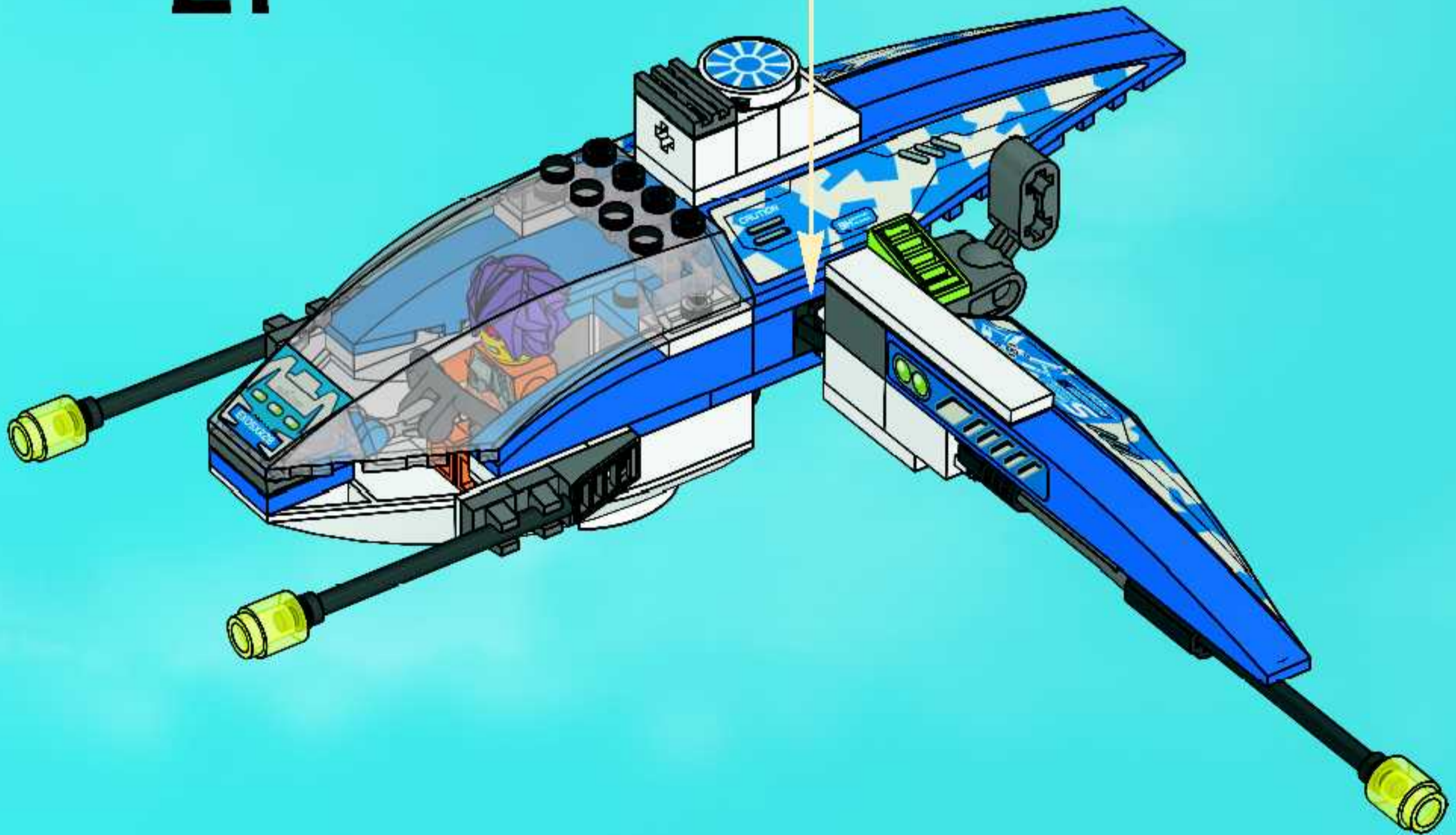

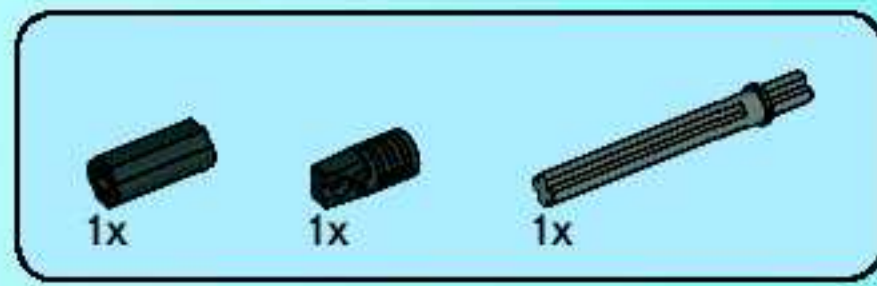
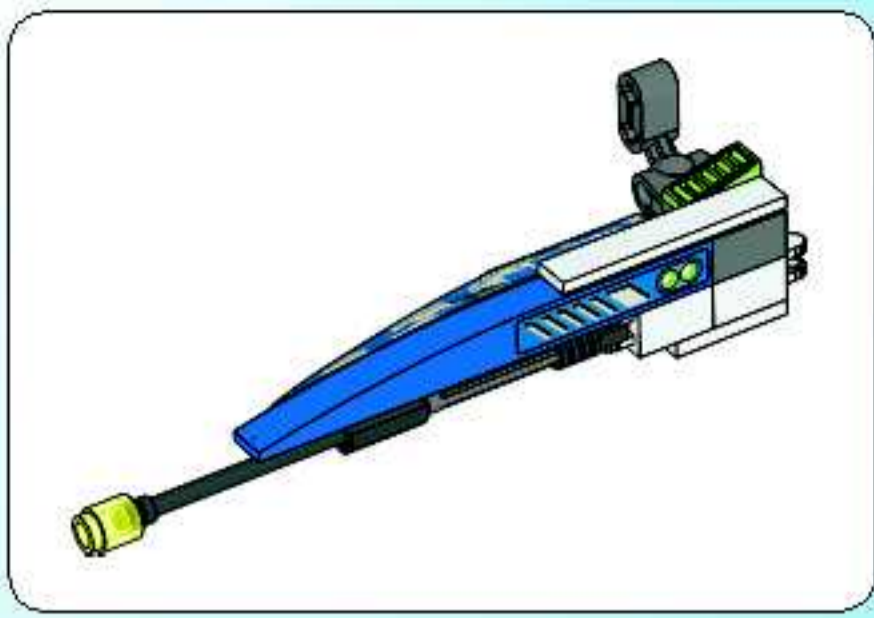

1

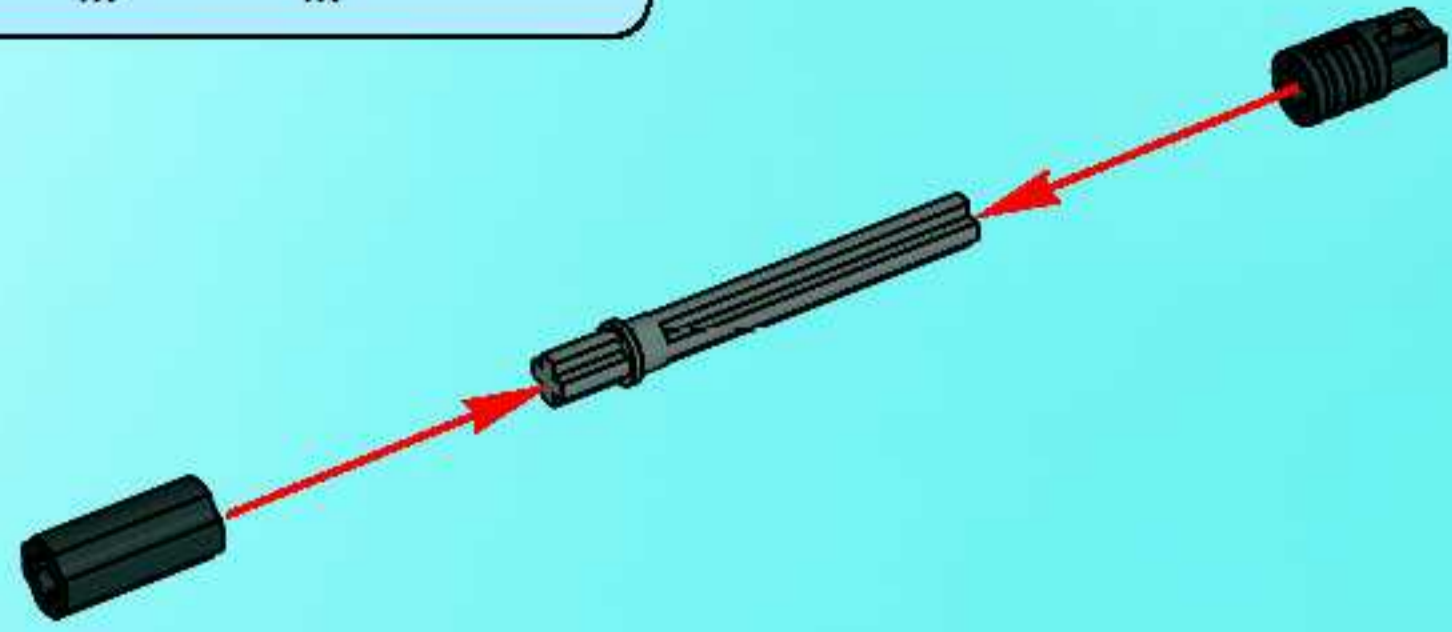

2

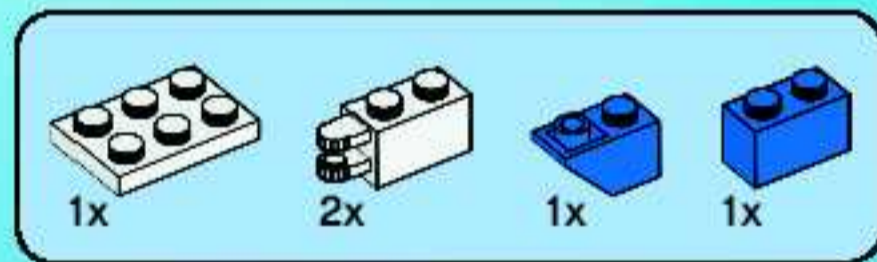

3

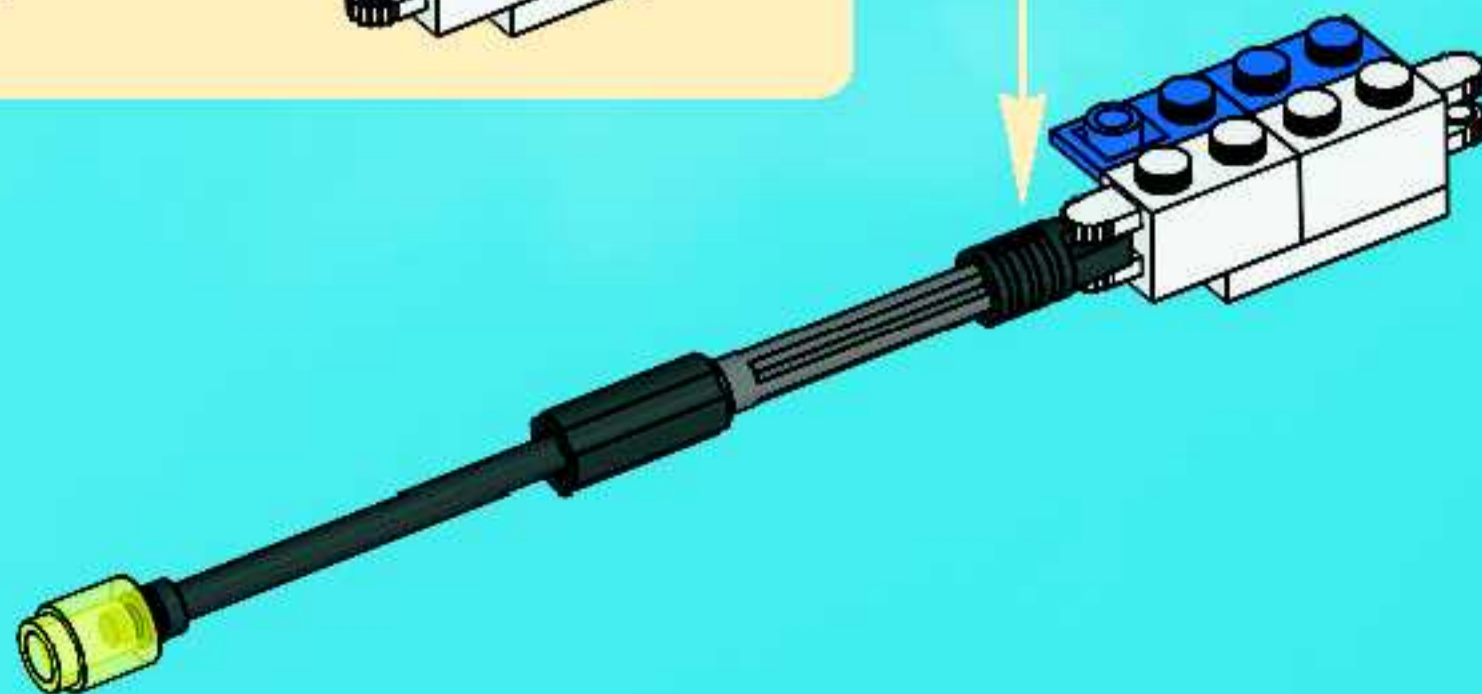
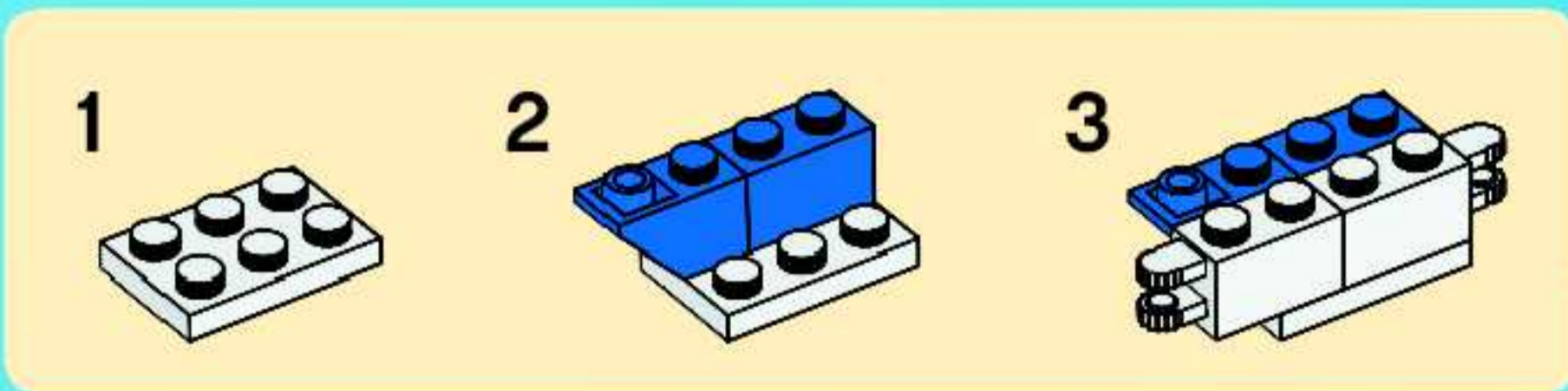

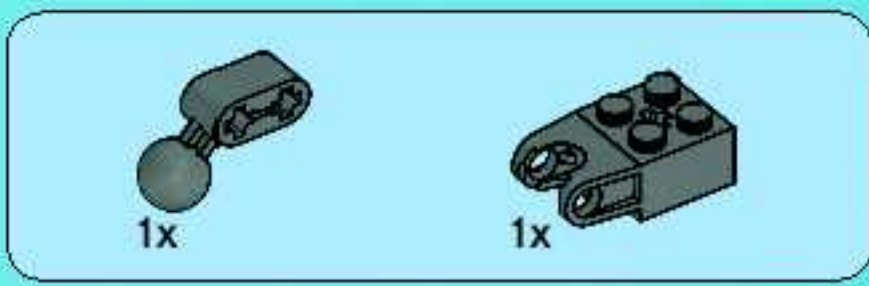

4

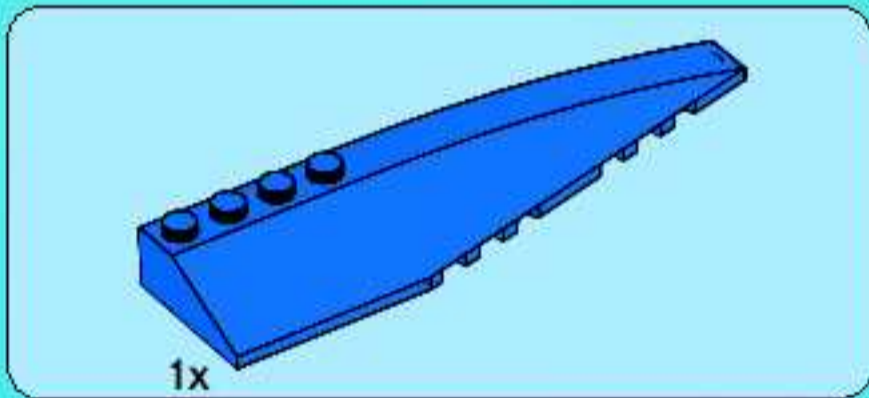
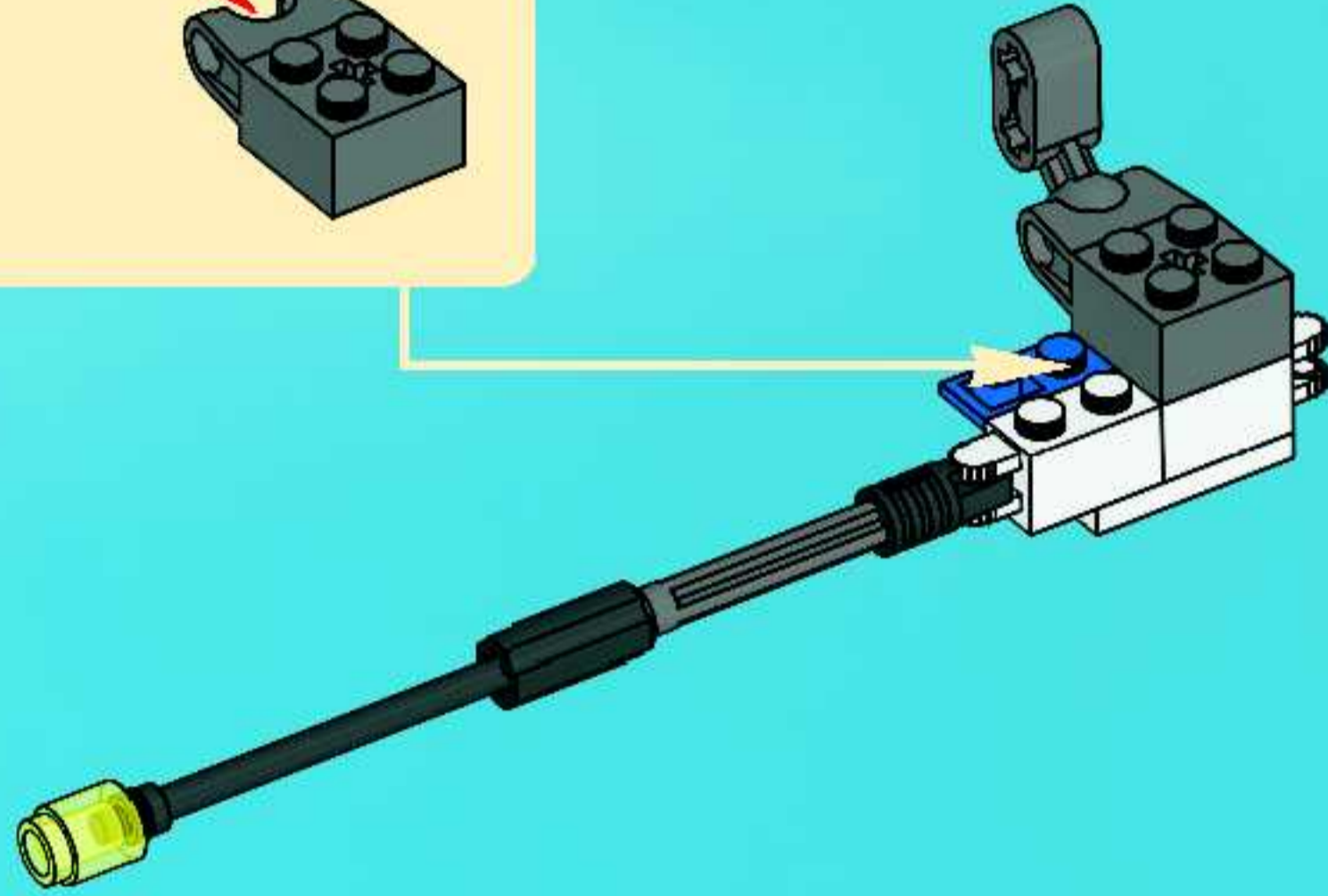
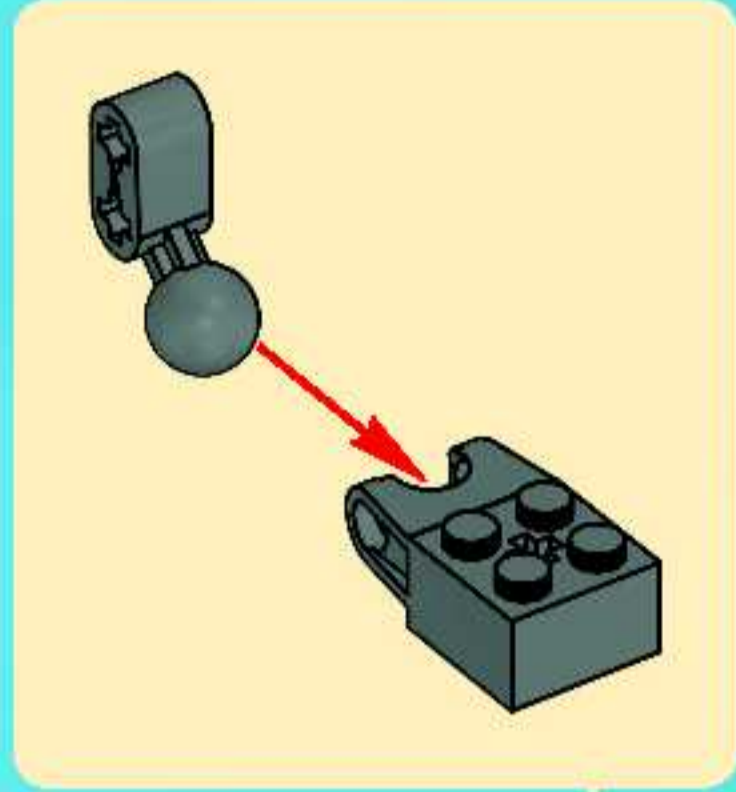

5

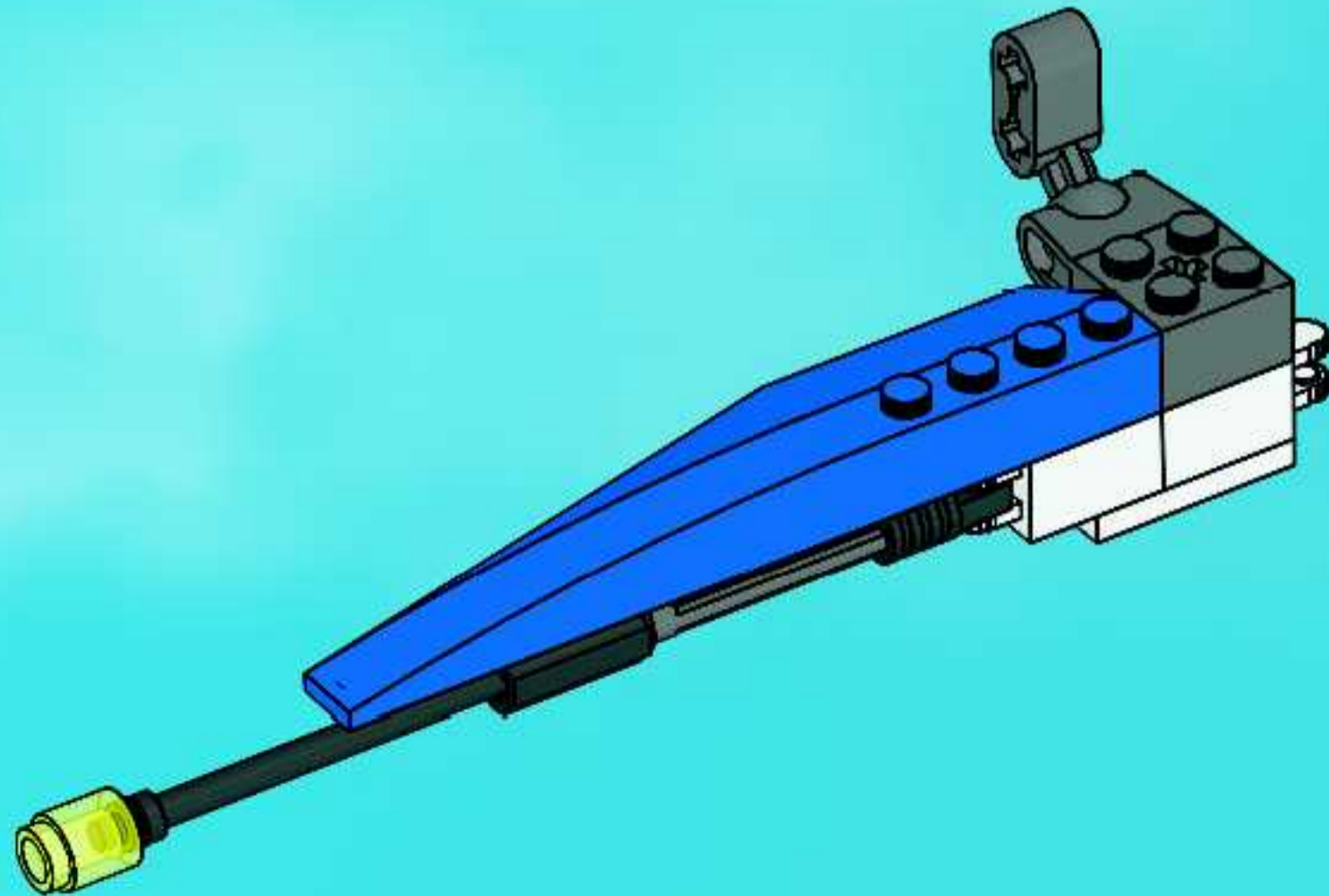

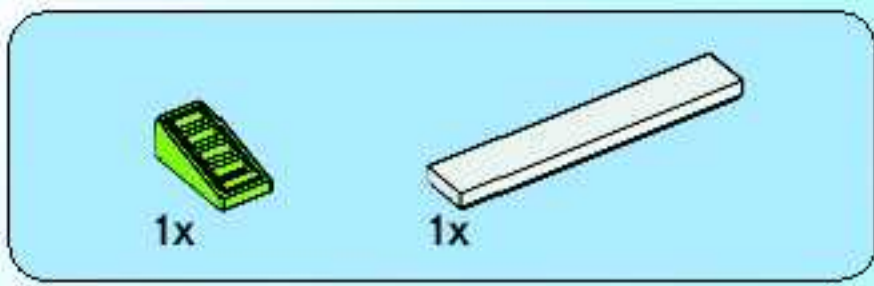

6

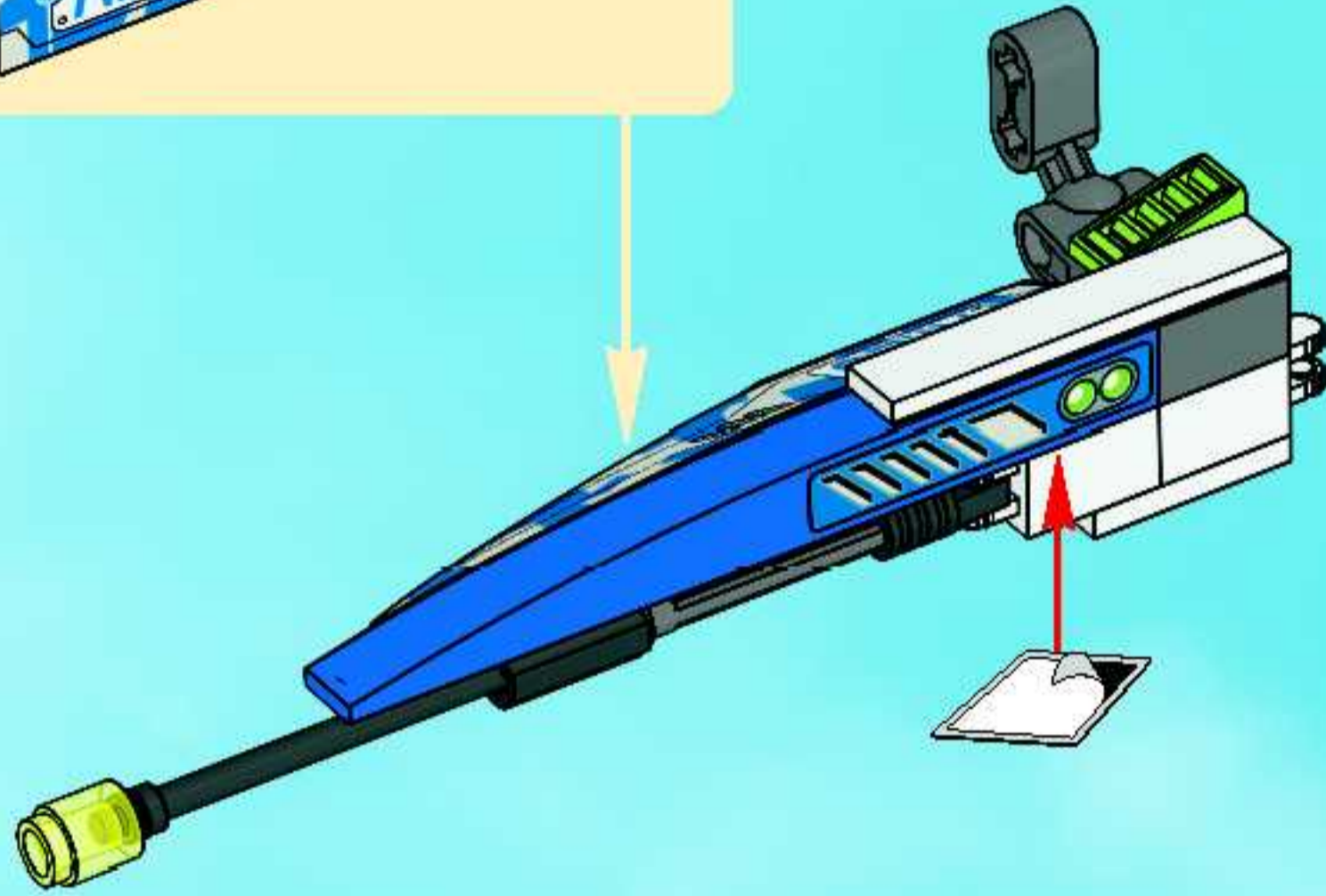

22





23

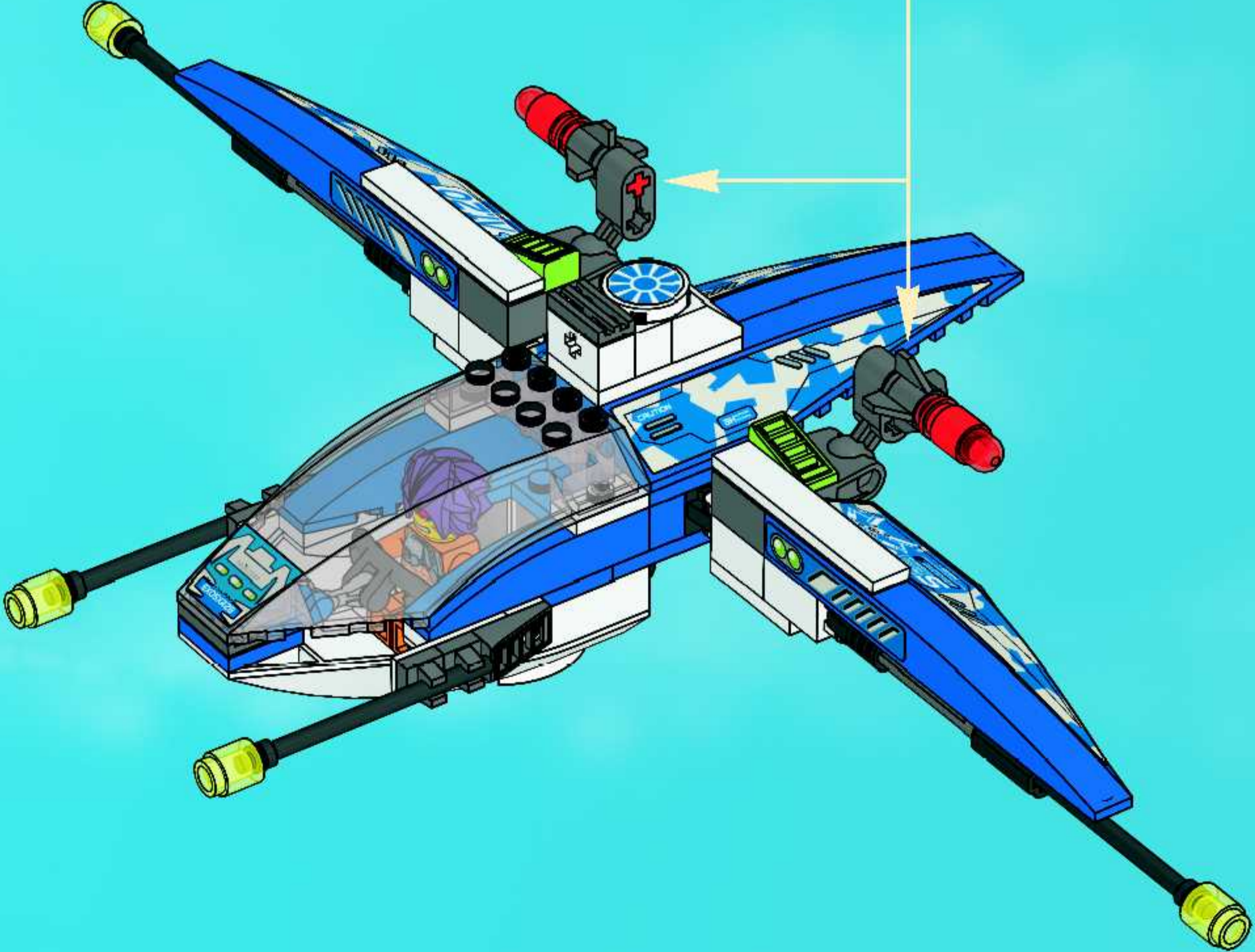
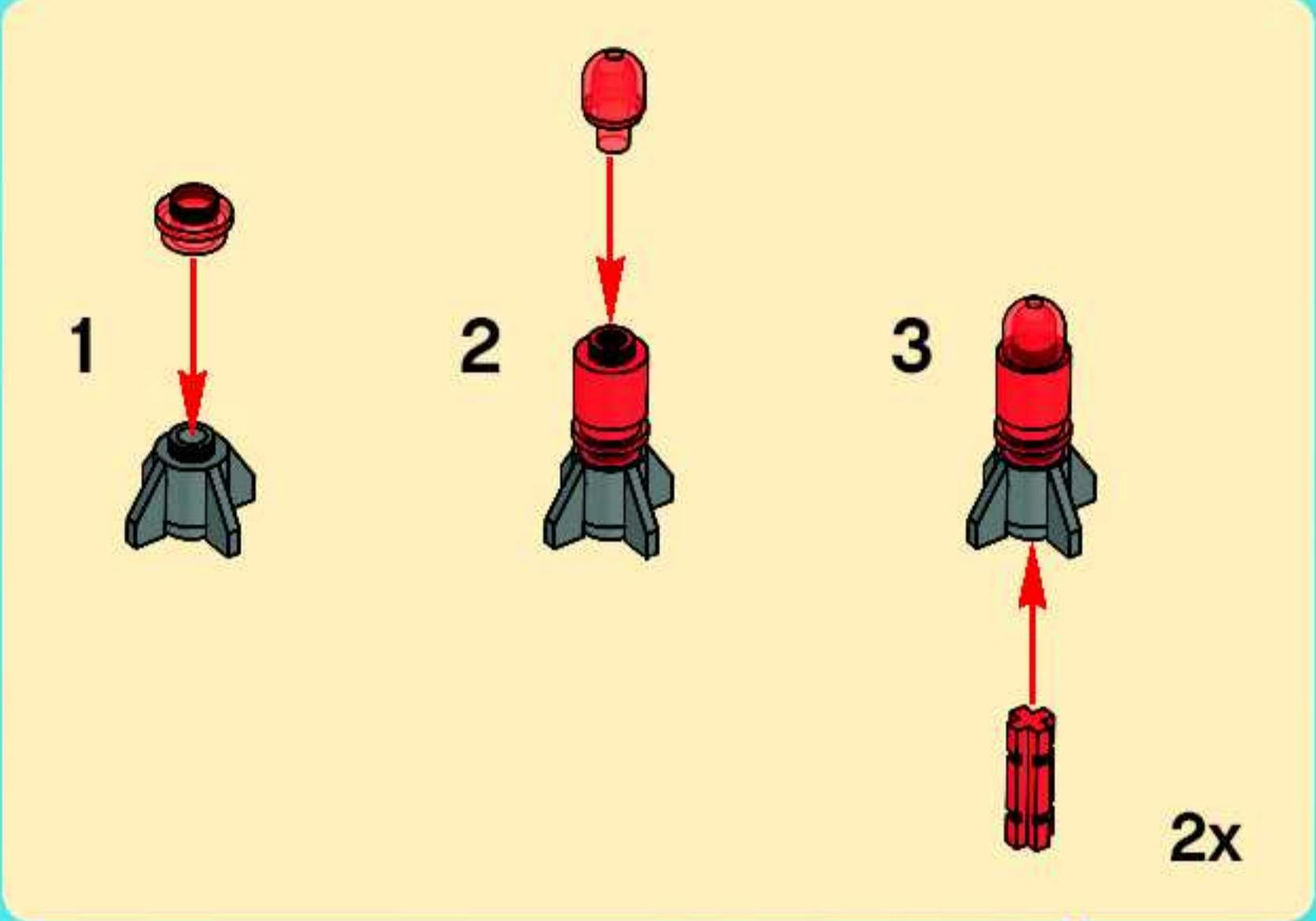

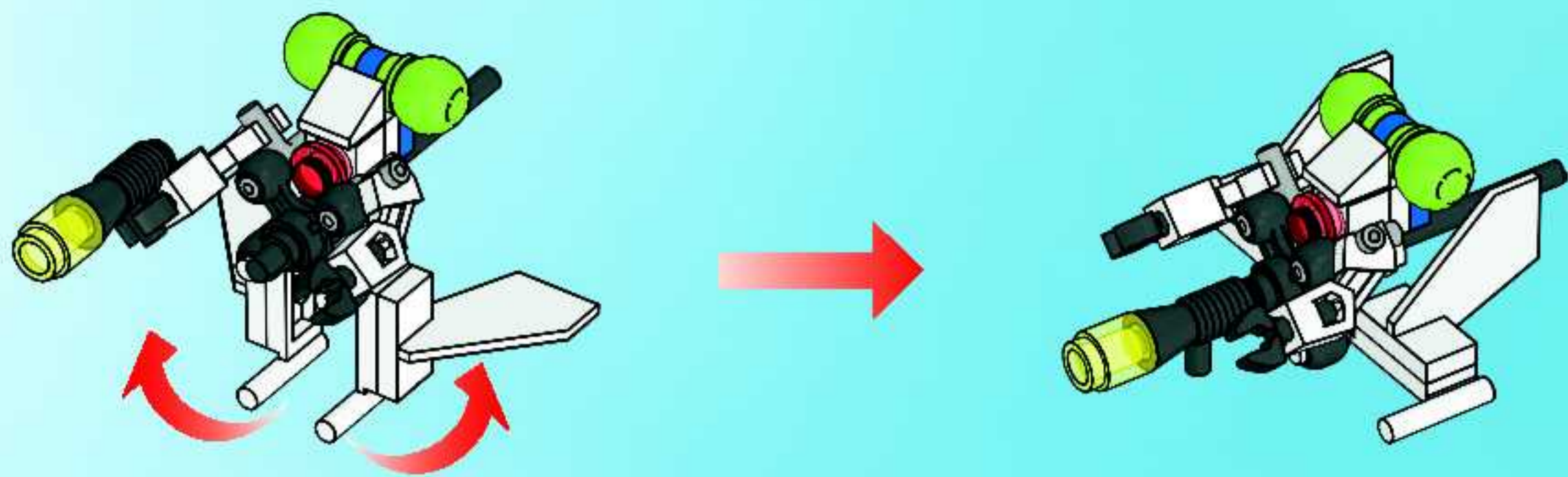

24

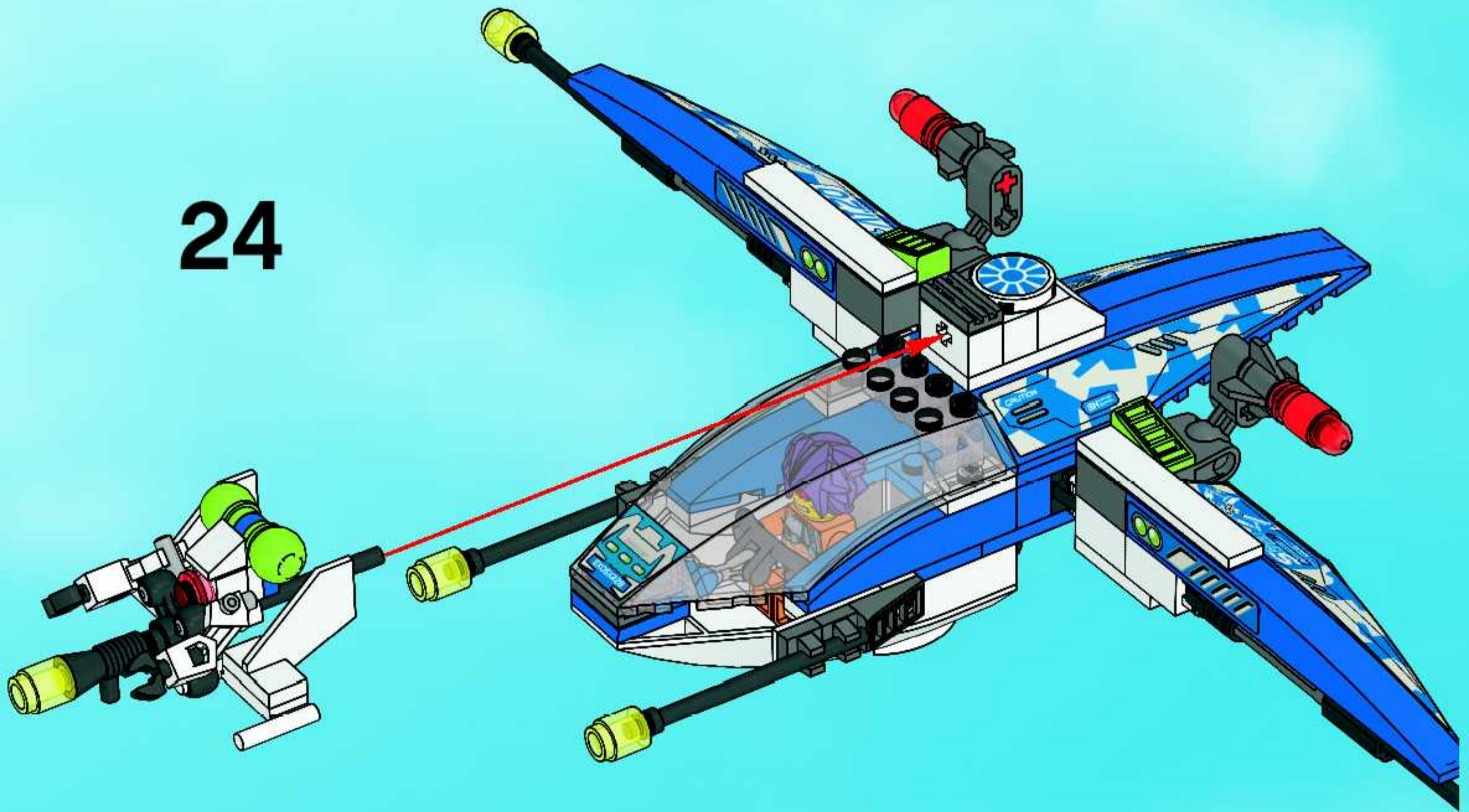

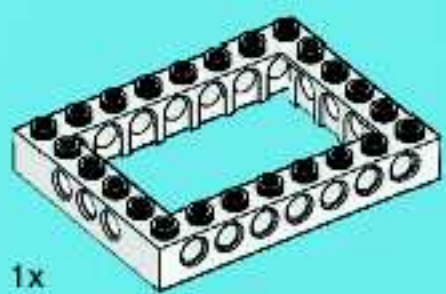

1x
4261717



4x
4282737



1x
407001



2x
4296948



4x
4522649



2x
4233486

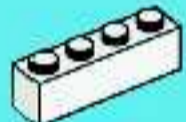

1x
301001



1x
370101

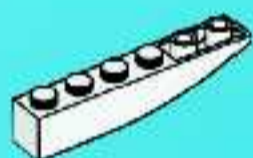

2x
4160403



2x
306901

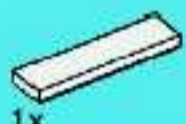

1x
243101

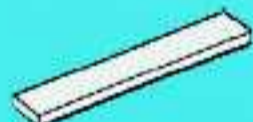

3x
663601



2x
306801



2x
415001



1x
9327



2x
383901



1x
4490732



2x
4501985



1x
408501



1x
302301



2x
379401



1x
4515169

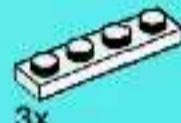

3x
371001

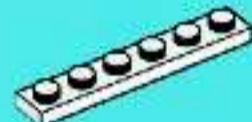

1x
366601



1x
403201



2x
302101



2x
370901



1x
303401



2x
4515347



1x
303601



5x
4504369



2x
428701



1x
303901



2x
4288960

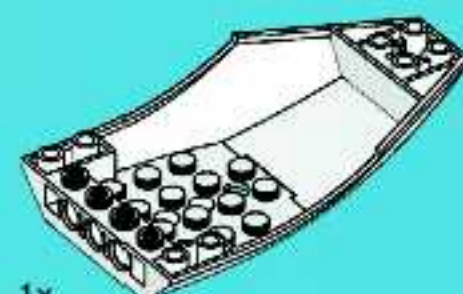

1x
4208132



1x
4278271



6x
4208160



2x
4161723



1x
4113022

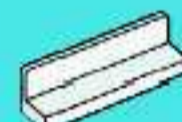

2x
4173477



1x
4214921



1x
4521331



2x
366023



2x
4124107



3x
4160128

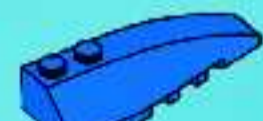

3x
4160106



3x
4297361

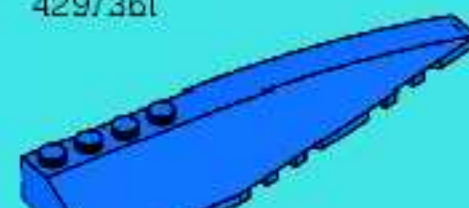

3x
4297359



2x
407023



2x
300523



3x
300423

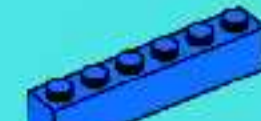

1x
300923



2x
389423



5x
4206482



26x
4514553



2x
4171849



1x
408123



4x
302323



2x
4514398



5x
302223



2x
379523



2x
4114027



1x
4193072



2x
303223



2x
366523

- 2x 4512363
- 2x 4177431
- 1x 415026
- 2x 4158848
- 1x 3003126
- 1x 434926
- 2x 4143751
- 1x 614326
- 4x 4121715
- 2x 4289538
- 1x 4248204
- 9x 409526
- 6x 4209159
- 1x 4517986
- 6x 4299389
- 1x 4262086



2x 4502834



1x 4291178



1x 370626

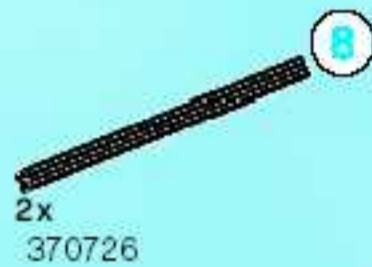

2x 370726



2x 373726



2x 4521216



2x 4183133



2x 4290718



2x 4494219



1x 4262614

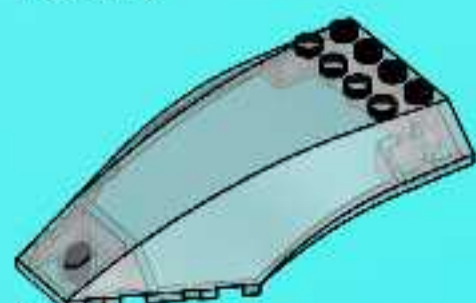

1x 4194217



1x 4292012



1x 4490817



2x 4497943



2x 3006841



3x 3005741



4x 4211865



13x 4211622



1x 4211815



1x 4211434



1x 4227658



1x 4211658



2x 4211508



1x 4289562



13x 4107106



2x 4514556



4x 4142865



1x 403221



2x 306221



4x 3005748



4x 4211133



1x 4211065



7x 4210631



2x 4212352



4x 4521185



6x 4210633

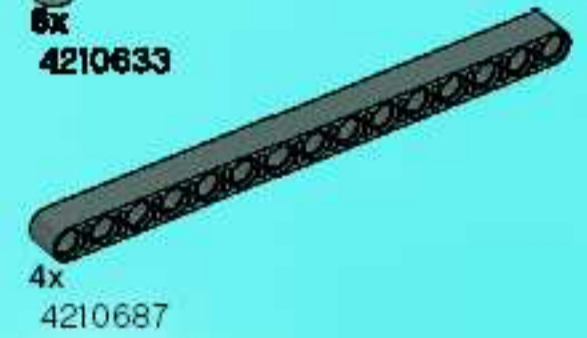

4x 4210687



2x 4210686



6x 4210753



4x 4210638



2x 4210655



7x 4508553



1x 4277928



4x 4524353



4x 4289258

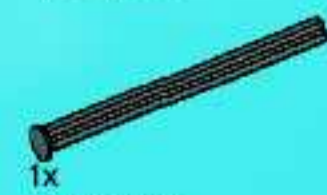

1x 4499858



3x 4211095



8x 4211069

トクシユブタイ

自爆兵器

LEGO

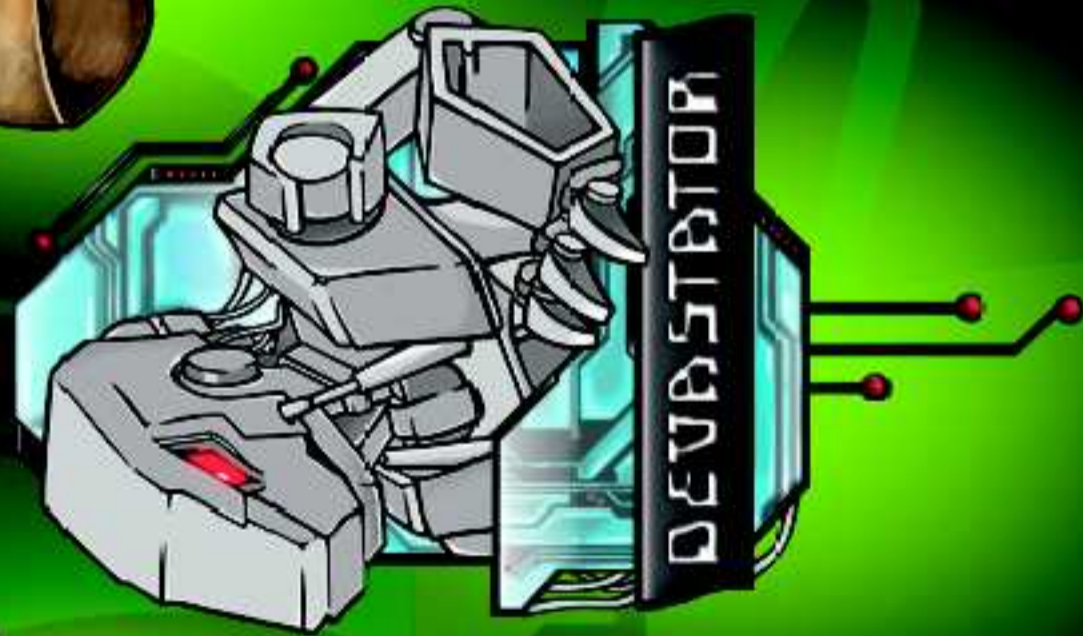

Customer Service
 Kundenservice
 Service Consommateurs
 Servicio Al Consumidor

www.lego.com/service or dial
 🇧🇪 🇩🇪 🇩🇰 🇪🇸 🇫🇷 🇩🇪 🇮🇹 🇯🇵 🇰🇷 🇸🇪 🇸🇮 🇸🇰 🇸🇮 🇸🇮
 : 00800 5346 5555
 🇺🇸 🇨🇦 : 1-800-422-5346







TM

FREE LEGO Magazine • GRATUIT • GRATIS LEGO Magazin



Join Today!

Abonne-toi dès aujourd'hui!

Meld je nu aan!

Jetzt anmelden!

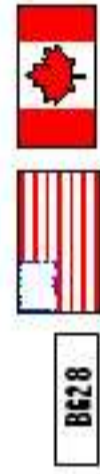

US & Canada only

1-866-534-6258

1-877-518-5346

(en Français)

00800 5346 5555



www.LEGOclub.com

**VISIT THE WORLD'S
BIGGEST LEGO® SHOP!
www.LEGOshop.com**





YES! I want to join the LEGO® Club FREE!

OUI ! Je veux m'abonner au Club LEGO® GRATUITEMENT !

Ja! Ich möchte Mitglied im kostenlosen LEGO Club werden.

Ja! Ik wil graag GRATIS lid worden van de LEGO Club.



8628

Mail to: / Poster à:
LEGO Club
P.O. Box 1157
Enfield, CT USA
06083-1157



BI08U

Mail to:
LEGO Club
33 Bath Road
Slough SL1 3UF
United Kingdom



BI08C

Per Post an:
LEGO® Club
Postfach 14 15
D-36243
Niederaula

First Name
Prénom
Vorname
Voor naam

--	--	--	--	--	--	--	--	--	--	--	--	--	--	--	--

Last name
Nom de famille
Familiename
Achternaam

--	--	--	--	--	--	--	--	--	--	--	--	--	--	--	--

Street, No.
Rue
Straße, Hausnr.
Straat, huisnr.

--	--	--	--	--	--	--	--	--	--	--	--	--	--	--	--

City/Country
Ville
Stadt
Woonplaats

--	--	--	--	--	--	--	--	--	--	--	--	--	--	--	--

Zip/Postcode
Code Postal
PLZ
Postcode

--	--	--	--	--	--	--	--	--	--	--	--	--	--	--	--

Date of Birth
Date de naissance
Geburtsdag
Geboortedatum

--	--	--	--	--	--	--	--	--	--	--	--	--	--	--	--

Parent's signature
Signature d'un parent
Unterschrift Erziehungsbeauftragte/r
Handtekening ouders

Boy
Garçon
Junge
Jongen

--	--	--	--	--	--	--	--	--	--	--	--	--	--	--	--

Girl
Fille
Mädchen
Meisje

--	--	--	--	--	--	--	--	--	--	--	--	--	--	--	--

State
Prov.

--	--	--	--	--	--	--	--	--	--	--	--	--	--	--	--

Country
Pays
Land

--	--	--	--	--	--	--	--	--	--	--	--	--	--	--	--

Email

--	--	--	--	--	--	--	--	--	--	--	--	--	--	--	--

The English version of the magazine can only be mailed to addresses in the US, Canada, the UK, and Republic of Ireland. Club membership is valid for 2 years and includes Free copies of the LEGO Magazine. In the US and Canada please allow up to 6 weeks for delivery of your first magazine. By signing this form you consent that LEGO Club to use your child's data for LEGO mailings. The data will only be used for LEGO mailings and will not be sold, rented or otherwise disclosed to any company outside the LEGO Company except for disclosure to companies acting as our agents to help us provide services requested by the child. This coupon good for one free membership per per son, group or organization. If you would not like to receive other communication from the LEGO company please tick here:

La version Française du magazine peut être postée uniquement au Canada, l'Allemagne, le Royaume-Uni, la République d'Irlande, l'Australie, le Japon, le Mexique, les Pays-Bas, la Belgique, la France, l'Espagne, l'Inde, l'Italie, le Royaume-Uni, les Etats-Unis, la Suisse, la Suède, la Nouvelle-Zélande. L'abonnement est valide pour 2 ans et inclut des exemplaires gratuits du Magazine LEGO. Aux E.-U. et au Canada, allowez 6 semaines pour la livraison initiale. En remplissant ce formulaire, vous consentez à ce que LEGO utilise les informations de votre enfant pour des envois postaux de LEGO. L'information sera utilisée uniquement pour des envois postaux par LEGO et ne sera en aucun cas, vendue, louée, échangée ou divulguée à d'autres compagnies autres que la compagnie LEGO, à l'exception des compagnies affiliées qui nous procurent des services auxquels l'enfant en a fait la demande.

Dies deutschesprachige Angebot gilt nur für die Länder D, AU und CH. Die Kostenlos e Mitgliedschaft beinhaltet die Zusendung des LEGO Magazins und endet nach zwei Jahren. Für die Mitglieder ents telien keine Verpflichtungen. Es kann bis zu drei Monaten dauern, bis das erste Magazin zugestellt wird. Mit Ihrer Unterschrift erklären Sie sich einverstanden, dass die Daten Ihres Kindes zum Zweck einer LEGO Club-Mitgliedschaft von der LEGO Gruppe gespeichert werden. Die Daten werden vertraulich behandelt und nicht an Dritte weitergegeben, außer an Dritte weiterzugeben, außer an Die restliche der LEGO Club keine weiteren Informationen von der LEGO Company bekommen möchte, bitte hier ankreuzen:

Door dit formulier te tekenen geeft u de LEGO Club toestemming om uw anstuurde gegevens te gebruiken voor het coösten van LEGO mailings. Uw gegevens worden uitsluitend gebruikt voor mailings van LEGO en zullen niet worden verkocht, verhuurd of op welke wijze dan ook versprekt aan derden buiten de LEGO Groep, uitgezonderd de organisaties die momenteel ons optrededen om de service te verlenen waar uw kind om gevraagd heeft.

www.acnielsen.aim.dk/LEGO

WIN LEGO® PRODUCTS

No purchase necessary.
Open to residents of all countries where not prohibited.
Go to www. for official rules and details.

WIN LEGO® PRODUCTEN

Kopen niet nodig.
Open voor alle leeftijden, en in alle landen waar geen verbod geldt.
Ga naar www. voor officiële regels en details.

GEWINNNE LEGO® PRODUKTE

Die Teilnahme am Gewinnspiel führt zu keinerlei Kaufverpflichtungen.
Sie können in allen nicht ausgeschlossenen Ländern teilnehmen.
Die offiziellen Regeln und nähere Informationen finden Sie unter www.

GAGNE DES PRODUITS LEGO®

Aucun achat n'est nécessaire.
Ouvert à tous les âges et aux résidents de tous les pays, sauf en cas d'interdiction.
Rendez-vous sur www. pour obtenir plus de détails et le règlement officiel.

レゴ®製品を「当てよう」

購入は不要です
禁止されていない限り、あらゆる年代およびあらゆる国の居住者の方々にご利用いただけます。
公認規則および詳細につきましては、www.をご覧ください



WIN
WIN
WIN
GAGNE
GAGNE
GAGNE
「当てよう」

