



RACERS

8231



1

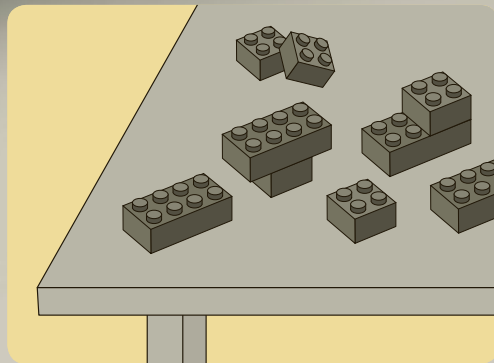

2

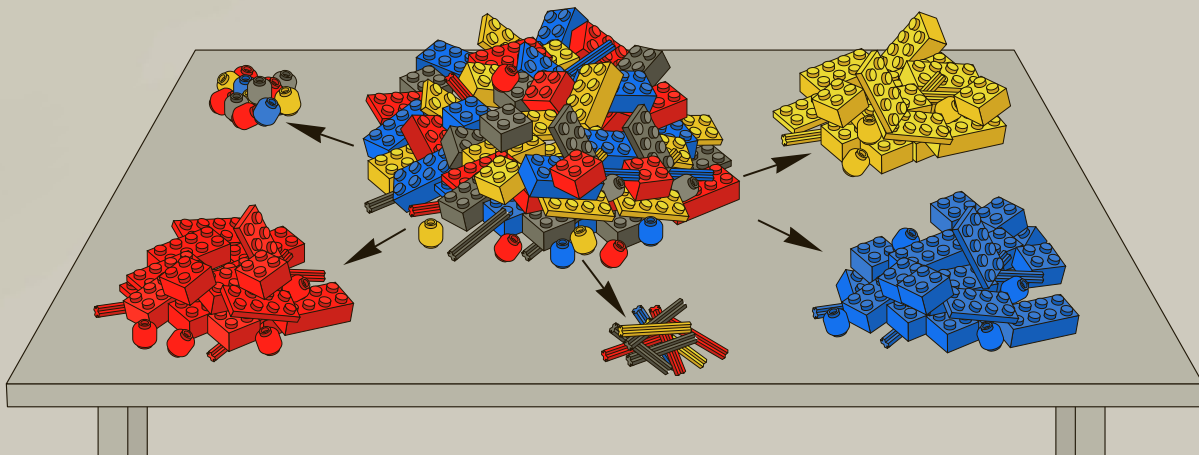

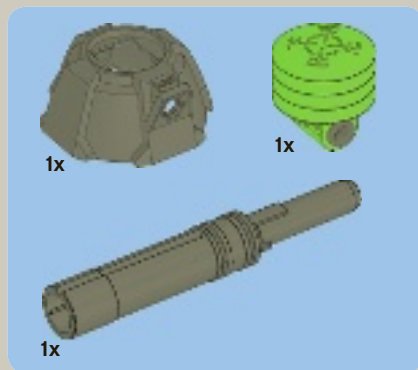

1

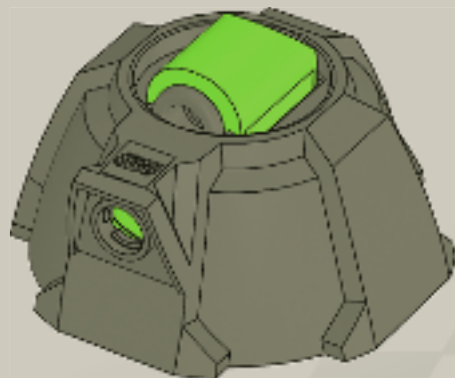

2

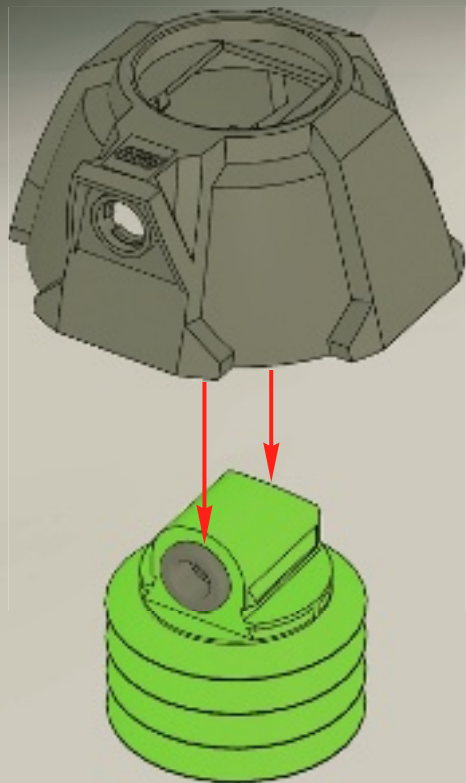

3

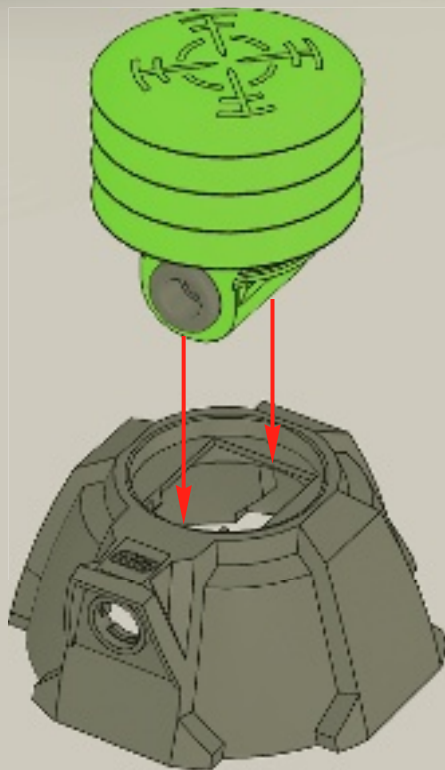

4

4

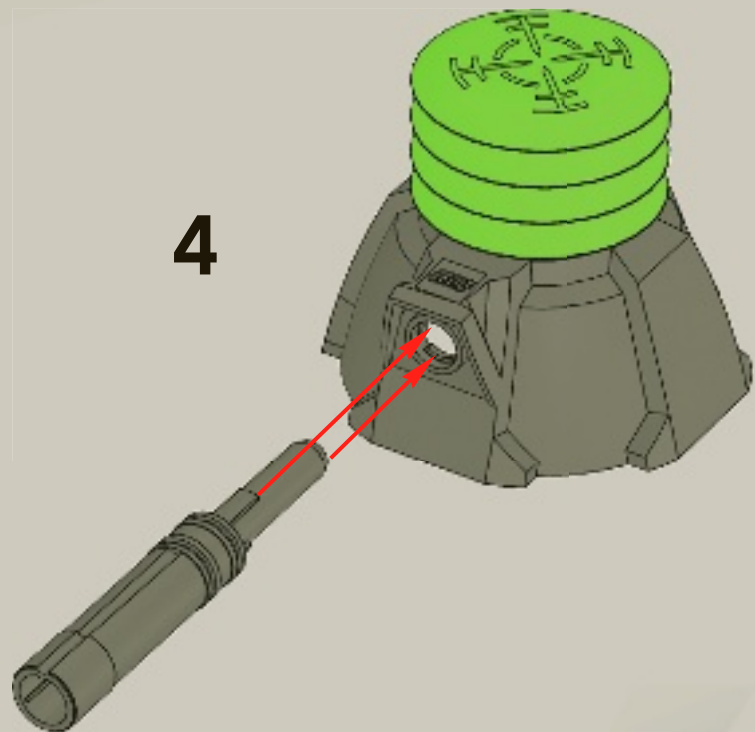

5

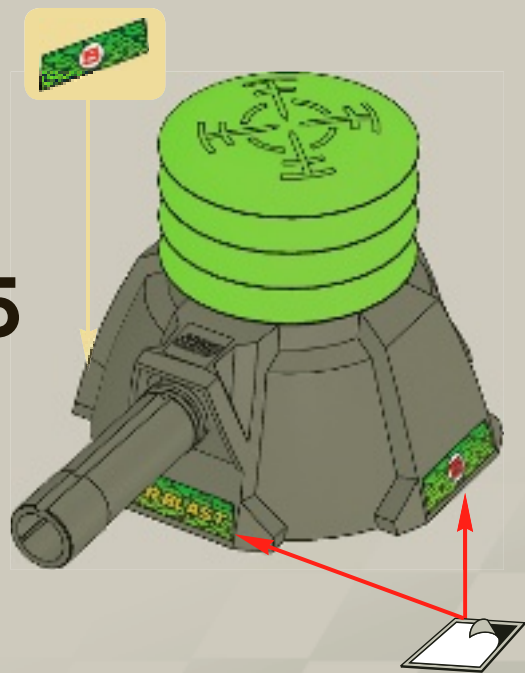



1x

1

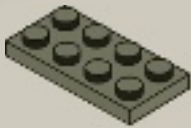

2x

2



6



2x

3

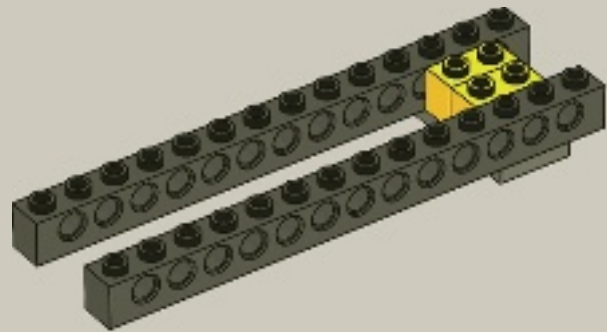



4

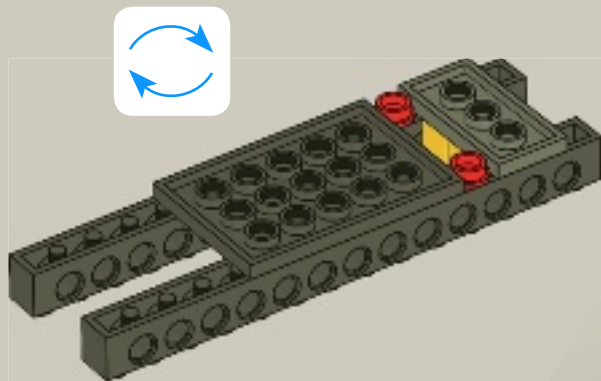

5

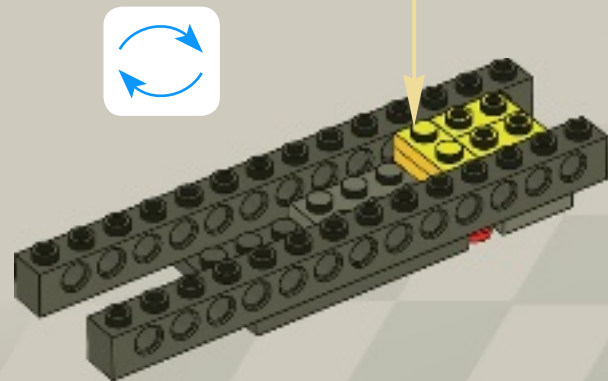
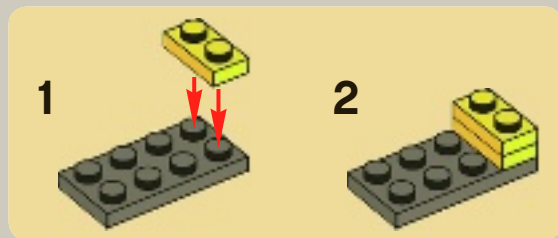

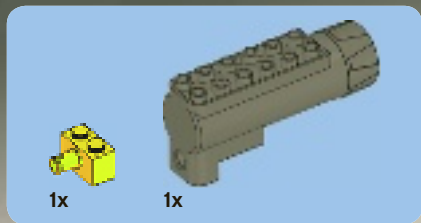

6

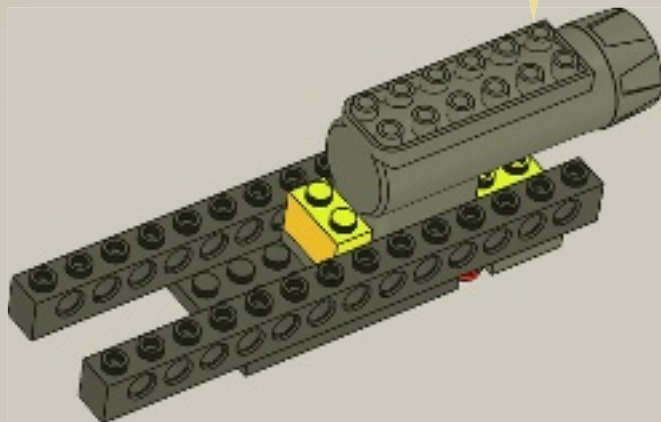
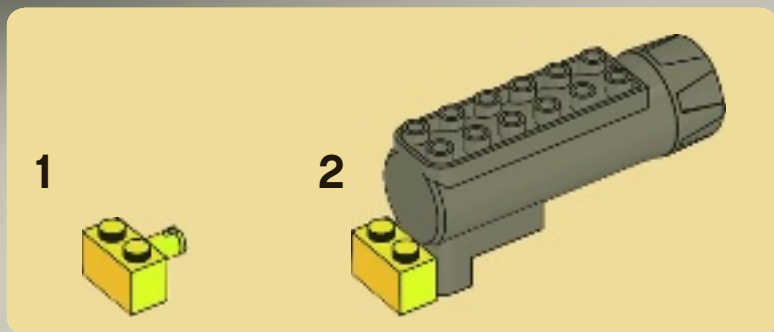



2x



1x

7

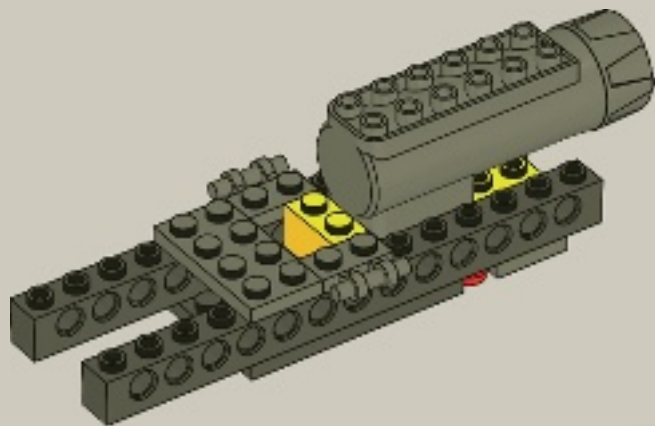

1x

8

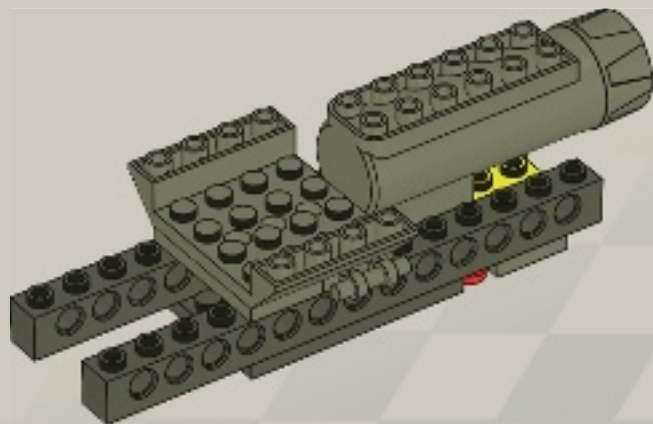



9

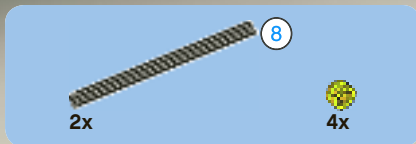
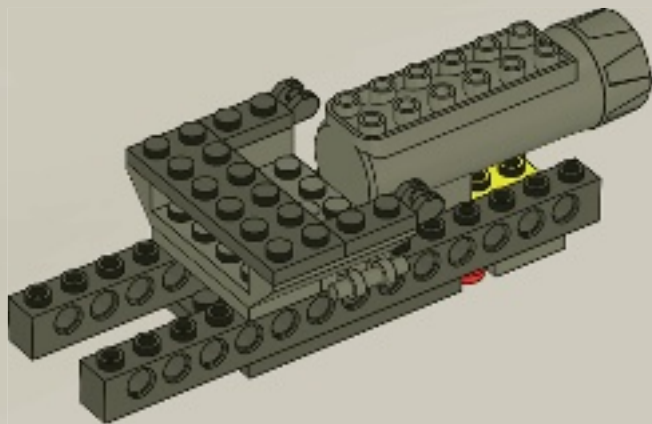

10

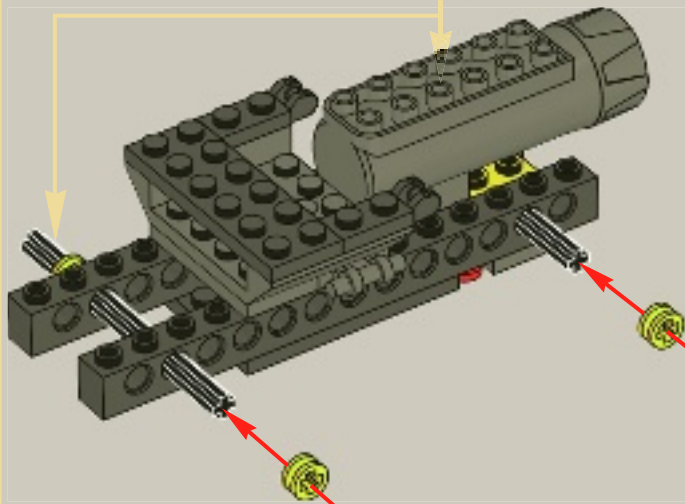
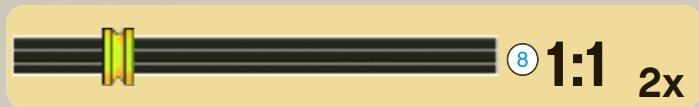



11

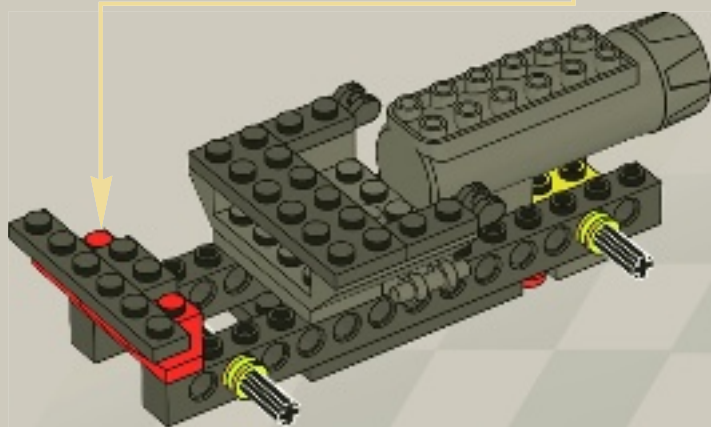
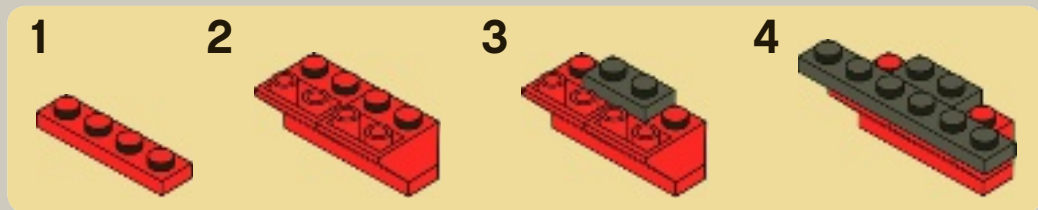



1x



2x

12

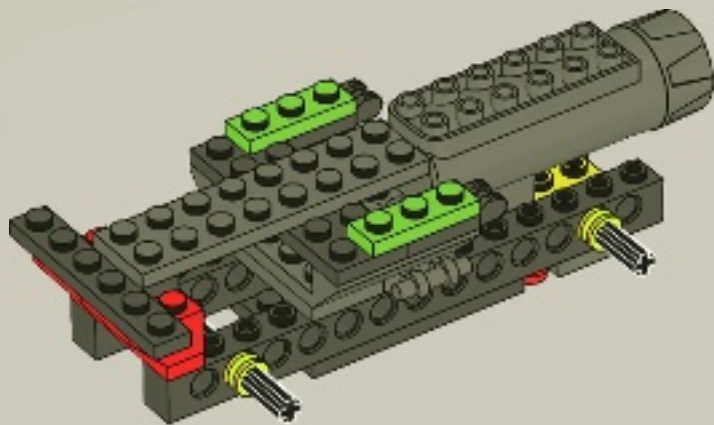



2x

13

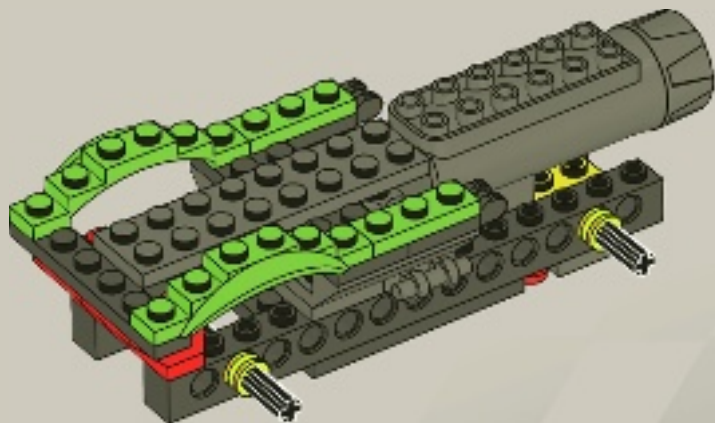



14

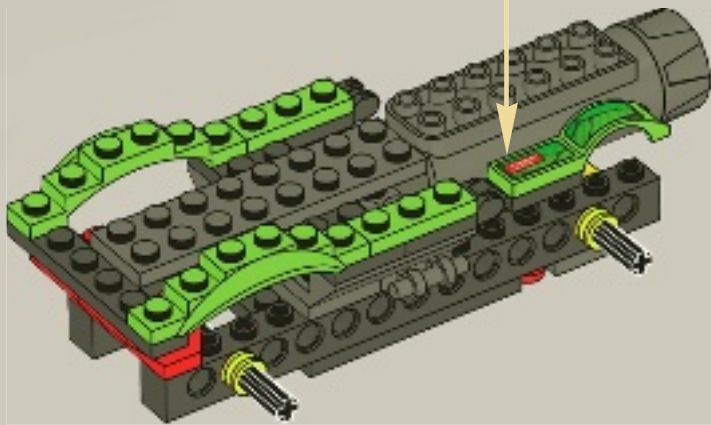



15

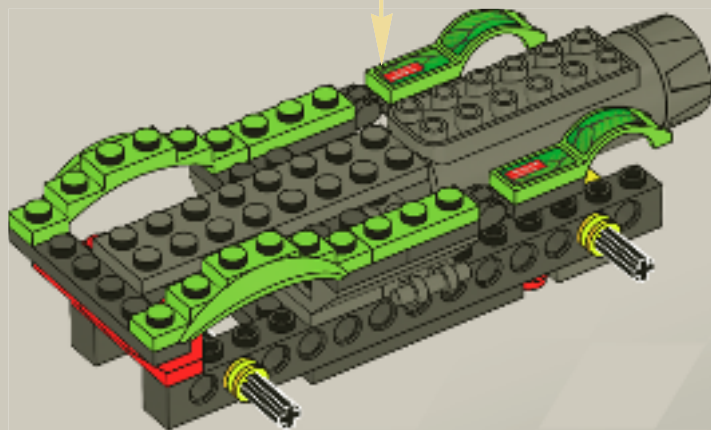
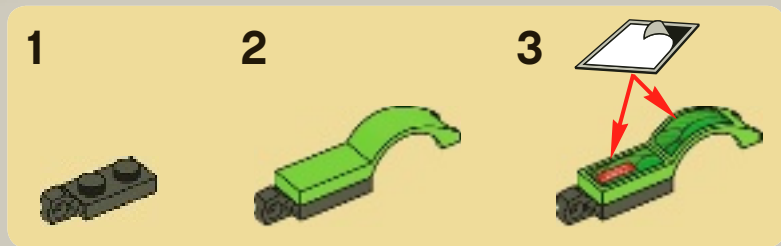

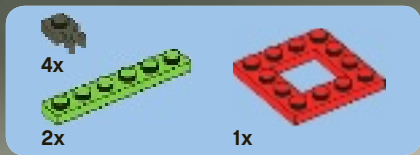

16

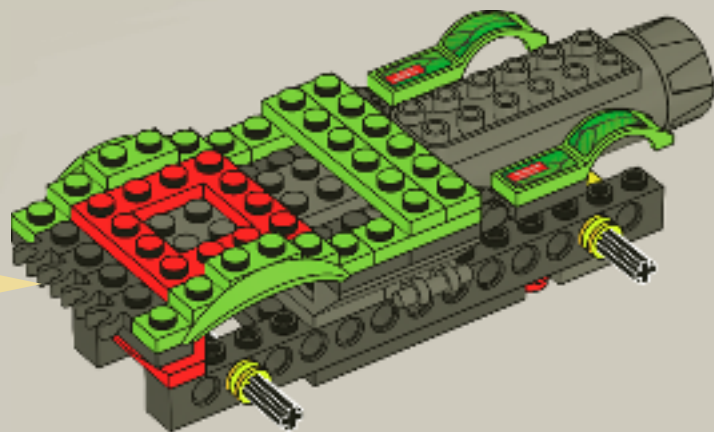



17

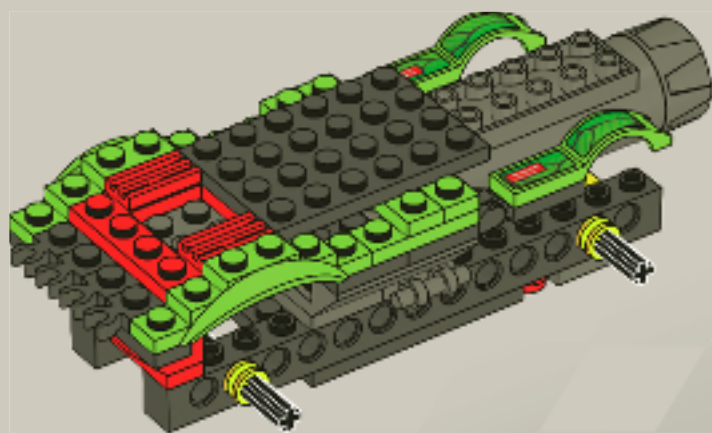



2x



1x

18

1

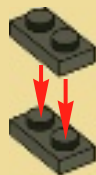

2

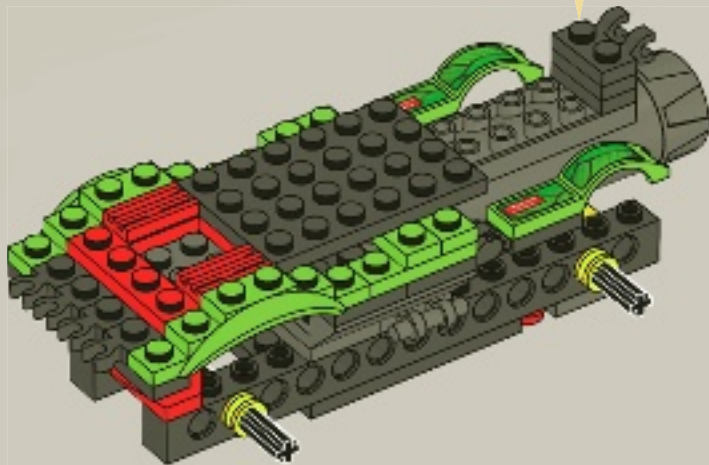



1x



2x



2x

19

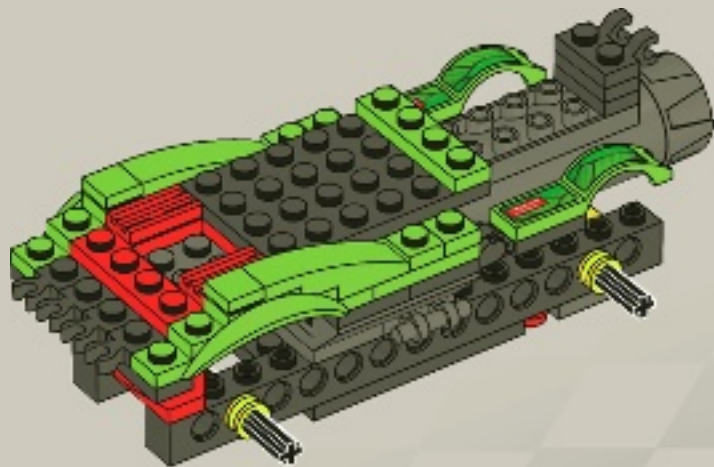



2x



2x



2x

20

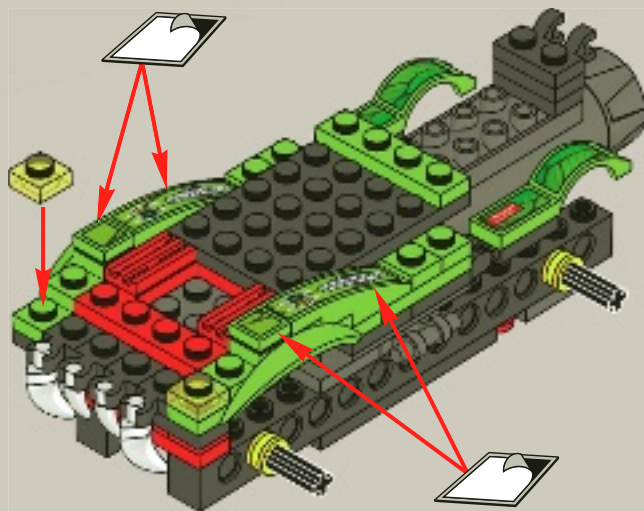

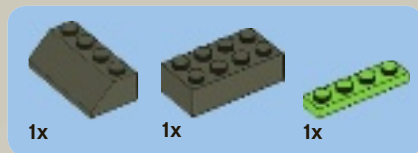

21

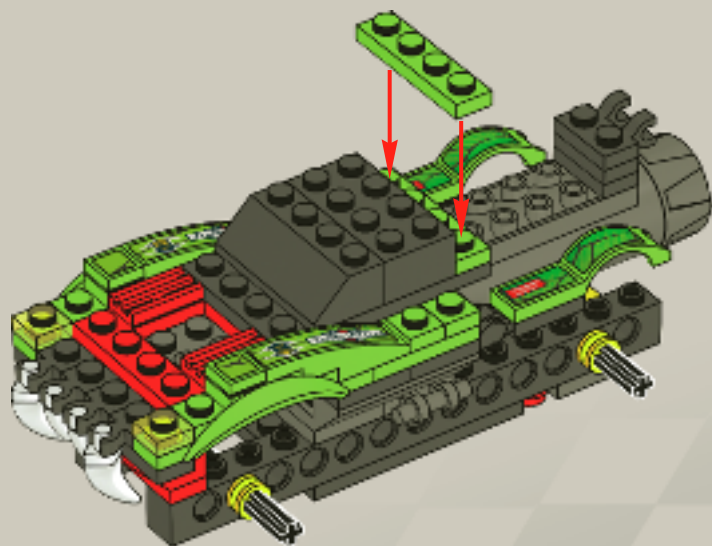



2x



1x

22

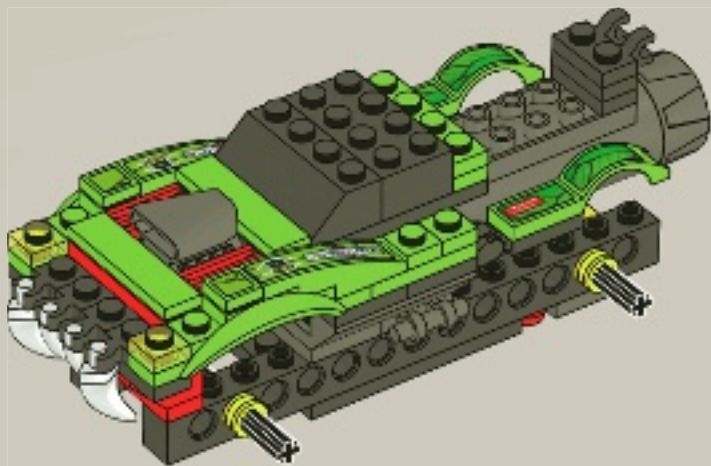



2x

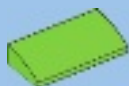

1x

23

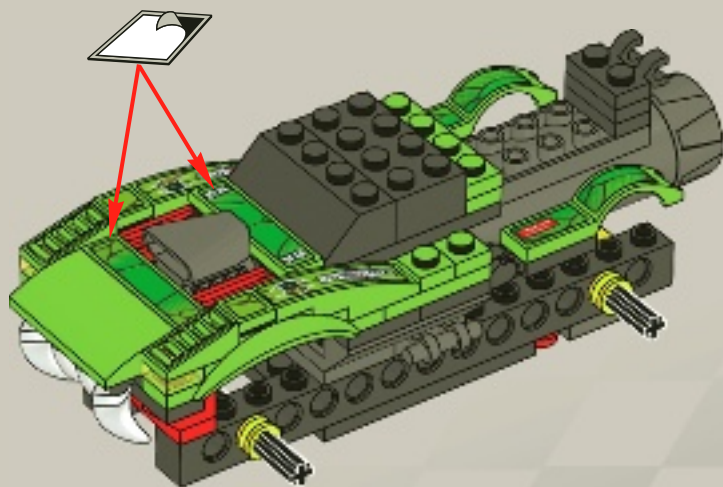

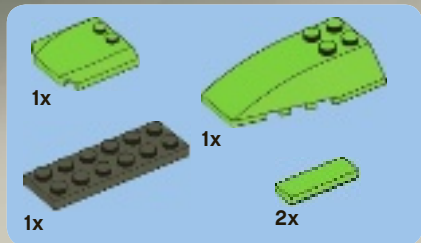
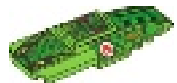

24

1

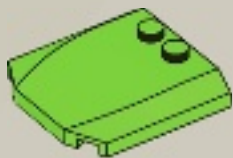

2

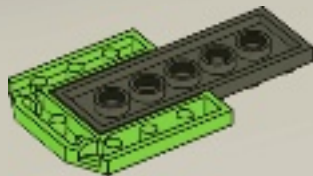

3

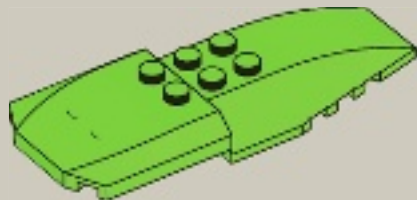

4

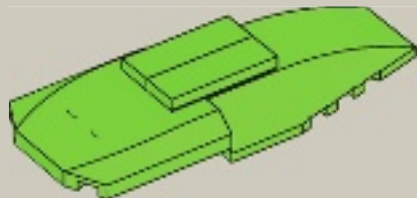

5

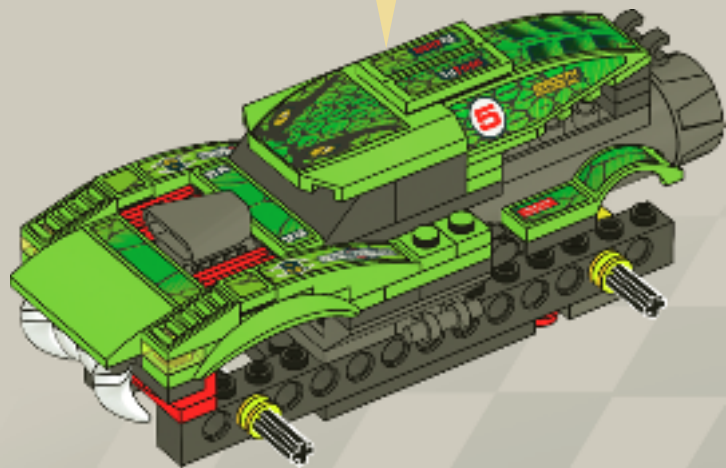
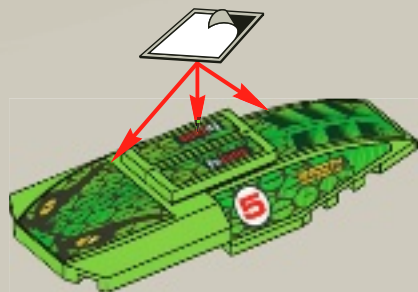



25

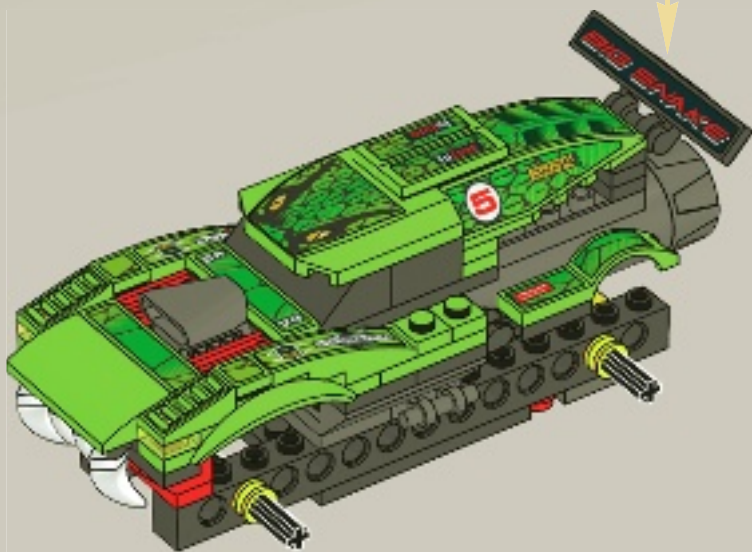



4x



4x

26

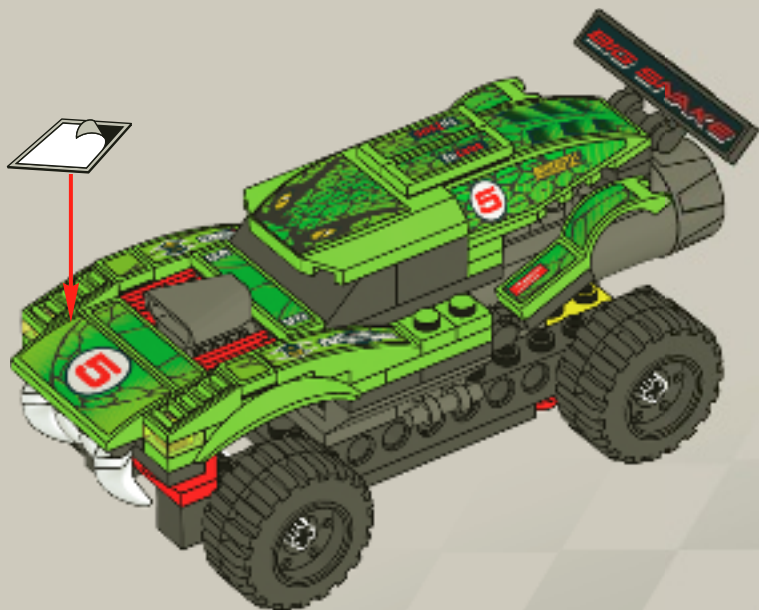



4x

27



2x

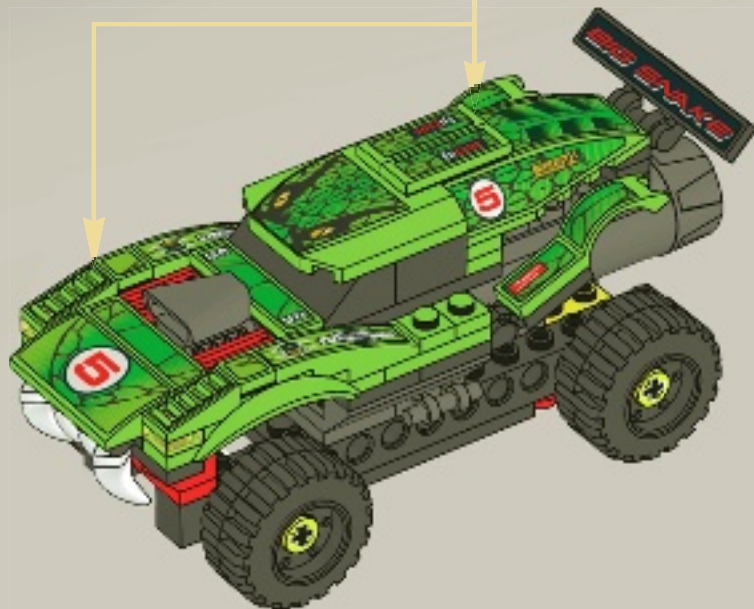

28

28

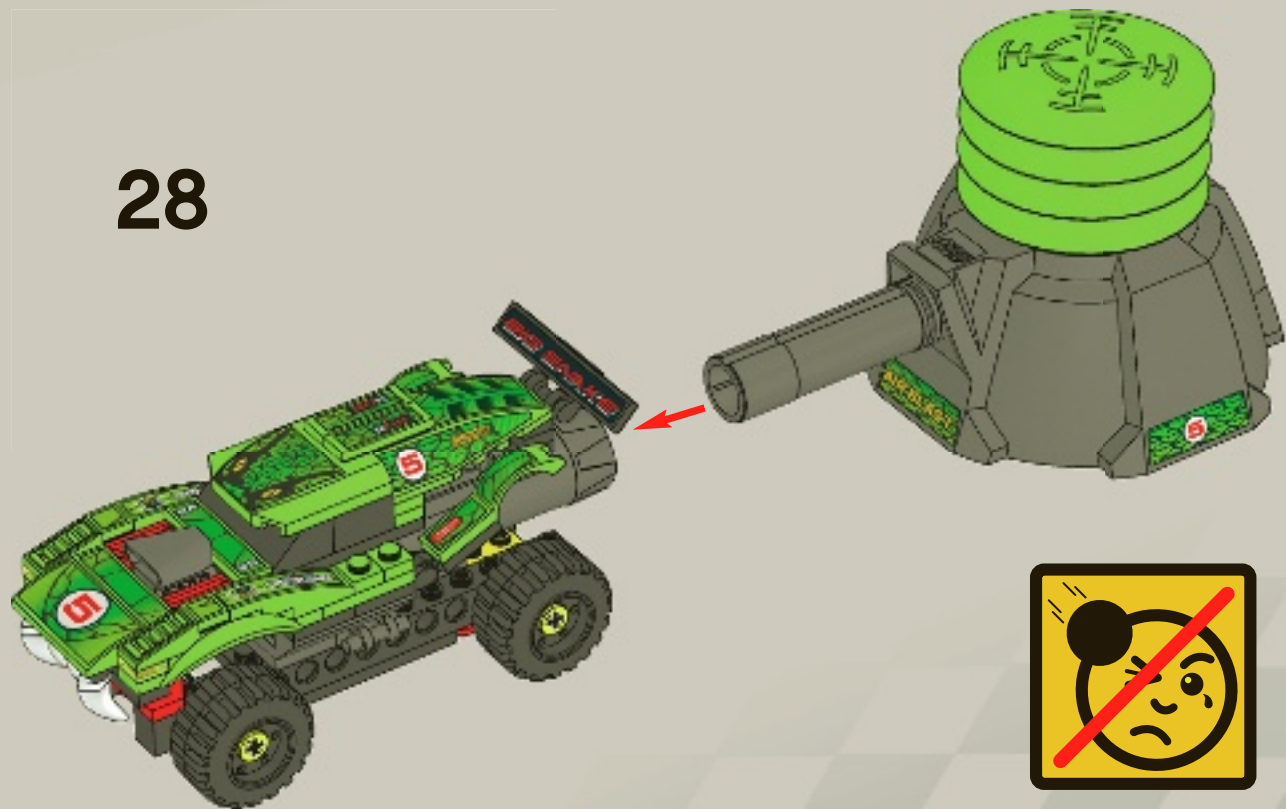



2x
366021



1x
371021



1x
4580871



2x
241221



2x
614121



2x
4566256



1x
245824



2x
370024



2x
302324



8x
4239601



1x
300126



2x
4107558



2x
4568387



1x
303726



3x
302326



1x
366626



1x
663626



2x
379526



2x
303226



4x
4550017



1x
4556158



1x
4225201



2x
4183043



2x
4183060



4x
4517737



4x
4140670

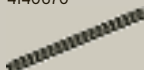

2x
370726



2x
3000844



1x
4503680



2x
4537927



2x
4537251



2x
4540385



2x
4210210



2x
4565993



2x
4164021



2x
4187743



2x
4529160



2x
4284253



1x
4597561



1x
4612424



1x
4610893



2x
4610474



3x
4211065



2x
4210660



1x
4502068



1x
4549999



1x
4210997



1x
4563226



1x
4568692



1x
4563215

8



Customer Service

Kundenservice

Service Consommateurs

Servicio Al Consumidor

www.lego.com/service or dial



00800 5346 5555 :



1-800-422-5346 :



FREE! GRATIS! GRATUIT!





club
MAGAZINE™

www.LEGOclub.com



00800 5346 5555*        

  **1-866-534-6258 • 1-877-518-5346**

US & Canada only

Canada seulement

* Freephone. Mobile charges may apply. * Numéro sans Frais. Des Frais peuvent s'appliquer avec les téléphones cellulaires. * Gebührenfrei. Kosten für Anrufe aus Mobilfunknetzen können abweichen. * Gratís telefonnummer vanaf vaste lijn. * Det er ett gratis nummer, når du ringer fra Fasttelefon. * Det är gratis, när du ringer från en Fast telefon.



VISIT THE WORLD'S
BIGGEST LEGO® SHOP!

www.LEGOshop.com

Go to www.LEGOsurvey.com/product to fill out a survey for a chance to win a cool LEGO® Product.

No purchase necessary.

Open to all residents where not prohibited.

www.LEGOsurvey.com/product

GEWINNE!

Nimm an der Umfrage auf www.LEGOsurvey.com/product teil und hab die Chance ein cooles LEGO® Produkt zu gewinnen!

Die Teilnahme am Gewinnspiel führt zu keinerlei Kaufverpflichtungen. Teilnahme in allen nicht ausgeschlossenen Ländern möglich.

4614527

WIN!

Ga naar www.LEGOsurvey.com/product, vul een enquêteformulier in en maak kans op een cool LEGO® product.

Geen aankoopverplichting. Iedereen mag deelnemen, uitgezonderd ingezetenden van landen waar een enquêteverbod geldt.

LEGO and the LEGO logo are trademarks of the LEGO Group. ©2011 The LEGO Group. ©2011 LucasFilm Ltd. & TM. All rights reserved.

GAGNE!

Visite www.LEGOsurvey.com/product pour répondre à un questionnaire et avoir une chance de gagner un produit LEGO® très cool!

Aucune obligation d'achat.

Ouvert à tous les résidents des pays autorisés.

当てよう!

www.LEGOsurvey.com/product にアクセスして、アンケートにご記入ください。当選者にはレゴ®製品を差し上げます。

お買い上げの必要はありません。

禁止されていない限り、すべての皆様にご利用いただけます。