

# BIONICLE

HYDRAXON

[WWW.BIONICLE.COM](http://WWW.BIONICLE.COM)



8923

LEGO



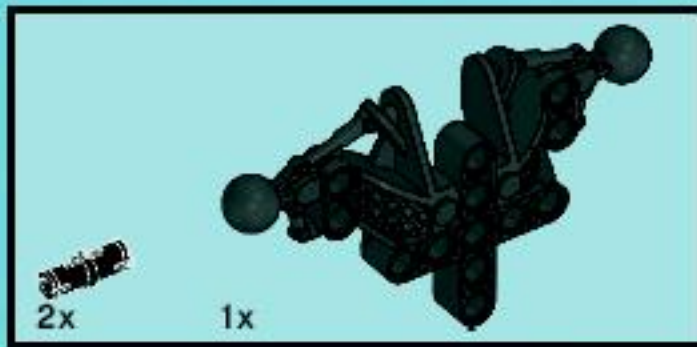
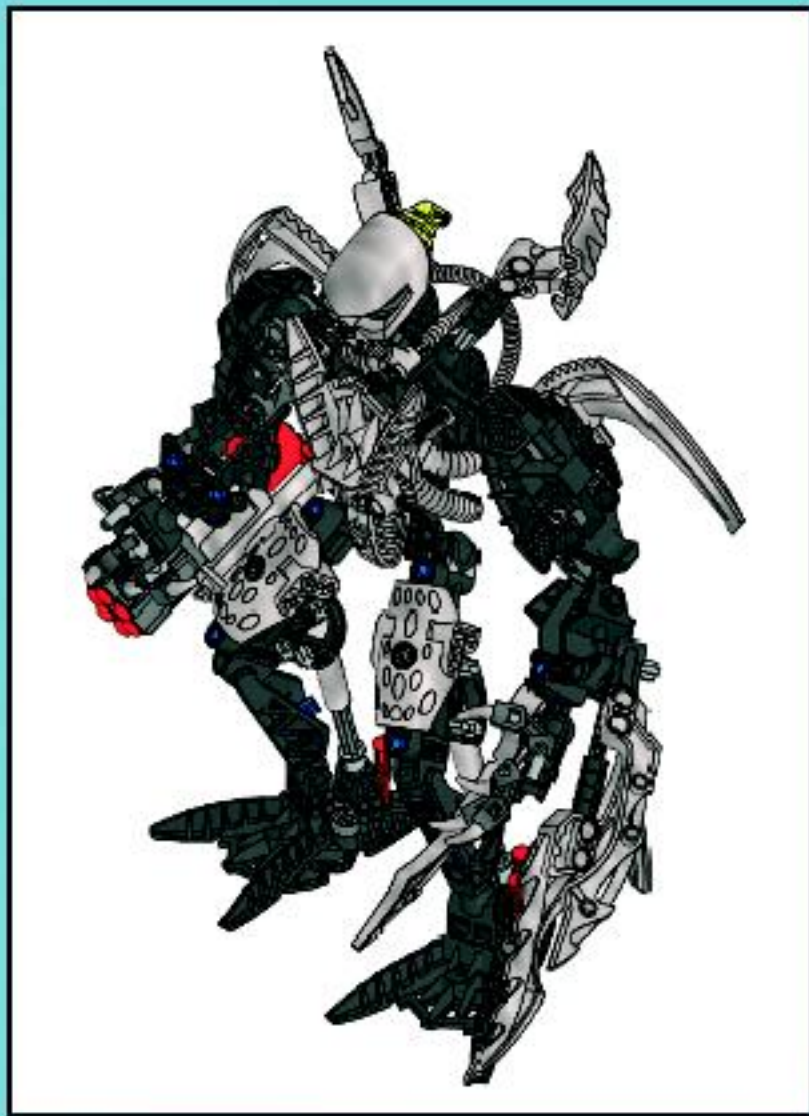

1

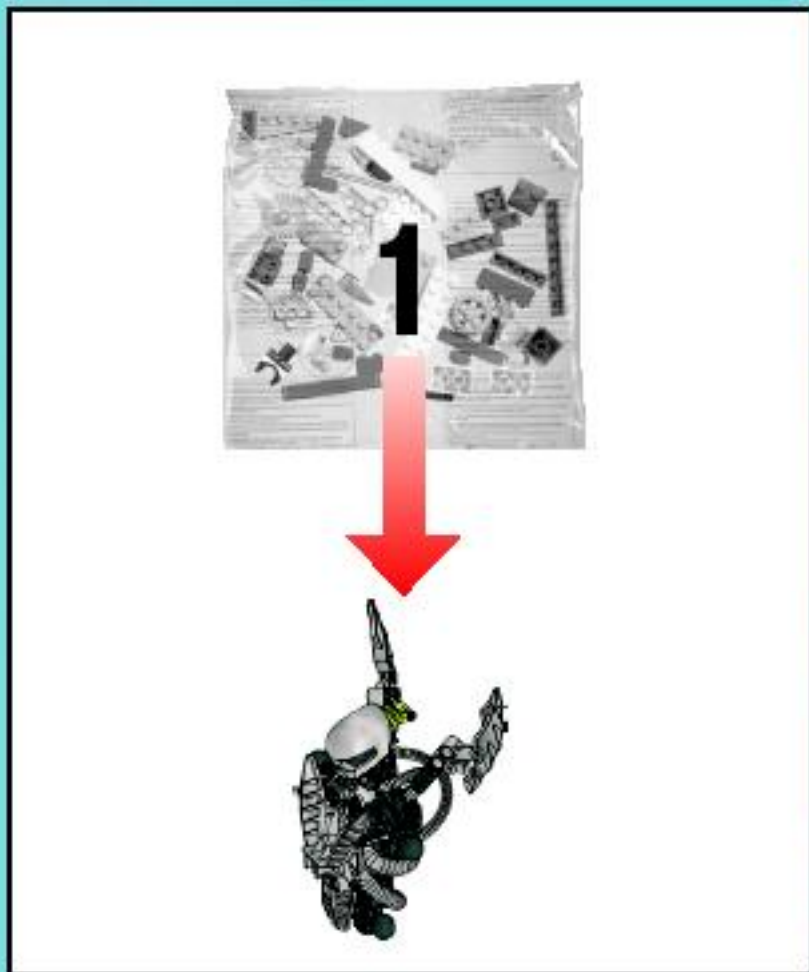
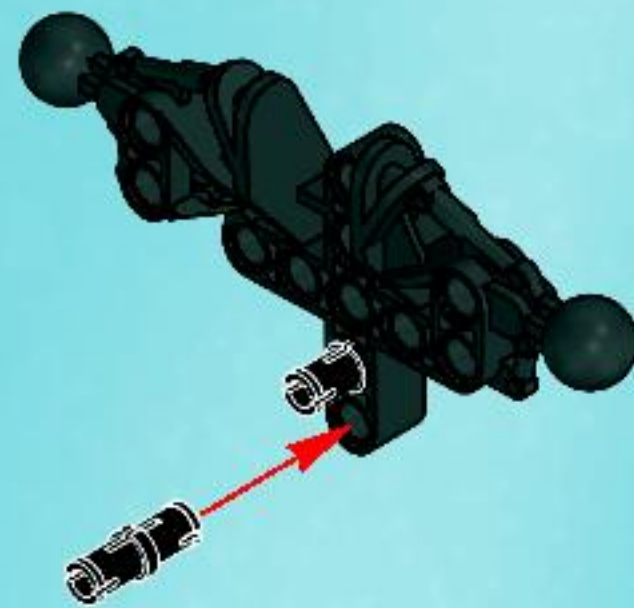

2

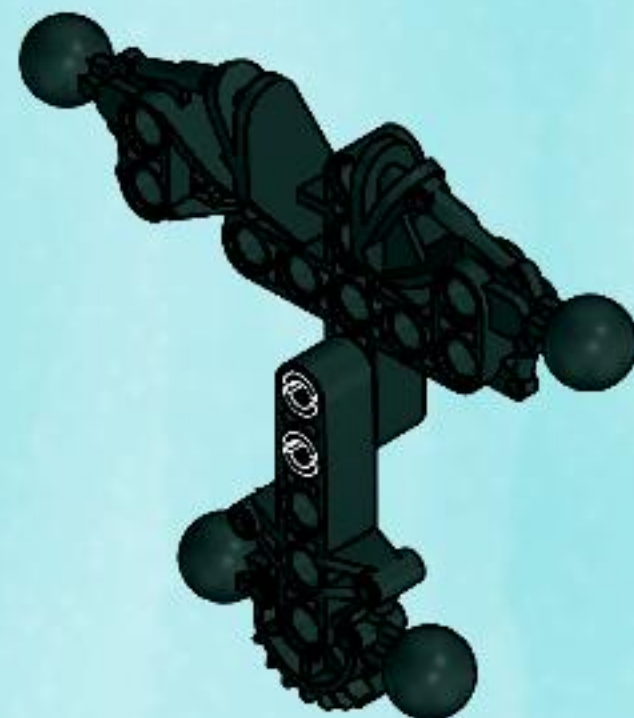

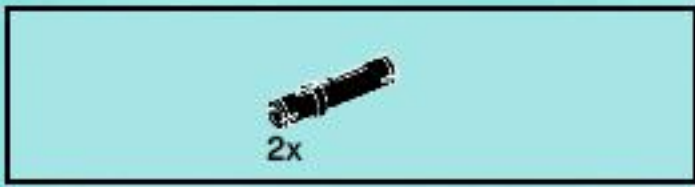

3

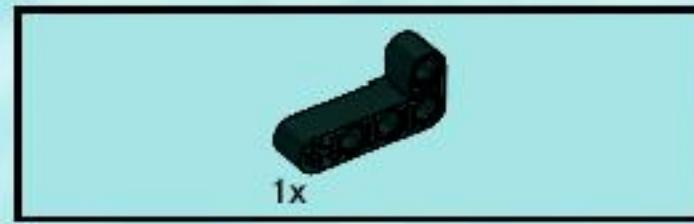

4

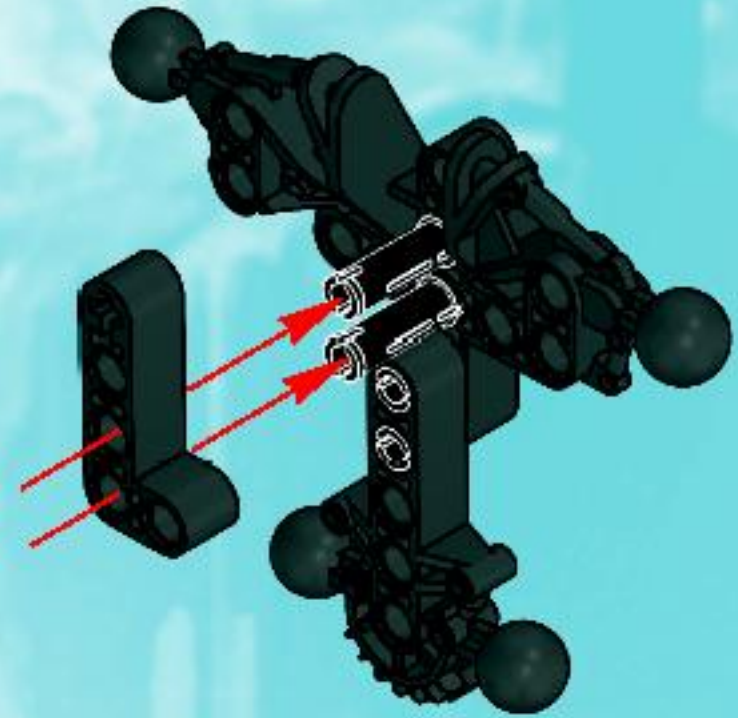





5

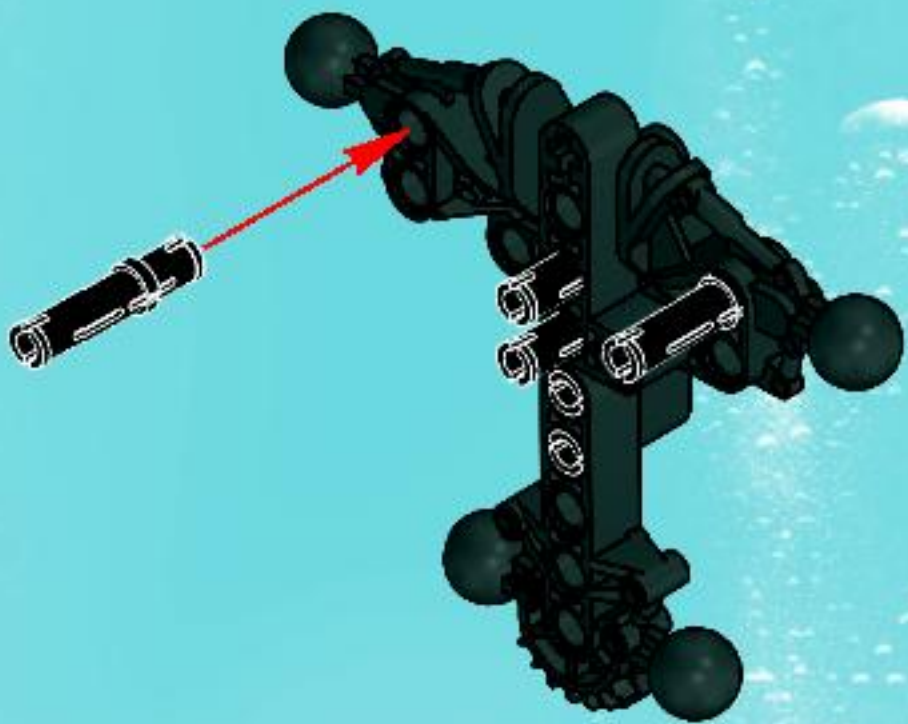

6

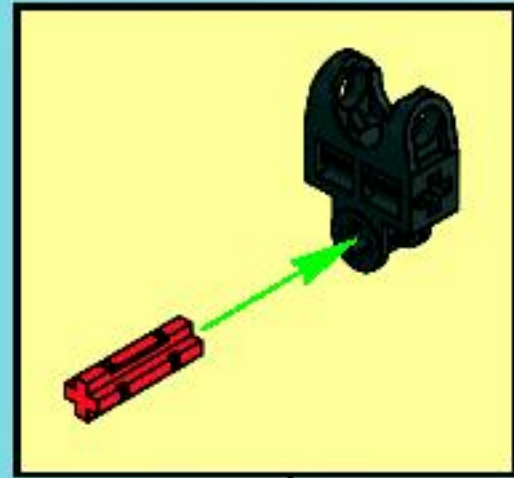

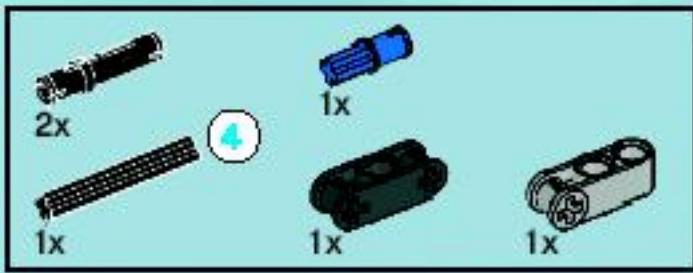

7

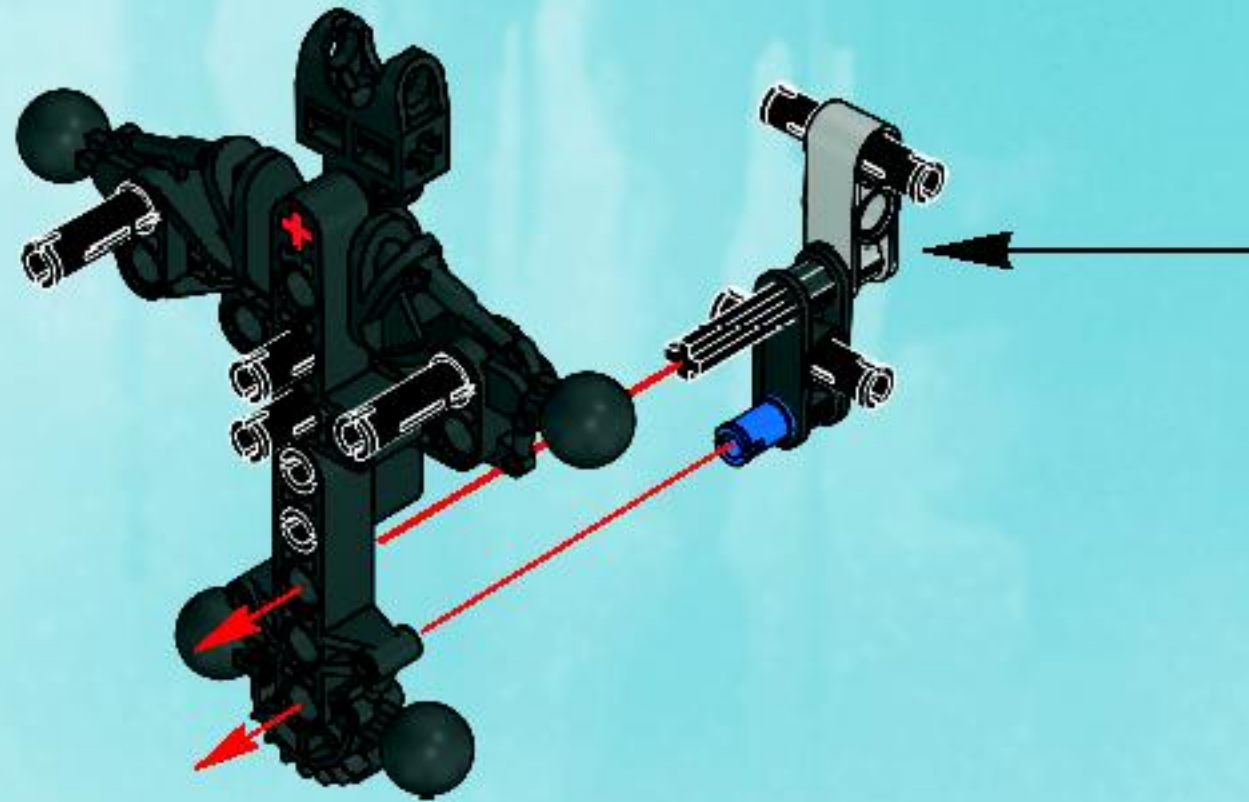
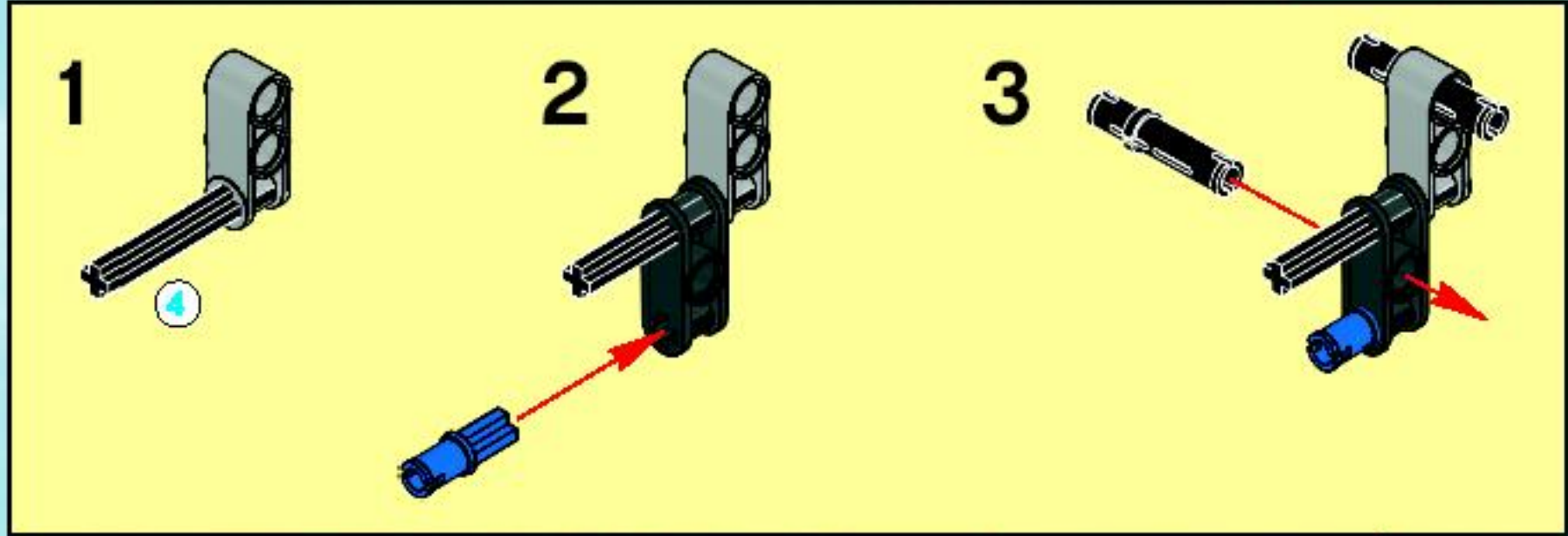



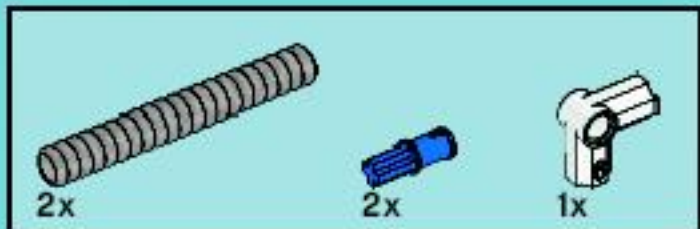

8

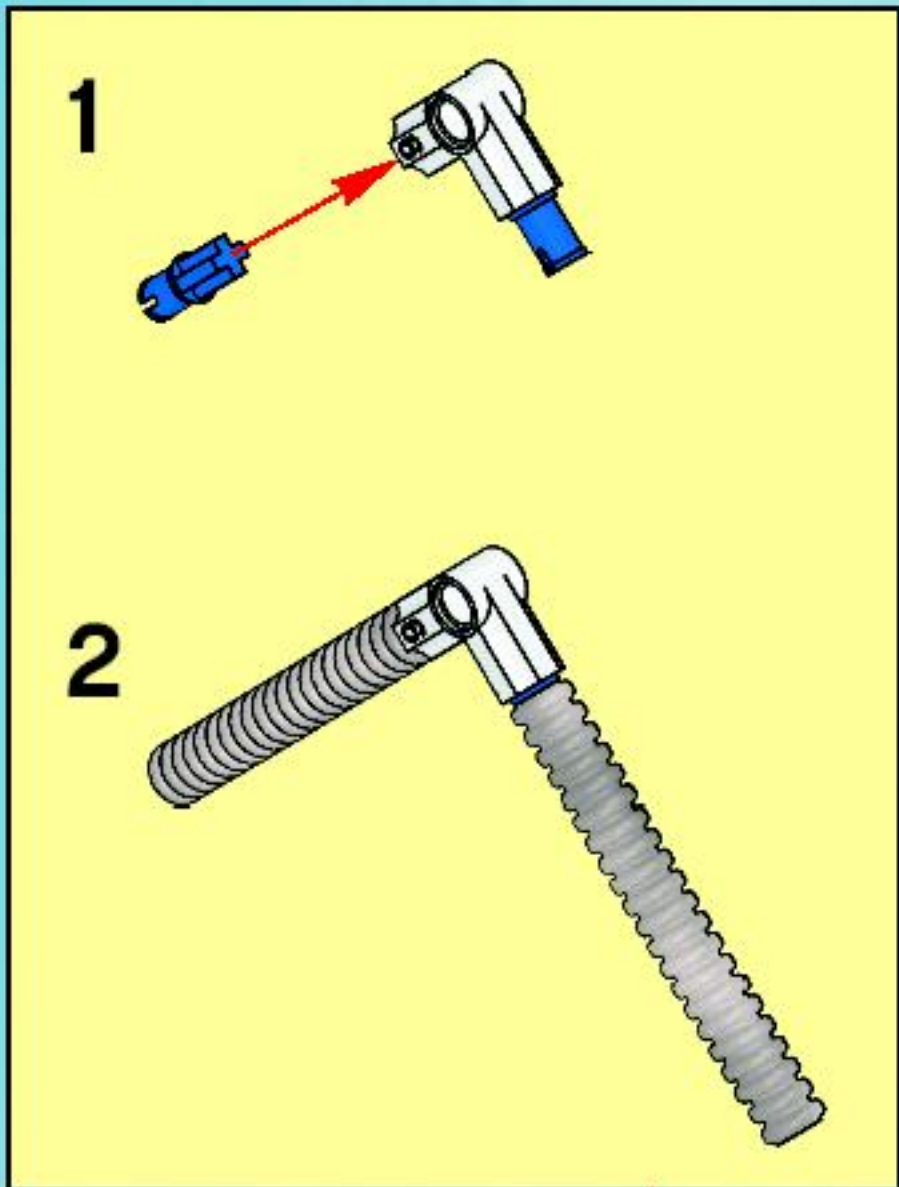

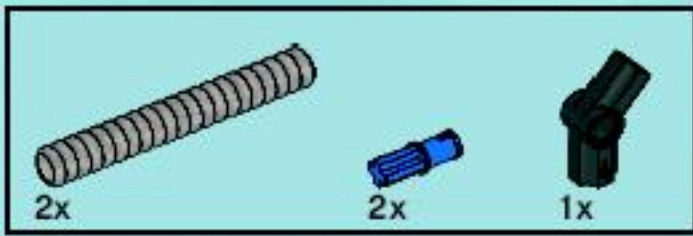

9

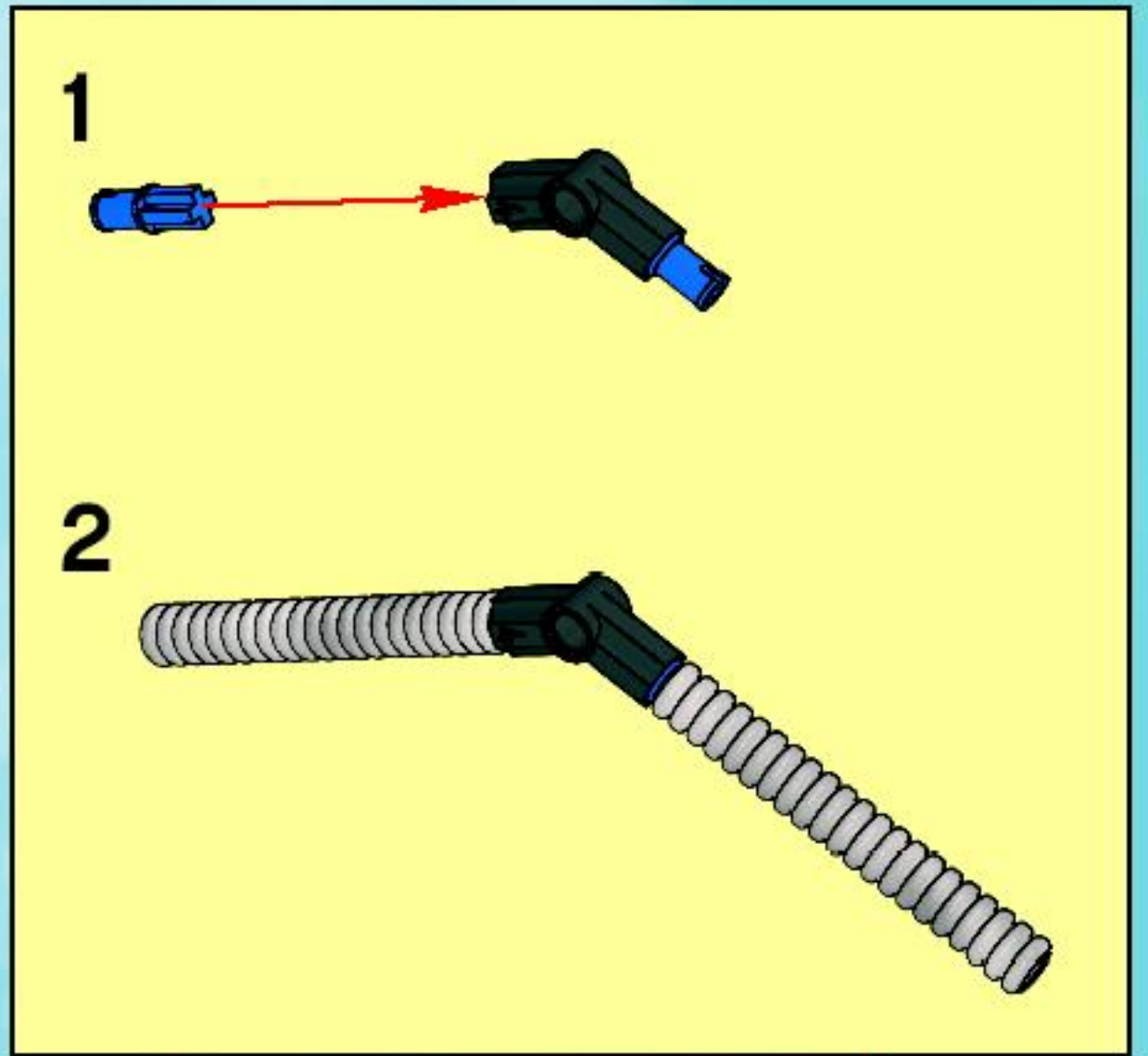





2x

# 10

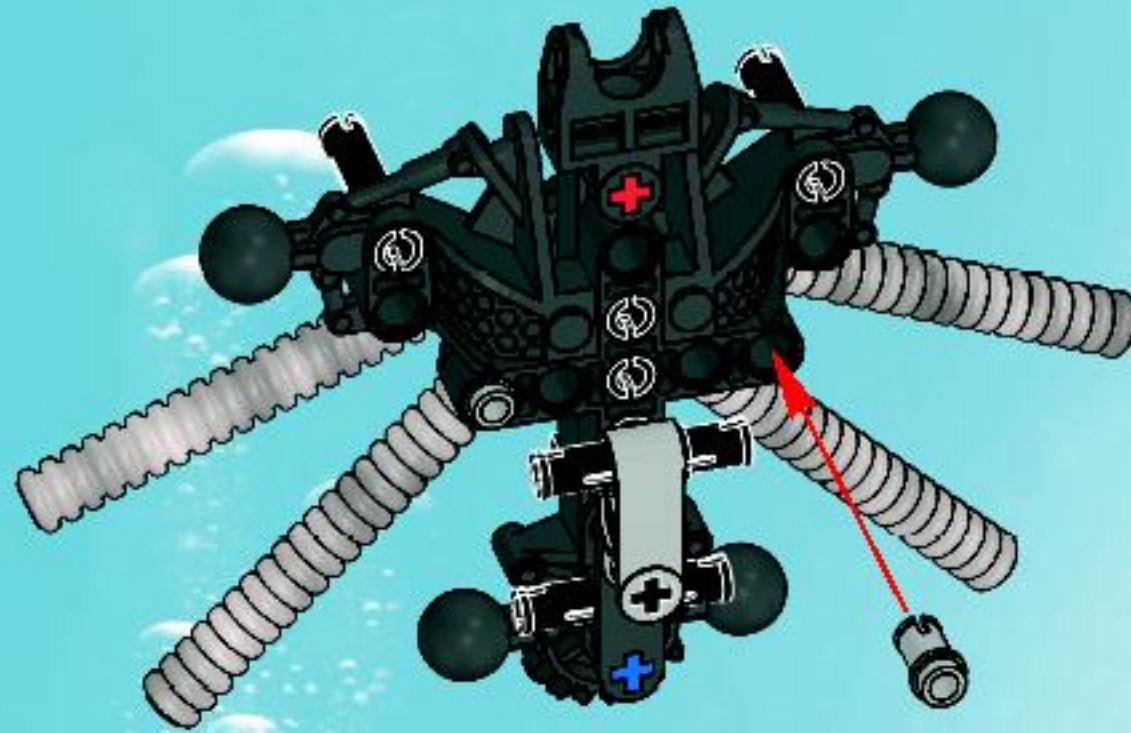



11

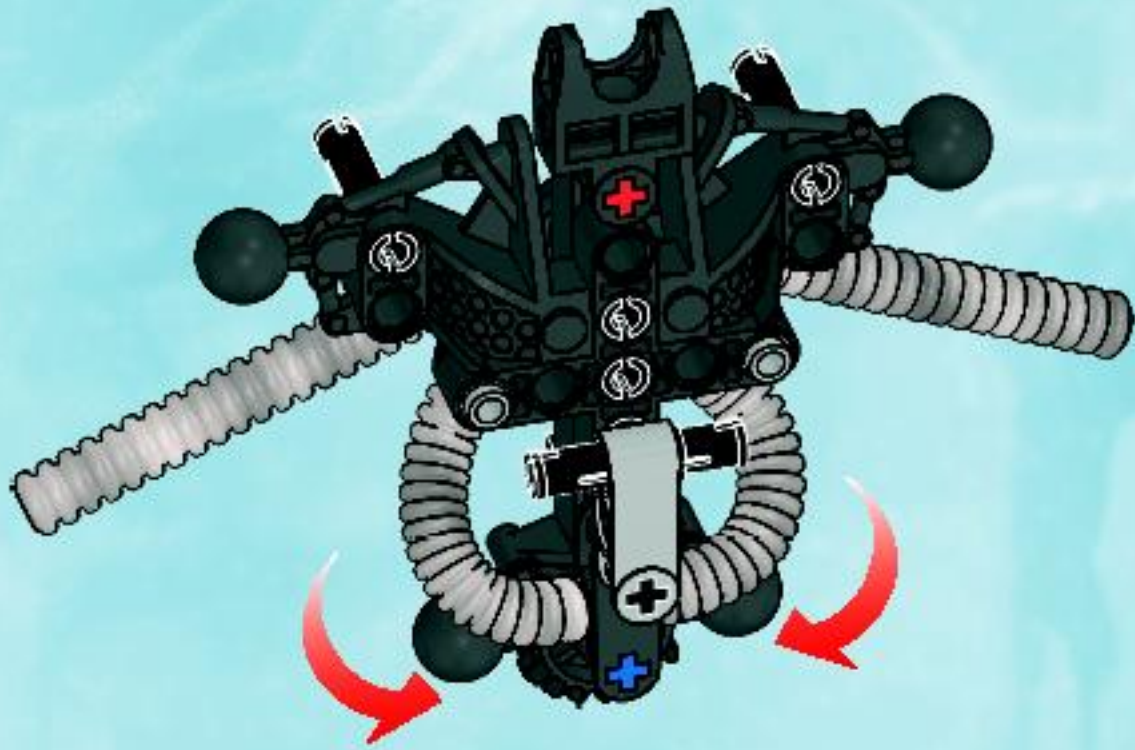

12





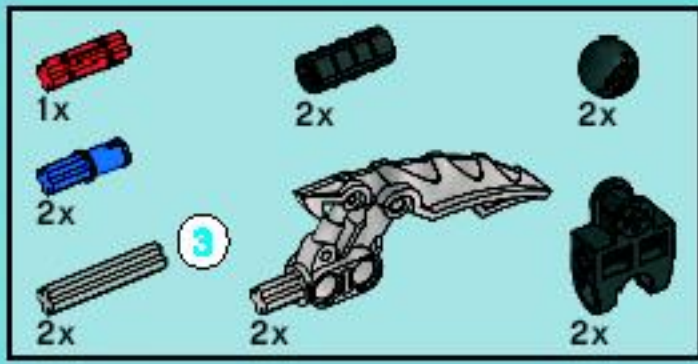

# 13

1

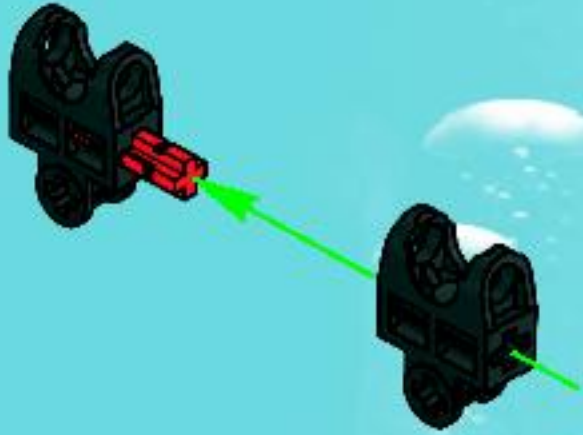

2

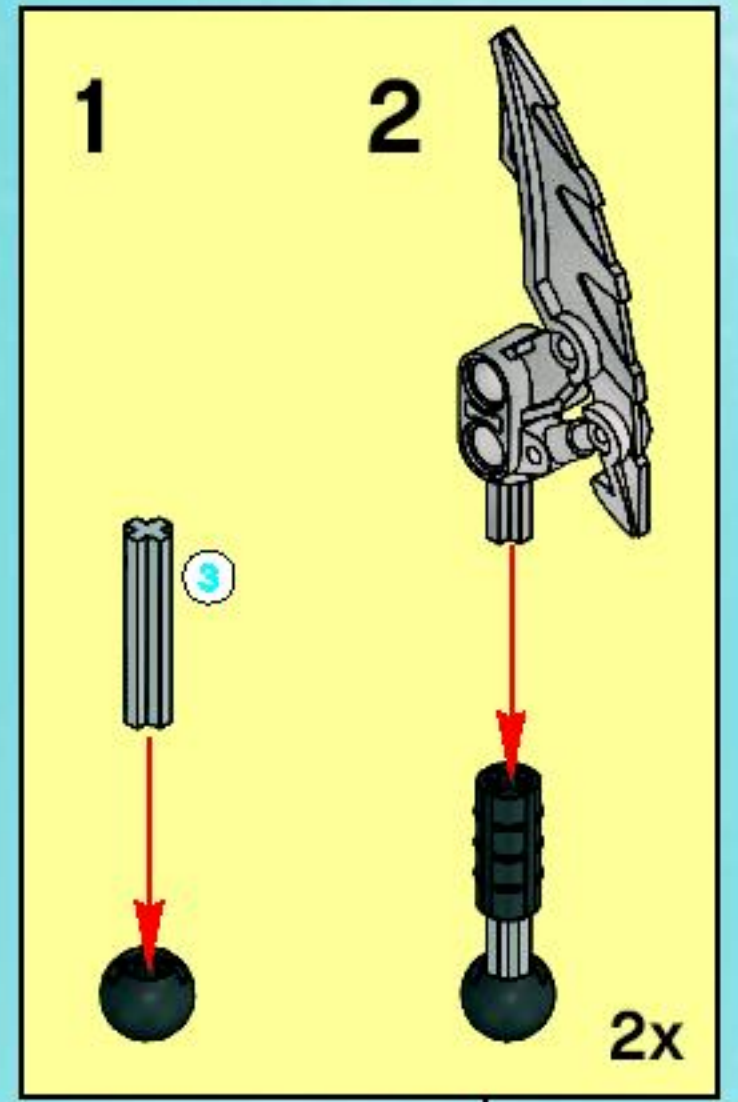
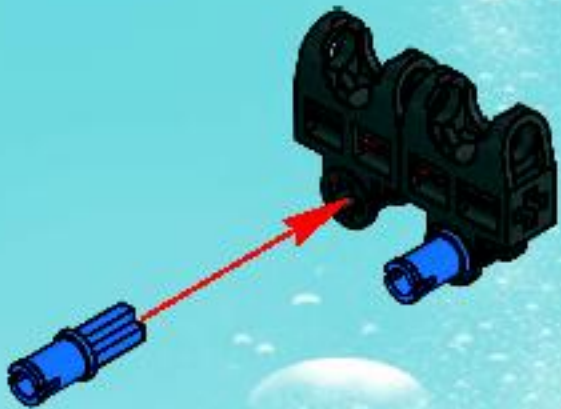

3

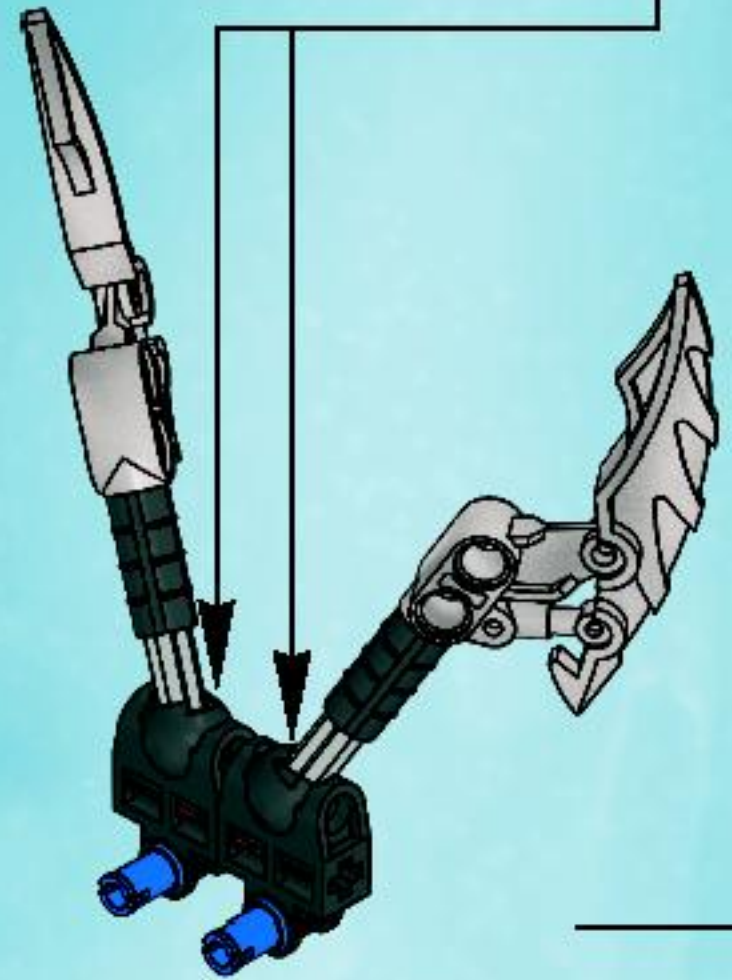



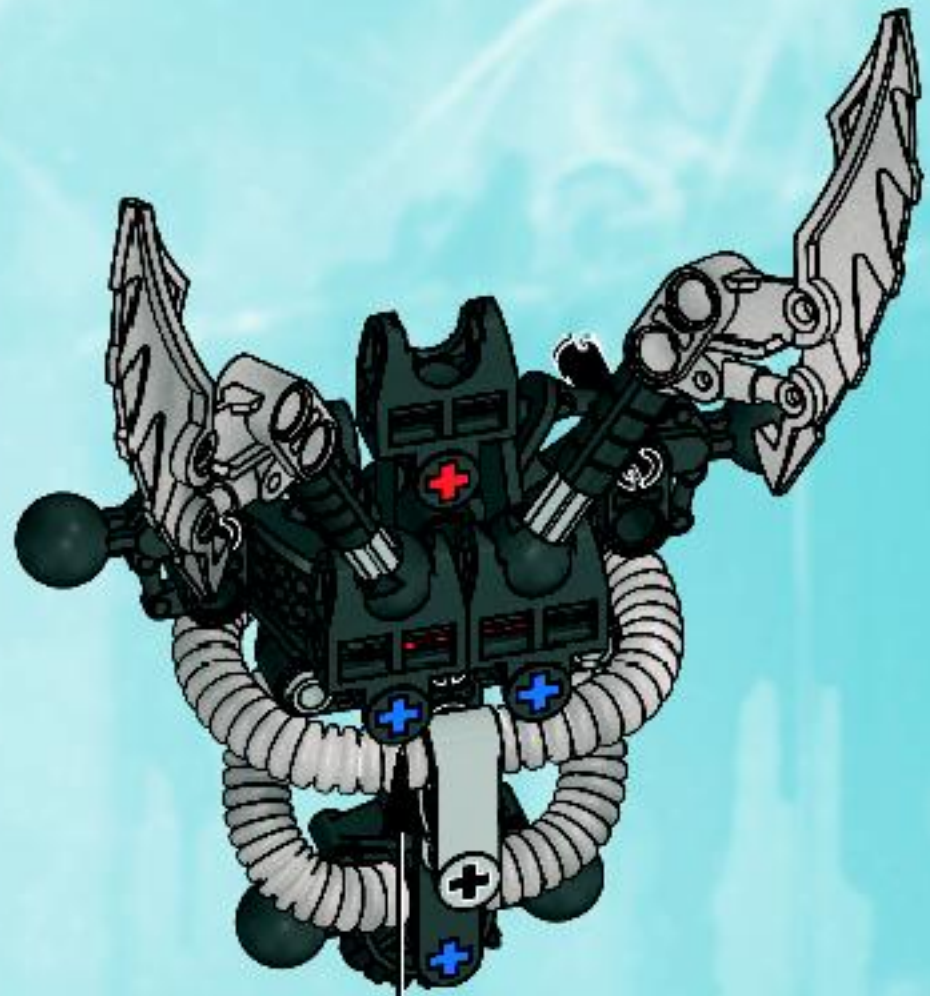



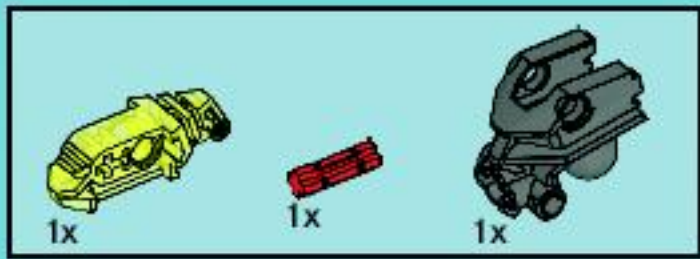

14

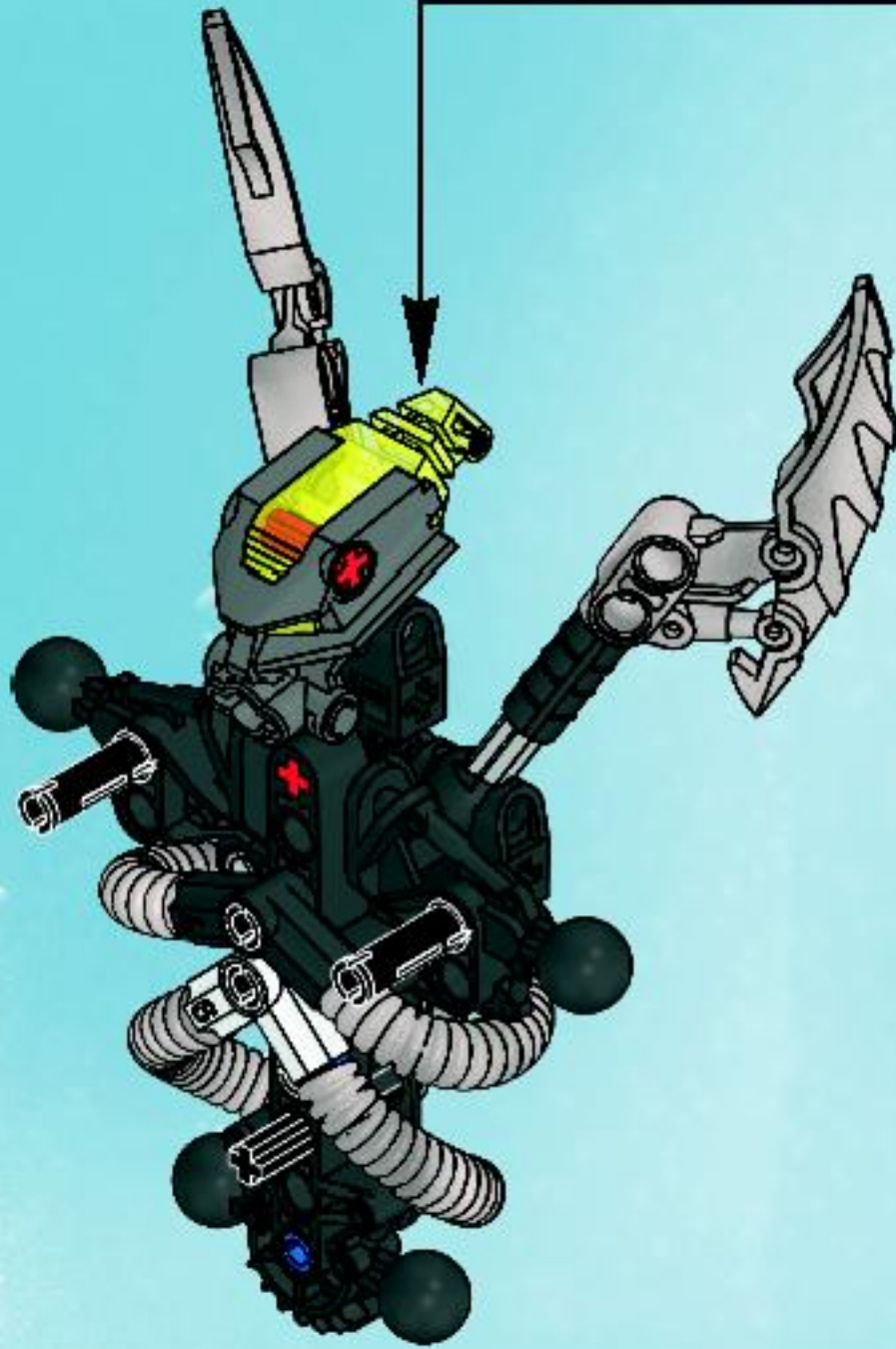
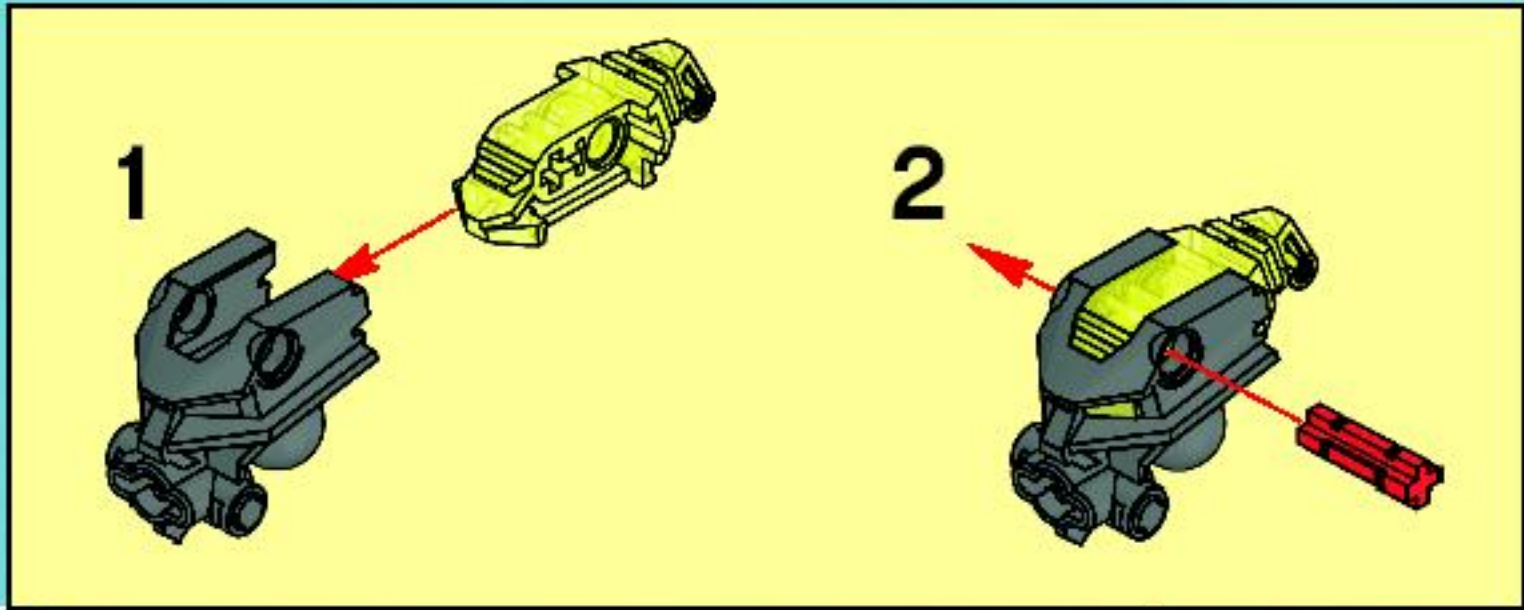



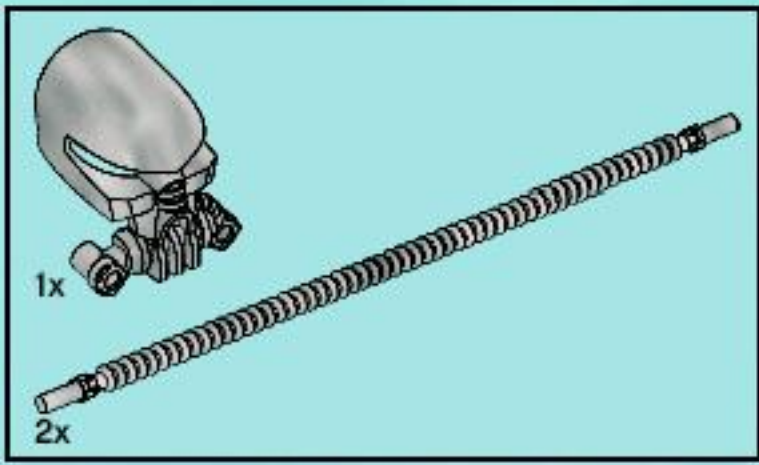

15

1



2

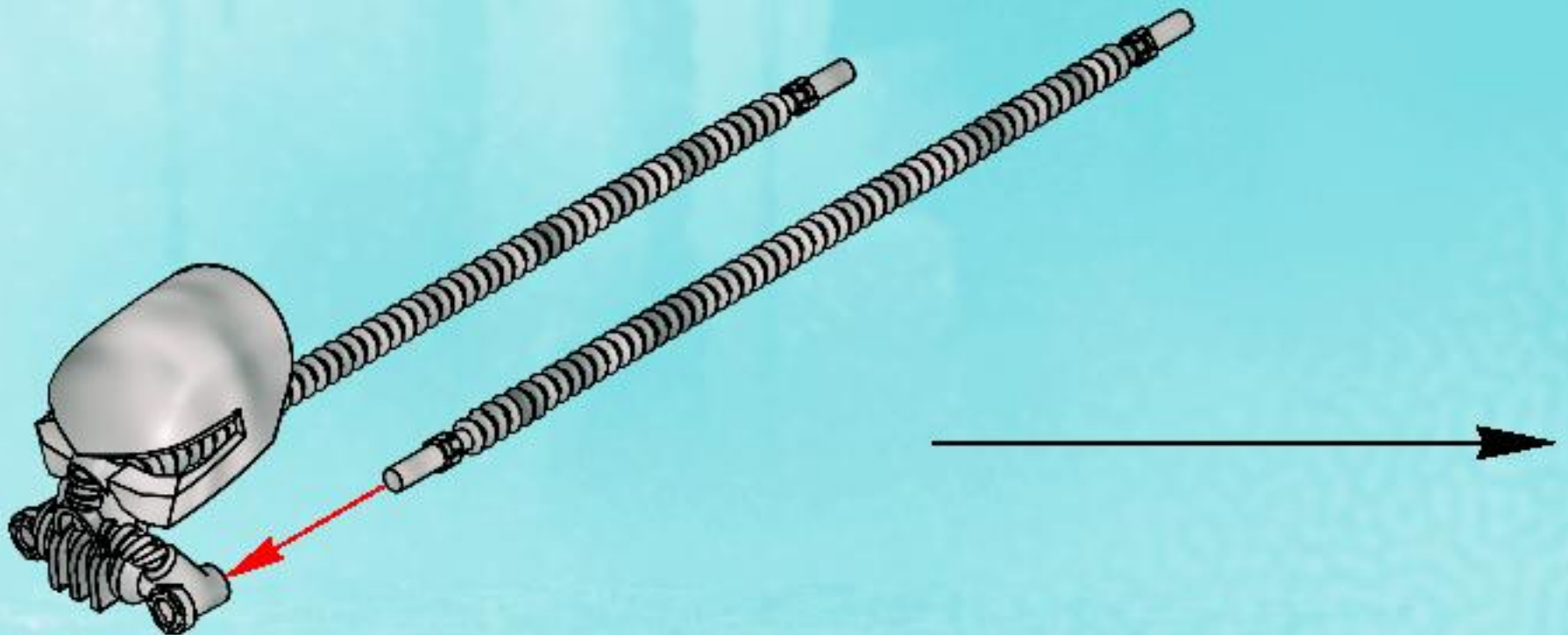



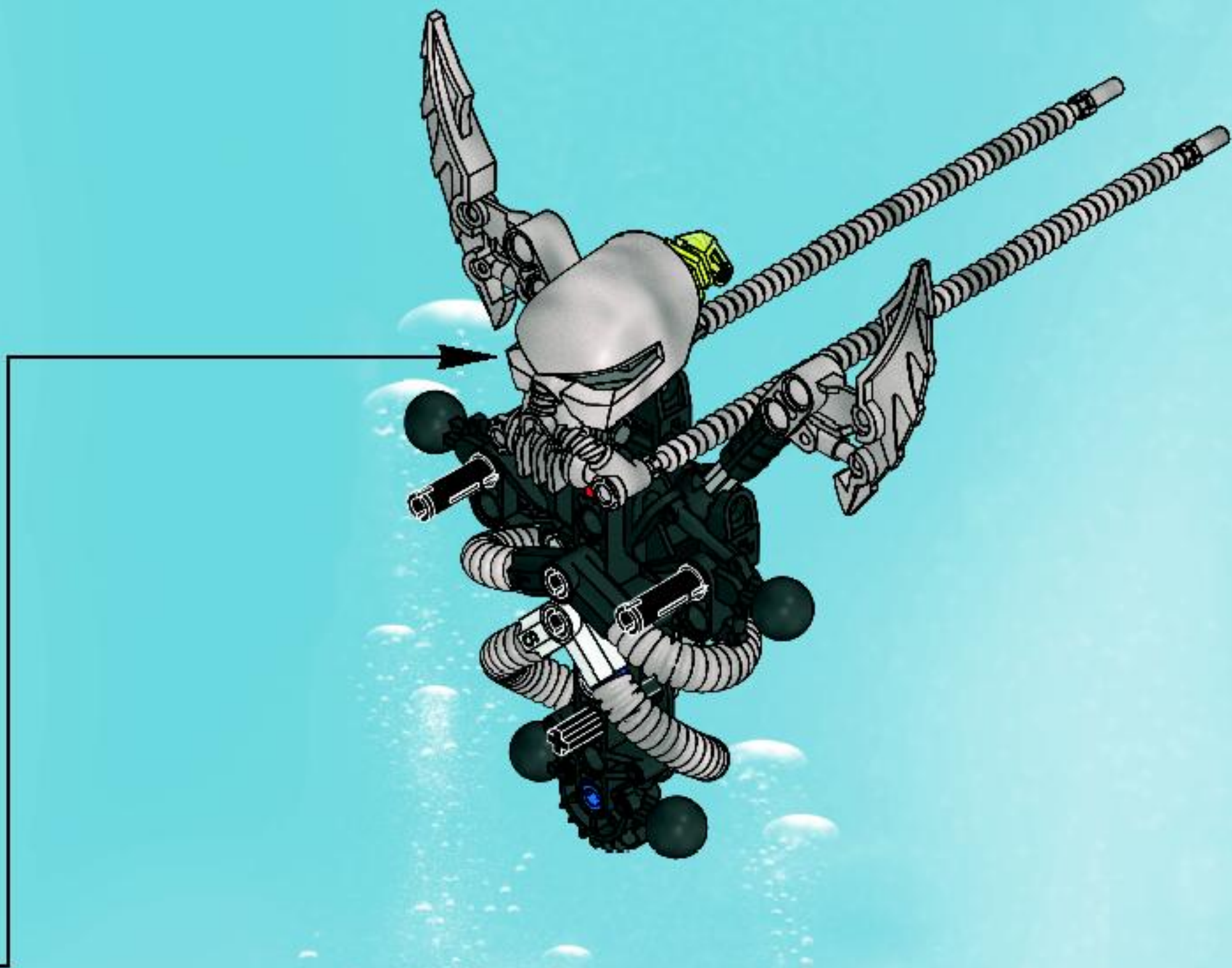



16



17





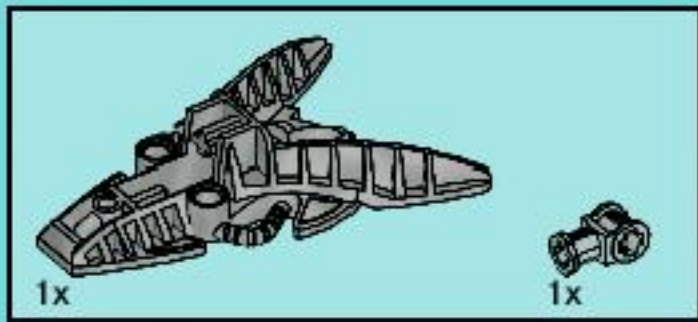

18

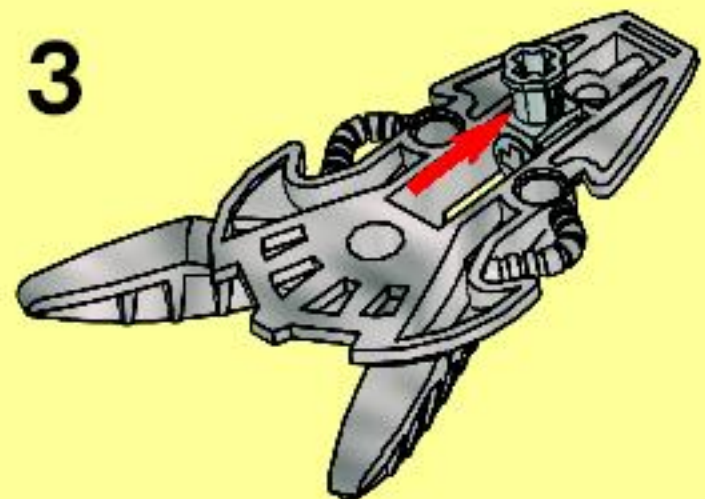
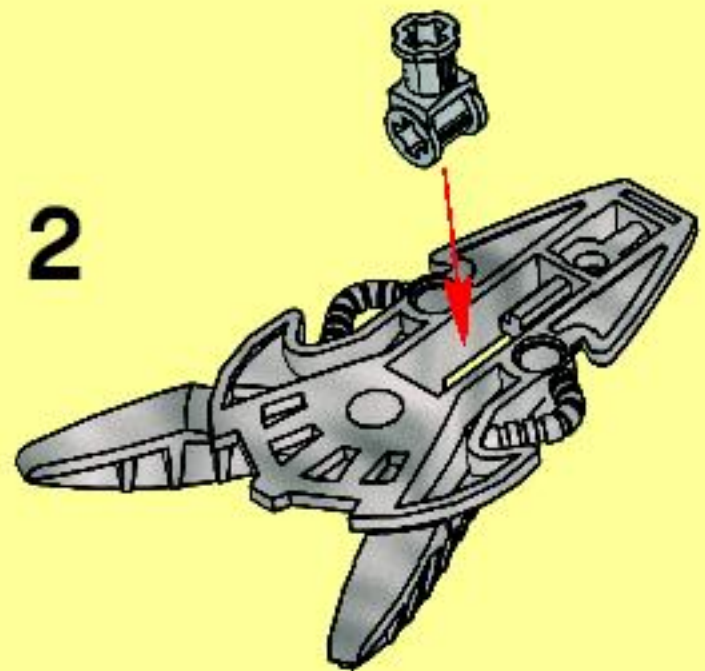
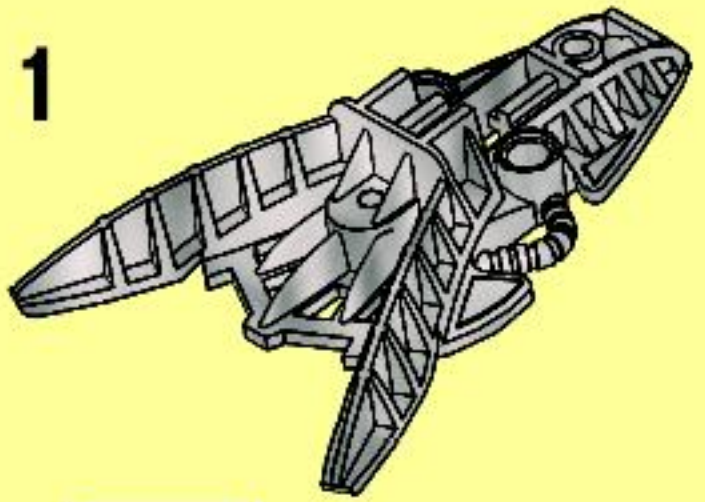



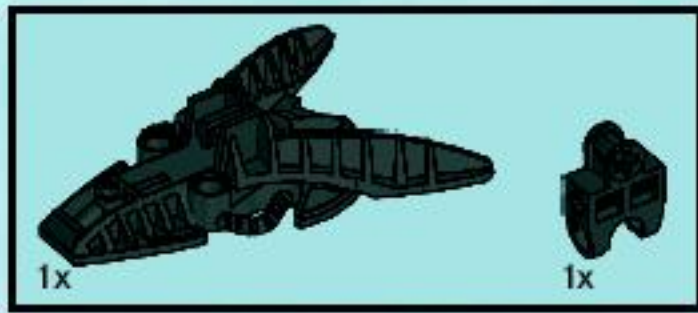
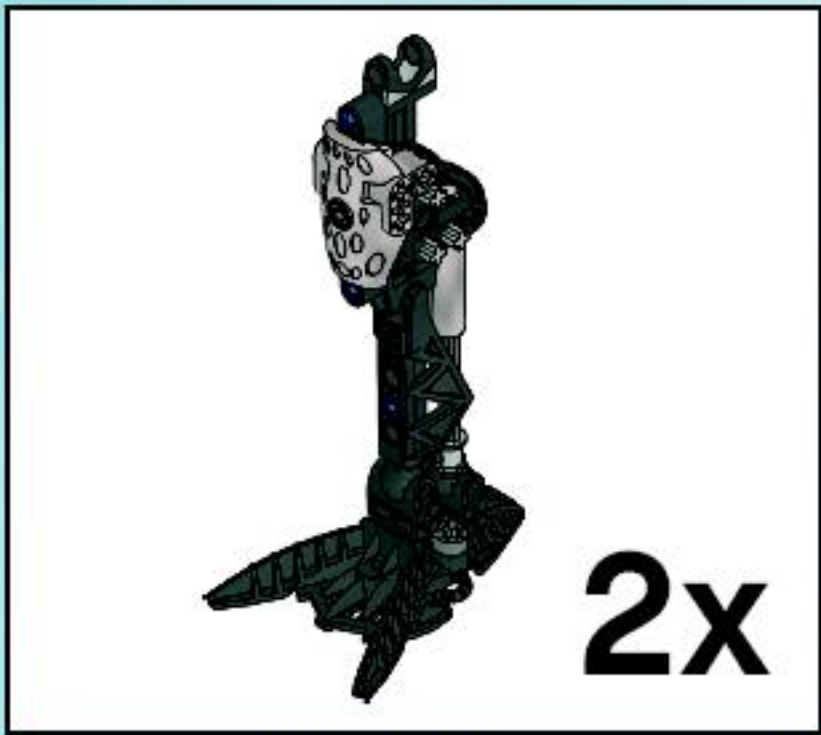

1



2

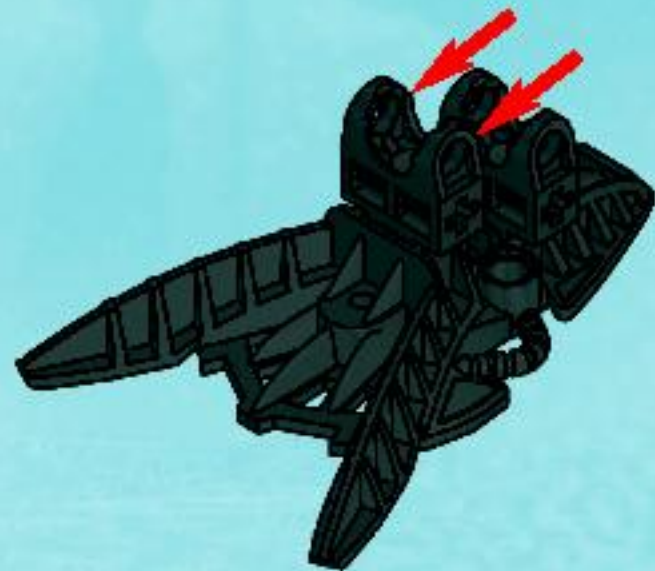





3

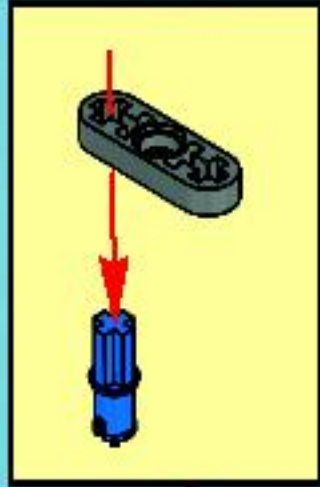



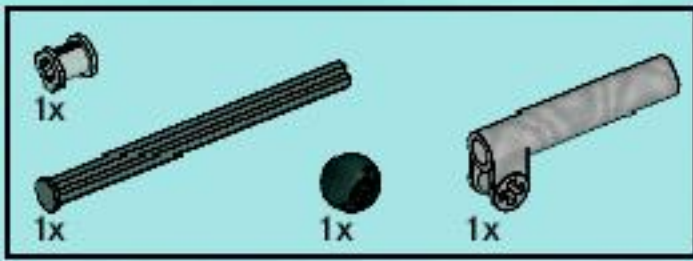

4

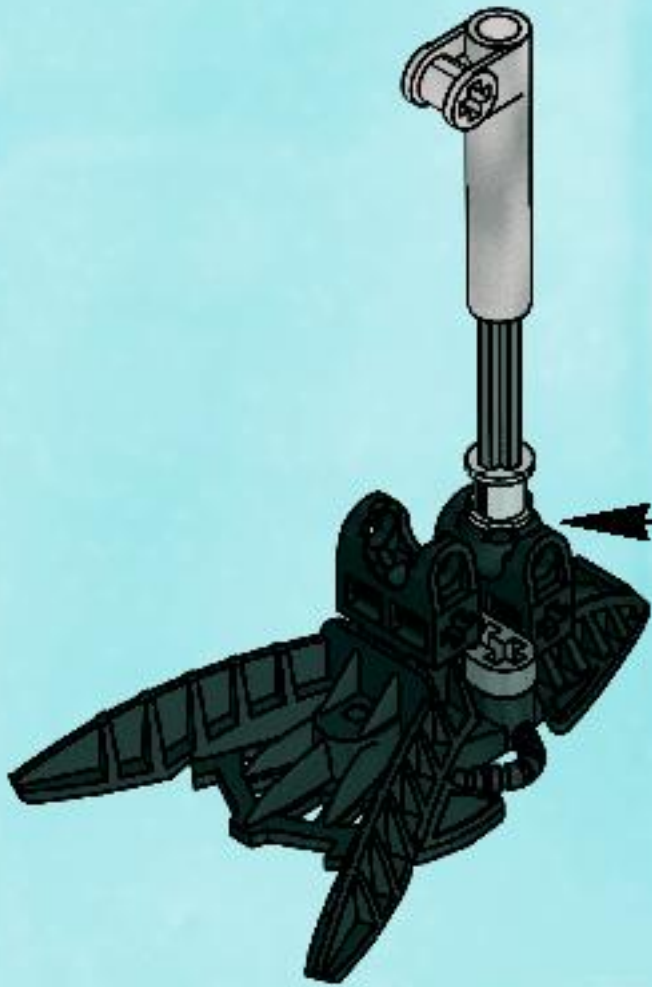
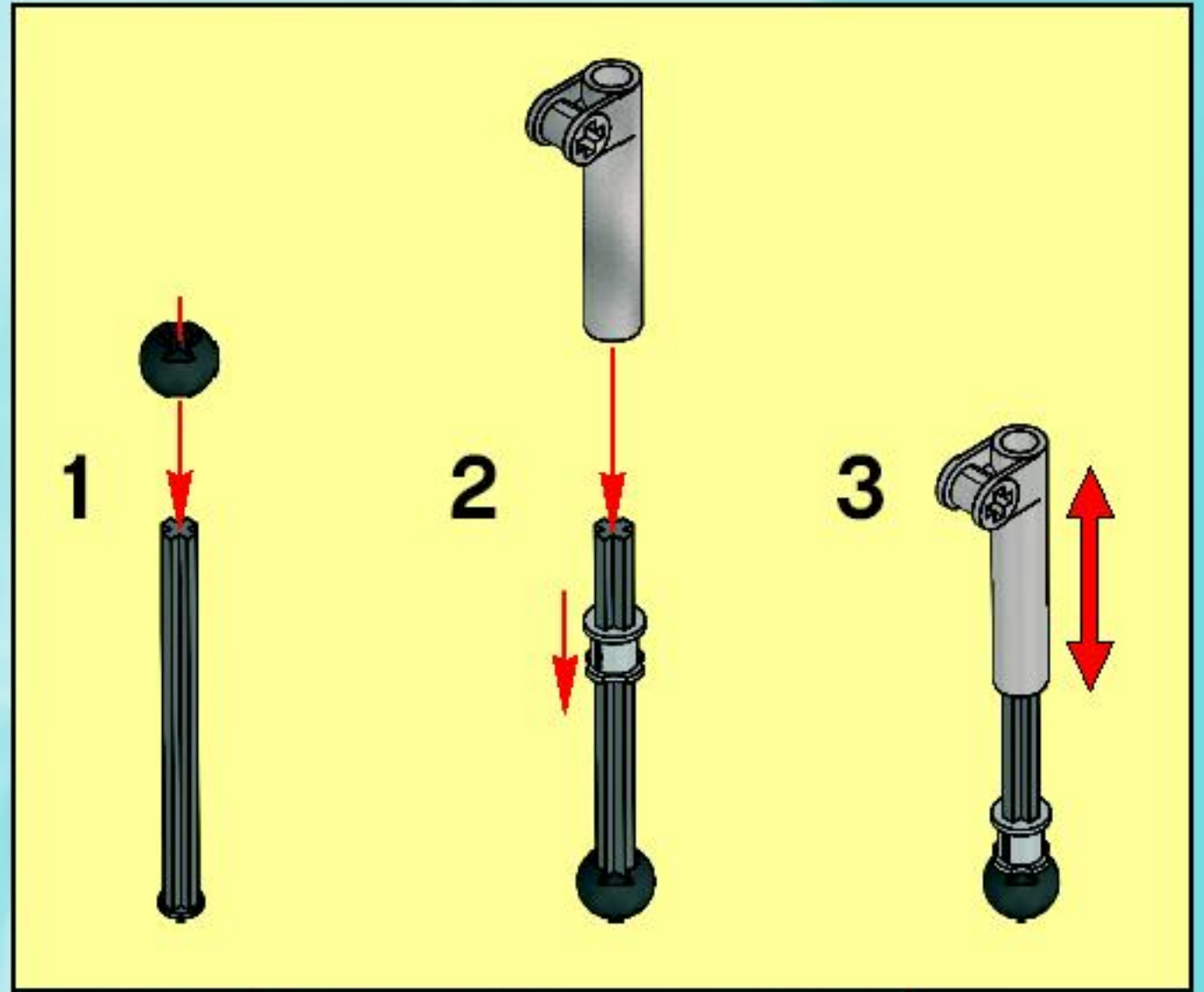



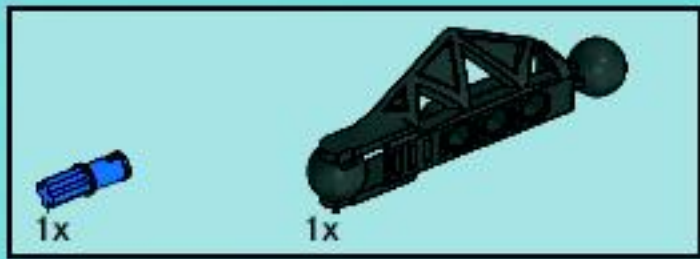

5

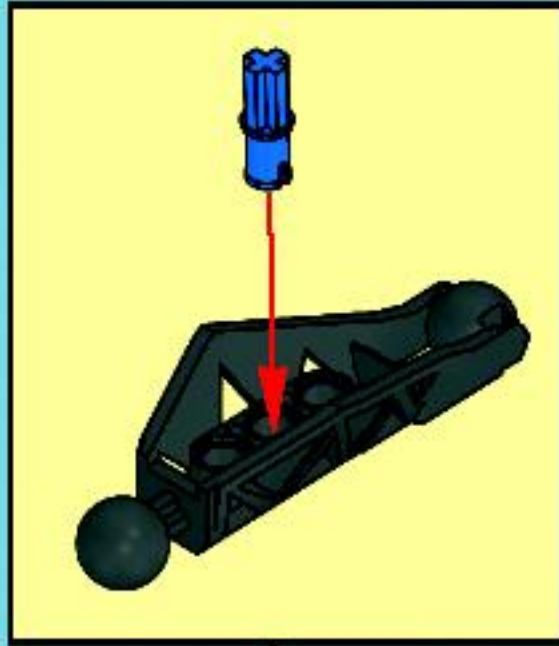





1

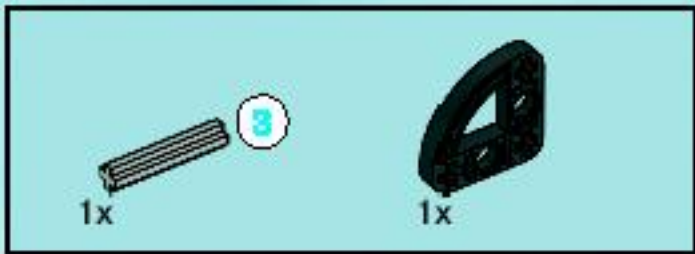

2

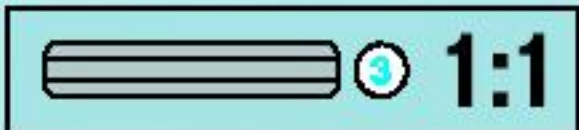
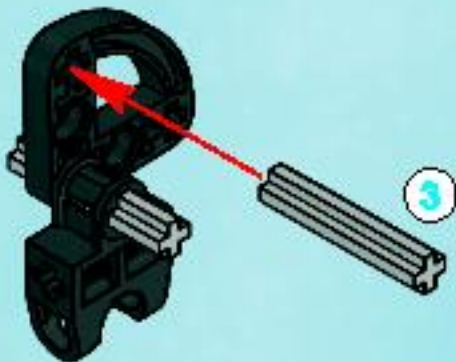

3

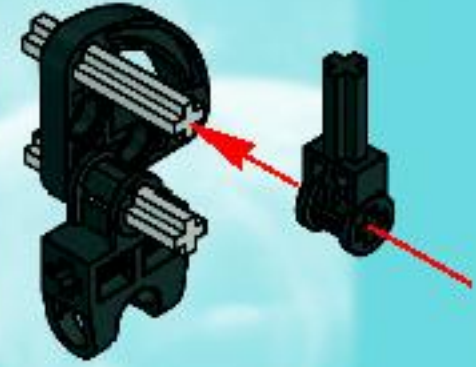

4







5

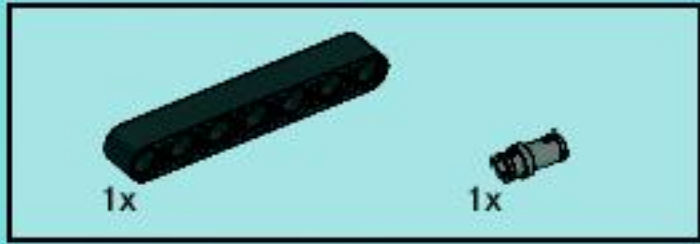
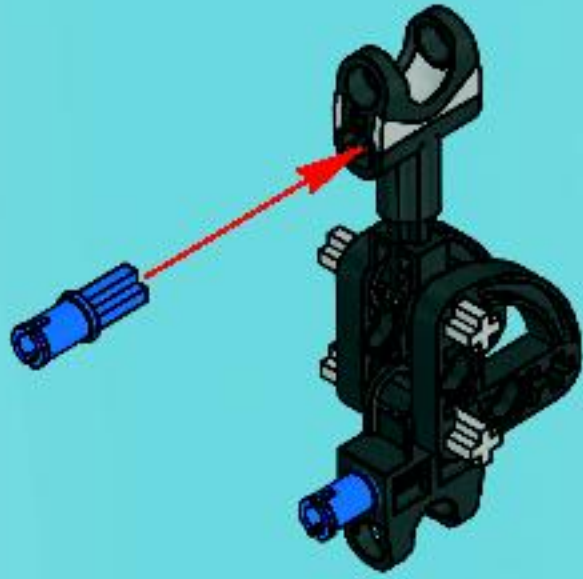

6

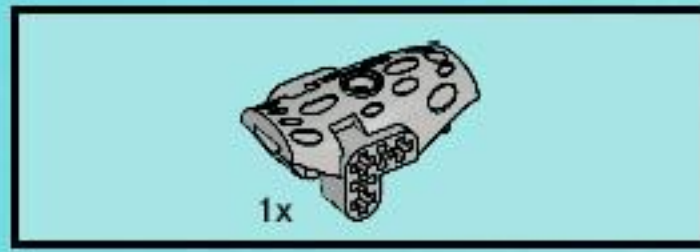

7

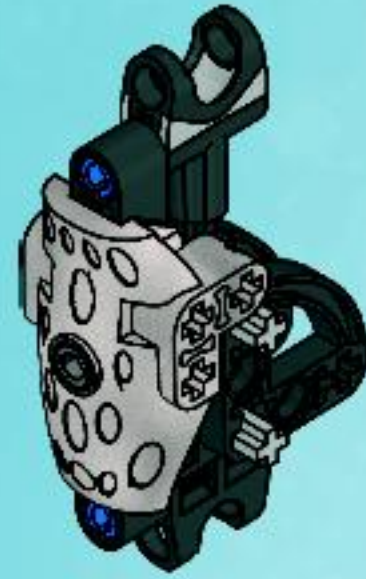



6

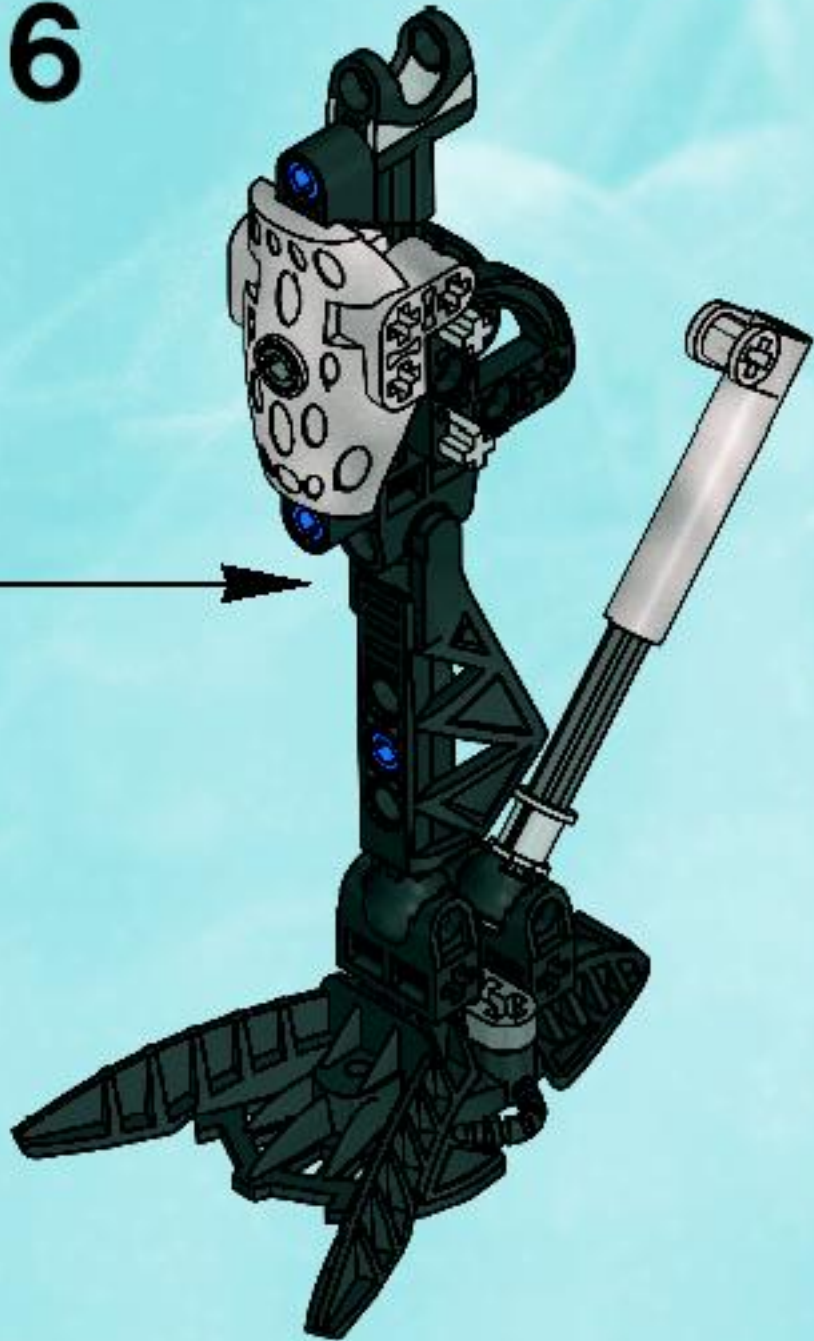

7

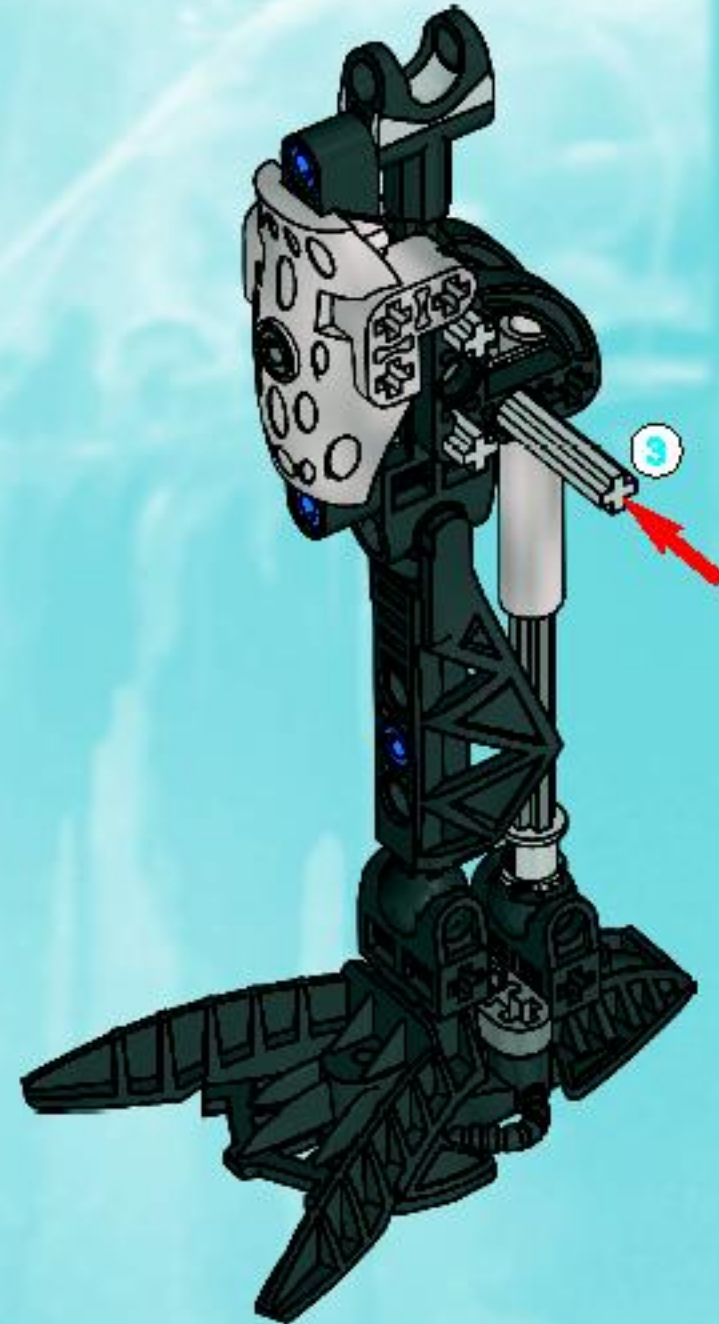

2x

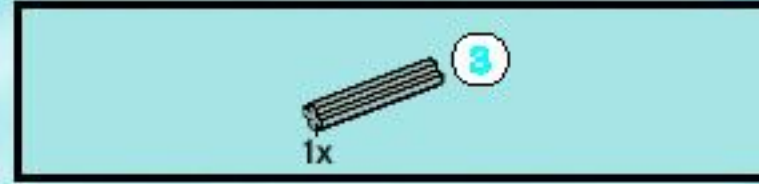



8

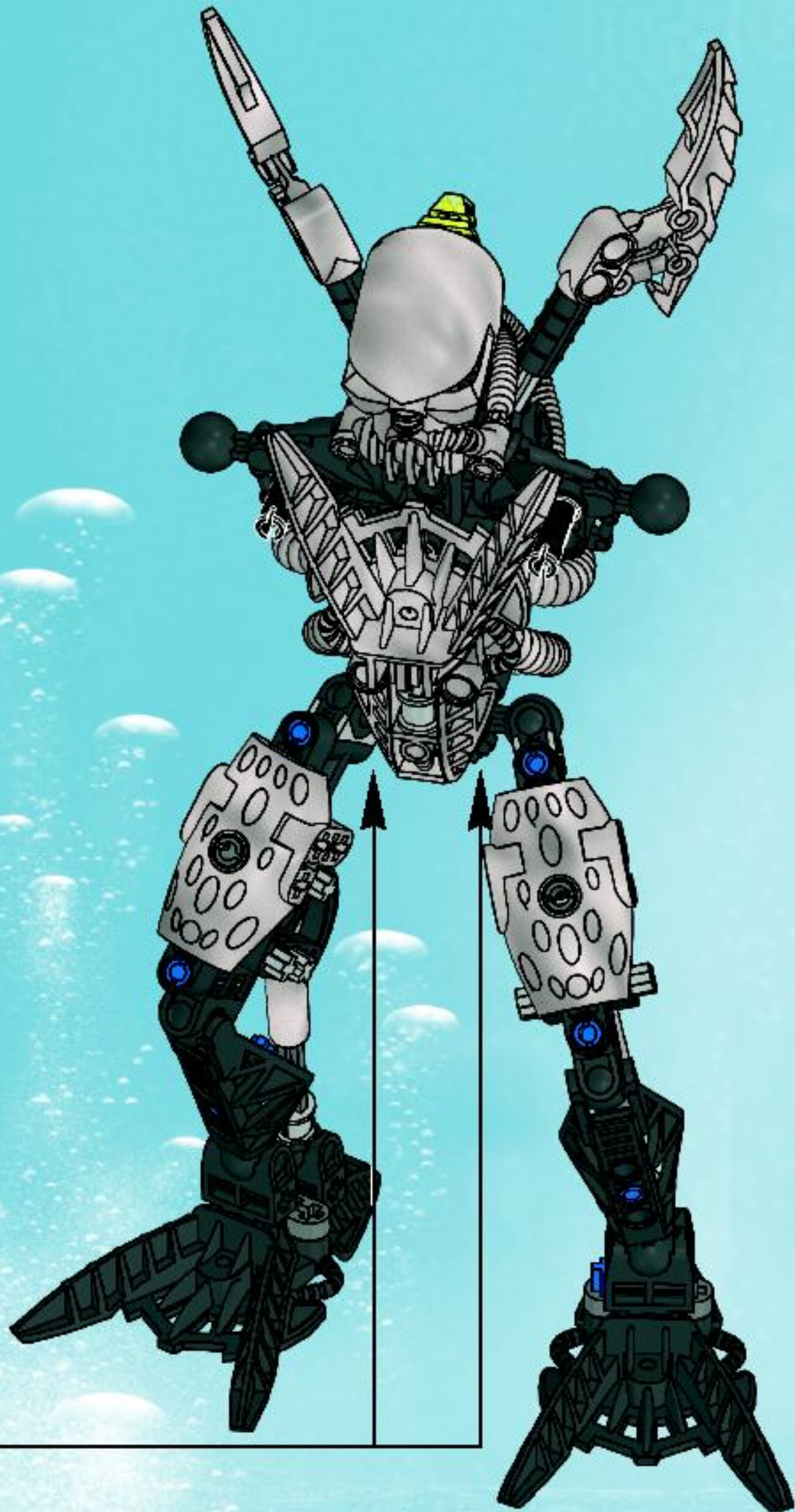



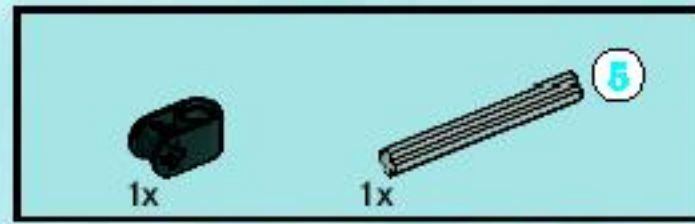
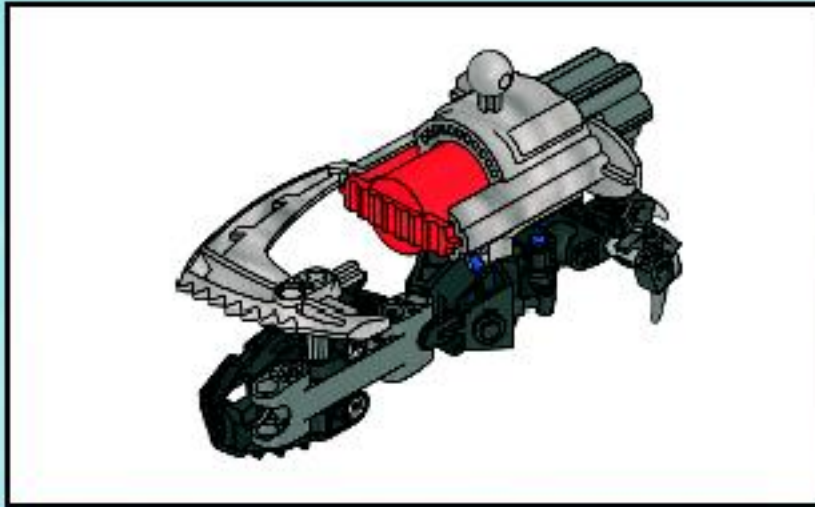
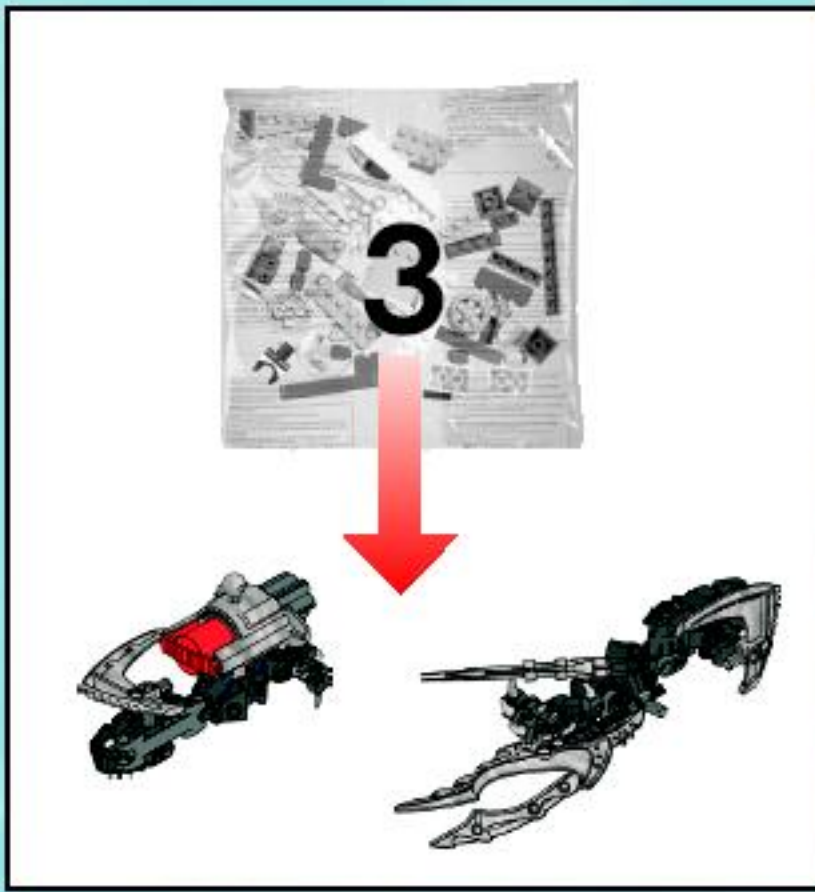

1

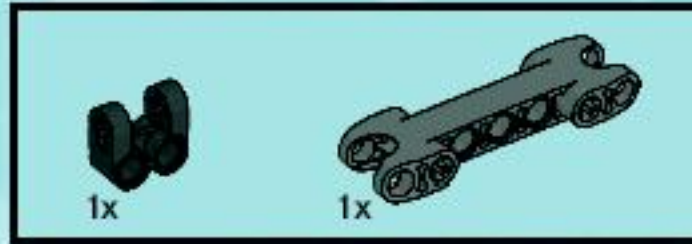
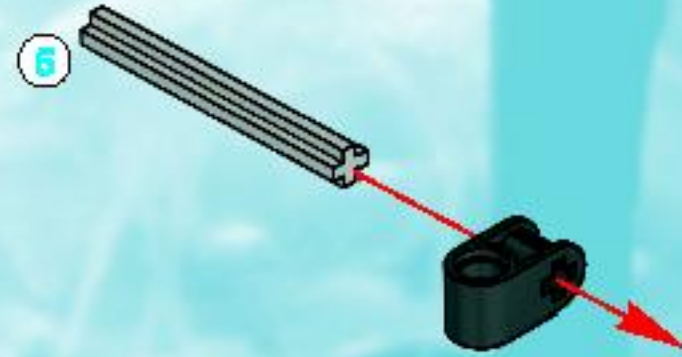

2

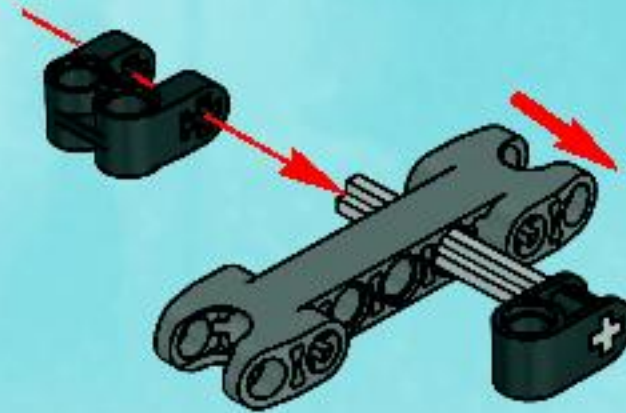





3

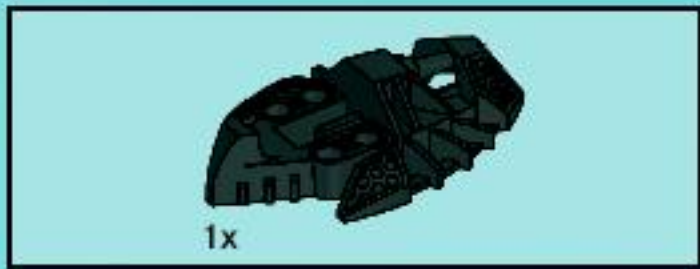
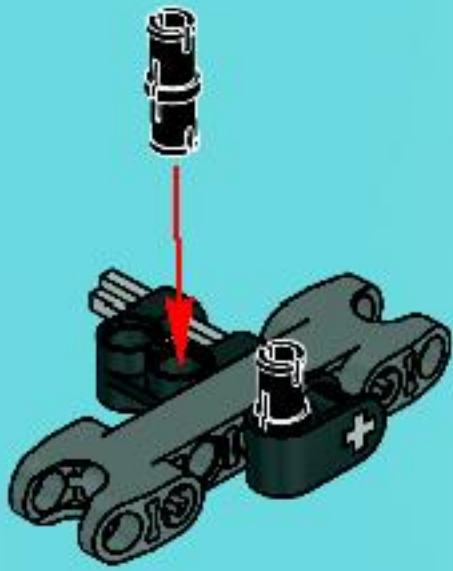

4

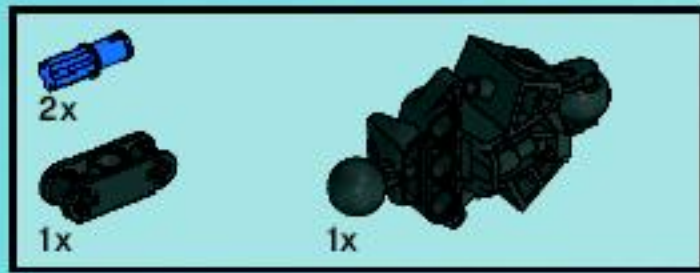

5

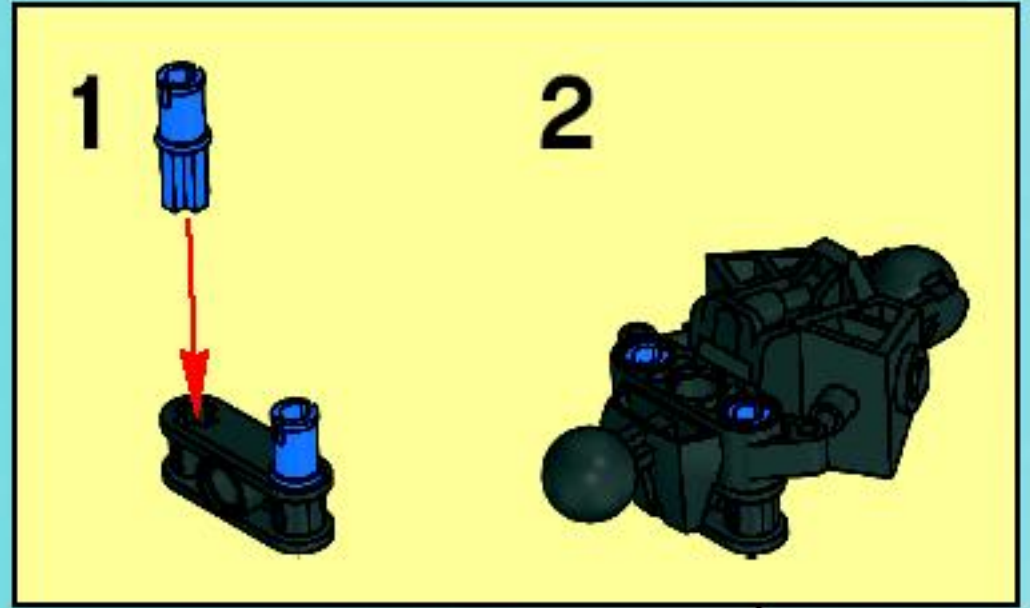





6

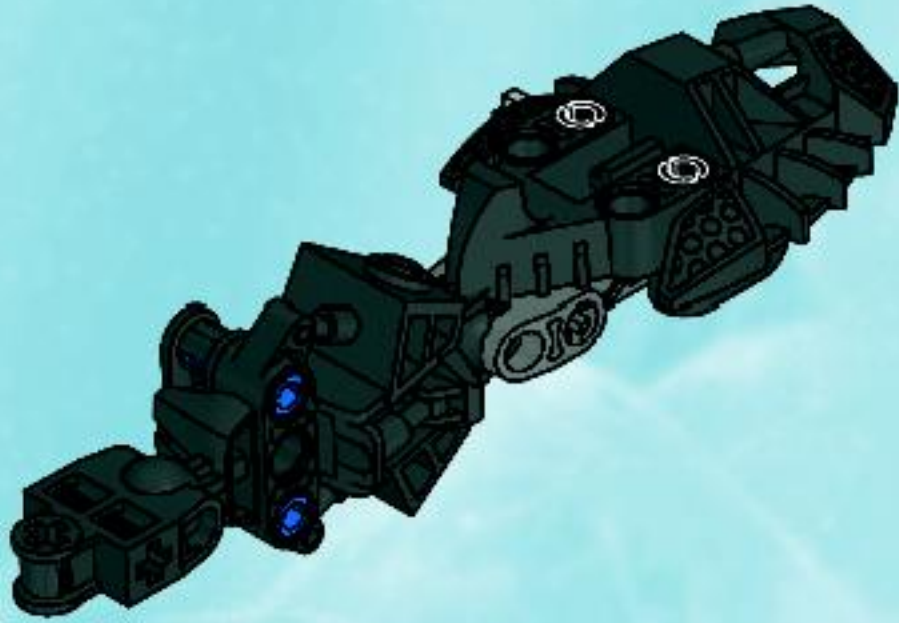

7

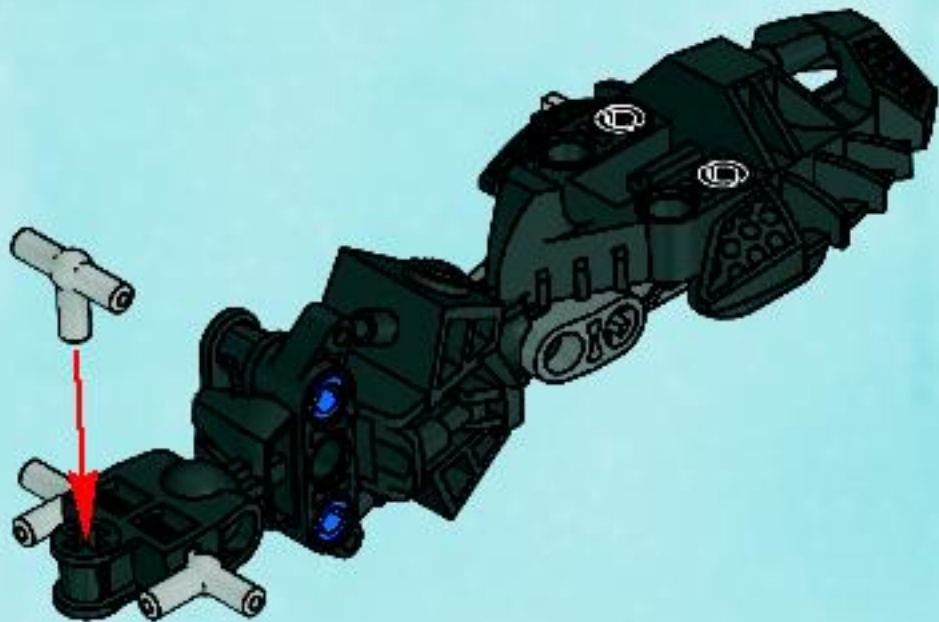

8

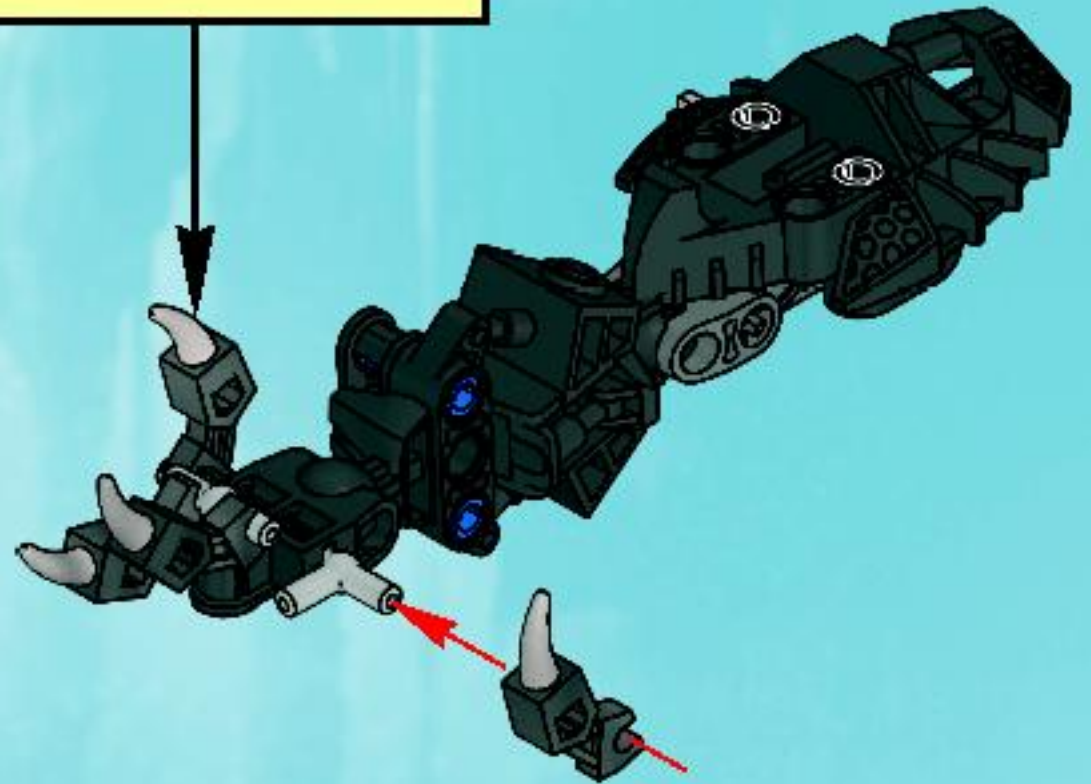
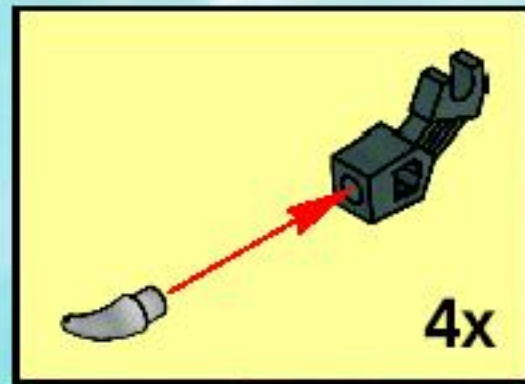



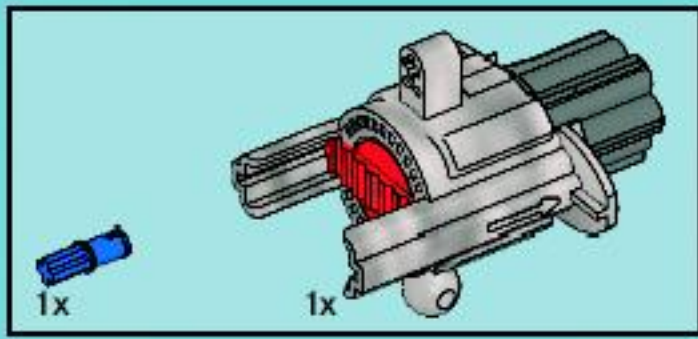

9

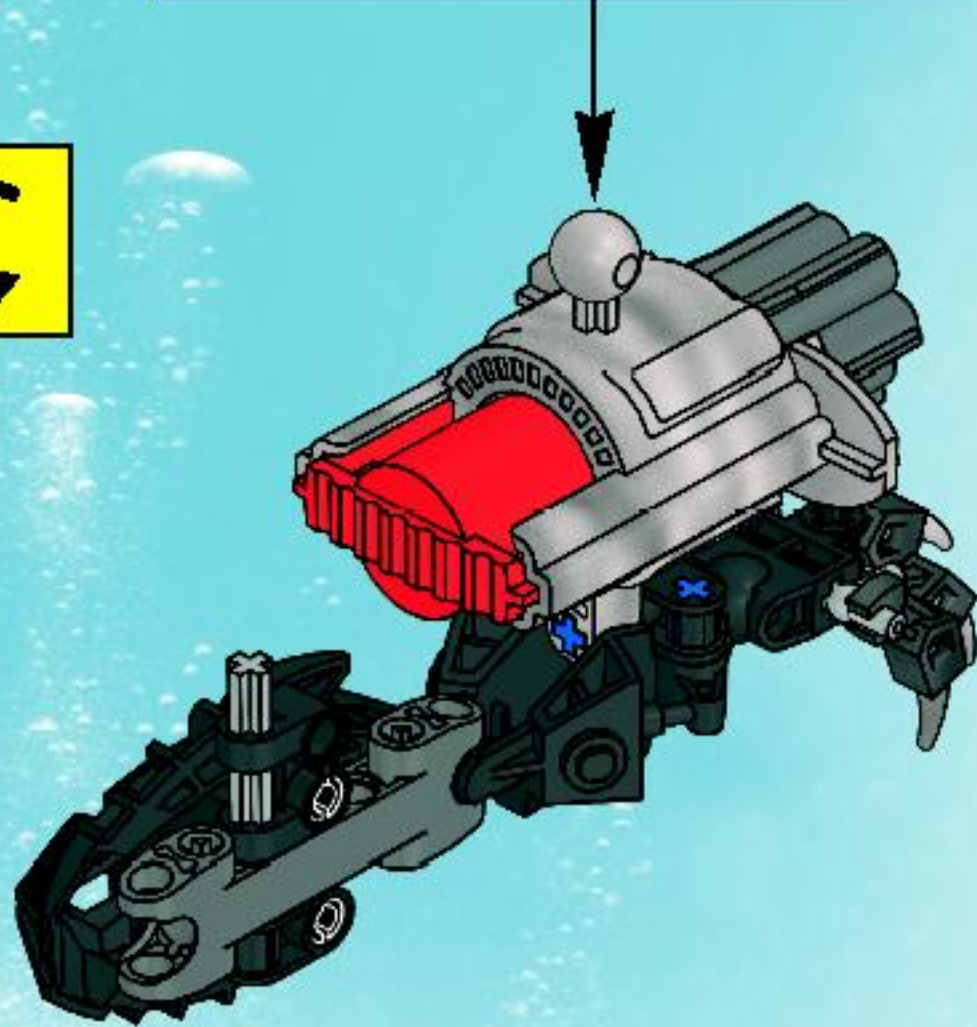
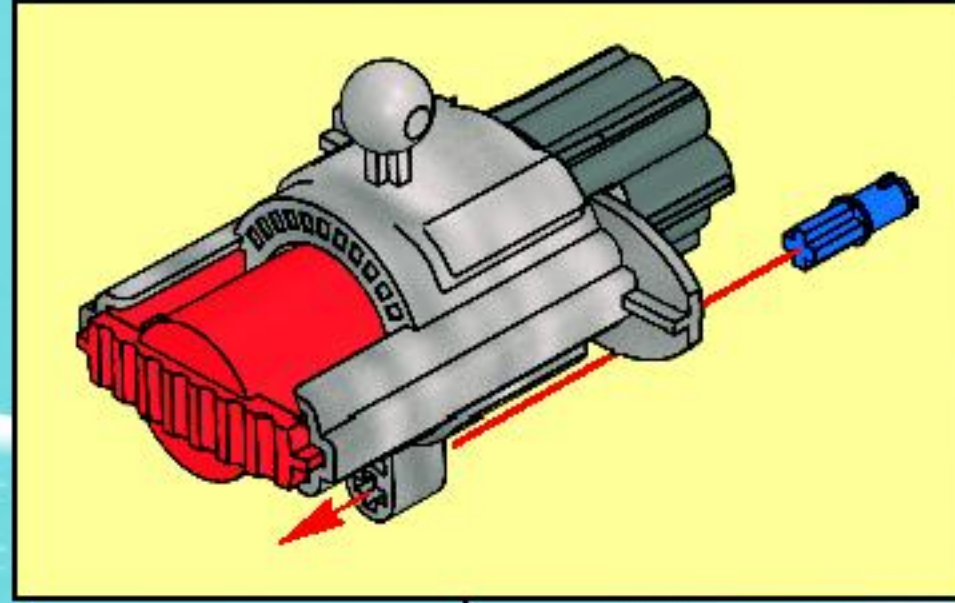



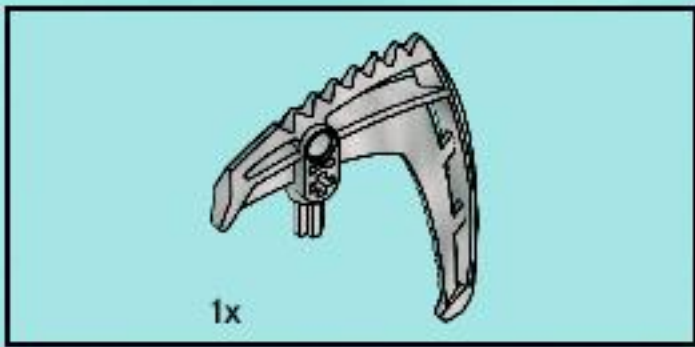

10

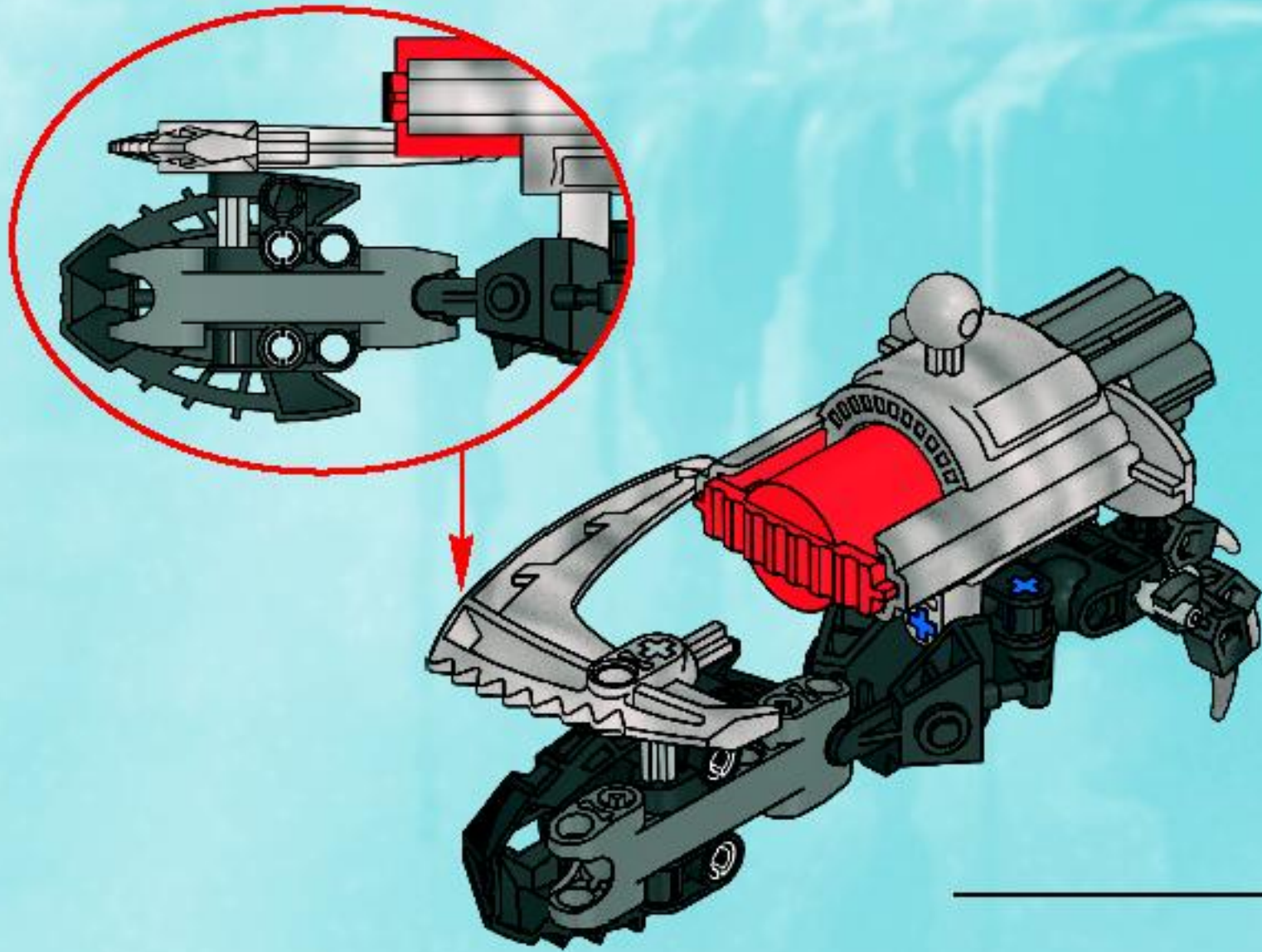



11

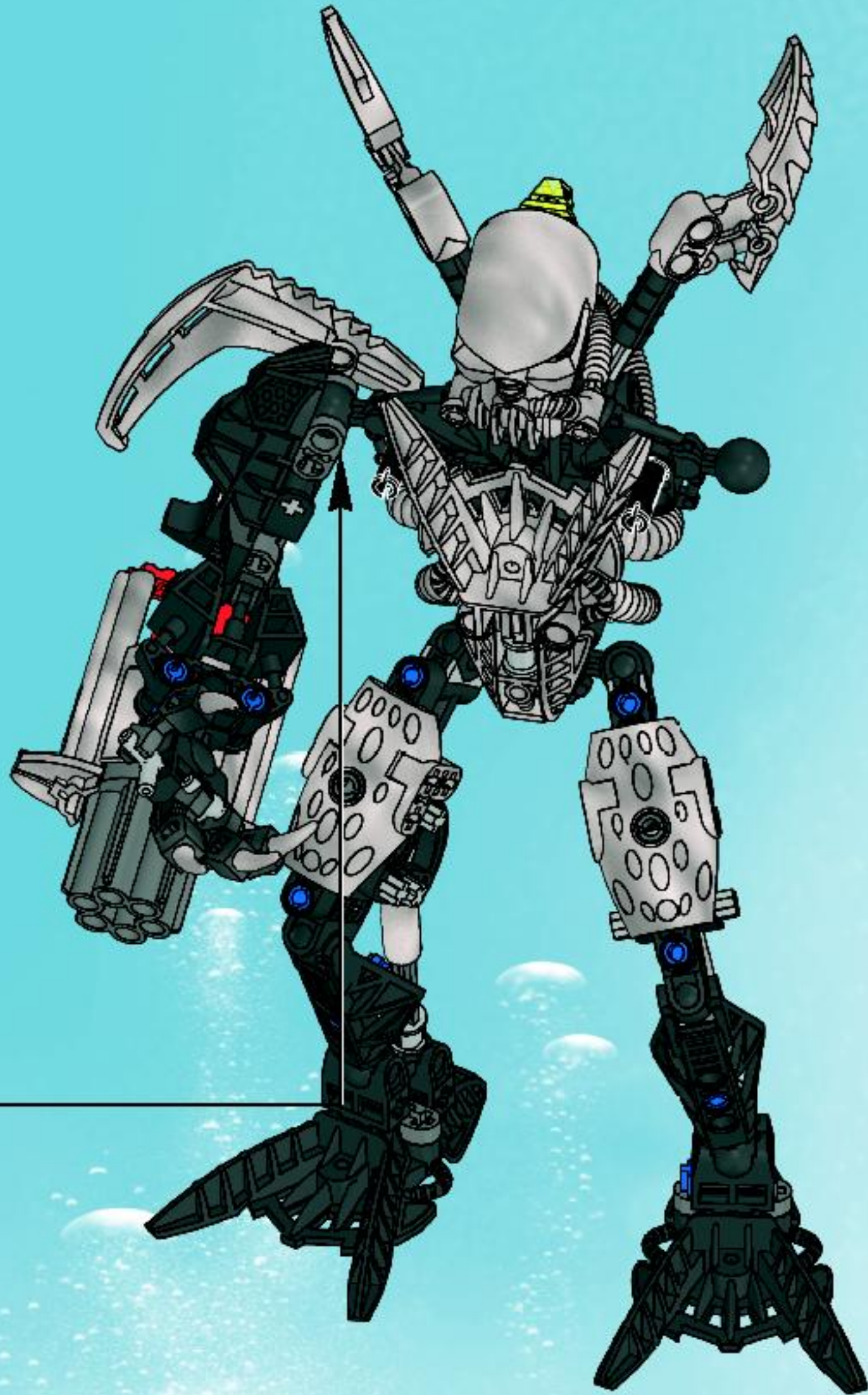



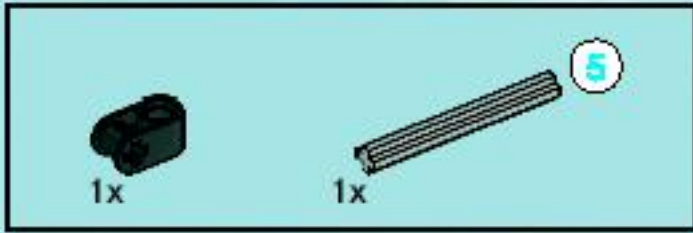
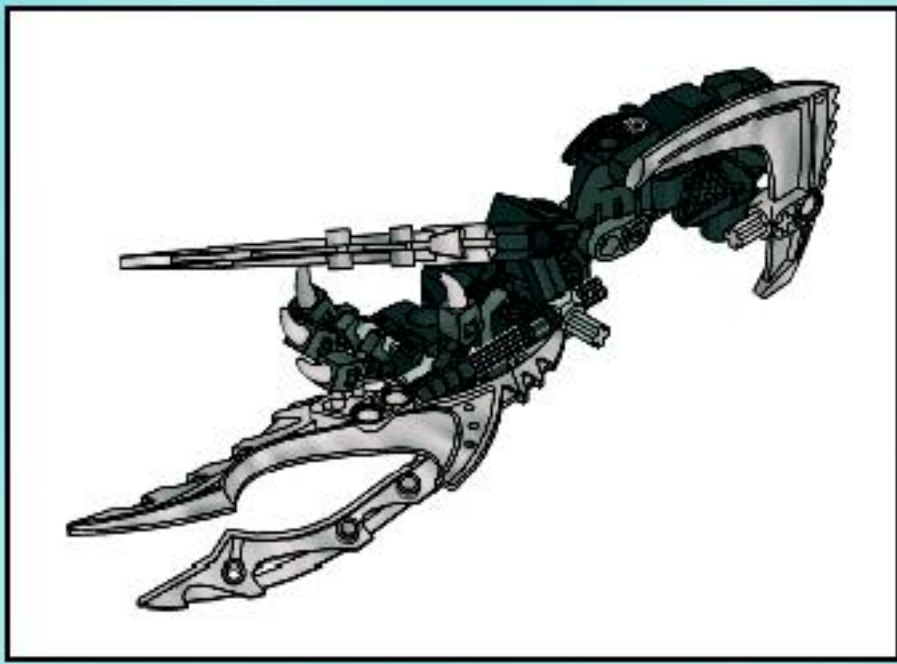

1

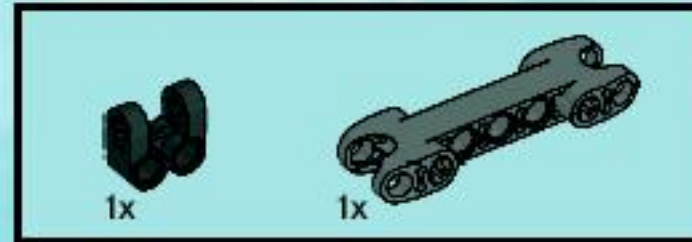
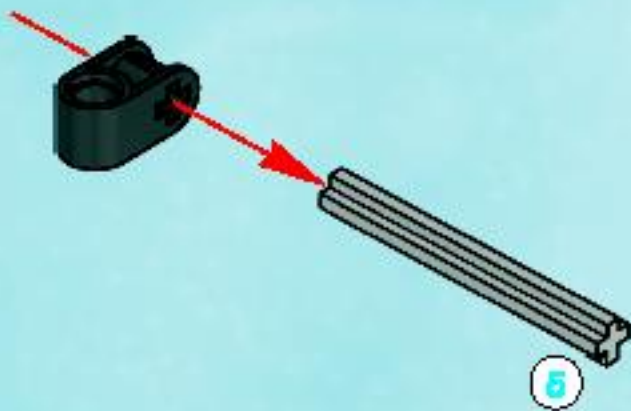

2

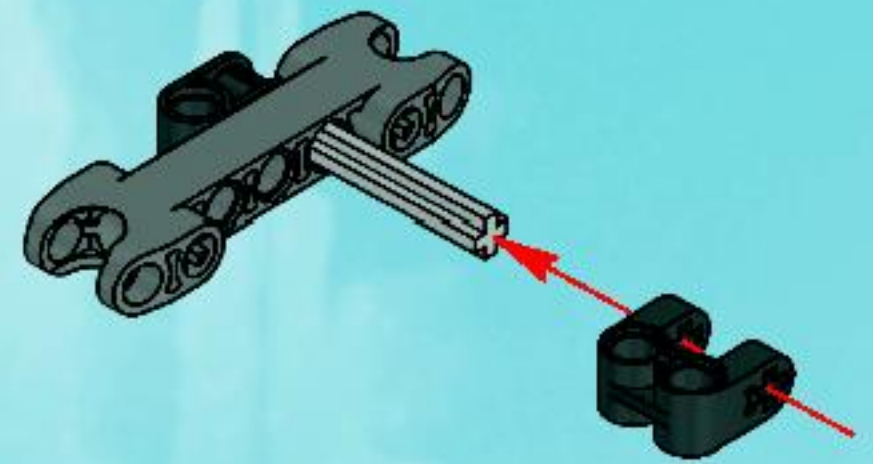





3

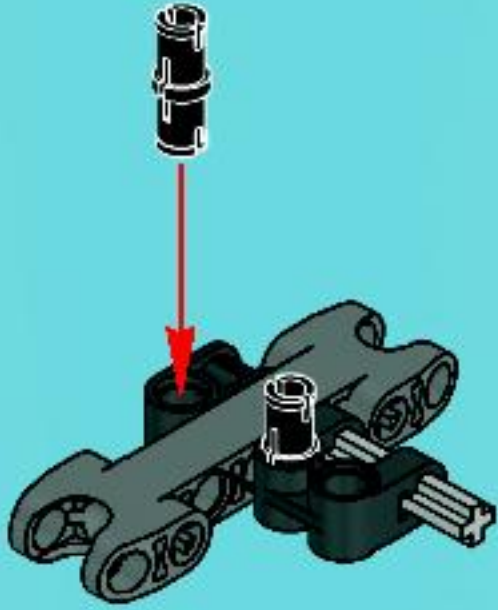

4



5

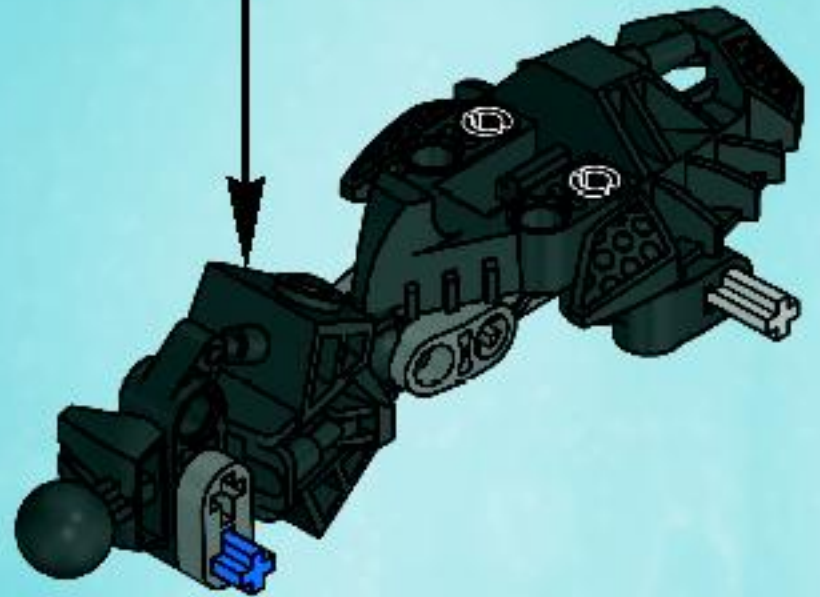
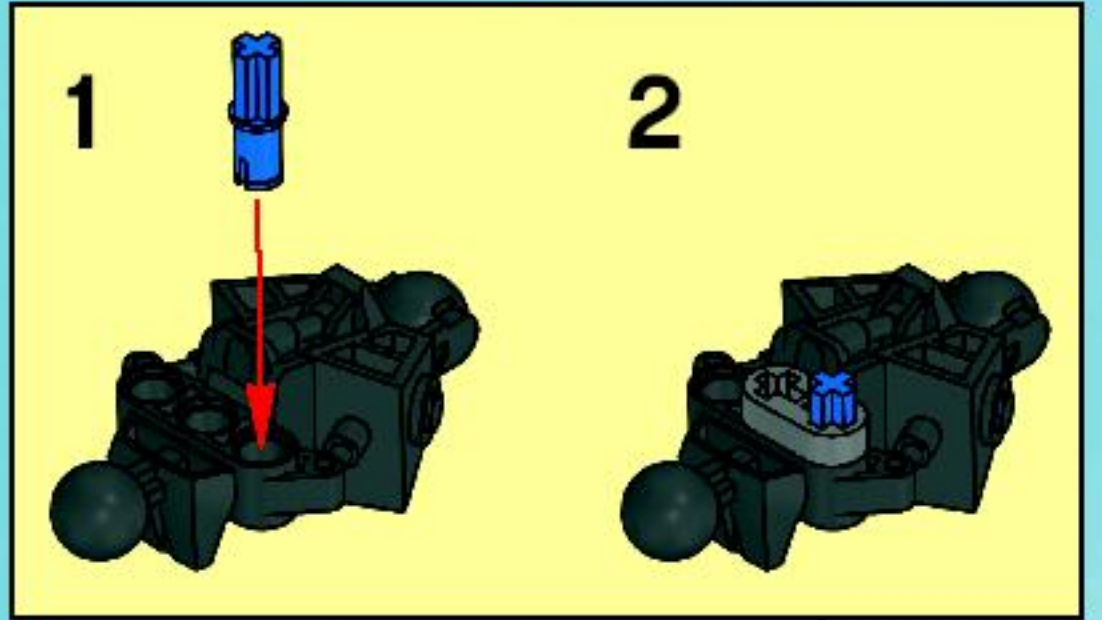





6

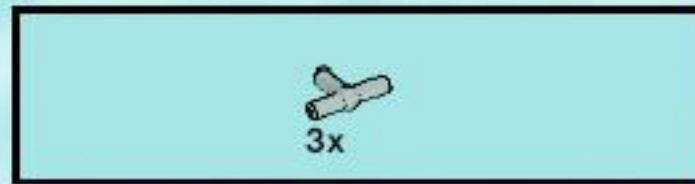
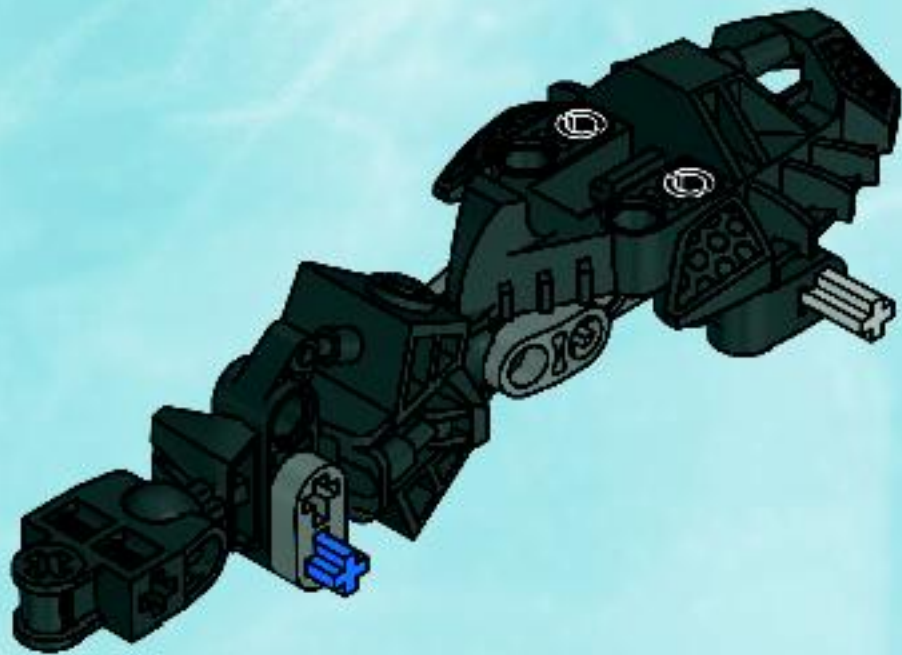

7

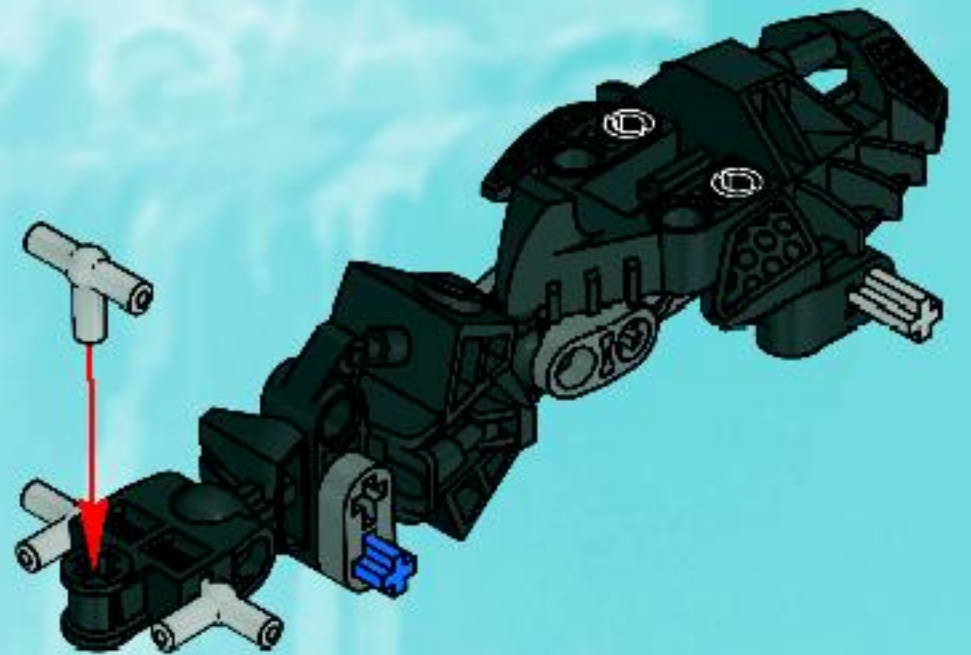





8

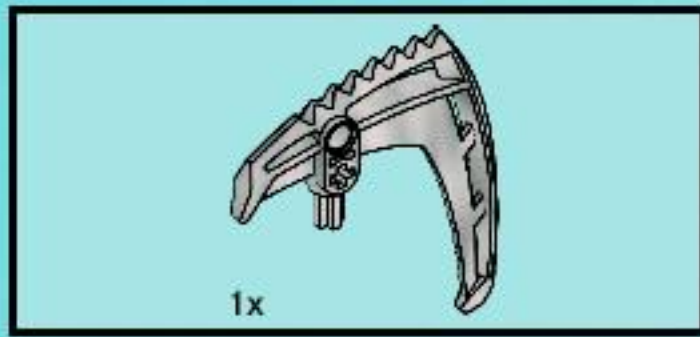
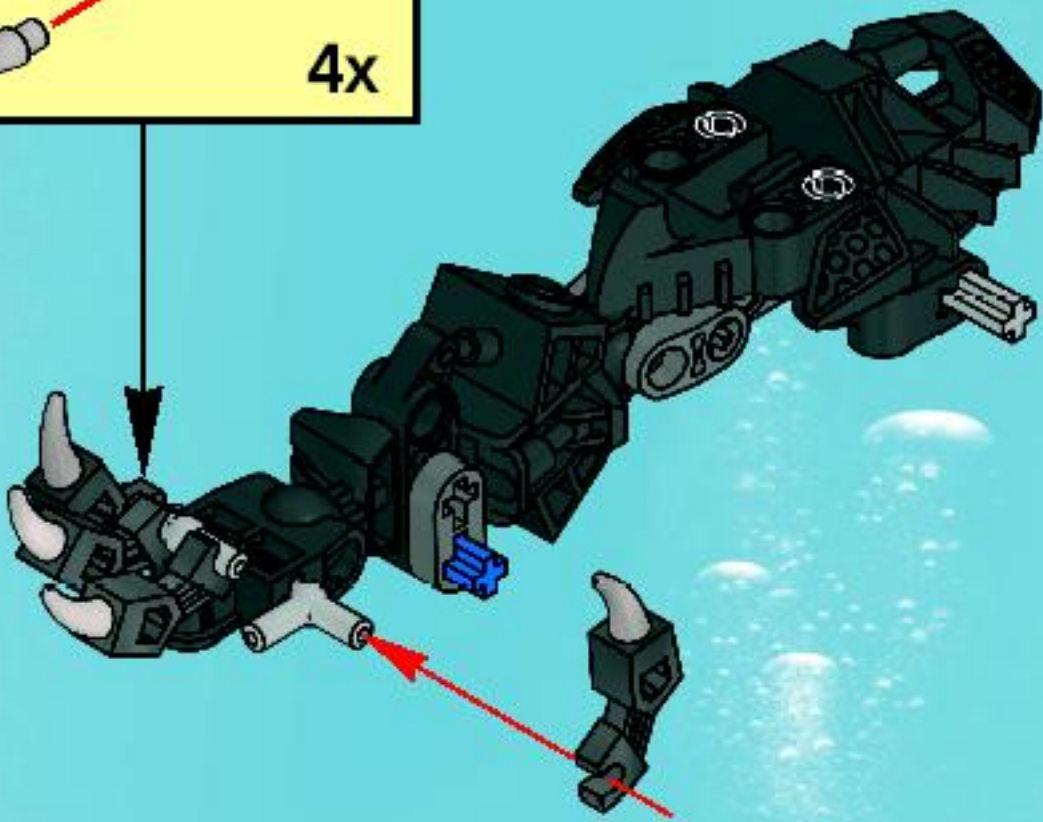
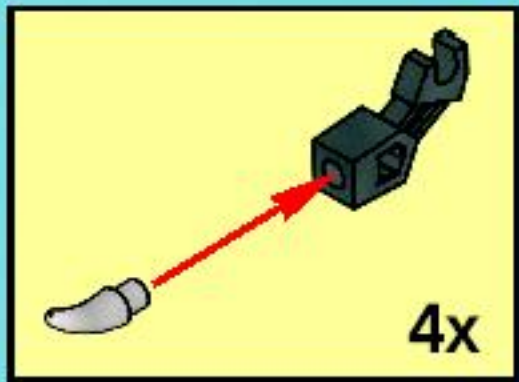

9

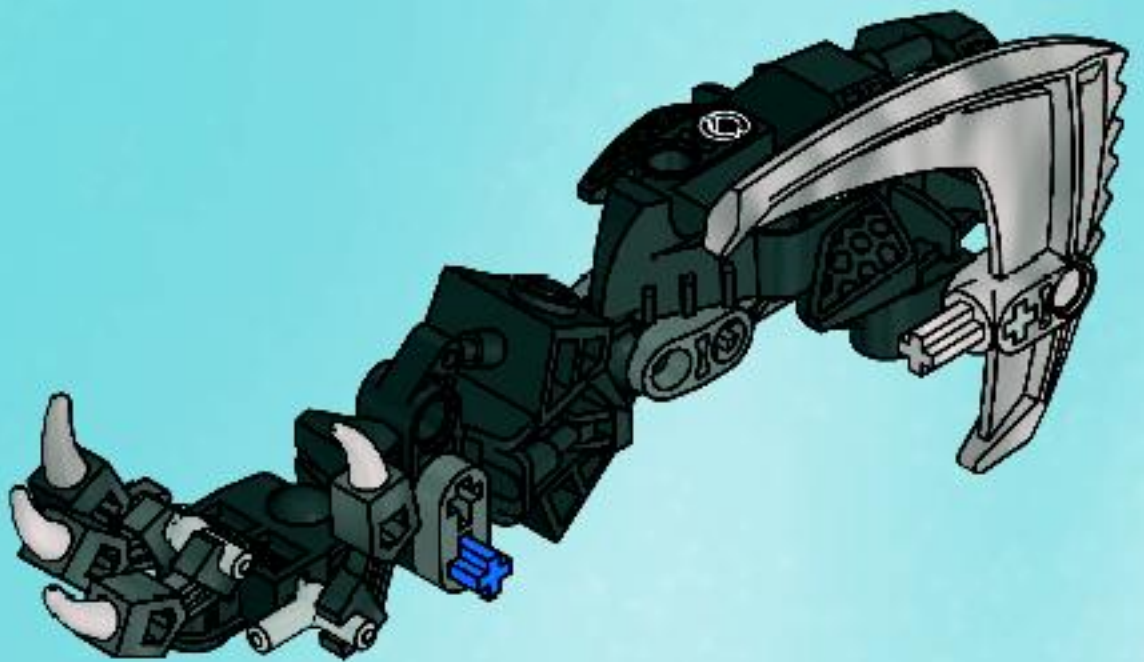



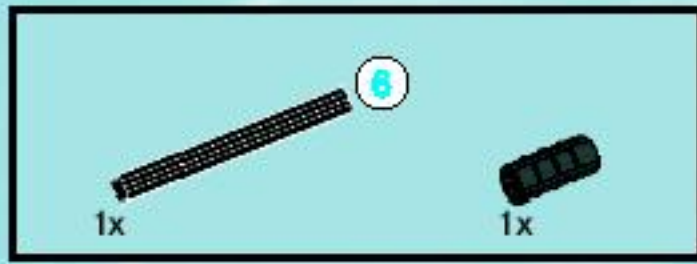
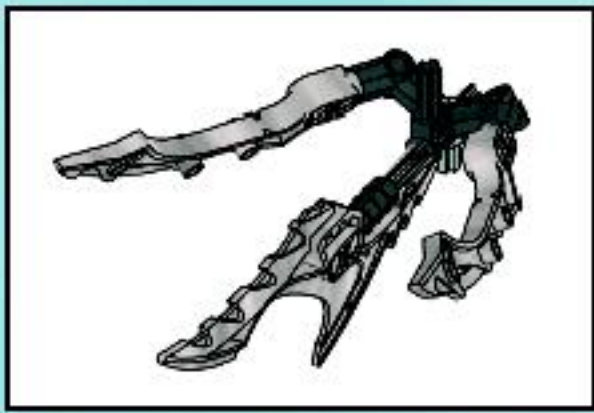

1



2

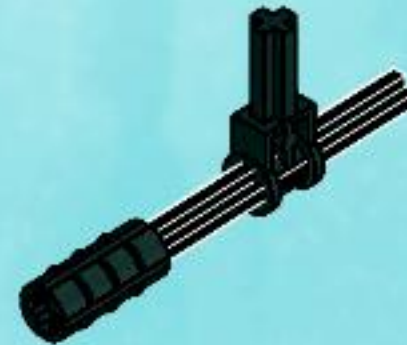





3

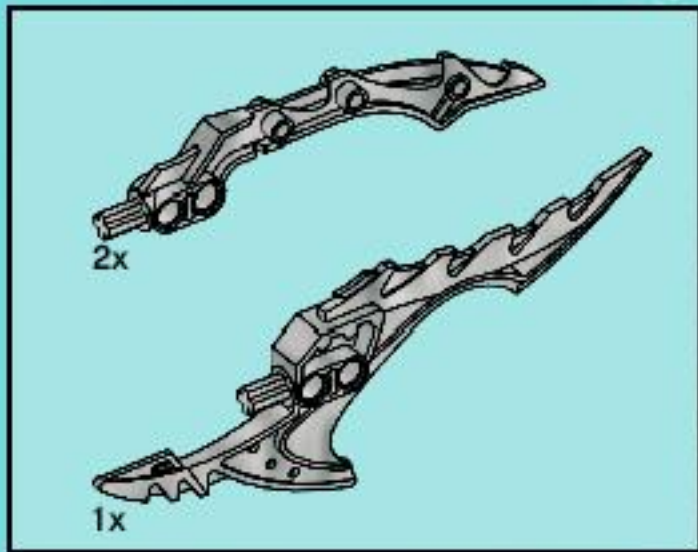
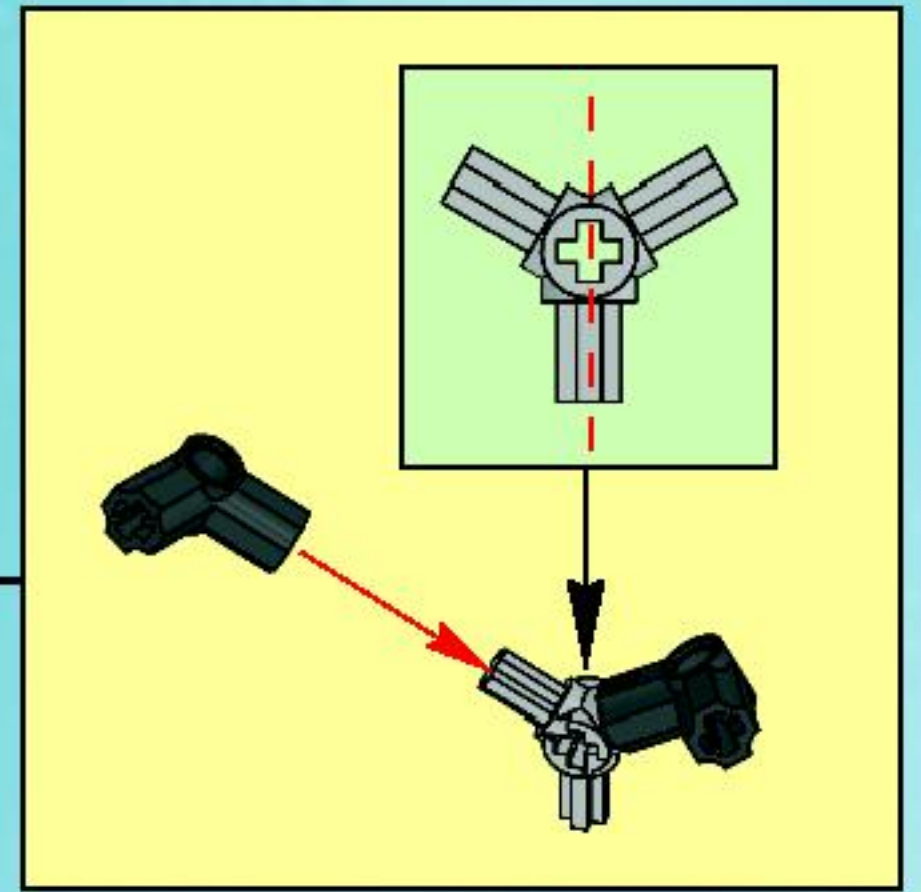

4

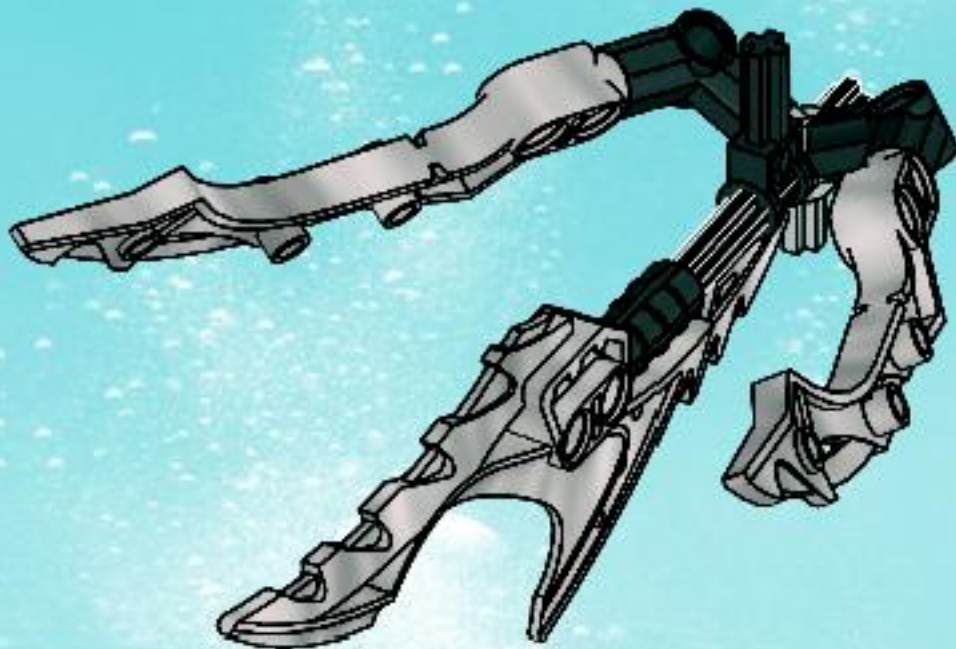

10

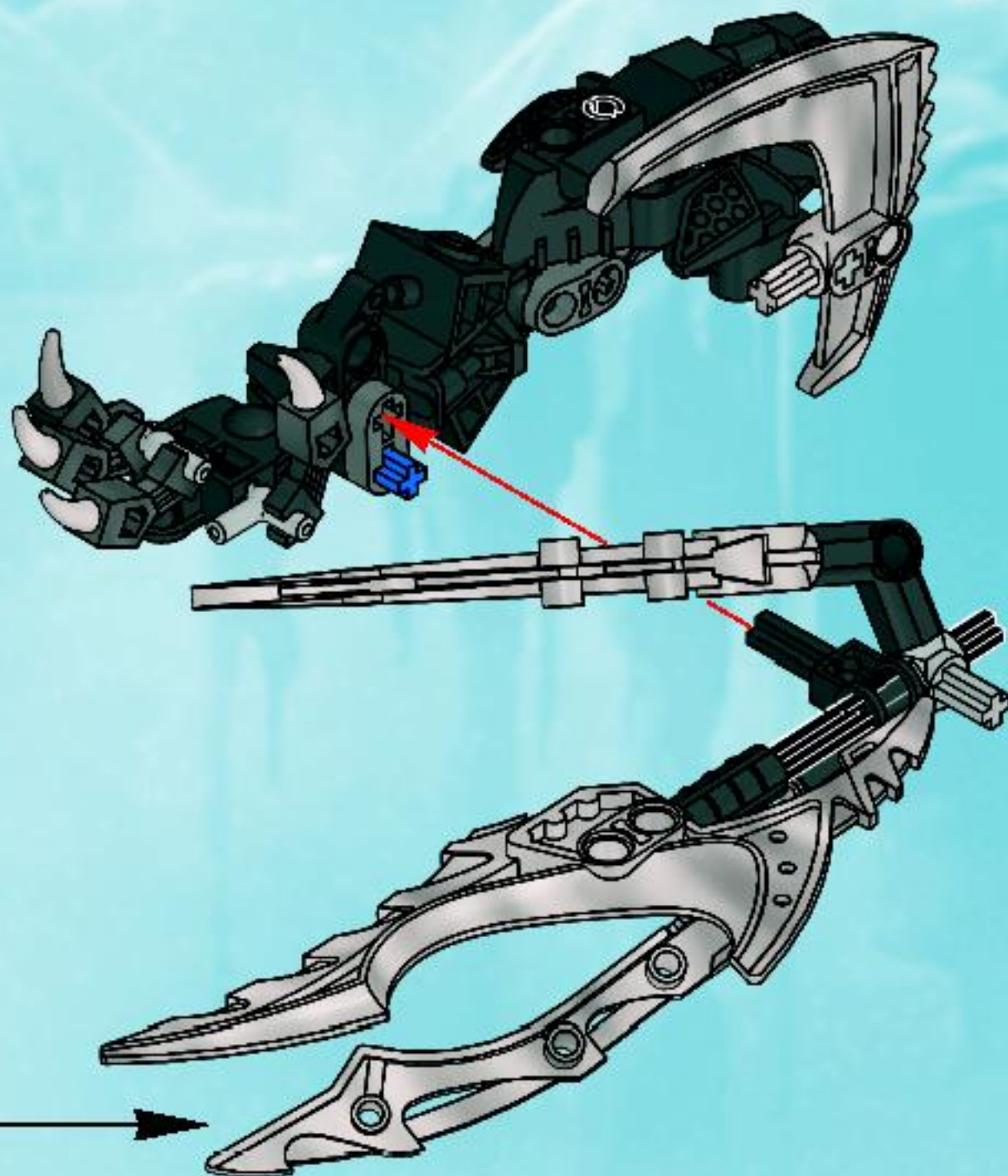



11

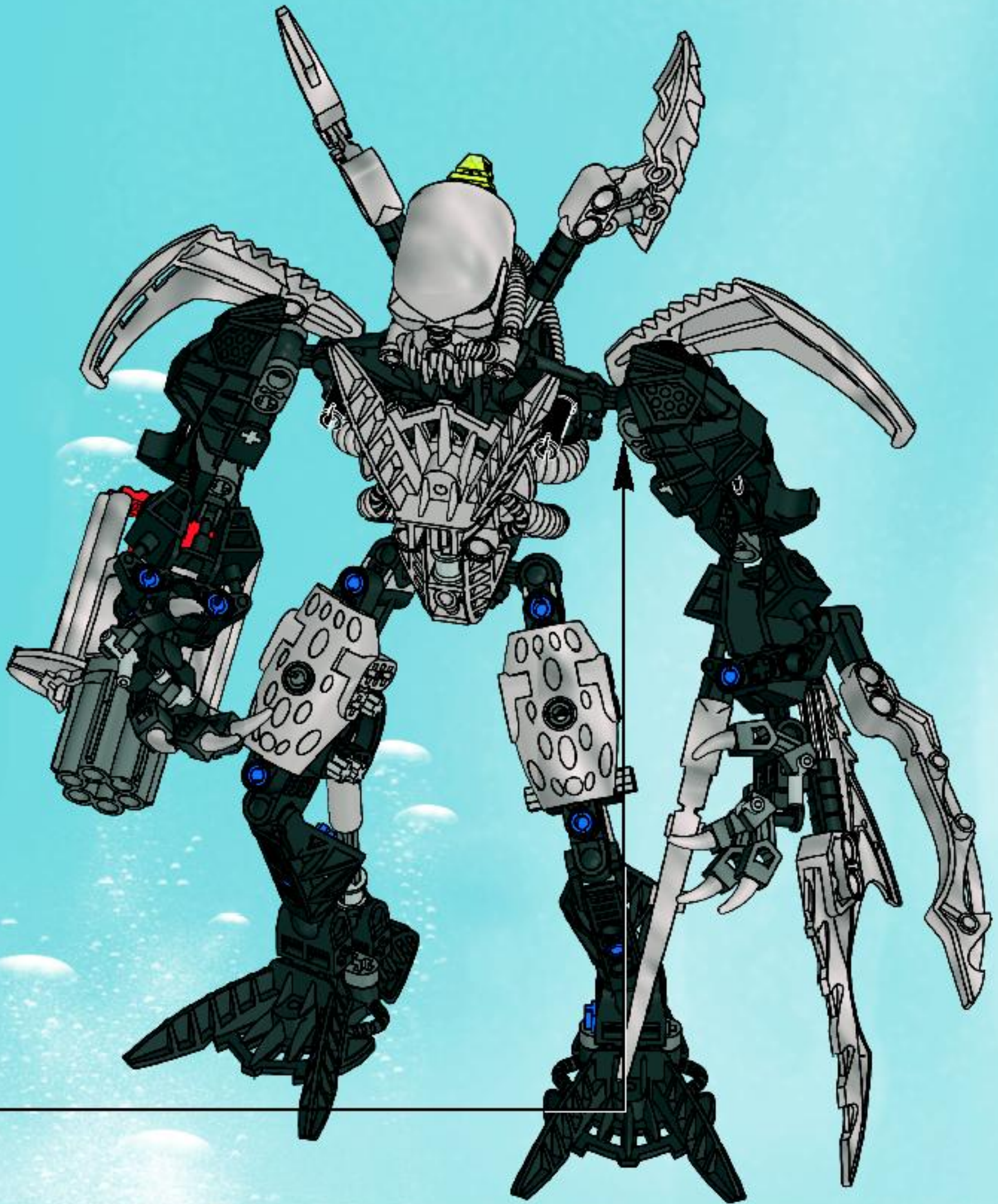





12

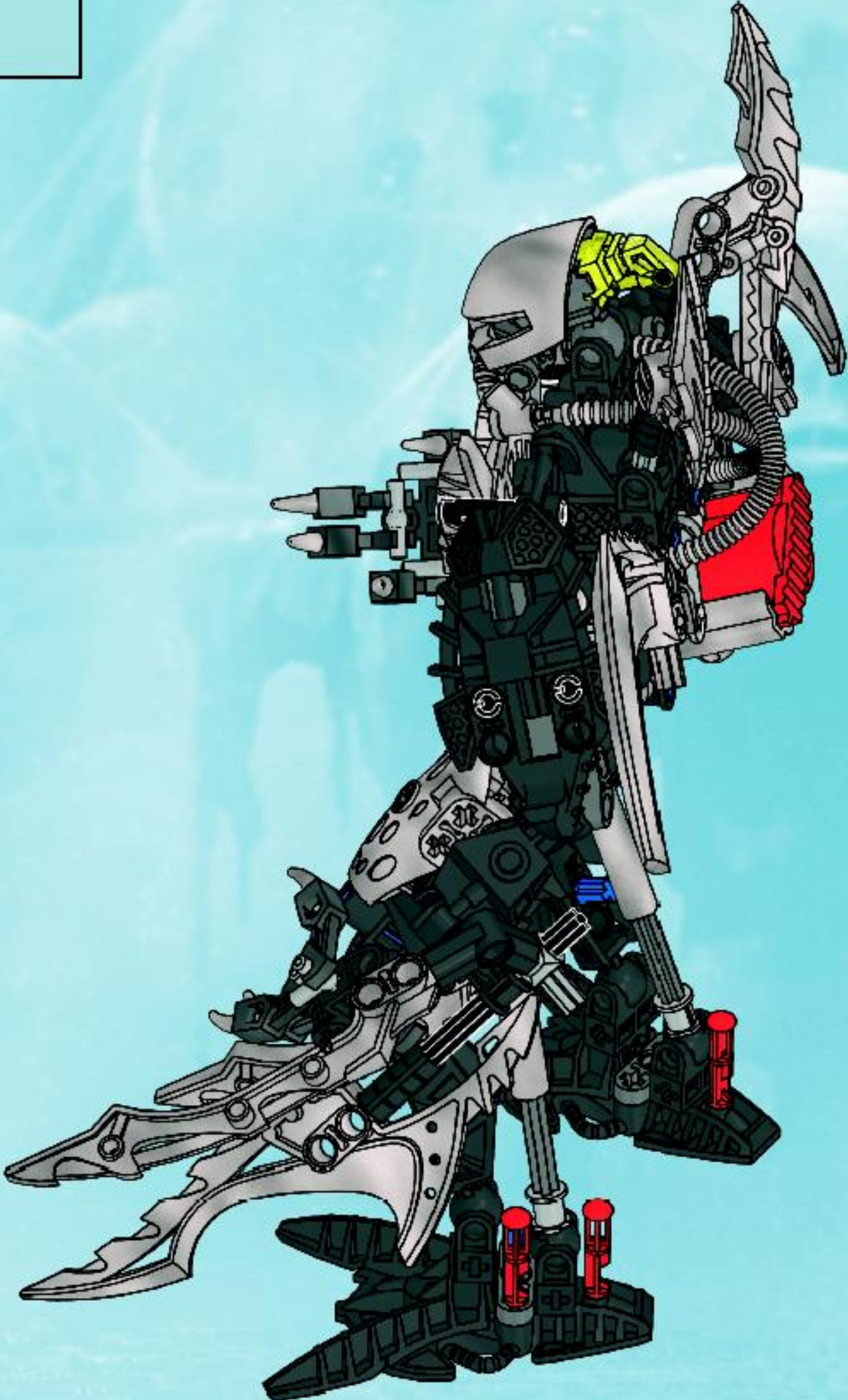





13

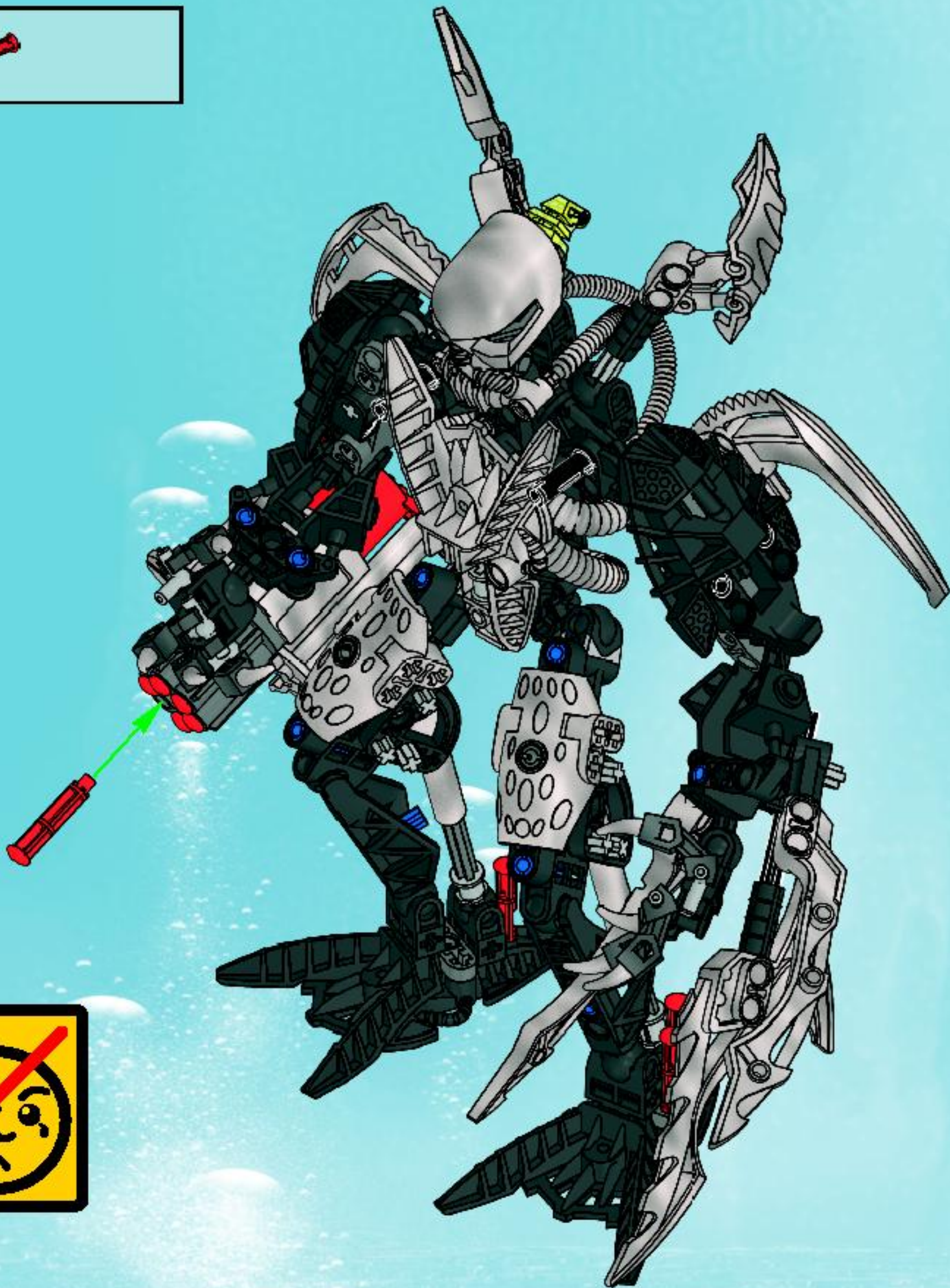



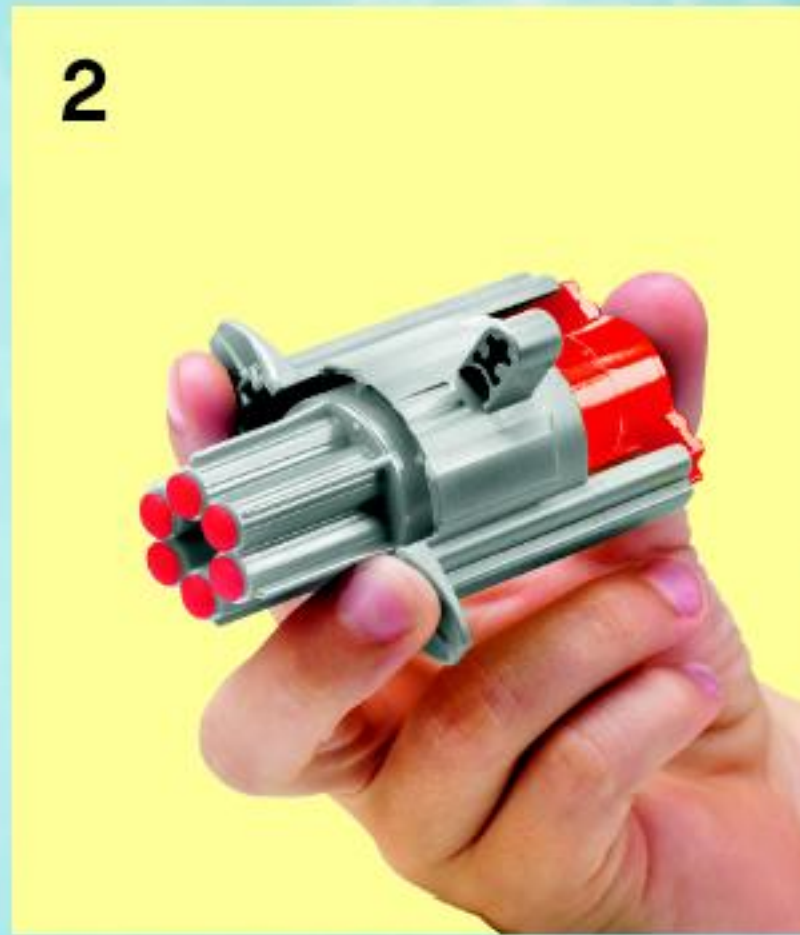
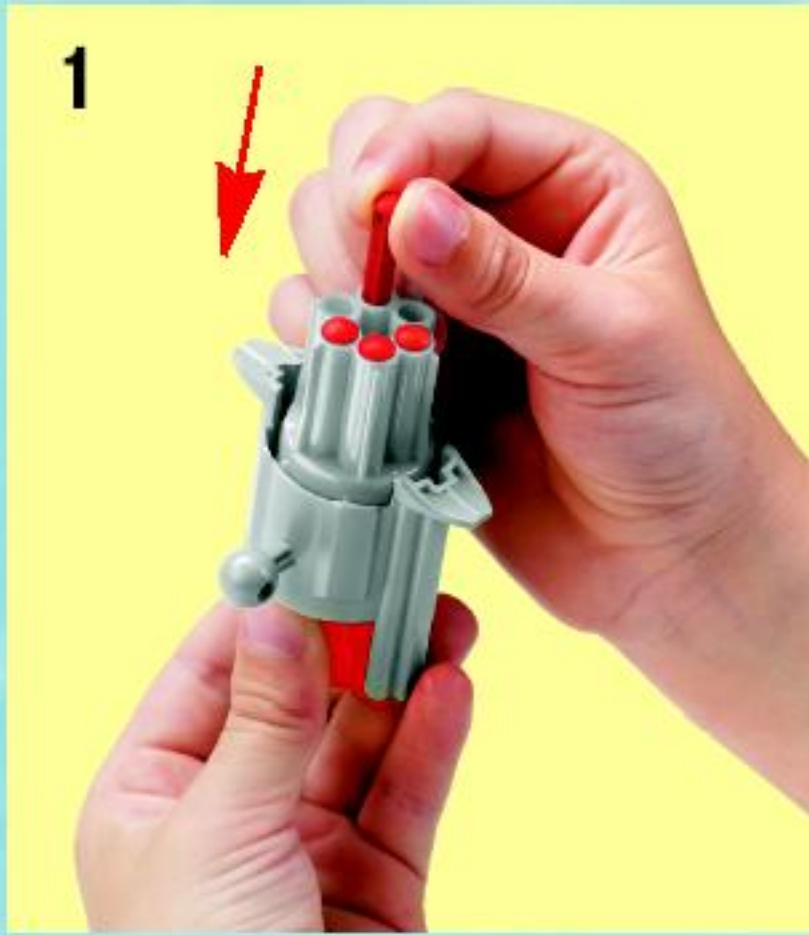





8x  
4294997



3x  
4142865



9x  
4497796



6x  
4121715



6x  
655826



1x  
370526



1x  
370626



3x  
4107765



3x  
4113805



2x  
4173668



2x  
4121667



1x  
4121610



2x  
4107084



4x  
4286267



4x  
4505842



11x  
4119328



2x  
4162857



1x  
4278585



2x  
4289376



1x  
4292590



2x  
4294582



2x  
4284574



2x  
4292528



2x  
4495935



1x  
4120017



2x  
4235786



1x  
4238920



1x  
4210980



2x  
4223767



2x  
4211050



2x  
4242036



2x  
4499858



1x  
4278473



19x  
4206482



1x  
4502595



2x  
4211622



1x  
4211553



2x  
4211483



8x  
4211815



2x  
4211639



1x  
4211779



6x  
4211508



1x  
4495414



8x  
4494086



4x  
4495203



2x  
4494486

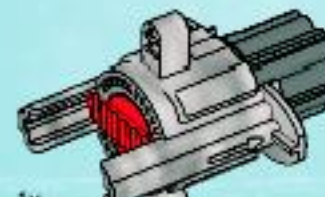

1x  
4504505



1x  
4506662



1x  
4506530



2x  
4505846



1x  
4276534



2x  
4497138



2x  
4504538



2x  
4504970



2x  
4506460







8922  
Gadunka

8923  
Hydraxon

8924  
Maxilos & Spinax



# MAHRI

8915  
Toa Matoro



8911  
Toa Jaller



8913  
Toa Nuparu



8910  
Toa Kongu



8914  
Toa Hahli



8912  
Toa Hewkii





**8927**  
Toa Terrain Crawler



**8926**  
Toa Undersea Attack



**8925**  
Barraki Deepsea Patrol



# Win! Gagne! 当たります Gewinne!

## Win LEGO products

We would like to know what you think about your new LEGO product. Log on to the web address below for further instructions.

## Gagne des produits LEGO

Nous aimerions savoir ce que tu penses de ton nouveau produit LEGO. Tu obtiendras davantage d'informations en visitant le site Internet indique ci-dessous.

## Gewinne LEGO produkte

Wir sind sehr an deiner Meinung über dein neues LEGO Produkt interessiert. Gehe einfach zu der unten angegebenen Webadresse – dort findest du weitere Informationen.

## Estimado usuario LEGO

Al contestar algunas preguntas en inglés, francés, alemán o japonés, en el sitio [www.acnielsen.aim.dk/lego](http://www.acnielsen.aim.dk/lego), podrás participar en el sorteo de algunos valiosos premios LEGO.

## Caro Consumidor da LEGO

Ao responder a algumas perguntas em Inglês, Francês, Alemão ou Japonês no endereço [www.acnielsen.aim.dk/lego](http://www.acnielsen.aim.dk/lego) irá participar num concurso para ganhar valiosos prémios da LEGO.

## Kedves ifjú LEGO Vásárló

Ha ellátogatsz a [www.acnielsen.aim.dk/lego](http://www.acnielsen.aim.dk/lego) honlapra és ott angol, francia, német vagy japán nyelven megválaszolsz néhány kérdést, akkor részt veszel egy versenyben, amelyben értékes LEGO díjakat nyerhetsz.

## 抽選でレゴの製品が当たります

私たちは、皆さんがお買い求めのレゴの製品についてどんな感想をお持ちか、知りたいと思っています。質問に答えて、楽しいレゴ製品の抽選に応募しませんか。アンケートの回答には、ほんの3分ほどしかかかりません！詳しくは、以下のウェブアドレスまでアクセスしてください。

[www.acnielsen.aim.dk/LEGO](http://www.acnielsen.aim.dk/LEGO)



Any questions regarding your new LEGO product, please contact:

**Customer Service | Kundenservice**

**Service Consommateurs | Servicio Al Consumidor**

**at [www.lego.com/service](http://www.lego.com/service) or dial**

 : 00800 5346 5555

 : 1-800-422-5346





# club™

FREE LEGO Magazine • GRATUIT • GRATIS LEGO Magazin



## Join Today!

## Abonne-toi dès aujourd'hui !

## Meld je nu aan!

## Jetzt anmelden!

  US & Canada only

1-866-534-6258 / 1-877-518-5346

(en Français)

00800 5346 5555      

# www.LEGOclub.com



VISIT THE  
WORLD'S BIGGEST  
LEGO® SHOP!  
[www.LEGOshop.com](http://www.LEGOshop.com)





## BIONICLE

STORY

PRODUCTS

FUN ZONE

KANOKA CLUB

+ MESSAGE

## BARRAKI

PLAY MOVIE

## BARRAKI LOG

Among the most dangerous creatures in these waters are Taka sharks, giant squid, and venomous...



### NEW PRODUCTS

Merciless and armed to the fangs with Squid ammo, the Barraki know what they want and stop at nothing to get it! Join in the quest for the Mask with all the new characters.

### NEW GAME



Escape the vile creatures prowling in the seaweed in this hostile trench of darkness.

### GALLERY



What else may be lurking beneath the surface? See what other BIONICLE fans have created and let us see your next creation!



Introducing BIONICLEStory.com  
New Kanoka Club website!  
New Products: Barraki

