

BIONICLE®

SKRALL

8978

GLATORIAN

LEGO



1

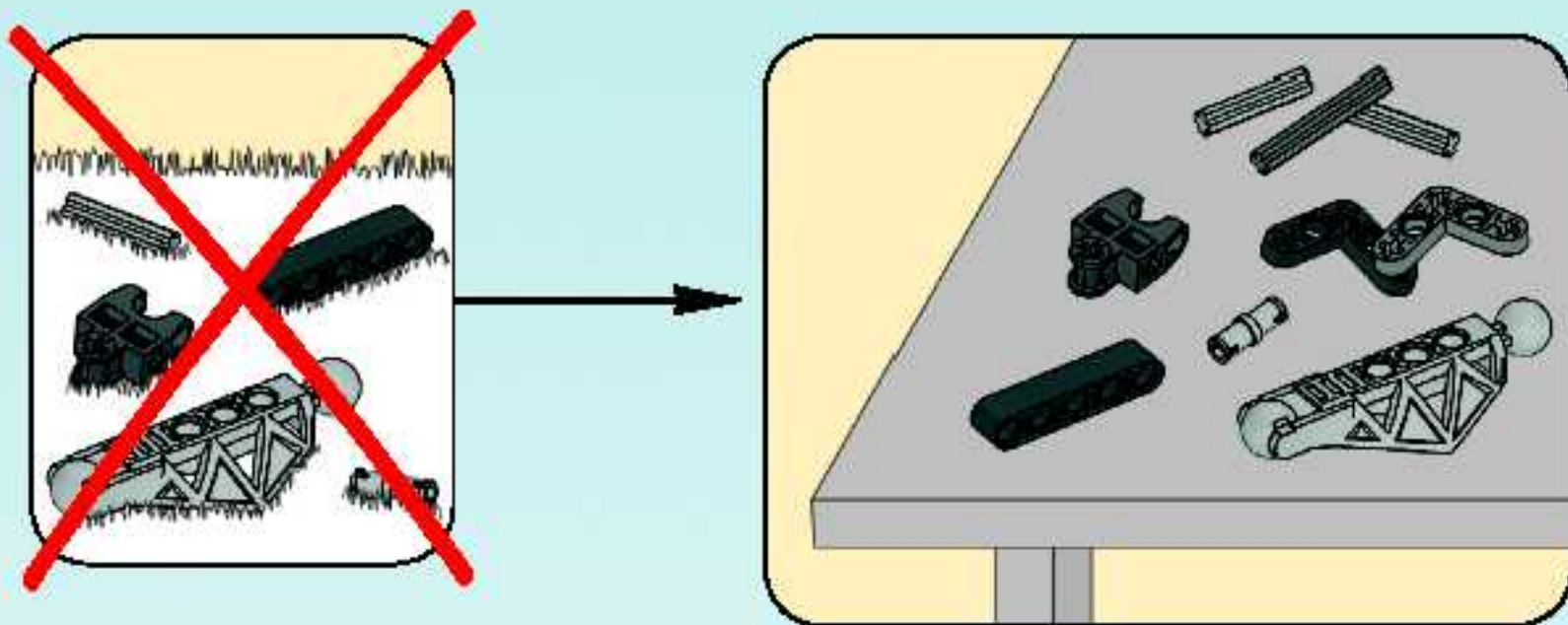

2

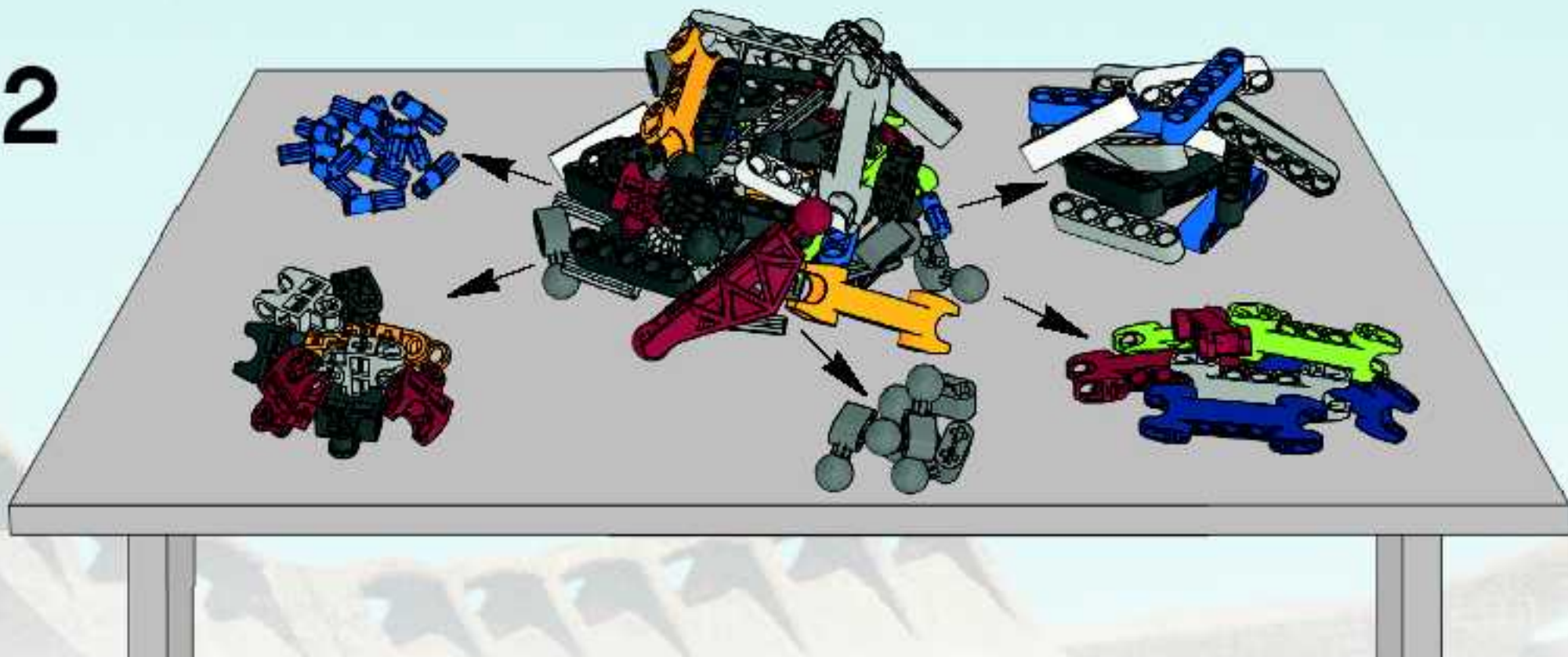

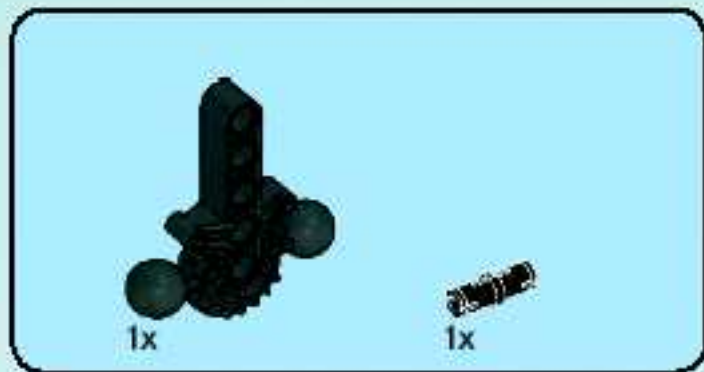

1

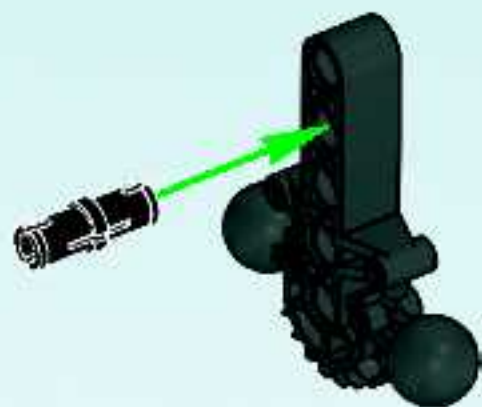

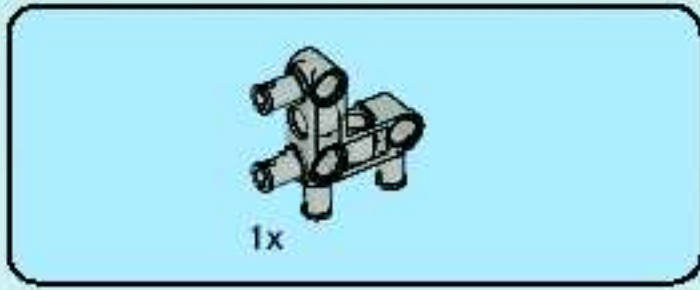

2

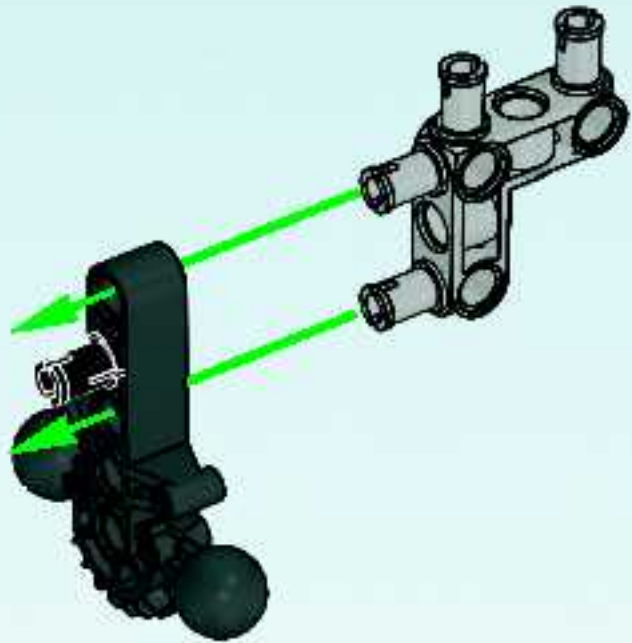

3

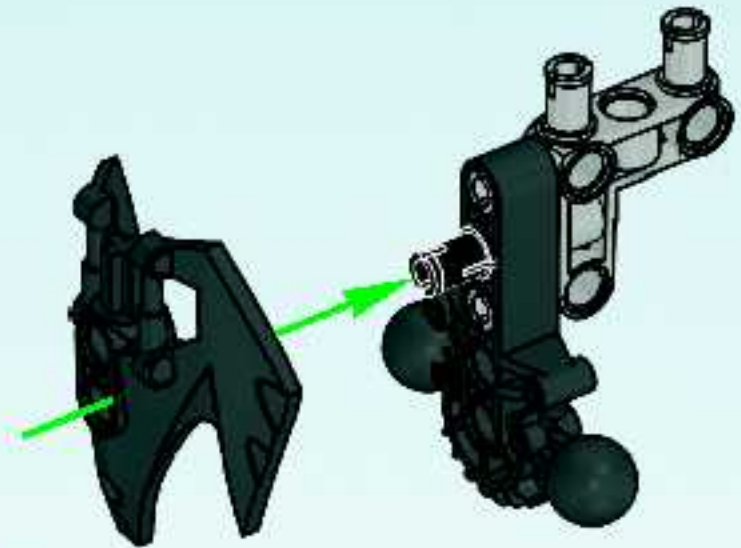

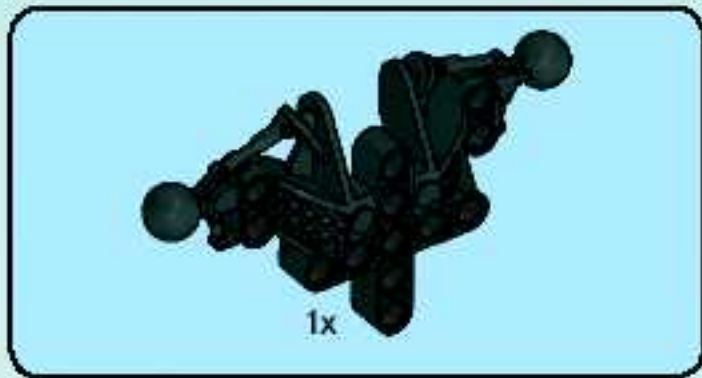

4

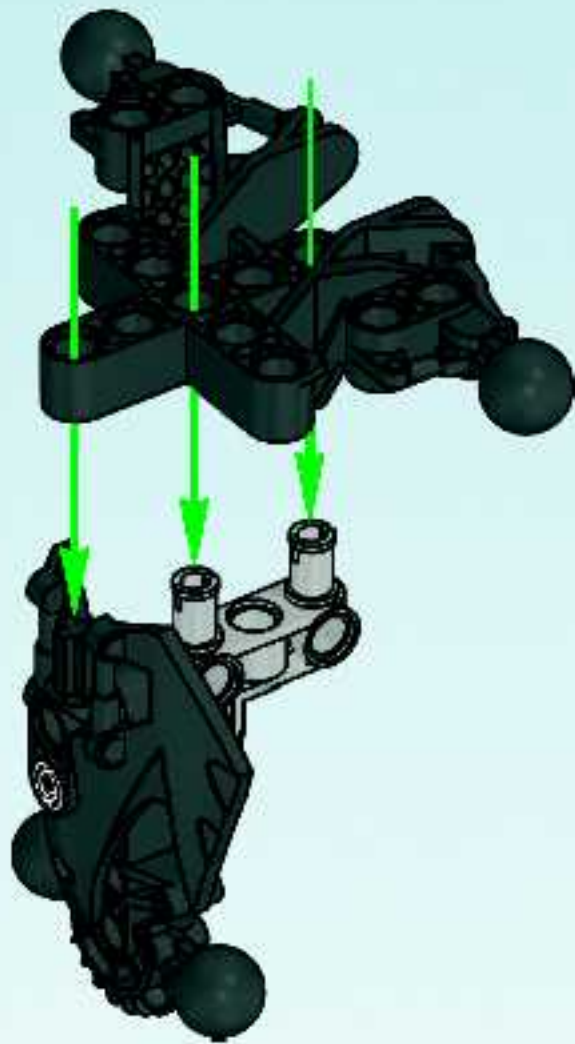

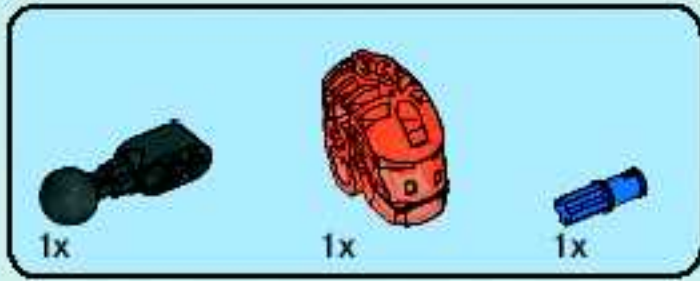

5

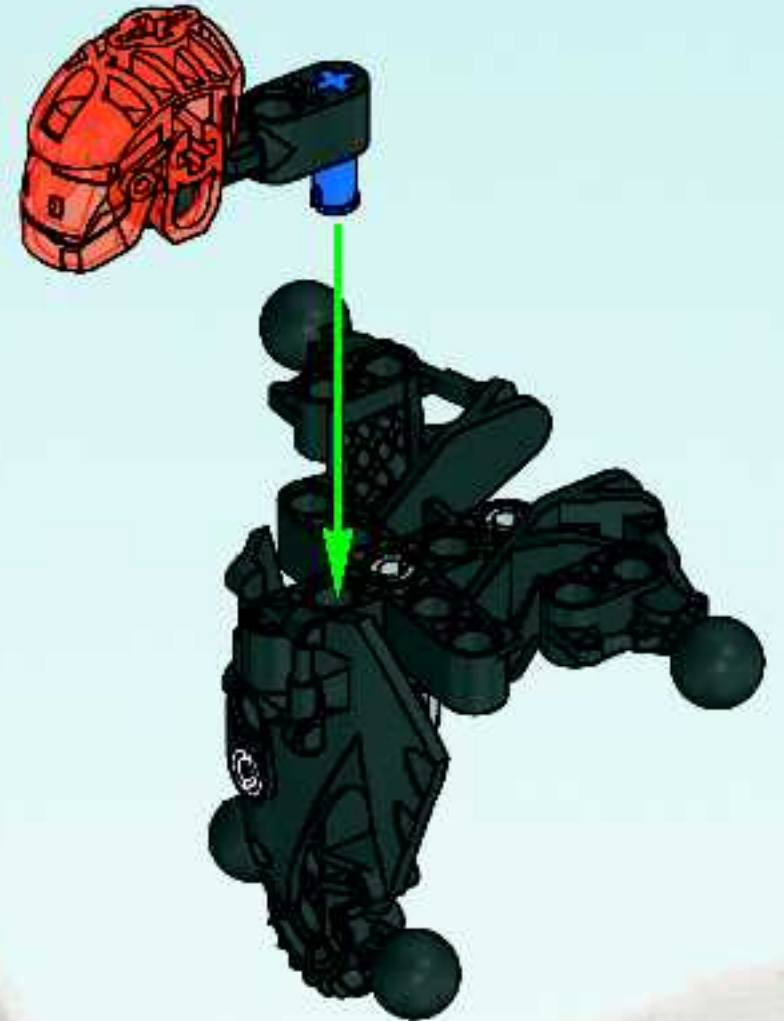
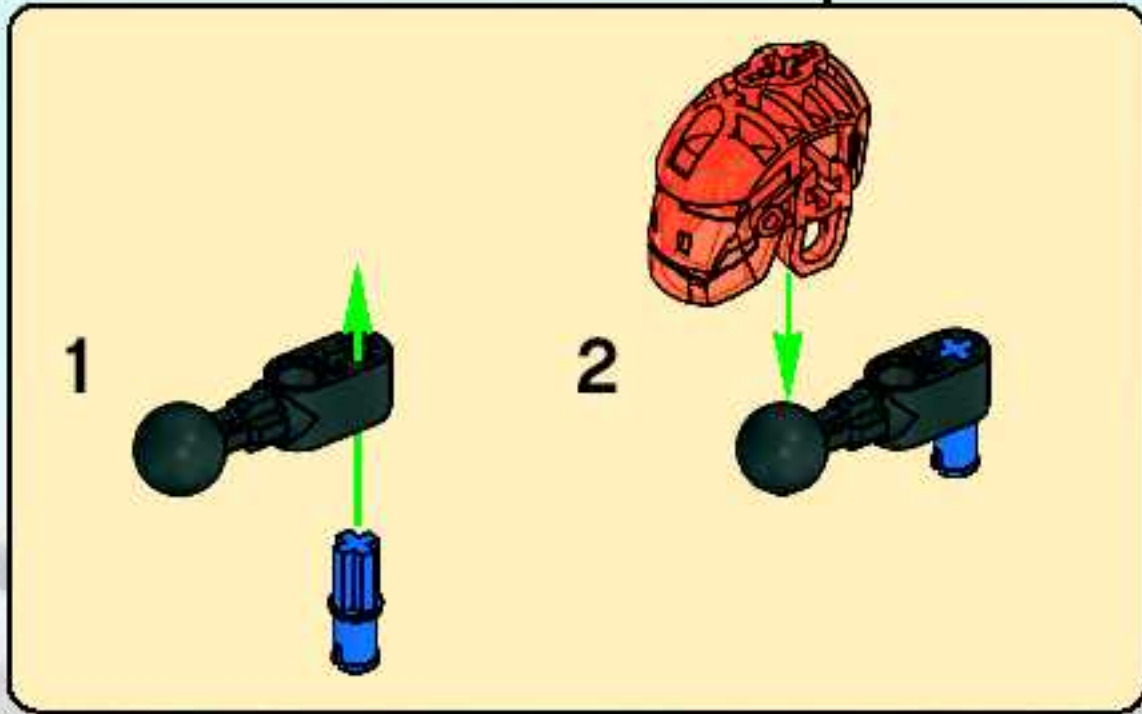

6

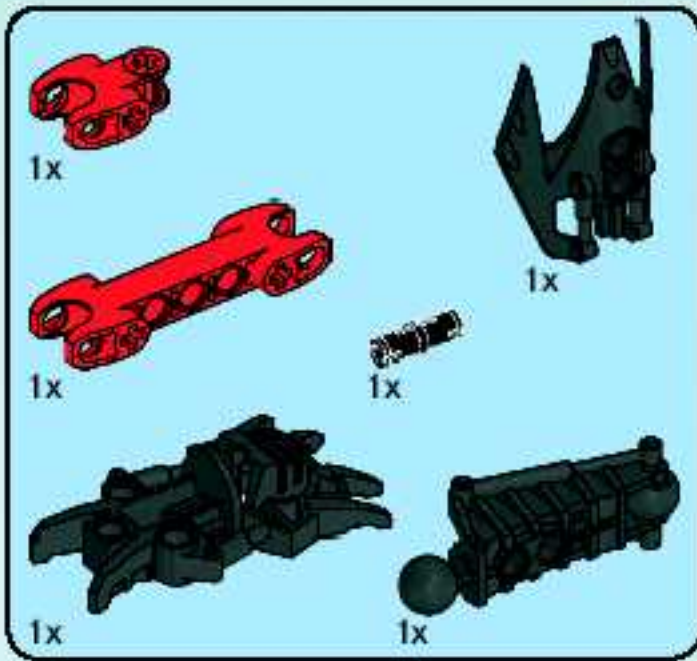

6



3



2x

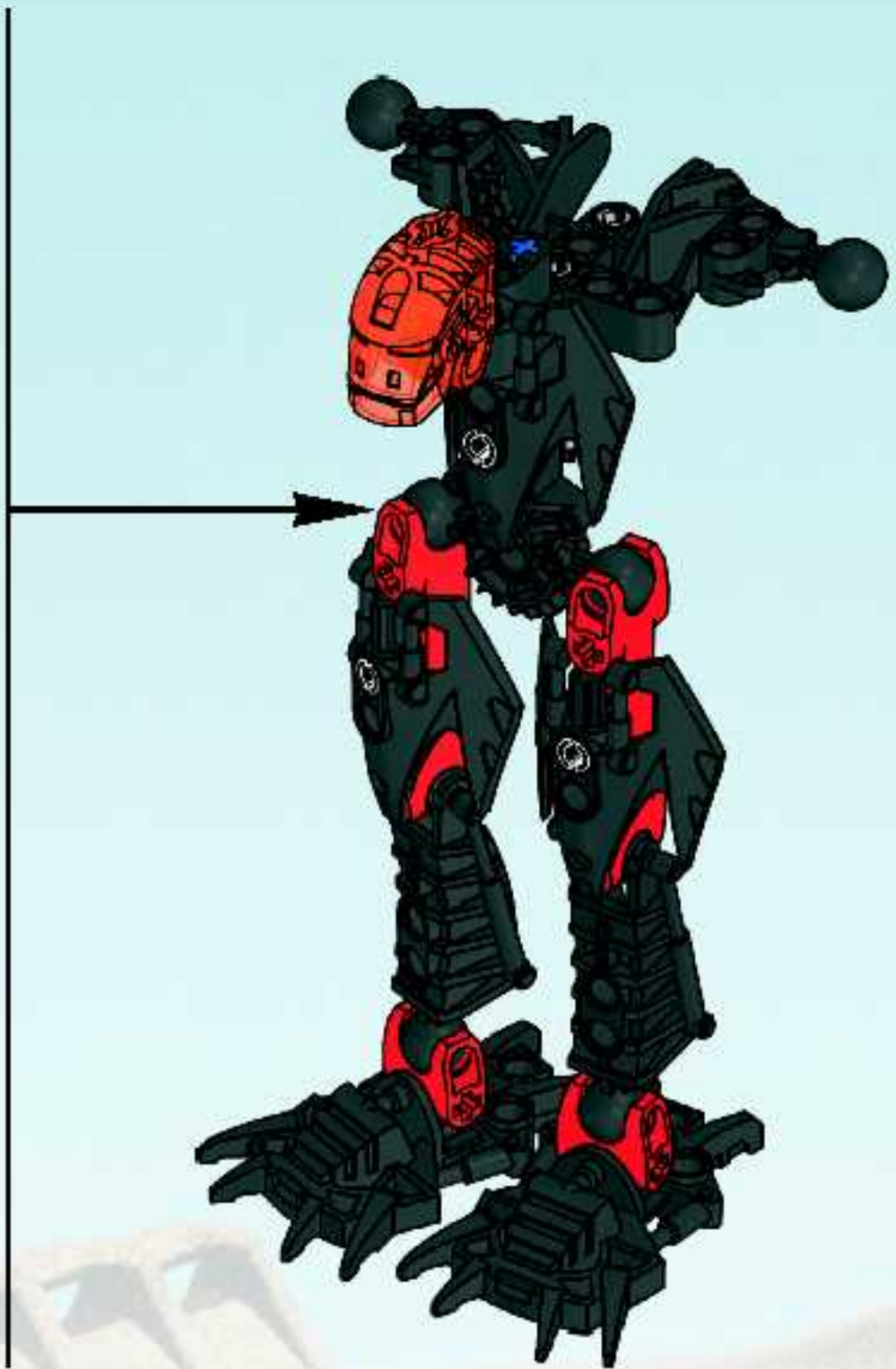

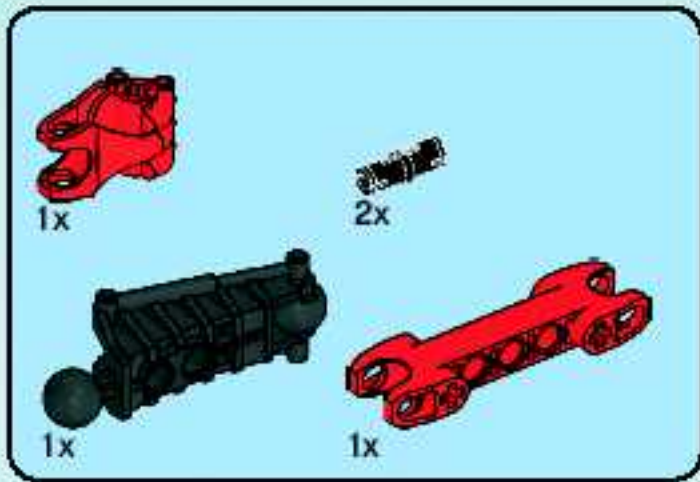

7

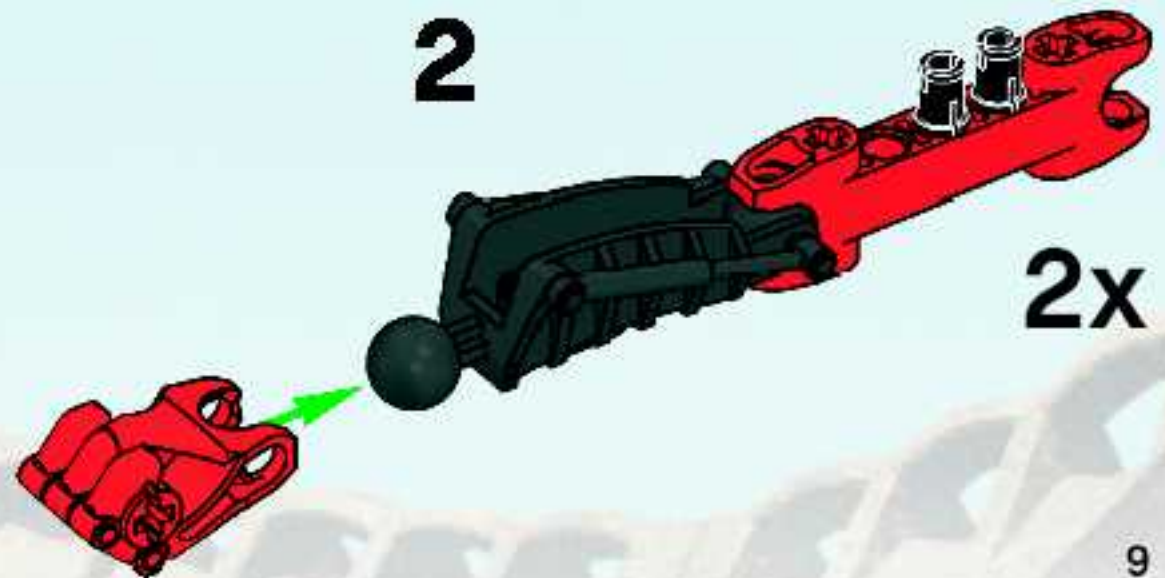
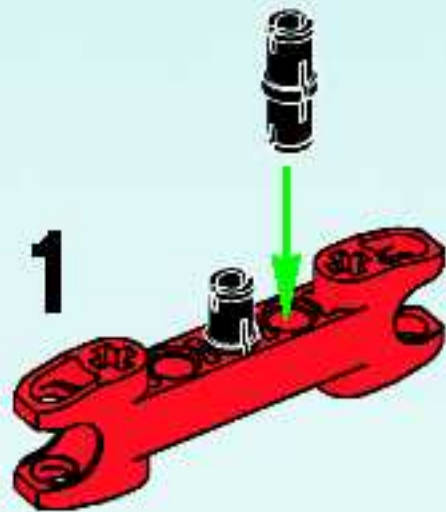

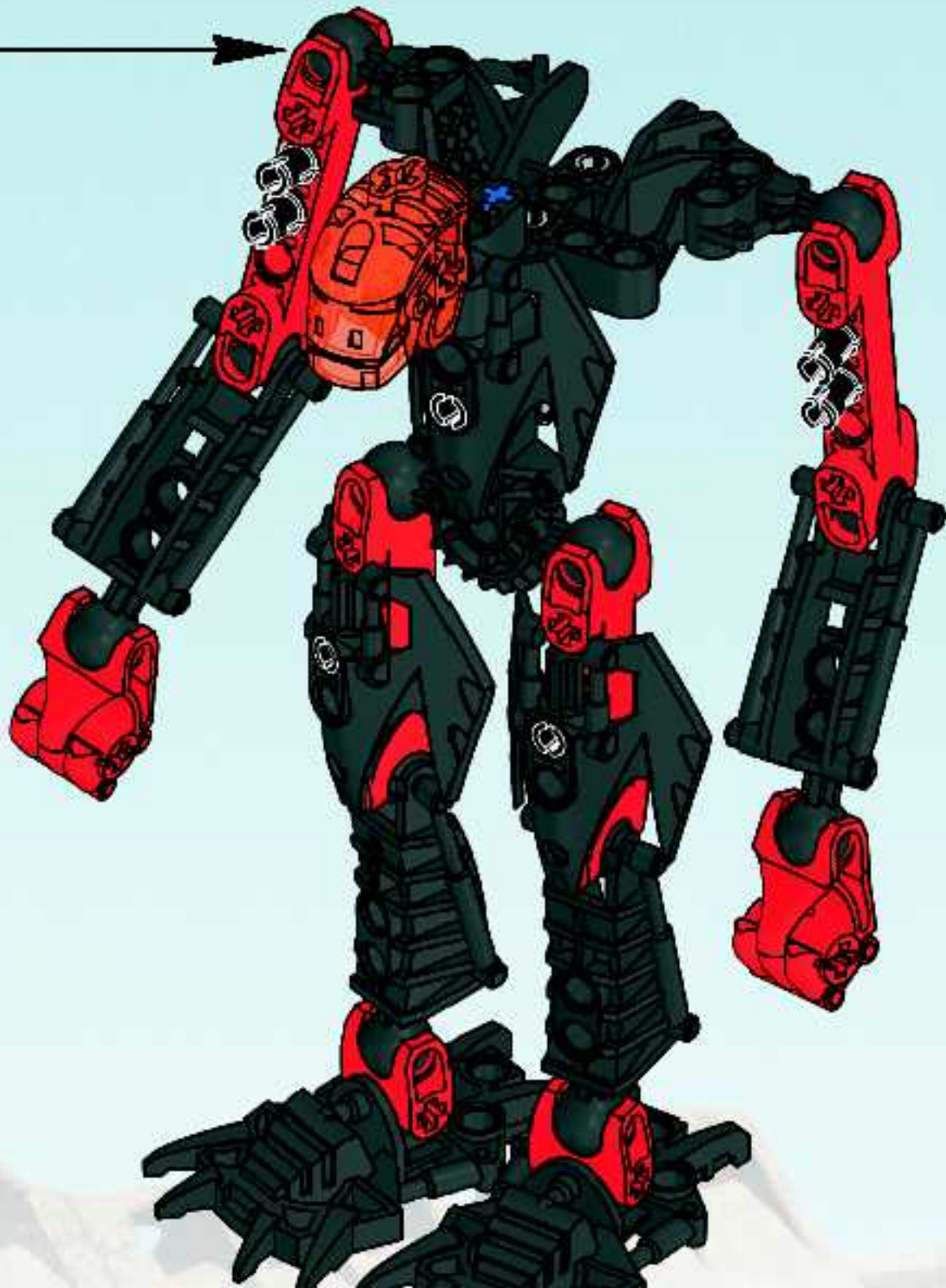

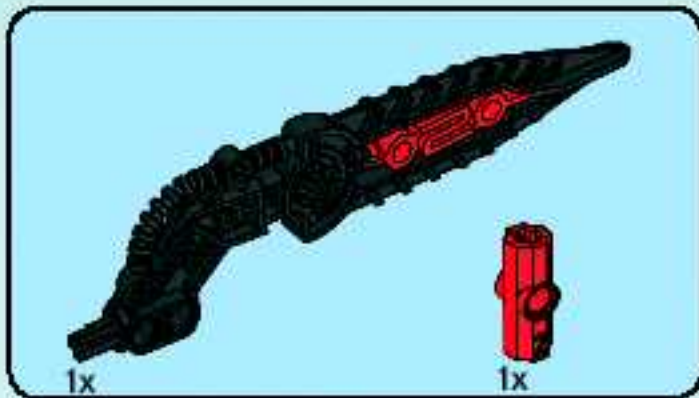

1



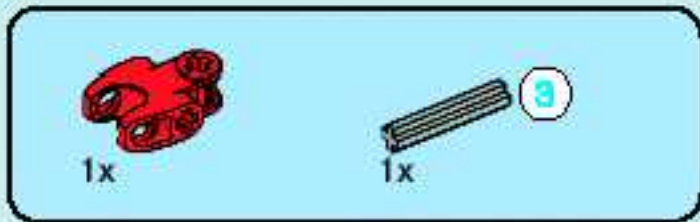

2

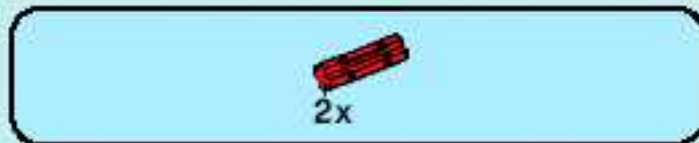
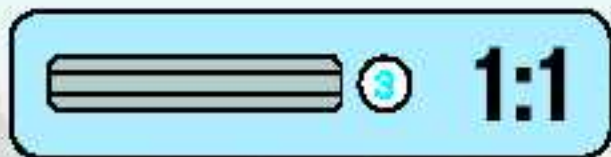
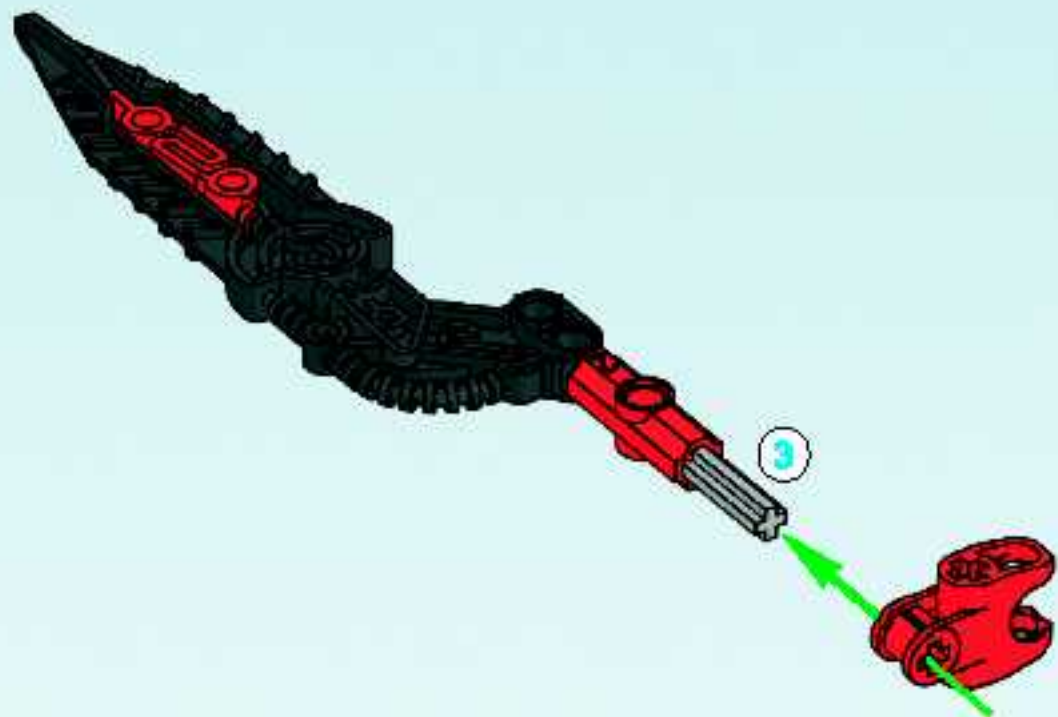

3

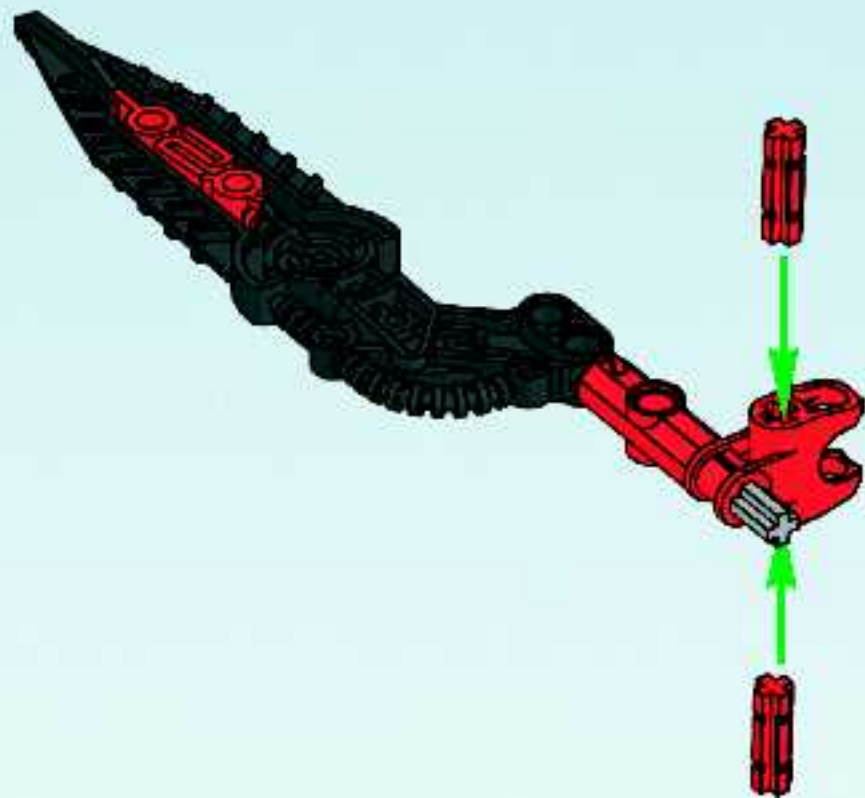

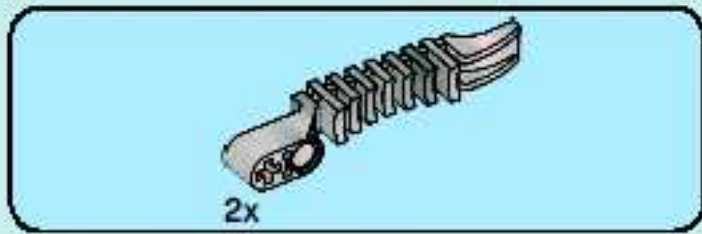

4

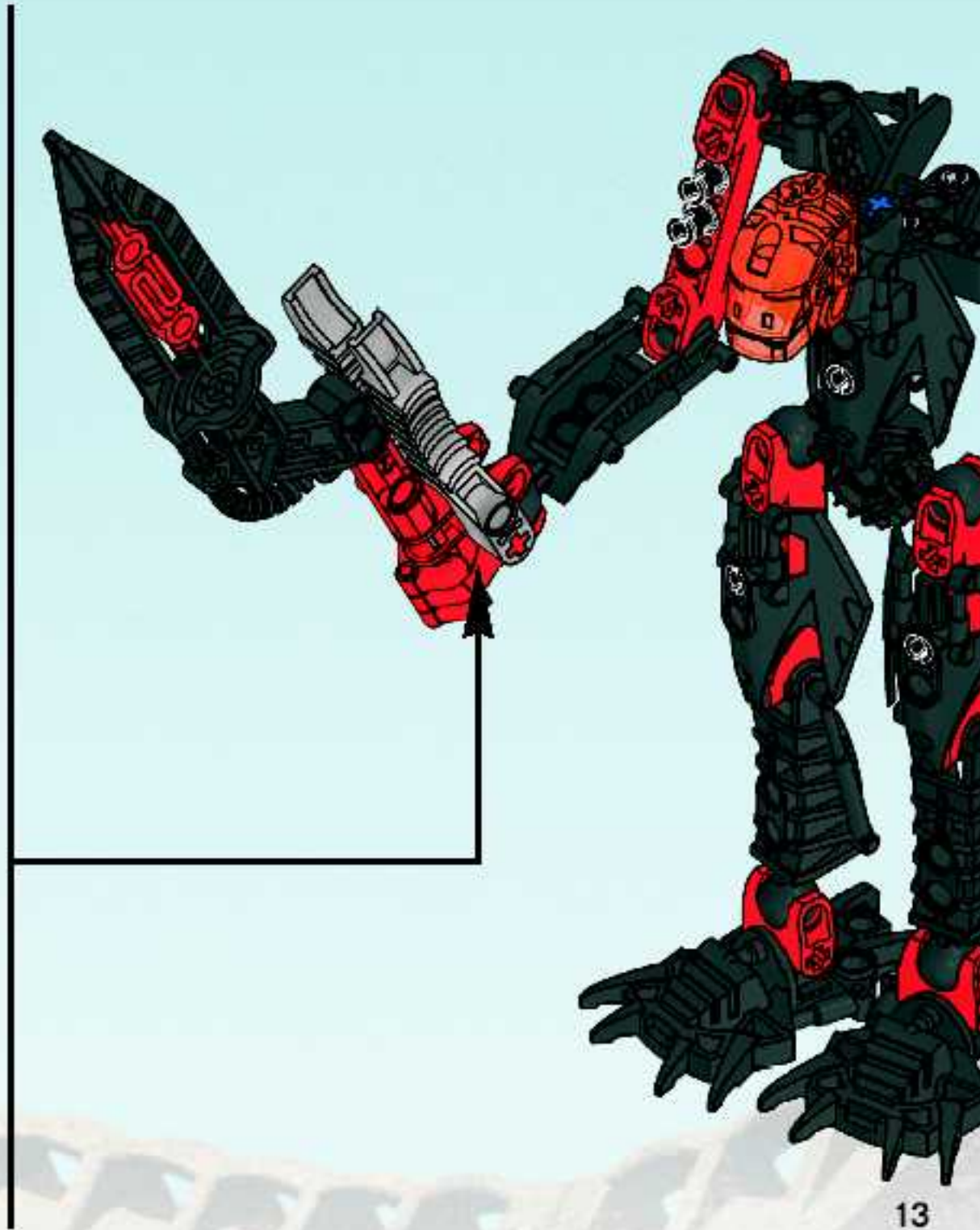
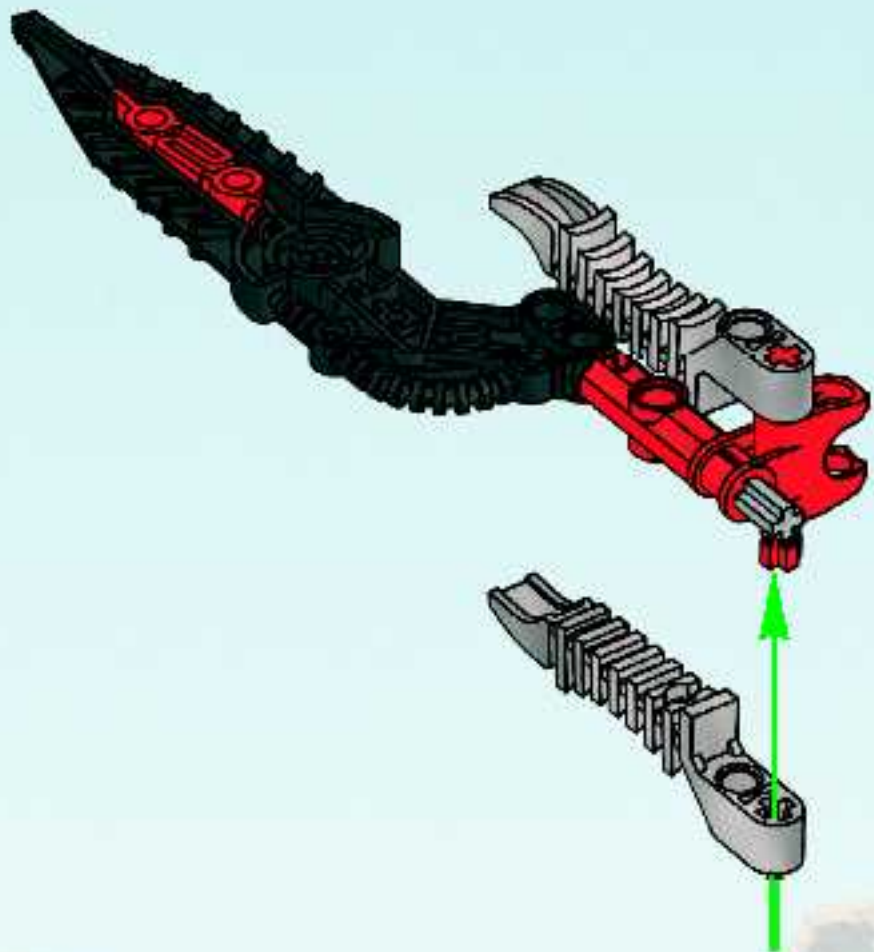



8



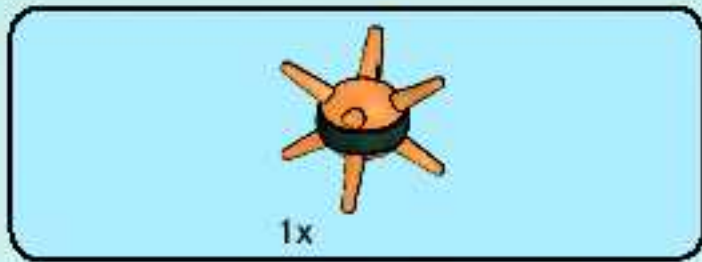

9

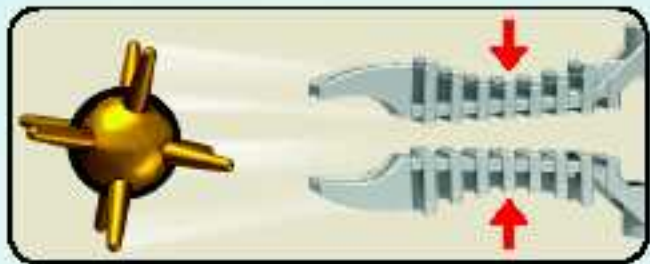
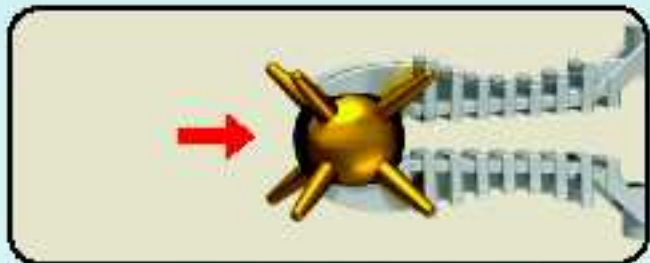

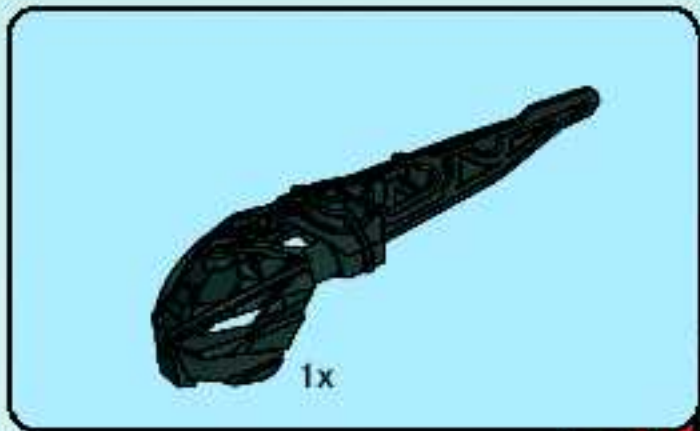

10



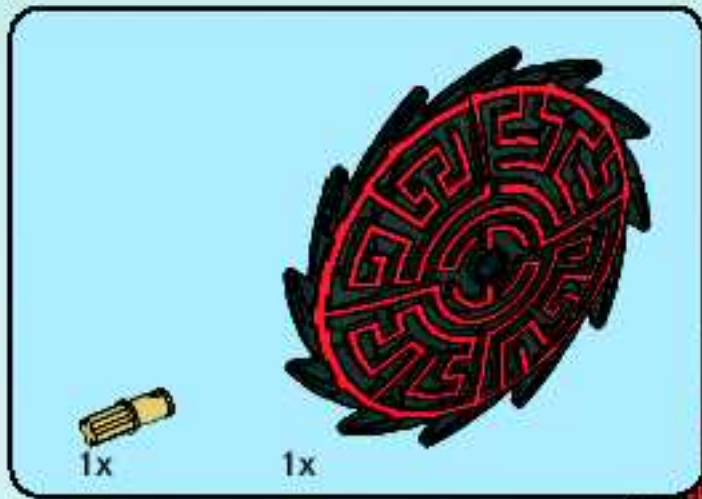

11



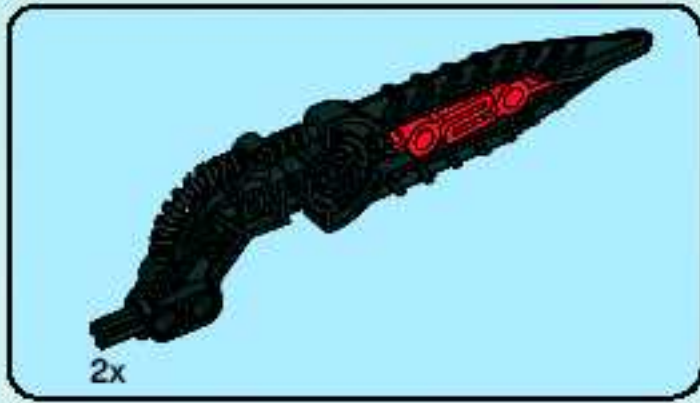

12



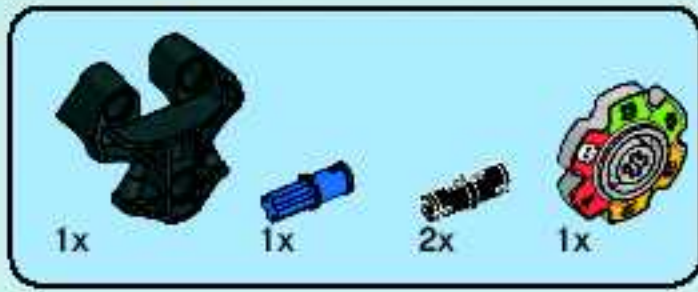

13

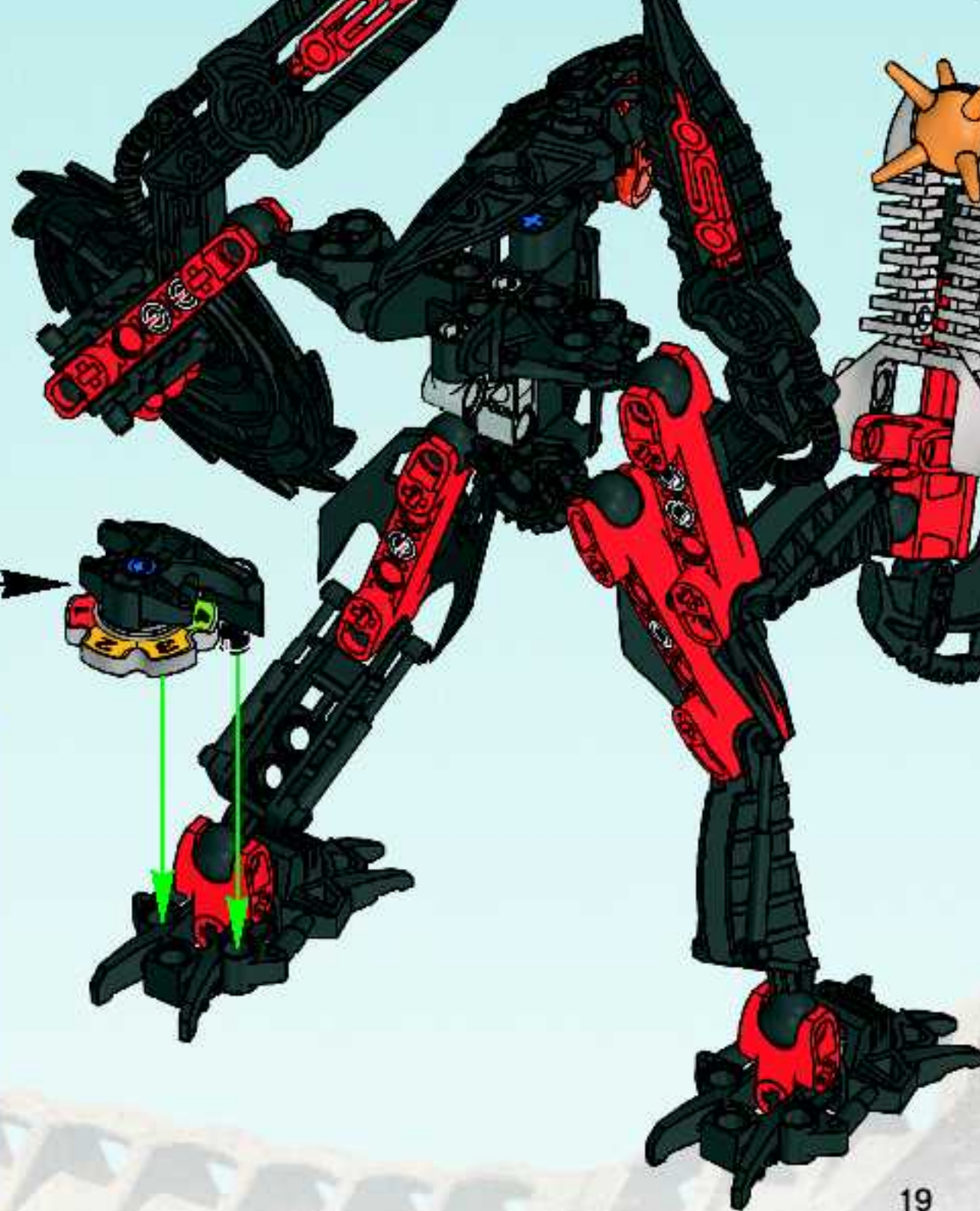
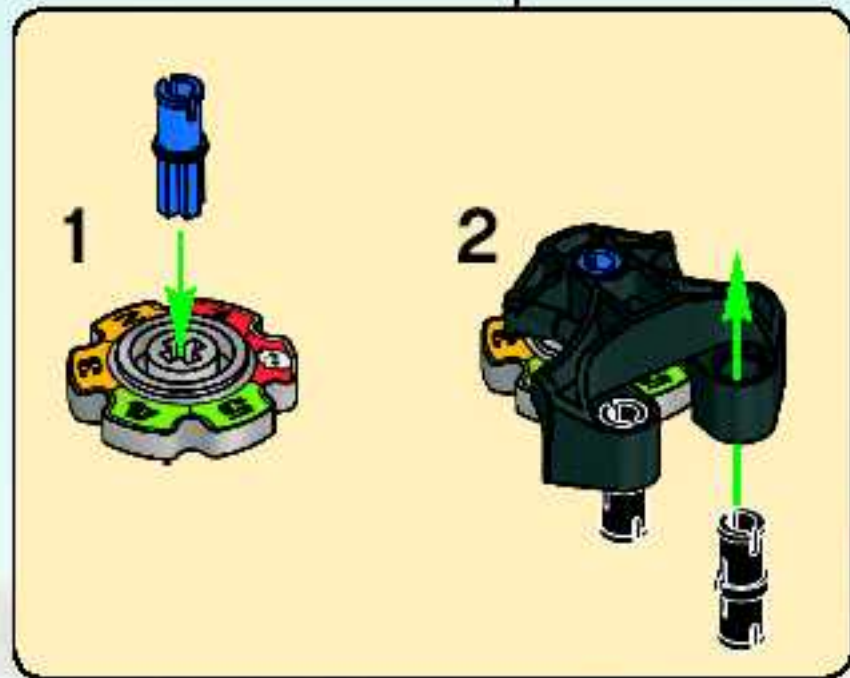



2x
4142865

1x
4234429

3x
4509902

2x
4541816

4x
4539216

9x
4121715

1x
4540702

1x
4537514

3x
4542509

1x
4278585

1x
4540599

4x
4278481

3x
4541600

1x
4541817

1x
4542386

2x
4280266

1x
4292590

1x
4543333

1x
4544529

2x
4546416

1x
4296059

1x
4211815

2x
4206482

1x
4186017

1x
4546585

Customer Service
Kundenservice
Service Consommateurs
Servicio Al Consumidor
www.lego.com/service or dial

: 00800 5346 5555
: 1-800-422-5346



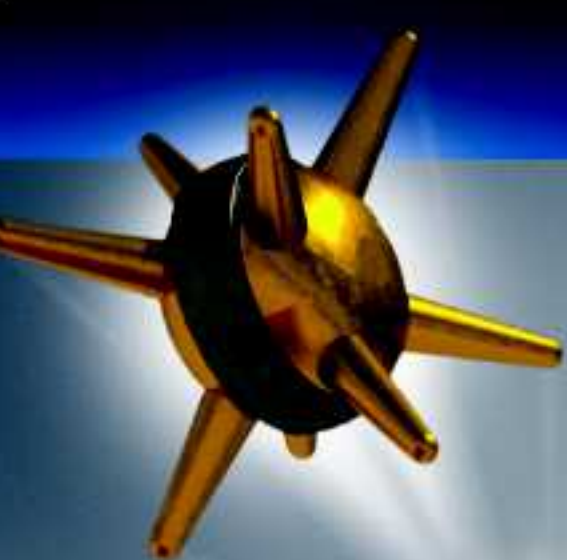

BIONICLE ACTION FIGURE
GAME



Setting Up Aufbau des Spiels

Règles du jeu Comenzar a jugar

This game is about taking the life of your opponent before he takes yours!

1. Set up the game using 2 cans & 2 figures
2. Set the dial to 5
3. Decide who goes first

Treffe Deinen Gegner und nimm ihm die Lebenspunkte, bevor er es tut!

1. Stelle zwei Dosen und zwei Figuren wie abgebildet auf.
2. Drehe die Lebenszähler an den Spielfiguren auf 5.
3. Entscheide, wer beginnt.

Pour remporter le combat, il faut que tu t'empares de la vie de ton adversaire avant qu'il ne s'empare de la tienne !

1. Délimite la zone de combat à l'aide des 2 boîtes et place les 2 figurines
2. Positionne ton compteur de vie sur 5
3. Décide qui commence

¡El objetivo de este juego es hacerse con la vida de tu oponente antes de que él se haga con la tuya!

1. Prepara el juego utilizando 2 botes y 2 figuras
2. Coloca el marcador en 5
3. Decide quién empezará



Playing the game: **POINTS** Punktvergabe bei einem Treffer

Comment jouer : **LE CALCUL DES POINTS**
Como jugar: **PUNTOS**

1. Hit can and opponent loses 1 life point or hit figure and opponent loses 2 points.
1. Wird die Dose getroffen, verliert der Gegner 1 Punkt, bei einem Treffer der Figur werden 2 Punkte abgezogen.
1. Si ta balle Spiky touche la boîte, ton adversaire perd 1 point de vie et si elle touche la figurine, ton adversaire perd 2 points
1. Si golpeas el bote, tu oponente pierde 1 punto y si golpeas la figura, tu oponente pierde dos puntos.



Playing the game: **MOVE**
Position der Spielfiguren

Comment jouer : **LES DÉPLACEMENTS**
Como jugar: **DESPLAZAMIENTO**

1. After shooting move figure to where ball lands.

1. Nach jedem Schuss wird die Figur dort abgestellt, wo die Dornenkugel gelandet ist.

1. Après avoir tiré, déplace la figurine à l'endroit où ta balle Spiky a atterri.

1. Después de disparar, mueve la figura hasta el lugar en el que haya caído la bola.



Winning the game
Gewinne das Spiel

Comment remporter le combat !
Como ganar



- 1. The first player to take all the opponent's life points wins!
- 1. Gewonnen hat der Spieler, der seinem Gegner als Erster alle Lebenspunkte genommen hat.
- 1. Le premier joueur qui s'empare de tous les points de vie de son adversaire gagne !
- 1. El primer jugador que se haya con todos los puntos de vida de su oponente ganará!

Team up
Spiele mit mehreren Figuren

Forme ton équipe !
Une al equipo

8988



8981



8982



8976



8975

8990



8977

For more rules on advanced multi-figure game play - check out

Weitere Informationen und Anleitungen für coole Spiele mit mehreren Figuren findest du unter

Retrouve toutes les règles du jeu multi-joueur sur

Para más información sobre instrucciones de juego avanzado con varias figuras, consulta

8980



www.BIONICLE.com

8974



8978



8991



8979



8972

8973



GLATORIAN BIONICLE®

FOR VICTORY - FOR GLORY - FOR POWER





8972



8973



8974

www.BIONICLE.com



8975



8977



8976

FERO &
SKIRMIX

TUMA

8990

8991

www.BIONICLE.com

FREE! GRATIS! GRATUIT!



club
MAGAZINE™

www.LEGOclub.com



00800 5346 5555*        

  **1-866-534-6258 • 1-877-518-5346**

US & Canada only

Canada seulement

* Prepaid card. Mobile charges may apply. ** Numéro sans Frais. Les Frais peuvent s'appliquer avec les téléphones cellulaires.

* Gebührenfrei. Kosten für Anrufer sind Mobilfunknetzkosten abweichend. ** Gratis telefonnummer vanaf gratis lijn. * Det er et gratis nummer, der du bruger fra Fast telefon.

* Débit gratuit, mais de régler l'abonnement Fast téléphone.



VISIT THE WORLD'S
BIGGEST LEGO® SHOP!

www.LEGOshop.com

 **YES! I want to join the LEGO® Club FREE! OUI! Je veux m'abonner au Club LEGO® GRATUITEMENT! Ja! Ich möchte Mitglied im kostenlosen LEGO® Club werden. Ja! Ik wil graag GRATIS lid worden van de LEGO® Club. Ja! Jeg ønsker å melde meg inn i LEGO® Club gratis! Ja! Jag vill gå med i LEGO® Club GRATIS!**

First name - Prénom
 Vername - Voornamen
 Fornavn - Fornavn

--	--	--	--	--	--	--	--	--	--	--	--	--	--	--	--	--	--

Last name - Nom de Famille
 Name - Achternamen
 Etternavn - Efternavn

--	--	--	--	--	--	--	--	--	--	--	--	--	--	--	--	--	--

Date of Birth - Date de naissance
 Geboortedag - Geboortedatum
 Fødselsdato - Fødselsdato

<table border="1" style="width: 100%; height: 20px;"> <tr><td style="width: 25%;"></td><td style="width: 25%;"></td><td style="width: 25%;"></td><td style="width: 25%;"></td></tr> </table>					<table border="1" style="width: 100%; height: 20px;"> <tr><td style="width: 25%;"></td><td style="width: 25%;"></td><td style="width: 25%;"></td><td style="width: 25%;"></td></tr> </table>					Boy - Garçon Junge - Jungen Guttt - Pojke <input type="checkbox"/>	Girl - Fille Mädchen - Hetsje Jente - Flicka <input type="checkbox"/>

Street - Adresse
 Straße, Hausnr.
 Straat, huisnr. - Adress

--	--	--	--	--	--	--	--	--	--	--	--	--	--	--	--	--	--

City - Ville
 Ort - Woonplaats
 Poststed - Postort

--	--	--	--	--	--	--	--	--	--	--	--	--	--	--	--	--	--

State
 Prov.
 County

--	--	--	--	--	--	--	--	--	--	--	--	--	--	--	--	--	--

Zip/Postcode - Code Postal
 PLZ - Postcode - Postnummer

--	--	--	--	--	--	--	--	--	--	--	--	--	--	--	--	--	--

Country
 Pays - Land

--	--	--	--	--	--	--	--	--	--	--	--	--	--	--	--	--	--

Please tick below if you would like to receive other communication from the LEGO Group. Si vous aimeriez recevoir d'autres communications de la part de la compagnie LEGO, veuillez s.v.p. cocher ici. Als u graag andere informatie van de LEGO Groep wilt ontvangen, kruis dan o.v.b. dit vakje aan. Ich möchte über Produkte, Angebote, Aktionen und weitere interessante Themen von der LEGO Gruppe informiert werden* (bitte ankreuzen). Om å vill få annen informasjon fra LEGO Gruppen, sett kryss her. Hvis du ønsker å motta annen informasjon fra LEGO Gruppen, merk der av her.

Post - Poste
 Per Post

Email - Courriel
 Per E-Mail
 E-Mail

--	--	--	--	--	--	--	--	--	--	--	--	--	--	--	--	--	--

Ich möchte über Produkte, Angebote, Aktionen und weitere interessante Themen von der LEGO Gruppe informiert werden* (bitte ankreuzen). Per Post Per E-Mail

Mail to: / Poster à:  LEGO® Club
 P.O. Box 1157
 EnField, CT USA
 06083-1157

Mail to:   LEGO® Club
 33 Both Road
 Slough SL1 3UF
 United Kingdom

Per Post an:    LEGO® Club
 Postfach 14 15
 D-36243 Niederaulo

Stuur op naar:  LEGO® Club
 Postbus 40250
 3504 AB Utrecht

Send til:  LEGO® Club Norge
 Postboks 58
 1314 Vøyenenga

Skickas till:  LEGO® Club Sverige
 Ubox 841
 202 29 Malmö

   The English language version of the magazine can only be mailed to addresses in the US, Canada, the UK, and Republic of Ireland. Club membership is valid for two years and includes free copies of the LEGO Club Magazine. In the US and Canada please allow up to 6 weeks for delivery of your first magazine. In the UK and Republic of Ireland please allow six to 14 weeks for delivery of your first magazine. By signing this form you consent the LEGO Club to use your child's data for LEGO mailings. The data will only be used for LEGO mailings and will not be sold, rented or otherwise disclosed to any company outside the LEGO Company except for disclosure to companies acting as our agents to help us provide services requested by the child. This coupon is valid for one free membership per person, group or organisation. Photocopied coupons are accepted.  La version française du magazine peut être postée uniquement au Canada. L'abonnement est valide pour 2 ans et inclut des exemplaires gratuits du Magazine LEGO. Aux E.-U. et au Canada, allouer 6 semaines pour la livraison initiale. En remplissant ce formulaire, vous consentez à ce que LEGO utilise les informations de votre enfant pour des envois postaux de LEGO. L'information sera utilisée uniquement pour des envois postaux par LEGO et ne sera en aucun cas, vendue, louée, échangée ou divulguée à d'autres compagnies autres que la compagnie LEGO, à l'exception des compagnies affiliées qui nous procurent des services auxquels l'enfant en a fait la demande.  Das deutschsprachige LEGO Club Magazin kann nur an Adressen in Deutschland, Österreich und der Schweiz verschickt werden. Die kostenlose Mitgliedschaft beinhaltet die Zusendung des LEGO Club Magazins und endet nach zwei Jahren. Mit der Anmeldung gehen Sie keine Verpflichtungen ein. Es kann bis zu drei Monate dauern, bis das erste Magazin zugestellt wird. Mit Ihrer Unterschrift erklären Sie sich damit einverstanden, dass die Daten Ihres Kindes zum Zweck einer LEGO Club Mitgliedschaft von der LEGO Gruppe gespeichert und verarbeitet werden. Die Daten werden vertraulich behandelt, nicht an Dritte weitergegeben und nicht veräußert. Externe Dienstleister erhalten Ihre Daten nur, soweit es für die Abwicklung von LEGO Kommunikation erforderlich ist. Wenn Sie von uns nicht mehr kontaktiert werden möchten, können Sie der Verwendung Ihrer Daten für Werbezwecke widersprechen unter: 00800 5346 5555 (Anruf gebührenfrei, Kosten für Anrufe aus Mobilfunknetzen können abweichen). * Die Einwilligungen kann ich jederzeit (insgesamt oder zum Teil) ohne Einfluss auf die LEGO Club Mitgliedschaft bei der LEGO Gruppe widerrufen.  Het LEGO Club Magazine kan alleen worden gestuurd naar adressen in Nederland. Het lidmaatschap is 2 jaar geldig en geeft recht op toezending van het gratis LEGO Club Magazine. Het eerste magazine zal na 12 tot 14 weken toegestuurd worden. Het lidmaatschap kan op ieder moment opgezegd worden. Door dit formulier te tekenen geeft u de LEGO Club toestemming om bovenstaande gegevens te gebruiken voor het toesturen van LEGO mailings. Uw gegevens worden uitsluitend gebruikt voor mailings van LEGO en zullen niet worden verkocht, verhuurd of op welke wijze dan ook verstrekt aan derden buiten de LEGO Groep, uitgezonderd de organisaties die namens ons optreden om de service te verlenen waar uw kind om gevraagd heeft.  Den norske utgaven av magasinet sendes kun til adresser i Norge. Medlemskap i klubben gjelder i 2 år og inkluderer gratisutgaver av LEGO Magazine. Påregnet opp til seks uker leveringstid for første magasin. Ved å undertegne dette skjemaet, gir du ditt samtykke til at LEGO Club kan bruke opplysningene om barnet ditt i LEGO forsendelser. Dataene vil utelukkende bli brukt i LEGO forsendelser og vil ikke bli solgt, utleid eller på annen måte gjøres tilgjengelig for selskaper utenfor LEGO gruppen, unntatt selskaper som er våre agenter og som hjelper oss å tilby tjenestene barnet etter spør. Dette skjemaet gjelder for ett gratis medlemskap per person, gruppe eller organisasjon.  Den svenska versionen av tidningen kan endast skickas till adresser i Sverige. Club-medlemskapet är giltigt i 2 år och innefattar gratis exemplar av LEGO Club Magazine. Vänligen räkna med 6 veckor för leverans av din första tidning. Genom att skicka in det här formuläret godkänner du att LEGO Club använder barnets uppgifter för LEGO utskick. Uppgifterna kommer bara att användas för LEGO utskick och kommer inte att säljas, hyras ut eller vidarebefordras till något företag som inte tillhör LEGO Gruppen, med undantag av företag som agerar som våra ombud för att tillhandahålla tjänster som barnet har begärt. Den här kupongen gäller för ett gratis medlemskap per person, grupp eller organisation.

Parent's signature - Signature d'un parent - Unterschrift: Erziehungsberechtigte/r
 Handtekening ouders - Forældres/Forættets underskrift - Forælders /Förmyndares underskrift

Date
 Datum
 Dato



WIN LEGO® PRODUCTS

Fill out a survey and you might WIN a cool LEGO product
NO PURCHASE NECESSARY
Open to all residents where not prohibited
Go to www.nielsen.com/LEGO to fill out a survey for a chance to win a LEGO product

WIN LEGO® PRODUCTEN

Vul een enquêteformulier in en maak kans op een cool LEGO® product!
Kopen niet nodig
Iedereen uit landen waar geen enquêteverbod geldt mag deelnemen.
Ga naar www.nielsen.nl/m.dk/LEGO, vul een enquêteformulier in en maak kans op een LEGO product.

GEWINNE LEGO® PRODUKTE

Nimm an der Umfrage teil und GEWINNE ein tolles LEGO® Produkt!
Die Teilnahme am Gewinnspiel führt zu keinerlei Kaufverpflichtungen
Teilnahme in allen nicht ausgeschlossenen Ländern möglich
Wir verlosen unter allen Teilnehmern der Umfrage auf www.nielsen.nl/m.dk/LEGO LEGO Produkte.

GAGNE DES PRODUITS LEGO®

Réponds à un questionnaire et tu pourrais GAGNER un produit LEGO® très cool !
Aucune obligation d'achat.
Ouvert à tous les résidents des pays autorisés.
Visite www.nielsen.nl/m.dk/LEGO pour répondre à un questionnaire et avoir une chance de gagner un produit LEGO.

レゴ®製品を「当てよう」

アンケートに記入して、かっこいいレゴ®製品を当てよう！
お買い上げの必要はありません。
禁止されていない限り、すべての皆様にご利用いただけます。
www.nielsen.nl/m.dk/LEGOにアクセスして、アンケートにご記入ください。当選者にはレゴ®製品を差し上げます。

