



STAR WARS



9500



1

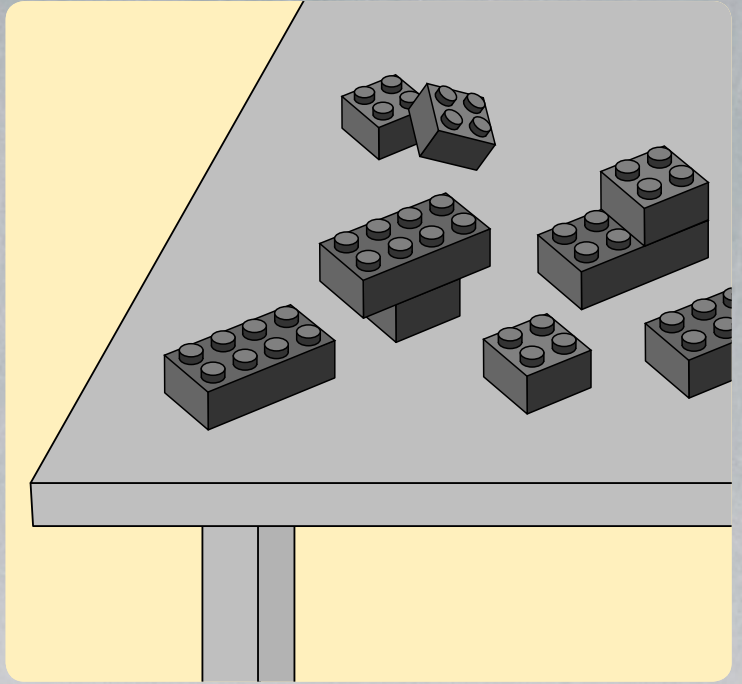
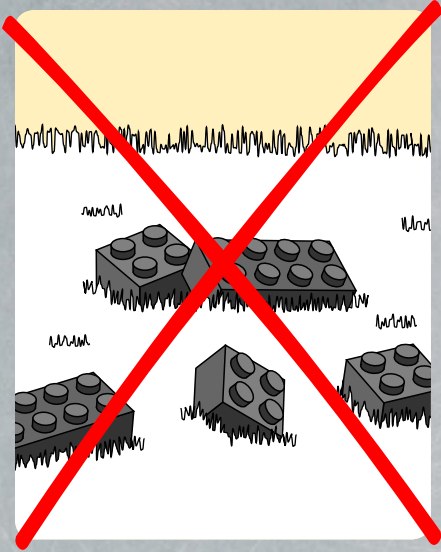

2



<http://lego.com/brickseparator>

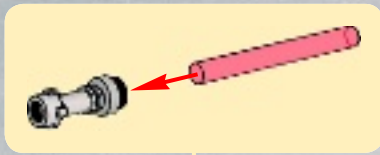

1

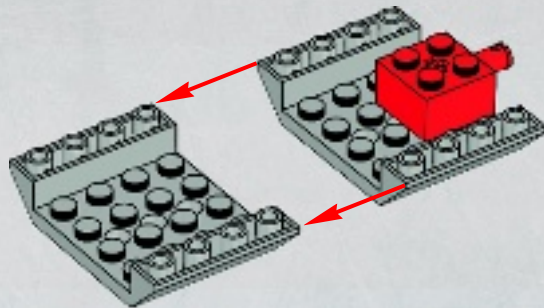



1x

2

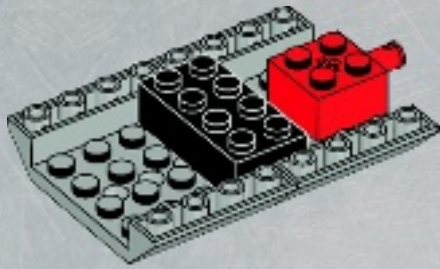

1x



3x



2x

4

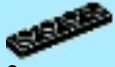
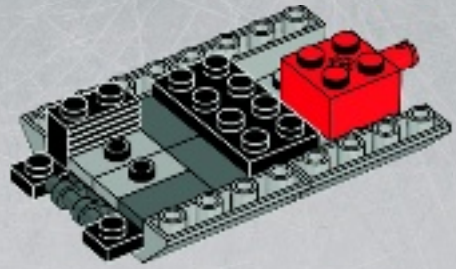

2x



1x



1x

3

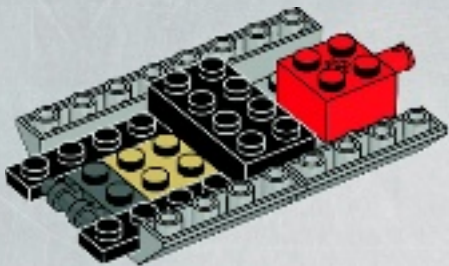

2x



2x



2x



2x

5

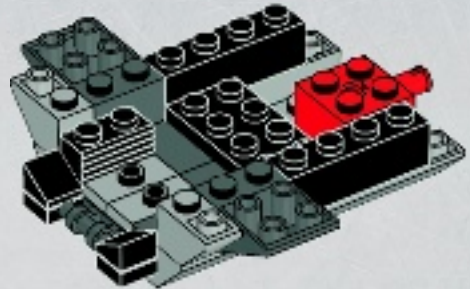

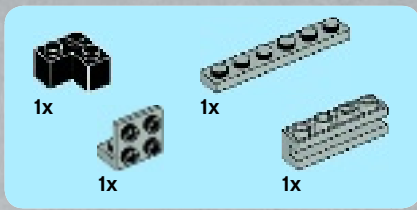

6

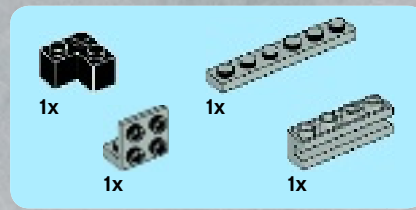
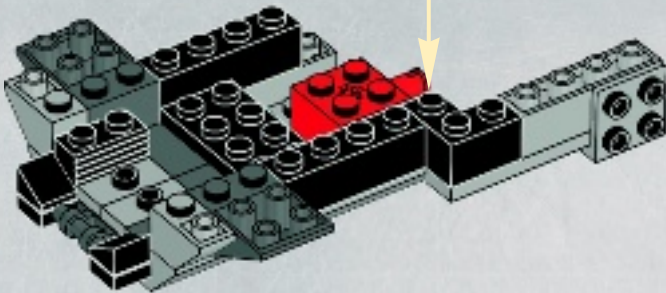
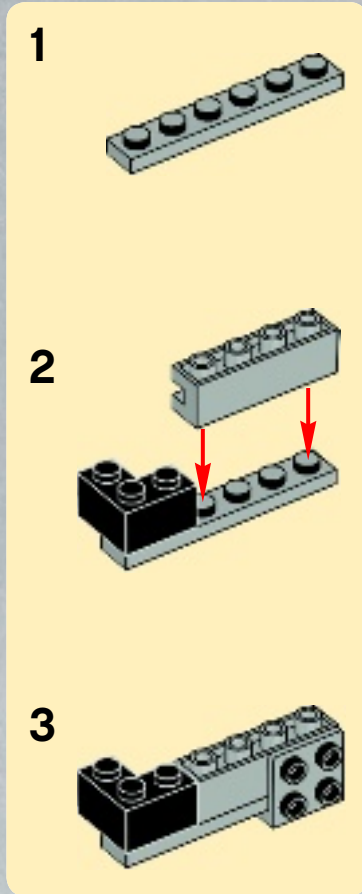

7

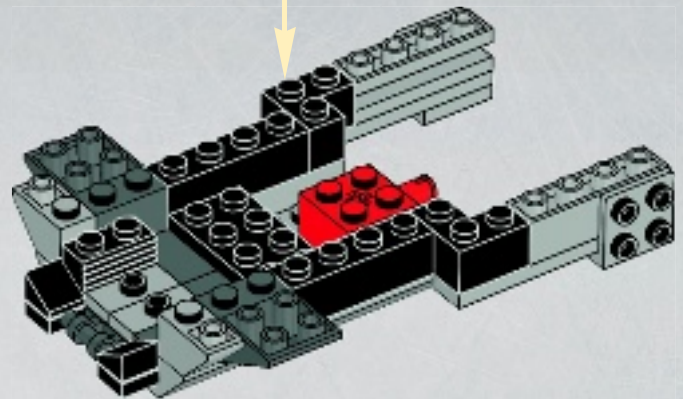
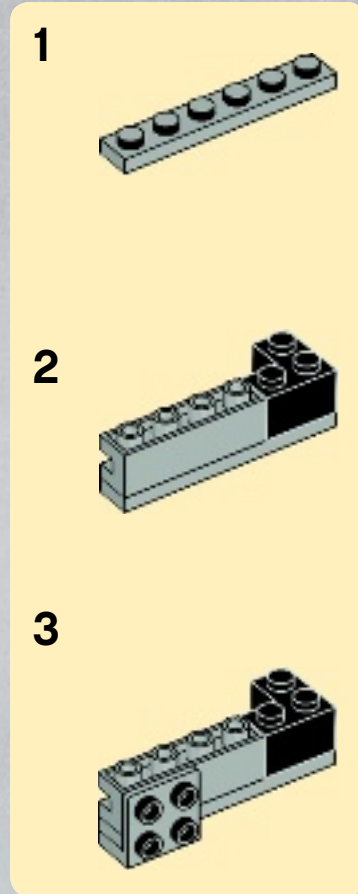

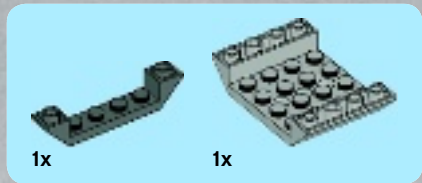

1

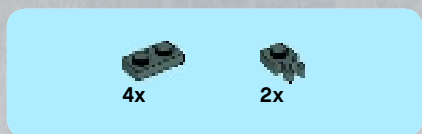
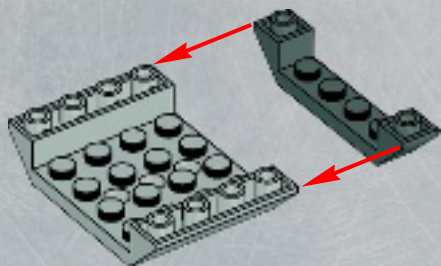

2

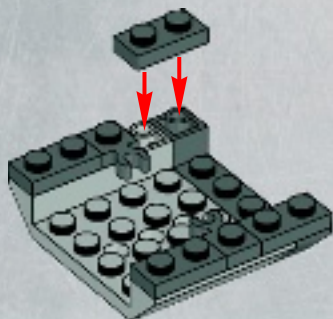

3

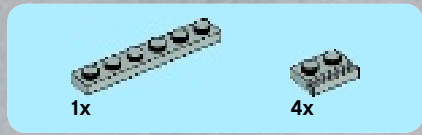
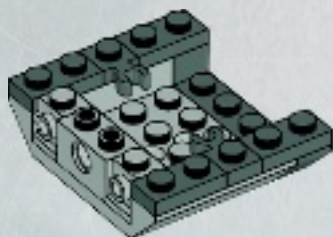

4

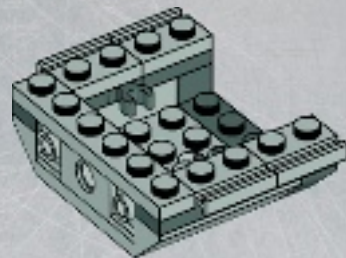

5

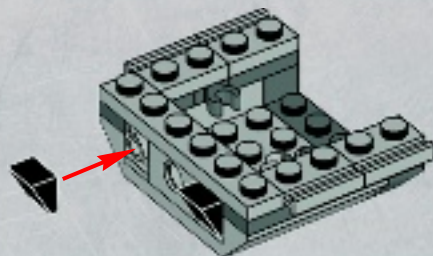

6

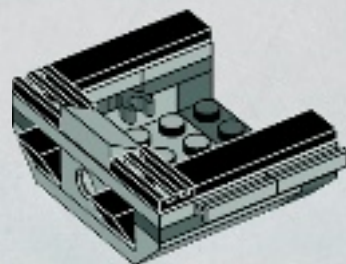

8

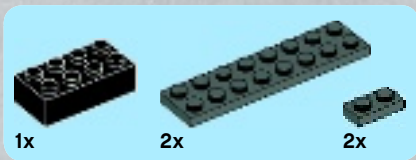
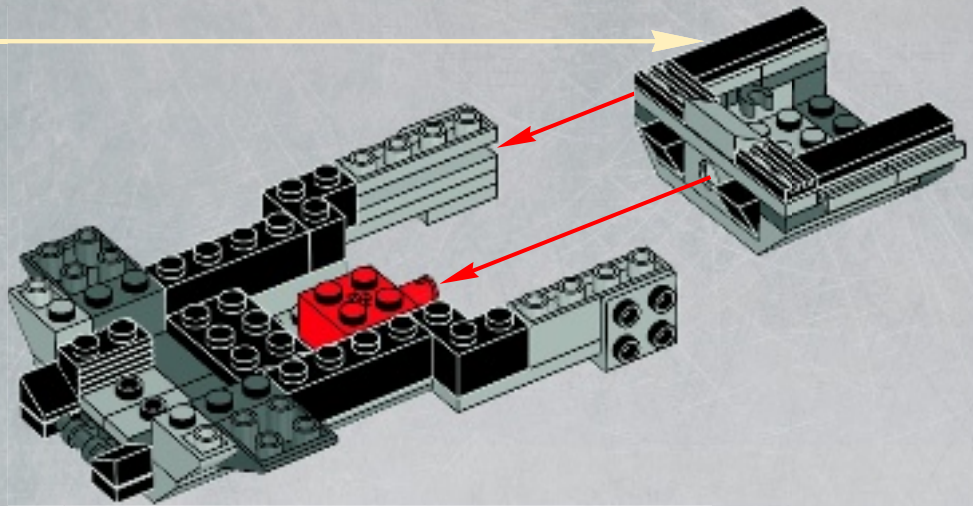

9

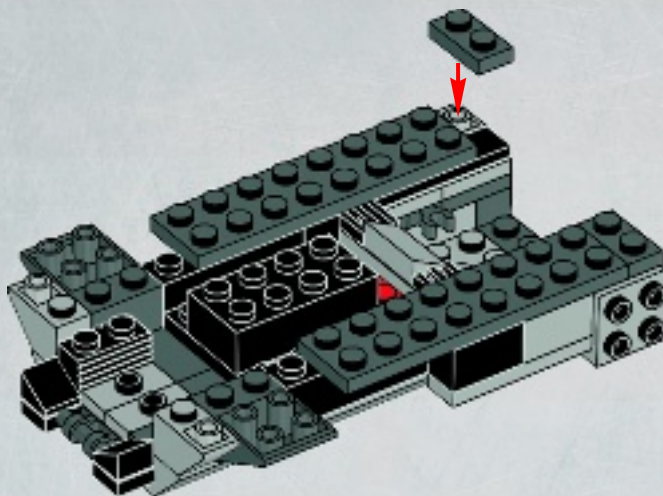



10

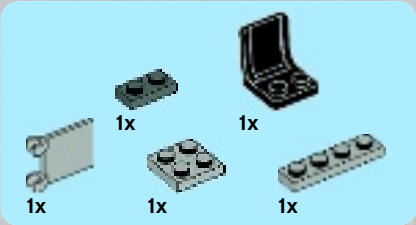
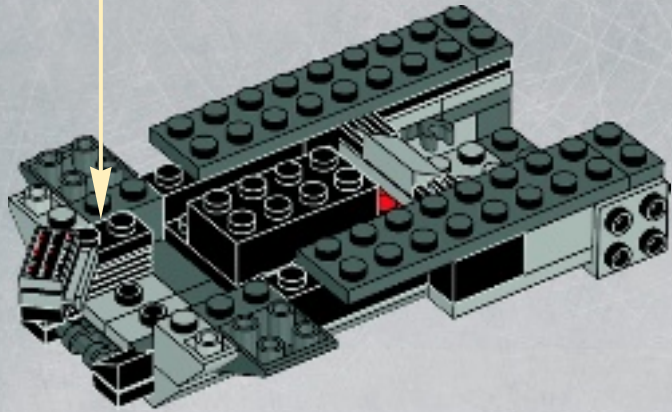

11

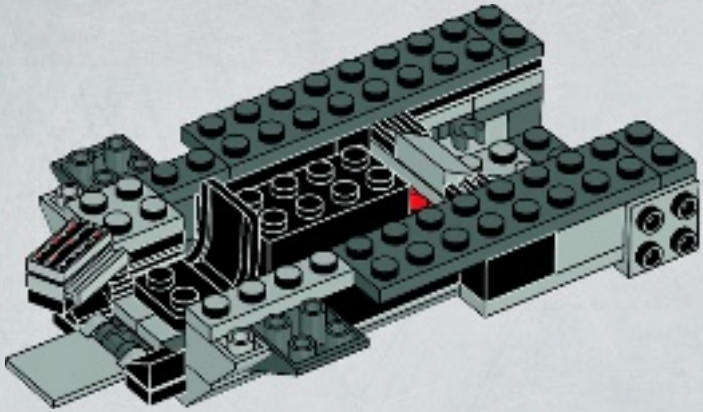

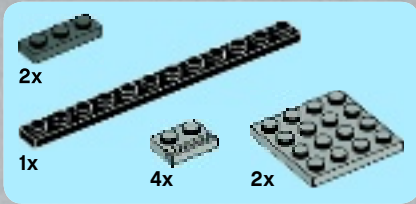

12

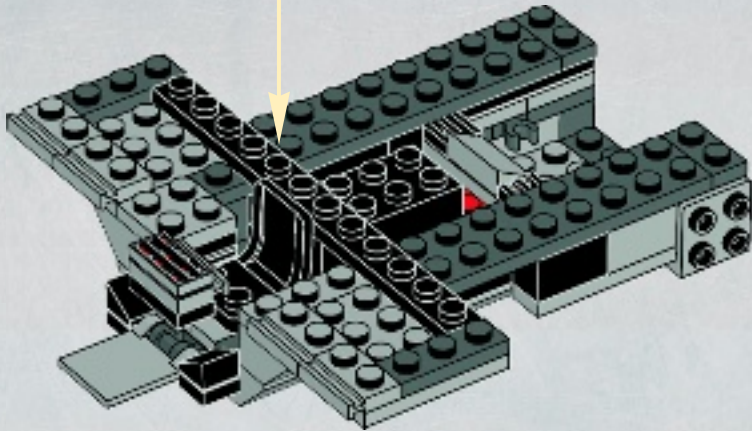
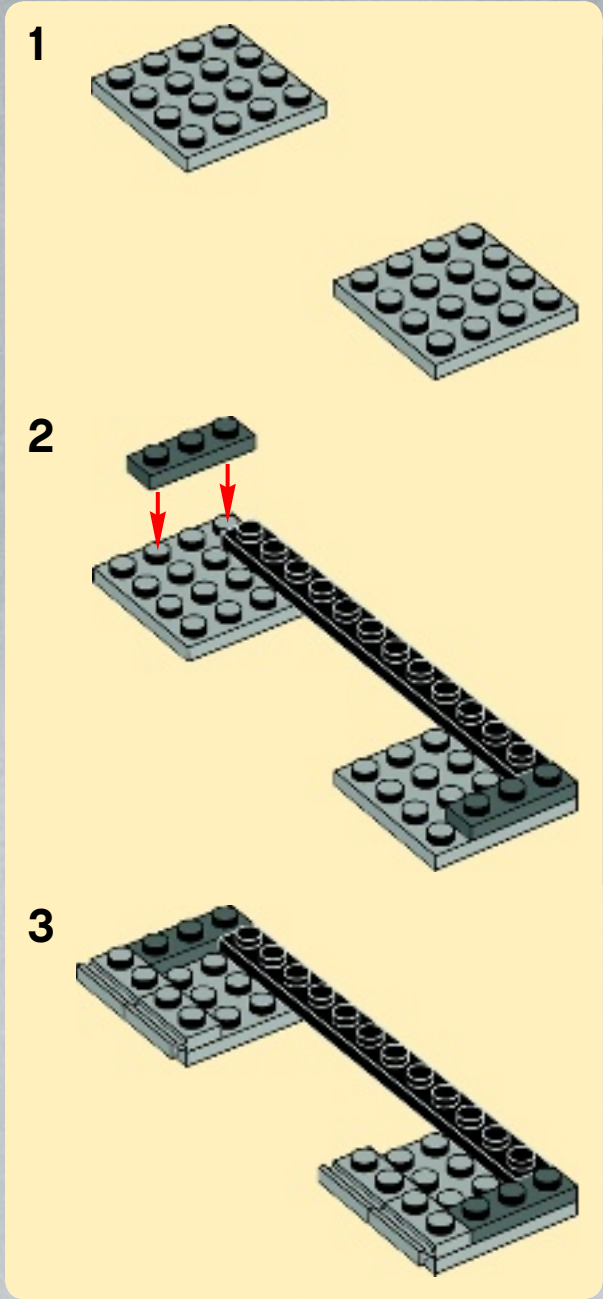

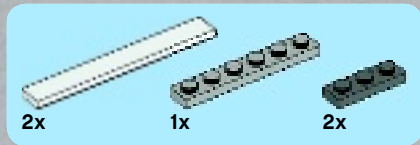

13

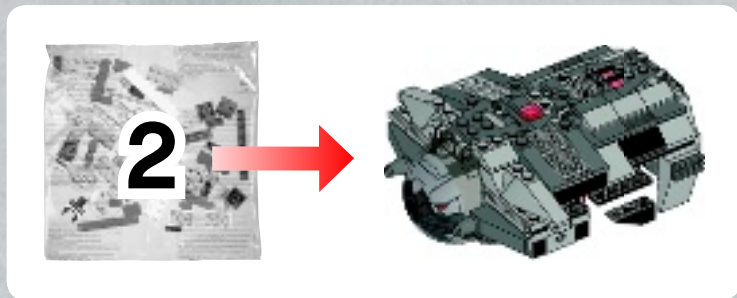
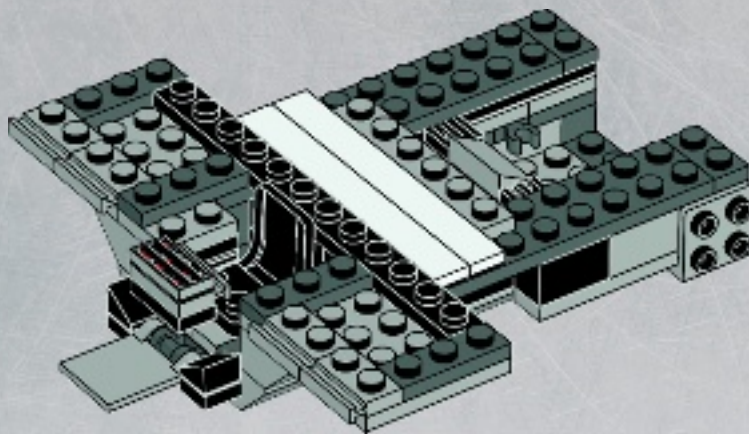

14

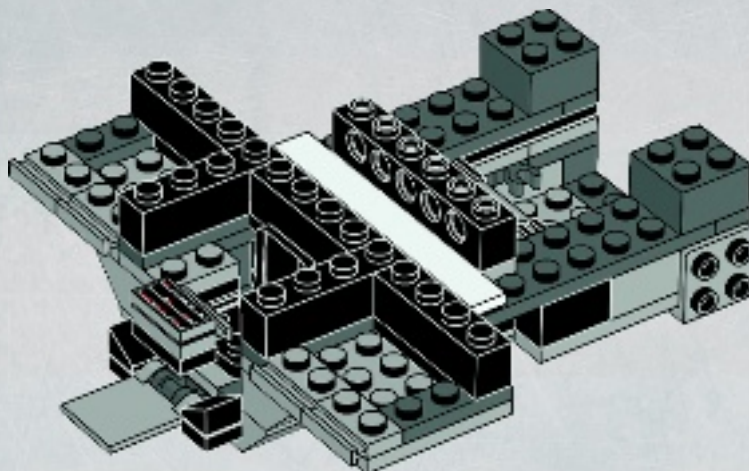



4x



2x

15

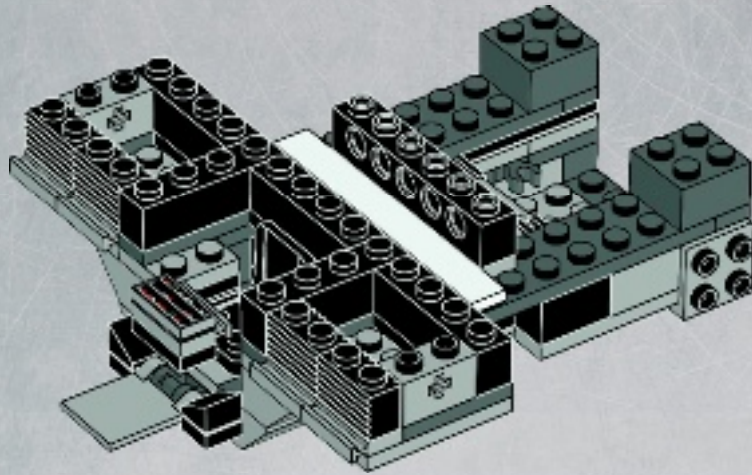

1x



1x



2x



2x



2x

16

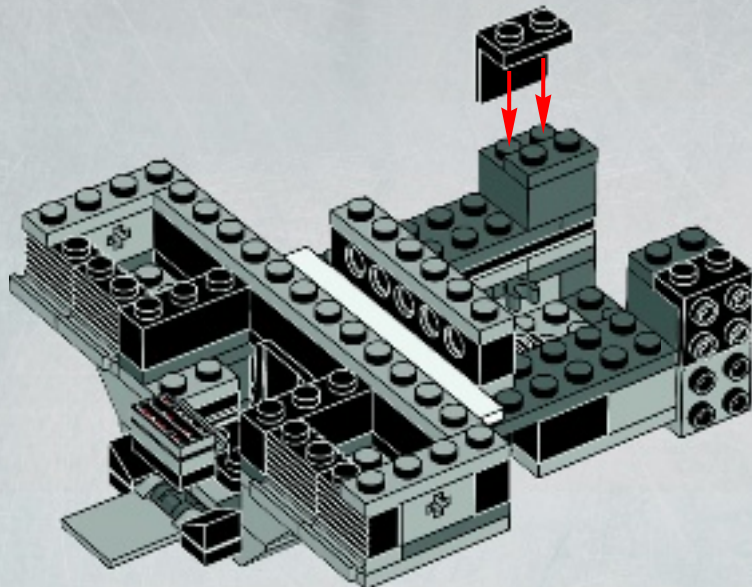



4x



2x

17

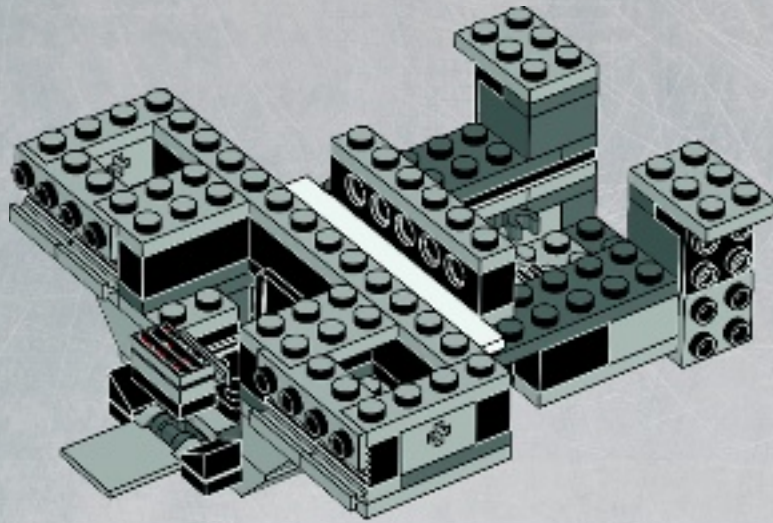

2x



2x

18

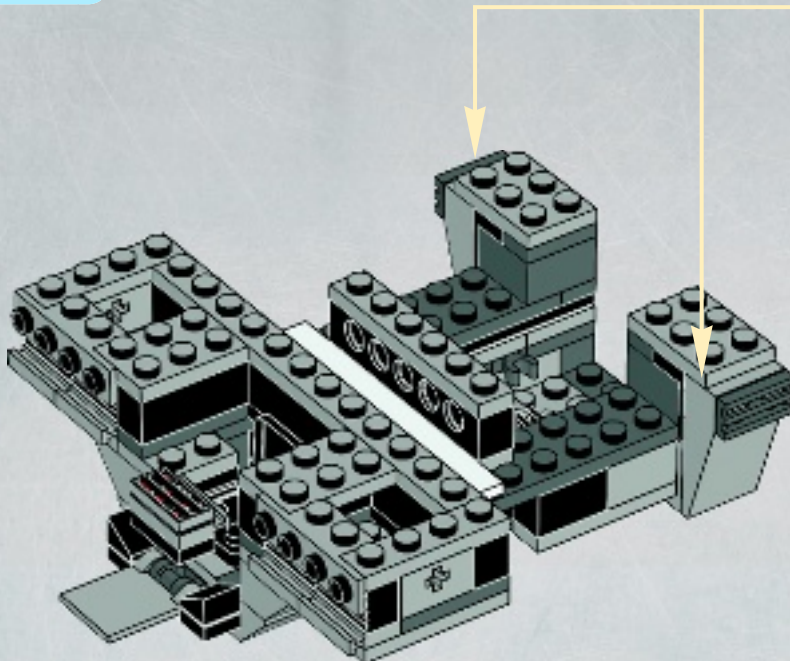

2x

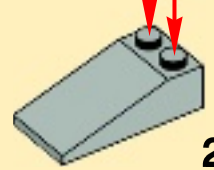

2x

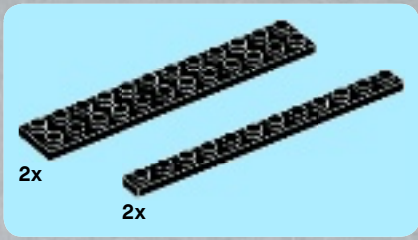

19

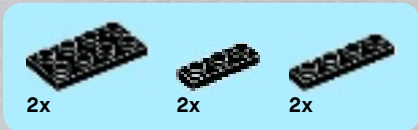
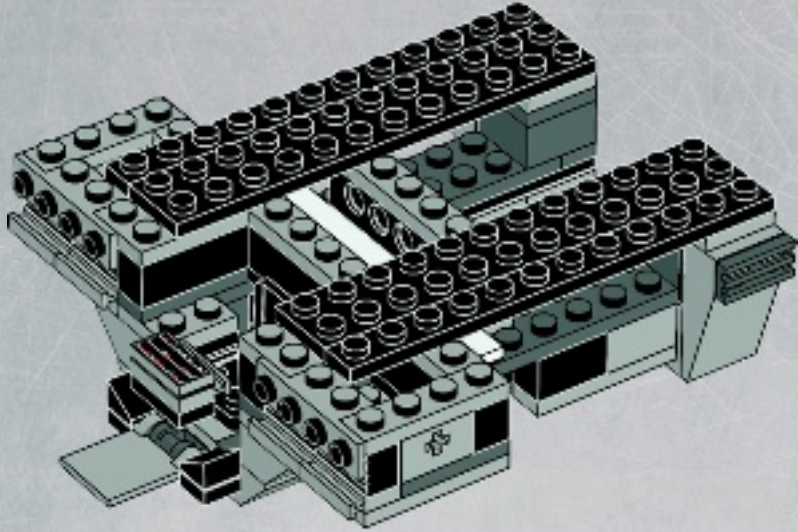

20

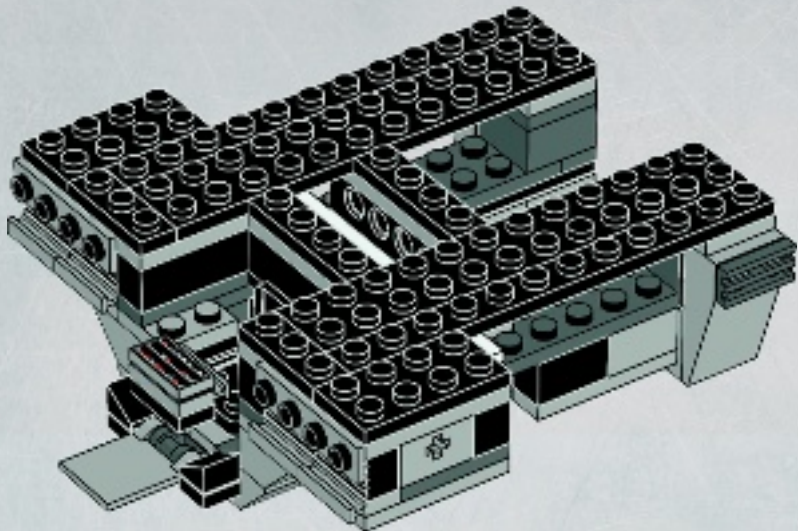



2x



2x

21

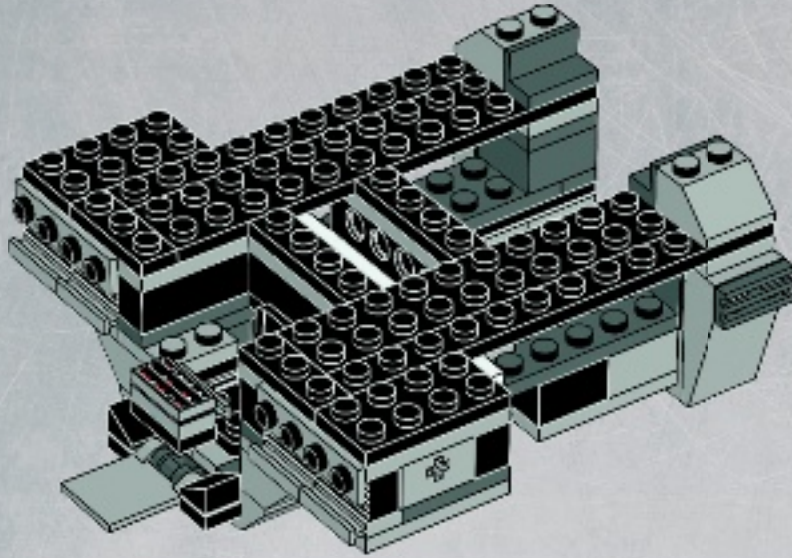

2x



2x

22

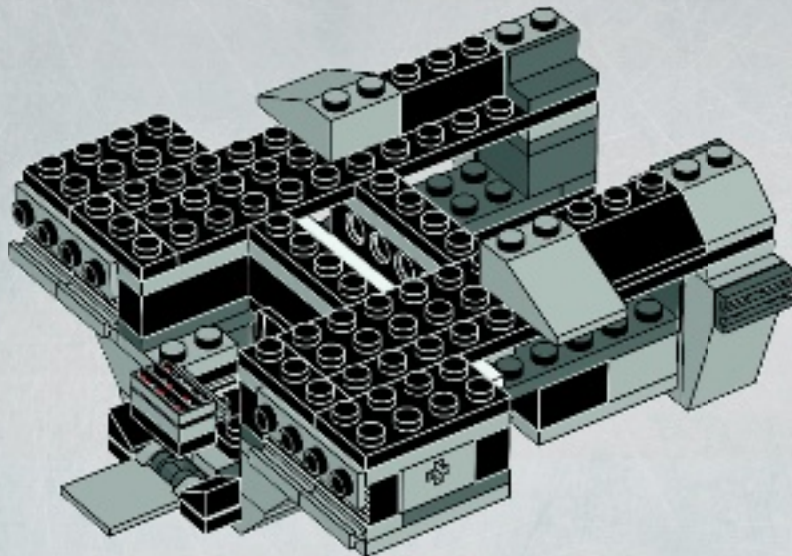

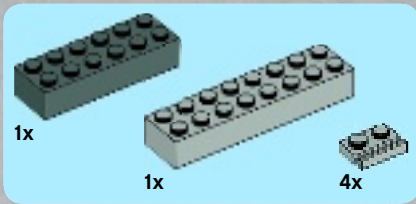

23

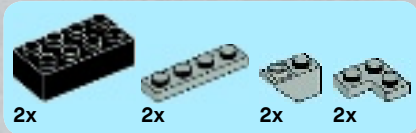
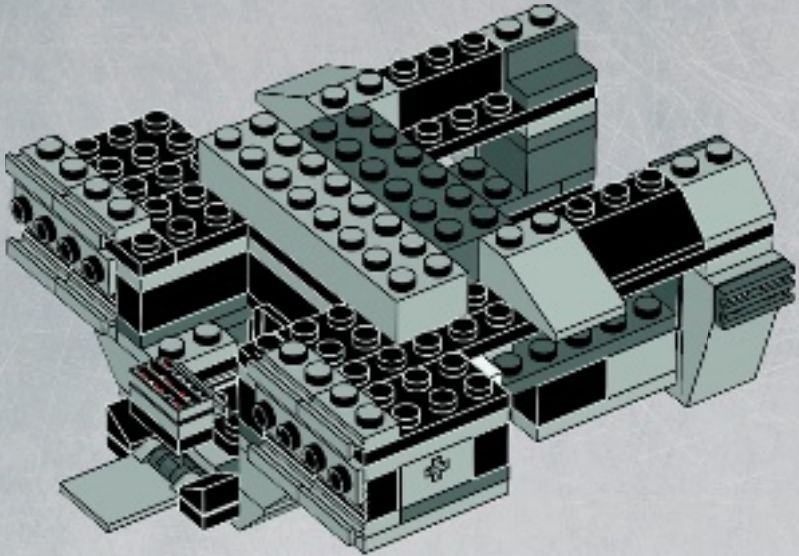

24

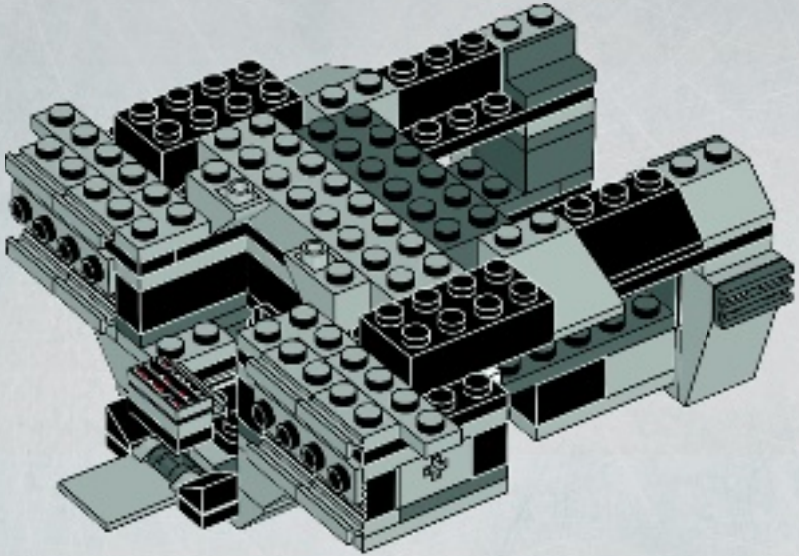



2x

2x

6x

4x

25

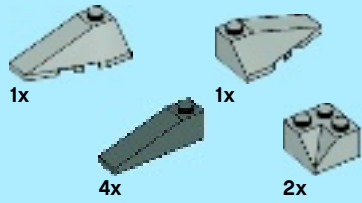
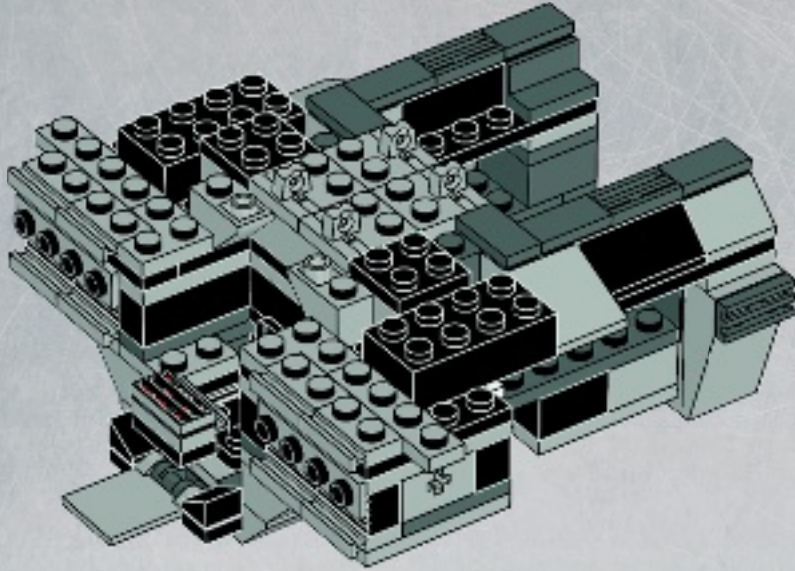

1x

1x

4x

2x

26

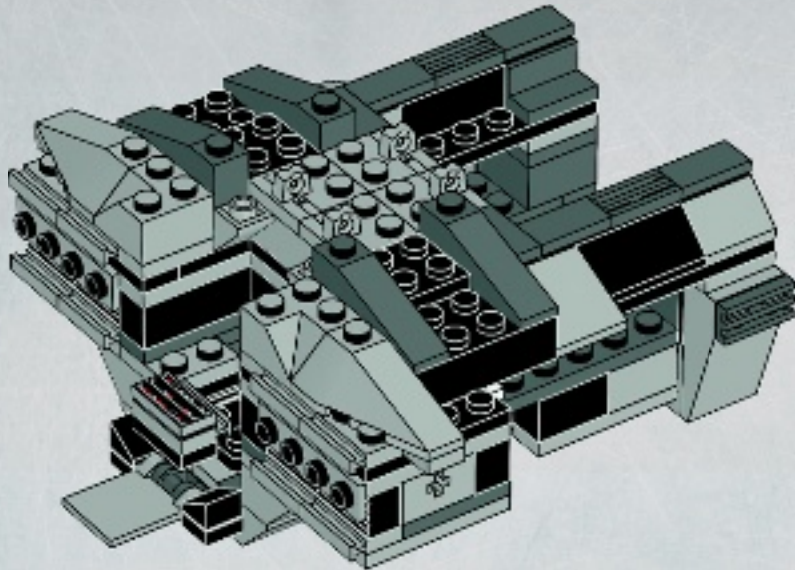



1x



8x



1x



2x

27

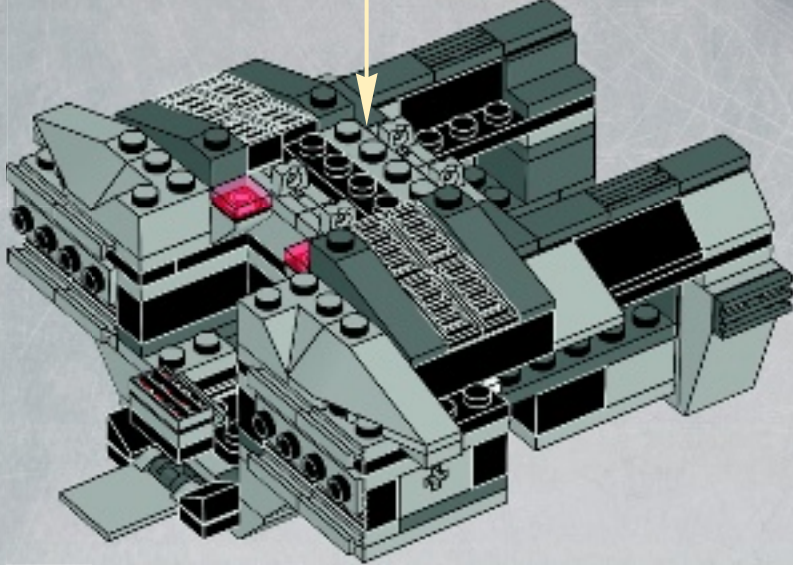

1x



2x

28

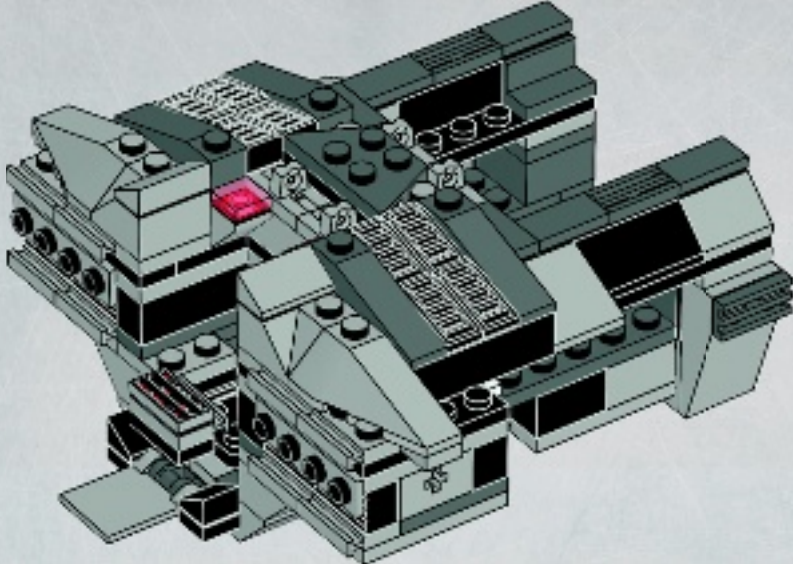



1x



2x



1x

29

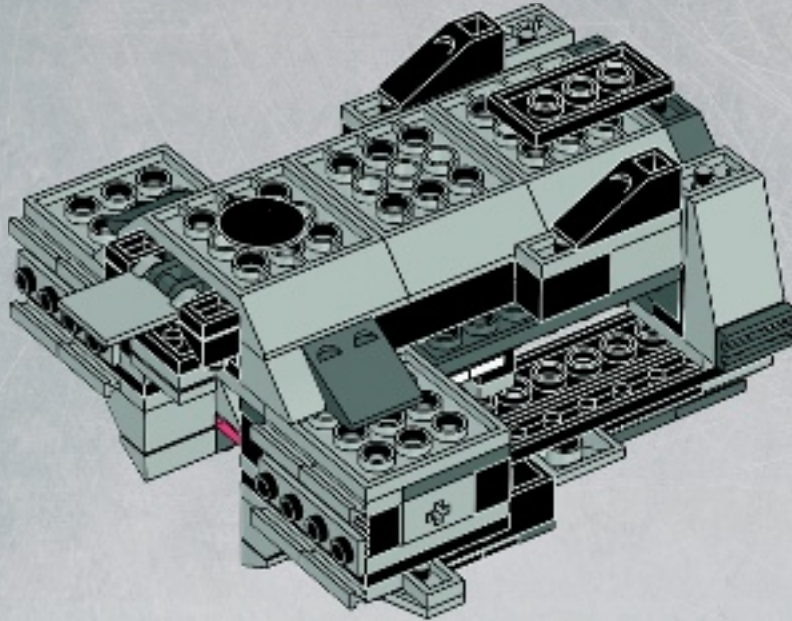

1x



1x



2x

30

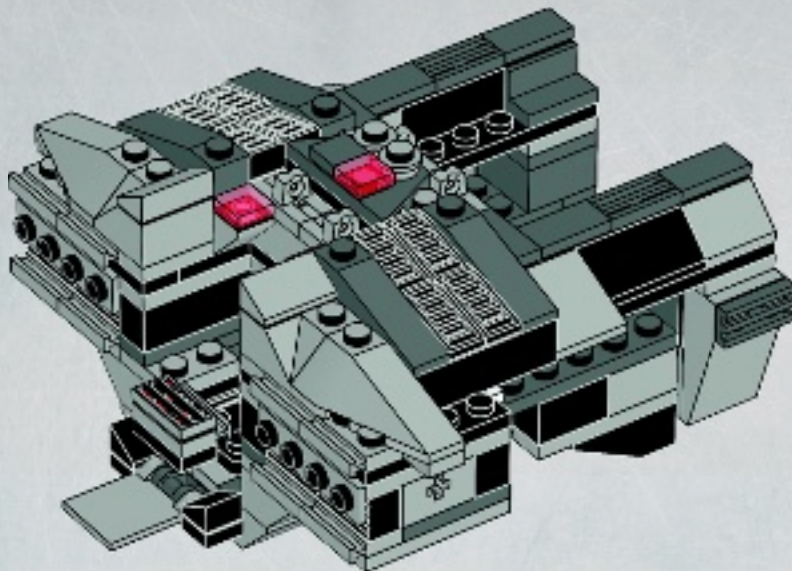

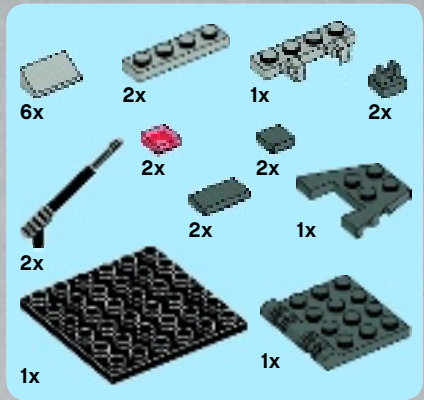

31

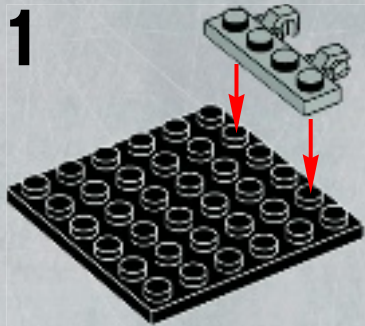

2



4

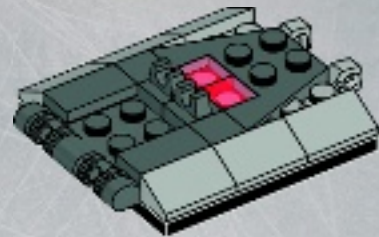

3

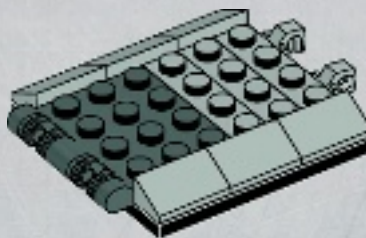

5

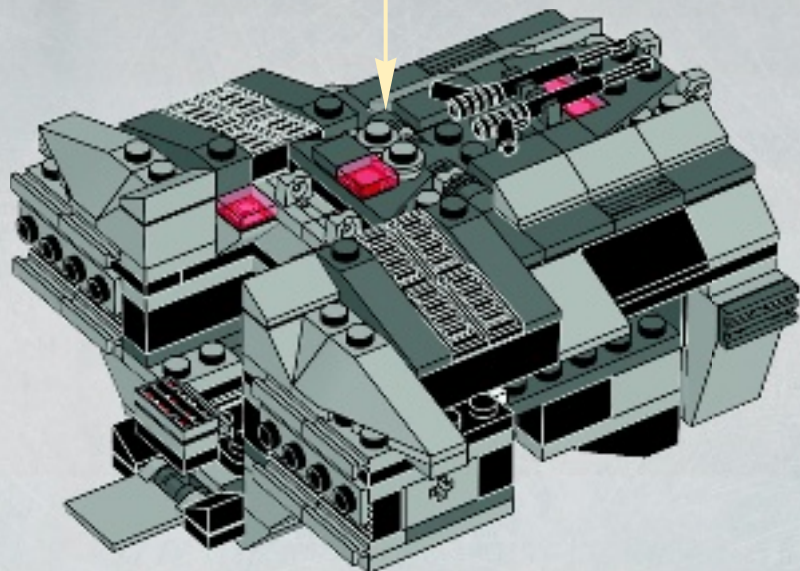
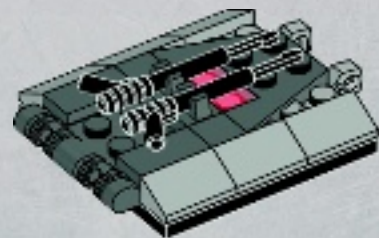



1

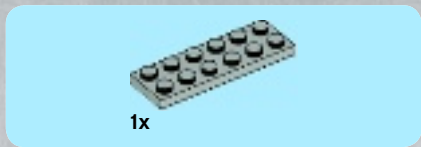
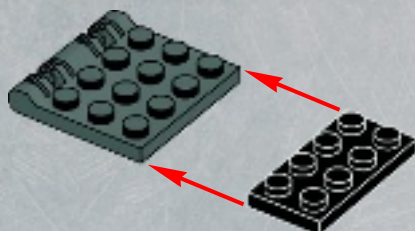

2

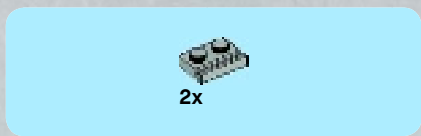

3

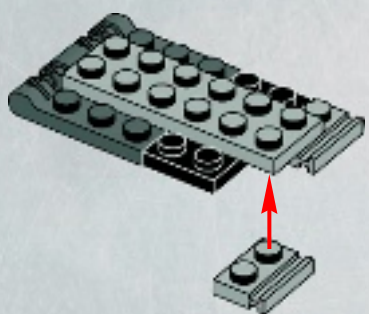

4

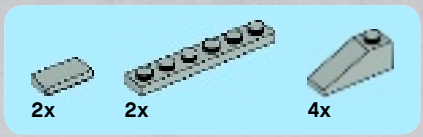
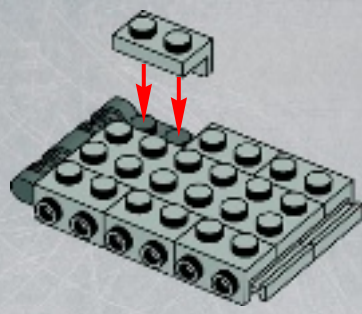

5

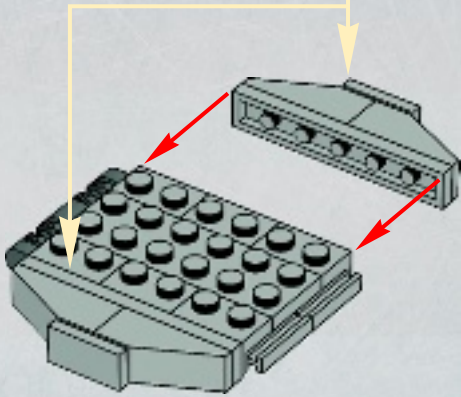
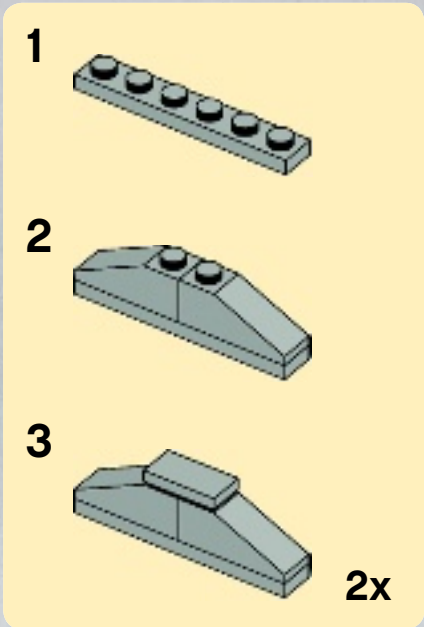



2x



2x



2x

6



2x

7



32

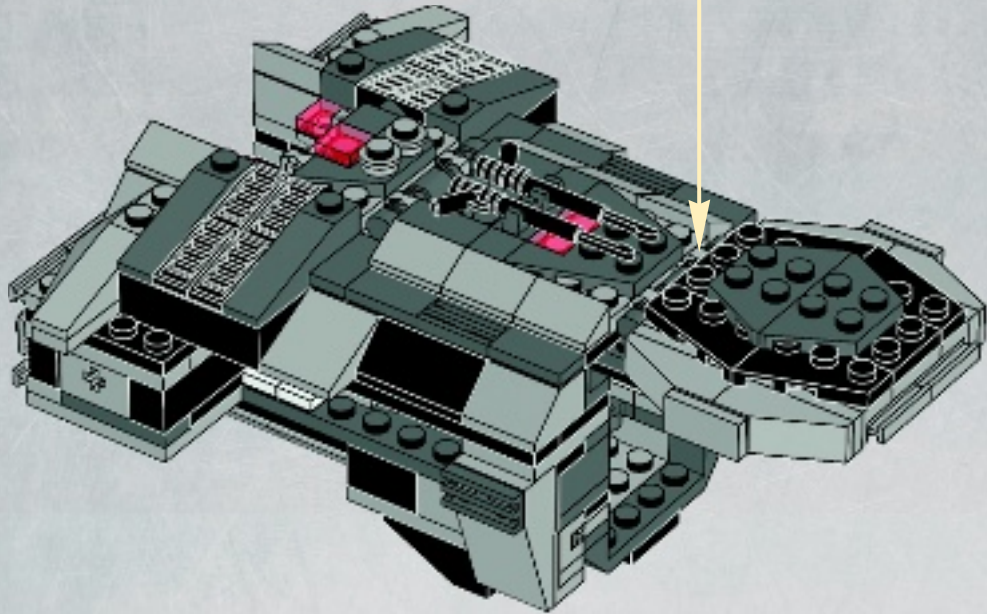



2x



2x

33

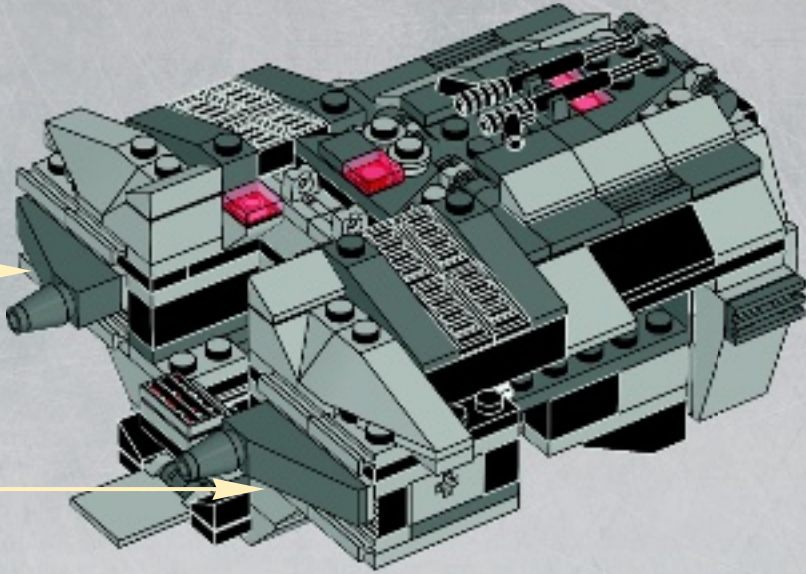

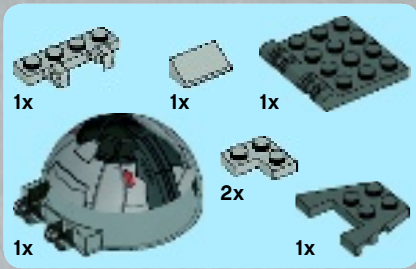

34

1



2



3



4



5

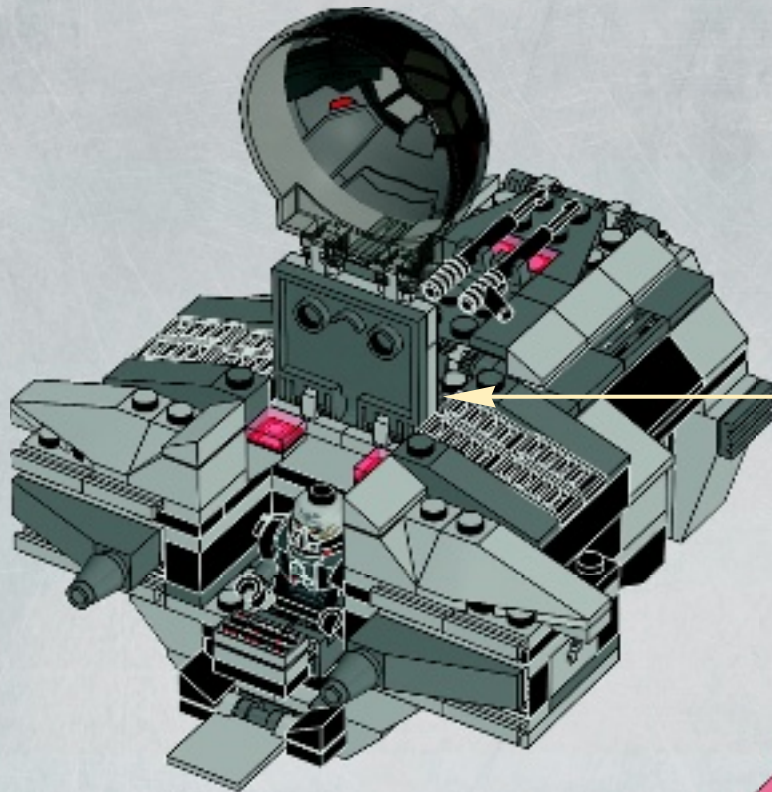
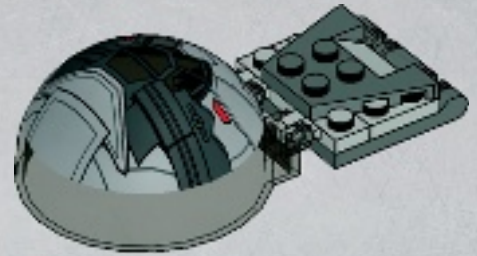

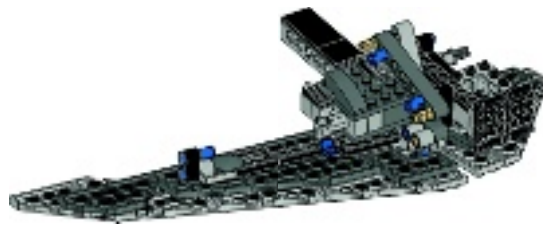

1x

1

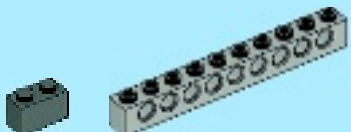

1x

2x

2

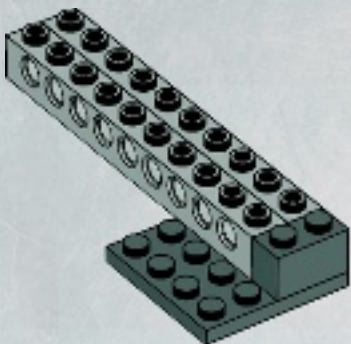

2x

3

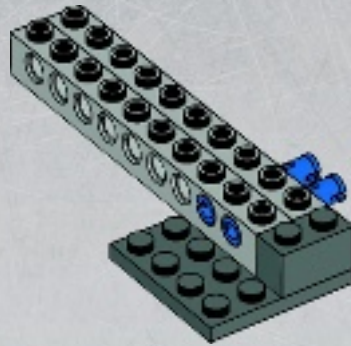

1x



1x

4

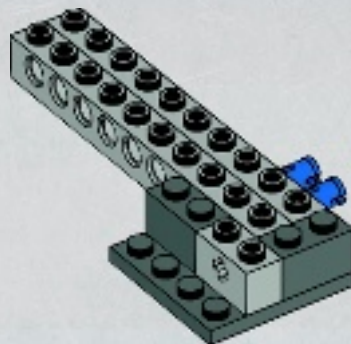



3x

5

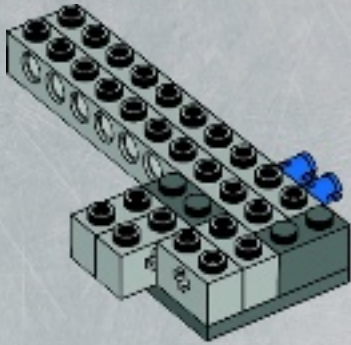

2x



1x



1x

7

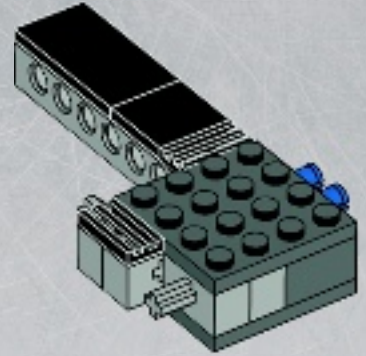

2x



1x

6

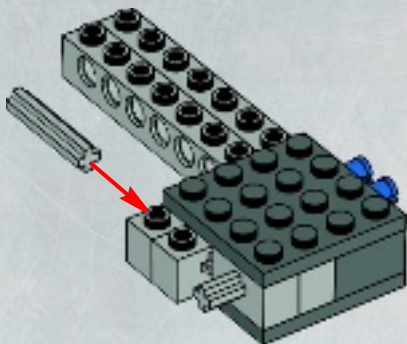

1x



1x



1x



1x

8

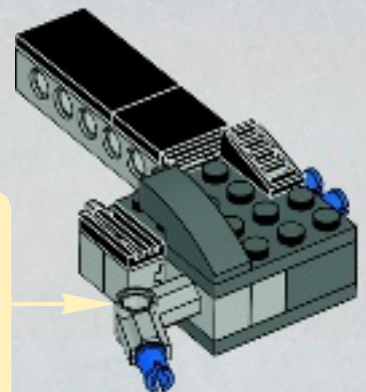
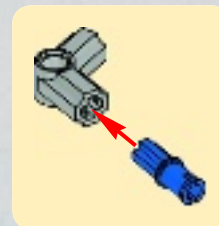

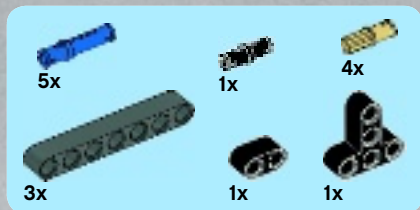

9

1



2



3

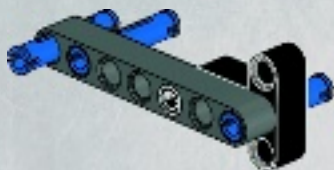

4

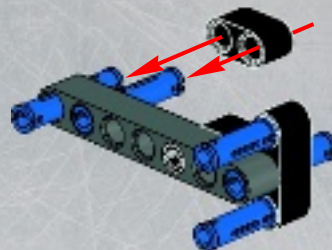

5

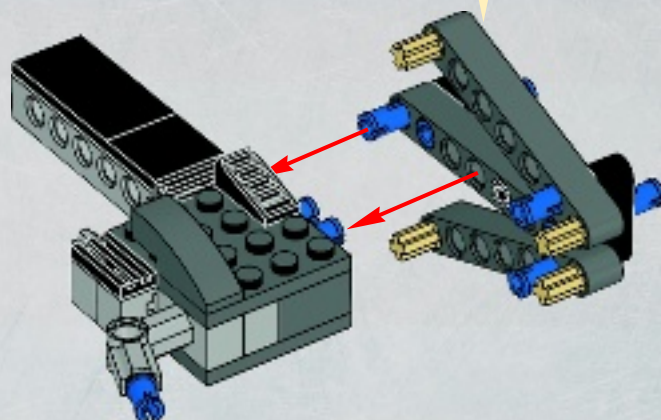
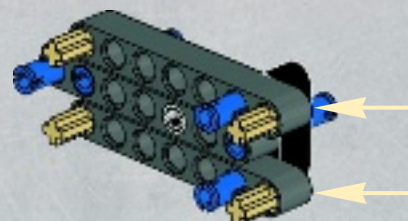
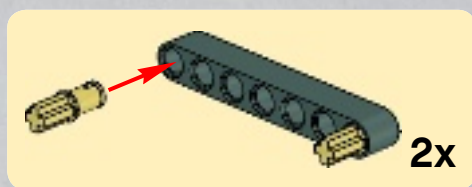



10

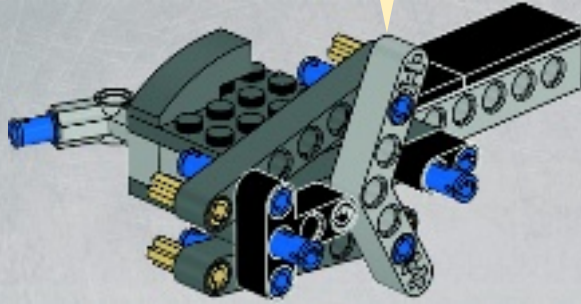
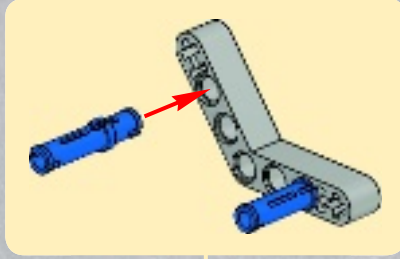

11

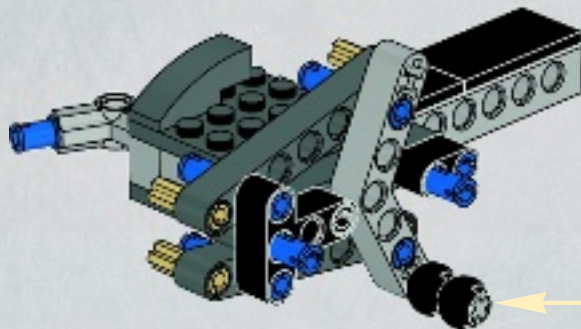

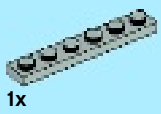

1

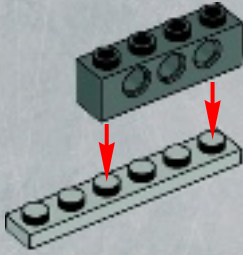

2

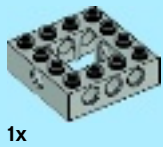
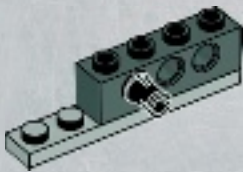

3

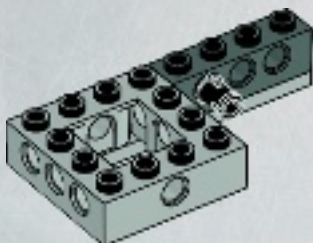

4

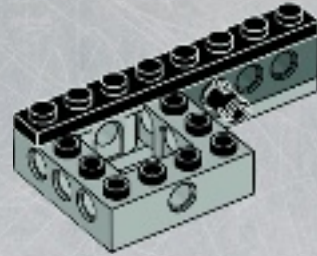

5

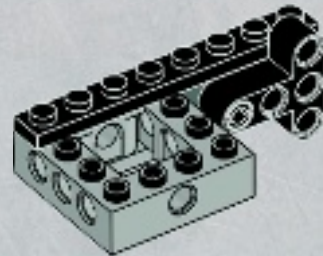

6

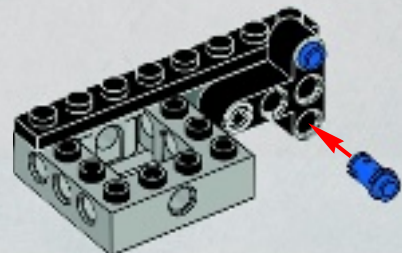

1x



1x

7

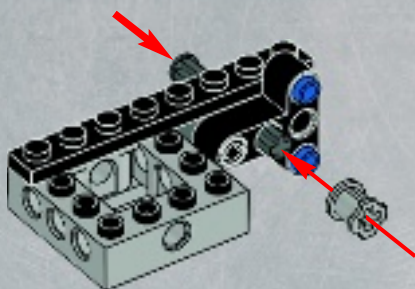

4x



2x

8

1



2



2x

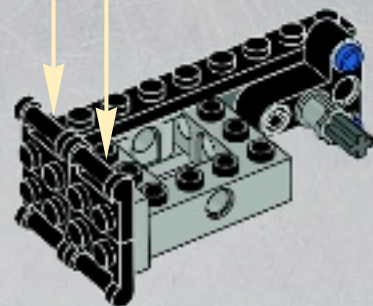

12

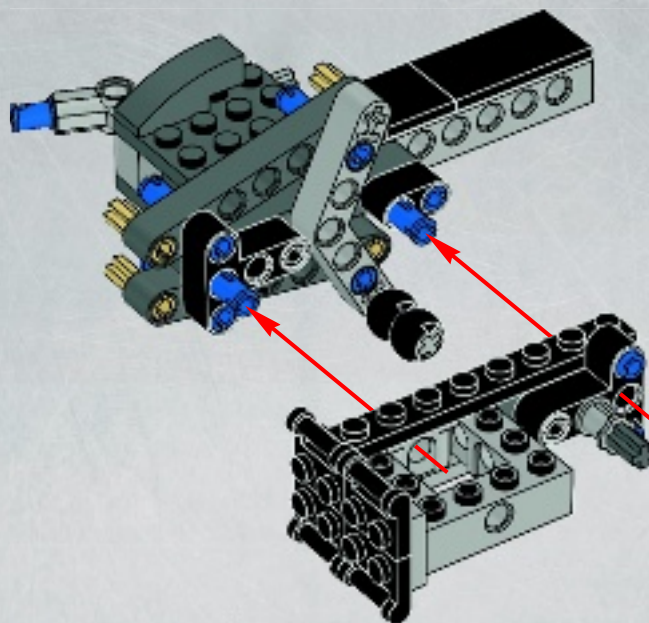

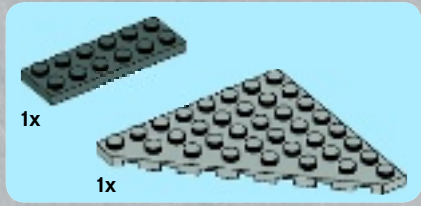

1

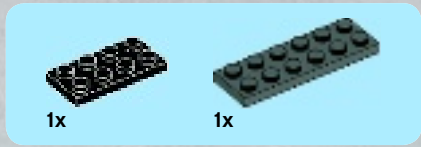
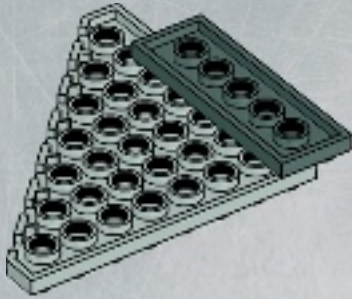

2

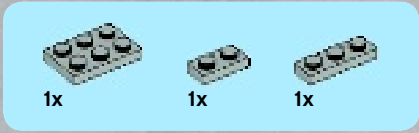
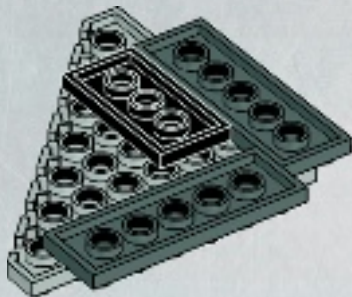

3

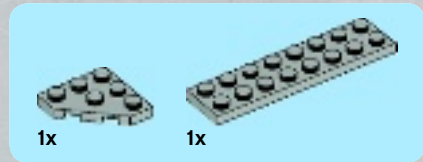
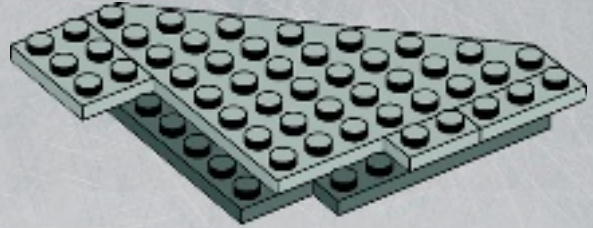

4

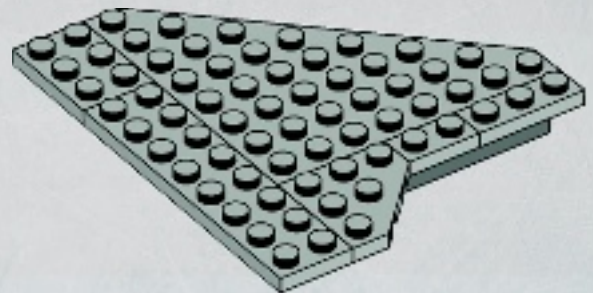



1x



2x

5

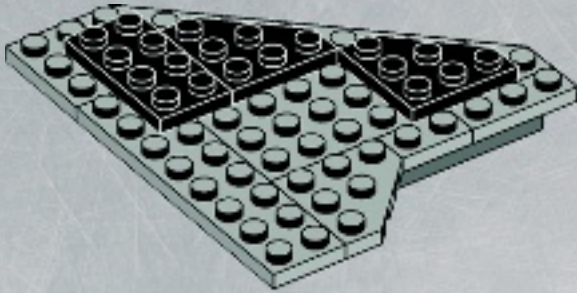

1x



1x

7

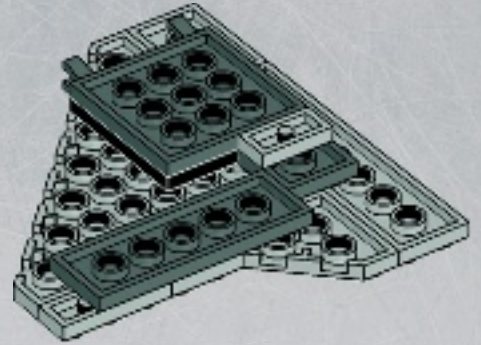

1x



2x



1x

6

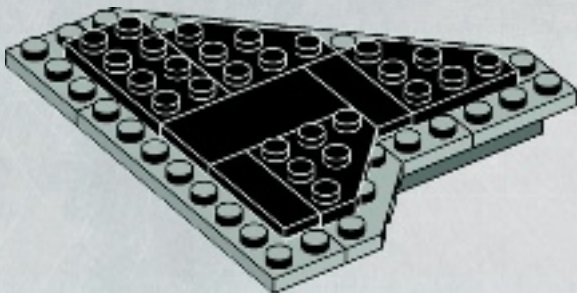

1x



1x



1x

8

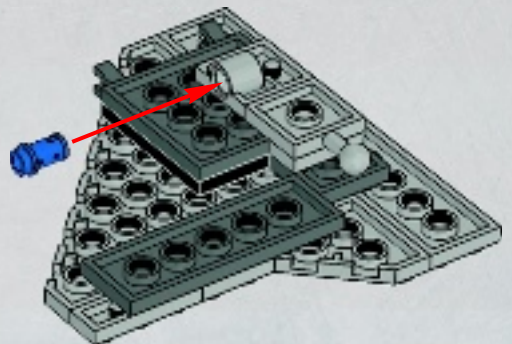

13

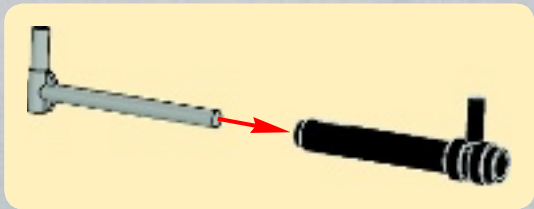
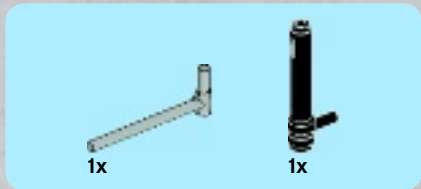
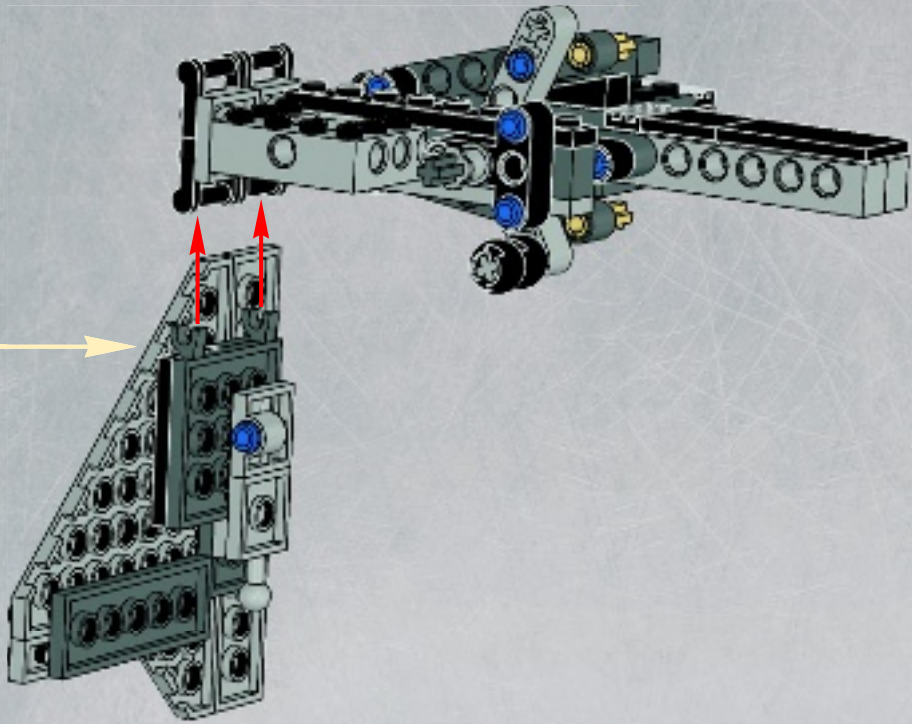

14

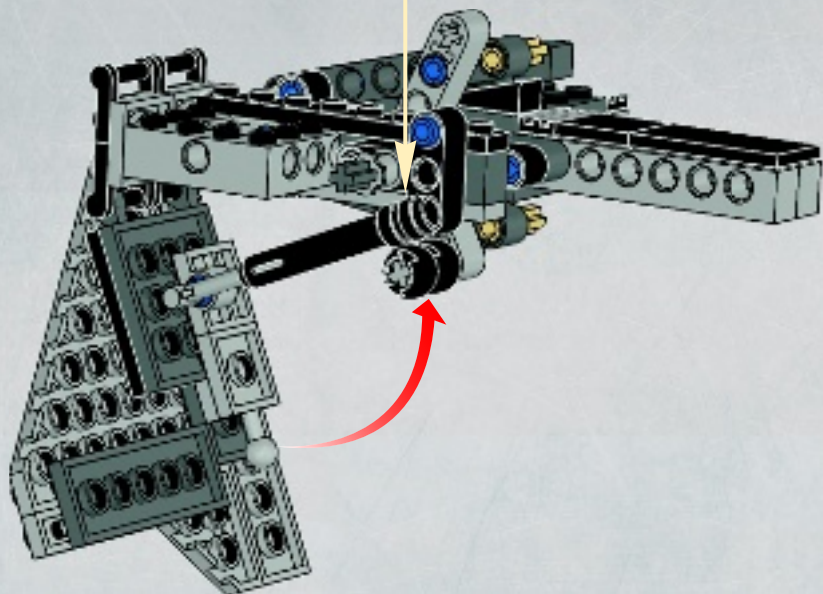

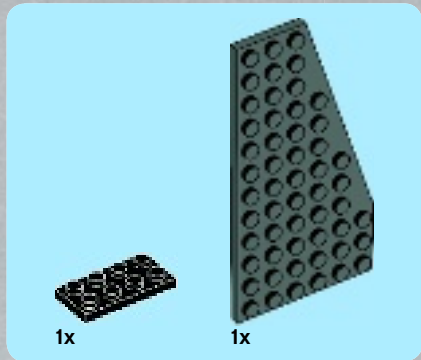

1



2

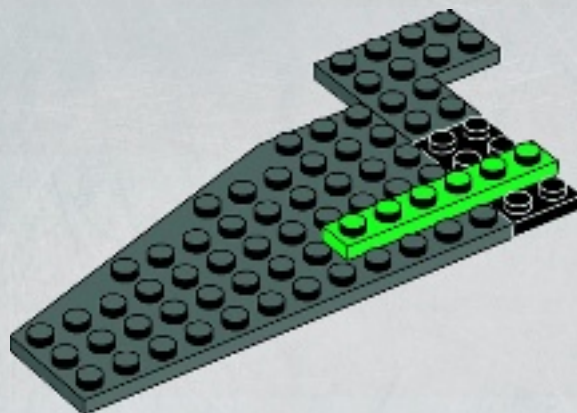

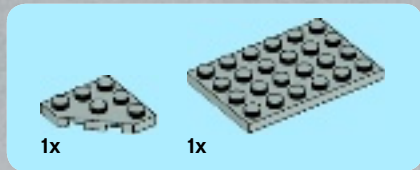

3

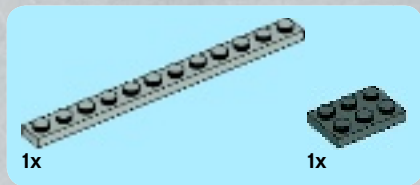
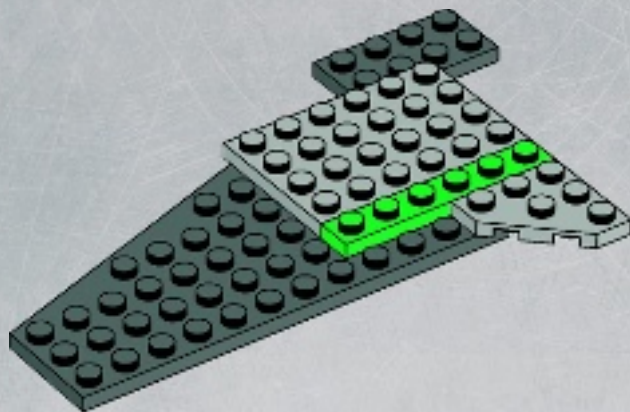

4

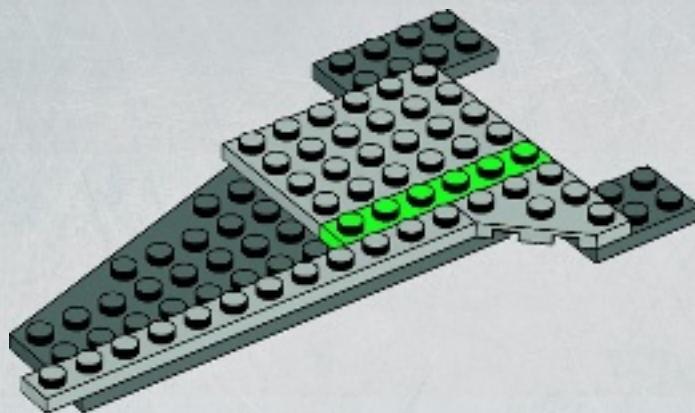

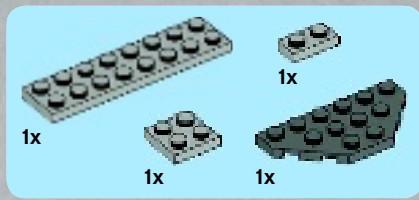

5

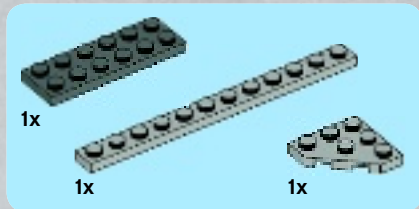
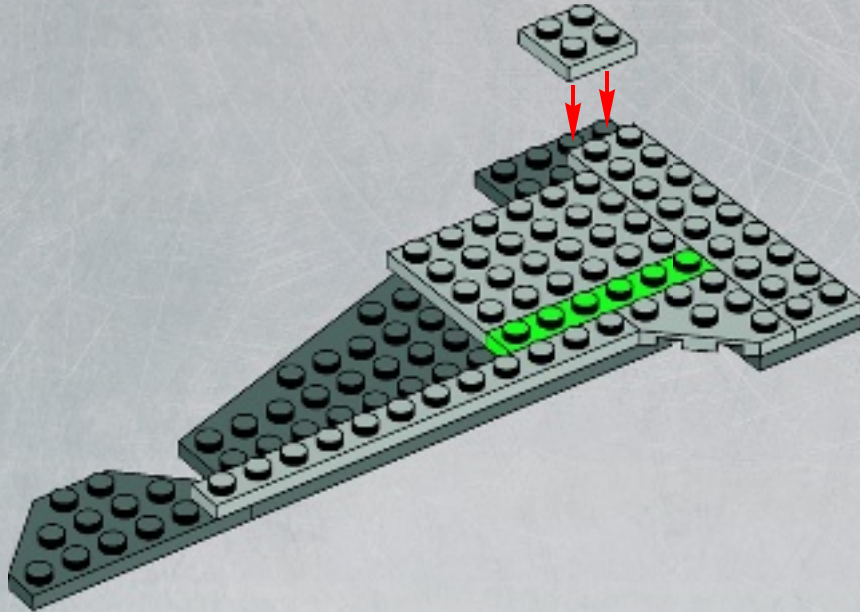

6

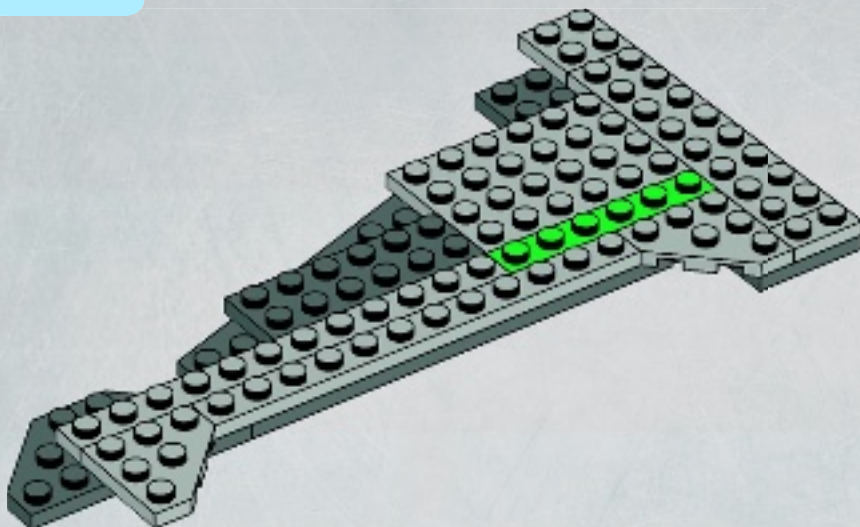

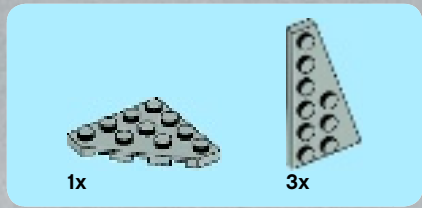

7

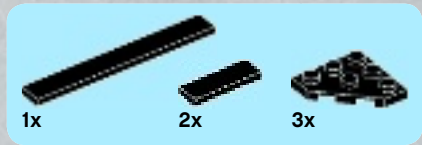
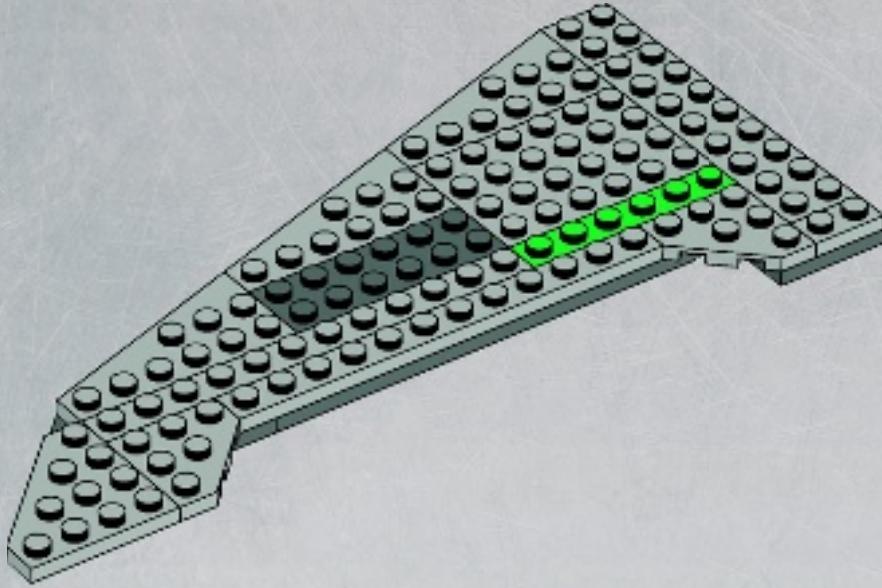

8

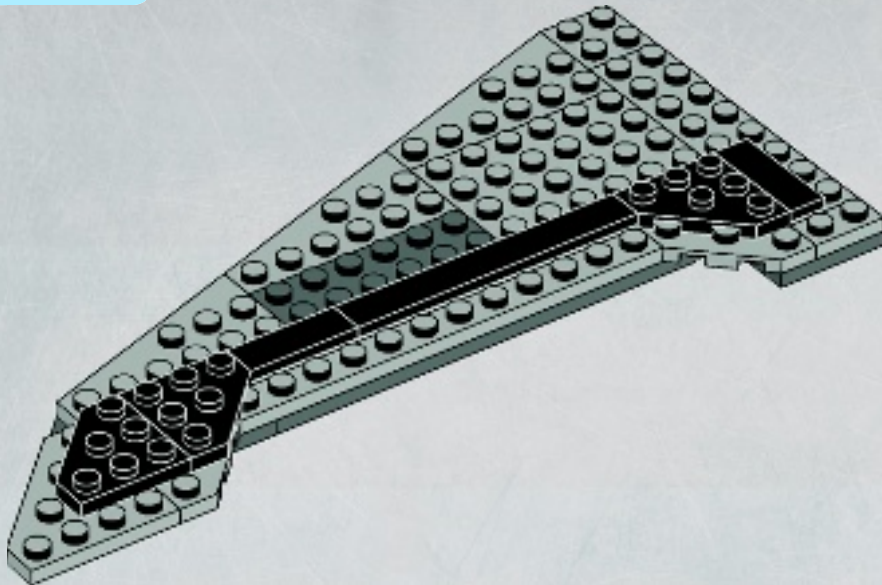

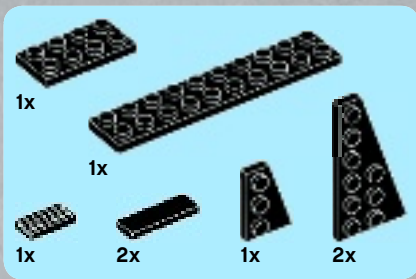

9

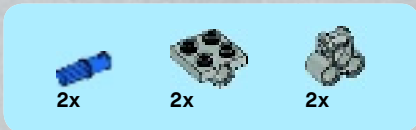
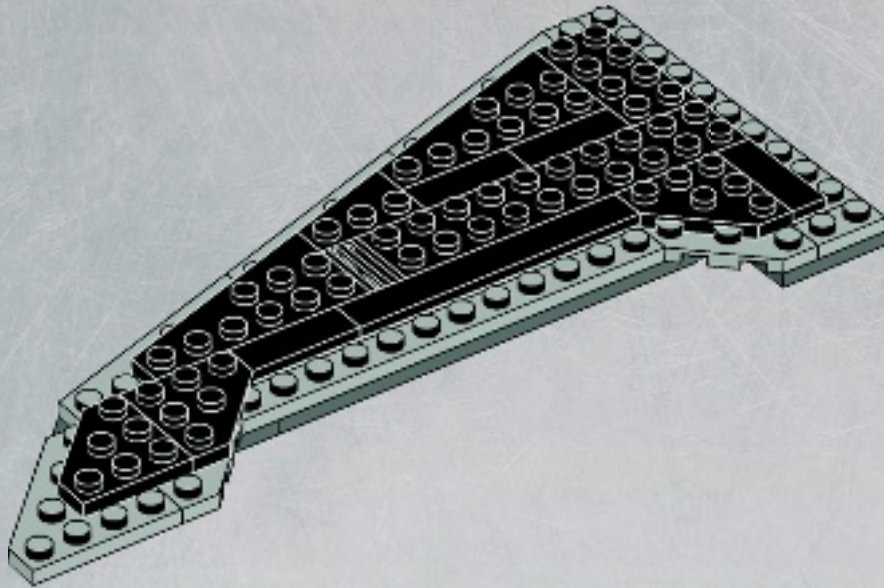

10

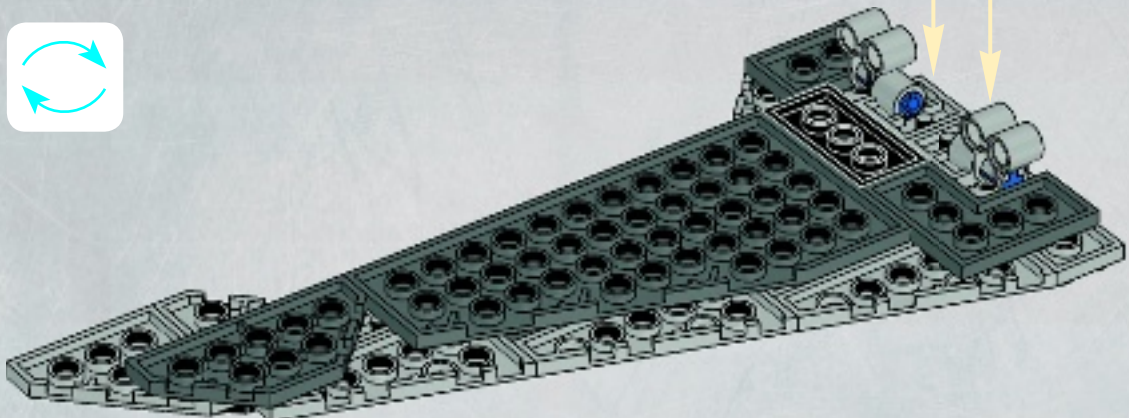
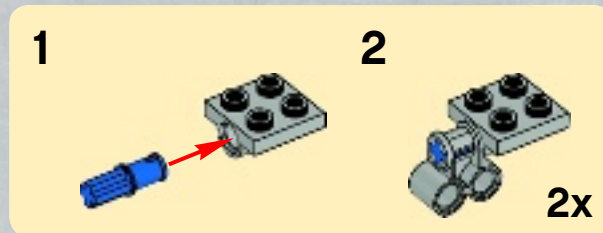



11

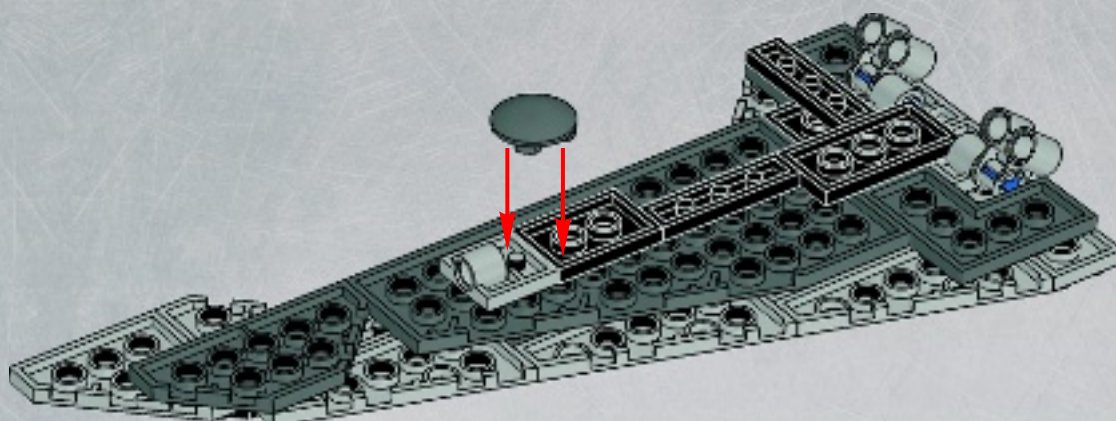

12

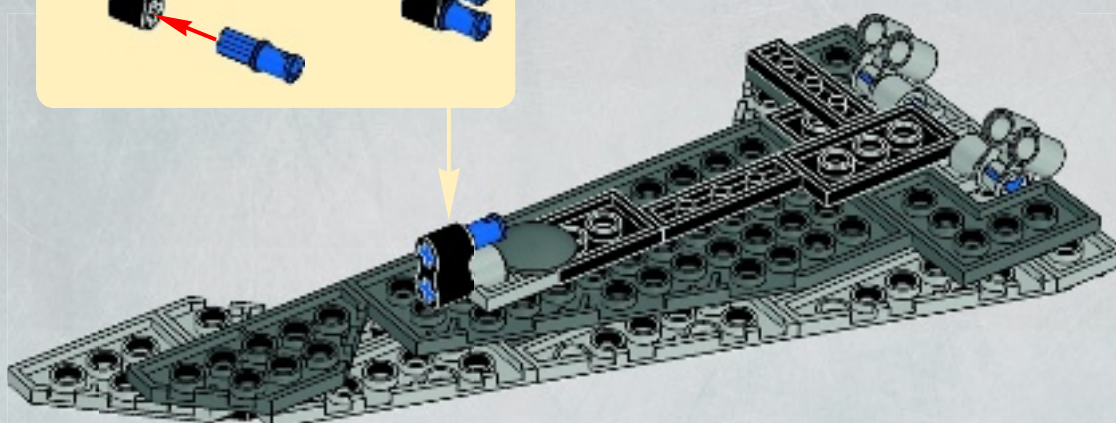
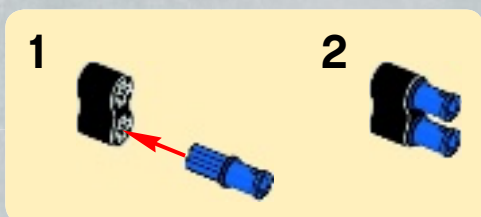

15

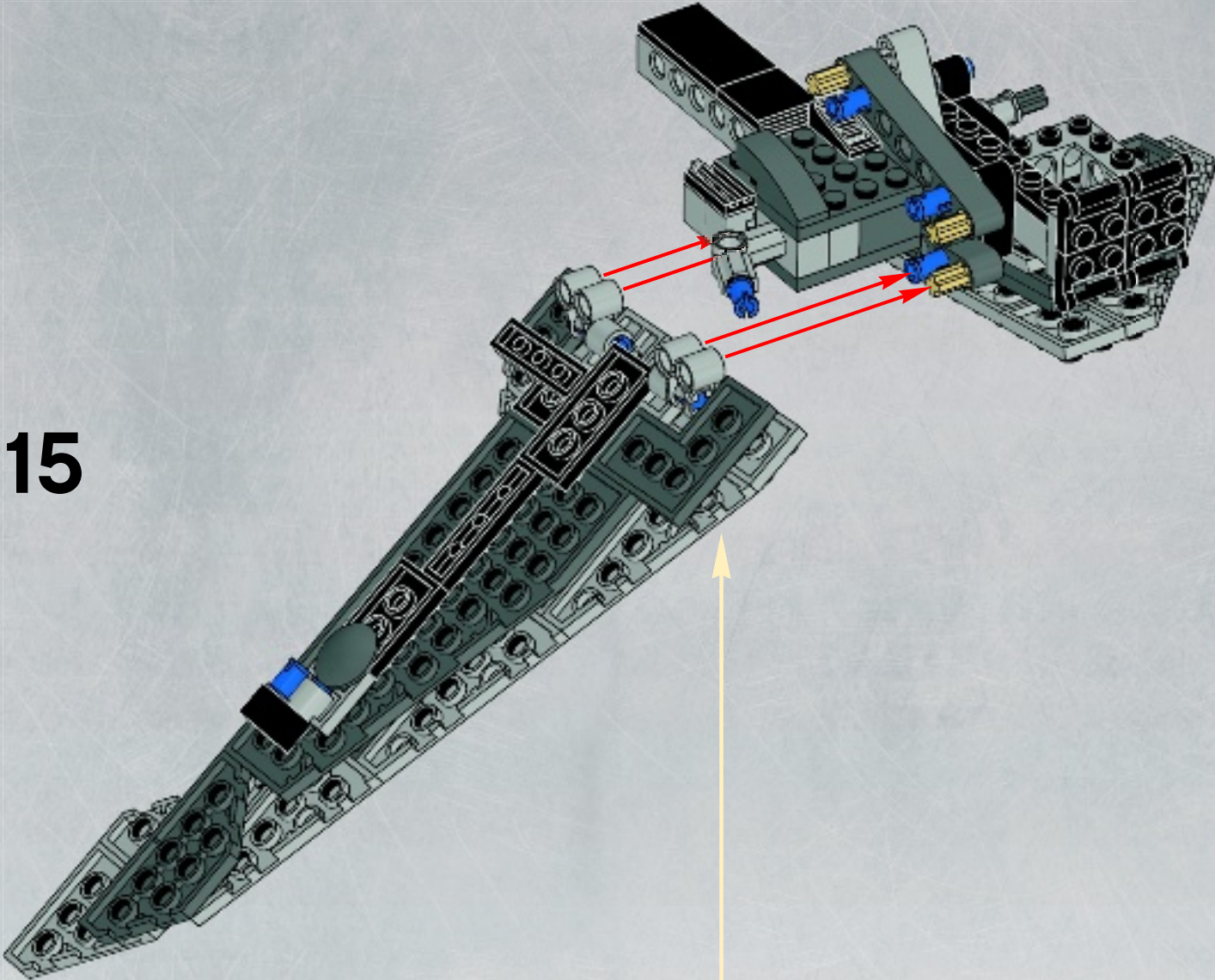

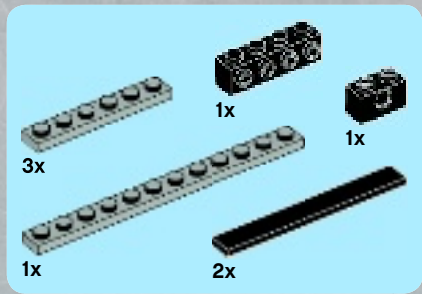
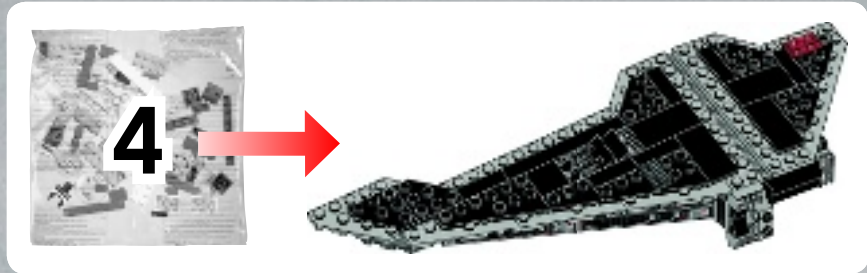

16

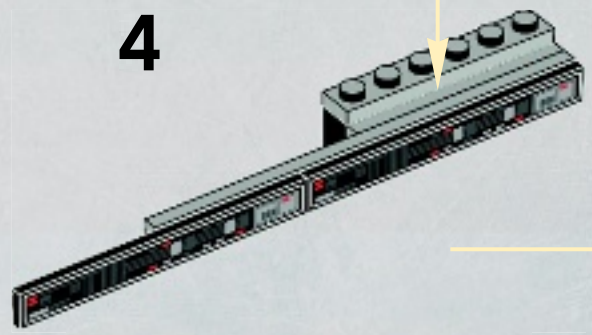
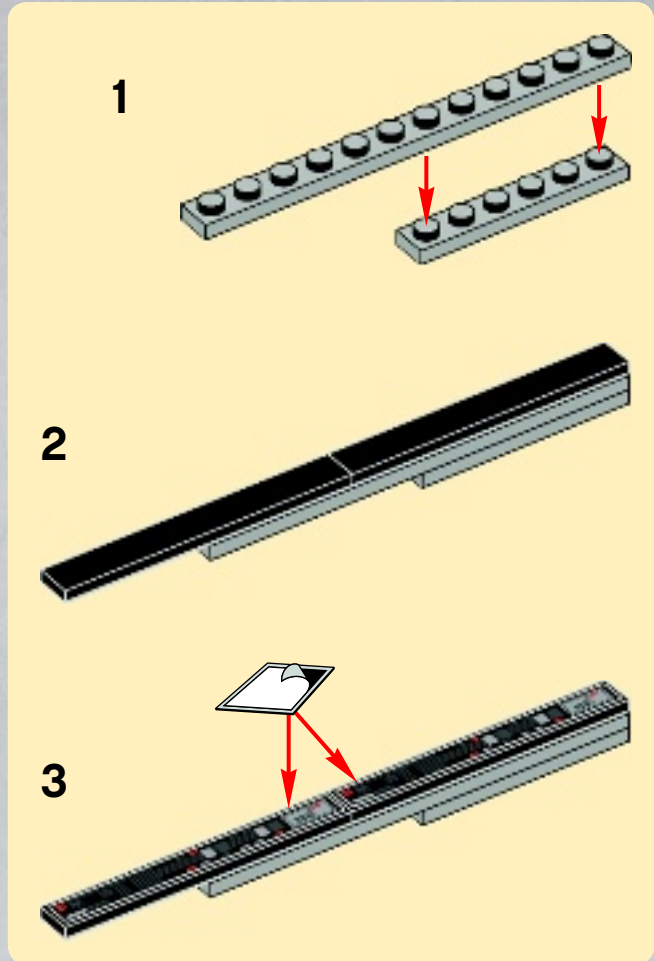
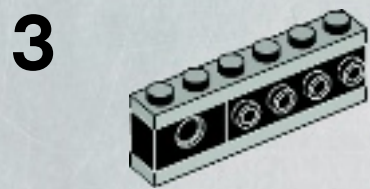
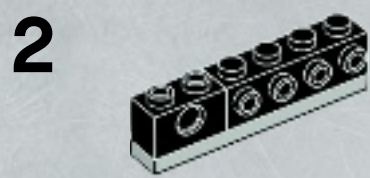
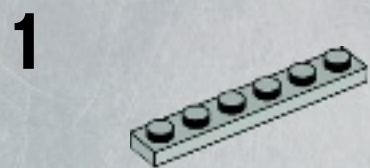

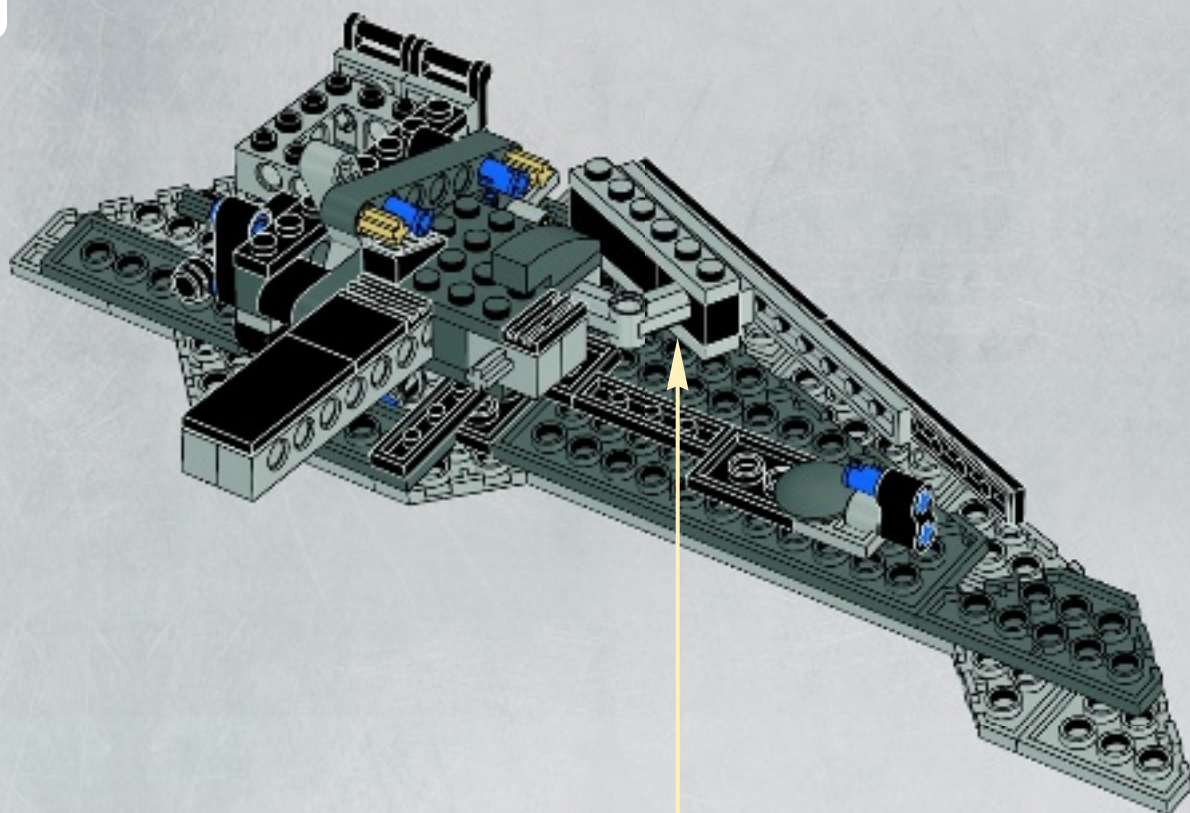
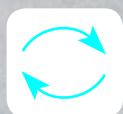

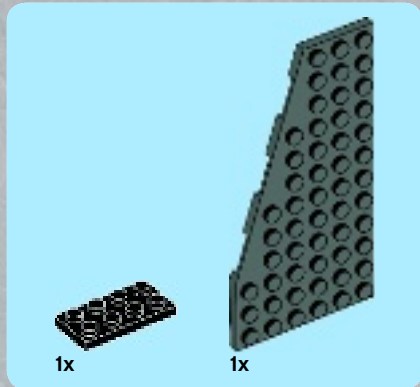
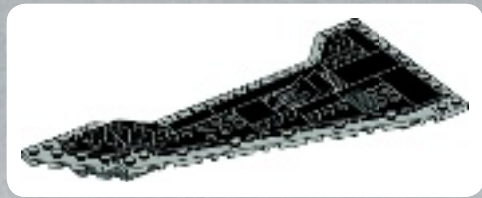

1

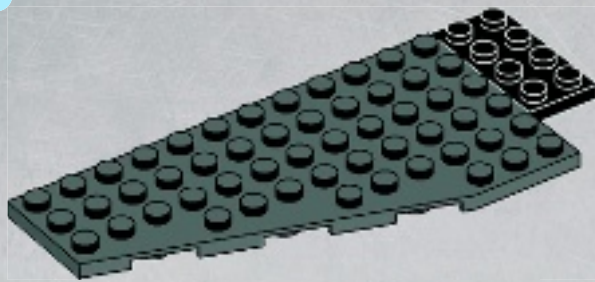

2

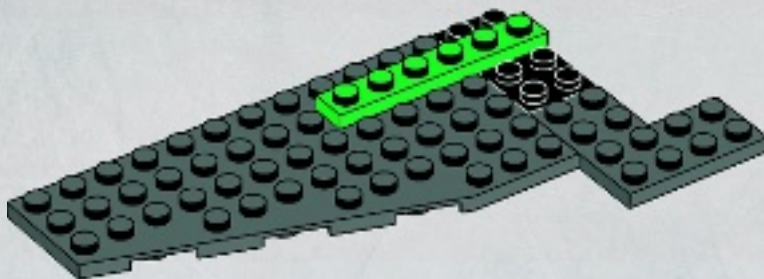

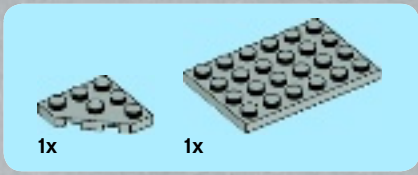

3

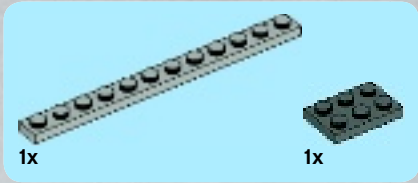
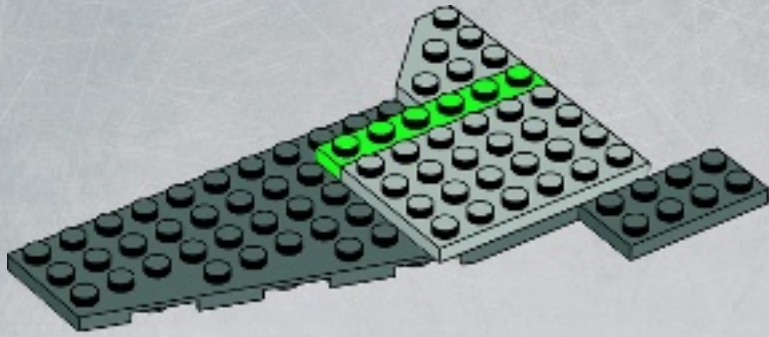

4

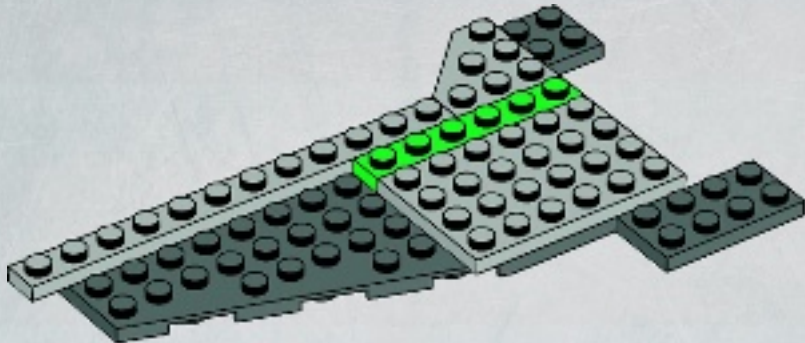

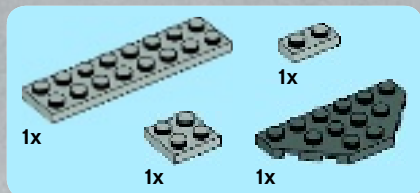

5

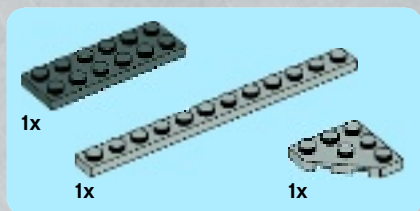
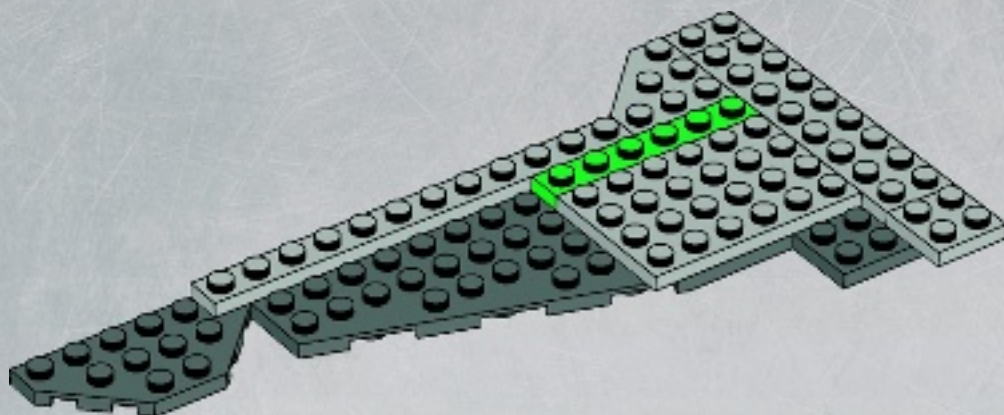

6

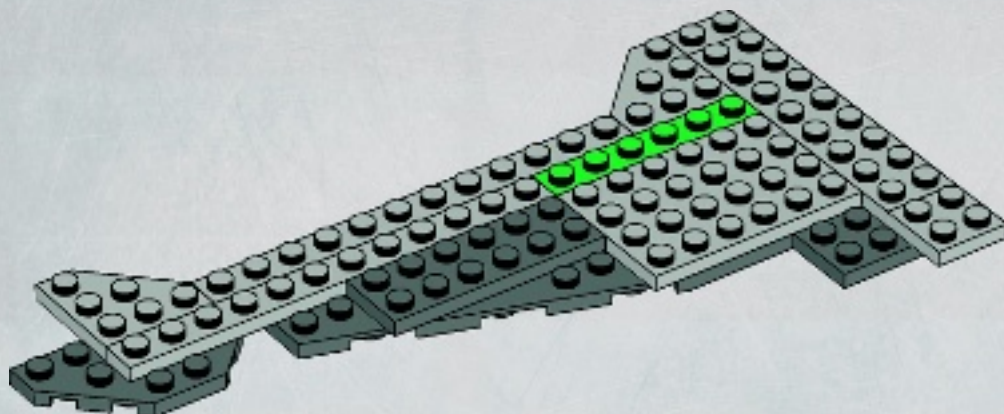

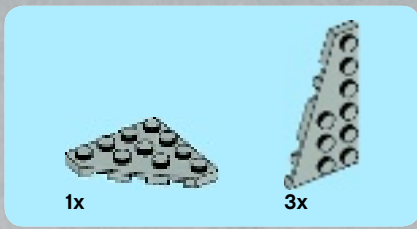

7

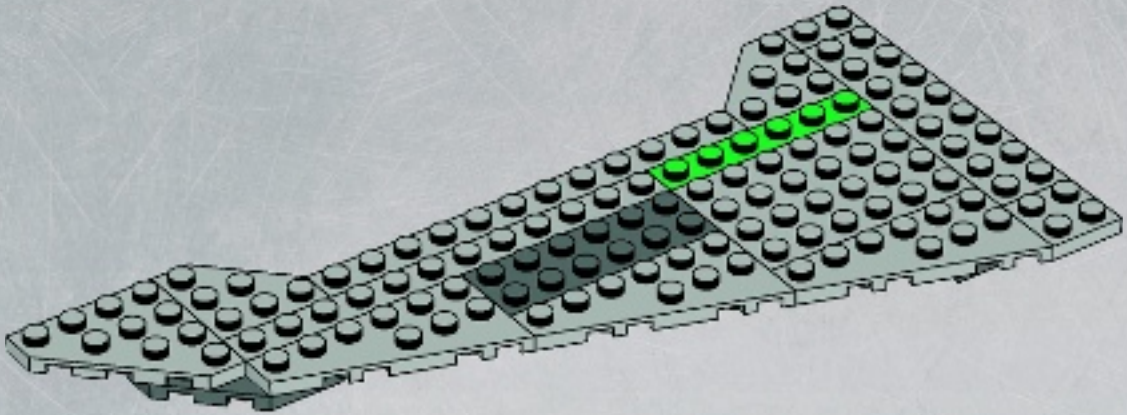

8

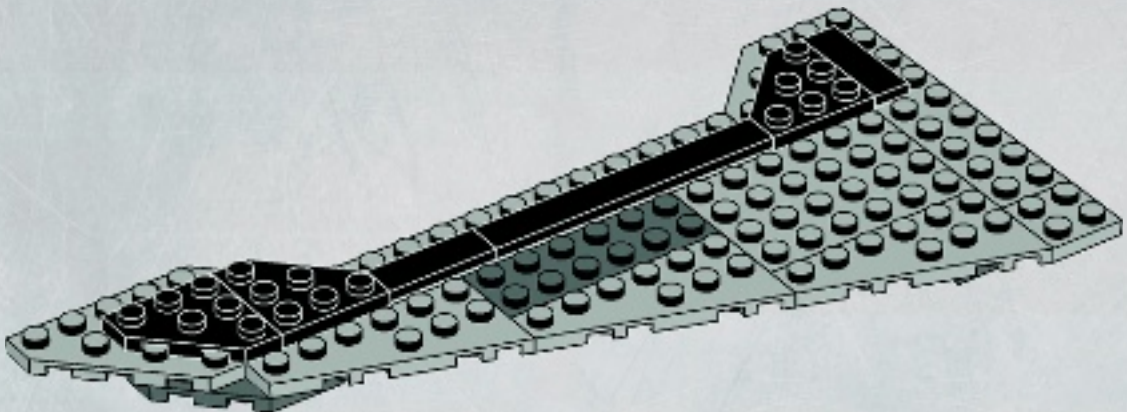

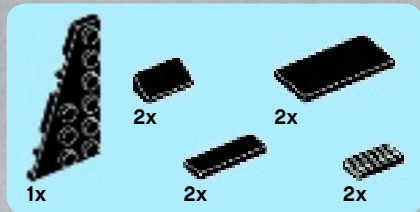

9

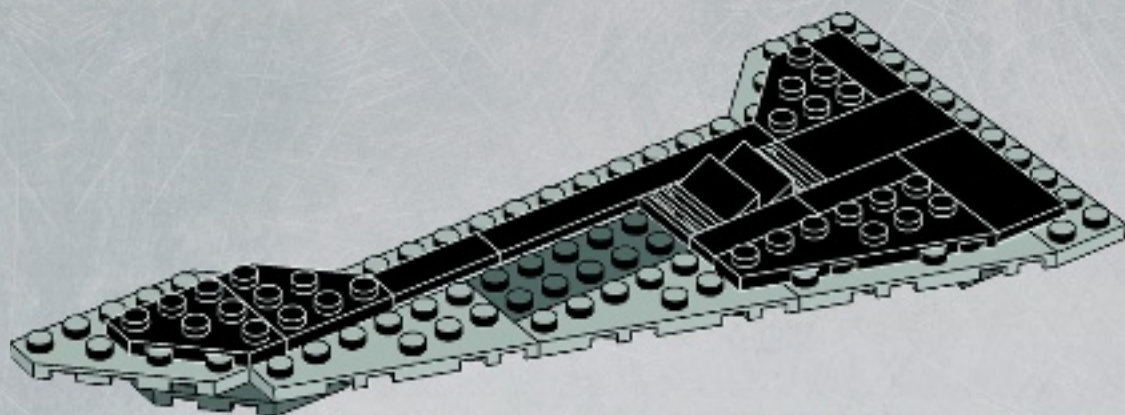

10

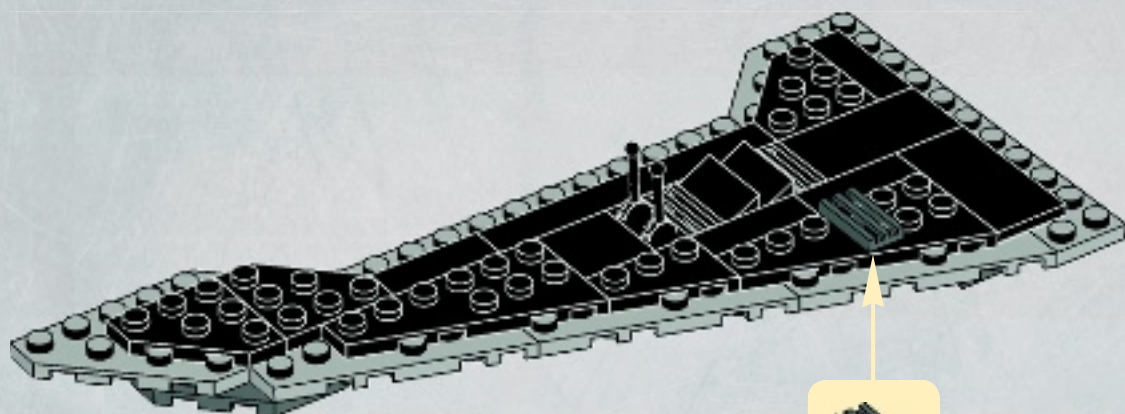

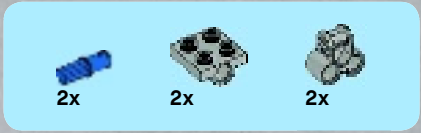

11

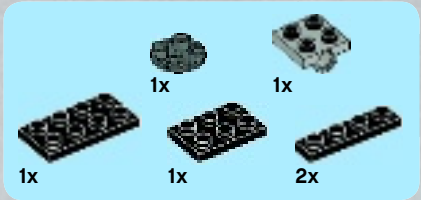
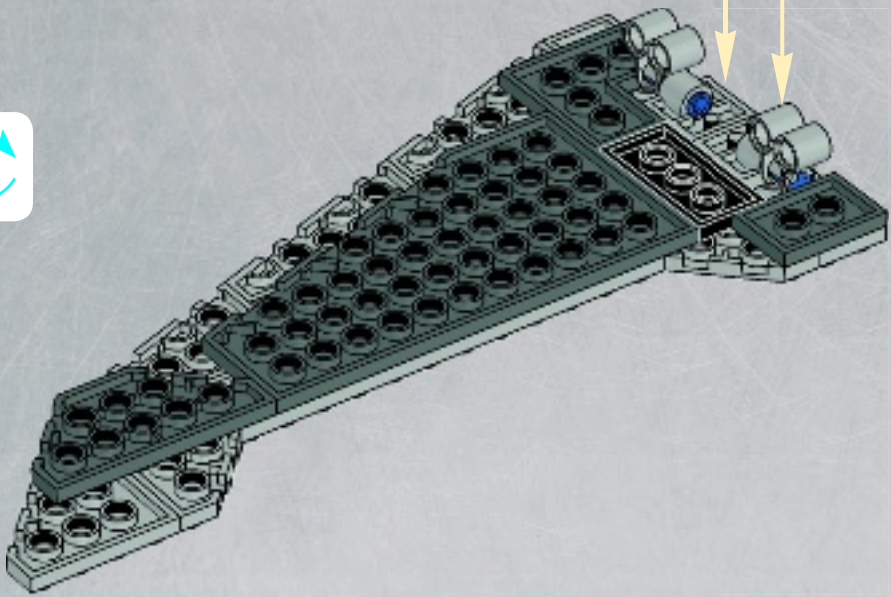
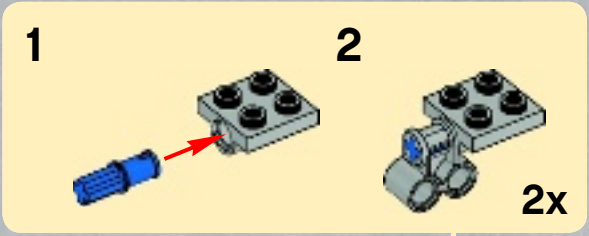

12

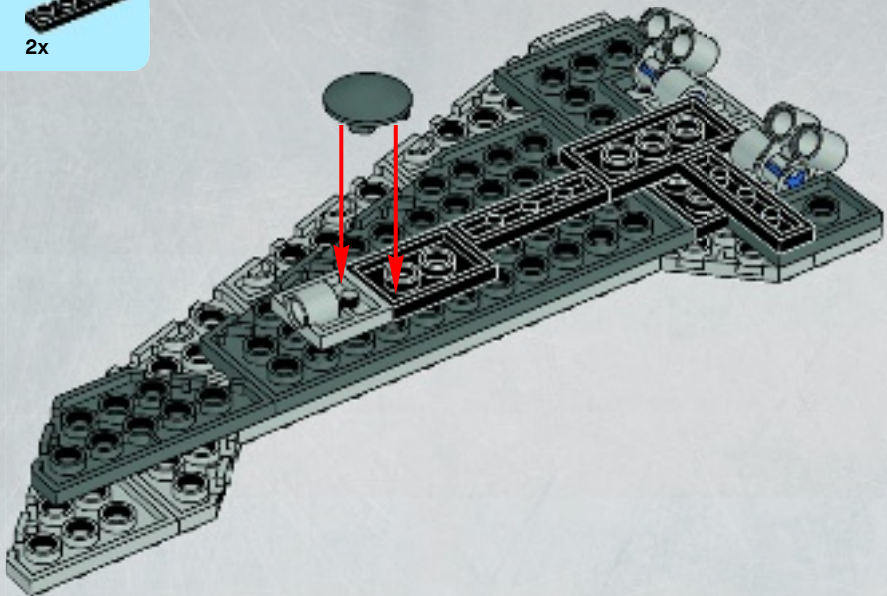

17

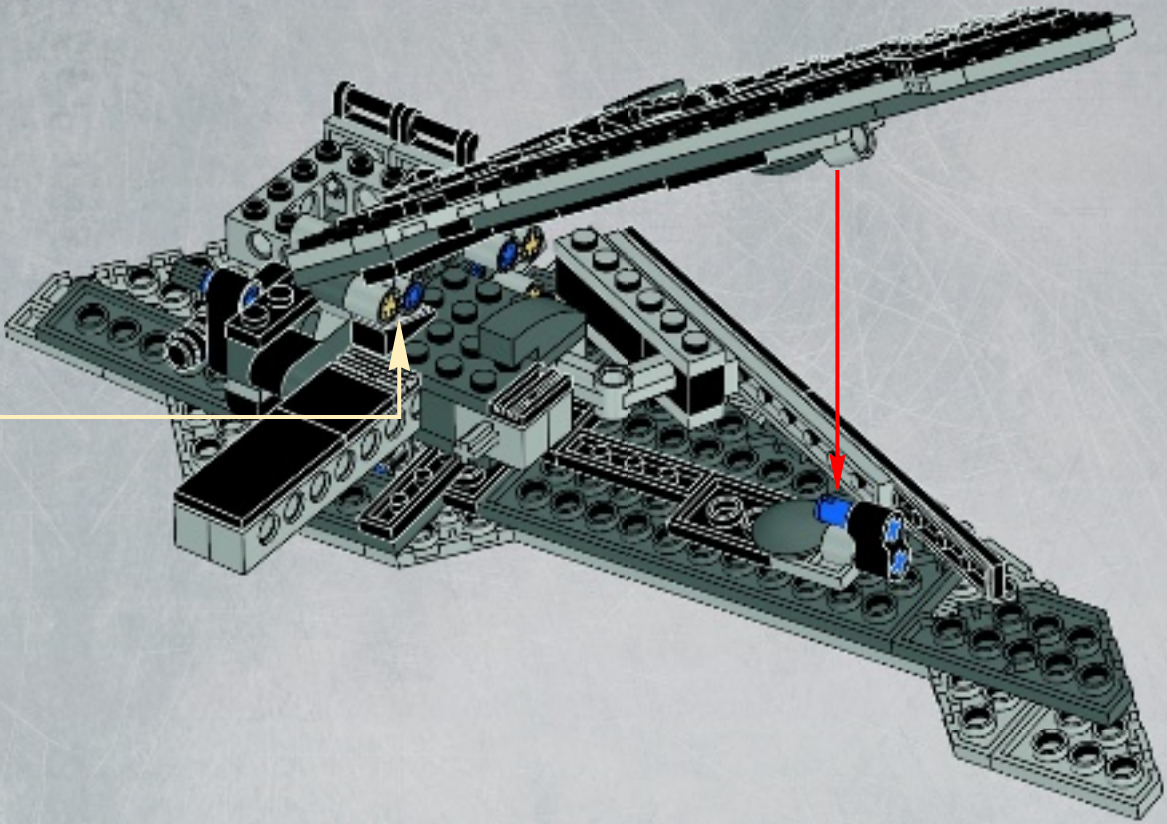

18

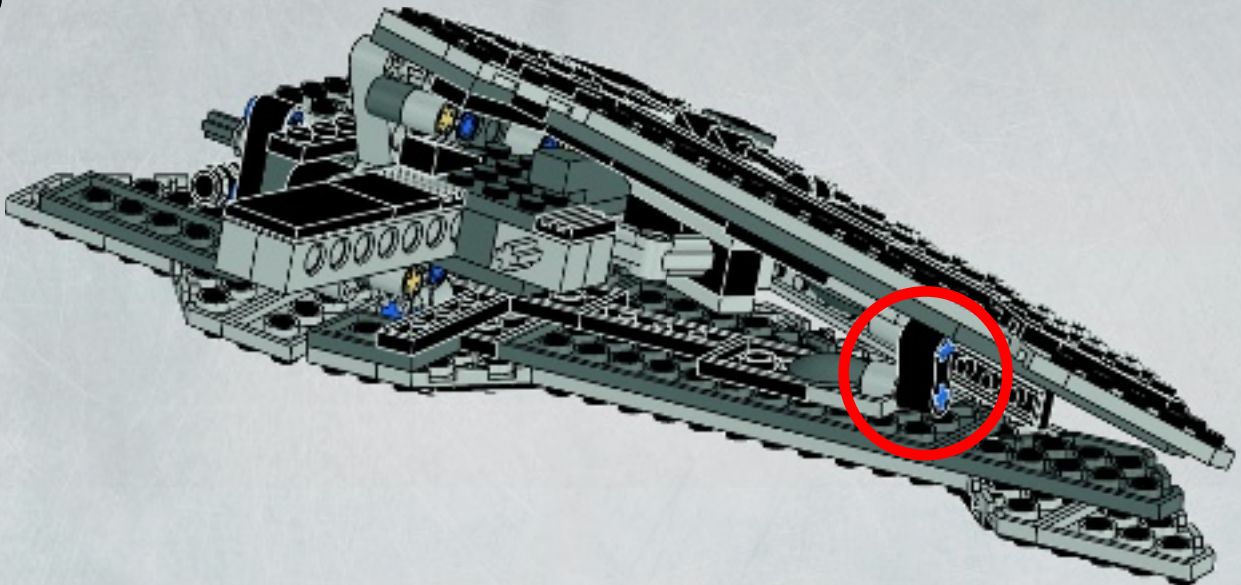

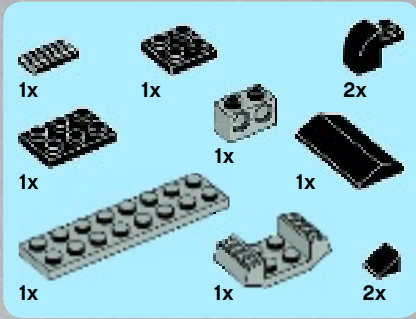

19

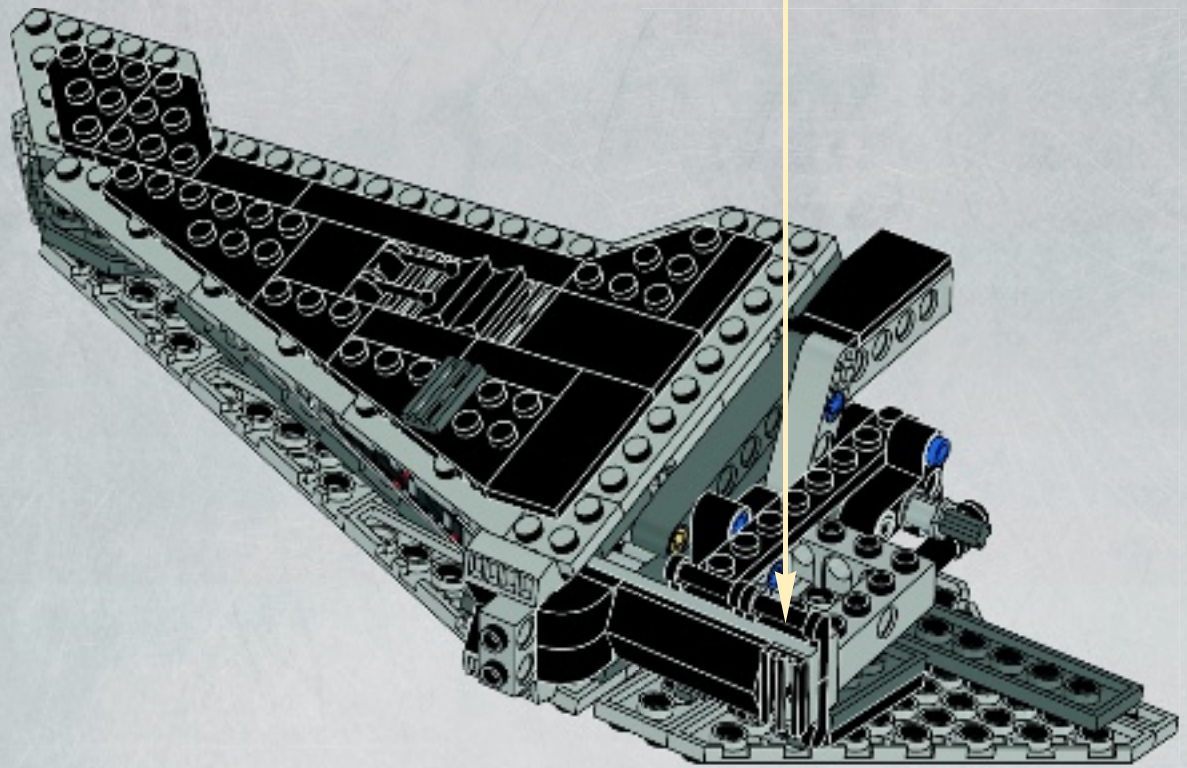
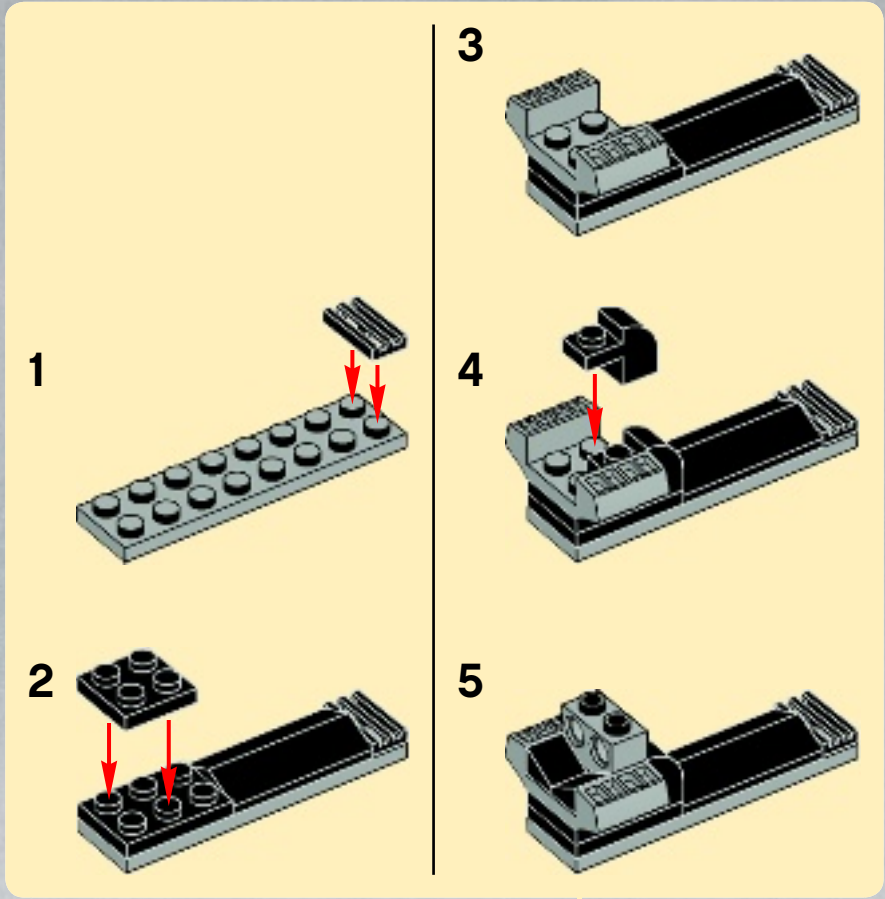



20

- 1
- 2
- 3

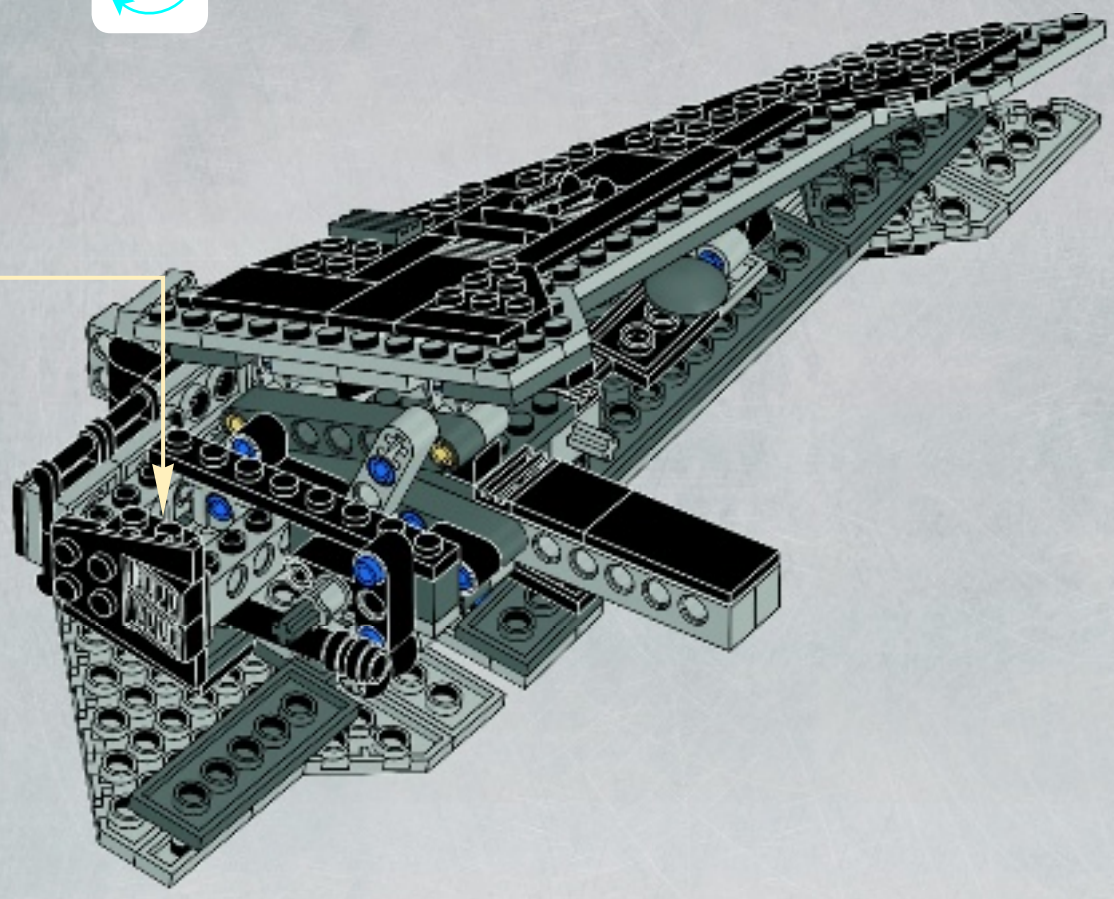

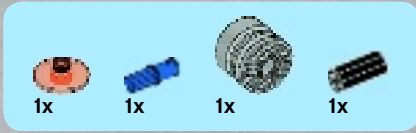

21

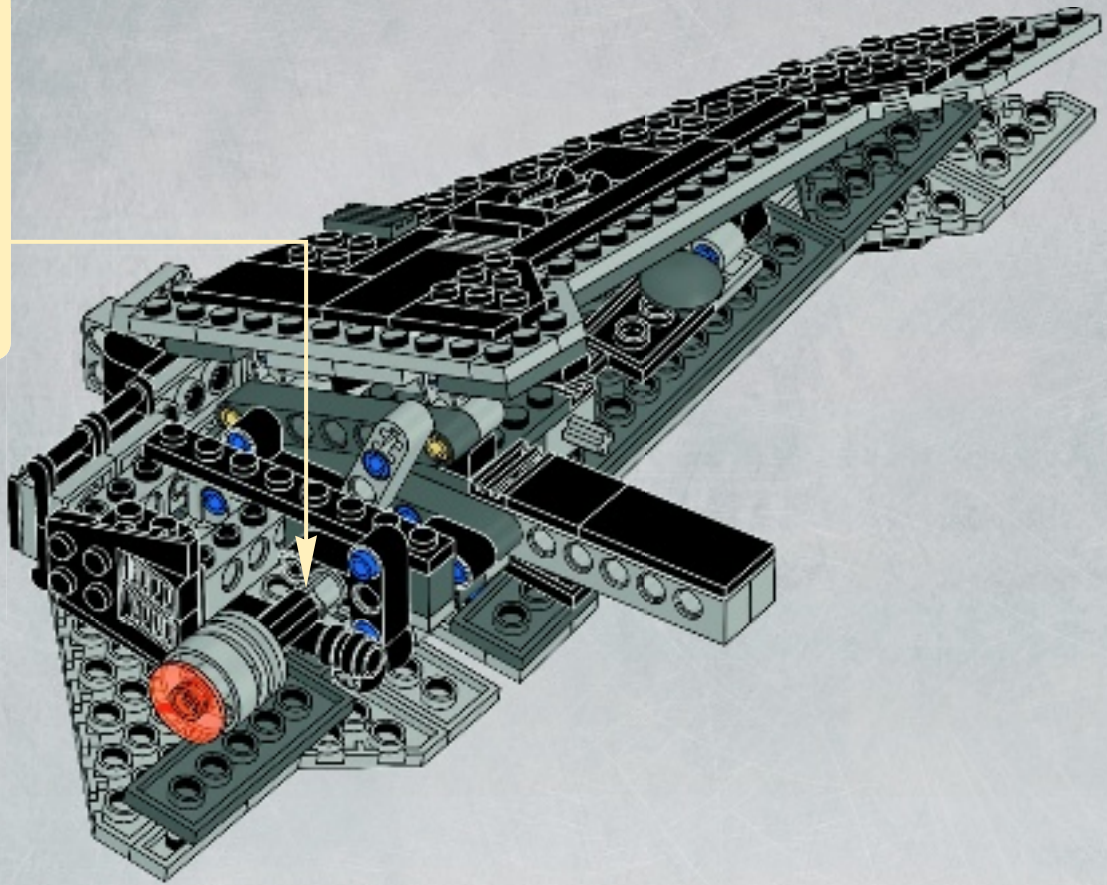
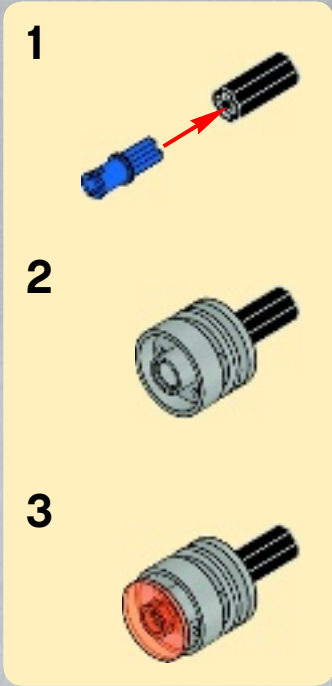

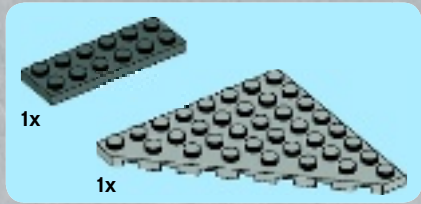

1

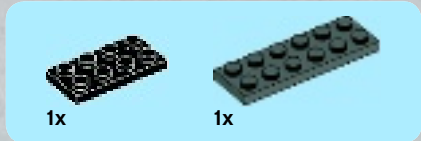
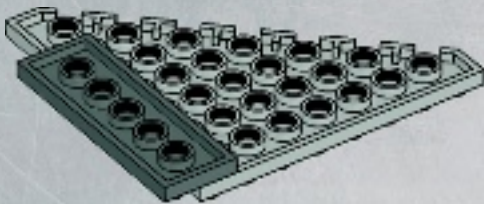

2

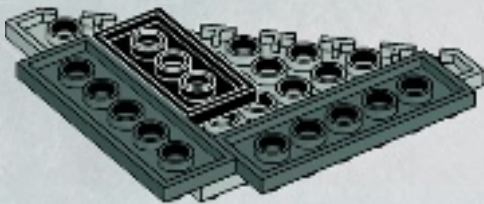

3

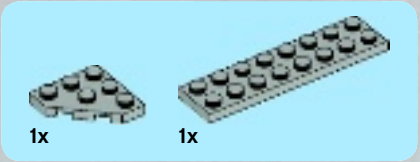
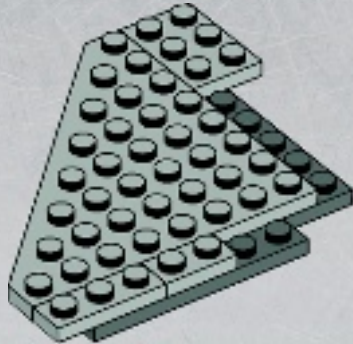

4

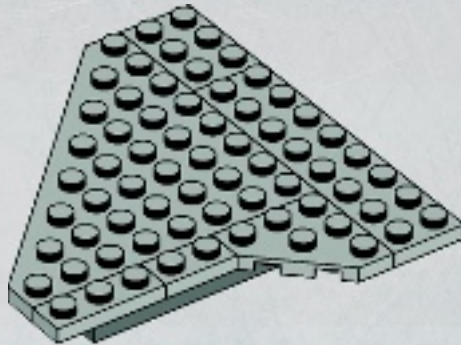



5

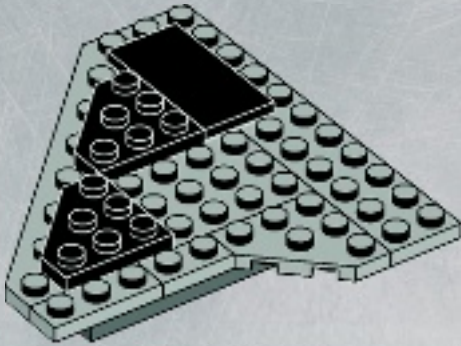

6

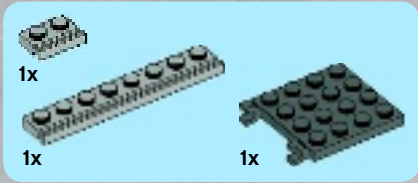
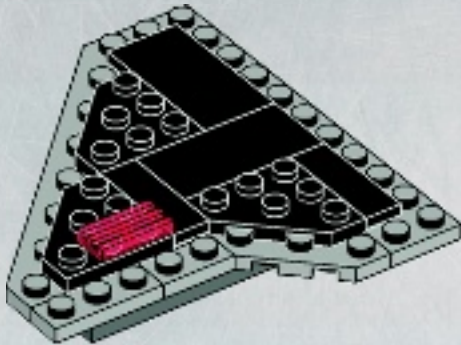

7

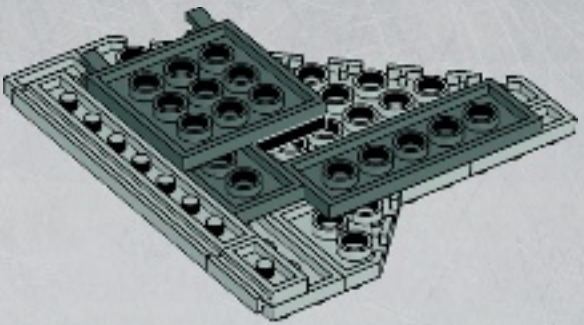

8

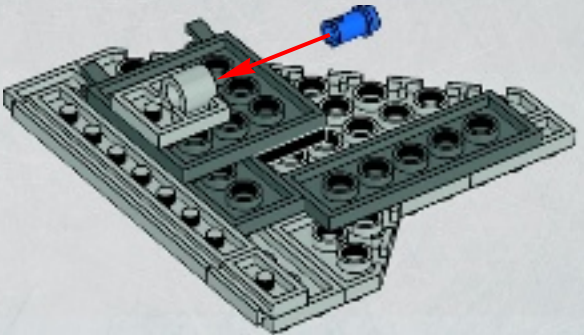

22

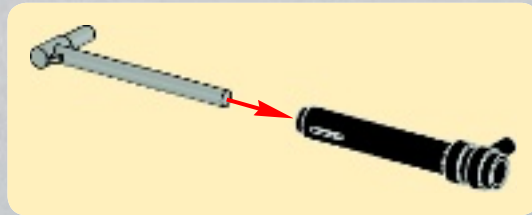
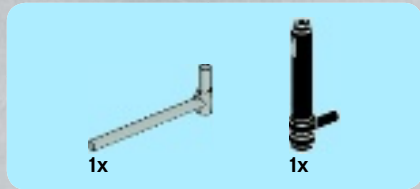
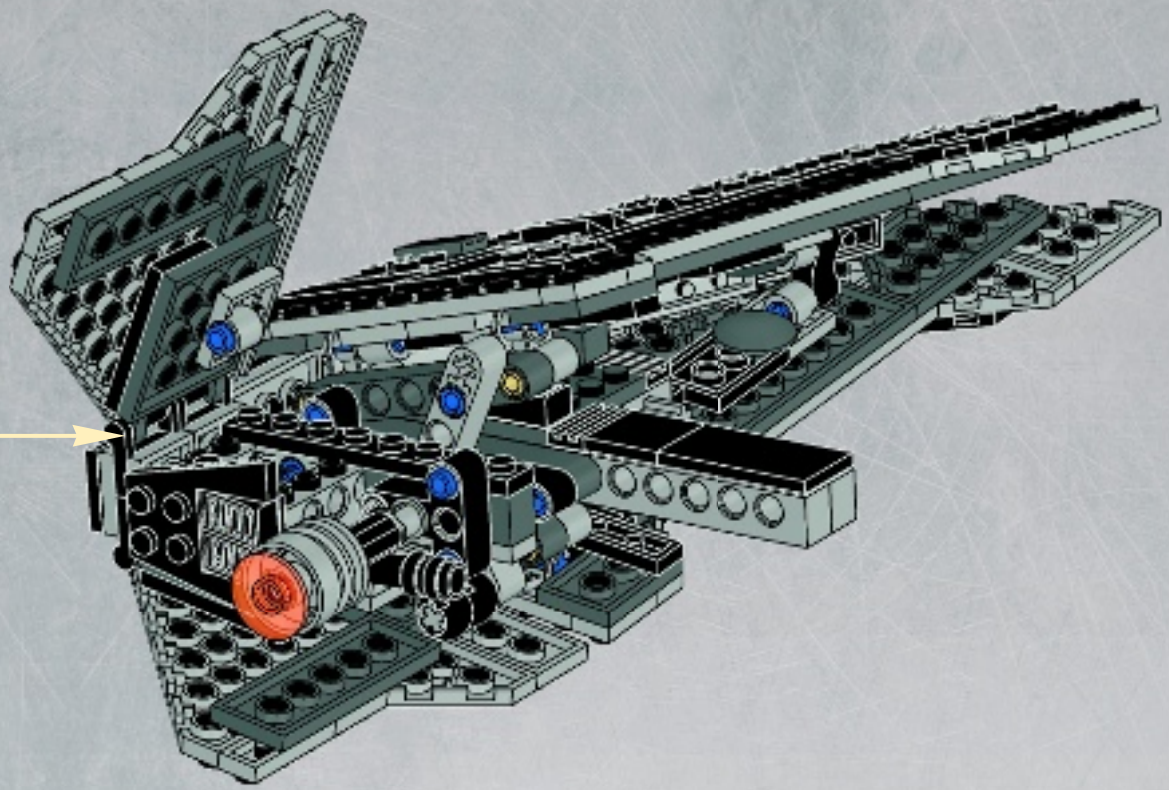

23

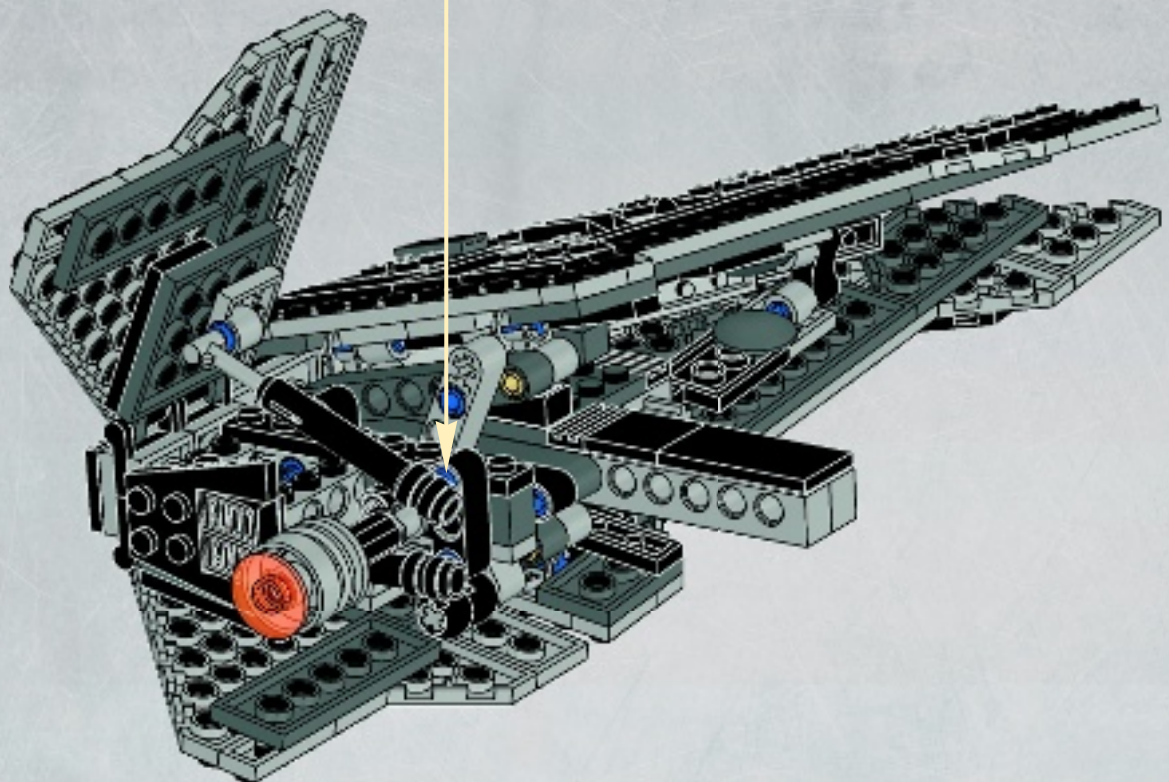

24

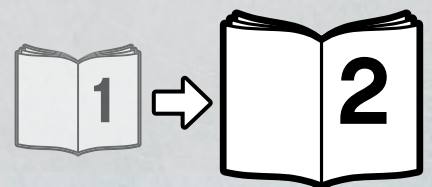
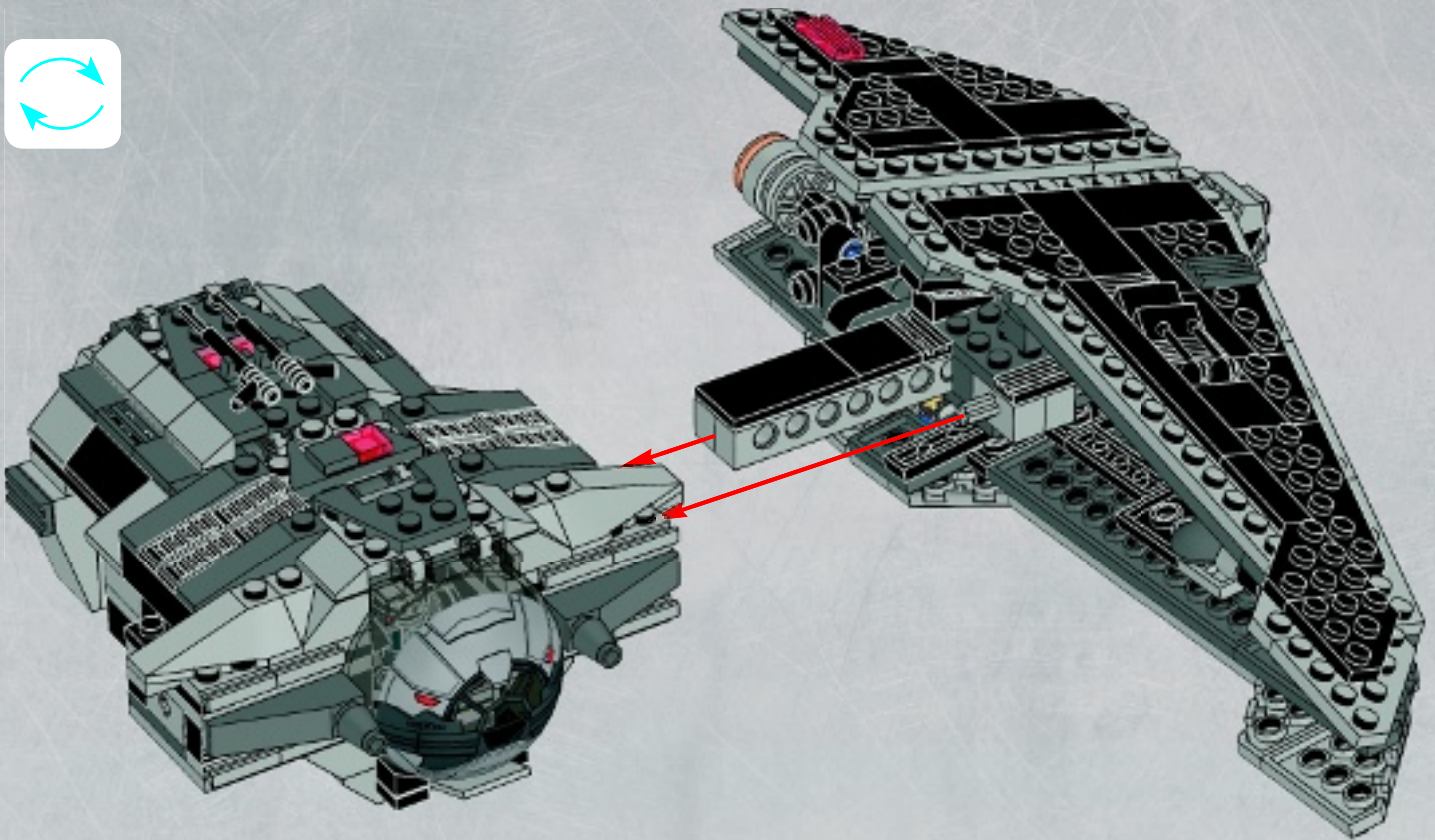



WIN!

Go to www.LEGOsurvey.com/product to fill out a survey for a chance to win a cool LEGO® Product. No purchase necessary. Open to all residents where not prohibited.



www.LEGO.com



www.LEGOsurvey.com/product

GEWINNE!

Nimm an der Umfrage auf www.LEGOsurvey.com/product teil und hab die Chance ein cooles LEGO® Produkt zu gewinnen! Die Teilnahme am Gewinnspiel führt zu keinerlei Kaufverpflichtungen. Teilnahme in allen nicht ausgeschlossenen Ländern möglich.

WIN!

Ga naar www.LEGOsurvey.com/product, vul een enquêteformulier in en maak kans op een cool LEGO® product. Geen aankoopverplichting. Iedereen mag deelnemen, uitgezonderd ingezetenden van landen waar een enquêteverbod geldt.

GAGNE!

Visite www.LEGOsurvey.com/product pour répondre à un questionnaire et avoir une chance de gagner un produit LEGO® très cool ! Aucune obligation d'achat. Ouvert à tous les résidents des pays autorisés.

当てよう!

www.LEGOsurvey.com/product にアクセスして、アンケートにご記入ください。当選者にはレゴ製品を差し上げます。お買い上げの必要はありません。禁止されていない限り、すべての皆様にご利用いただけます。