

**MEGA
BLOKS**

Disney

PIRATES of the CARIBBEAN

DEAD MEN TELL NO TALES

1066

Black Pearl

6+

175 pcs



Kampfschaden
Krijgsschade
Danno di battaglia
Danos de combate



- | | | | | |
|------------------|-----------------|-----------------|-----------------|-----------------|
| 36x
AM01312NK | 4x
AS0983435 | 2x
AM04850KM | 1x
AS0106631 | 1x
AS010668 |
| 2x
AM01495KJ | 2x
AM09493KM | | 1x
AS0106630 | 1x
AS010668 |
| 14x
AM09013DO | 1x
AS0362023 | | 1x
AM06941NK | 1x
AM06935KM |
| 1x
AM01793F | 1x
AM04781KJ | | 1x
AM06939JG | 1x
AS0106610 |
| 2x
AM02613YF | 4x
AM04663KJ | | 1x
AM06940JG | 2x
AS010662 |
| 1x
AM09435NK | 4x
AM04663NK | | 2x
AM06934KM | 1x
AS010665 |
| 2x
AM02641NK | 3x
AM10931TM | | 2x
AS0106622 | 1x
AS010669 |
| 1x
AM04758JN | 3x
AM06952KM | | 1x
AS010661 | 2x
AM06950KM |
| 1x
AM04733DO | 3x
AS0101715 | | 1x
AS010663 | 1x
AS0106620 |
| 4x
AM01887TM | 8x
AS0106613 | | 1x
AS010663 | 1x
AS0106621 |
| 1x
AS0101725 | 1x
AM06955NK | | 1x
AM06937KM | 1x
AS0106619 |
| 1x
AM02637NK | 8x
AM09033DO | | | |
| 2x
AS0106632 | 1x
AS0106638 | | | |
| 1x
AS0106635 | | | | |
| 1x
AS0106636 | | | | |
| 1x
AS0106637 | | | | |
| 1x
AS0367418 | | | | |
| 3x
AM04815YF | | | | |
| 1x
AM04809KM | | | | |
| | 2x
AM06976JG | | | |
| | 2x
AM06977JG | | | |
| | 3x
AS0106612 | | | |
| | 1x
AX010177 | | | |
| | 2x
AS0106634 | | | |
| | 1x
AS0101727 | | | |
| | 3x
AS0106639 | | | |

PIRATES *of the* CARIBBEAN

DEAD MEN TELL NO TALES



Jack Sparrow



Tia Dalma



Gibbs

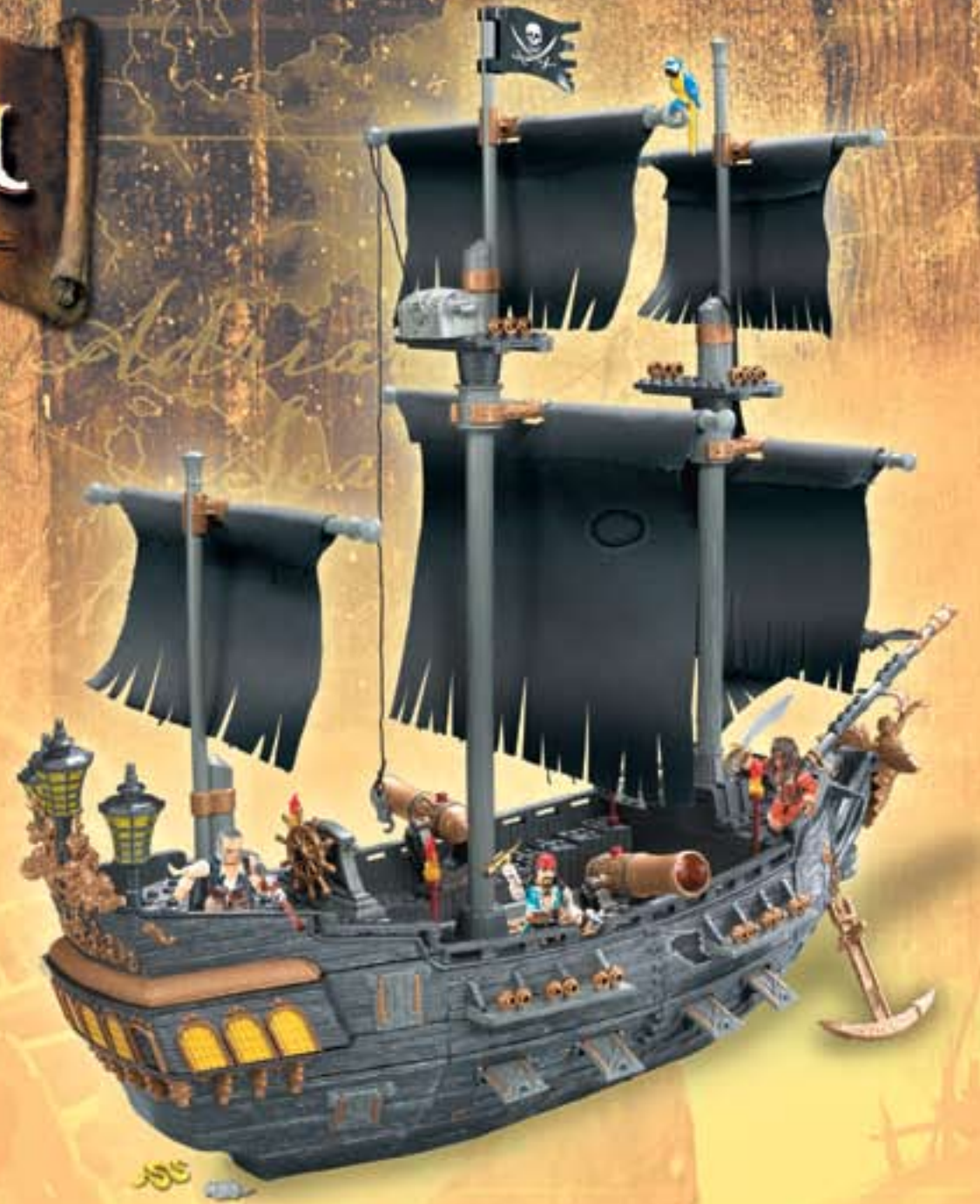

Please read these instructions carefully before first use and keep them for future reference. / Leer estas instrucciones cuidadosamente antes de la primera utilización y guardarlas para referencia futura. / Il est recommandé de lire attentivement ce feuillet avant la première utilisation et de le conserver pour référence future. / Die Gebrauchsanleitung bitte durchlesen und aufbewahren. / Wij raden u aan deze handleiding zorgvuldig te lezen en te bewaren voor eventuele raadpleging op een later tijdstip. / Leggere le istruzioni prima di cominciare ad usare il gioco e conservarle per referenze future. / Leia as instruções antes do primeiro uso e guarde-as para futura referência.

EN ⚠ **WARNING :**
CHOKING HAZARD. - Small parts.
Not for children under 3 years.

ES ⚠ **ADVERTENCIA :**
PELIGRO DE ASFIXIA. - Contiene piezas pequeñas.
No recomendado para niños menores de 3 años.

FR ⚠ **AVERTISSEMENT :**
RISQUE DE SUFFOCATION. - Présence de petits éléments.
Ne convient pas aux enfants de moins de 3 ans.

DE ⚠ **WARNUNG:**
ERSTICKUNGSGEFAHR. - Enthält kleine Teile.
Nicht für Kinder unter 3 Jahren geeignet.

NL ⚠ **WAARSCHUWING:**
VERSTIKKINGSGEVAAR. - Bevat kleine onderdelen.
Niet geschikt voor kinderen onder de 3 jaar.

DA ⚠ **ADVARSEL:**
KVÆLNINGSFARE. - Indeholder smådele.
Ikke til børn under 3 år.

EL ⚠ **ΠΡΟΕΙΔΟΠΟΙΗΣΗ:**
ΚΙΝΔΥΝΟΣ ΠΝΙΞΙΜΑΤΟΣ. - Περιέχει μικρά αντικείμενα
Όχι για παιδιά κάτω των 3 ετών.

FI ⚠ **VAROITUS:**
TUKEHTUMISVAARA. - Sisältää pieniä osia.
Ei alle 3-vuotiaalle lapsille.

IT ⚠ **ATTENZIONE:**
PERICOLO DI SOFFOCAMENTO. - Contiene piccole parti.
Non indicato per bambini sotto i 3 anni.

NO ⚠ **ADVARSEL:**
KVELNINGSFARE. - Inneholder små deler.
Kun for barn over 3 år.

PT ⚠ **ATENÇÃO:**
PERIGO DE ASFIXIA. - Contém peças pequenas.
Não é concebido para crianças de menos de 3 anos.

SV ⚠ **VARNING:**
KVÄVNINGSRISK. - Innehåller små delar.
Inte för barn under 3 år.

JA ⚠ **警告 :**
窒息の危険性 小さな部品が含まれています
3歳以下の子供には与えないで下さい。

ZH ⚠ **警告:**
有窒息危險。包含有小部件
不适合3岁以下的小孩玩。

AR ⚠ **تحذير:**
خطر اختناق - قطع صغيرة.
غير صالحة للأطفال أقل من 3 سنوات.



LIFETIME GUARANTEE / GARANTIZADO DE POR VIDA / GARANTIE À VIE / LEBENSLANGE GARANTIE / LEVENSLANGE GARANTIE / GARANZIA A VITA / TEM GARANTIA VITAÍCIA
COMMENTS, QUESTIONS ? / ¿COMENTARIOS, PREGUNTAS ? / COMMENTAIRES, QUESTIONS ? / KOMMENTARE, FRAGEN ? / COMMENTAAR, VRAGEN ? / COMMENTI?, DOMANDE? / PERGUNTAS?, COMENTÁRIOS?
1-800-465-MEGA
U.S. & Canada only / Solamente en EEUU y Canadá / É.U. et Canada seulement / Nur für U.S und Kanada / Uitsluitend in de V.S. en Canada / USA e Canada solamente / Somente EE.UU. e Canadá
www.megabloks.com

The Disney logo is located in the top left corner, enclosed in a dark oval with a wooden texture. The background of the entire page is a dark, textured surface, possibly wood, with a large, detailed skull of a pirate with a red bandana and a sword in its mouth on the left side. In the top right, there are several gold coins. The main title is on a parchment scroll in the center.

PIRATES *of the* CARIBBEAN

DEAD MEN TELL NO TALES

A majestic maiden gliding across the unlimited sea, the **BLACK PEARL** is a swift and resilient vessel with a history as winding as its maneuverability in dangerous situations.

Deslizándose majestuoso y solitario por el mar sin límites, el **PERLA NEGRA** es un barco rápido y resistente, con una reputación tan tortuosa como sus maniobras en situaciones peligrosas.

Majestueux navire glissant sur la mer infinie, la **PERLE NOIRE** est un vaisseau rapide et résistant avec une réputation aussi tortueuse que ses manœuvres dans les situations dangereuses.

Die **SCHWARZE PERLE**, ein grandioses Schiff, das über das grenzenlose Meer gleitet, ist ein schnelles, unverwüstliches Fahrzeug mit einer Geschichte, die so verschlungen ist wie ihre Wendigkeit in gefährlichen Lagen.

De **ZWARTE PAREL**, als een majestueuze maagd over de eindeloze zee glijdend, is een snel en veerkrachtig vaartuig met een verleden dat even kronkelig is als haar wendbaarheid in gevaarlijke situaties.

Una fanciulla maestosa che corre sul mare infinito, la **PERLA NERA** è un vascello rapido e maneggevole, noto per la sua capacità di serpeggiare e la sua manovrabilità in situazioni pericolose.

Uma nave majestosa deslizando pelo mar ilimitado, a **PÉROLA NEGRA** é uma embarcação rápida e forte, com uma história tão tortuosa como a sua manobrabilidade em situações perigosas.

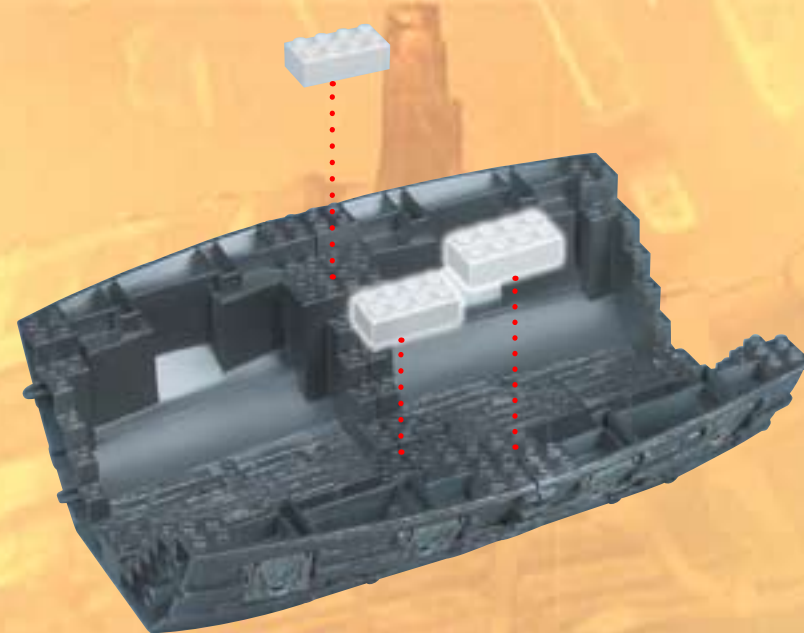
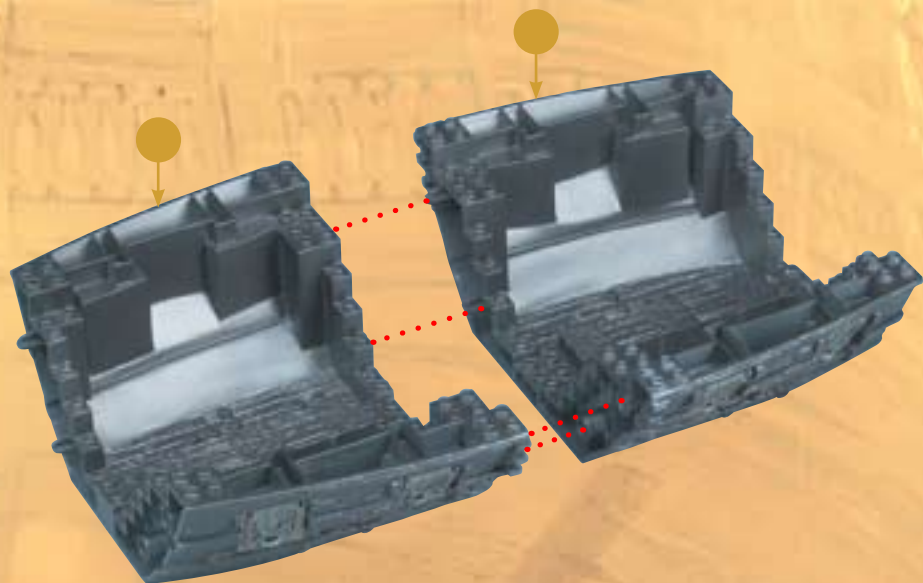
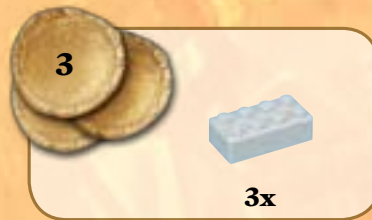

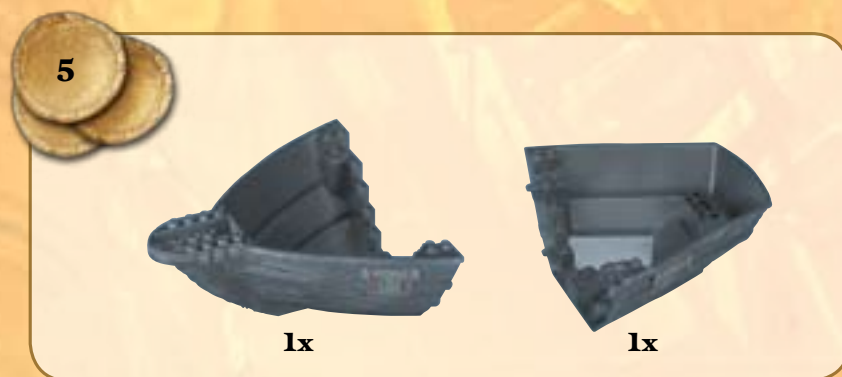
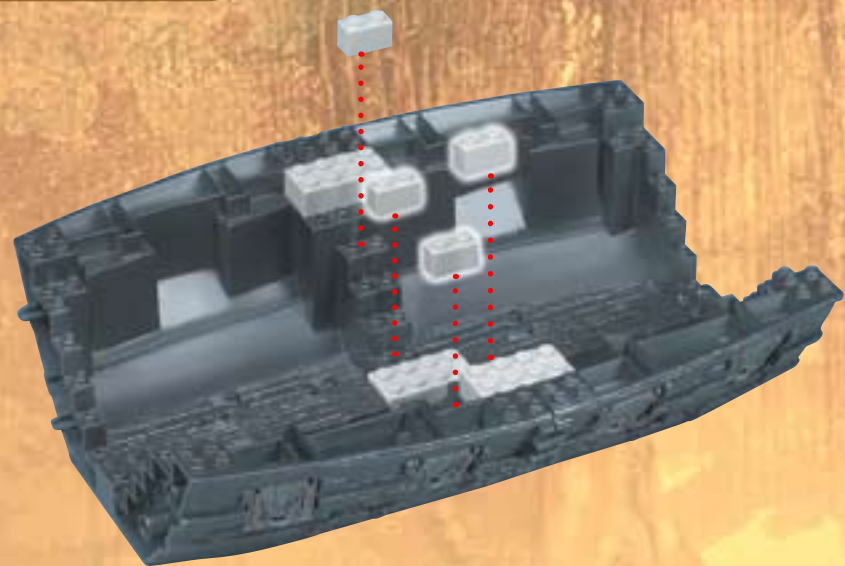
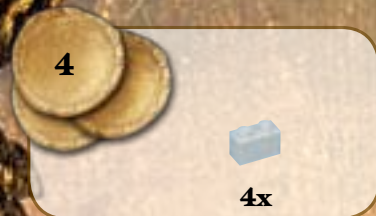

6



4x

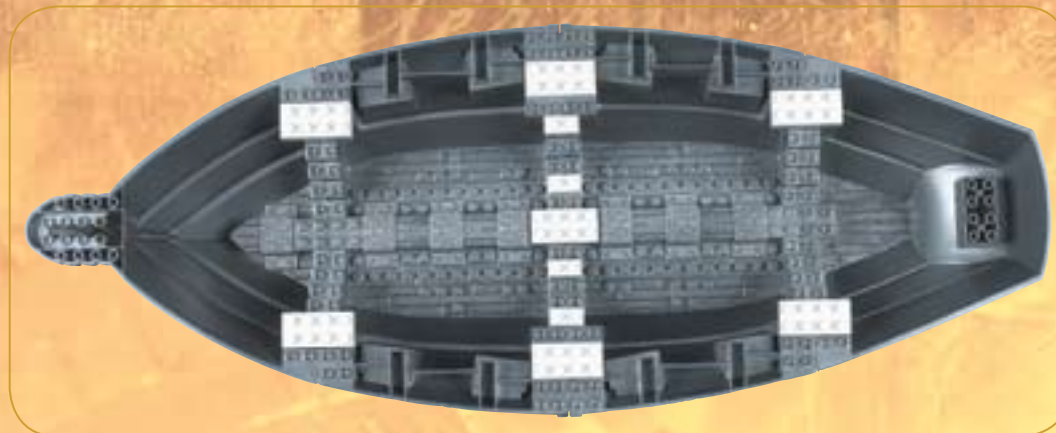
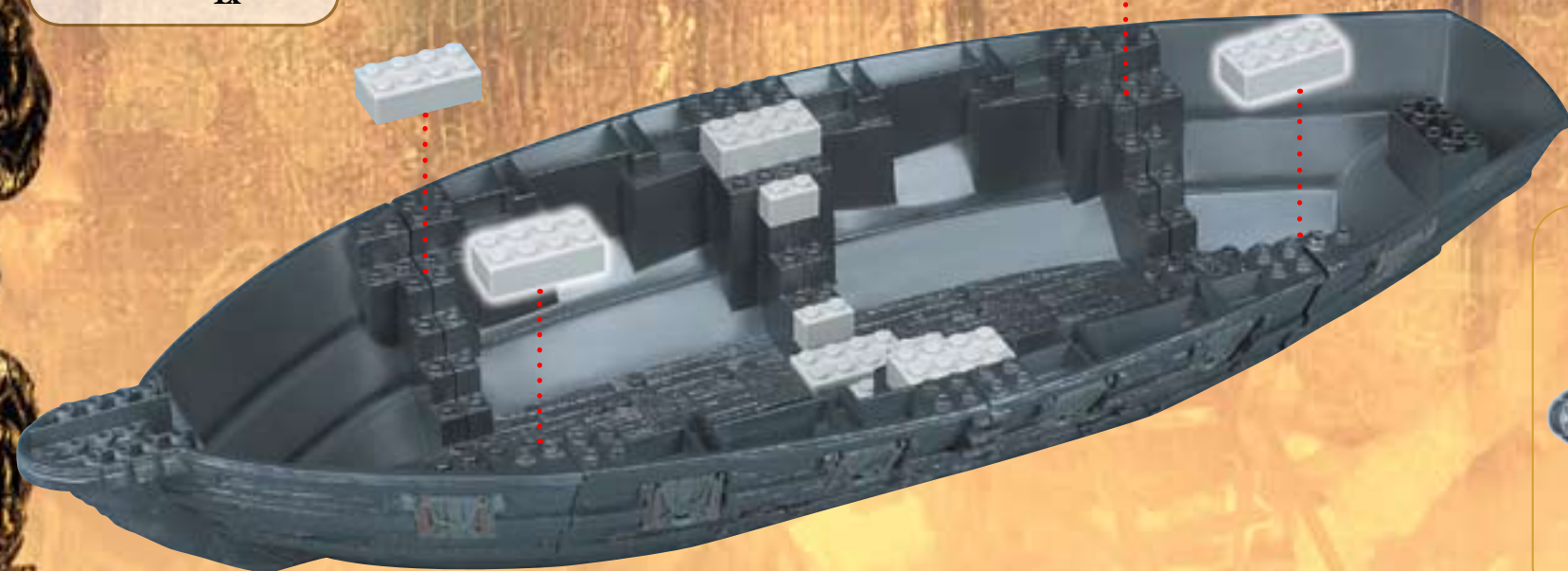

7

7



10x



1x

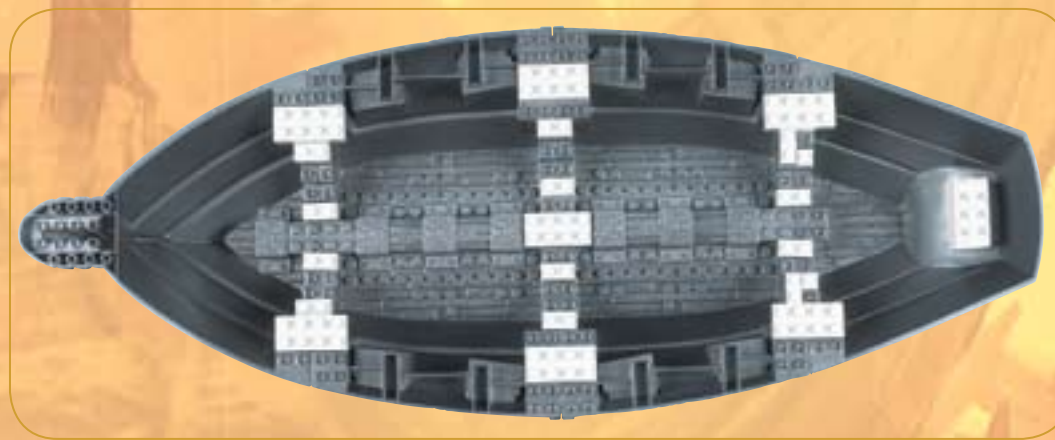

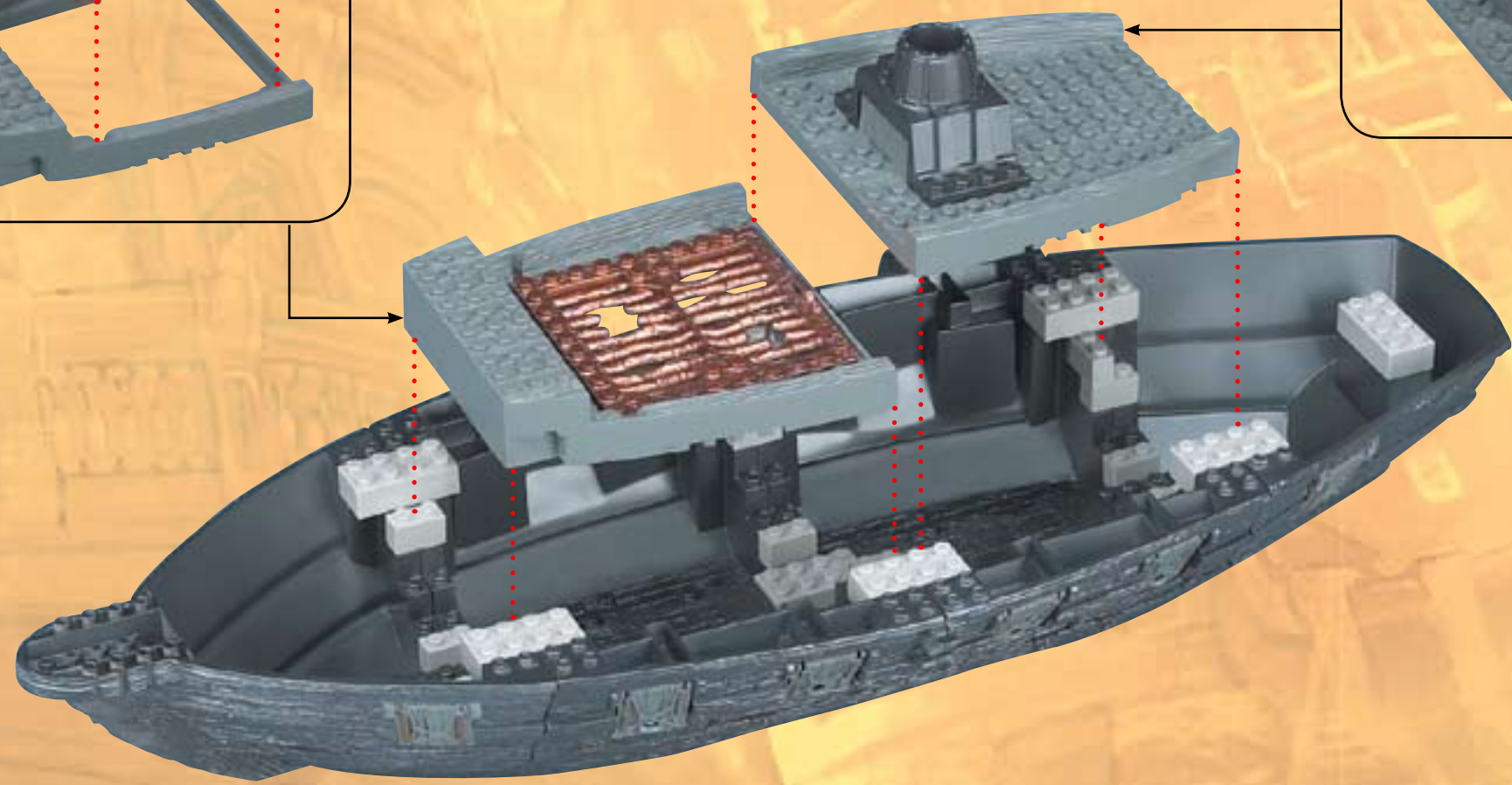
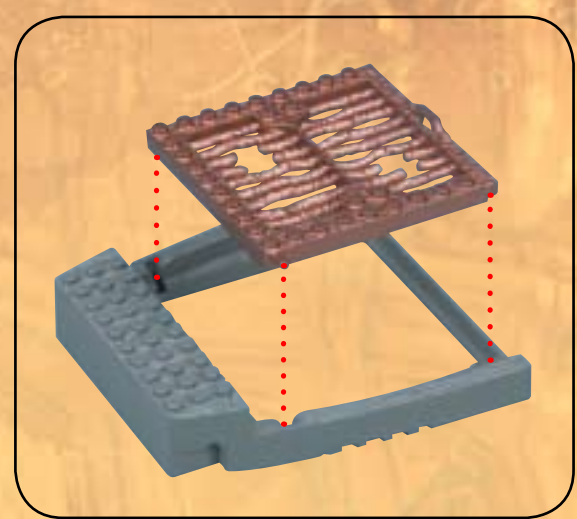
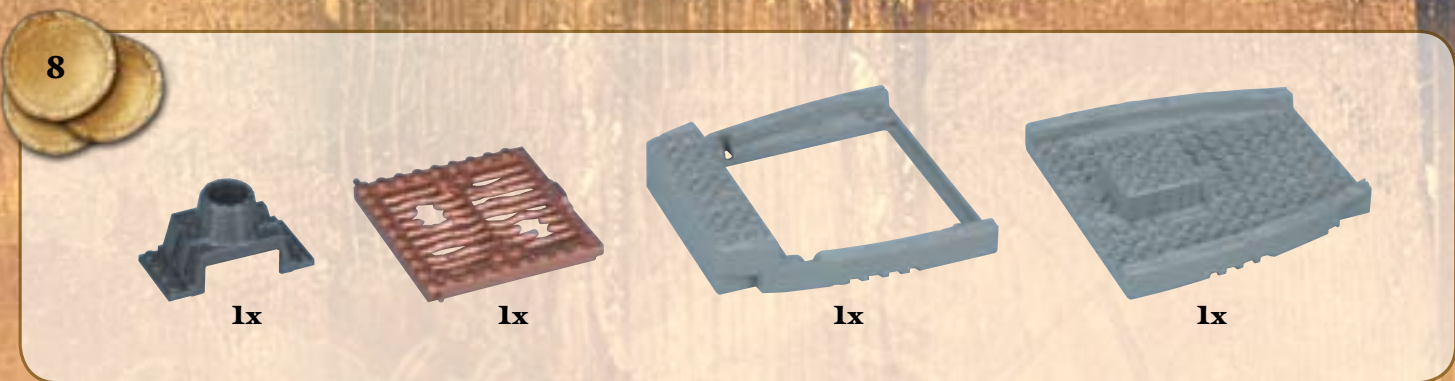





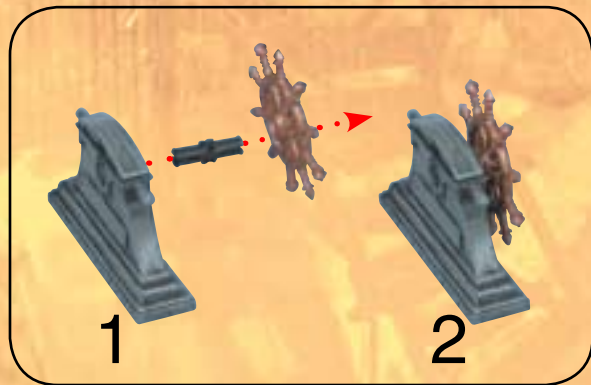

1

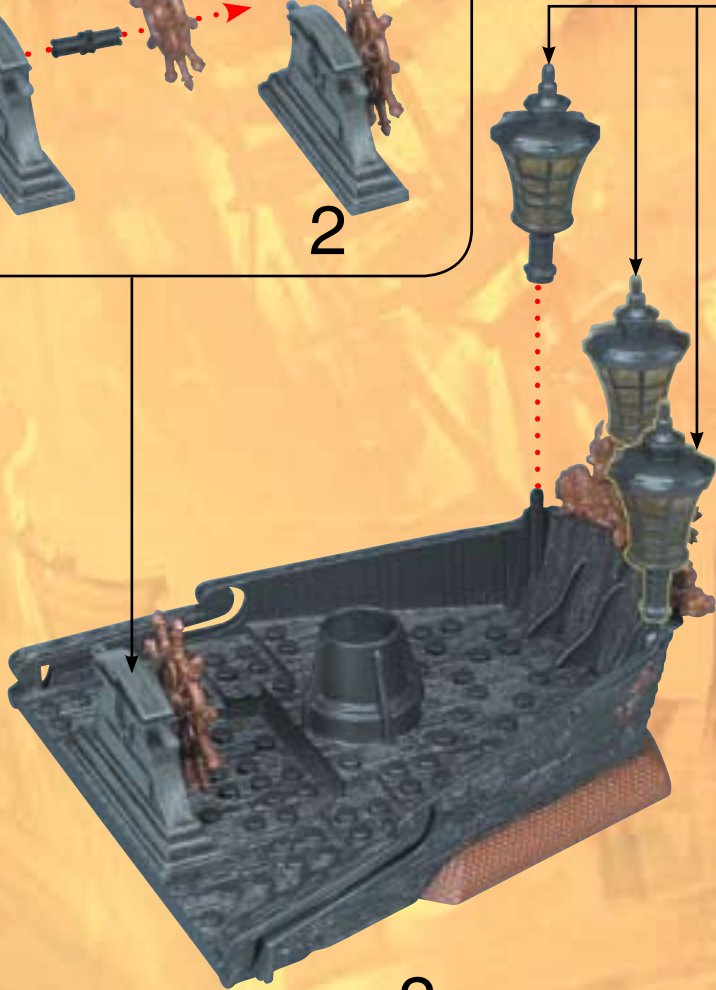

2



3



13

13

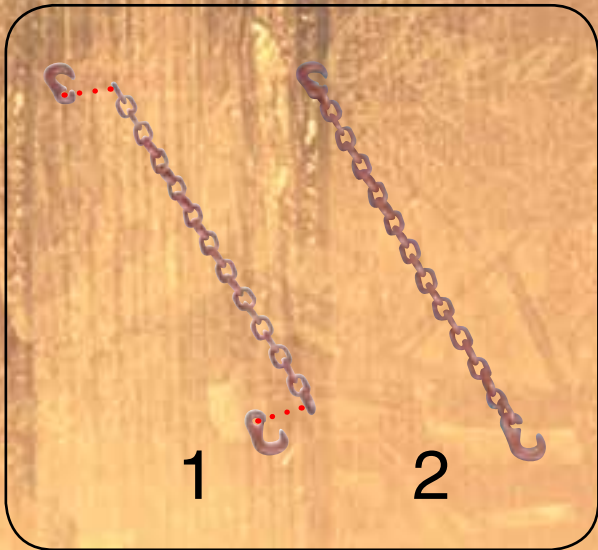

1



2



3

14

13



15

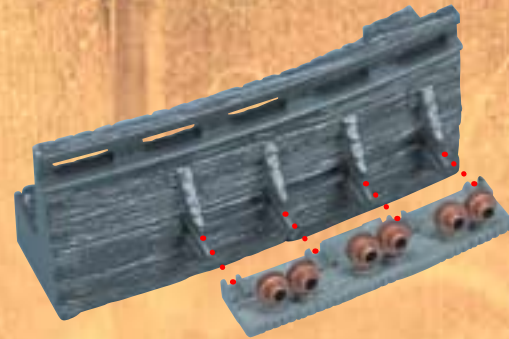
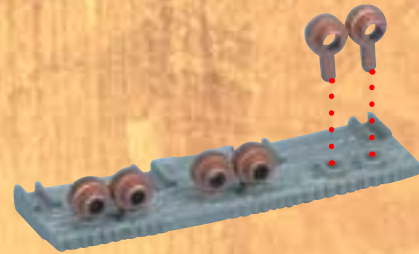
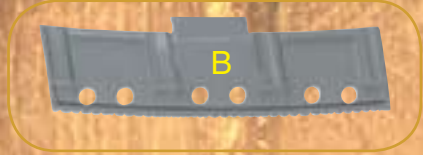

x2

14

16

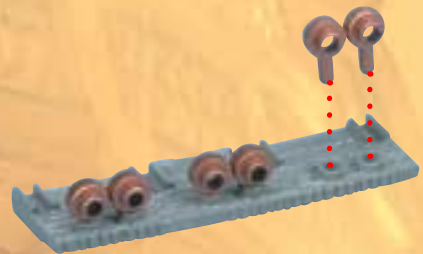
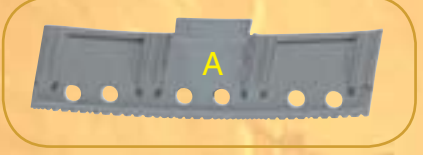

x2

17

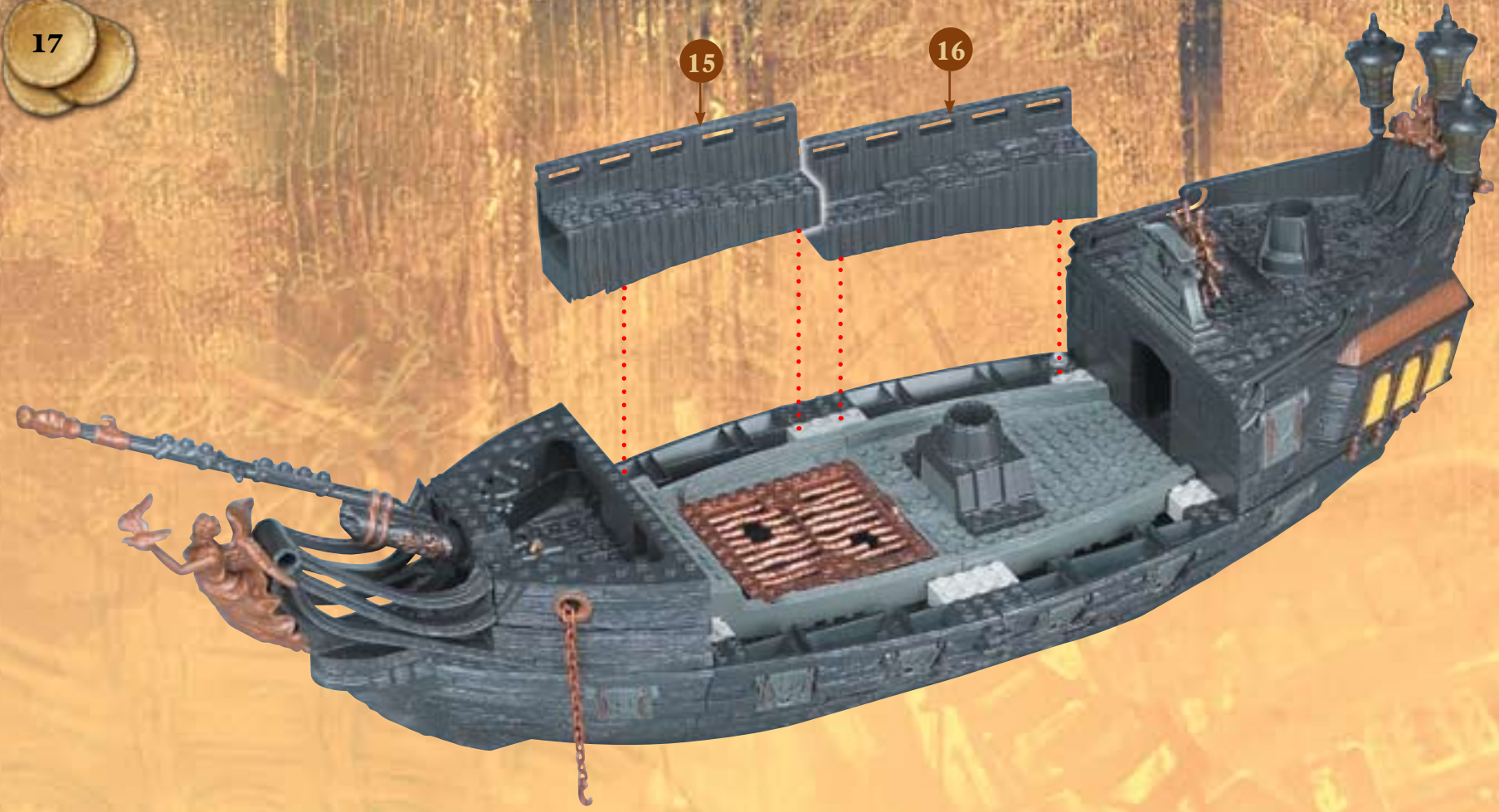

15

18



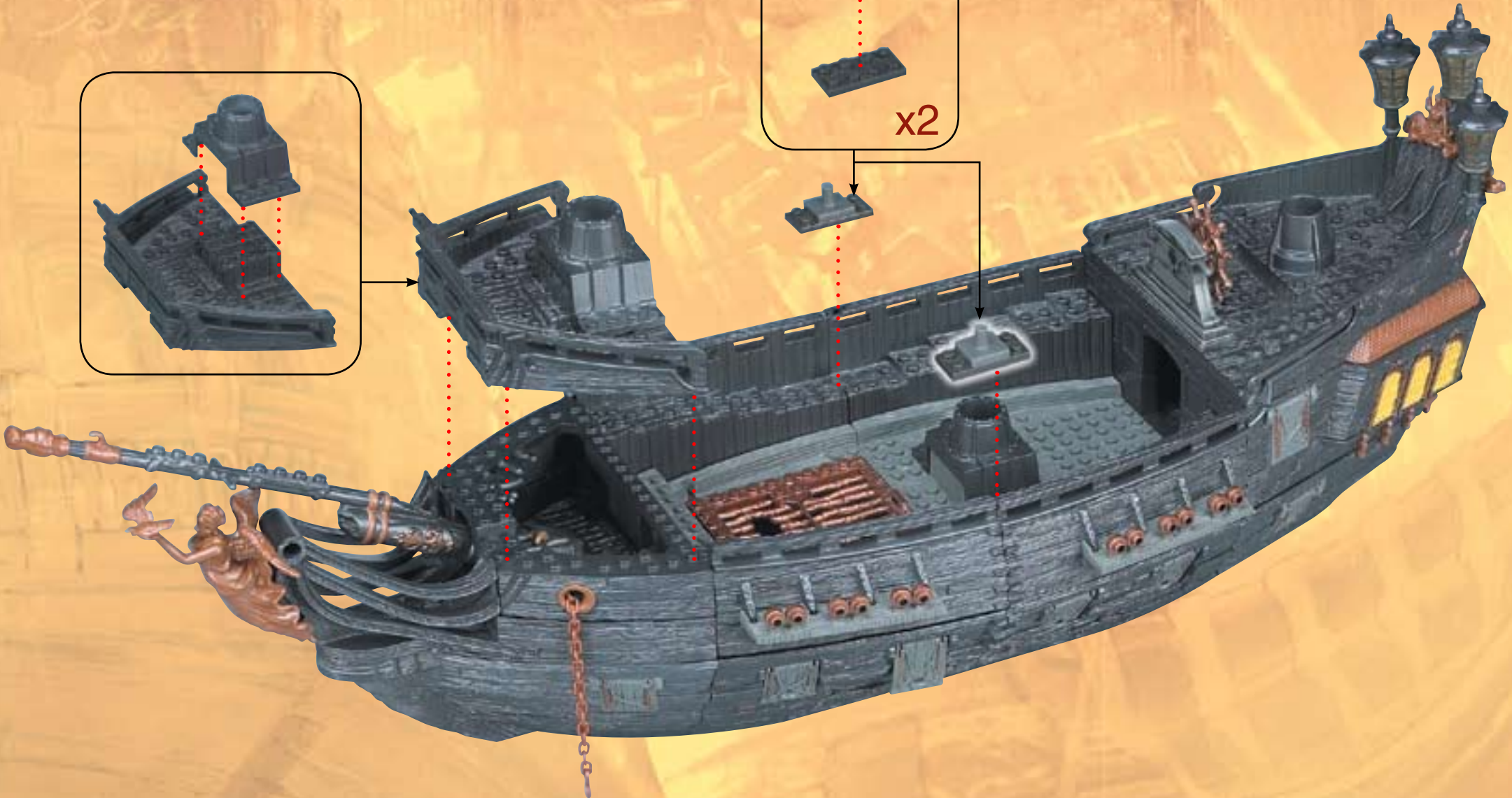



2x



2x



1x



x2

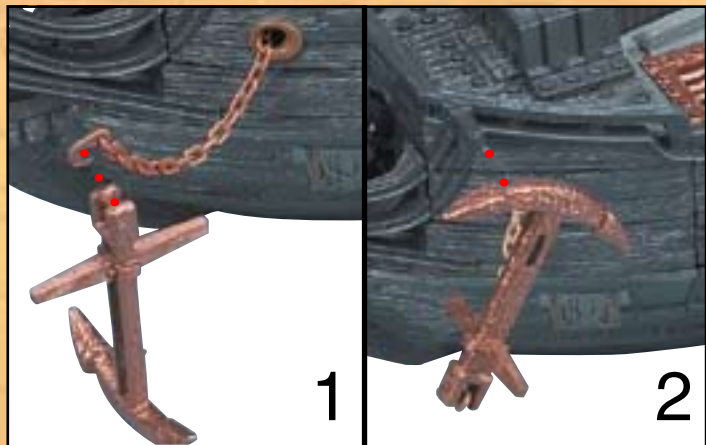
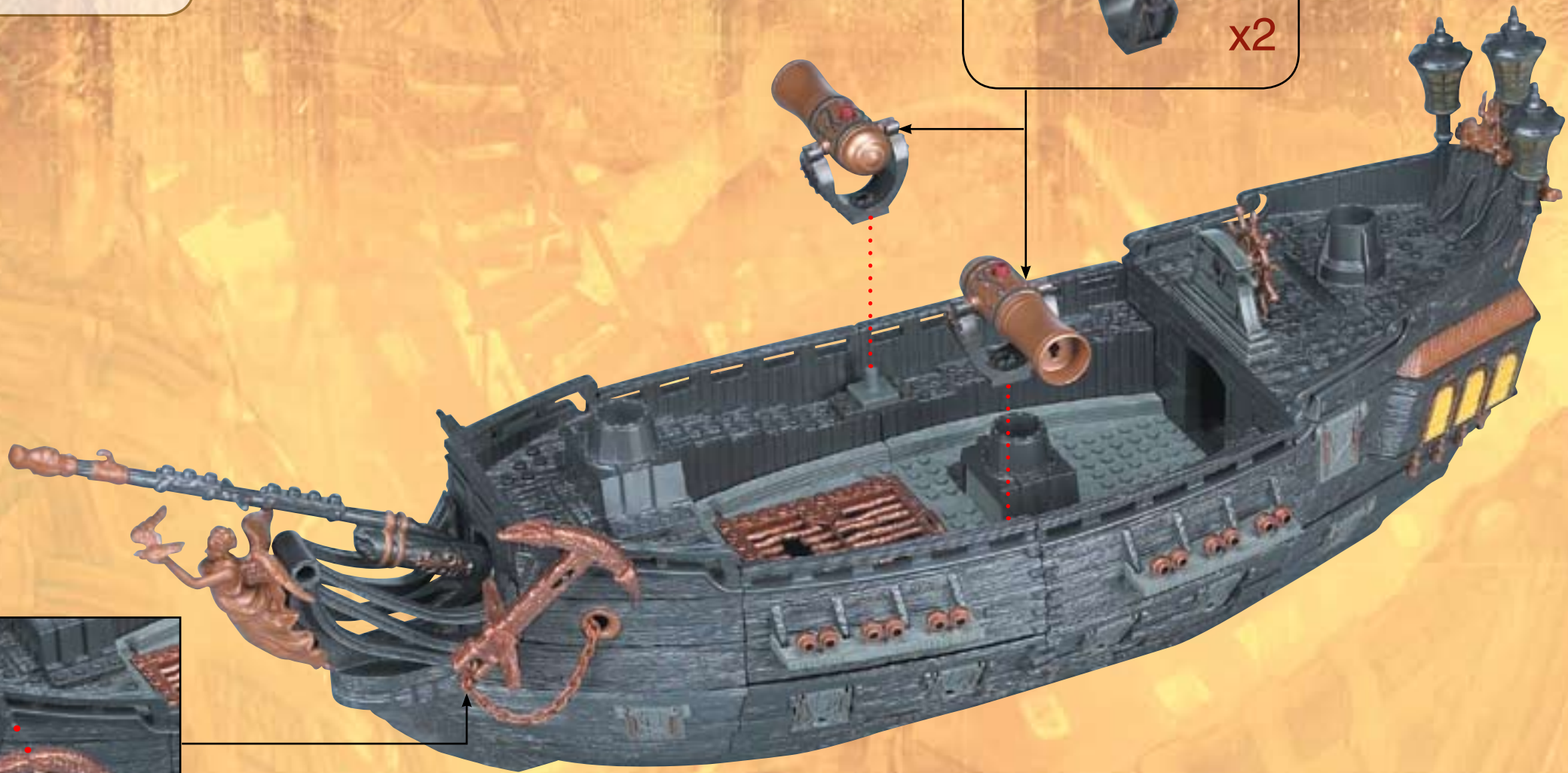

1

2

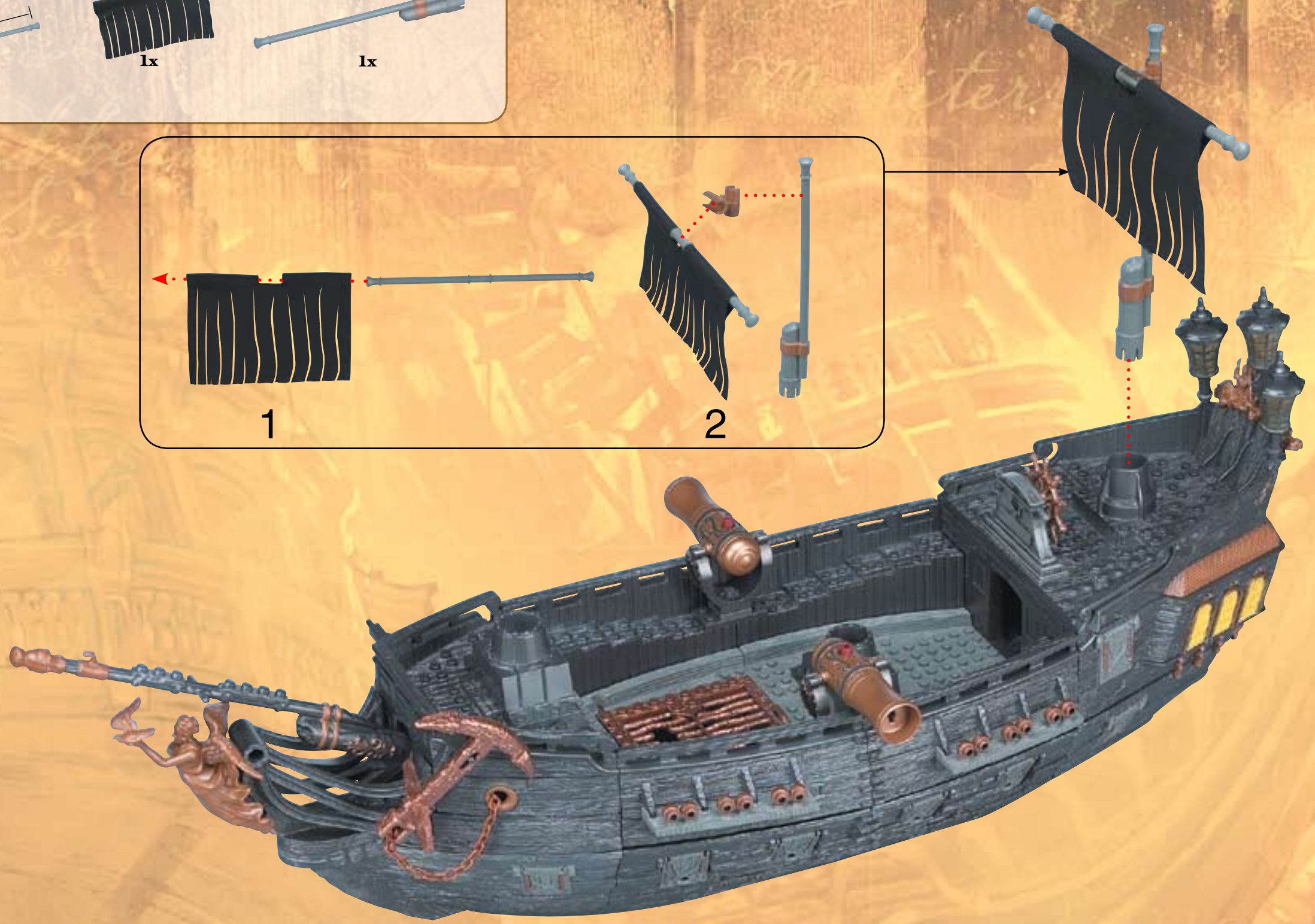
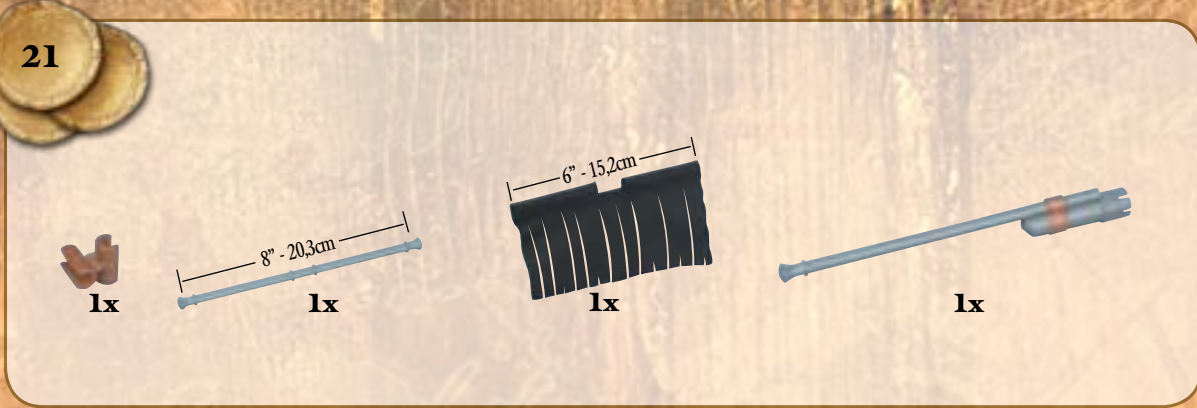

6x

1x

10" - 25.4cm

1x

10.5" - 26.6cm

1x

1x

8.7" - 22.2cm

1x

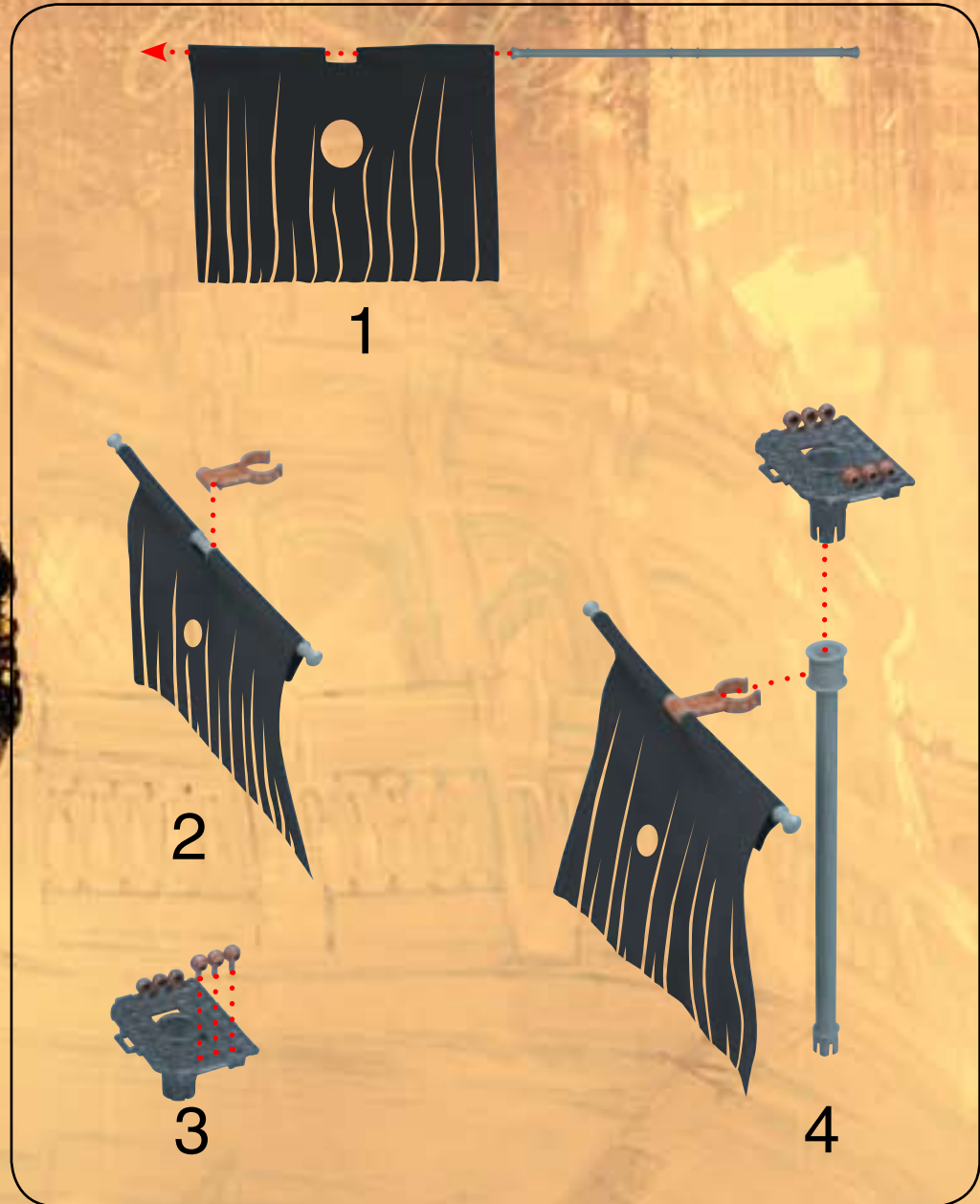

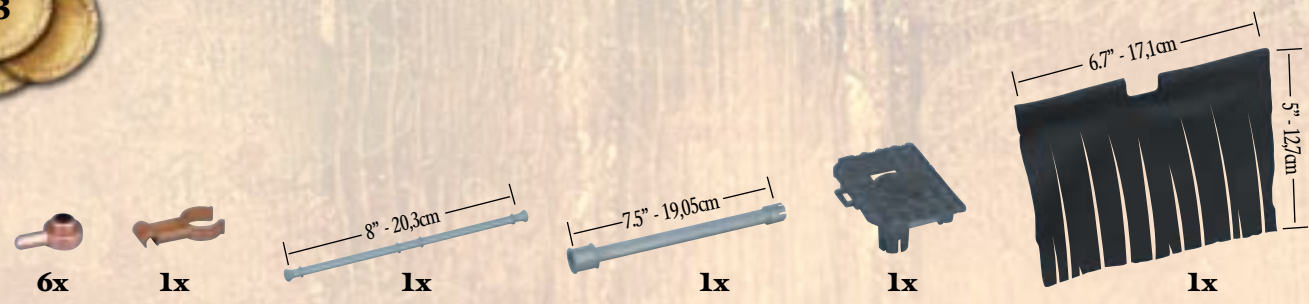



25

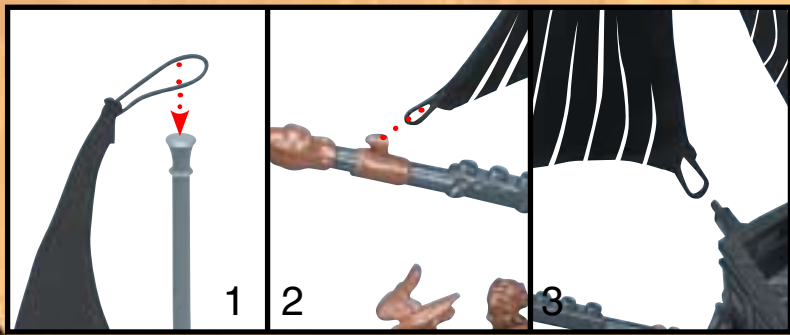

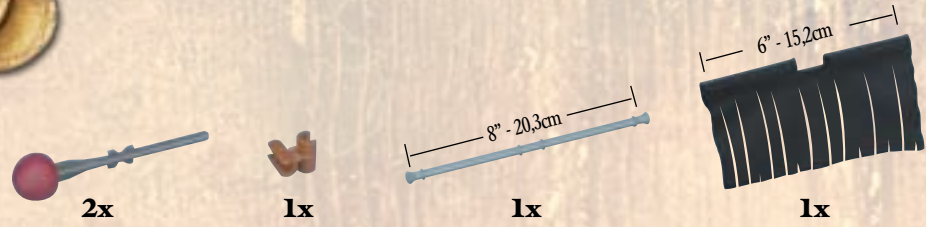

- EN CAUTION! Do not aim at eyes or face.
- ES ¡ADVERTENCIA! NO dirigir nunca los proyectiles hacia los ojos o la cara.
- FR ATTENTION! Ne pas viser les yeux ou le visage.
- DE VORSICHT! Nicht auf das Gesicht oder die Augen richten.
- NL LET OP! Niet op ogen of gezicht richten.
- DA ADVARSEL! Peg ikke i retning af øjne eller ansigt.
- EL ΠΡΟΣΟΧΗ! Να μην σκοπεύετε προς τα μάτια ή το πρόσωπο.
- FI VARO! Älä tähtää silmiin tai kasvoihin.
- IT Attenzione! Non puntare verso gli occhi o il viso.
- NO FORSIKTIG! Sikt ikke mot øyne eller ansikt.
- PT ATENÇÃO: Não apontar para os olhos ou o rosto.
- SV VAR FÖRSIKTIG! Rikta inte med ögon eller ansikte.
- JA 注意！目や顔に使用しないで下さい。
- ZH 警告！不要对准眼睛或脸。
- AR تنبيه! لا توجه للعينين أو الوجه

Use only the projectiles included with this toy.
 Utilizar solamente los proyectiles incluidos con el juguete.
 Utiliser seulement les projectiles fournis avec le jouet.
 Nur die mit dem Spielzeug mitgelieferten Projektile verwenden.
 Alleen de met het speelgoed bijgeleverde projectielen gebruiken.
 Utilizzare soltanto i proiettili forniti con questo giocattolo.
 Usar somente os projéteis incluídos com este brinquedo.
 استخدم فقط القذيفة المرافقة لهذه اللعبة



1x



1x



1x

COINS NOT INCLUDED
MONEDAS NO INCLUIDAS
PIÈCES DE MONNAIE NON INCLUSES
MÜNZEN NICHT INBEGRIFFEN
MUNTEN NIET INBEGREPEN
MONETE NON INCLUSE
NÃO INCLUI MOEDAS



1

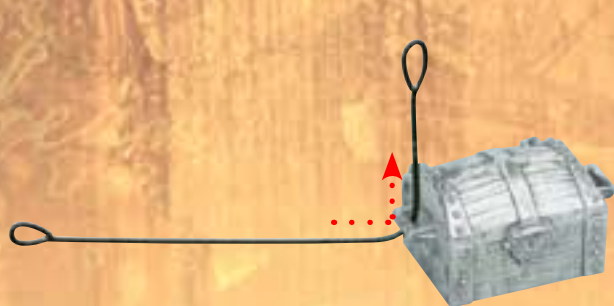

2



3



4



5

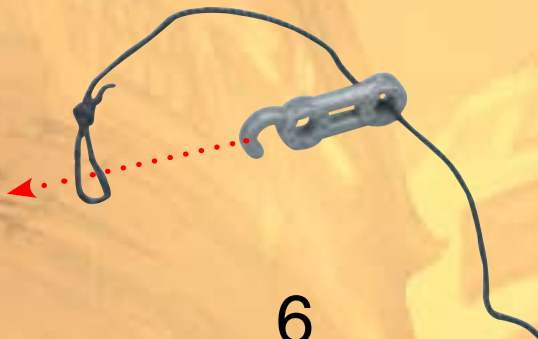

6



7



8



EN Adult assistance may be required.
ES Puede ser necesaria la ayuda de un adulto.
FR L'assistance d'un adulte peut être requise.
DE Hilfe eines Erwachsenen kann erforderlich sein.
NL De hulp van een volwassene kan nodig zijn.
IT L'assistenza di un adulto può essere necessaria.
PT Assistência por um adulto poderá ser necessária.

	 4x	 4x	 1x	 1x
 1x	 1x	 3x	 1x	 4x
 3x	 1x	 1x	 4x	 1x
 1x	 1x	 1x		



x4









Disney PIRATES OF THE CARIBBEAN AT WORLD'S END

Black Pearl

1066

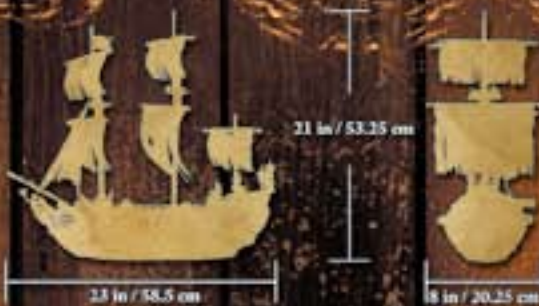

A majestic maiden gliding across the unlimited sea, the BLACK PEARL is a swift and resilient vessel with a history as winding as its maneuverability in dangerous situations.

Deslizándose majestuoso y solitario por el mar sin límites, el PERLA NEGRA es un barco rápido y resistente, con una reputación tan tortuosa como sus maniobras en situaciones peligrosas.

Majestueux navire glissant sur la mer infinie, la PERLE NOIRE est un vaisseau rapide et résistant avec une réputation aussi tortueuse que ses manœuvres dans les situations dangereuses.

Die SCHWARZE PERLE, ein grandioses Schiff, das über das grenzenlose Meer gleitet, ist ein schnelles, unverwundliches Fahrzeug mit einer Geschichte, die so verschlungen ist wie ihre Wendigkeit in gefährlichen Lagen.

De ZWARTE PAREL, als een majestueuze maagd over de eindeloze zee glijdend, is een snel en veerkrachtig vaartuig met een verleden dat even kronkelig is als haar wendbaarheid in gevaarlijke situaties.

Una fanciulla maestosa che corre sul mare infinito, la PERLA NERA è un vascello rapido e maneggevole, noto per la sua capacità di serpeggiare e la sua manovrabilità in situazioni pericolose.

Uma nave majestosa deslizando pelo mar ilimitado, a PÉROLA NEGRA é uma embarcação rápida e forte, com uma história tão tortuosa como a sua manobrabilidade em situações perigosas.

Battle Damage
Daños de la batalla
Dommages de combat
Kampfschaden
Danno di battaglia
Danos de combate



1070
Flagship Battlers
Flying Dutchman™

1071
Flagship Battlers
Empress™

1057
Mediterranean
Mayhem™

1069
Flagship Battlers
Black Pearl™

1043
Isla de Muerta™

1079
Atlantic
Adventure™

1049
Singapore
Harbor™

1045
Pelegostos
Escape™



© 2007, MEGA Brands Inc.
© and ™ denote trademarks of MEGA Brands Inc.
© y ™ designan la marca registrada y la marca comercial de MEGA Brands Inc.
© et ™ désignent des marques de commerce de MEGA Brands Inc.
© und ™ sind Markenzeichen der Firma MEGA Brands Inc.
© en ™ duiden op handelsmerken van MEGA Brands Inc.
© e ™ indicano dei marchi depositati di MEGA Brands Inc.
© e ™ denotam marcas registradas de MEGA Brands Inc. Printed in China AD010662

DISNEYPIRATES.COM

© 2006 Walt Disney Co. All Rights Reserved

www.megabloks.com/potc