

**MEGA
BLOKS**

Disney
PIRATES of the CARIBBEAN
AT WORLD'S END

1067

Flying
Dutchman

6+

240 pcs



- 5x AM1113E
- 9x AM1113NK
- 1x AM0910E
- 18x AM0910NK
- 2x AM0910WR
- 5x AM04663KJ
- 5x AM04663NK
- 42x AM01312WR
- 1x AM02641WR
- 3x AM04815KR
- 1.5" - 4cm 2x AM02611KR
- 1.5" - 4.5cm 1x AM02613KR
- 3x AM02929JG
- 1x AM03157JG
- 1x AM03236WR
- 1x AM03773JG
- 2x M11101JG
- 2x AM04866MM

- 2x AM09013JG
- 2x AM09013NK
- 4x AM09023JG
- 2x AM09023NK
- 2x AM10273JG
- 1x AM03773WR
- 2x AM03773NK
- 3x AM10931DH
- 2x AM10931KN
- 1x AM04245WR
- 2x AM02632LH
- 2x AM03873JG
- 2x AM01495LH
- 6x AS0988724
- 2x AS0988723
- 1x AS0102928
- 2x AS0102927

- 1x AS0362028
- 1x AS0102926
- 1x AS010102
- 2x AM02637LH
- 7x AM01982JG
- 7x AM09493JG
- 1x AM09033JG
- 1x AM09493NK
- 2x AM04758JC
- 1x AM04758JU
- 1x AS0102944
- 4x AM01887WR
- 1x AS0106725
- 4x AS0102930
- 1x AS0102940
- 2x AM01313JZ
- 1x AM04737F

- 1x AS0102943
- 1x AS0102936
- 1x AS0102937
- 1x AS0102921
- 4x AS010188
- 2x AM02676LH
- 2x AS0102941
- 1x AS0102945
- 4x AX010295
- 1x AX010296
- 1x AX010297
- 1x AM02100WR
- 1x AS0102939

- 4x AM04816KR (8" - 20.7cm)
- 2x AM04817KR (10" - 25.5cm)
- 2x AS0366029
- 3x AS0102931
- 2x AS0102942
- 2x AS0102933
- 1x AS010673
- 3x AS0102932
- 1x AS0102920
- 2x AM07469LH
- 1x AS0102913
- 1x AS0102915

- 1x AS0102916
- 1x AS0102912
- 1x AS010292
- 1x AS010671
- 1x AS010297
- 1x AS010299
- 1x AS010296
- 1x AS0102910

- 1x AS010678
- 1x AS010679
- 1x AS010294
- 1x AS0102911
- 1x AS0102914
- 1x AS0106723
- 1x AS0106734
- 1x AS0106735
- 1x AS0106745

Disney
PIRATES of the CARIBBEAN
AT WORLD'S END

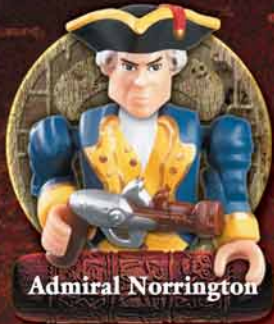

Admiral Norrington



Davy Jones

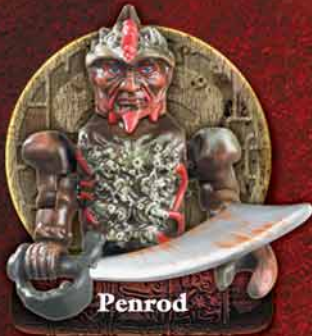

Penrod



Bootstrap Bill



Find the secret webcode!
!Encuentra el código web secreto!
Trouve le code web secret!
Finde den geheimen Web-Code!
Vind de geheime webcode!
Trova il codice web segreto!
Encuentra o código secreto da web!

Please read these instructions carefully before first use and keep them for future reference. / Leer estas instrucciones cuidadosamente antes de la primera utilización y guardarlas para referencia futura. / Il est recommandé de lire attentivement ce feuillet avant la première utilisation et de le conserver pour référence future. / Die Gebrauchsanleitung bitte durchlesen und aufbewahren. / Wij raden u aan deze handleiding zorgvuldig te lezen en te bewaren voor eventuele raadpleging op een later tijdstip. / Leggere le istruzioni prima di cominciare ad usare il gioco e conservarle per referenze future. / Leia as instruções antes do primeiro uso e guarde-as para futura referência.



EN ⚠ **WARNING:**
CHOKING HAZARD. - Small parts.
Not for children under 3 years.

ES ⚠ **ADVERTENCIA:**
PELIGRO DE ASFIXIA. - Contiene piezas pequeñas.
No recomendado para niños menores de 3 años.

FR ⚠ **AVERTISSEMENT:**
RISQUE DE SUFFOCATION. - Présence de petits éléments.
Ne convient pas aux enfants de moins de 3 ans.

DE ⚠ **WARNUNG:**
ERSTICKUNGSGEFAHR. - Enthält kleine Teile.
Nicht für Kinder unter 3 Jahren geeignet.

NL ⚠ **WAARSCHUWING:**
VERSTIKKINGSGEVAAR. - Bevat kleine onderdelen.
Niet geschikt voor kinderen onder de 3 jaar.

DA ⚠ **ADVARSEL:**
KVÆLNINGSFARE. - Indeholder smådele.
Ikke til børn under 3 år.

EL ⚠ **ΠΡΟΕΙΔΟΠΟΙΗΣΗ:**
ΚΙΝΔΥΝΟΣ ΠΝΕΙΜΑΤΟΣ. - Περιέχει μικρά αντικείμενα.
Όχι για παιδιά κάτω των 3 ετών.

FI ⚠ **VAROITUS:**
TUKEHTUMISVAARA. - Sisältää pieniä osia.
Ei alle 3-vuotiaalle lapsille.

IT ⚠ **ATTENZIONE:**
PERICOLO DI SOFFOCAMENTO. - Contiene piccole parti.
Non indicato per bambini sotto i 3 anni.

NO ⚠ **ADVARSEL:**
KVÆLNINGSFARE. - Inneholder små deler.
Kun for barn over 3 år.

PT ⚠ **ATENÇÃO:**
PERIGO DE ASFIXIA. - Contém peças pequenas.
Não é concebido para crianças de menos de 3 anos.

SV ⚠ **VARNING:**
KVÄVNINGSRISK. - Innehåller små delar.
Inte för barn under 3 år.

JA ⚠ **警告:**
窒息の危険性 小さな部品が含まれています
3歳以下の子供には与えないで下さい。

ZH ⚠ **警告:**
有窒息危險。包含有小部件
不适合3岁以下的小孩玩。

LIFETIME GUARANTEE / GARANTIZADO DE POR VIDA / GARANTIE À VIE / LEBENSLANGE GARANTIE / LEVENSLANGE GARANTIE / GARANZIA A VITA / TEM GARANTIA VITALÍCIA
COMMENTS, QUESTIONS ? / COMENTARIOS, PREGUNTAS ? / COMMENTAIRES, QUESTIONS ? / KOMMENTARE, FRAGEN ? / COMMENTAAR, VRAGEN ? / COMMENTI, DOMANDE ? / PERGUNTAS ? / COMENTÁRIOS ?
1-800-465-MEGA
U.S. & Canada only / Solamente en EEUU y Canadá / É.U. et Canada seulement / Nur für U.S. und Kanada / Uitsluitend in de V.S. en Canada / USA e Canada solamente / Somente EE.UU. e Canadá
www.megabloks.com



Disney
PIRATES *of the* **CARIBBEAN**
AT WORLD'S END

Ominous, dark, terrifying, the sinister Flying Dutchman is armed with legendary weaponry and brings forth a wave of destruction for all who cannot steer clear of its path.

Inquietante, oscuro, terrorífico, el siniestro Holandés Volante está armado con armas legendarias y provoca una ola de destrucción entre quienes no pueden evitar su paso.

Menaçant, sombre et terrifiant, le sinistre Hollandais volant possède des armes légendaires et amène une vague de destruction à tous ceux qui ne peuvent s'écarter de son chemin.

Der unheilverkündende Fliegende Holländer ist drohend, düster und furchterregend, und mit legendären Waffen ausgerüstet. Gegen alle, die ihm im Weg sind, löst er eine Welle der Zerstörung aus.

De Vliegende Hollander is onheilspellend, duister, en angstaanjagend, en uitgerust met legendarische bewapening. Zij veroorzaakt een golf van vernieling voor allen die niet uit de weg kunnen.

Minaccioso, oscuro, terrificante, il sinistro Olandese Volante è munito di armi leggendarie e porta con sé un'onda di distruzione per tutti quelli che non possono tenersi fuori dal suo cammino.

Ominoso, escuro, aterrorizante, o sinistro Holandês Voador está armado com armamento legendário e traz consigo uma onda de destruição para todos que não conseguem se desviar do seu caminho.

1

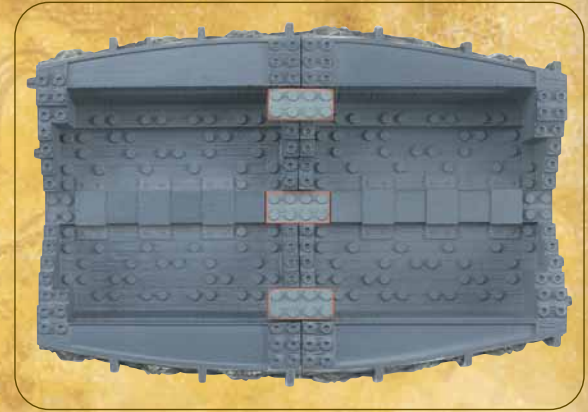
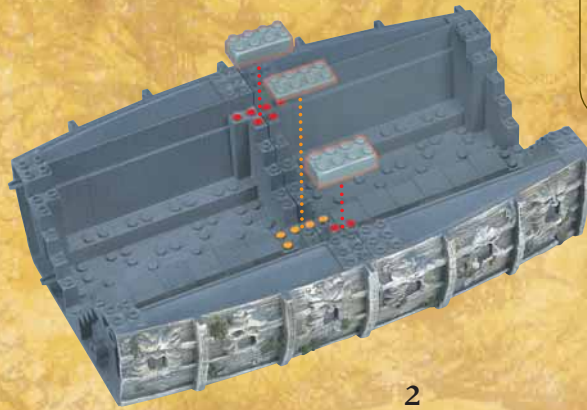
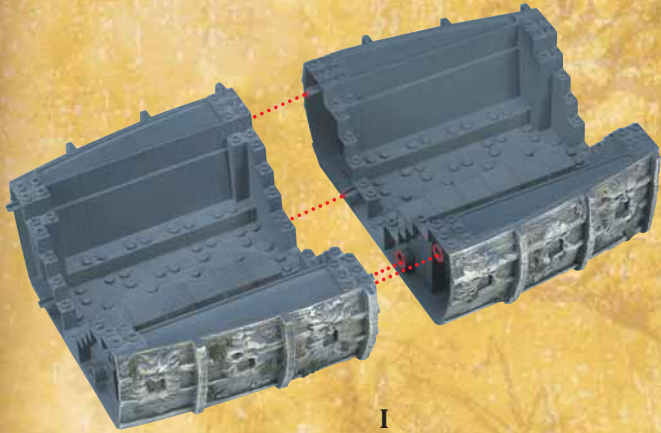

5

2

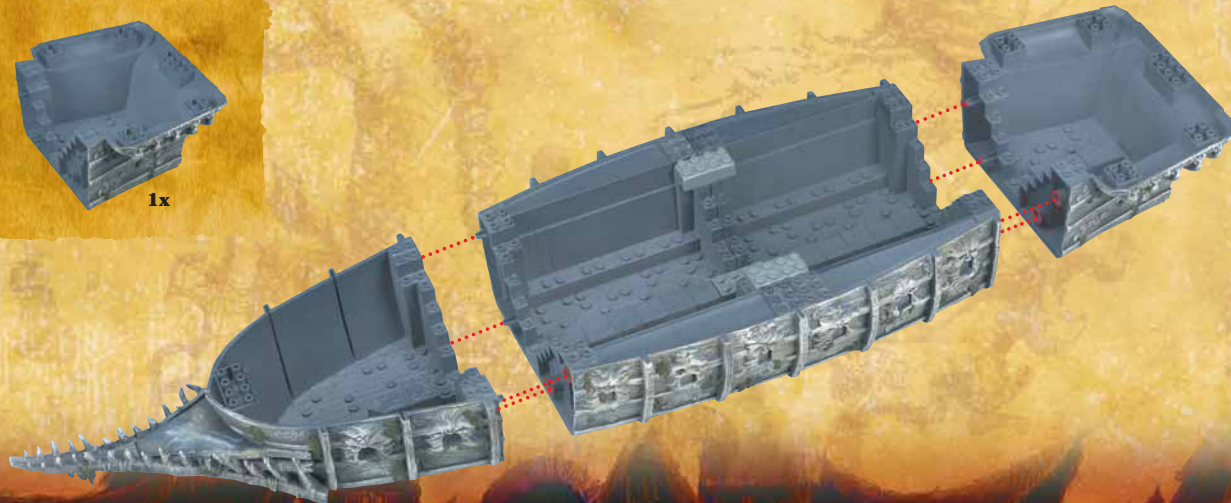
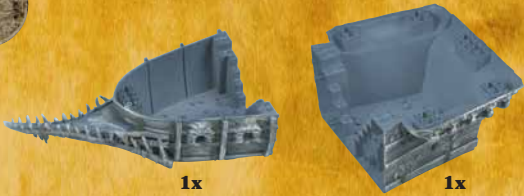

3

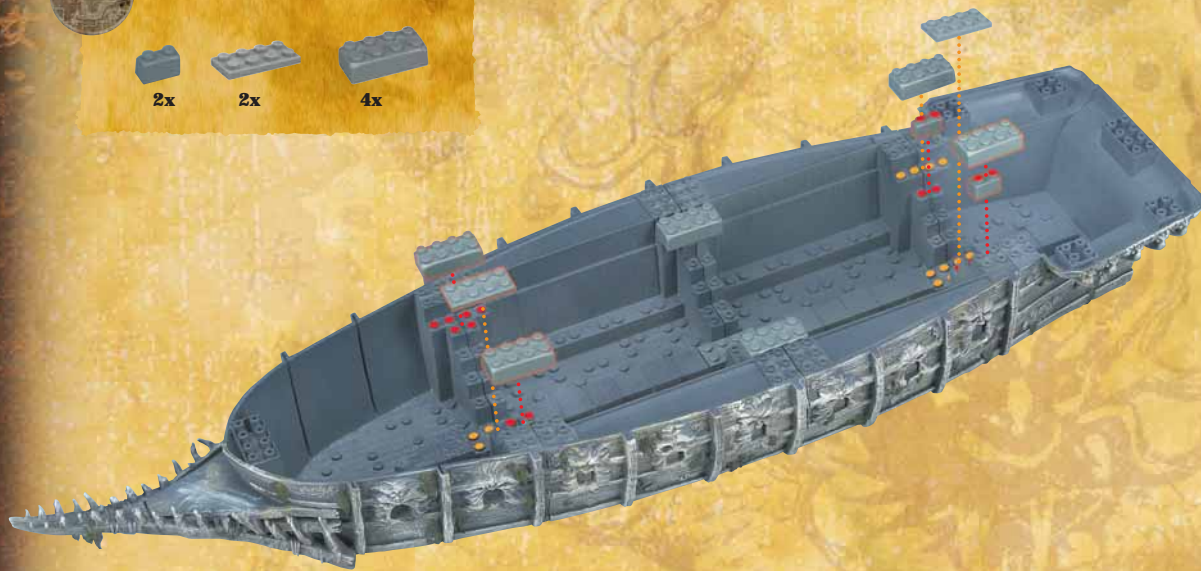

6

4

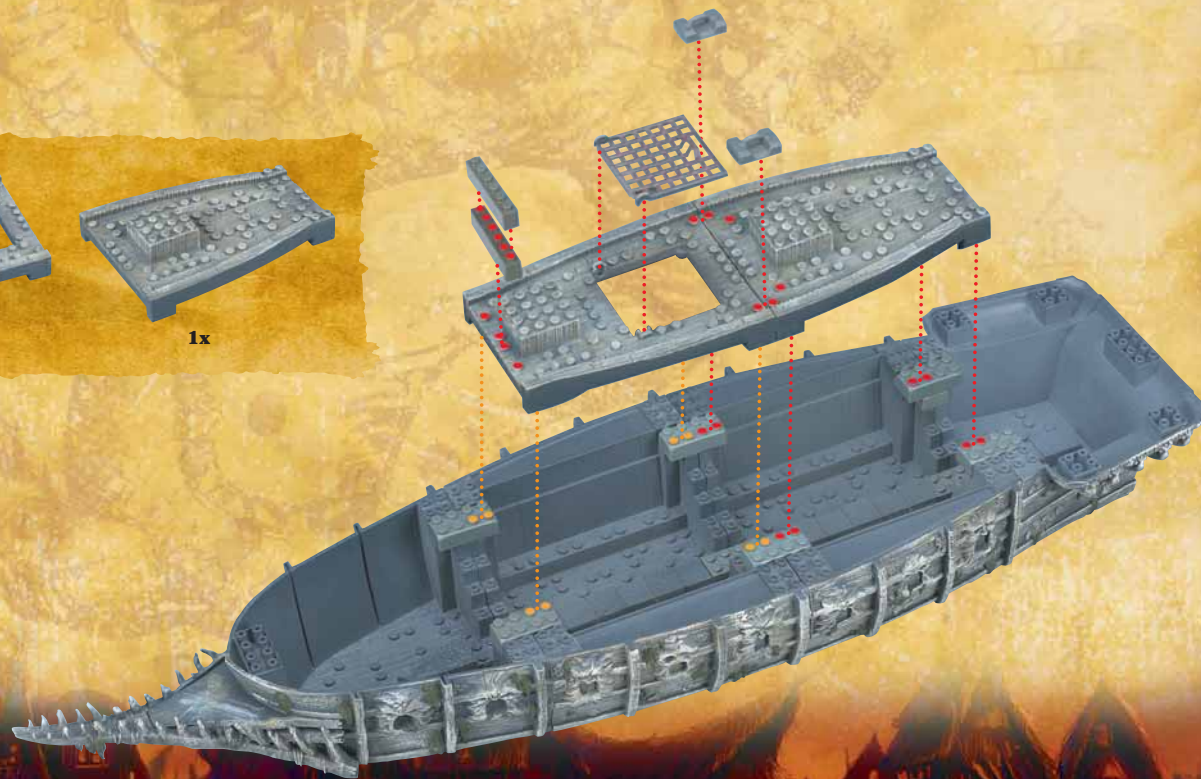

5



7

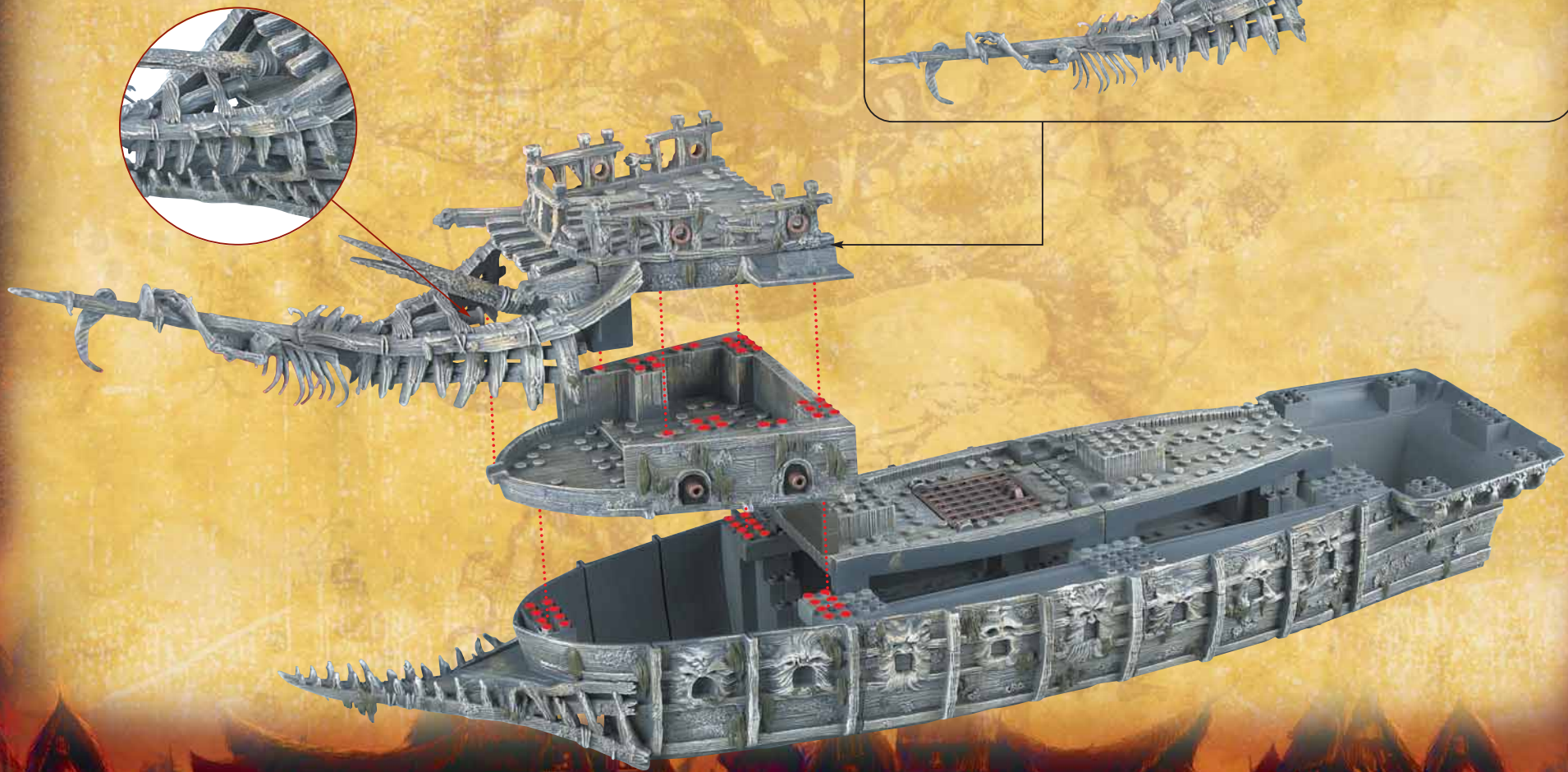
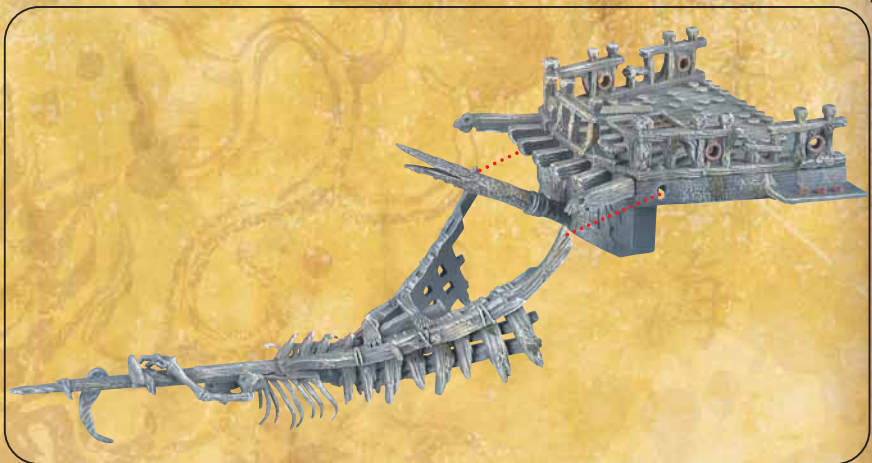

6

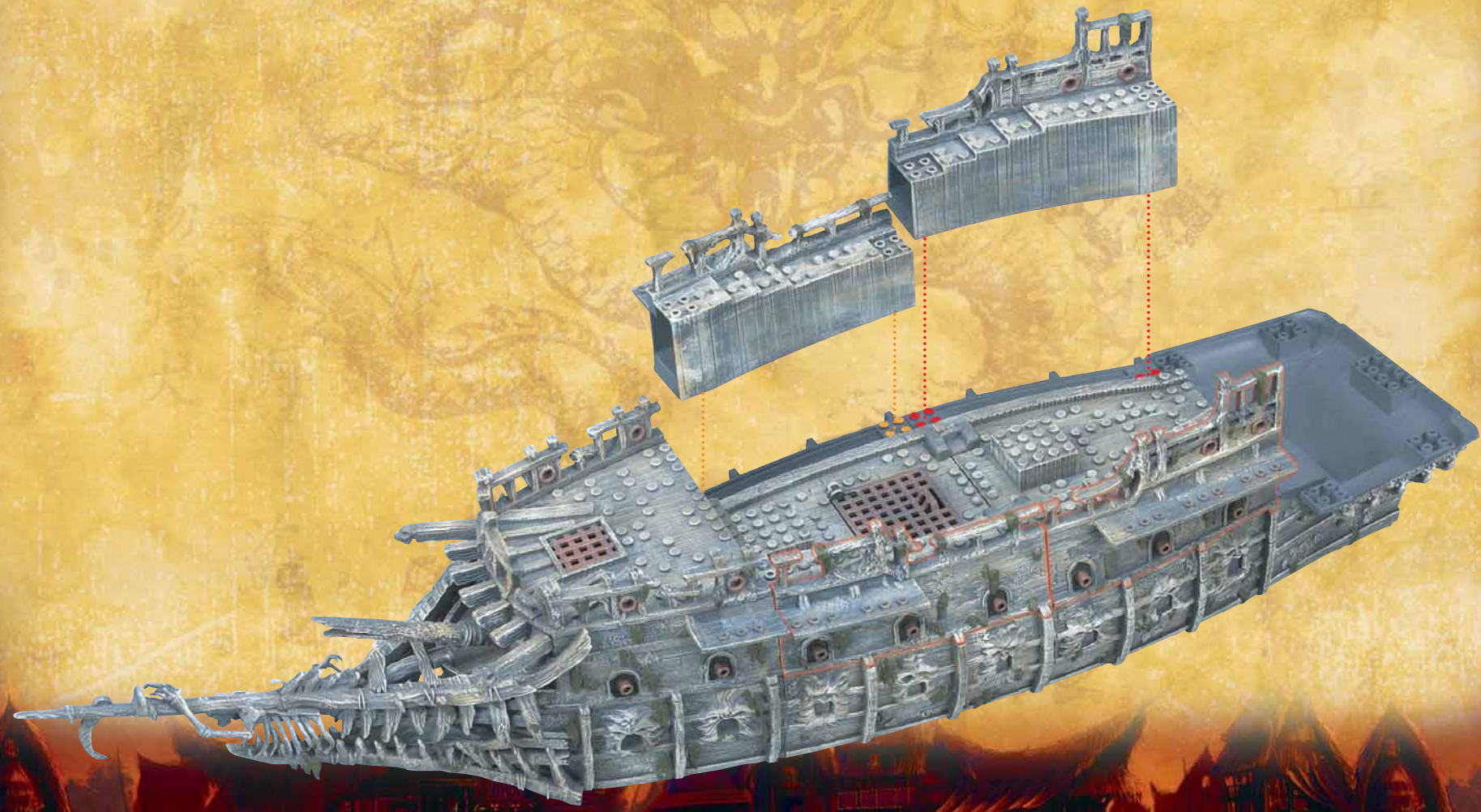
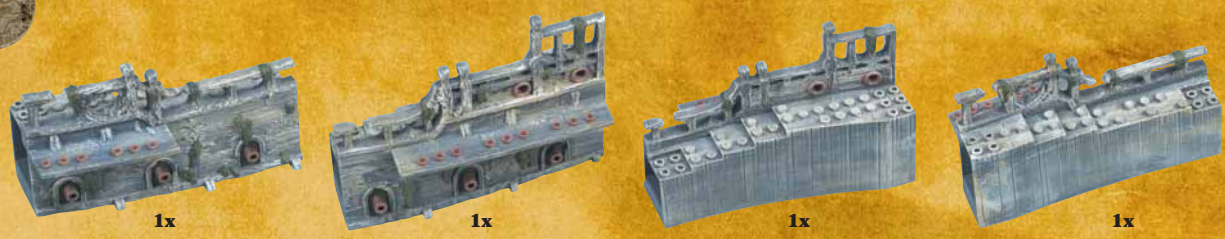

7

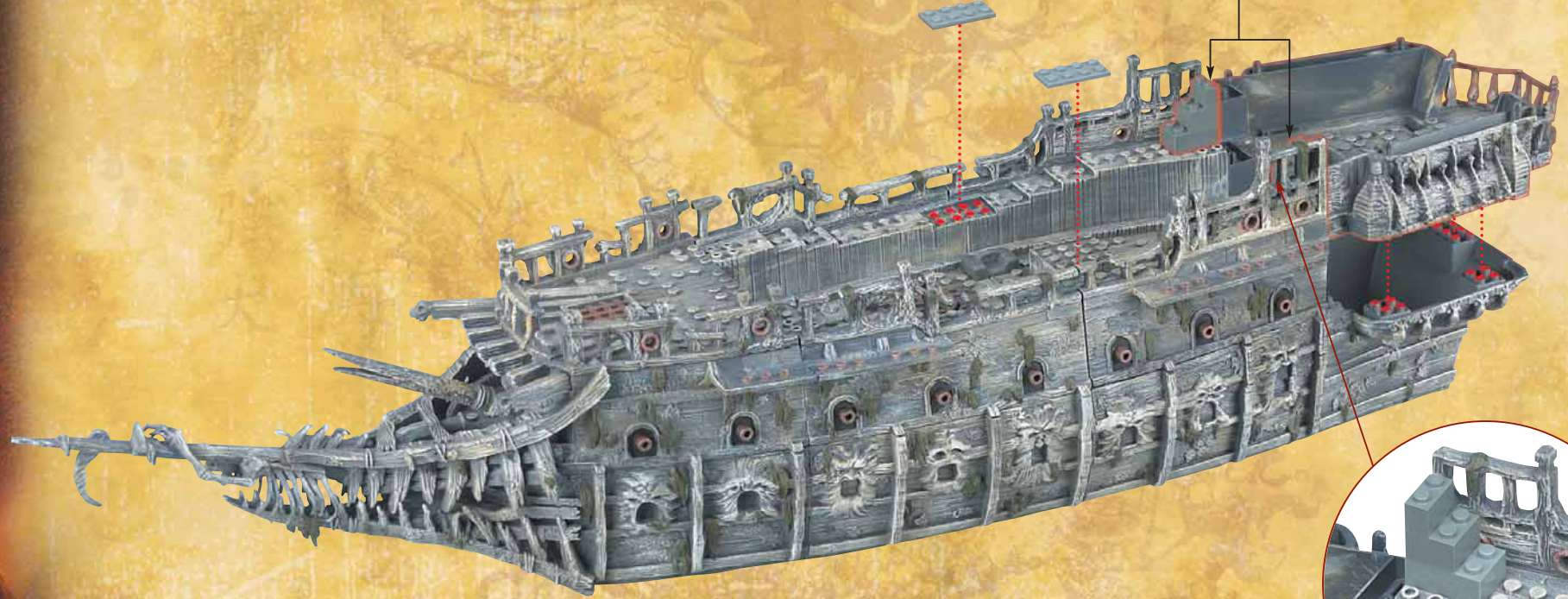
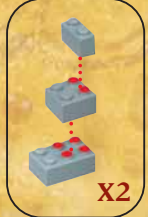
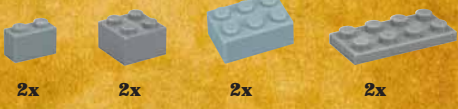

8

5x 9x 1x 18x 2x 1x 2x 2x

2x 1x 2x 1x 1x

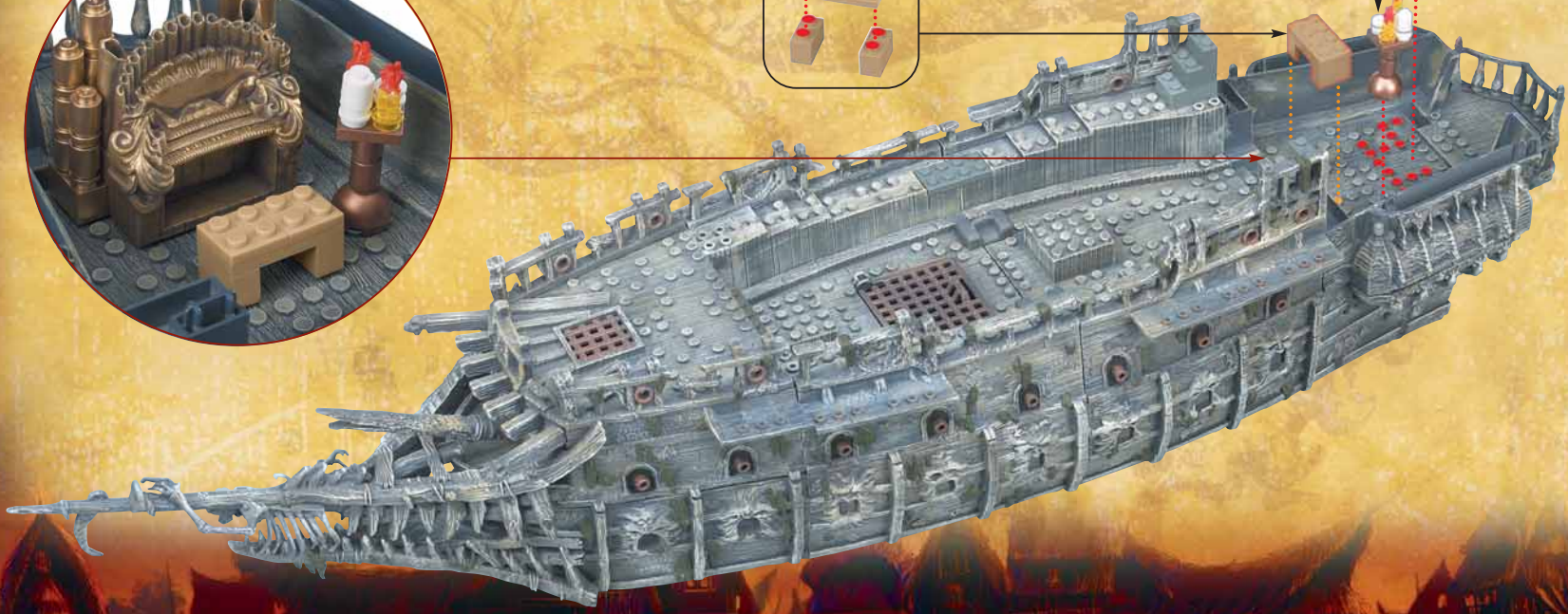
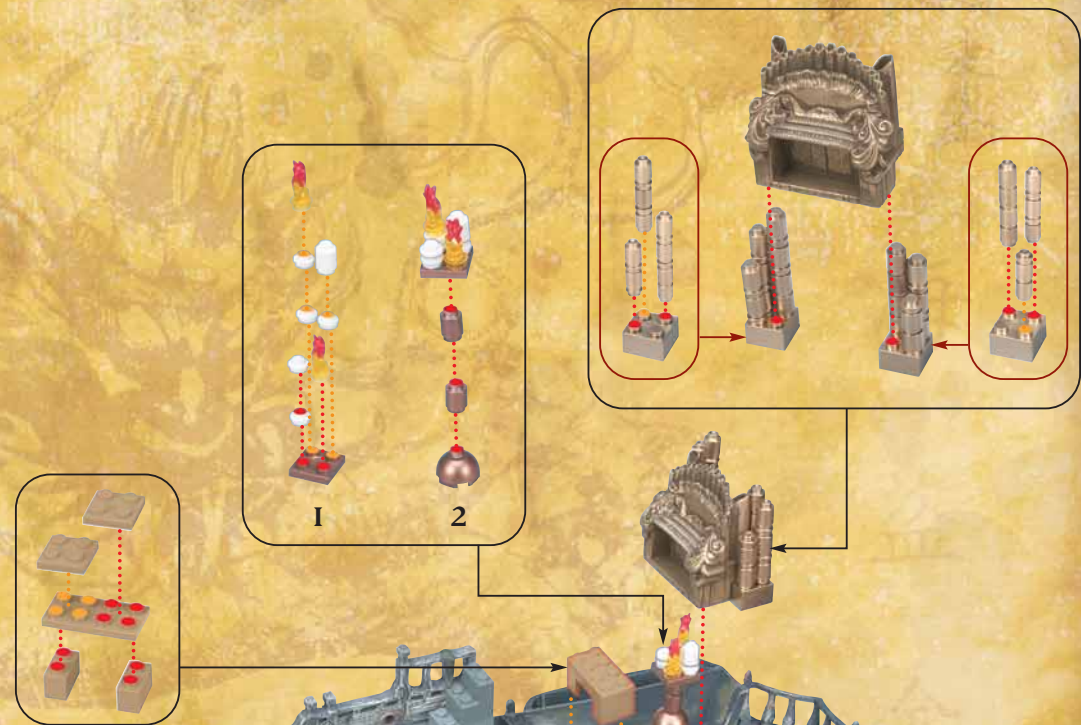

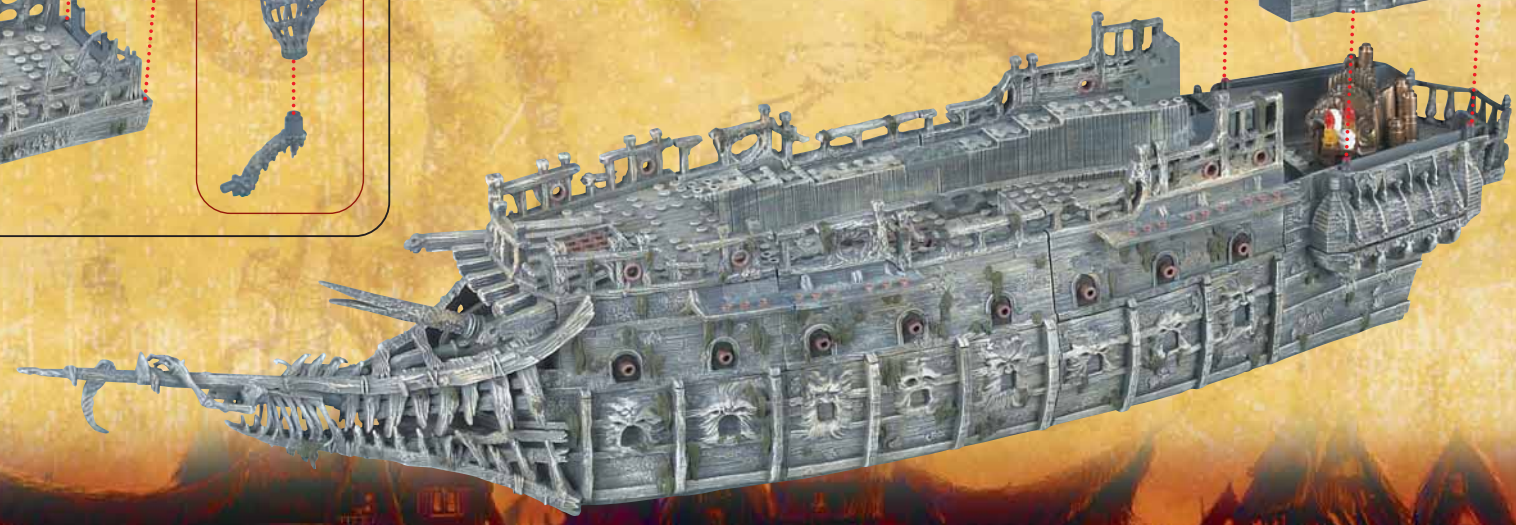
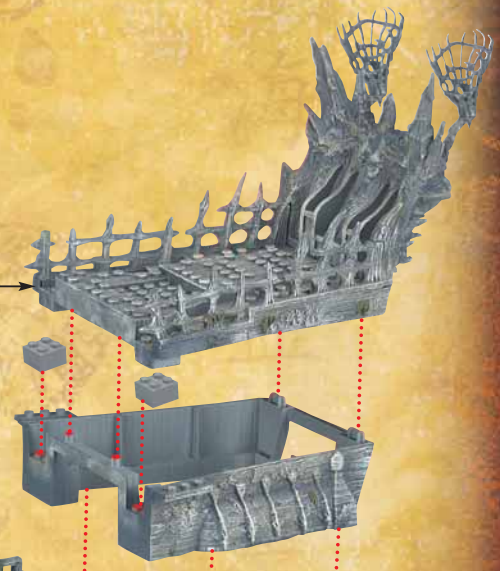
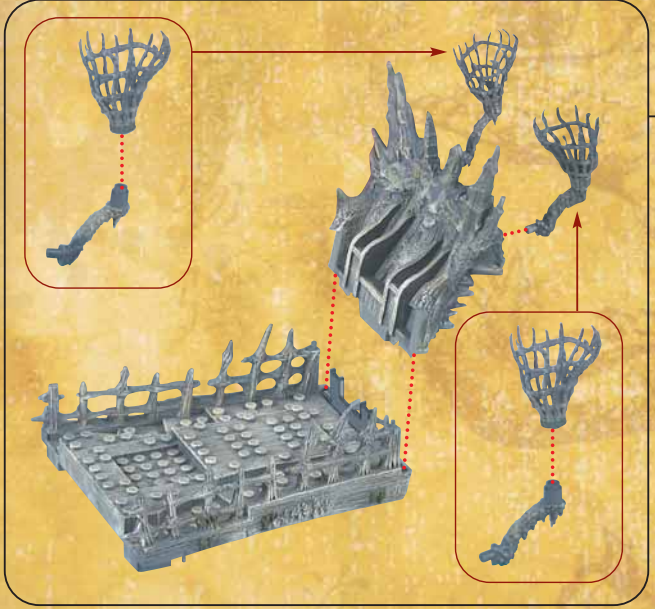
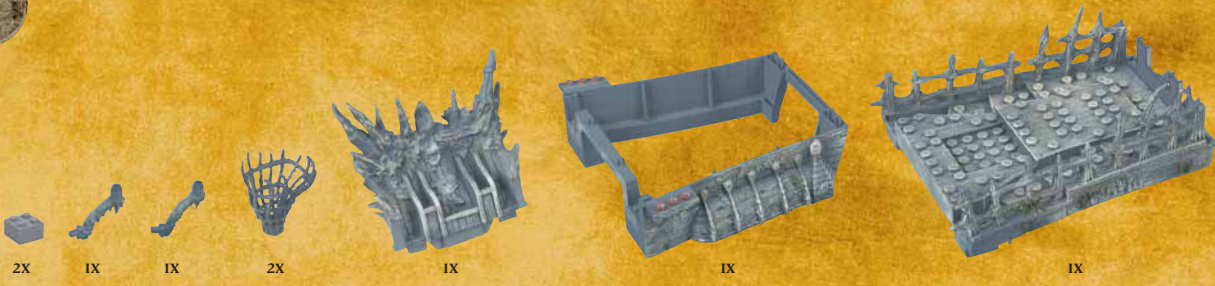

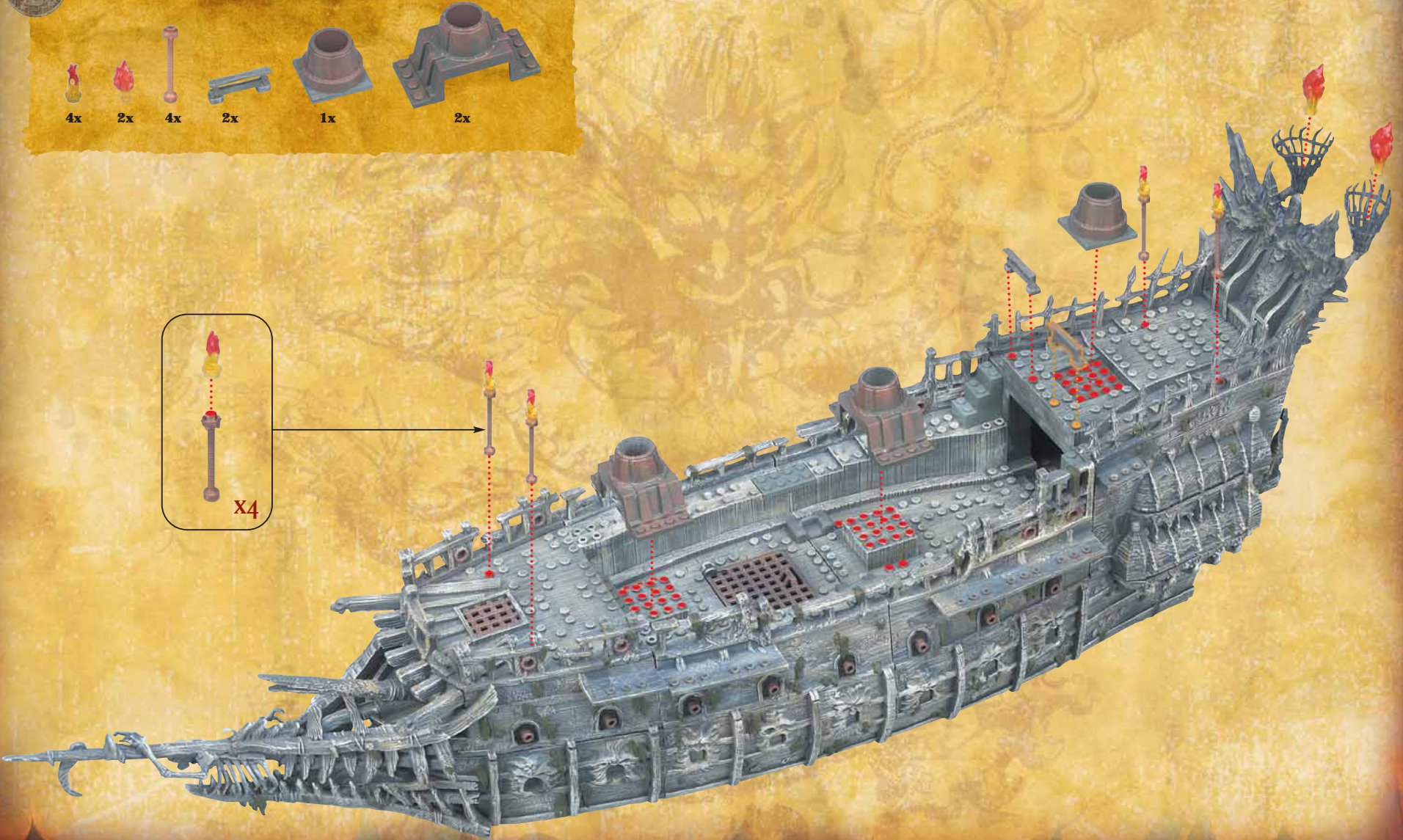

11

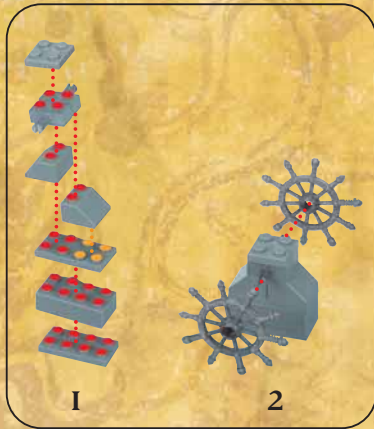

EN CAUTION! Do not aim at eyes or face.
ES ¡ADVERTENCIA! NO dirigir nunca los proyectiles hacia los ojos o la cara.
FR ATTENTION! Ne pas viser les yeux ou le visage.
DE VORSICHT! Nicht auf das Gesicht oder die Augen richten.
NL LET OP: Niet op ogen of gezicht richten.
DA ADVARSEL! Peg ikke i retning af øjne eller ansigt.
EL ΠΡΟΣΟΧΗ! Να μην σκοπεύετε προς τα μάτια ή το πρόσωπο.
FI VARO! Älä tähtää silmiin tai kasvoihin.
IT Attenzione! Non puntare verso gli occhi o il viso.
NO FØRSIKTIG! Sik ikke mot øyne eller ansikt.
PT ATENÇÃO: Não apontar para os olhos ou o rosto.
SV VAR FÖRSIKTIG! Rikta inte med ögon eller ansikte.
JA 注意! 目や顔に使用しないで下さい。
ZH 警告! 不要对准眼睛或脸。

Use only the projectiles included with this toy. / Utilizar solamente los proyectiles incluidos con el juguete. / Utiliser seulement les projectiles fournis avec le jouet. / Nur die mit dem Spielzeug mitgelieferten Projektile verwenden. / Alleen de met het speelgoed bijgeleverde projectielen gebruiken. / Utilizzare soltanto i proiettili forniti con questo giocattolo. / Usar somente os projéteis incluídos com este brinquedo.

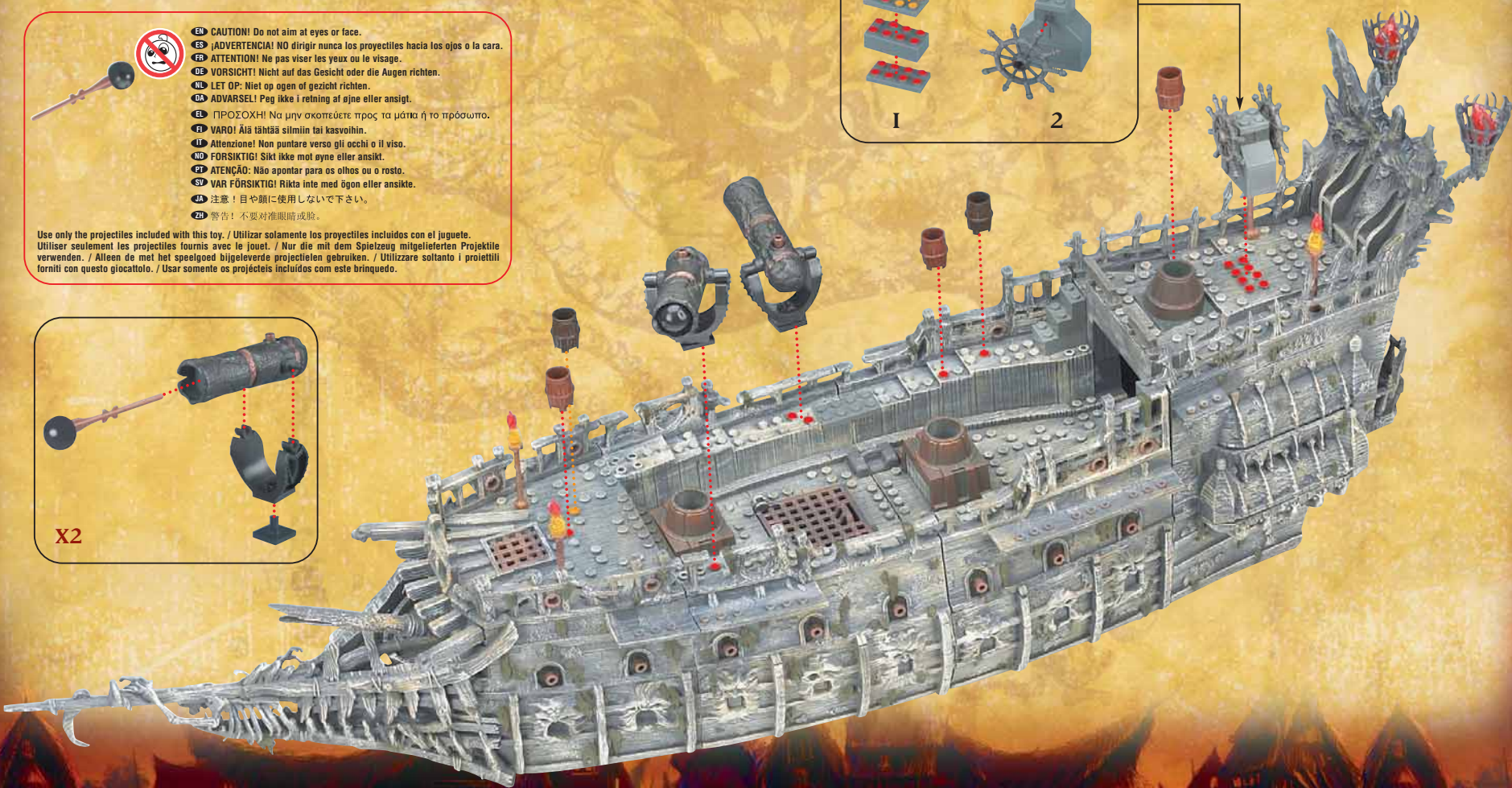
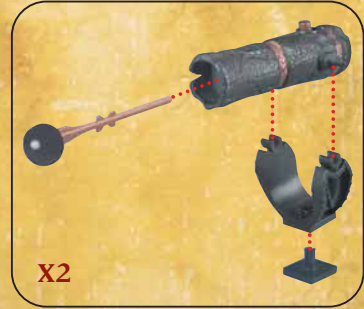

11

- 
1x
- 
1x
- 
1x
- 
1x
- 
1x
- 
1x
- 
1x
- 
1x

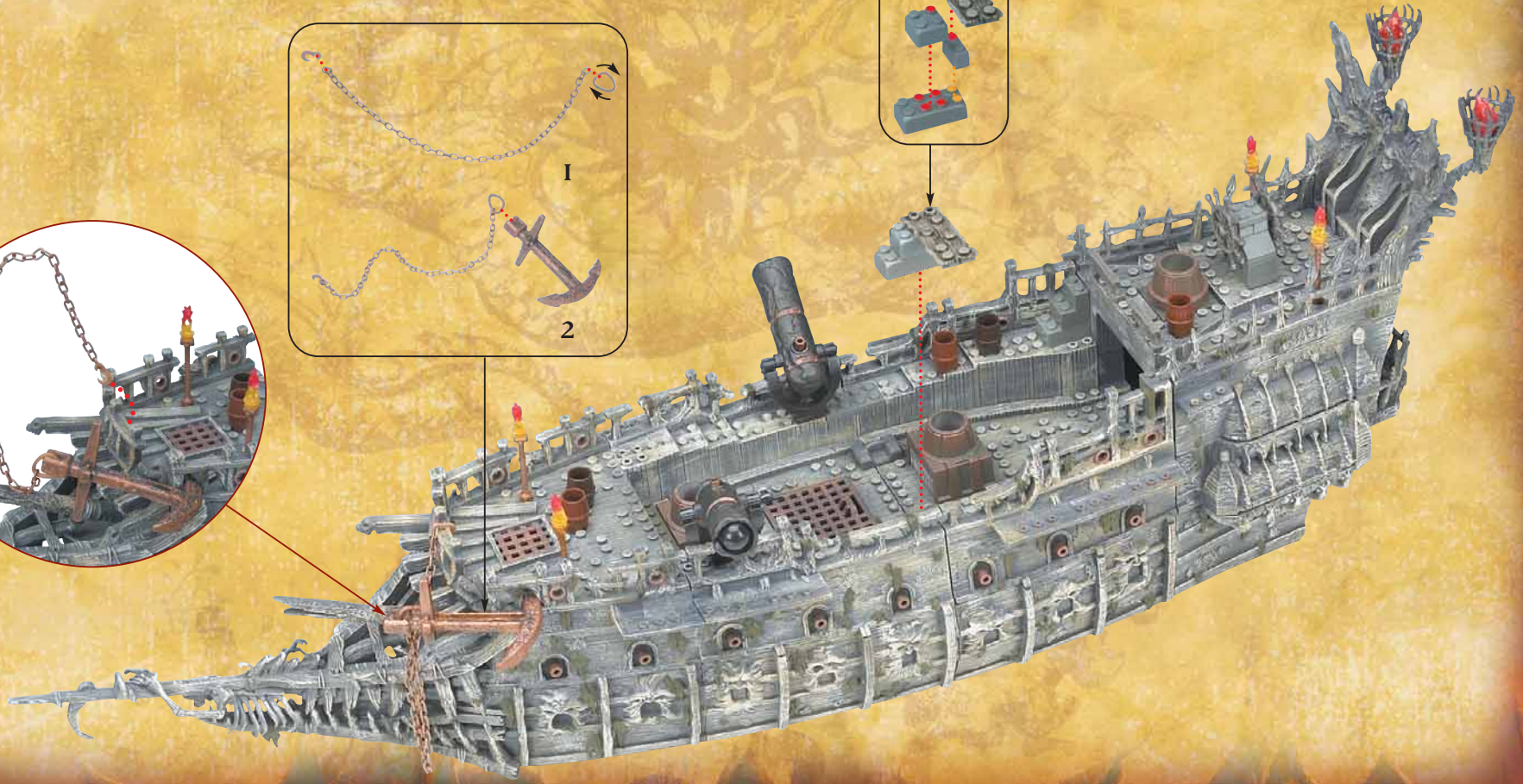
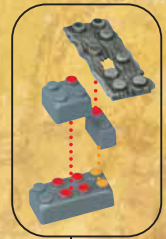

13



21x

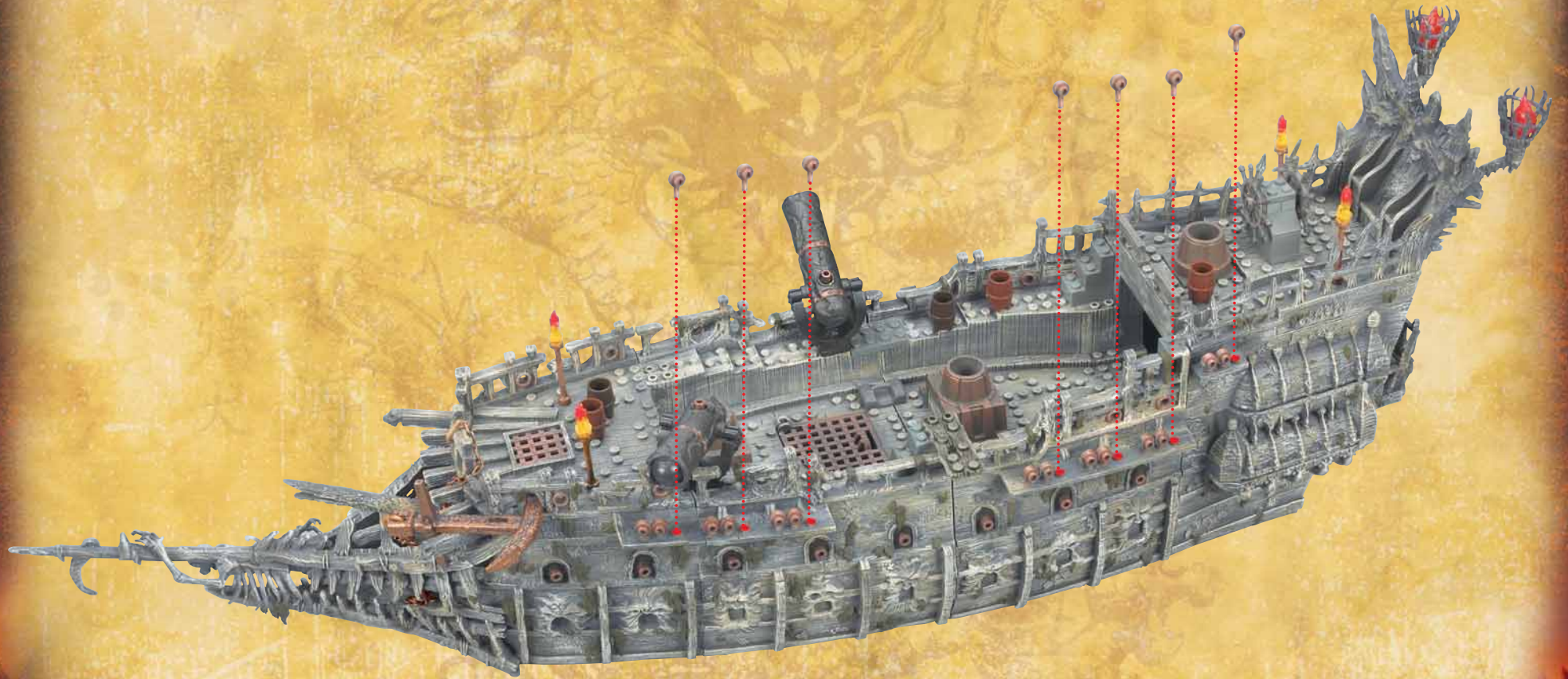

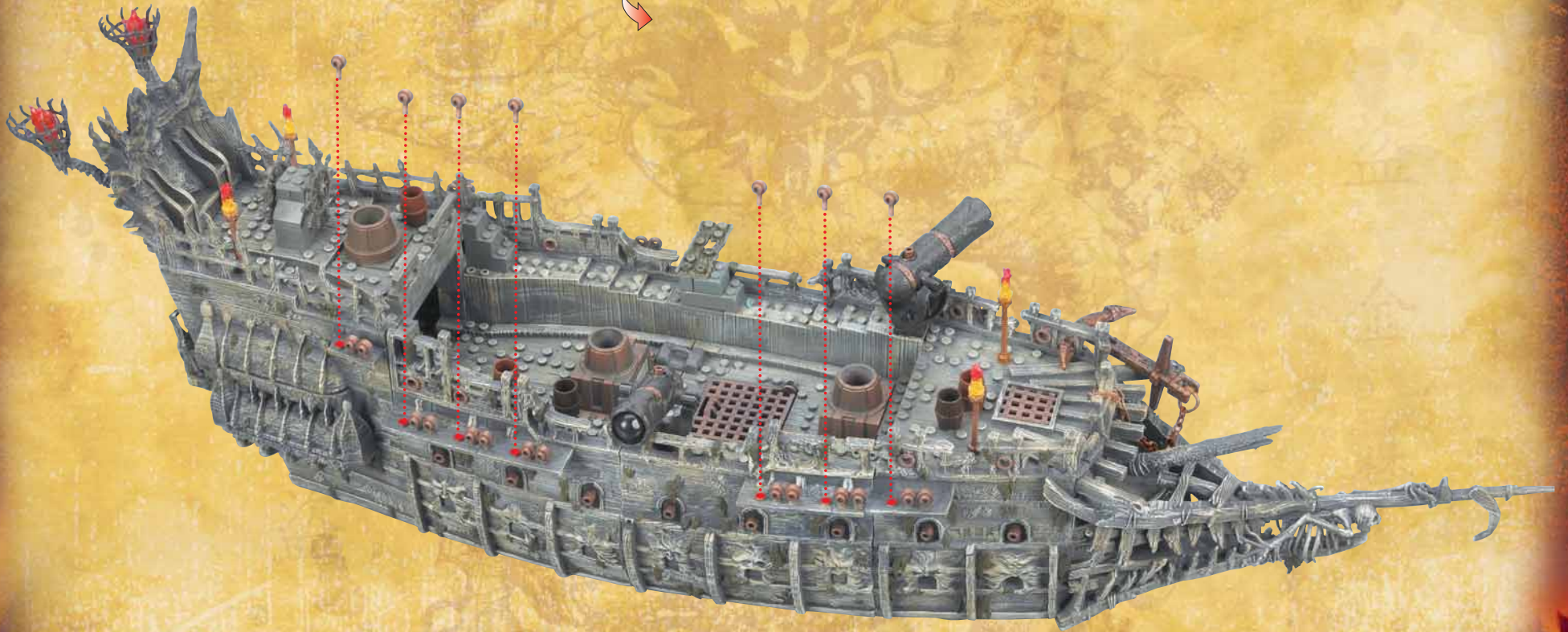

15

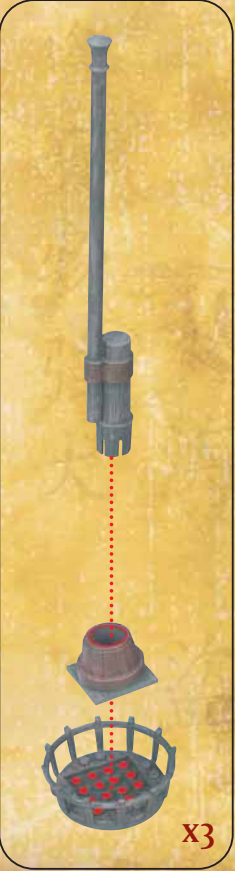
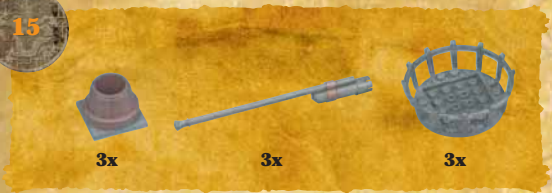

16

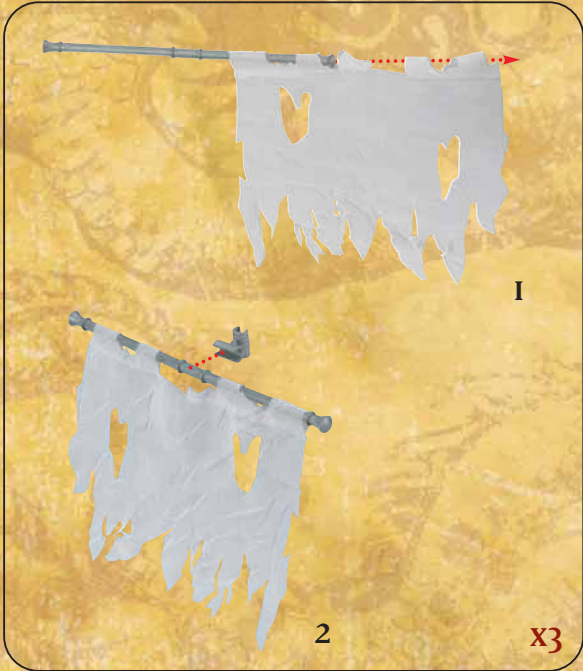
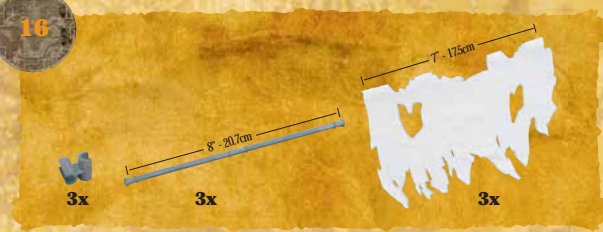

17

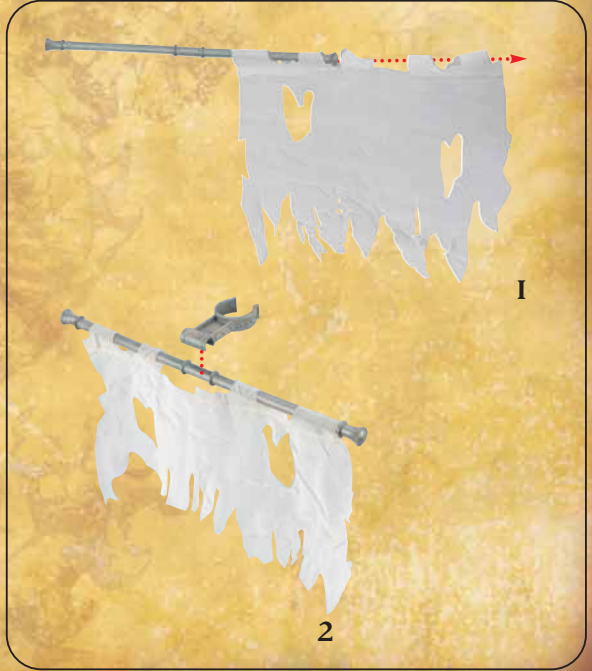

18

2x

2x

2x

10,75 - 27cm

9 - 23cm

19

1x

15

18

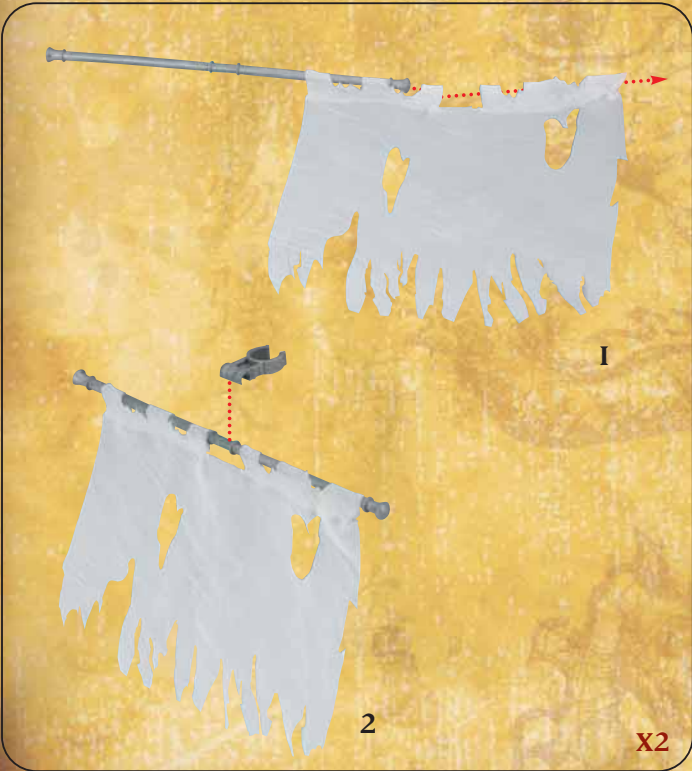



16

17

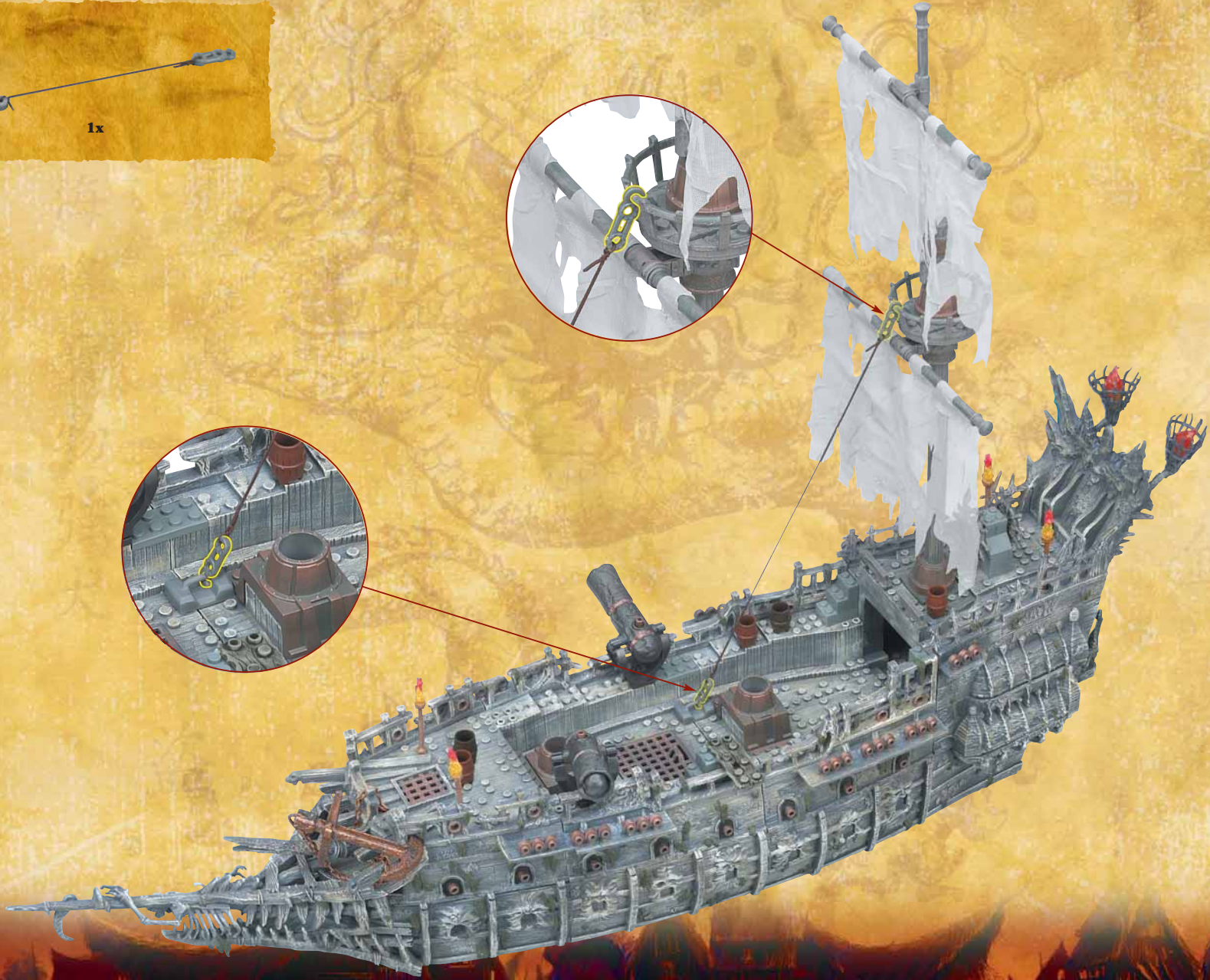
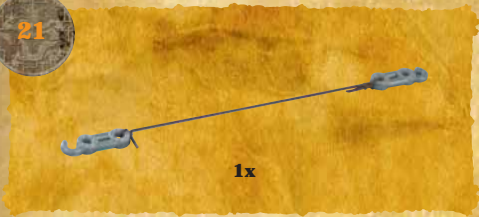

22



1x

15





16

18



1x



1x

15





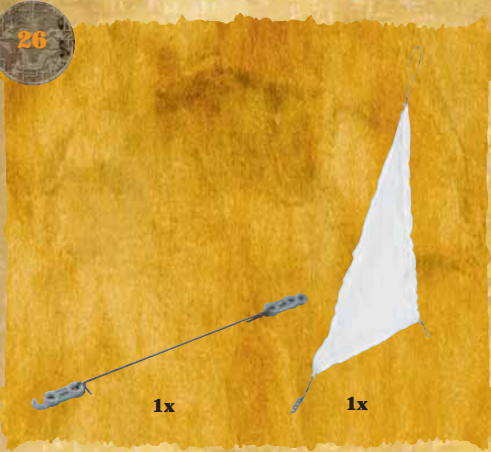





GLOW IN THE DARK!
FOSFORESCENTE!
PHOSPHORESCENT!
PHOSPHORESZIEREND!
FOSFORESCENTE!
FOSFORESCENTE!



COLOR CHANGE!
CAMBIA DE COLOR!
CHANGEMENT DE COULEUR!
FARBENWECHSEL!
DE KLEUR VERANDERT!
CAMBIA COLORE!
MUDANÇA DE COR!





Disney PIRATES OF THE CARIBBEAN AT WORLD'S END

Flying Dutchman

1067



Admiral Norrington



Davy Jones



Pernod



Bootstrap Bill



Glow in the dark!
Fosforescent! / Phosphorescent!
Phosphoreszierend! / Fosforescent!
Fosforescent! / Fosforescerend!

Ominous, dark, terrifying, the sinister Flying Dutchman is armed with legendary weaponry and brings forth a wave of destruction for all who cannot steer clear of its path.

Inquietante, oscuro, terrorífico, el siniestro Holandés Volante está armado con armas legendarias y provoca una ola de destrucción entre quienes no pueden evitar su paso.

Menaçant, sombre et terrifiant, le sinistre Hollandais volant possède des armes légendaires et amène une vague de destruction à tous ceux qui ne peuvent s'écarter de son chemin.

Der unheilverkündende Fliegende Holländer ist drohend, düster und furchterregend, und mit legendären Waffen ausgerüstet. Gegen alle, die ihm im Weg sind, löst er eine Welle der Zerstörung aus.

De Vliegende Hollander is onheilspellend, duister, en angstaanjagend, en uitgerust met legendarische bewapening. Zij veroorzaakt een golf van vernieling voor allen die niet uit de weg kunnen.

Minaccioso, oscuro, terrificante, il sinistro Olandese Volante è munito di armi leggendarie e porta con sé un'onda di distruzione per tutti quelli che non possono tenersi fuori dal suo cammino.

Ominoso, escuro, aterrador, o sinistro Holandés Voador está armado com armamento legendário e traz consigo uma onda de destruição para todos que não conseguem se desviar do seu caminho.



© 2006, MEGA Brands Inc.
© and ™ denote trademarks of MEGA Brands Inc.
© y ™ designan la marca registrada y la marca comercial de MEGA Brands Inc.
© et ™ désignent des marques de commerce de MEGA Brands Inc.
© and ™ sind Markenzeichen der Firma MEGA Brands Inc.
© en ™ duiden op handelsmerken van MEGA Brands Inc.
© e ™ indicano del marchio depositato di MEGA Brands Inc.
© e ™ denotam marcas registradas de MEGA Brands Inc.

www.megabloks.com/potc

DISNEYPIRATES.COM

Printed in China AD010671

© Disney