

# Probuilder®



8+ | 291  | 3249 | Eurofighter Typhoon™



1x  
AM01113X

4x  
AM01140BLG

2x  
AM07223BDG

4x  
AM022501BDG

2x  
AM022501BLG

1x  
AM07590F

8x  
AM07590BDG

1x  
AM07659F

2x  
AM09946BLG

2x  
AM03062BLG

6x  
AM01417BLG

2x  
AM03019F

2x  
AM03019BLG

2x  
M11101BLG

1x  
AM09393F

2x  
AM09393BDG

22x  
AM09393BLG

6x  
AM03773BLG

2x  
AS032496

2x  
AS032497

2x  
AM03772BLG

6x  
AM01314BLG

2x  
AM09593F

1x  
AM09593BDG

6x  
AM09593BLG

1x  
AM07475BDG

1x  
AM10273F

1x  
AM01418BDG

3x  
AM08480BDG

8x  
AM01154BLG

5x  
AM01323BDG

20x  
AM08481BDG

4x  
AM01531BDG

17x  
AM09493BLG

3x  
AM09493BDG

3x  
AM09838BDG

8x  
AM01480BLG

4x  
AM01480BDG

2x  
AM01086BDG

6x  
AM01086BLG

4x  
AM07629BDG

1x  
AM09013BYE

4x  
AM09013BDG

6x  
AM09013BLG

2x  
AM01087BDG

6x  
AM01087BLG

1x  
AM01313BDG

4x  
AM01313BLG

2x  
AM09033BYE

10x  
AM09033BDG

6x  
AM09033BLG

3x  
AM15494E

3x  
AM15500F

1x  
AM09825BLG

1x  
AM09826BLG

8x  
AM07475BLG

11x  
AM09292BLG

1x  
AM15251BLG

1x  
AM15250BLG

2x  
AS032498

1x  
AM04244BLG

3x  
AM03764KJ

6x  
M1346BLG

2x  
AM04219BLG

1x  
AM09186BLG

1x  
AM09187BLG

1x  
AM08483BLG

2x  
AM04983F

2x  
AM09923BLG

3x  
AM04984BLG

3x  
AM04985BDG

1x  
AM09924BLG

2x  
AM03759E

2x  
AM03760E

1x  
AS032493

1x  
AS032495

1x  
AS032494

1x  
AM01530BDG

1x  
AM02054BLG

1x  
AM02055BLG



1x  
AS032491



# EUROFIGHTER TYPHOON

Wing span  
Envergadura  
Envergure  
Spannweite  
Spanwijdte  
Apertura alare  
Envergadura de asa

10.95 m / 36'

Speed  
Velocidad  
Vitesse  
Geschwindigkeit  
Snelheid  
Velocità  
Velocidade

Mach 2.0

Weapons  
Armas  
Armes  
Waffen  
Wapens  
Armamenti  
Armamento

Guns: 27 mm Mauser canon  
Armas de fuego: Cañón Mauser de 27 mm  
Armes à feu: canon Mauser 27 mm  
Geschütze: Kanone 27 mm Mauser  
Geweren: 27 mm Mauser-kanon  
Armi: cannone Mauser da 27 mm  
Armas: Canhão Mauser de 27 mm

Air-to-air missiles ("AAM"):  
Mísiles aire-aire ("AAM"):  
Míssiles air-air ("AAM"):  
Luft-Luft-Rakete („AAM“, Air-to-Air Missile):  
Lucht-luchtraketten („AAM“):  
Missili aria-aria ("AAM"):  
Mísseis ar-ar ("AAM"):

BVRAAM (Beyond Visual Range) & SRAAM (Short-Range)  
BVRAAM (más allá del alcance visual) y SRAAM (corto alcance)  
BVRAAM (à longue portée) & SRAAM (à courte portée)  
BVRAAM (Beyond Visual Range, außer Sichtweite) und SRAAM (Short-Range, Kurzstrecke)  
BVRAAM (buiten gezichts bereik) en SRAAM (korte afstand)  
BVRAAM (a lungo raggio) e SRAAM (a corto raggio)  
BVRAAM (além do alcance visual) e SRAAM (curto alcance)

Air-to-surface weaponry:  
Mísiles aire-tierra:  
Armes air-sol:  
Luft-Boden-Rakete:  
Lucht-grondwapens:  
Armamenti aria-superficie:  
Armamento ar-terra:

laser guided bombs; advanced anti-armour weapons  
bombas dirigidas por láser; armas antiblindaje avanzadas  
bombes à guidage laser; armes antichars  
lasergesteuerte Bomben, hochentwickelte Panzerabwehrwaffen  
lasergeleide bommen, geavanceerde antipantserwapens  
bombe a guida laser; armi avanzate anti-carro  
bombas guiadas por laser; armamento anti-blindagem avançado



14.4 in • 37 cm

11.3 in • 29 cm

1

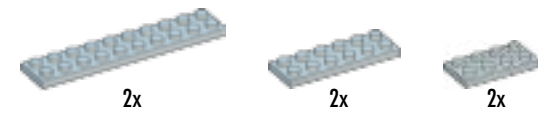
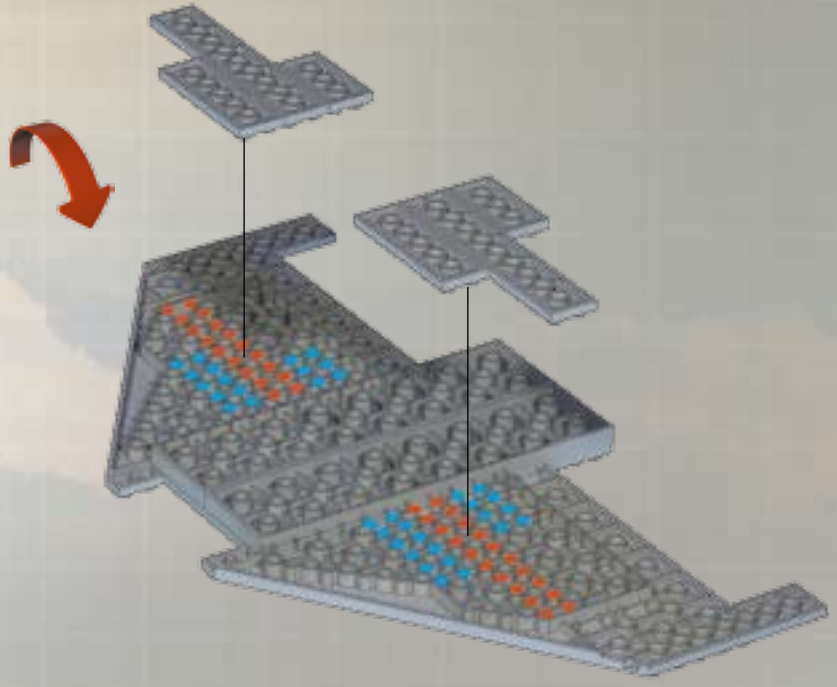
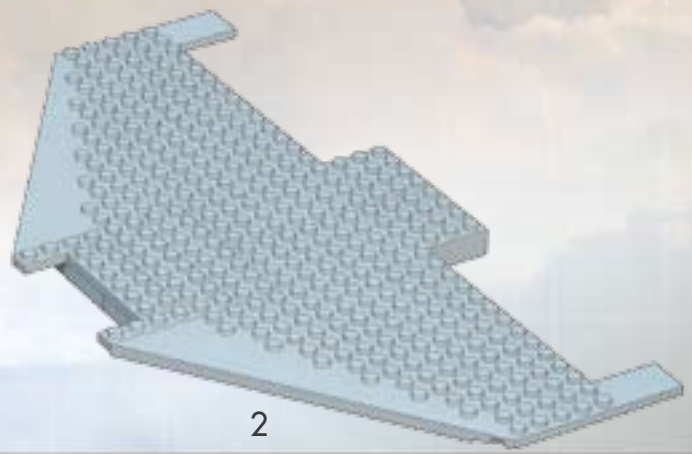
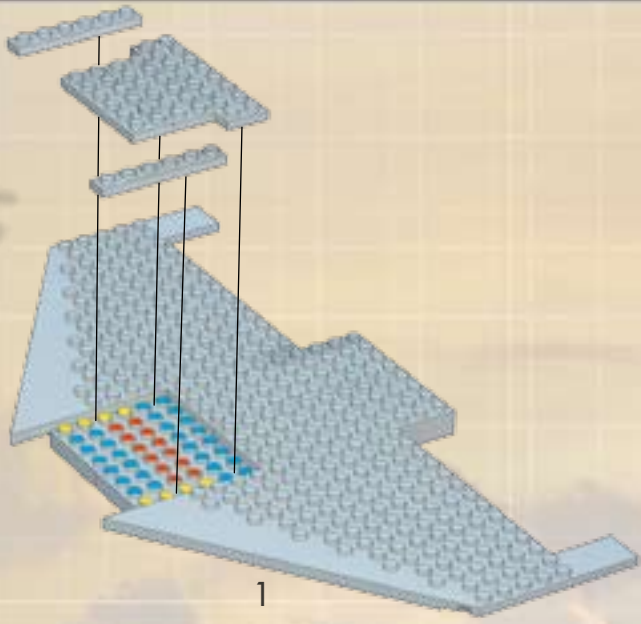
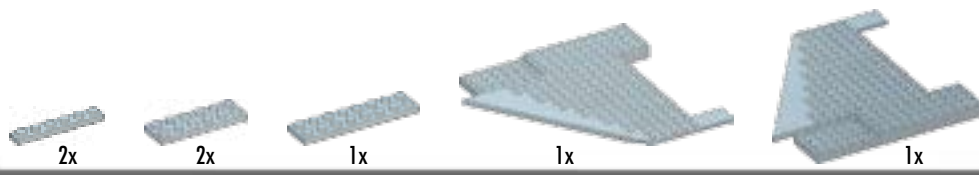

2

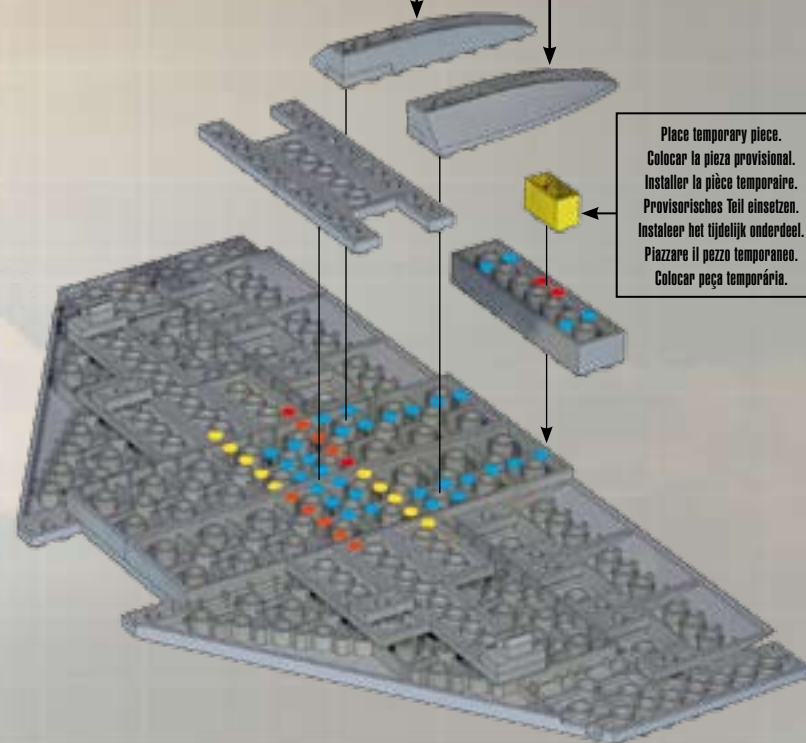
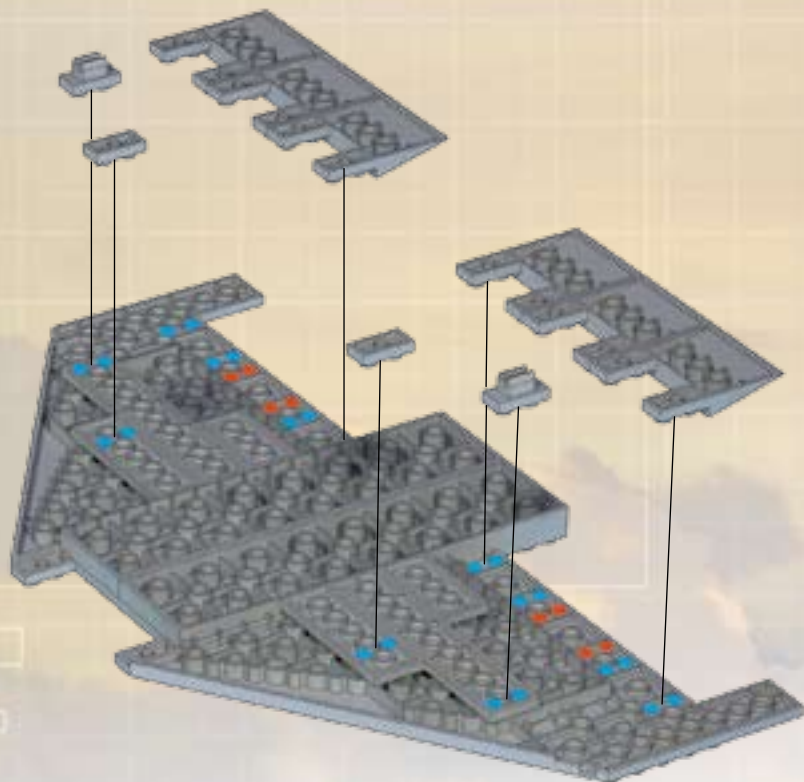
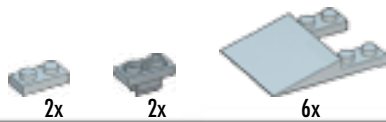

Place temporary piece.  
 Colocar la pieza provisional.  
 Installer la pièce temporaire.  
 Provisorisches Teil einsetzen.  
 Instaleer het tijdelijk onderdeel.  
 Piazzare il pezzo temporaneo.  
 Colocar peça temporária.



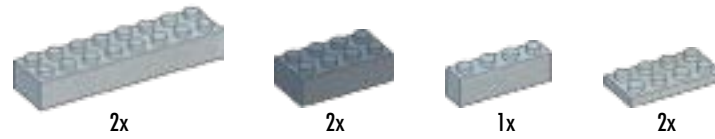
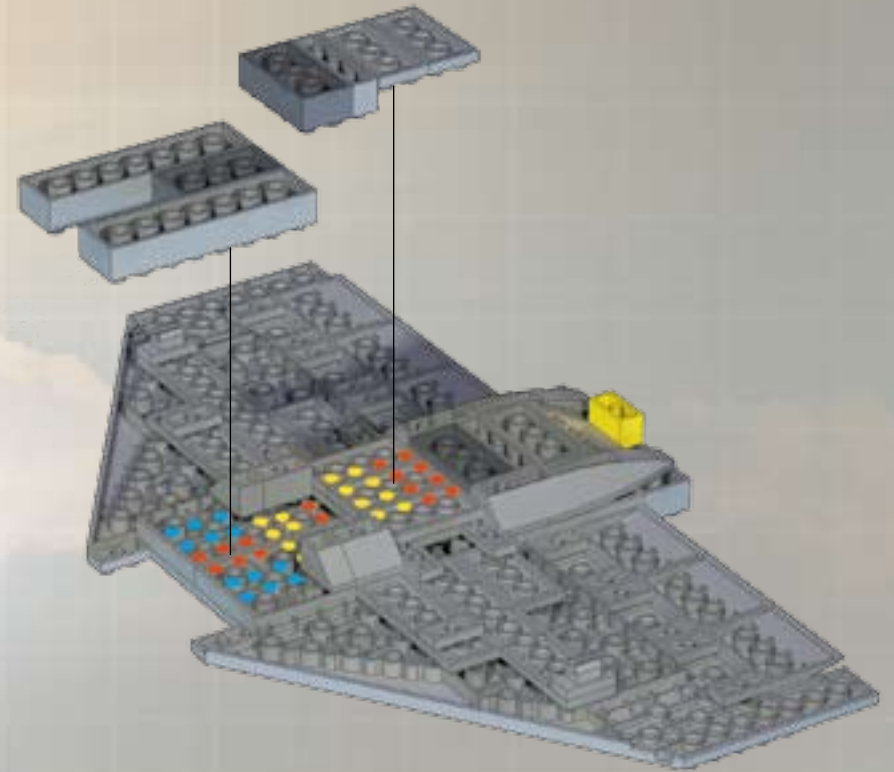
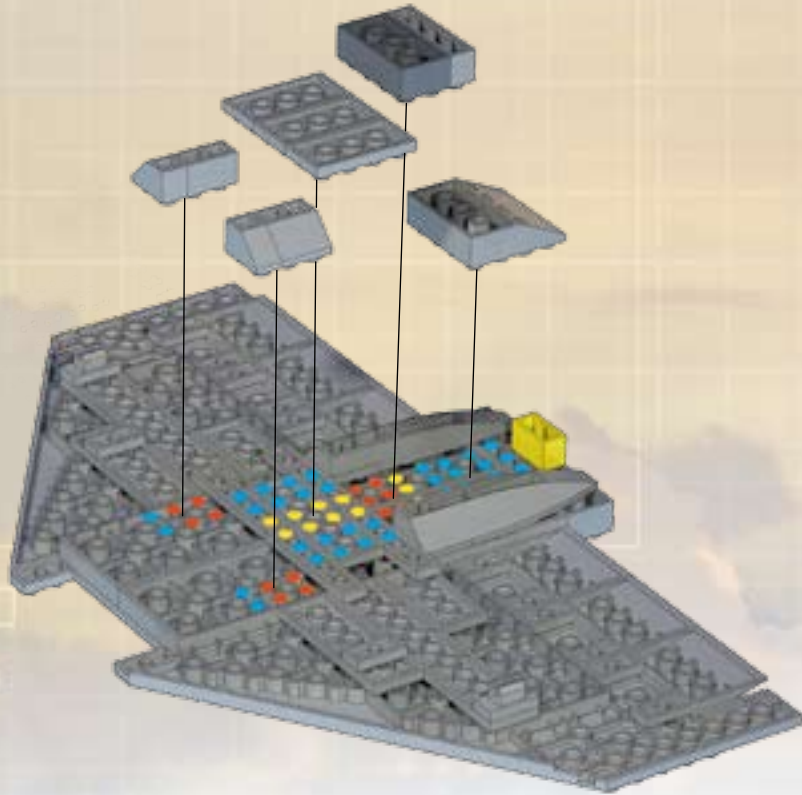
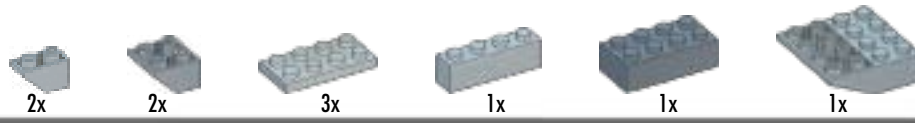

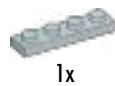
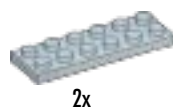
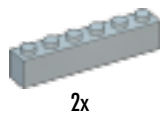
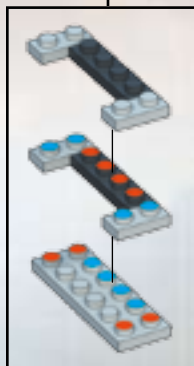
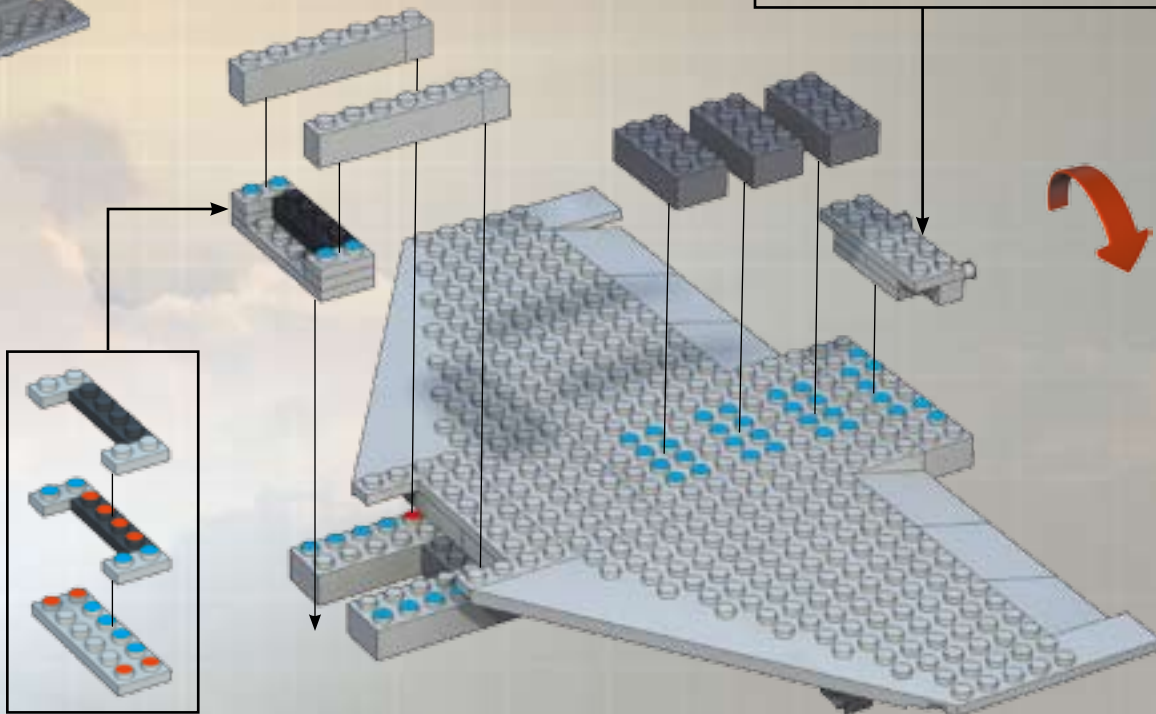
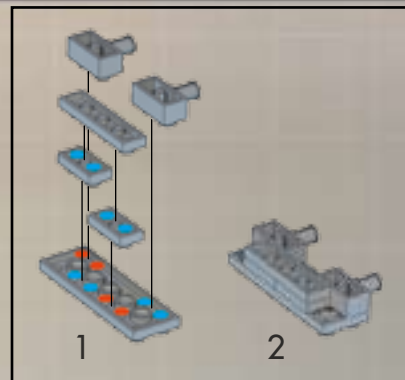



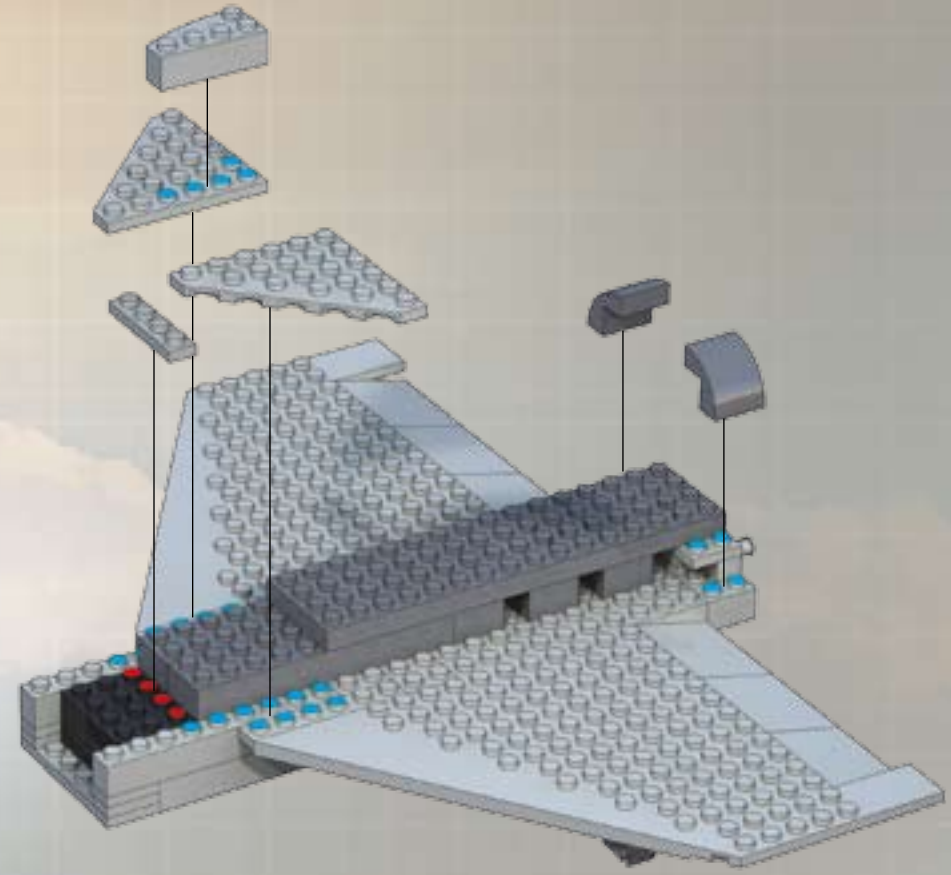
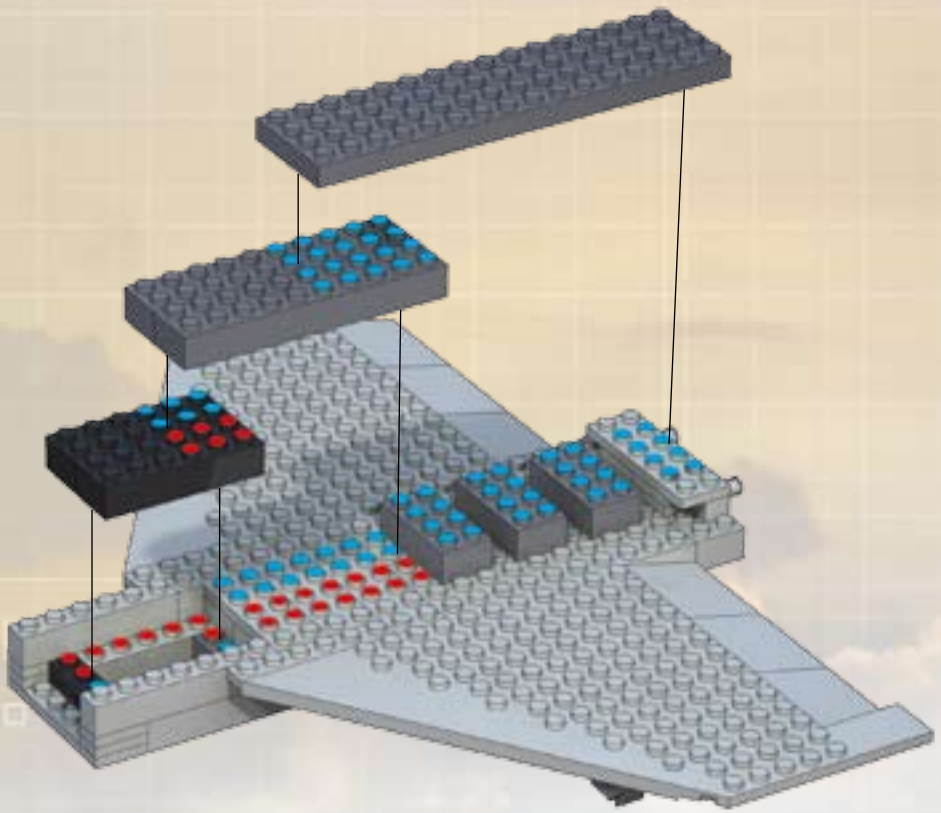
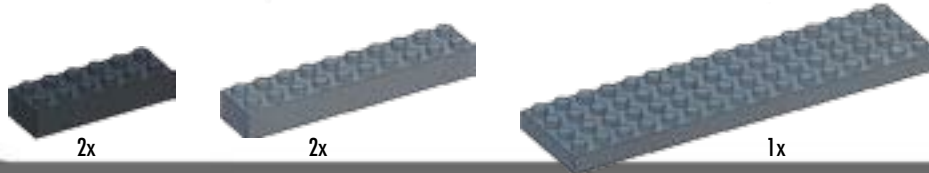









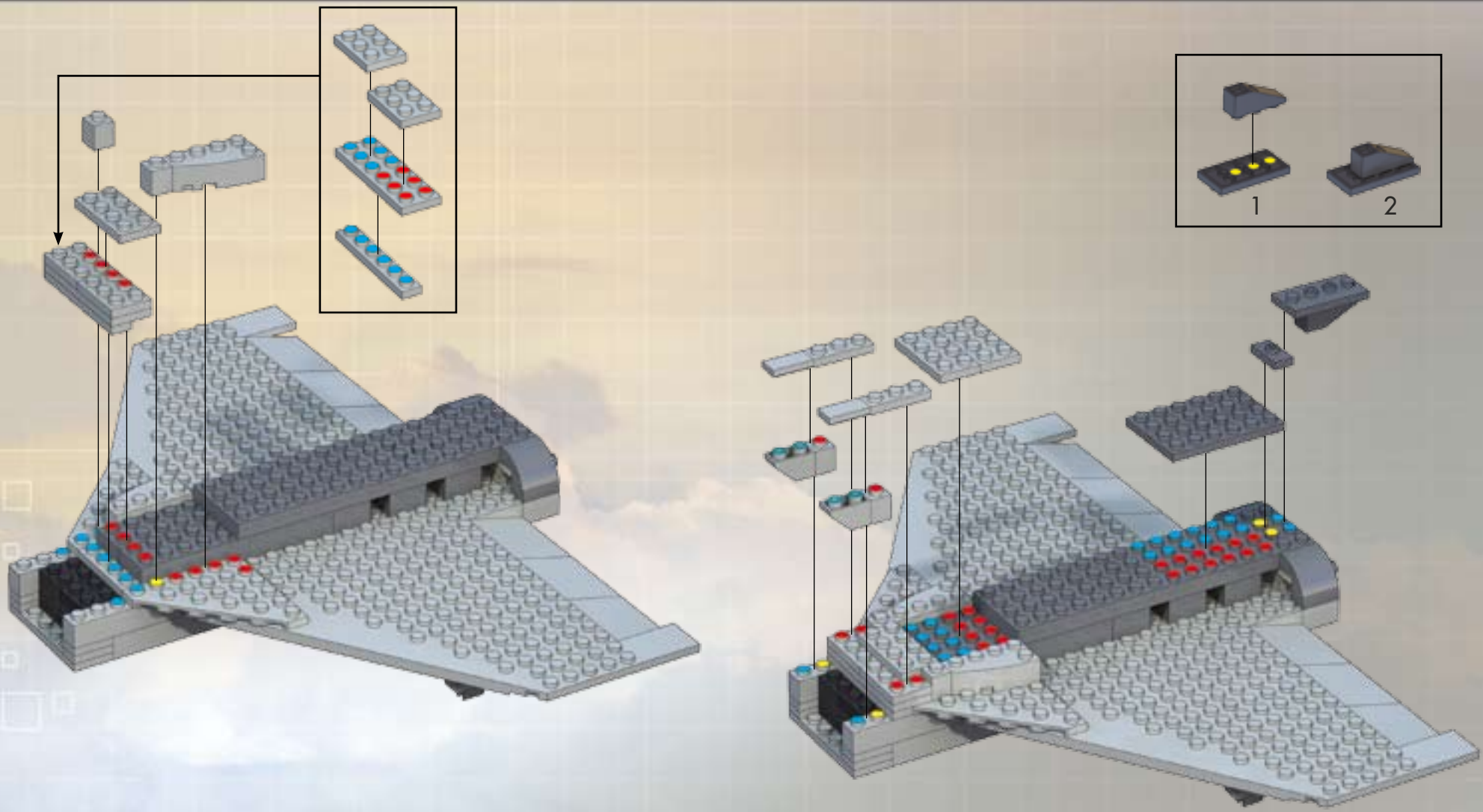



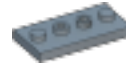

-  2x
-  1x
-  2x
-  1x
-  1x
-  1x



-  2x
-  2x
-  1x
-  1x
-  2x
-  2x
-  2x
-  2x
-  1x

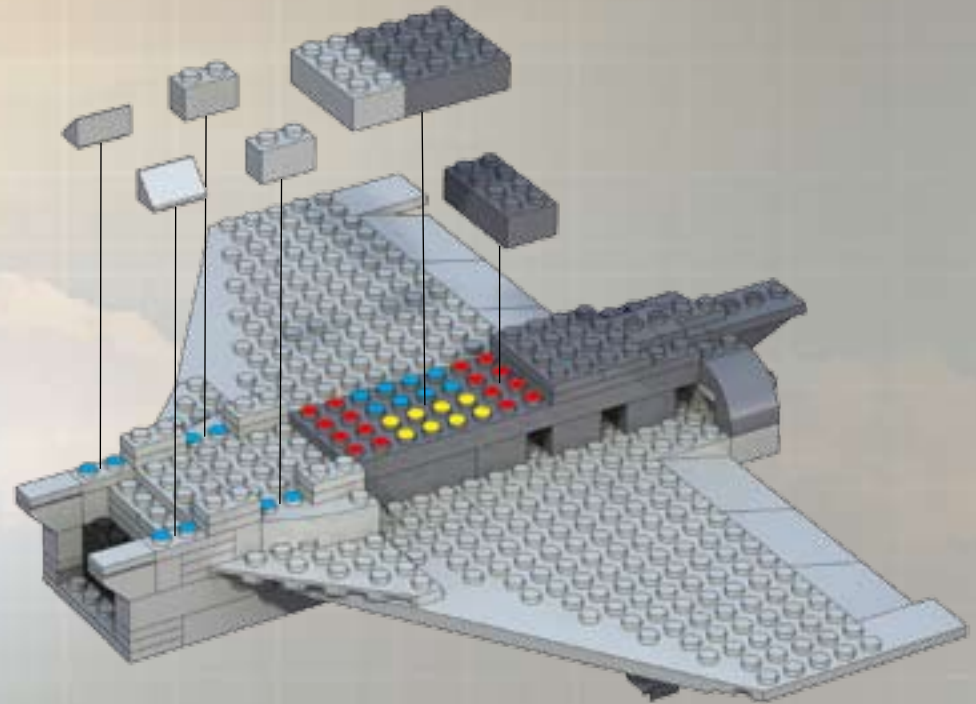
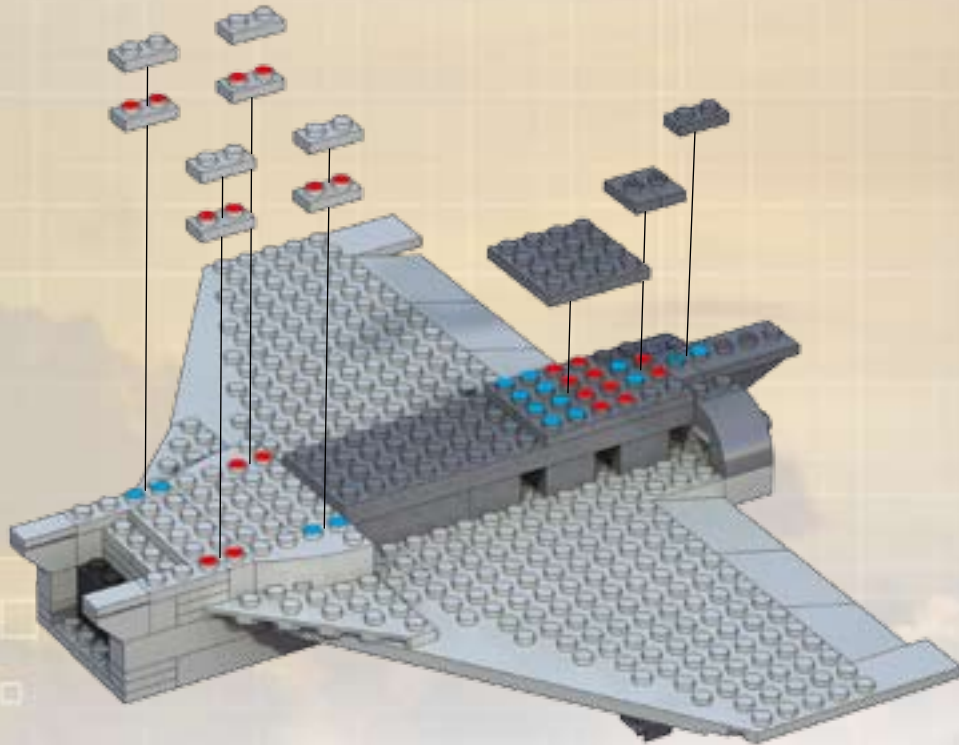
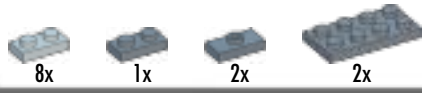

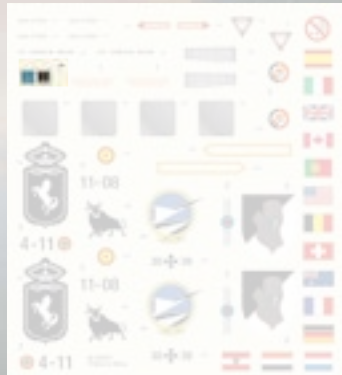
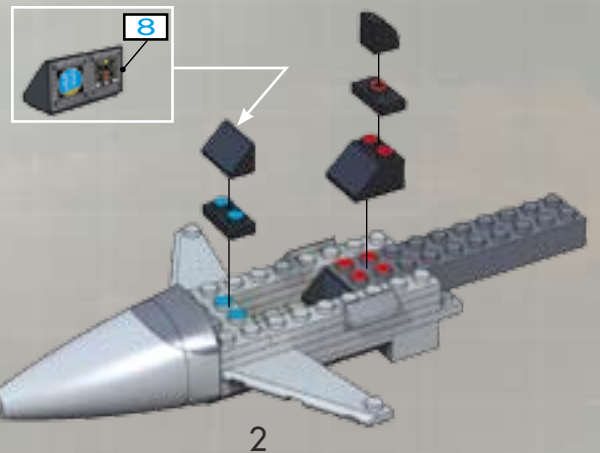
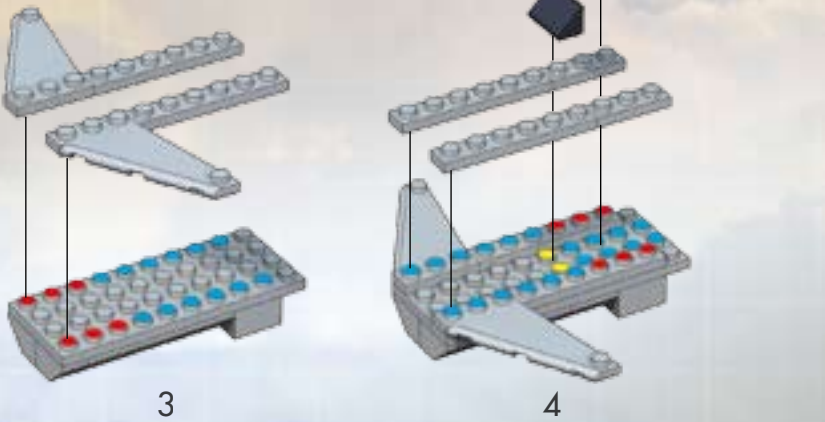
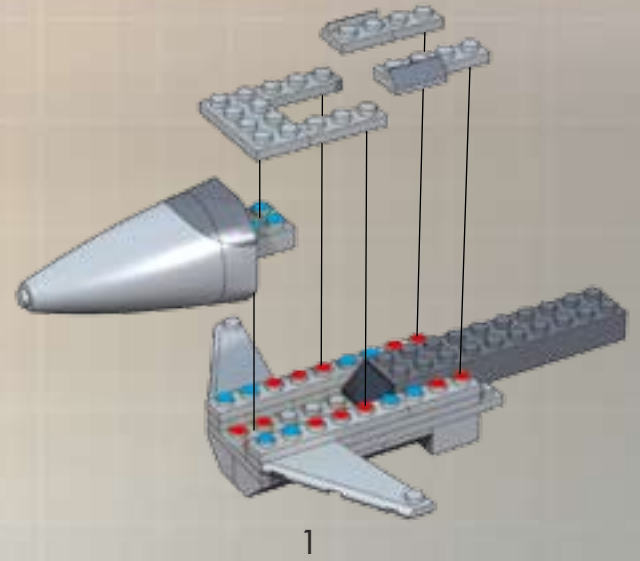
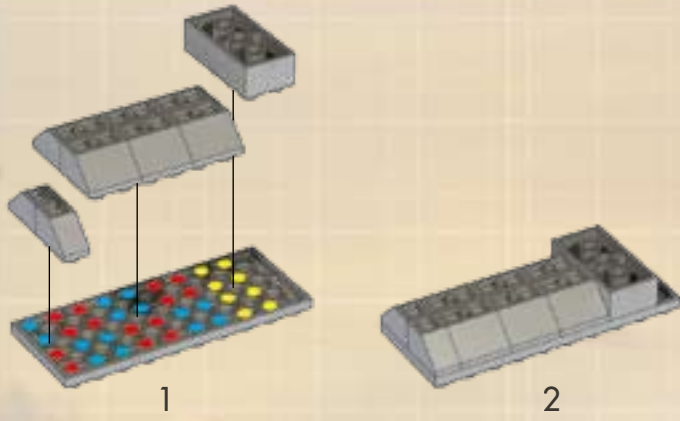



2x

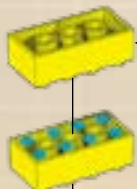

Place temporary pieces.  
Colocar las piezas provisionales.  
Installer les pièces temporaires.  
Provisorische Teile einsetzen.  
Instaleer de tijdelijke onderdelen.  
Piazzare i pezzi temporanei.  
Colocar peças temporárias.

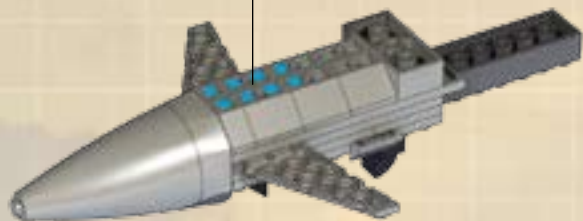

1



2

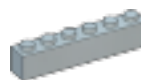
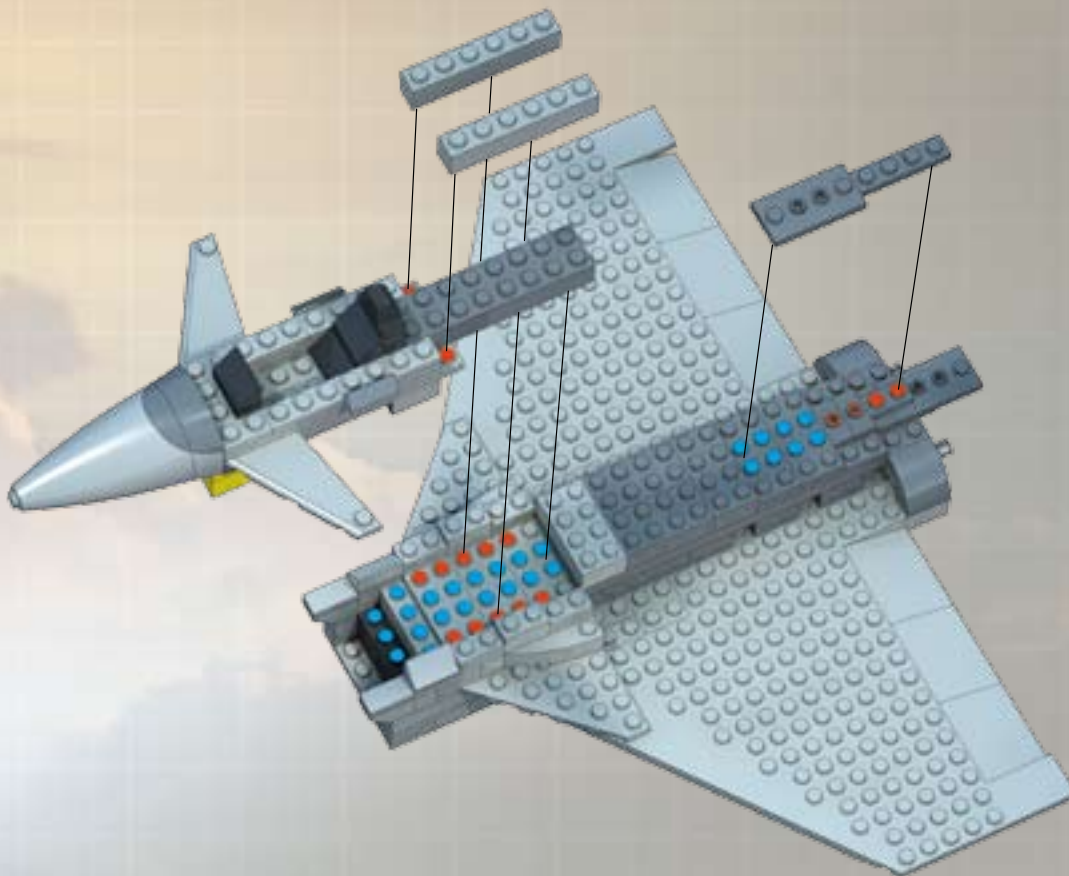





2x







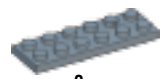

1x

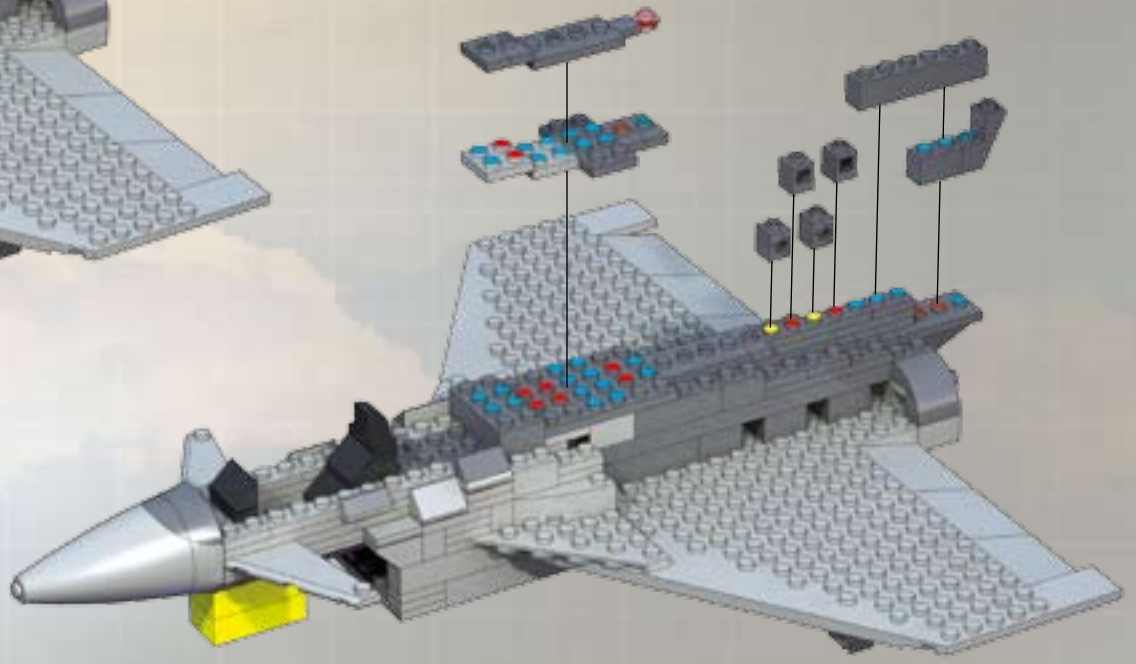
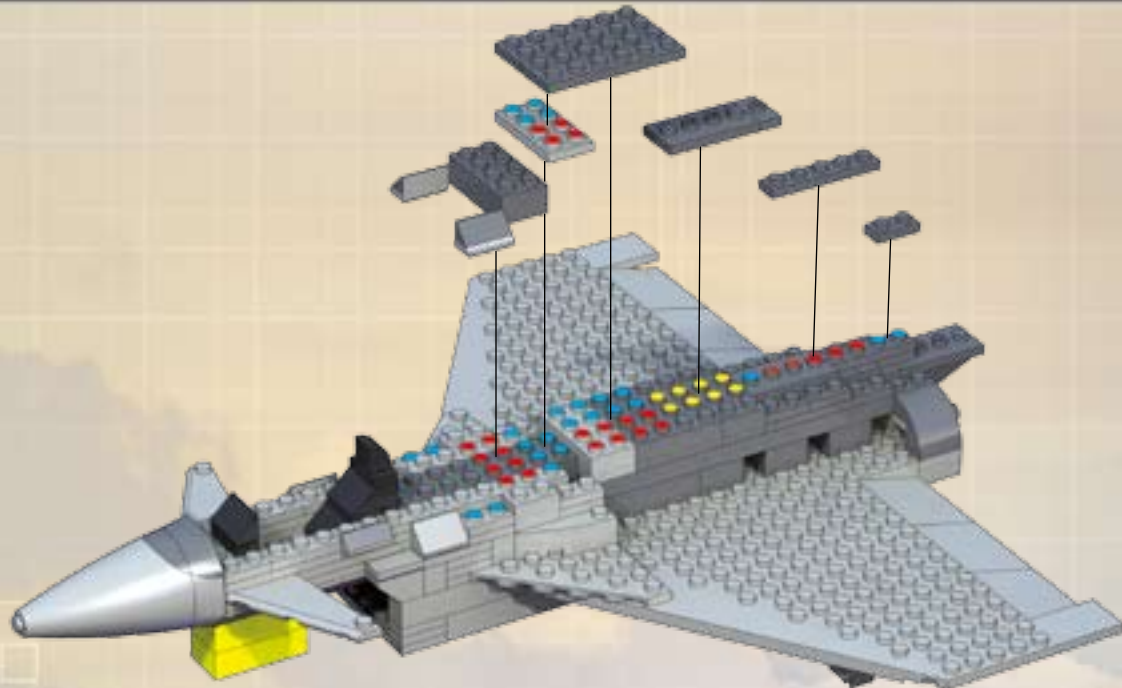

1x

-  1x
-  1x
-  2x
-  1x
-  1x
-  1x
-  2x
-  1x



-  1x
-  1x
-  1x
-  1x
-  1x
-  2x
-  4x
-  4x
-  1x
-  1x

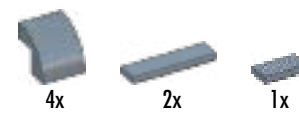
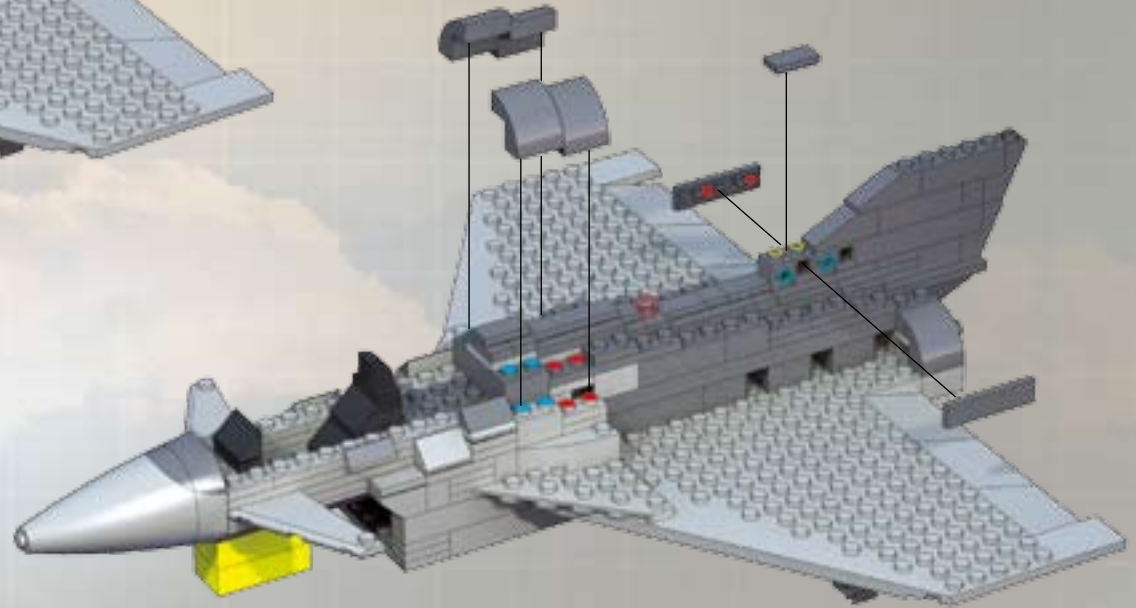
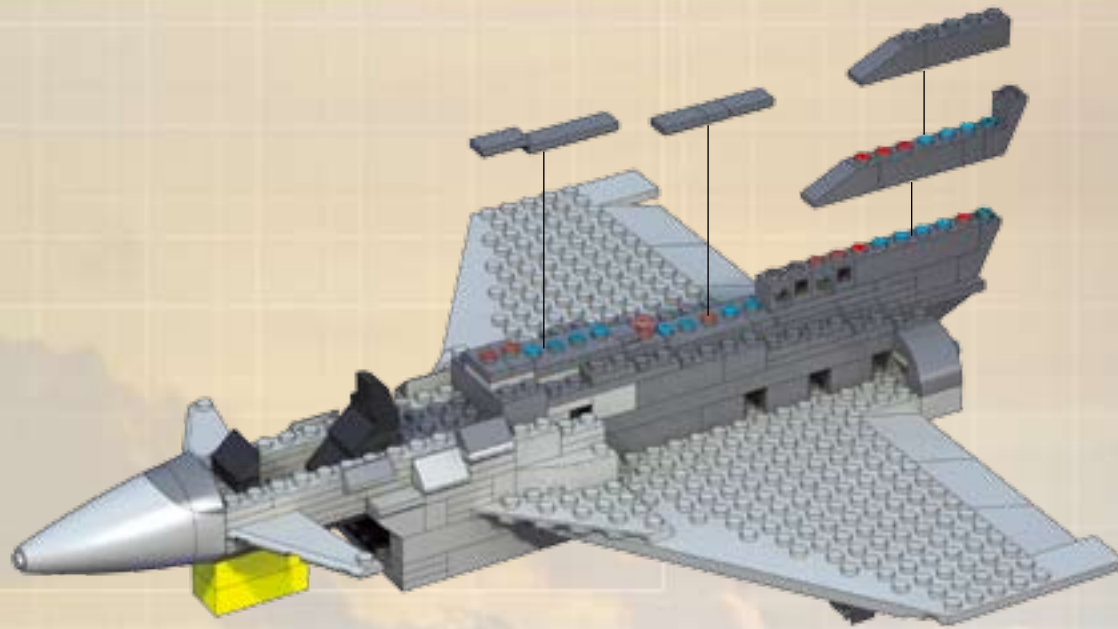

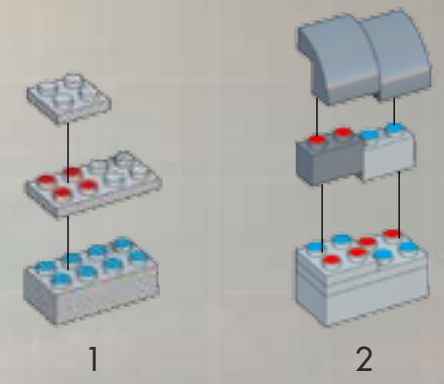
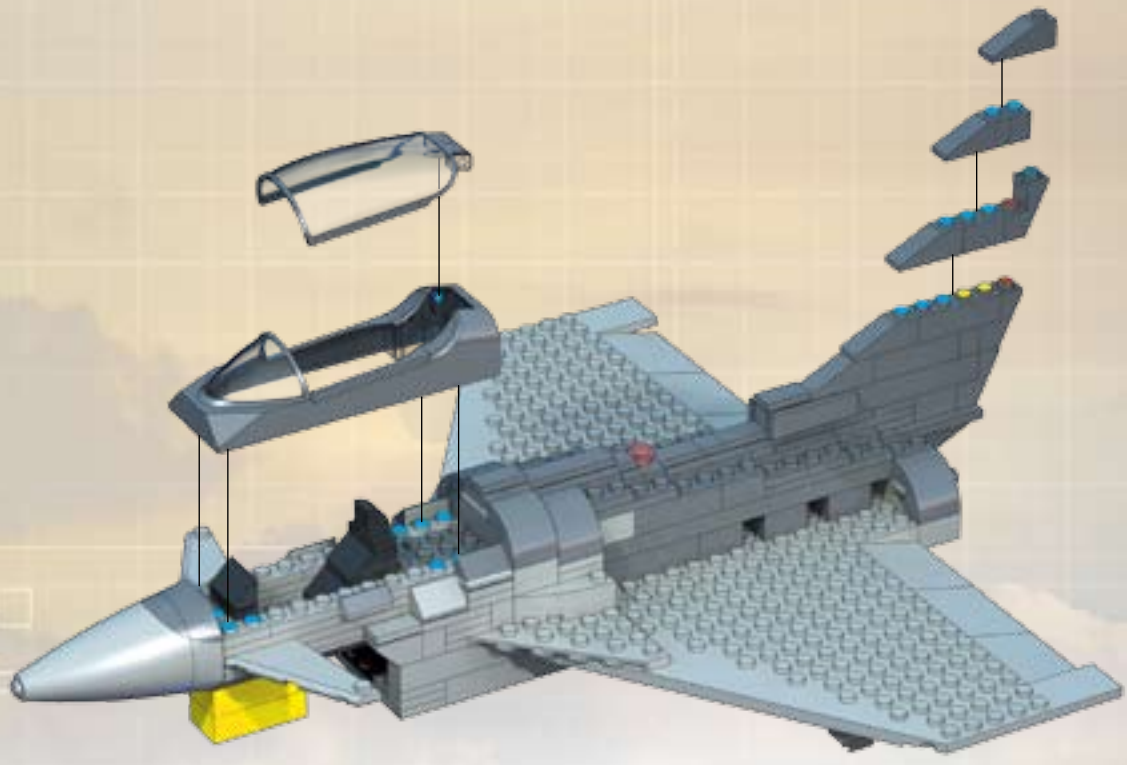
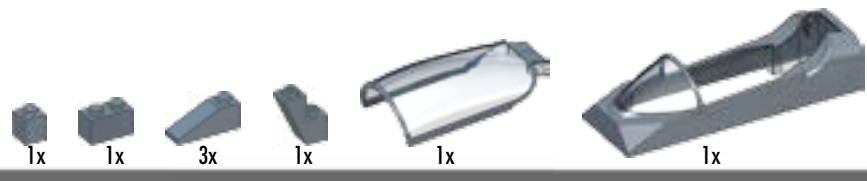



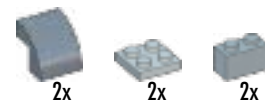
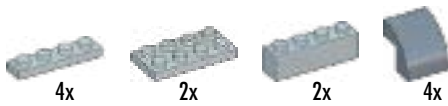
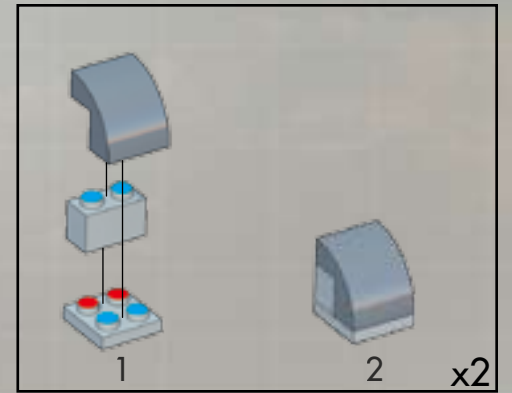
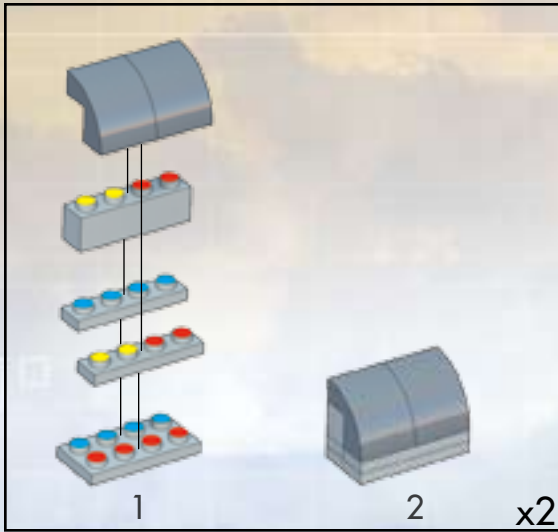
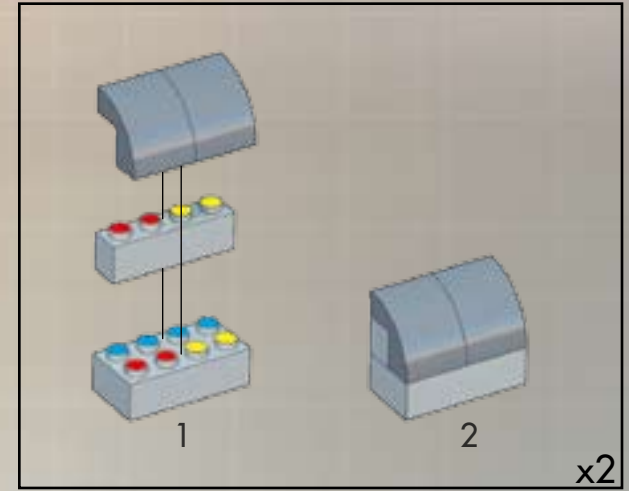
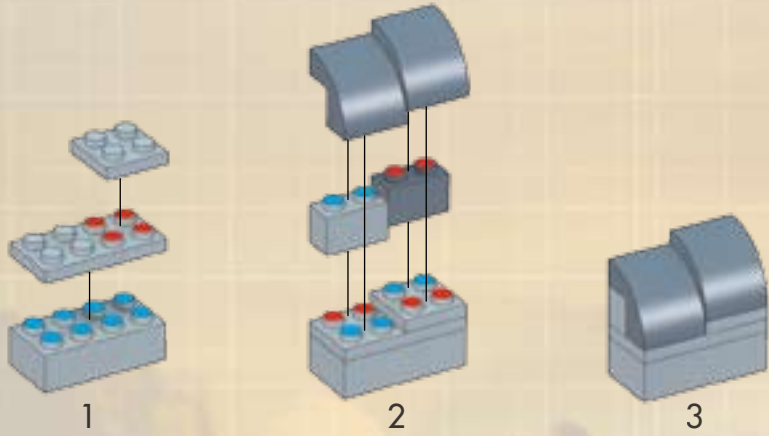
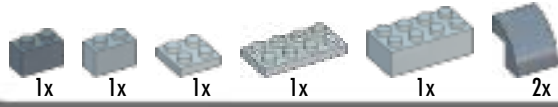

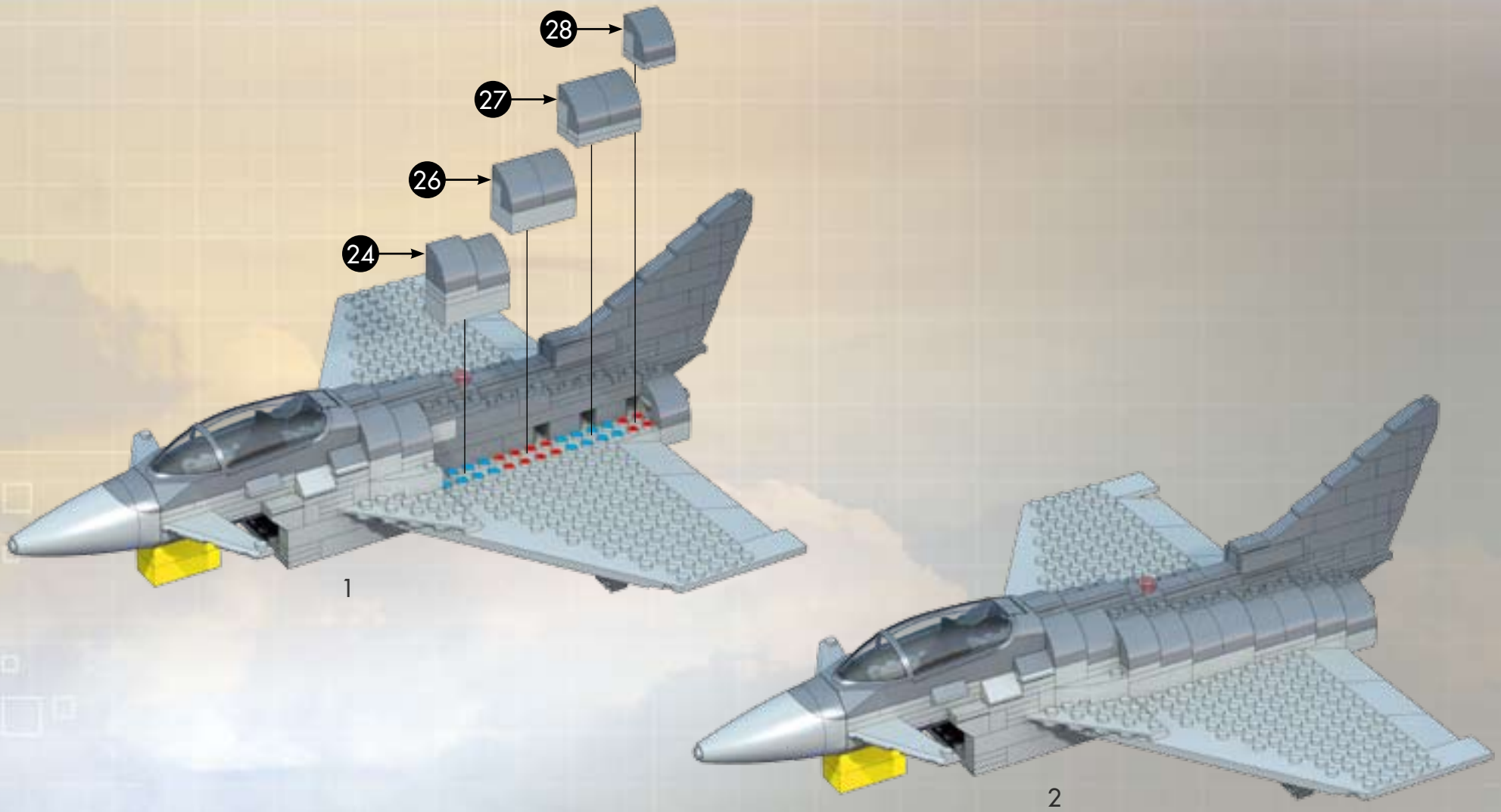

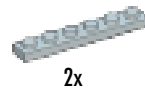
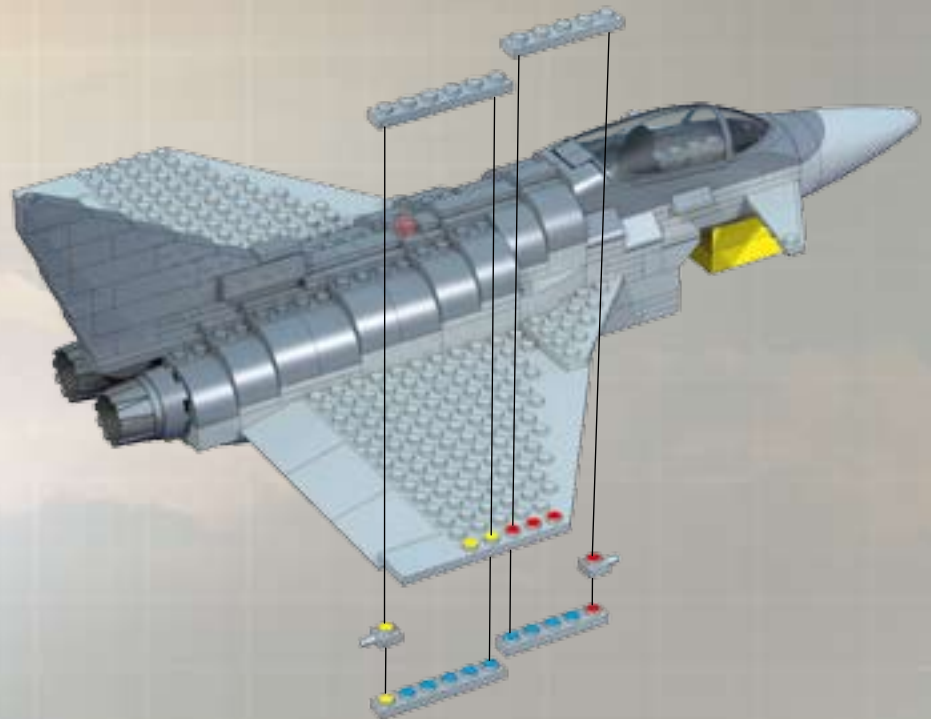
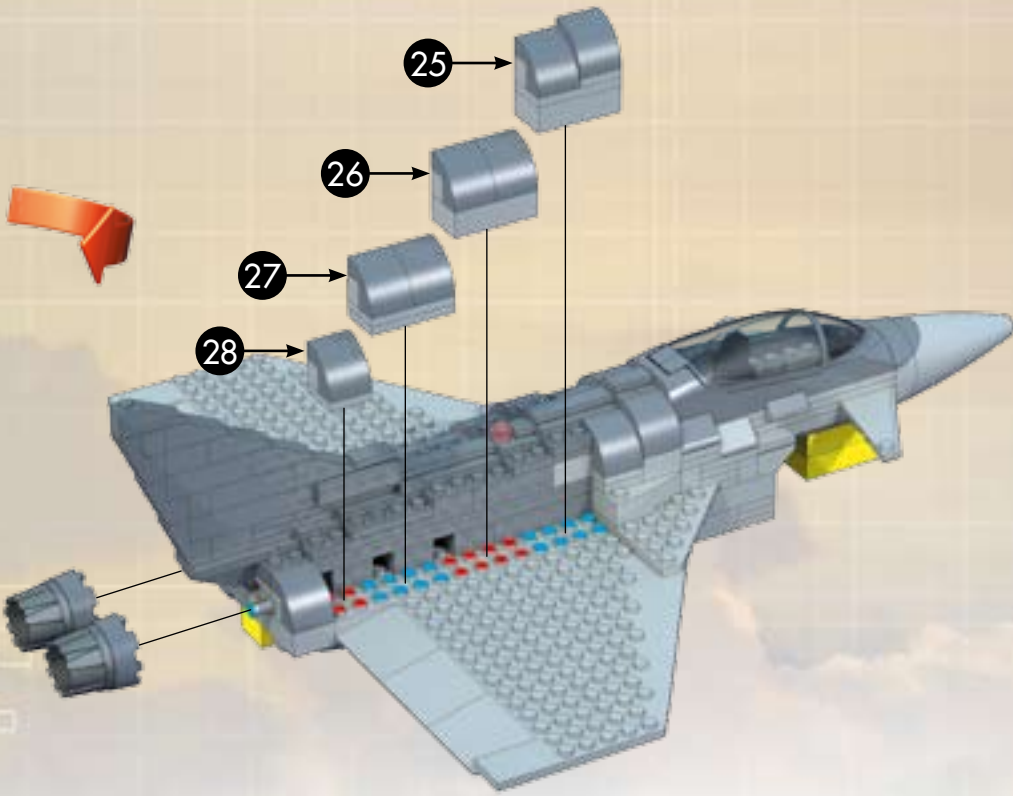

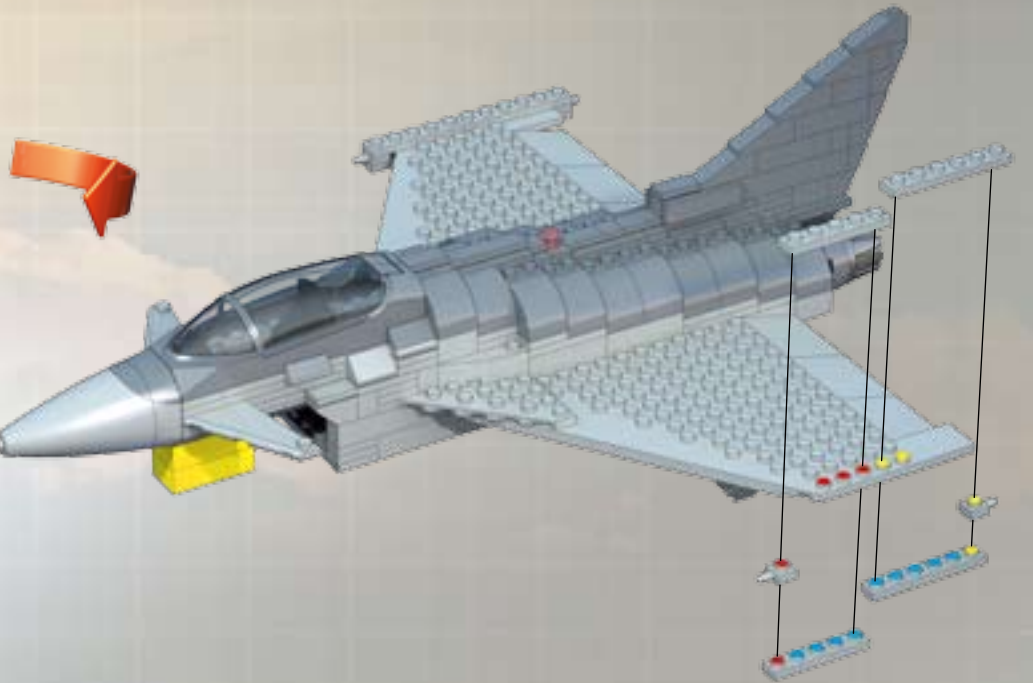



Remove temporary pieces.  
Retirar las piezas provisionales.  
Enlever les pièces temporaires.  
Provisorische Teile entfernen.  
Verwijder de tijdelijke onderdelen.  
Rimuovere i pezzi temporanei.  
Retirar peças temporárias.

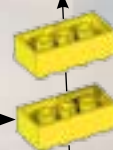

Remove temporary pieces.  
Retirar las piezas provisionales.  
Enlever les pièces temporaires.  
Provisorische Teile entfernen.  
Verwijder de tijdelijke onderdelen.  
Rimuovere i pezzi temporanei.  
Retirar peças temporárias.

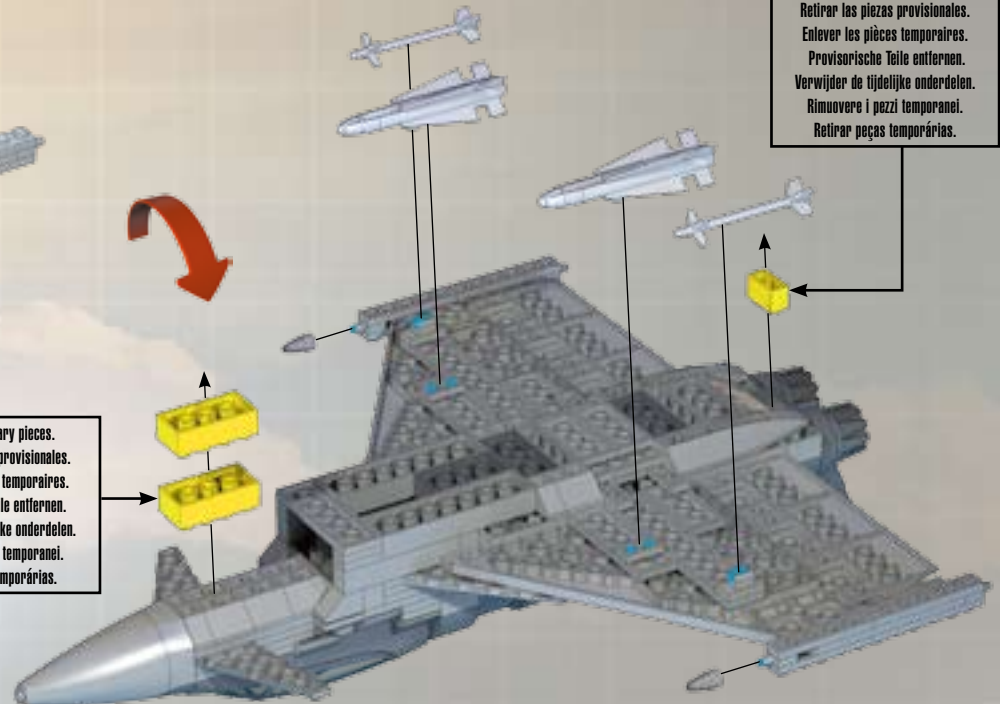

2x



2x



2x

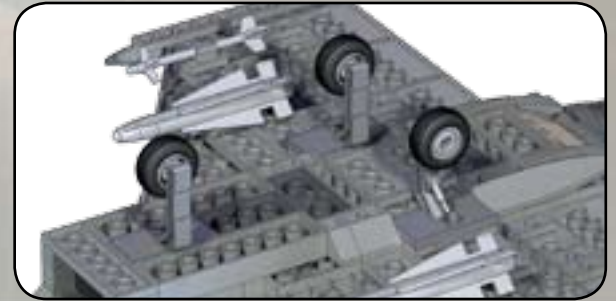
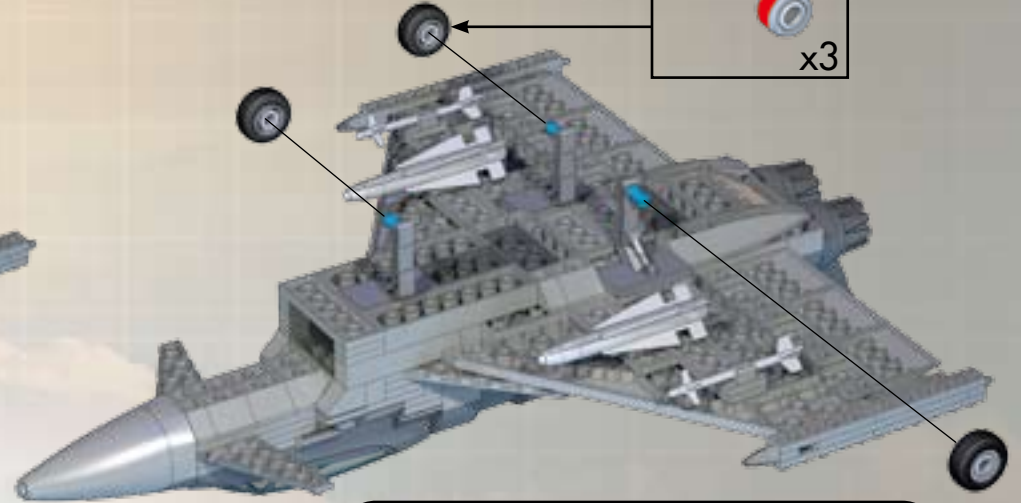
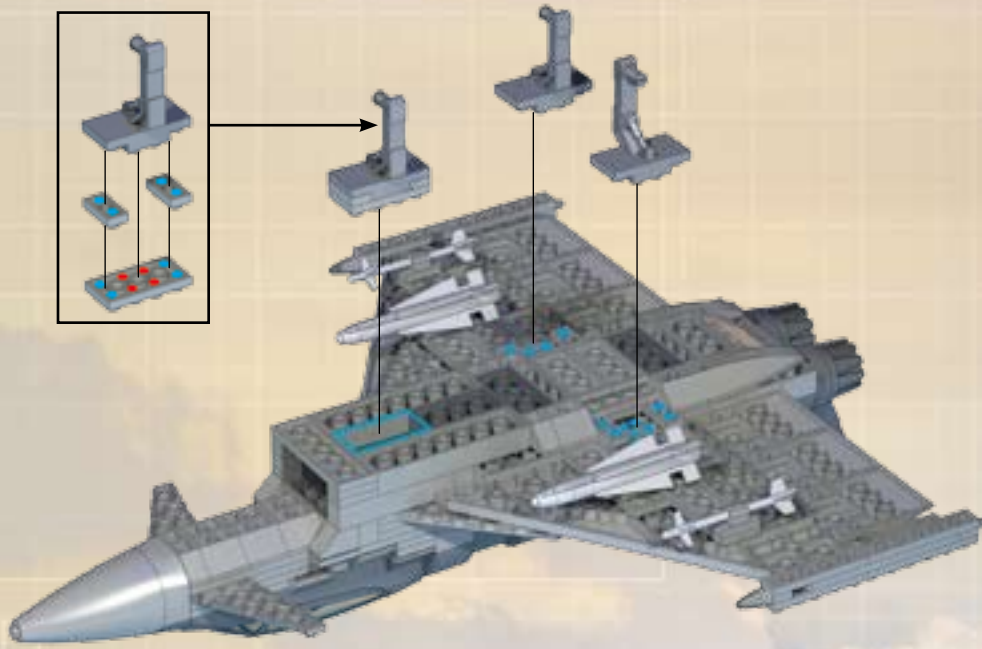
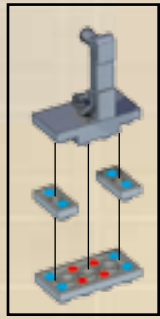
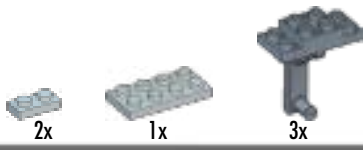

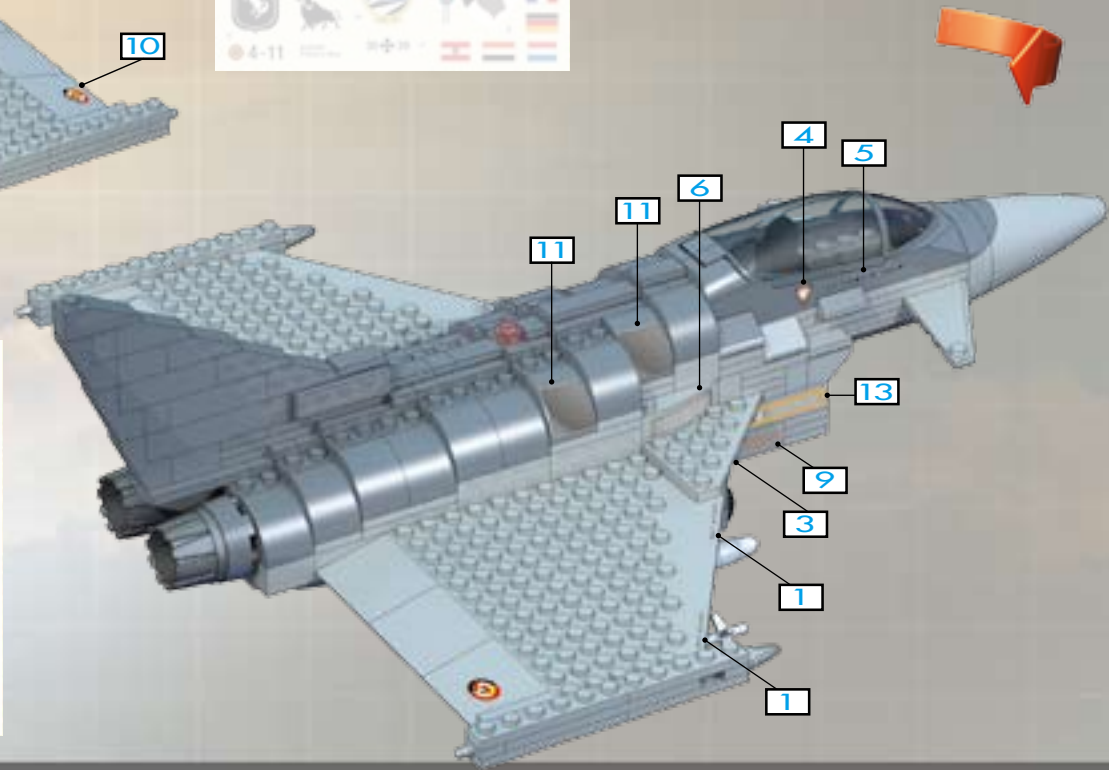
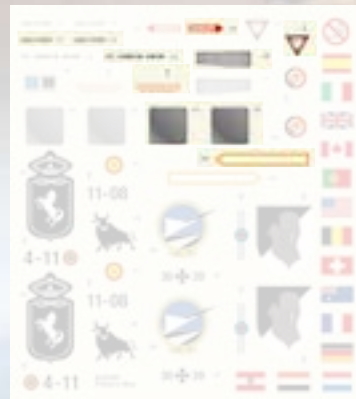
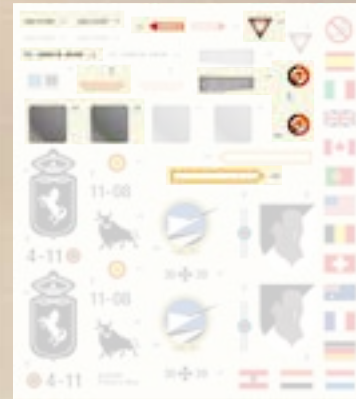
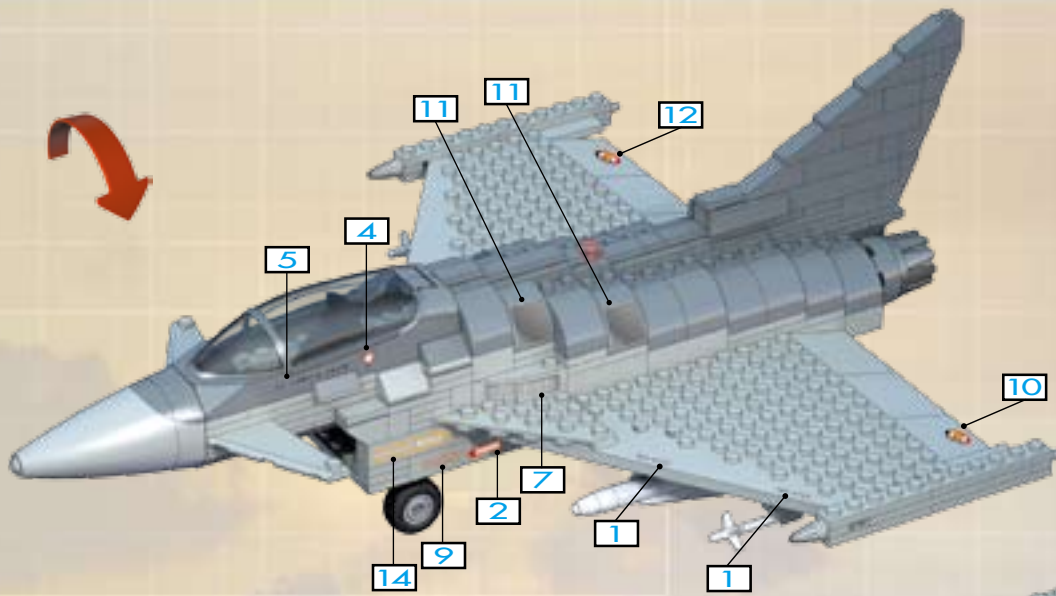

**Choose a country! / ¡Selecciona un país! / Choisis un pays ! /  
Land auswählen / Kies een land! / Scegli un Paese! /  
Escolhe um país**

-  Italy
- Italia
- Italië
- Italien
- Italië
- Italia
- Itália

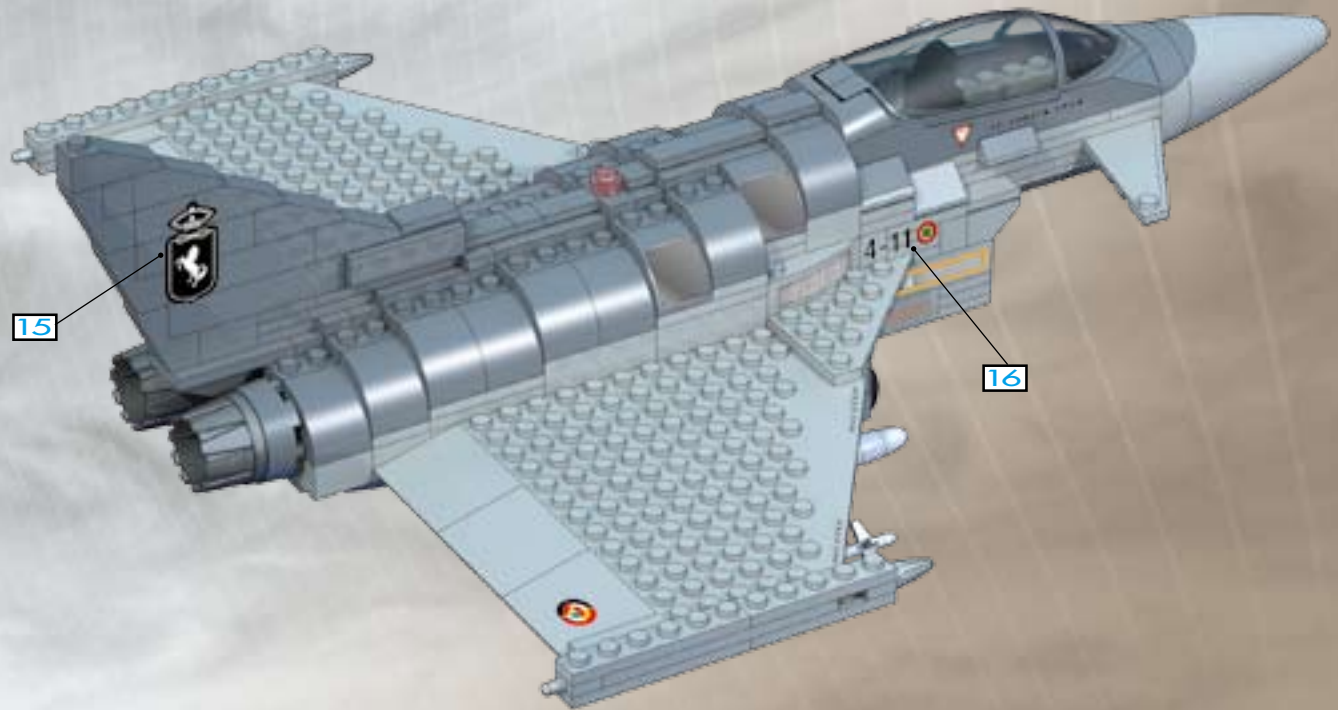
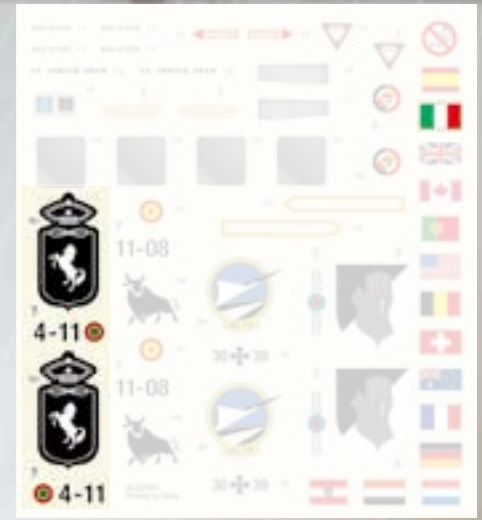





Spain  
 España  
 Espagne  
 Spanien  
 Spanje  
 Spagna  
 Espanha

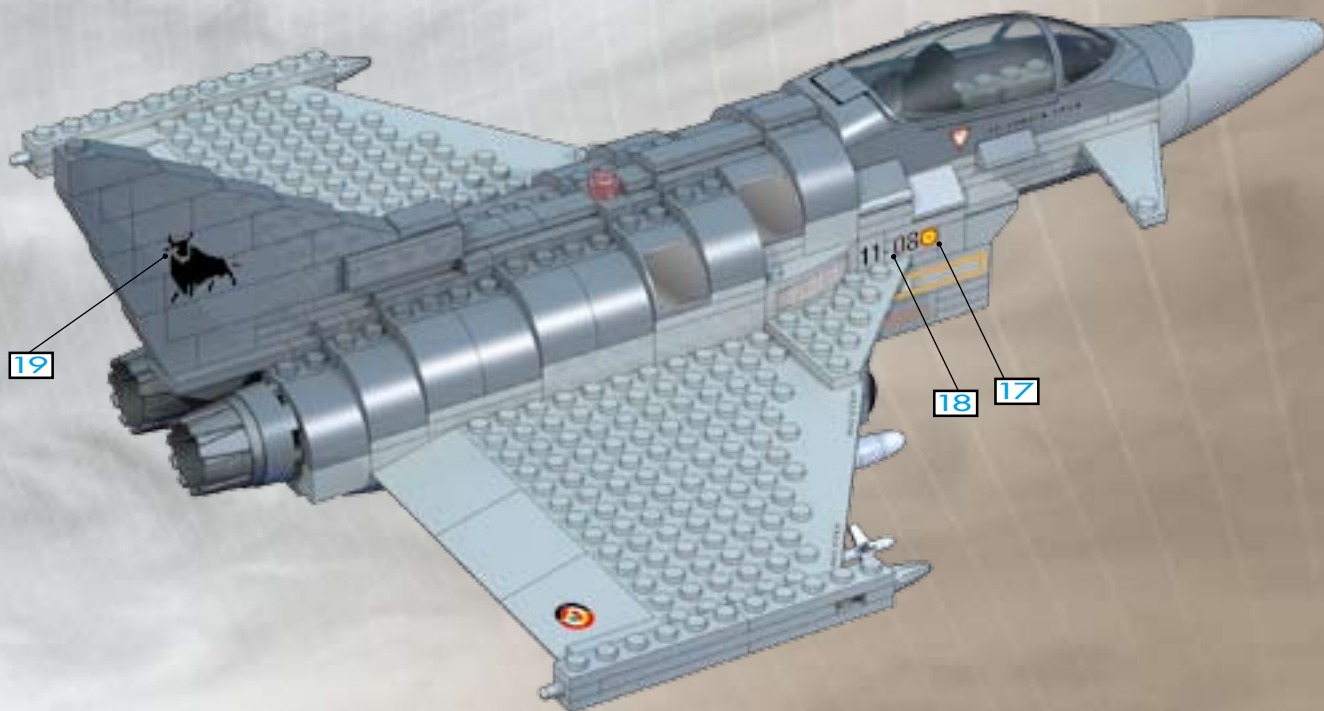
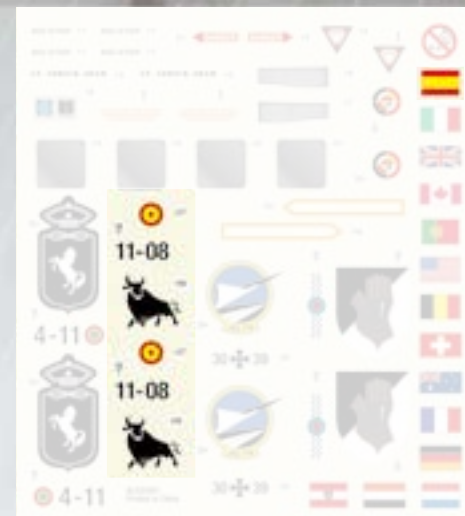



Germany  
 Alemania  
 Allemagne  
 Deutschland  
 Duitsland  
 Germania  
 Alemanha

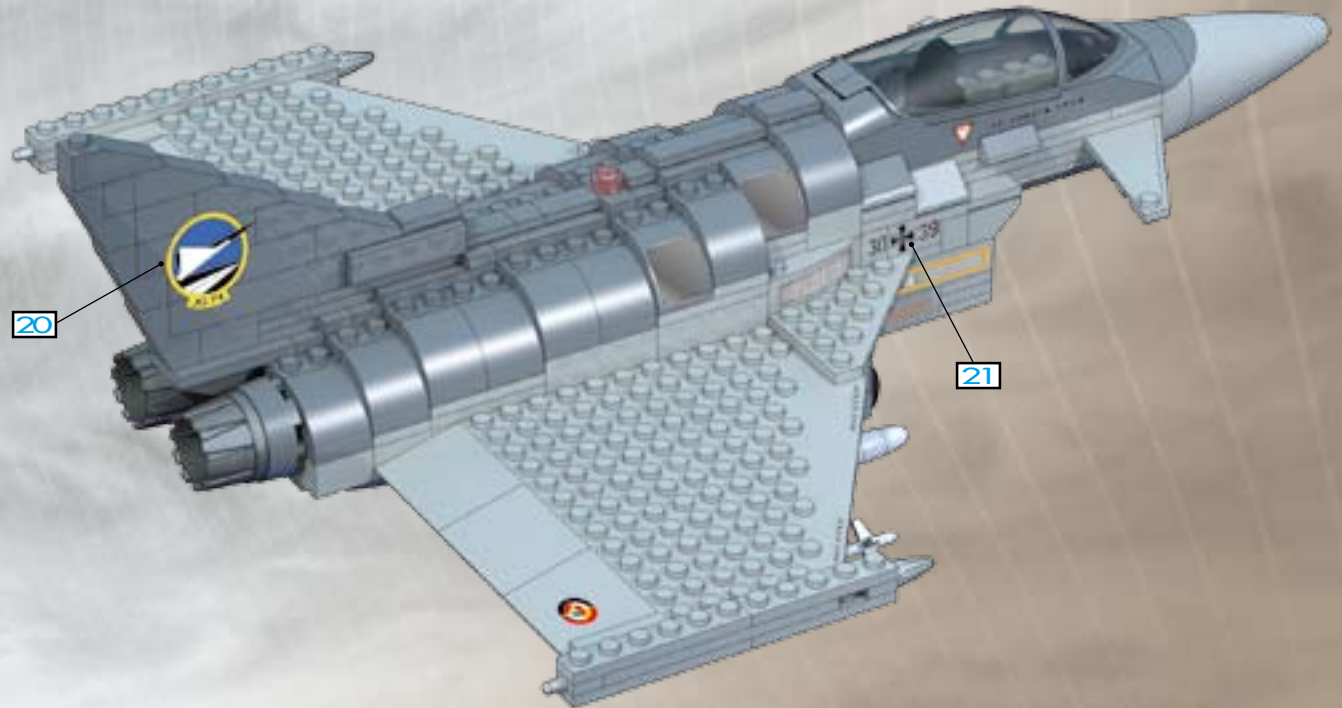
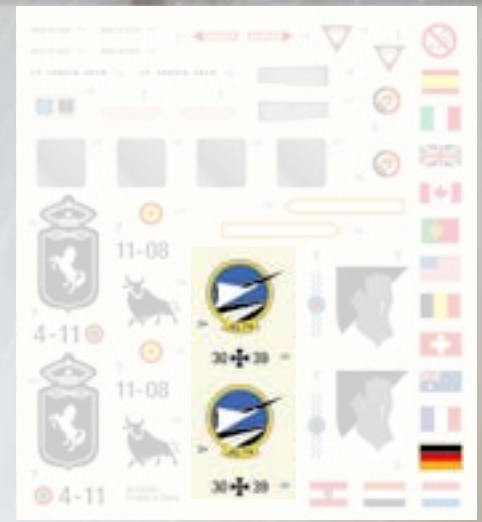
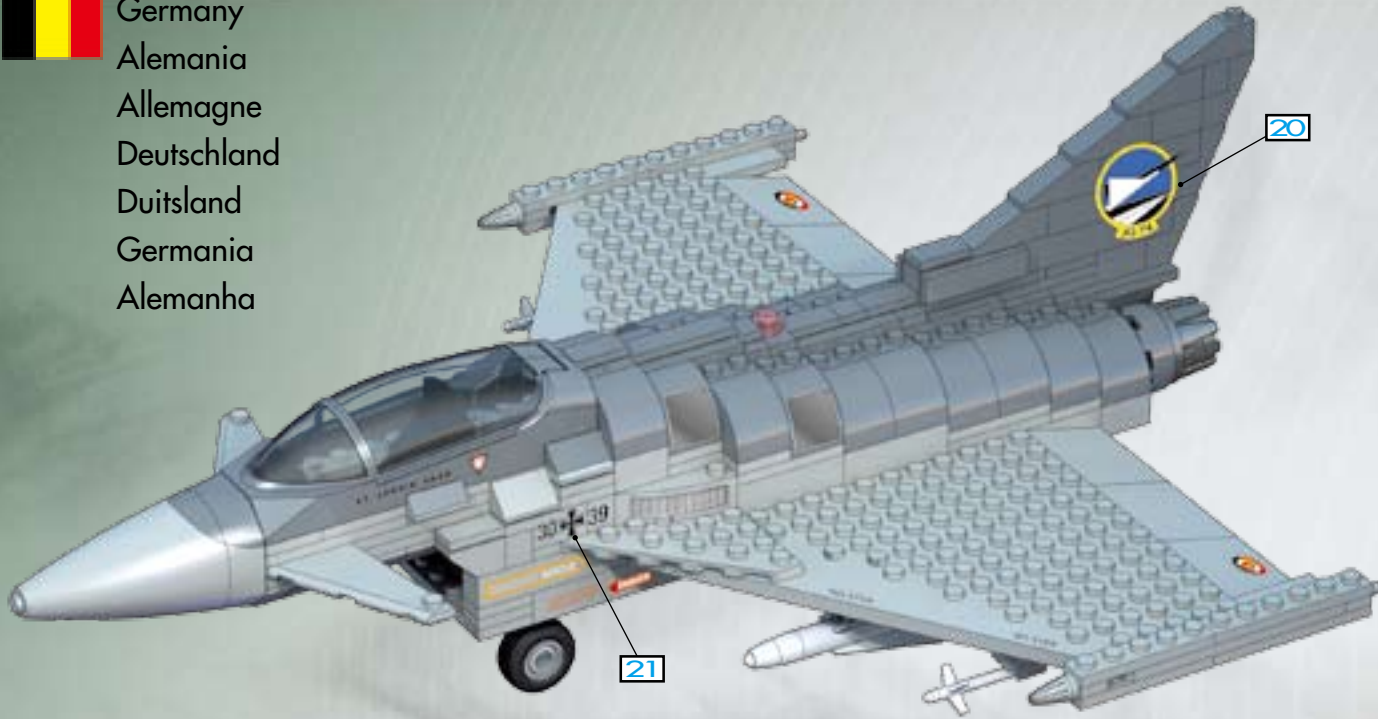



England  
 Inghilterra  
 Angleterre  
 England  
 England  
 Inghilterra  
 Inghilterra

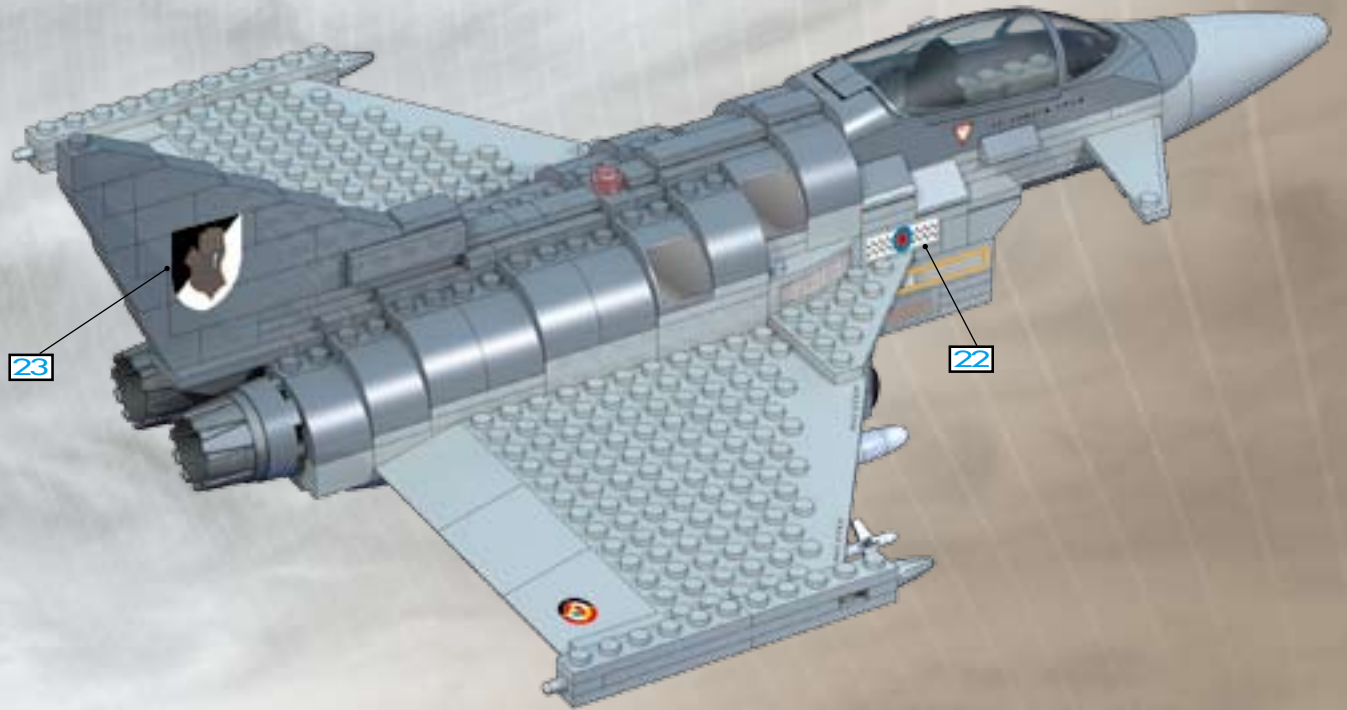
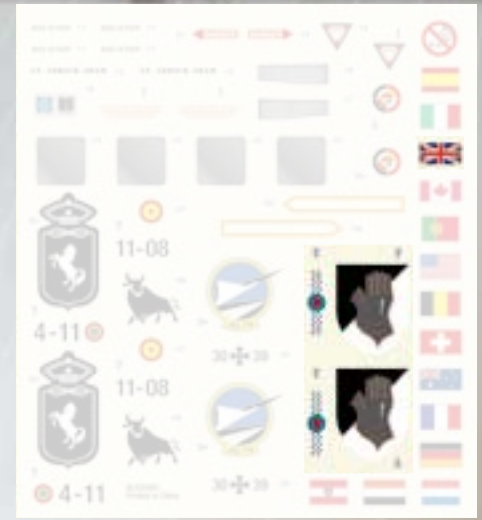
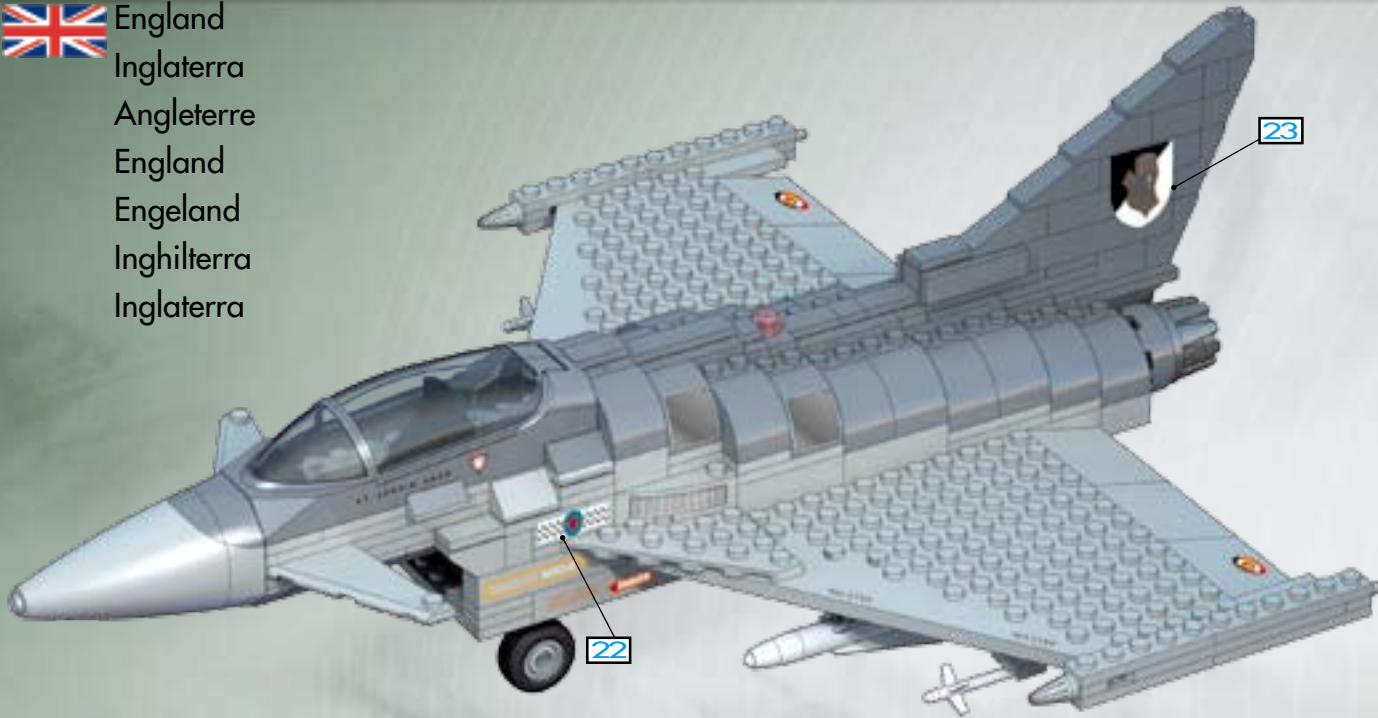



# Probuilder

## EUROFIGHTER TYPHOON™

EUROFIGHTER TYPHOON

- Wingspan / Envergadura / Размах / Spannweite / Spansvleugel / Аэродинамический размах / Envergadura de ala
- Speed / Velocidad / Vitesse / Geschwindigkeit / Stofhast / Velocitate / Velocidade
- Weapons / Armas / Armes / Waffen / Mijnen / Armamenti / Armamentos
- Air-to-air missiles ("AAM") / Misiles aire-aire ("AAM") / Missiles air-air ("AAM") / Luft-Luft-Rakete ("AAM") / Air-to-Air Missile / Luft-Luft-Rakete ("AAM") / Missili aria-aria ("AAM") / Missili air-air ("AAM")
- Air-to-surface weaponry / Mijnen anti-terre / Armes air-sol / Luft-Boden-Rakete / Lufti-grundleggers / Armas anti-superficie / Armamentos anti-terra

10.95 m / 36'

Mach 2.0

Guns: 27 mm Mauser canon  
 Armas de fogo: Canhão Mauser de 27 mm  
 Armes à feu: Canon Mauser 27 mm  
 Geschütze: Kanone 27 mm Mauser  
 Geweren: 27 mm Mauser-kanon  
 Armis: cannone Mauser da 27 mm  
 Armas: Canhão Mauser de 27 mm

BVRAAM (Beyond Visual Range) & SRAAM (Short-Range)  
 Misiles anti-aire (AAM) / Missiles air-air ("AAM") / Luft-Luft-Rakete ("AAM") / Air-to-Air Missile / Luft-Luft-Rakete ("AAM") / Missili aria-aria ("AAM") / Missili air-air ("AAM")

Laser guided bombs; advanced anti-armor weapons  
 Bombas dirigidas por laser; armas antiblindaje avanzadas  
 Bombes à guidage laser; armes antichars  
 Lasergesteuerte Bomben, hochentwickelte Panzerabwehrwaffen  
 Lasergestuurde bommen, geavanceerde antipantierwapens  
 Bombe à guida laser; armi avanzate anti-carro  
 Bombas guiadas por laser; armamentos anti-blindagem avançada

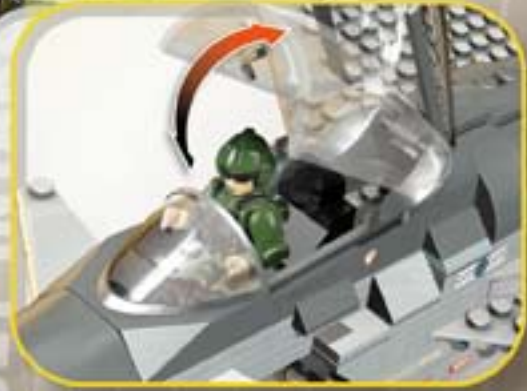
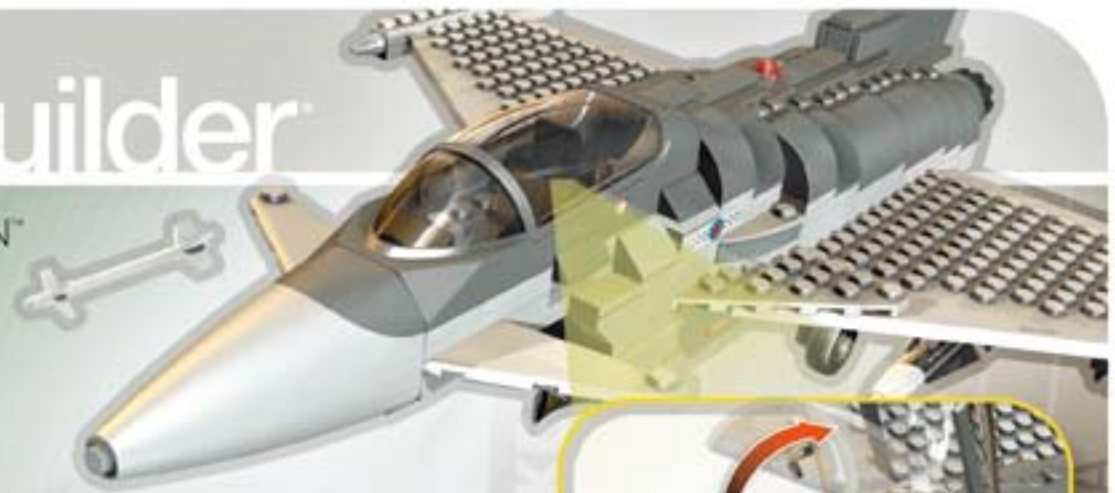

©2008, Eurofighter Jagdflugzeug GmbH. All rights reserved. Used with permission.

Ultima collectiō  
 (fina colección indispensable)  
 Collection ultime !  
 The ultimate Seriesings!  
 Última versamaling!  
 La collezione all'ultimo grado!  
 Última coleção e não perdes!



3250 M1064 Gromitz



3230 Mountain Peak Expedition™



3251 Leopard 2

