

5983
Off Shore Racing™

MEGA
BLOKS

nano™
Building System



7+ Ages / Edades
Âges / Leeftijden

470 Pieces / Piezas
Pièces / Stuks



Welcome to the world of NANO!

NANO Bloks™ is an exciting, new, miniature construction system, which allows you to BUILD, PLAY and COLLECT in a size and range that you have never seen before. I am NANOMAN and let me introduce you to a cool new world of building detail, action and fun!

¡Bienvenido al mundo de NANO!

NANO Bloks™ es un nuevo y excitante sistema de construcción miniatura que te deja CONSTRUIR, JUGAR y COLECCIONAR en una dimensión y de alcance nunca visto antes. ¡Soy NANOMAN, permítame que te presente un asombroso nuevo mundo para construir con detalles, acción y entretenimiento!

Bienvenue au monde de NANO!

NANO Bloks™ est un nouveau et fascinant système de construction à partir de pièces miniatures qui vous permet de CONSTRUIRE, de JOUER et de COLLECTIONNER un éventail de pièces d'une taille inédite. Je suis NANOMAN. Permettez-moi de vous présenter un nouveau monde de construction, d'action et de plaisir !

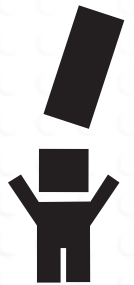

Welkom in de wereld van NANO!

NANO Bloks™ vormt een nieuw en opwindend miniatuur bouwsysteem dat je laat BOUWEN, SPELEN en VERZAMELEN in een formaat en verscheidenheid dat je nooit eerder gezien hebt. Ik ben NANOMAN en ik wil je bekend maken met een leuke nieuwe wereld van bouwdetails, actie en plezier.

I am here to help you with your building project so look for me throughout this playbook. I will guide you through the more challenging sections of these instructions to make sure that your building experience is easy, fun & rewarding.

Aquí estoy para ayudarte con tu proyecto de construcción, así que búscame en todo este libro de juego. Seré tu guía a través de las secciones más complejas de estas instrucciones para que tu aventura de constructor resulte fácil, entretenida y gozosa.

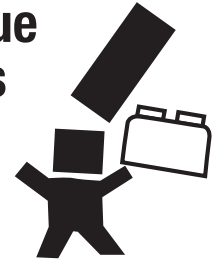

Je suis ici pour vous aider dans votre projet de construction. Il suffit de me rechercher dans ce livre de jeu. Je vous accompagnerai à travers les sections les plus difficiles de ces instructions pour vous assurer une expérience de construction facile, amusante et valorisante.

Ik ben hier om je te helpen met je bouwproject, dus je vindt me overal in deze handleiding. Ik zal je gids zijn in de meer ingewikkelde delen van deze instructies om jouw bouwervaring zo gemakkelijk, plezierig en bevredigend te maken als het maar kan.

Please read these instructions carefully before first use and keep them for future reference.

Leer estas instrucciones cuidadosamente antes de la primera utilización y guárdarlas para referencia futura.

Il est recommandé de lire attentivement ce feuillet avant la première utilisation et de le conserver pour référence future.

Wij raden u aan deze handleiding zorgvuldig te lezen en te bewaren voor eventuele raadpleging op een later tijdstip.



Military
Militar
Militaires
Militair



Racing
Carreras
Course
Racing



Rescue
Rescate
Secours
Redding



Construction
Construcción
Construction
Gebouw



Classic/Show cars
Autos clásicos/exhibicion
Voitures classiques/d'exposition
Klassieke/Show autos

Nanocase Playset / Juego Nanocase Jeu Nanocase / Nanocase Speelpakket



Action Key/Launcher – fires vehicles

Tecla de acción/Lanzador – dispara vehículos

Clé d'activation/Lanceur – déploie les véhicules

Actiesleutel/Lanceerinrichting – schiet voertuigen af

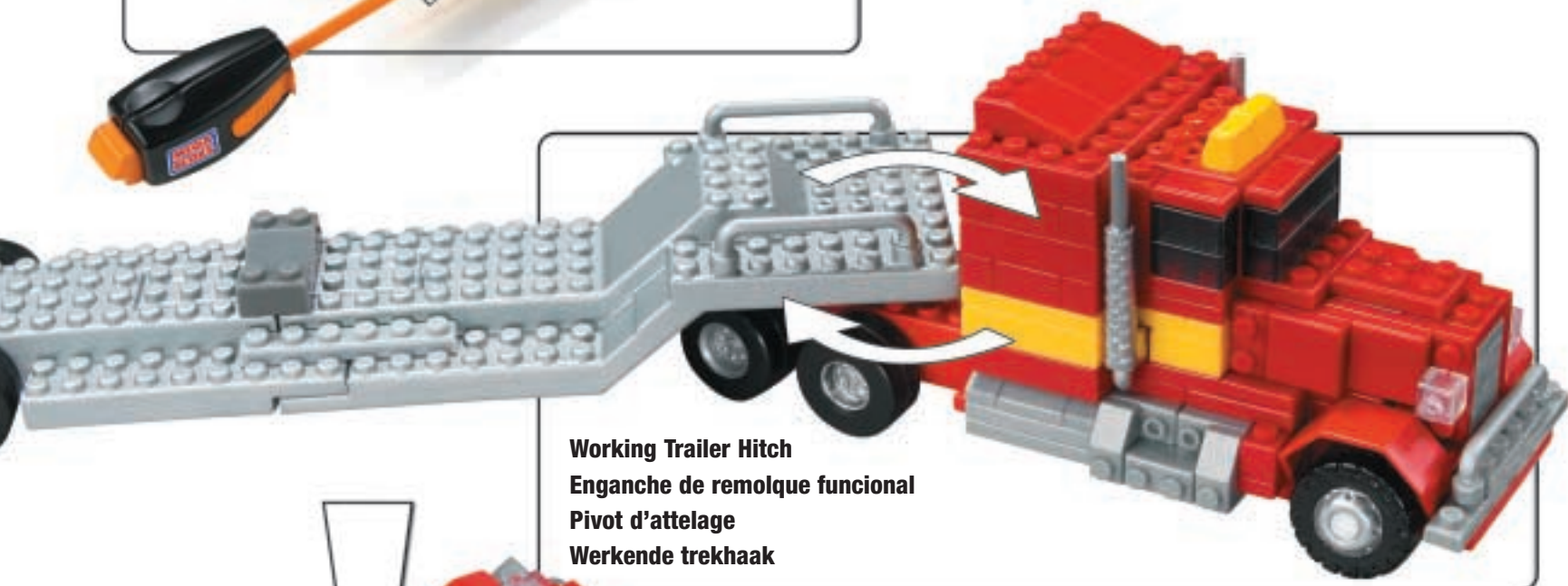

Working Trailer Hitch

Enganche de remolque funcional

Pivot d'attelage

Werkende trekhaak

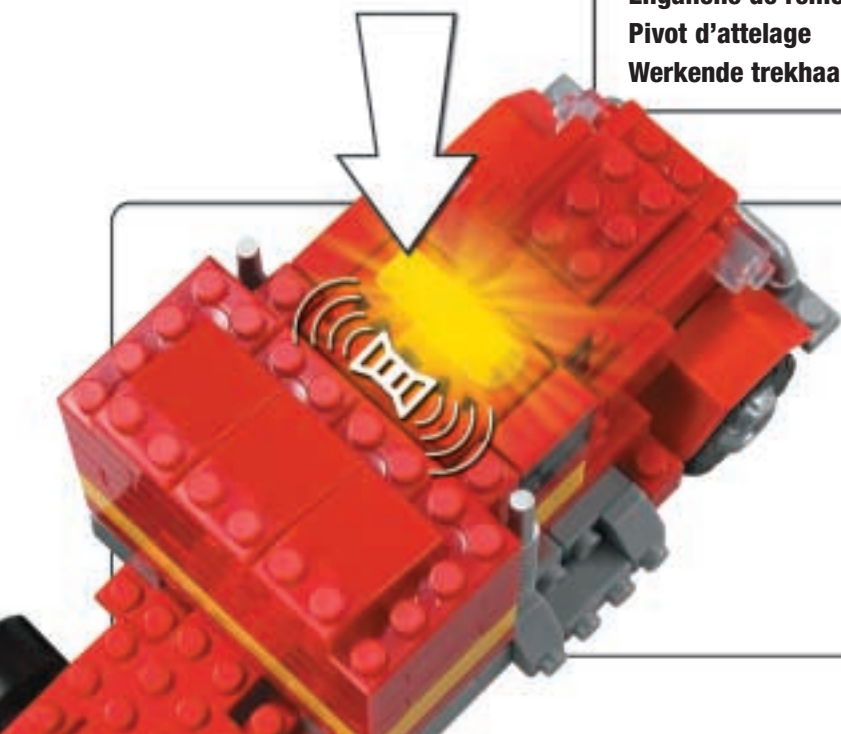

Nano-Sonics Sound & Light Block

Bloque Sonido & Luz Nano-Sonics

Bloc de son et de lumière Nano-Sonics

Nano-Sonics geluids-en lichtblok

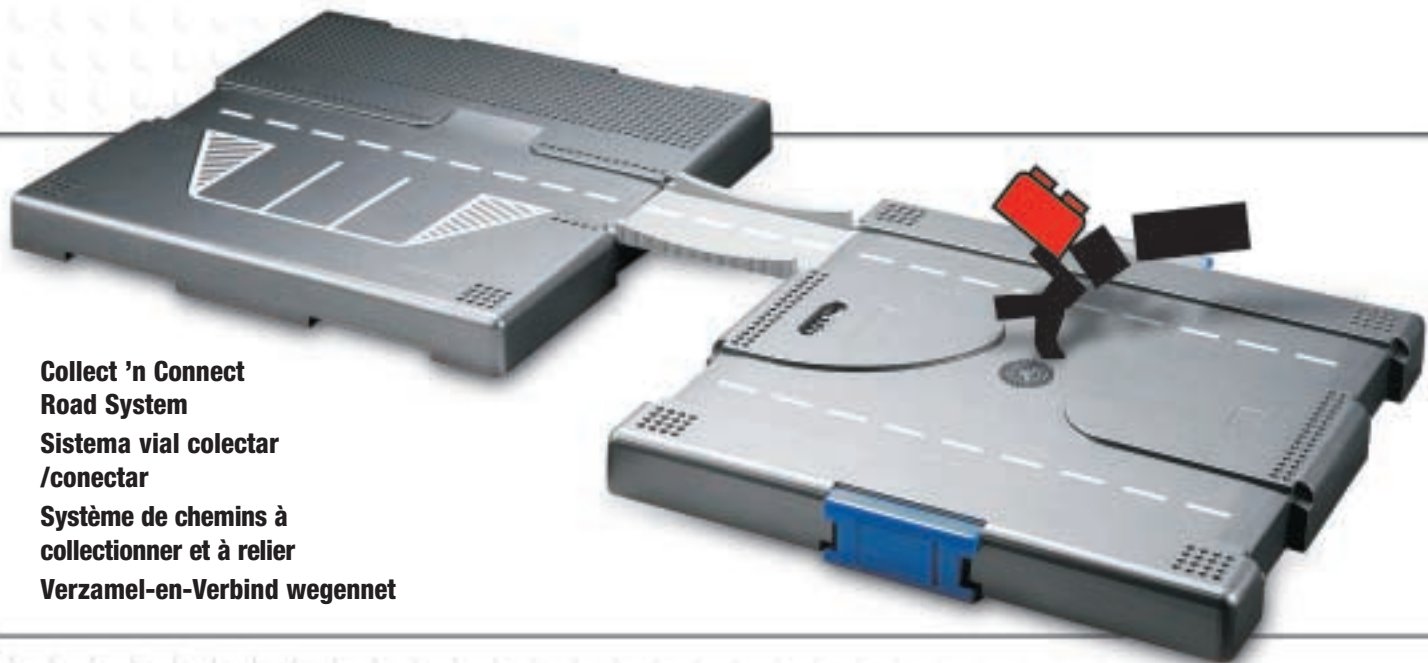

**Collect 'n Connect
Road System
Sistema vial colector
/conectar
Système de chemins à
collectionner et à relier
Verzamel-en-Verbind wegennet**



**Detailed Environments
Paisajes detallados
Environnements détaillés
Gedetailleerde milieus**

**Nanocase Display / Presentación Nanocase
Présentoir Nanocase / Nanocase Uitstalling**

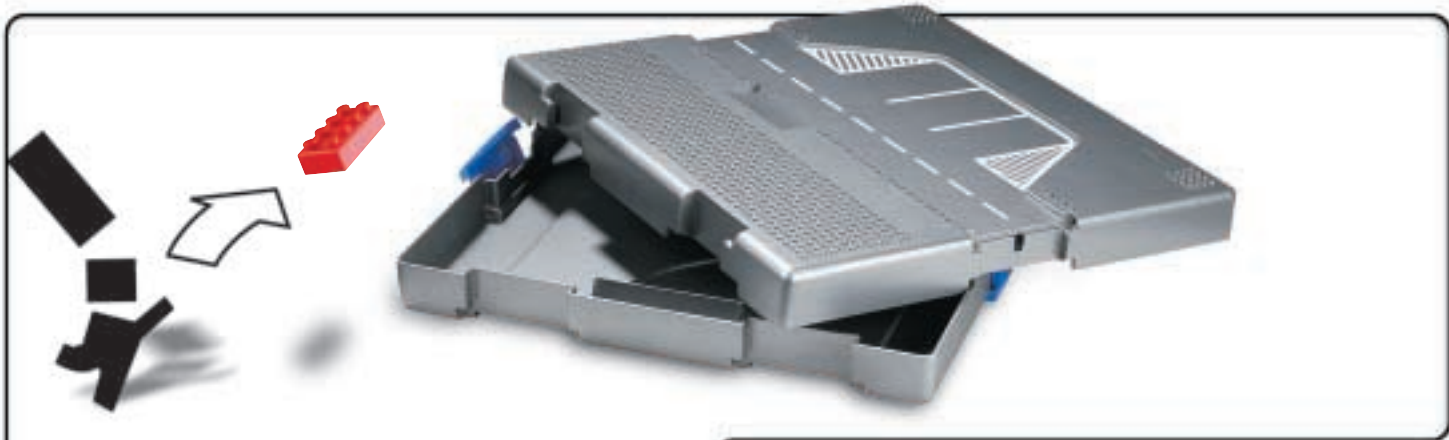

**Pack.
Store.
Collect.
Empaca.
Almacena.
Colecciona.
Ranger.
Collectionner.
Verpak.
Bewaar.
Verzamel.**



Section 1 • Sección 1
 Section 1 • Deel 1

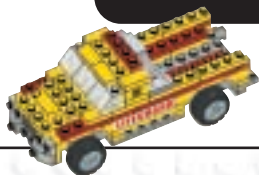

12

Section 2 • Sección 2
 Section 2 • Deel 2



17

Section 3 • Sección 3
 Section 3 • Deel 3

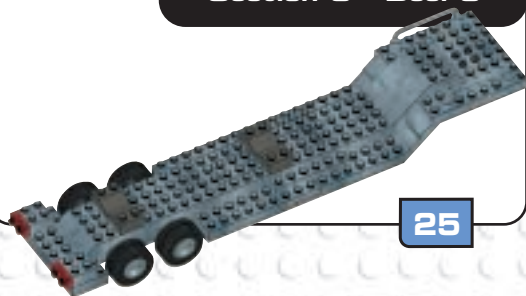

25

Section 4 • Sección 4
 Section 4 • Deel 4



30

00	00	
00	00	00

Page
 Pagina
 Page
 Bladzijde

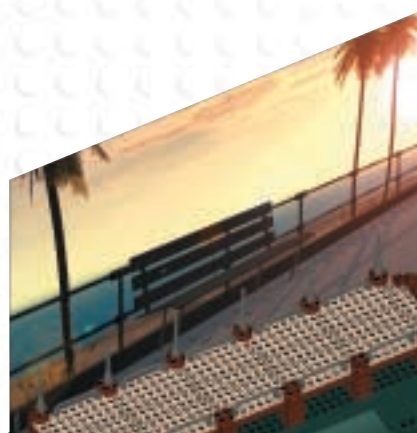

Section 5 • Sección 5
 Section 5 • Deel 5

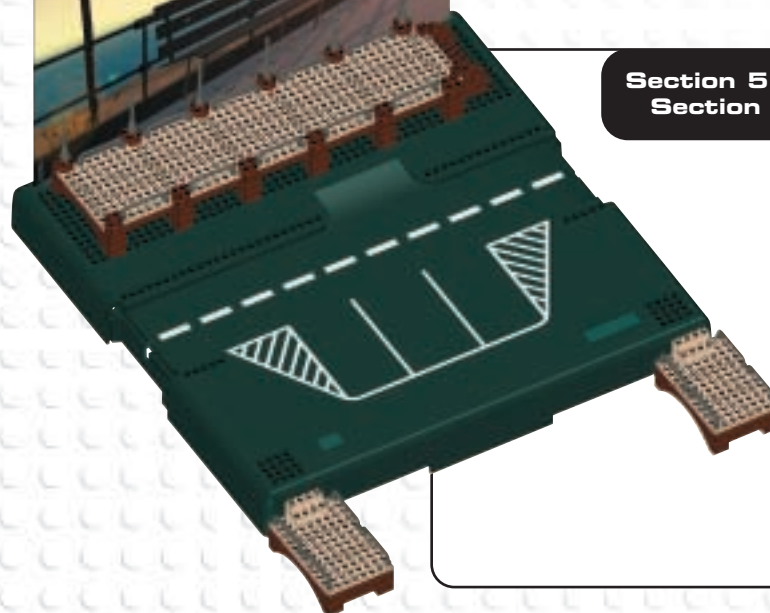

34

Off Shore Racing™

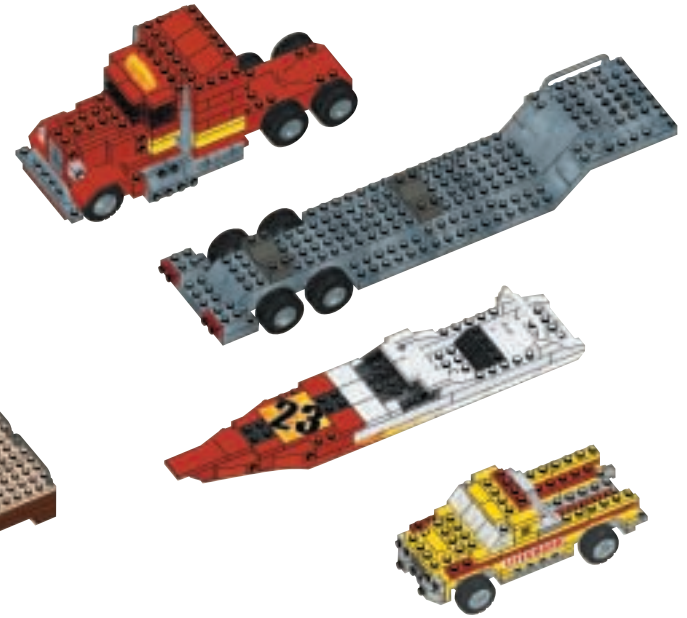
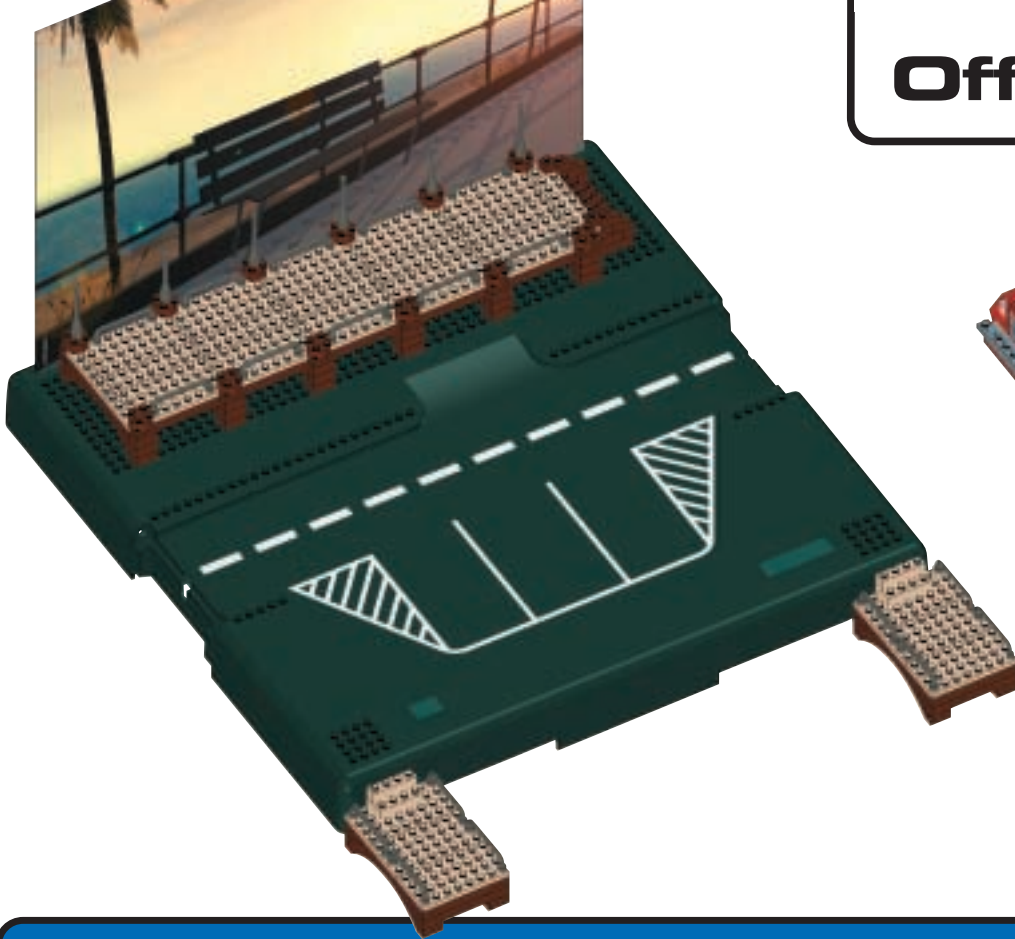

Color chart • Cuadro cromático • Charte de couleurs • Färgtabell

Active step
 Etapa activa
 Étape active
 Aktivt skede

Previous step
 Etapa precedente
 Étape précédente
 Föregående skedet

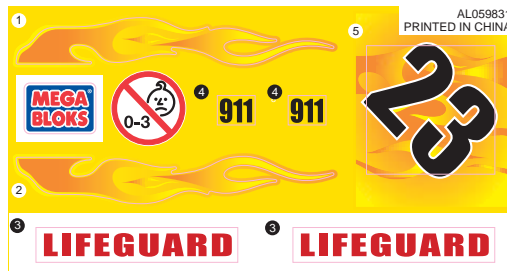
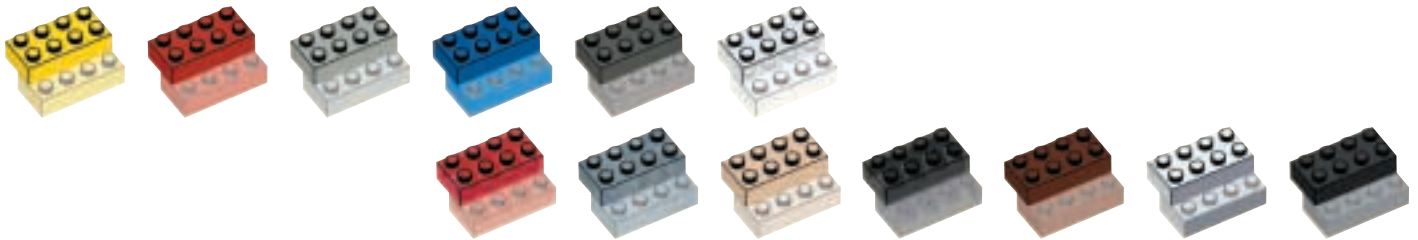

















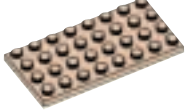























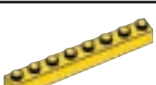





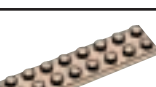

















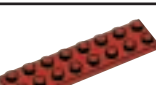
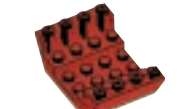

















































AL059831
 PRINTED IN CHINA







Apply stickers
 Aplicar autoadhesivos
 Appliquer les autocollants
 Stickers aanbrengen

1x
 AL059831

Parts List • Lista de piezas Liste de pièces • Onderdelenlijst

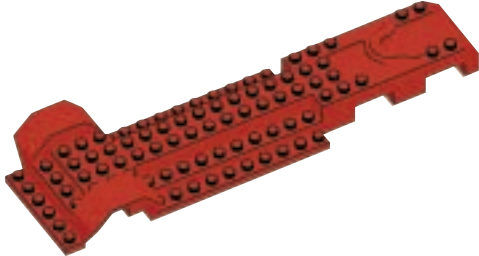
	2x AM25002DR		8x AM25047KJ		2x AM25010JN		3x AM25057W		4x AM25016E		1x AM25092E		16x AM25020DR
	2x AM25002X		4x AM25047A		2x AM25005DR		4x AM25027JG		2x AM25035E				15x AM25013DH
	2x AM25002A		1x AM25047E		5x AM25005KJ		2x AM25027F		3x AM25035A			4x AM25013A	
	2x AM25002E		4x AM25025DH		4x AM25005A		2x AM25027KJ		2x AM25022DR			4x AM25013E	
	8x AM25002JN		8x AM25025KJ		2x AM25005E		3x AM25027E		1x AM25022KJ			2x AM25013JN	
	8x AM25008DH		2x AM25025D0		8x AM25005JN		4x AM25042KJ		6x AM25022A			2x AM25013JN	
	2x AM25008W		2x AM25025E		2x AM25011DR		2x AM25042JN		3x AM25022E			6x AM25018DR	
	2x AM25008A		24x AM25009DH		2x AM25011WA		1x AM25031A		2x AM25022JN			2x AM25018KJ	
	1x AM25003DR		4x AM25009WA		2x AM25011A		12x AM25038DH		3x AM25006B			4x AM25018A	
	12x AM25003DH		2x AM25009KJ		4x AM25011JN		8x AM25015A		2x AM25006KJ			6x AM25023DH	
	4x AM25003X		7x AM25009A		2x AM25014F		1x AM25015E		2x AM25006A			3x AM25012B	
	2x AM25003W		3x AM25009E		1x AM25014KJ		4x AM25015JN		1x AM25006JN			1x AM25012A	
	7x AM25003A		3x AM25009JN		1x AM25014A		2x AM25028WA		3x AM25012B			1x AM25012JN	
	3x AM25003D0		6x AM25029JN		1x AM25014E		3x AM25028A		1x AM25012A			1x AS059835	
	1x AM25003E		6x AM25004A		3x AM25034E		2x AM25007A		1x AM25012JN			4x AS059836	
	1x AM25033JG		2x AM25030WA		9x AM25034A		2x AM25007JN		1x AM25017A			6x AM25049JG	
	8x AM25033A		4x AM25030A		2x AM25048KJ		3x AM25016KJ		7x AM25017JN			3x AM25092KJ	
	8x AM25033E		4x AM25030E		1x AM25021W		8x AM25016A		18x AM25092JG			3x AM25092KJ	
	7x AM25033JN		2x AM25010A		2x AM25021JN		3x AM25016JN		3x AM25092KJ			3x AM25092KJ	

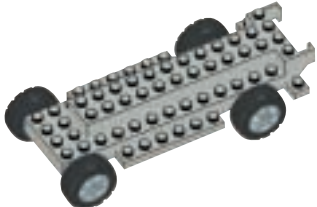
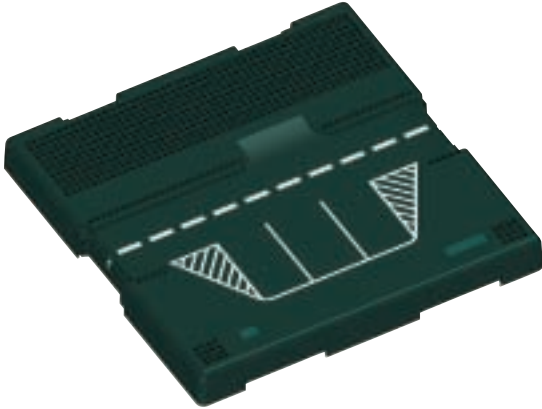
Parts List • Lista de piezas Liste de pièces • Onderdelenlijst

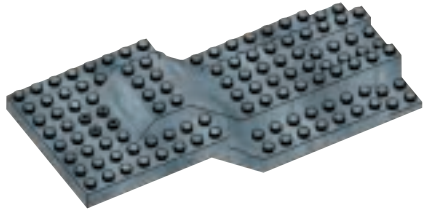
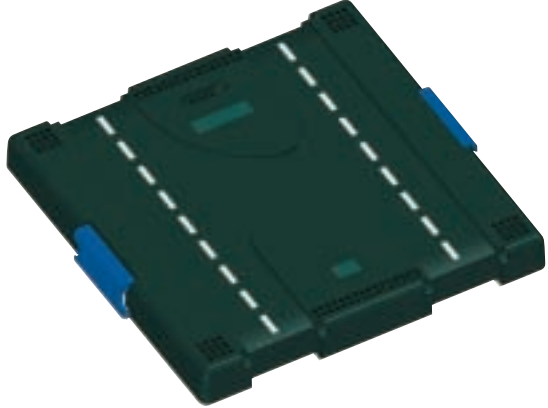
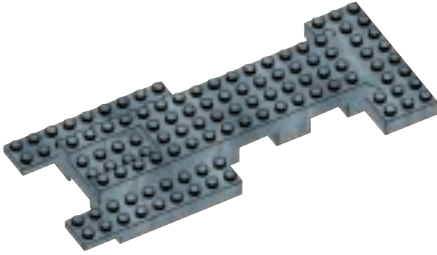
	<p>3x AS059015</p>		<p>1x AM25075A</p>
	<p>1x AS059013</p>		<p>1x AF059832</p>
	<p>1x AS059834</p>		<p>1x AS059832</p>
	<p>2x AM25094KJ</p>		<p>10x AM25037DH</p>
	<p>1x AM25076KJ</p>		<p>1x AS059839</p>
	<p>1x AM25069KJ</p>		

Section 1 • Sección 1
Section 1 • Deel 1

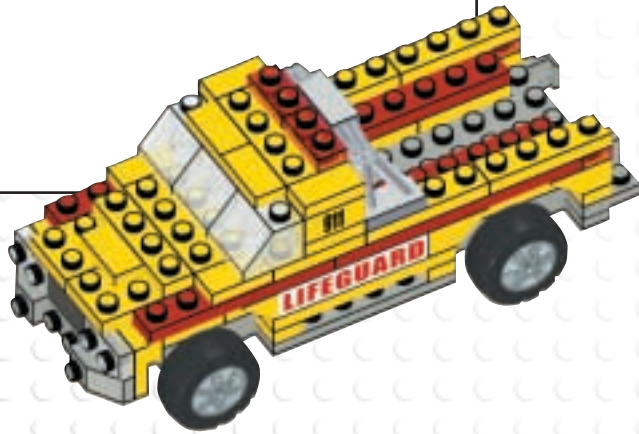

01



3x

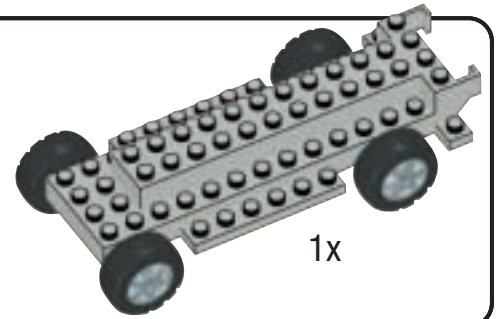

1x

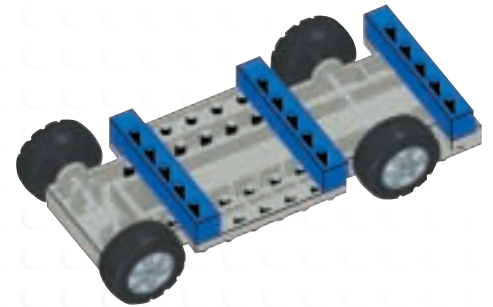

02



3x

03



4x

2x

04



4x

2x

2x

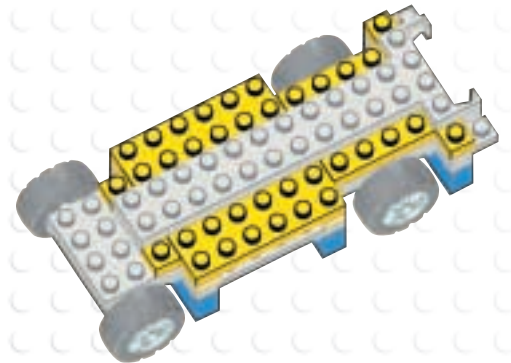
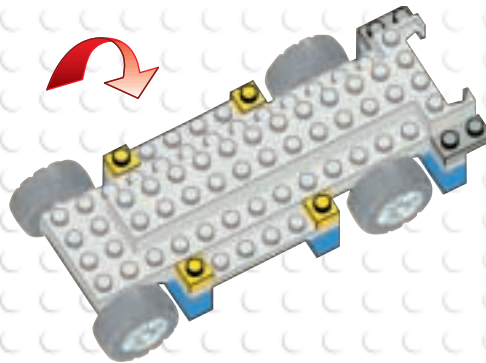
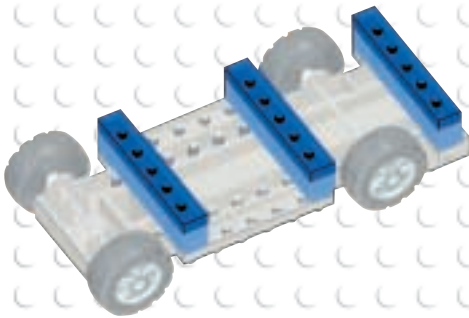

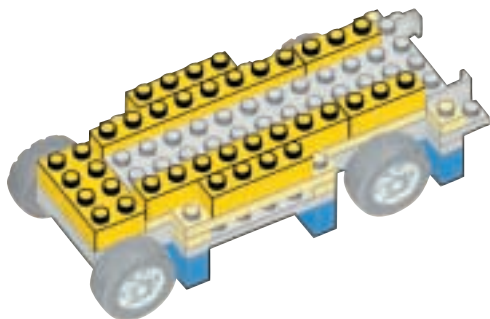
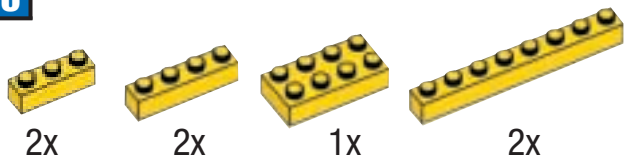
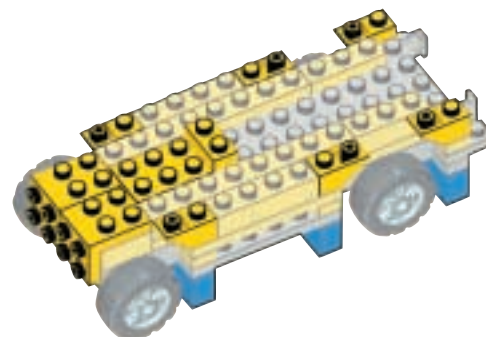
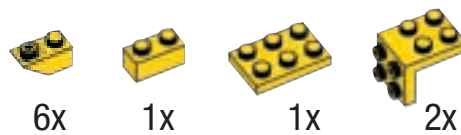
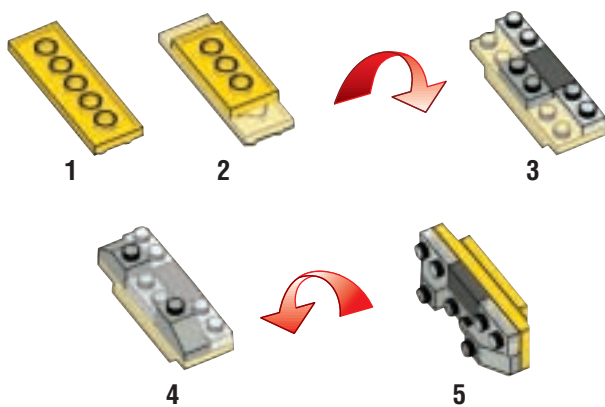
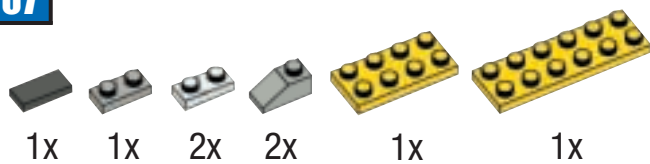
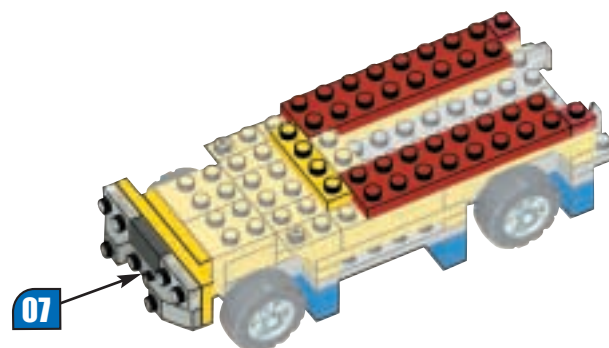
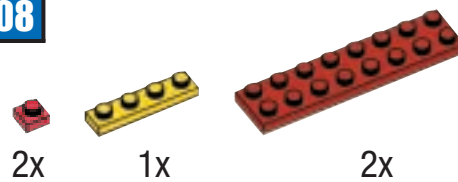
05**06****07****08**

09



2x

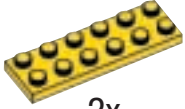

2x

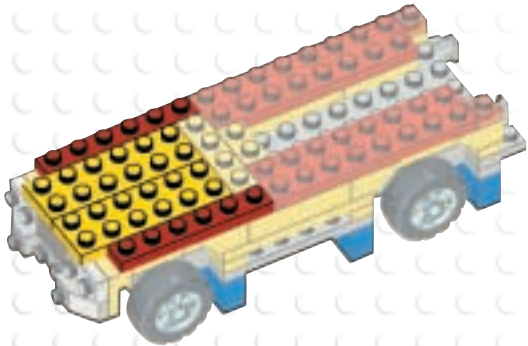

10



2x



4x



3x

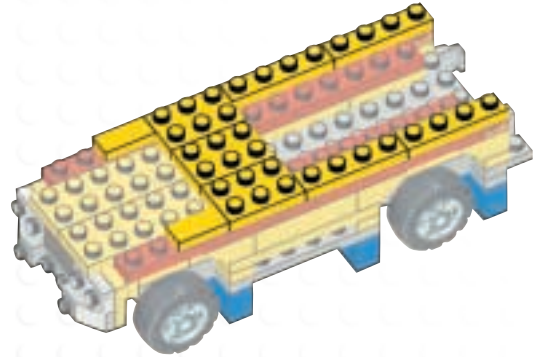

11



1x



1x



1x

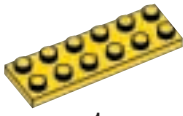

1x



1x

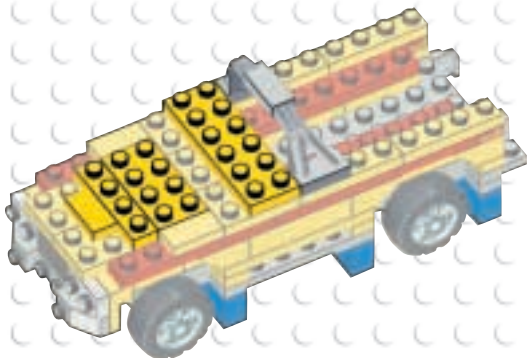

12



2x



1x

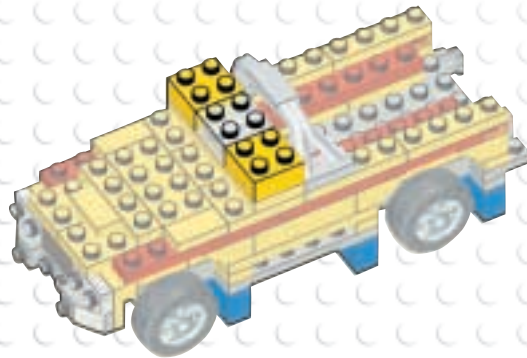

13



3x



1x

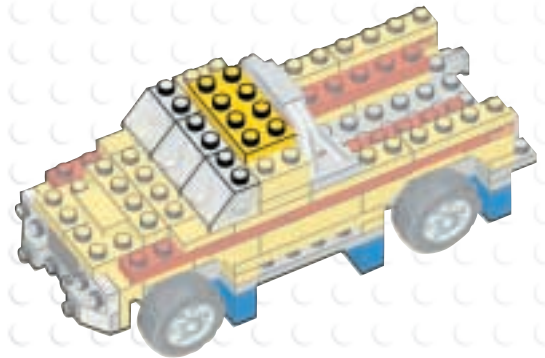

14



2x



4x

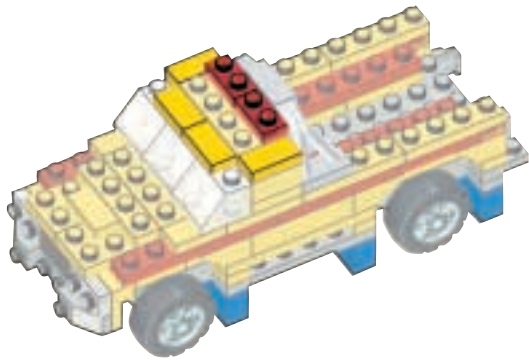

15

Remove temporary pieces.
Retirar las piezas provisionales.
Enlever les pièces temporaires.
Verwijder tijdelijkedelen.

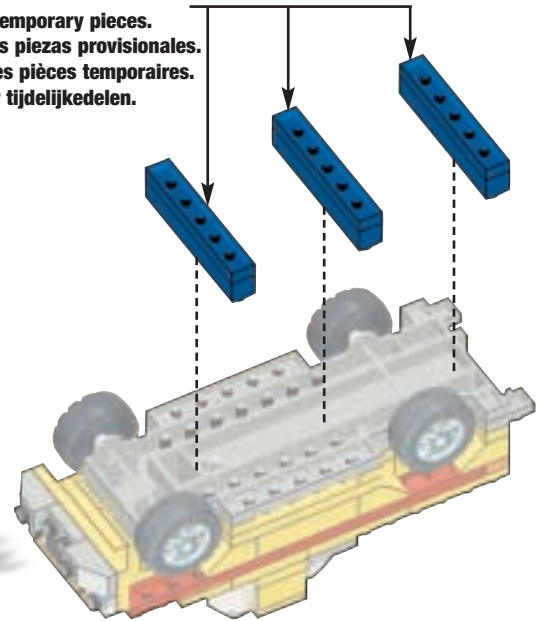

16

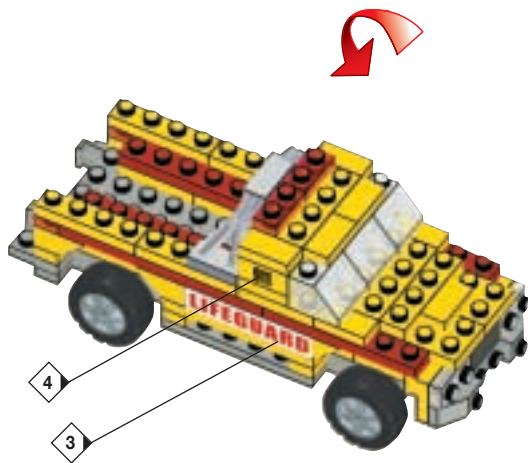

17

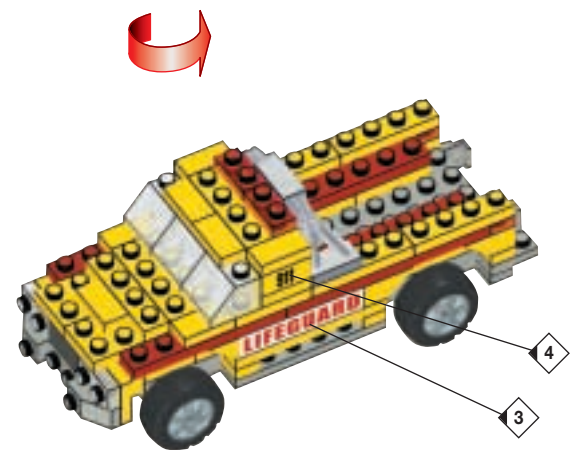

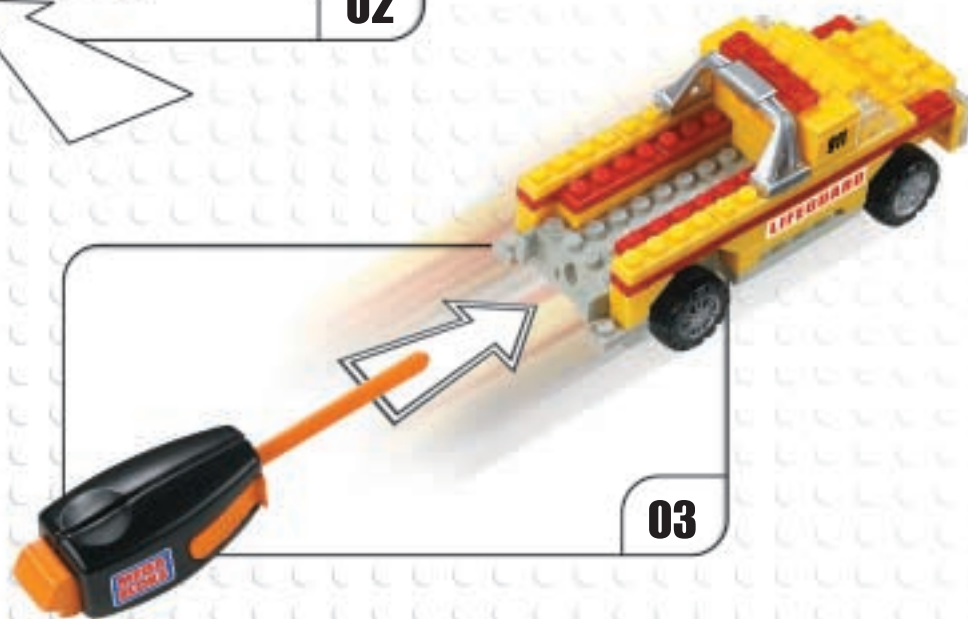

Section 2 • Sección 2
Section 2 • Deel 2

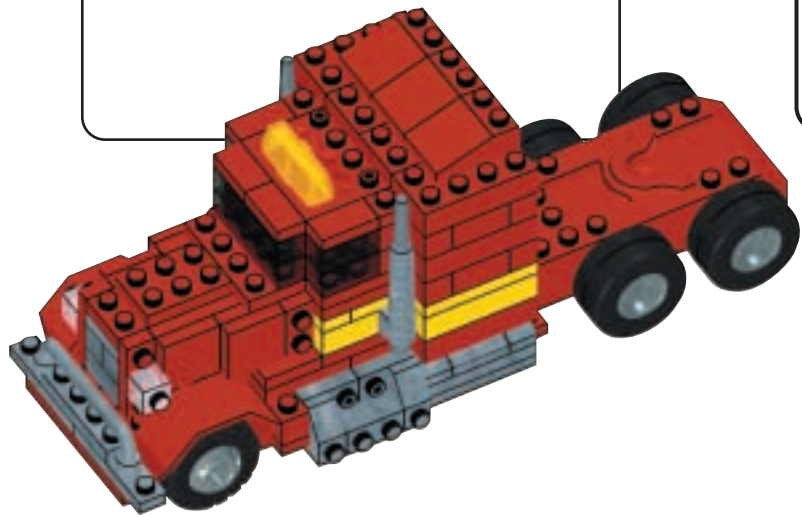

01

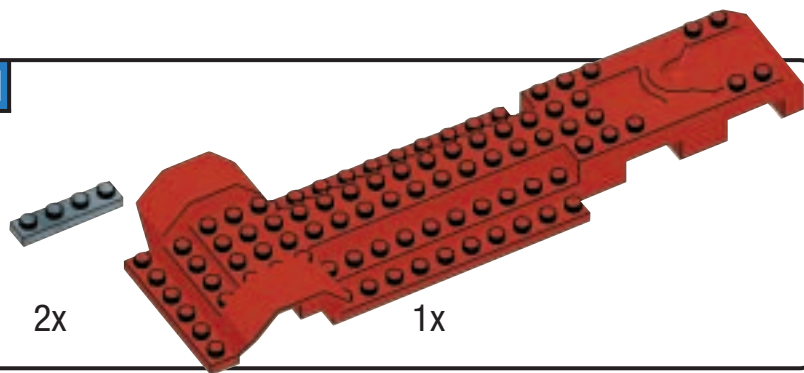

2x

1x

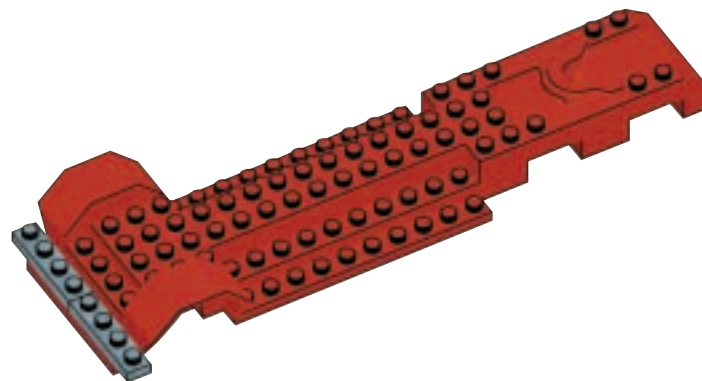

02



2x

2x

03



2x

2x

1x

1x

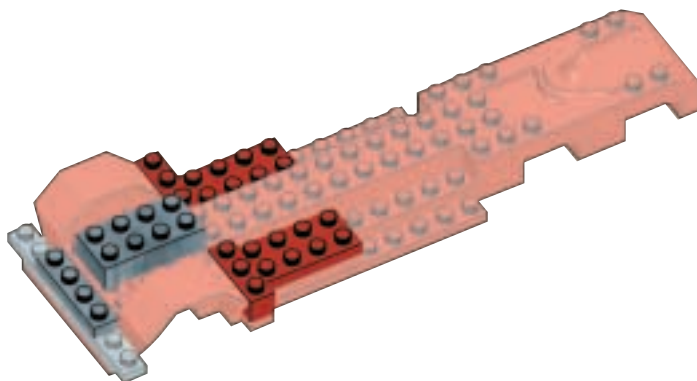
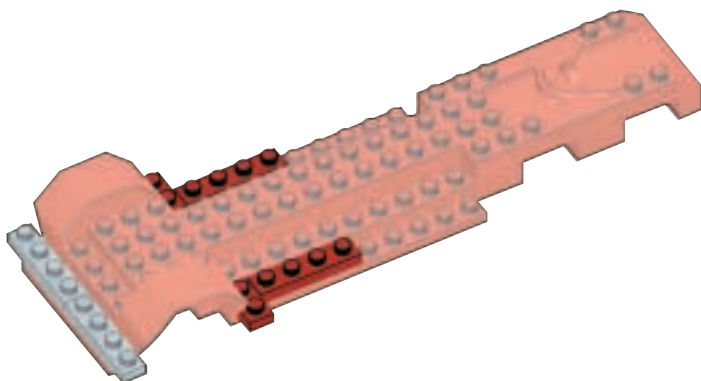

04

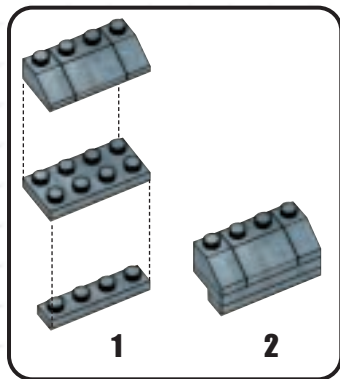
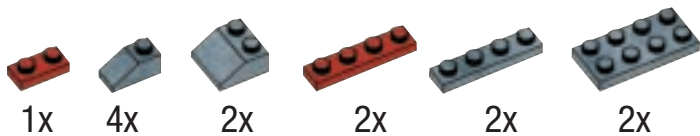

2x

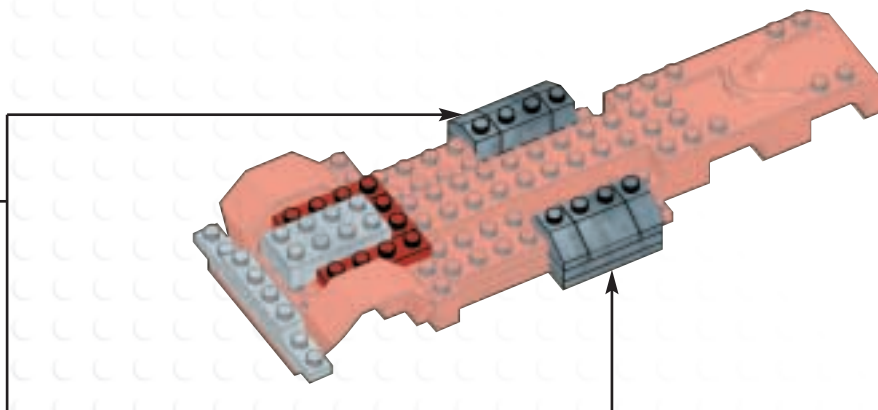

05

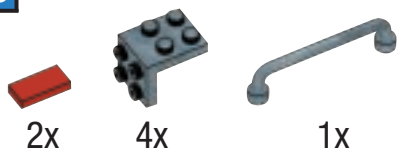

06

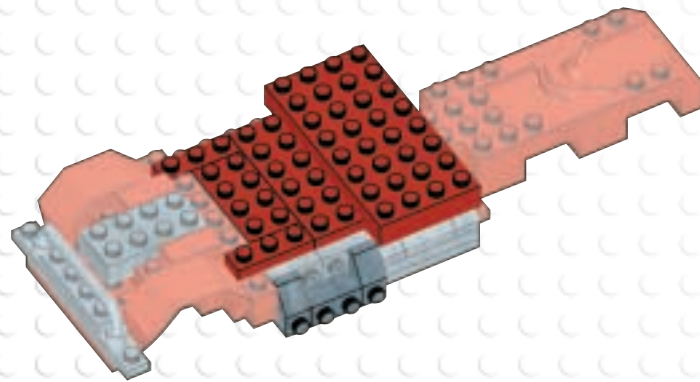
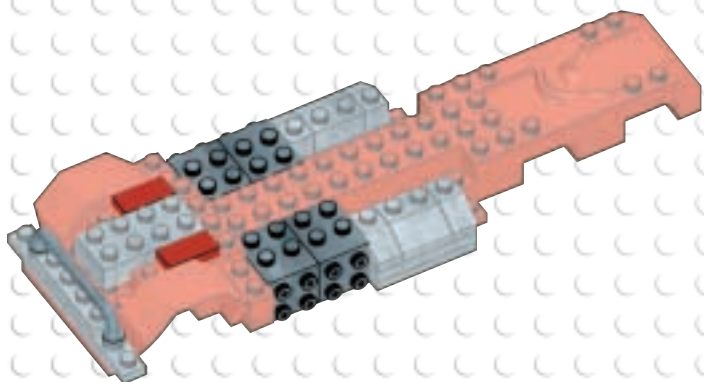
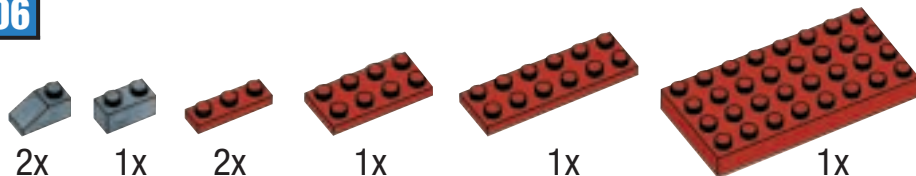

07



2x



2x



1x

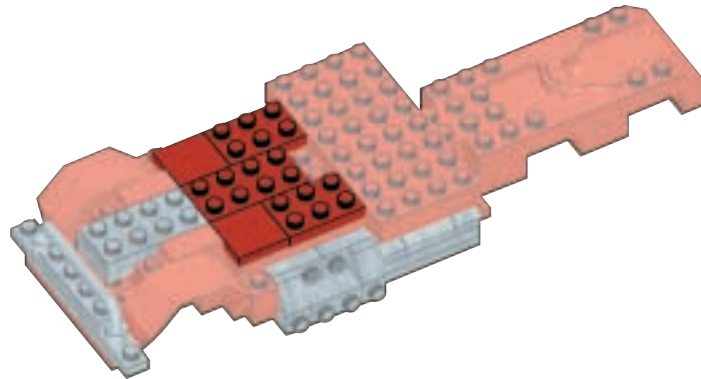

08



6x



2x



2x



1x

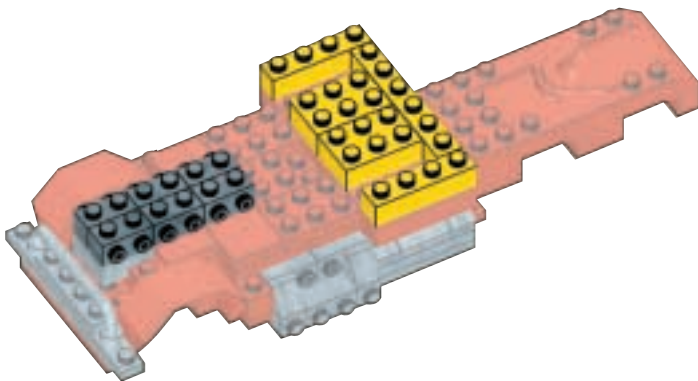

09



2x



2x



1x



1x



2x

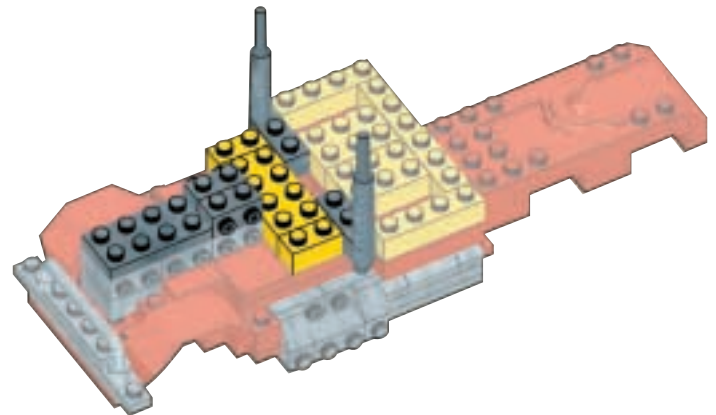

10

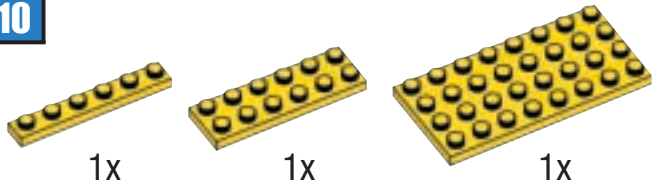

11

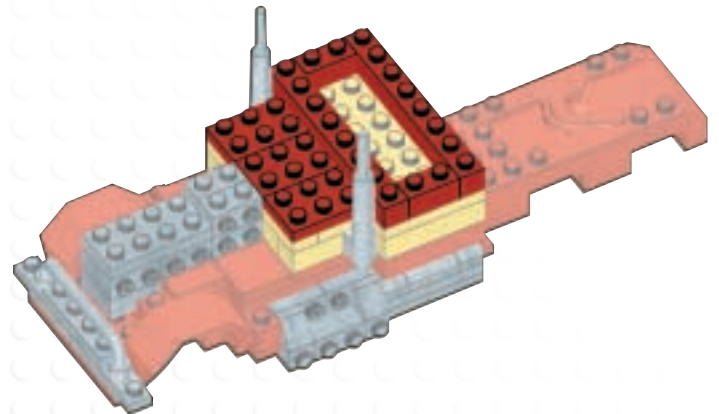
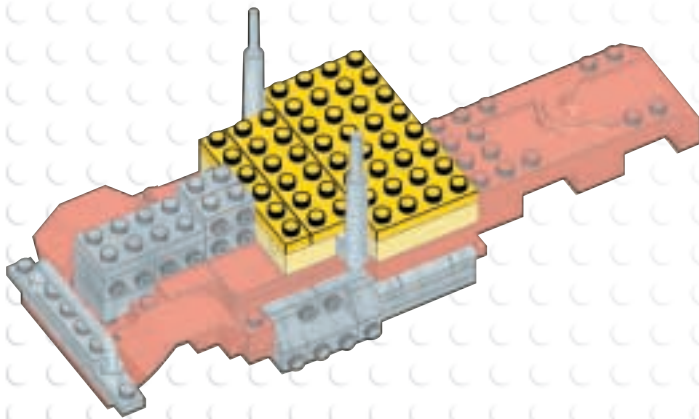
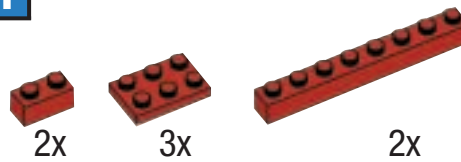

12

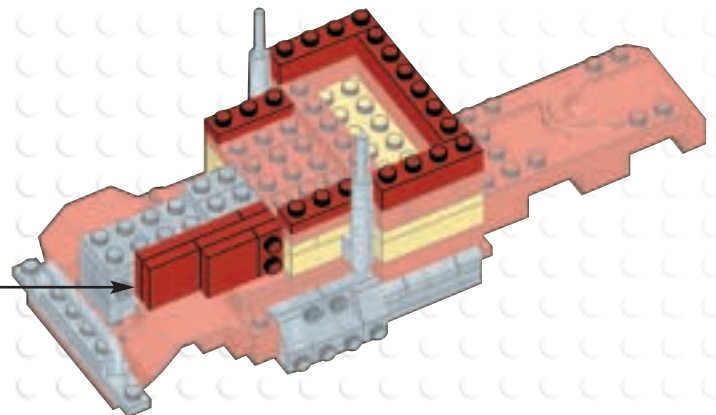
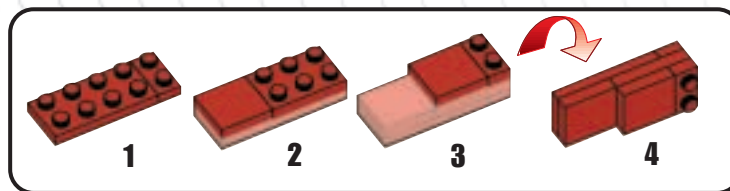
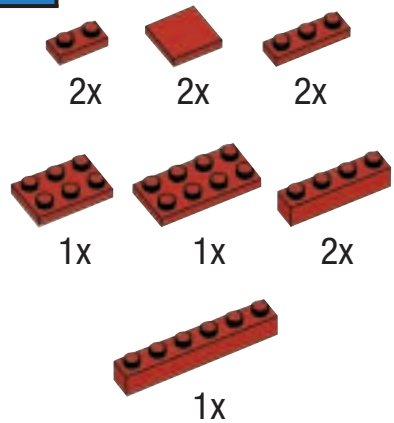

13

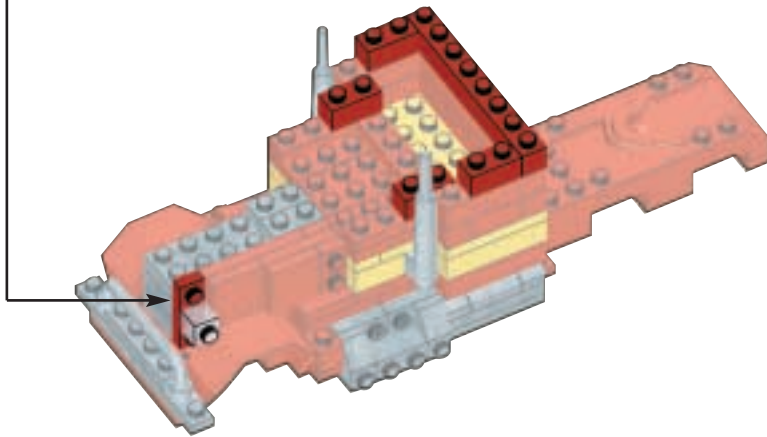
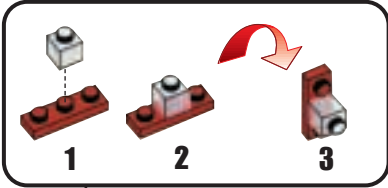
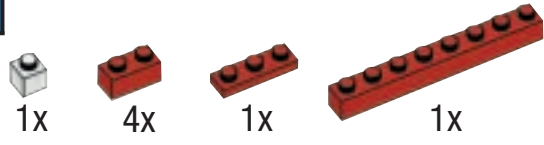

14

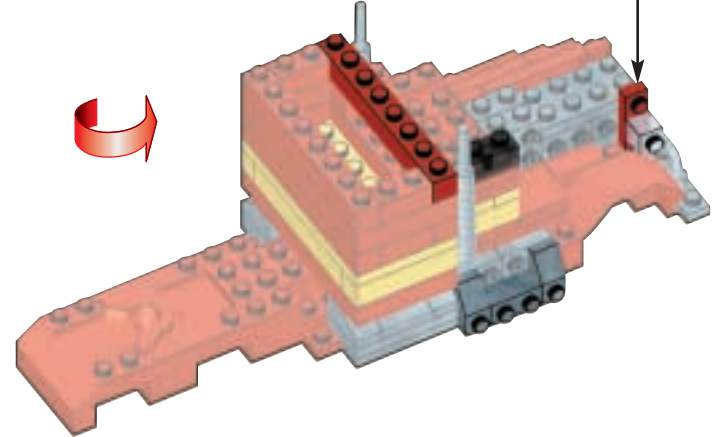
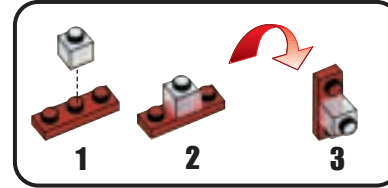
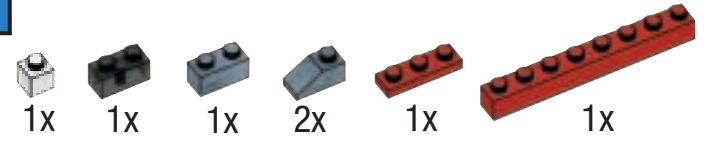

15

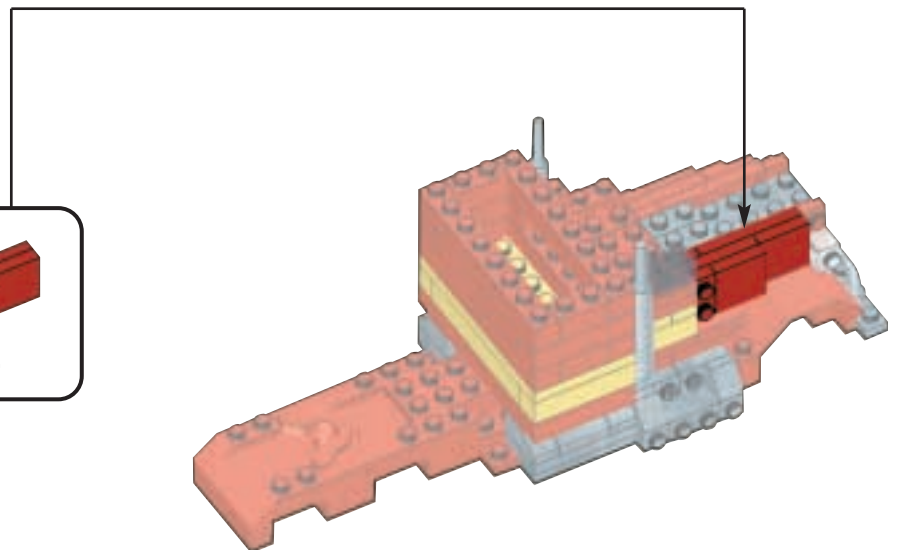
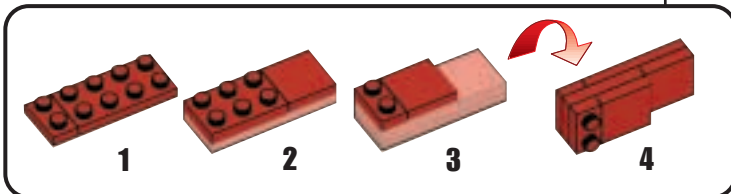
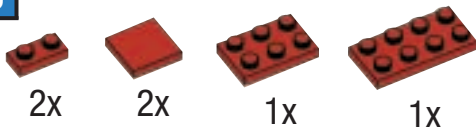

16



2x



1x



1x



1x



1x

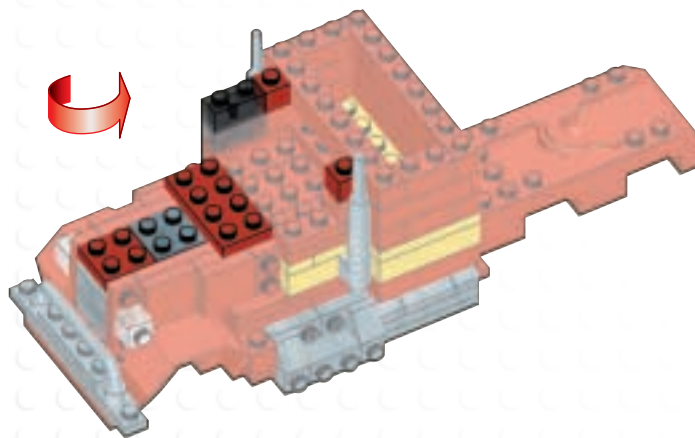

17



1x



1x

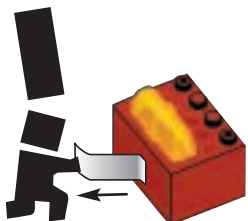

Pull tab to activate.
Tirar de la lengüeta para activar.
Tirer la languette pour activer.
Trek aan het lipje om te activeren.

18



1x



1x

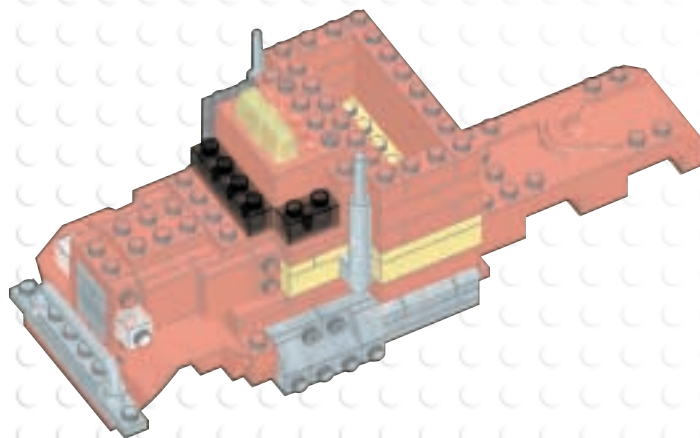
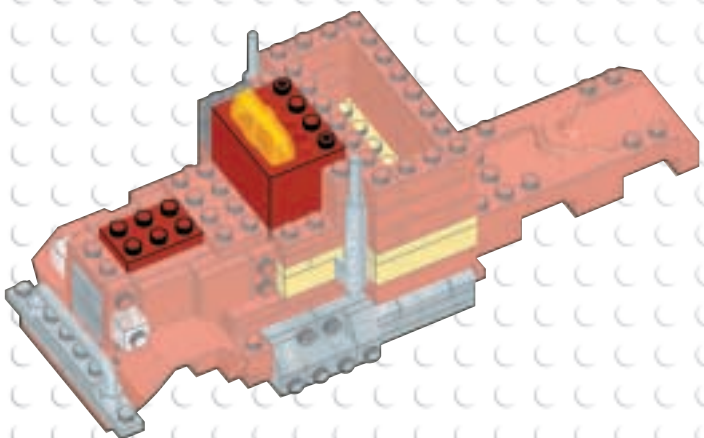

19



1x



1x



4x

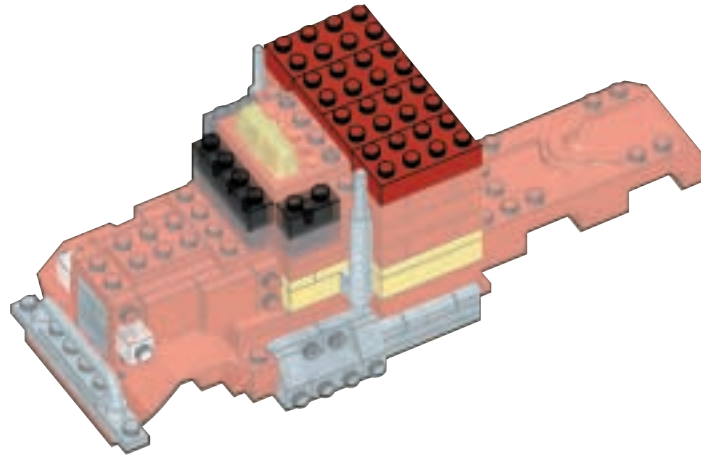

20



2x



4x



3x

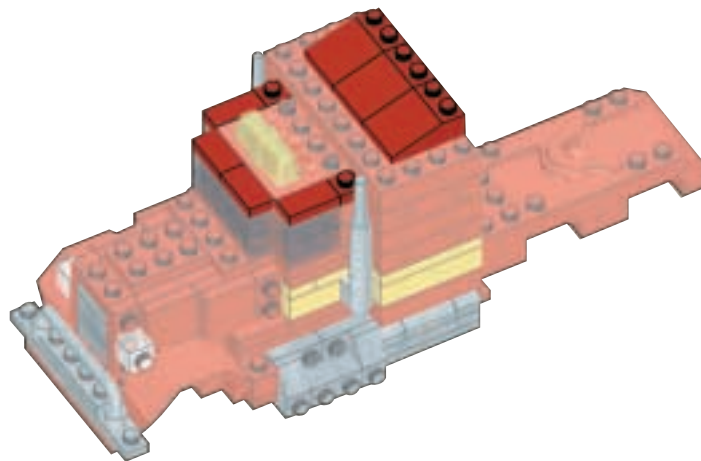

21



1x



2x

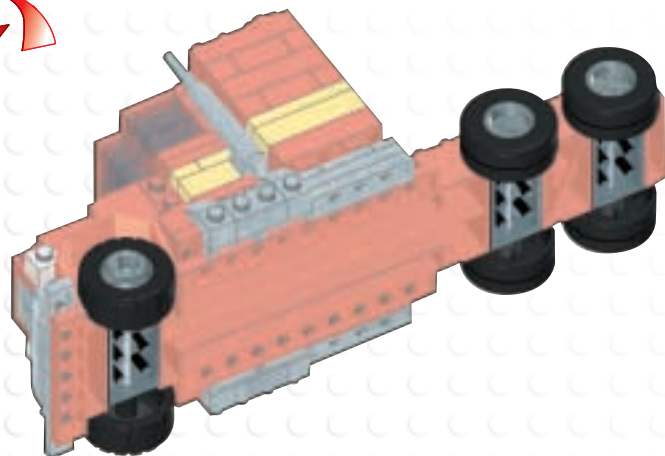

22

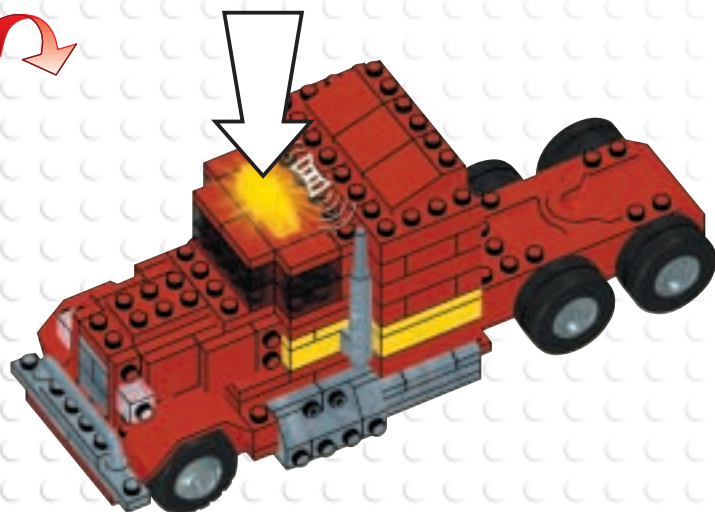

Section 3 • Sección 3
Section 3 • Deel 3

01

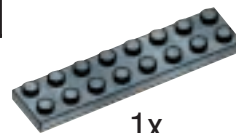

1x



02

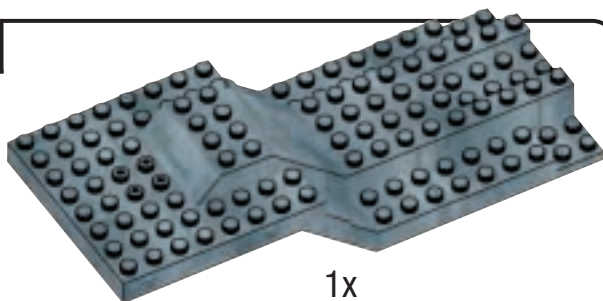

1x

03

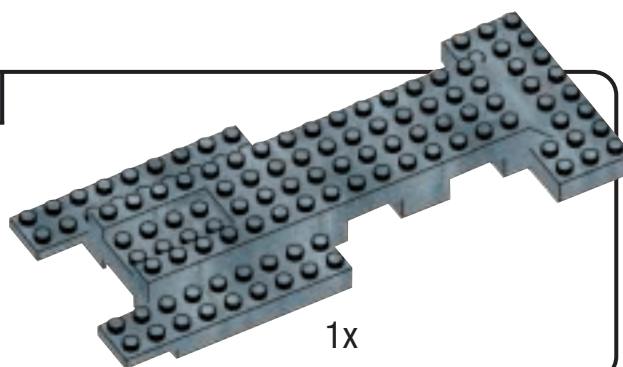

1x

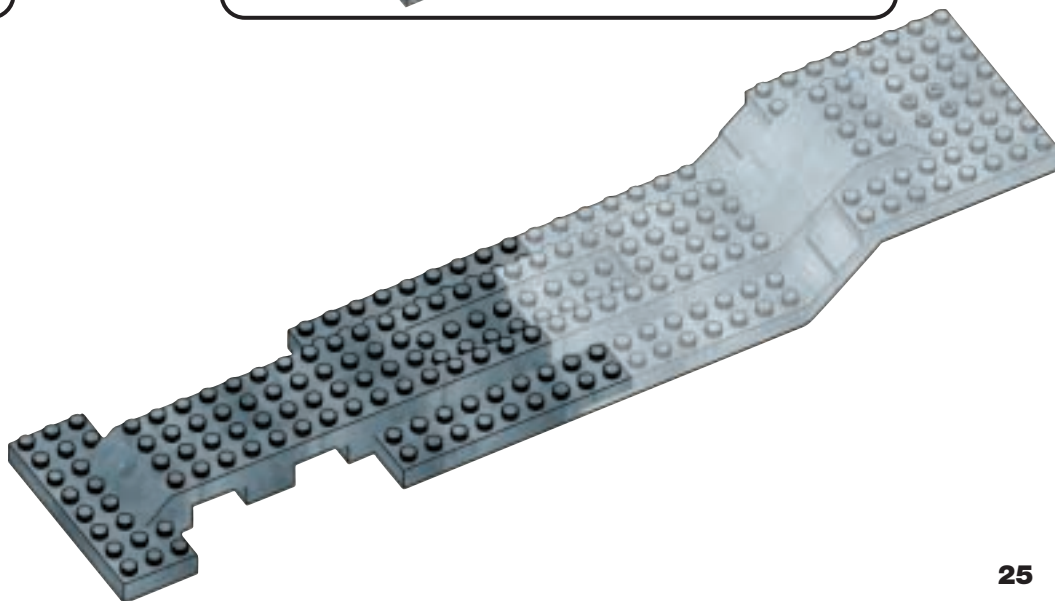
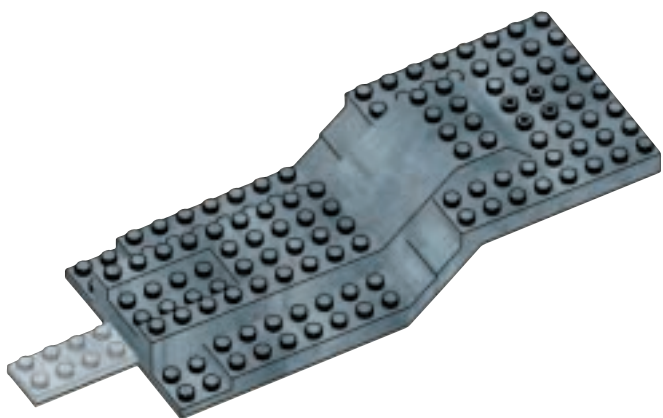

04



2x



1x

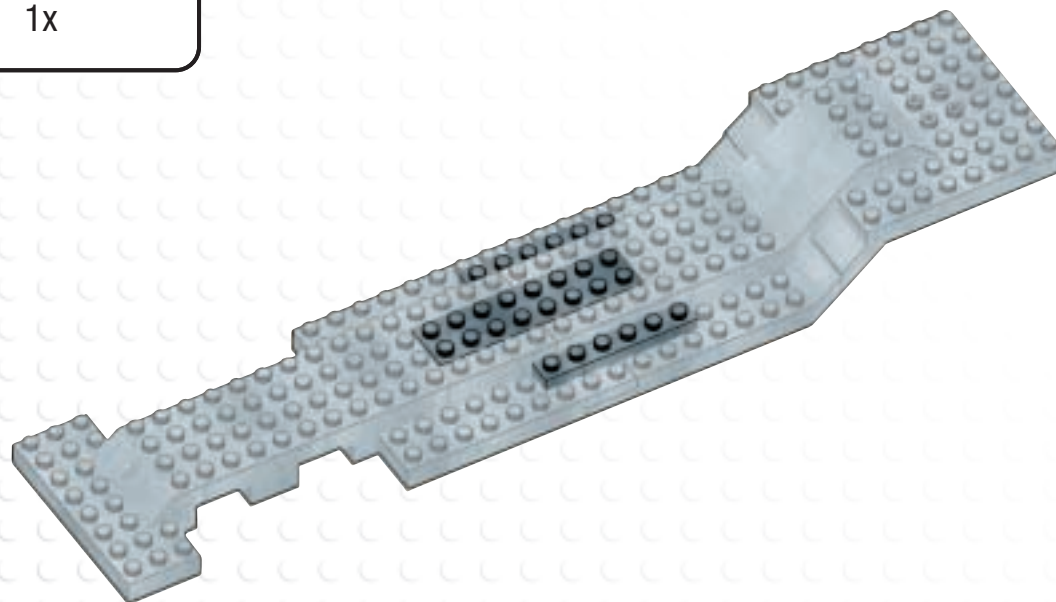

05



2x



4x

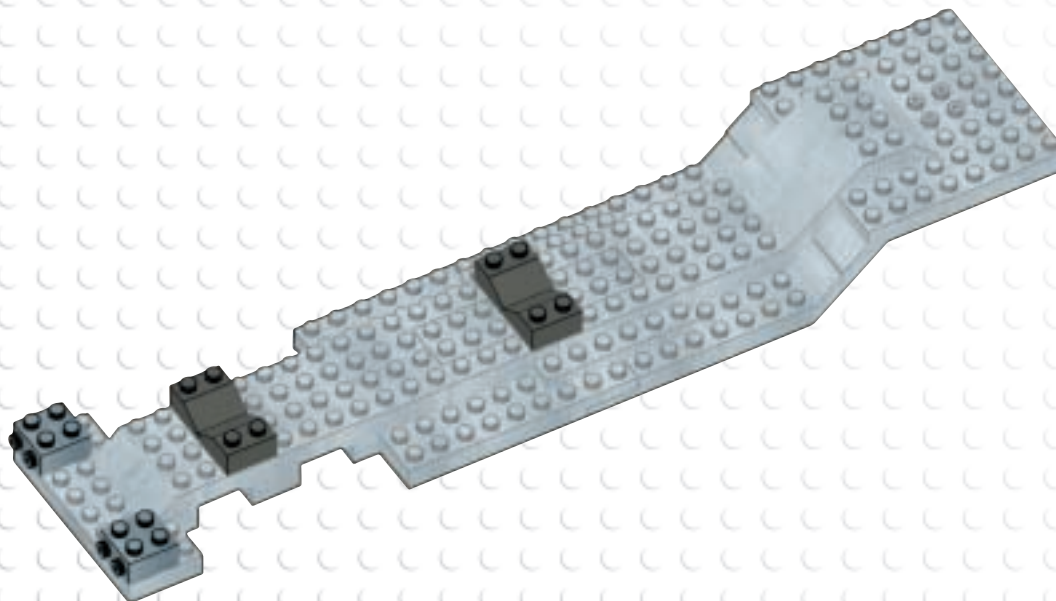

06



2x



2x

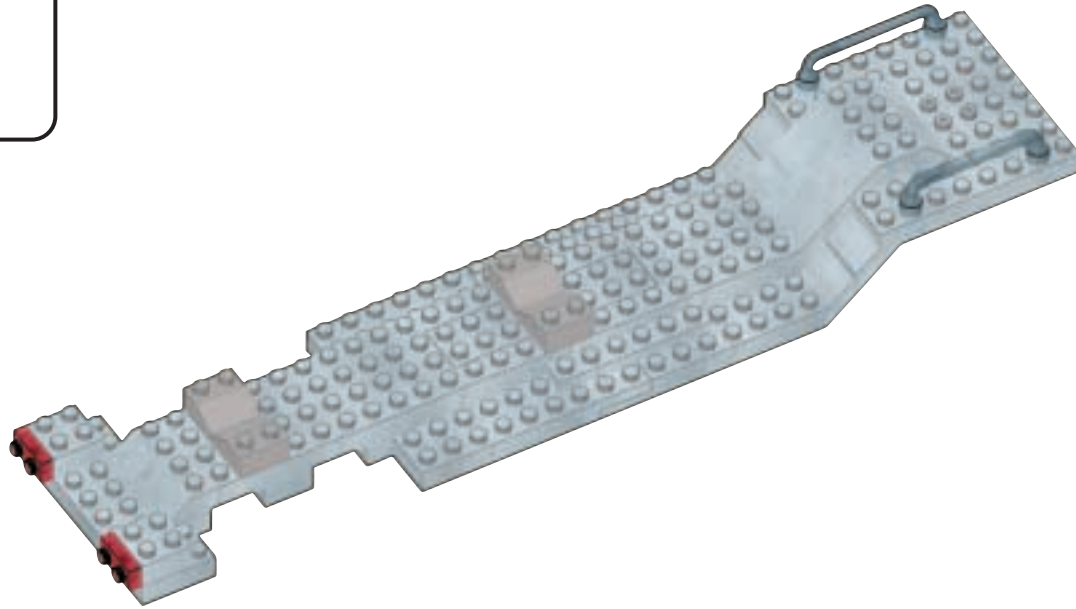

07



2x

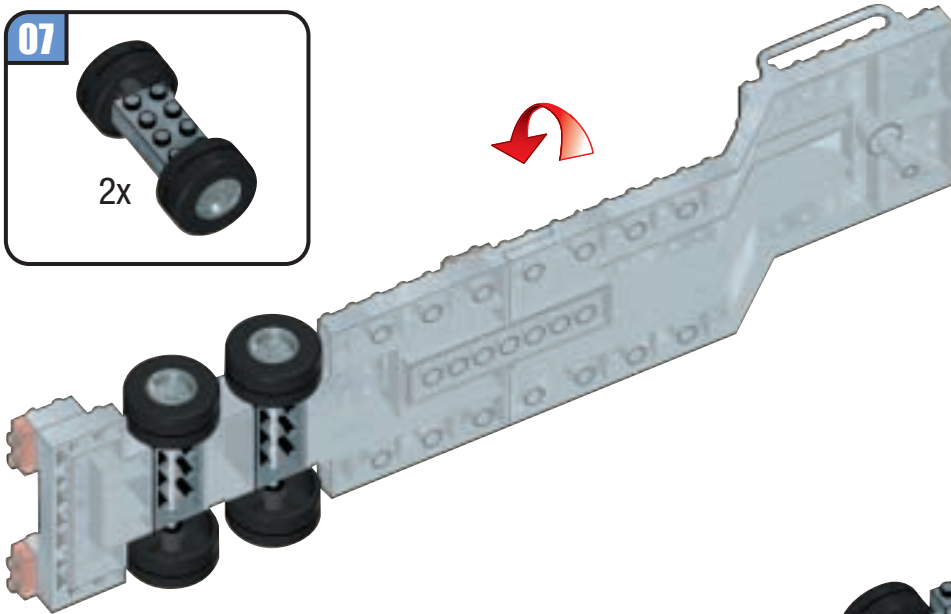

08

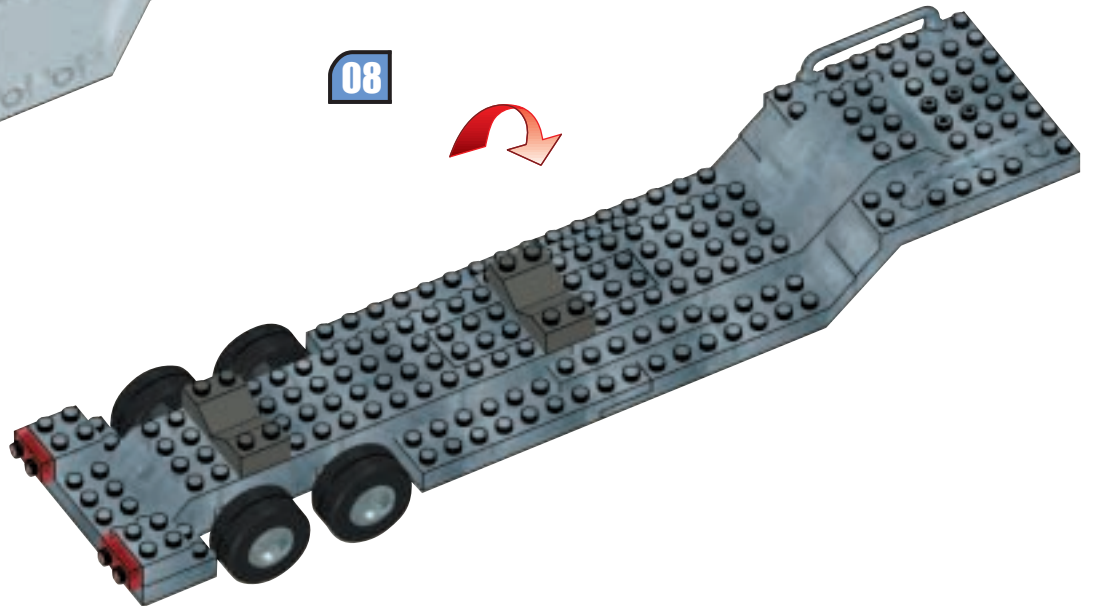

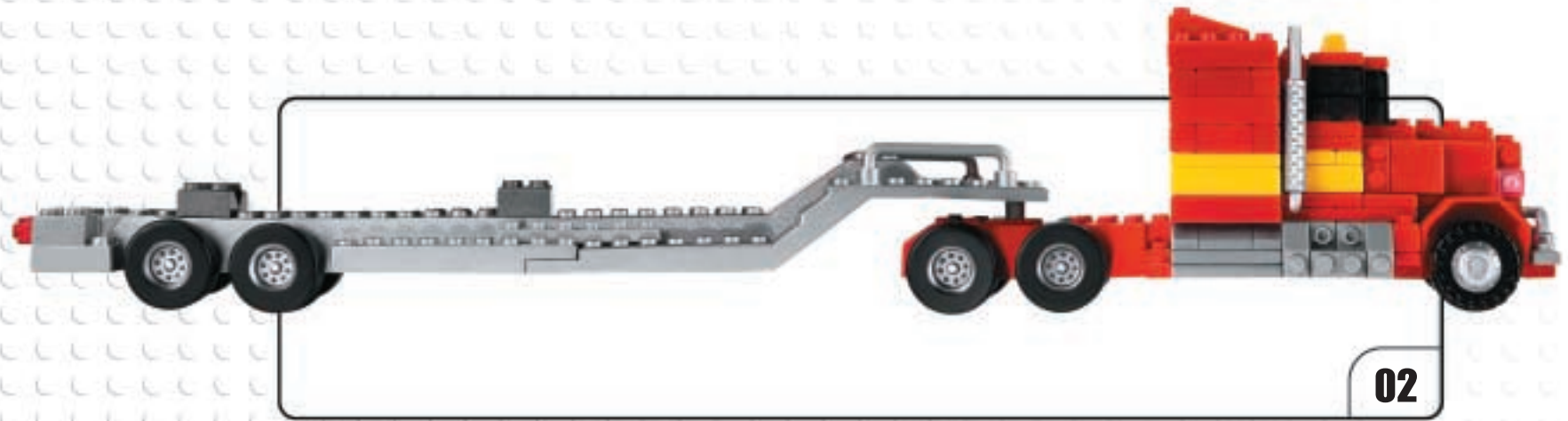
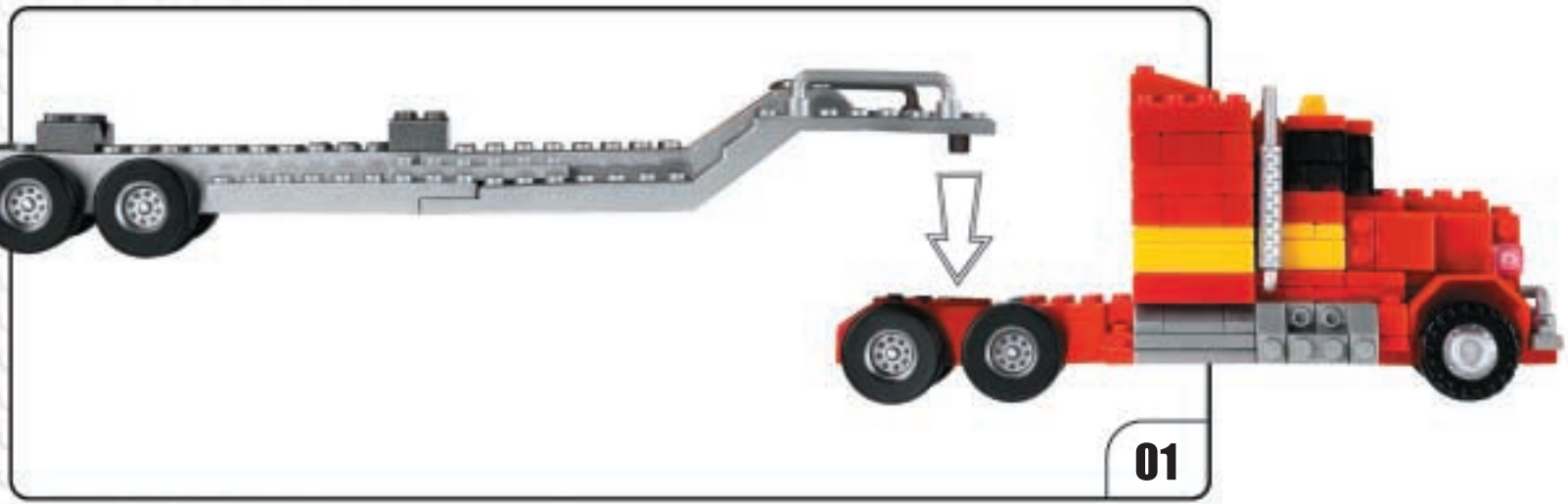



Section 4 • Sección 4
Section 4 • Deel 4

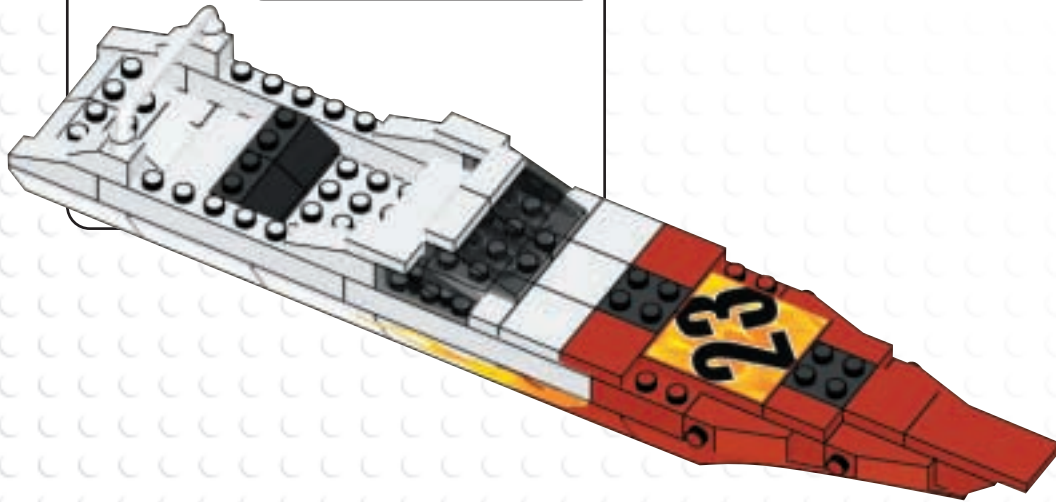

01



2x



02



1x



1x



2x

03



2x



2x

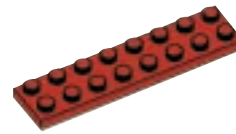

1x

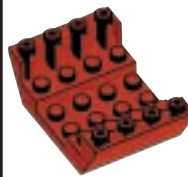

1x

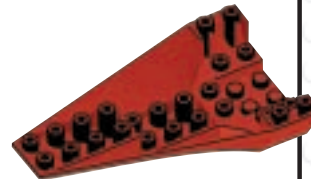

1x



2x

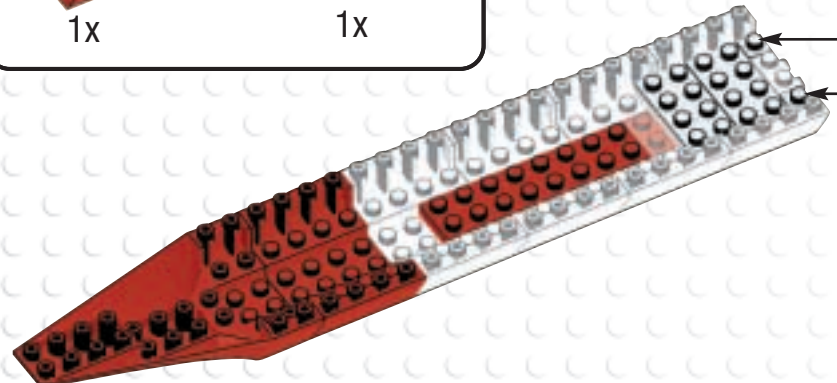
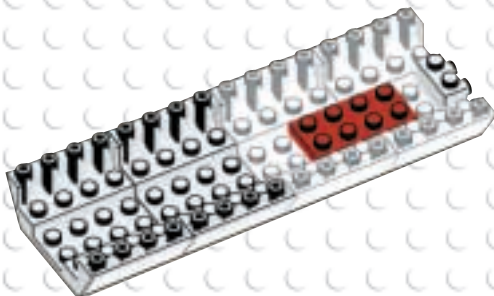

04

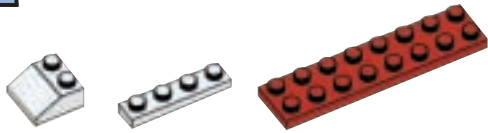

2x

1x

1x

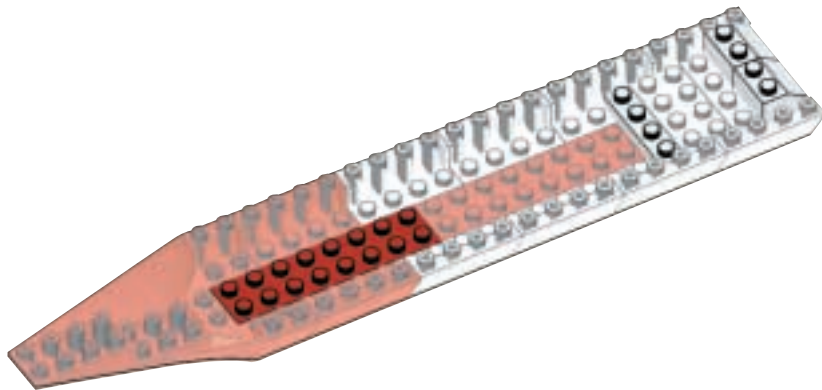

05

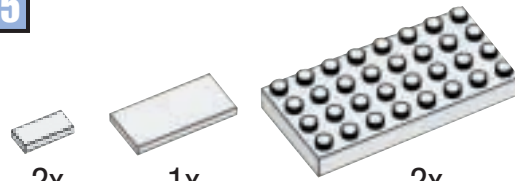

2x

1x

2x

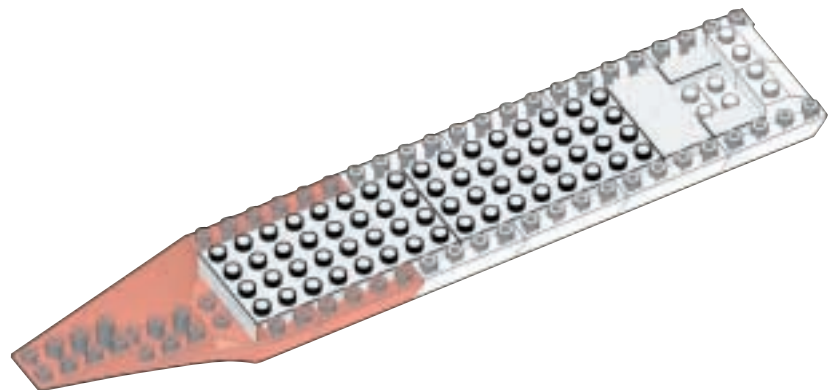

06



3x

1x

2x

1x

1x

3x

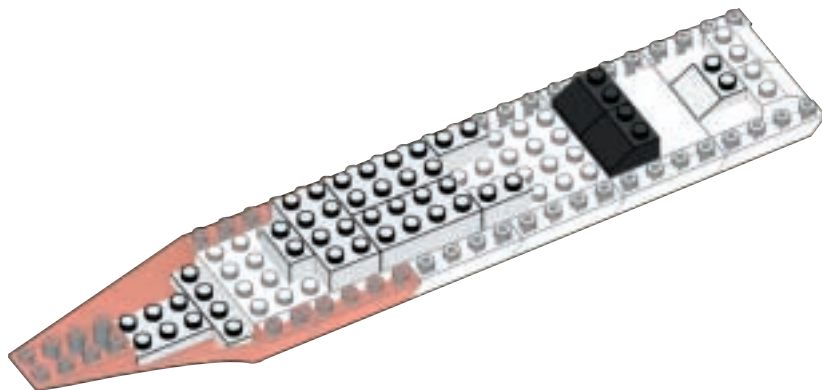

07



1x

2x

1x

4x

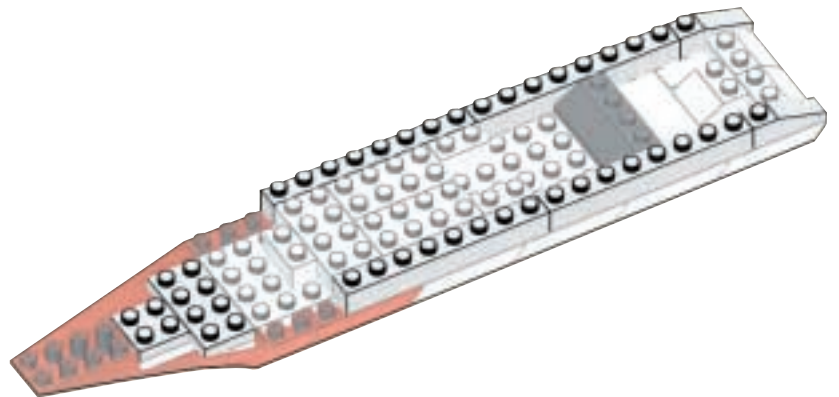

08

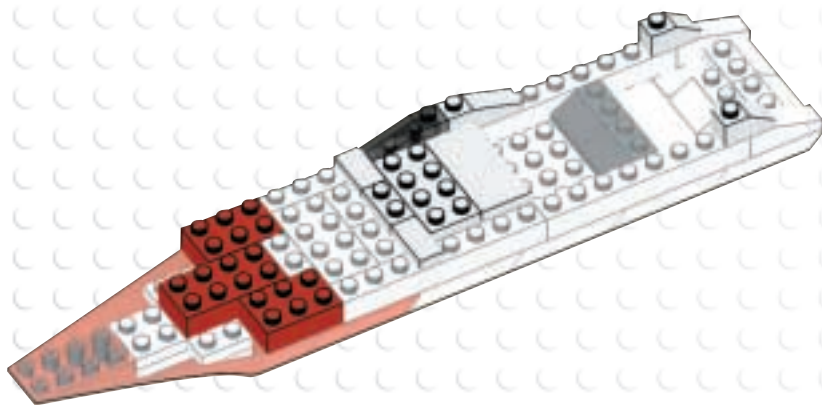
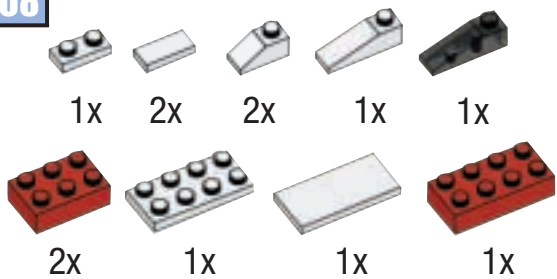

09

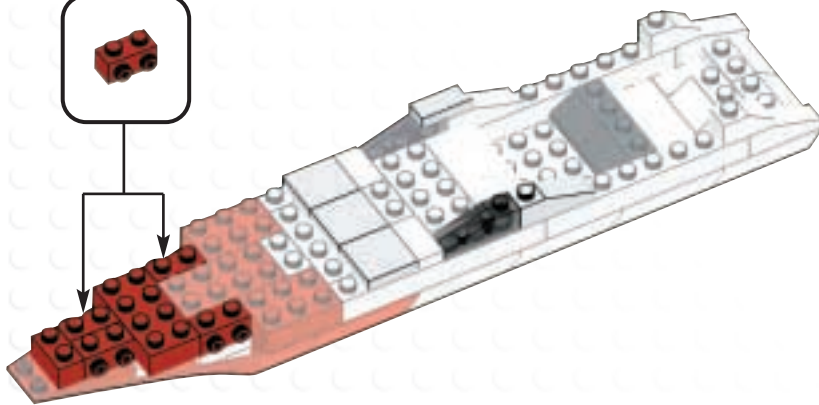
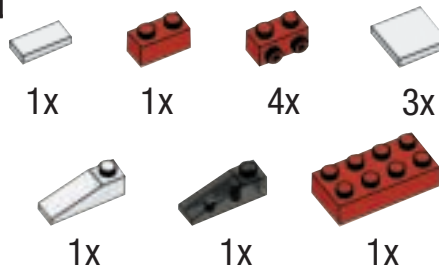

10

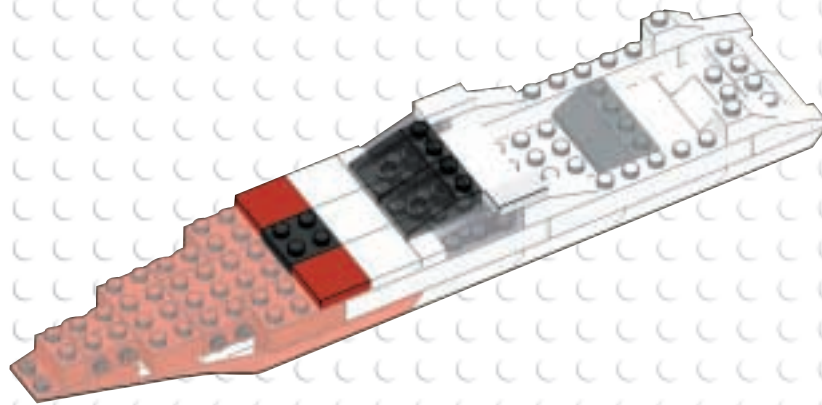
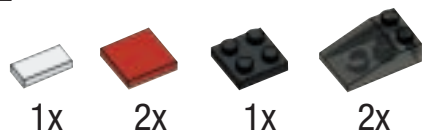

11

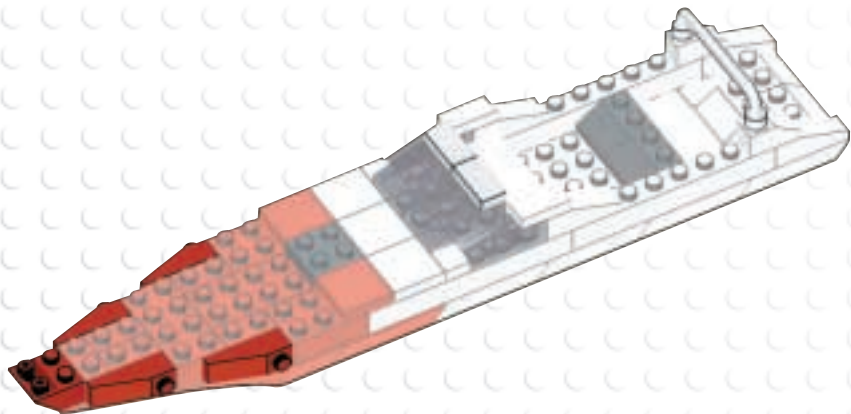
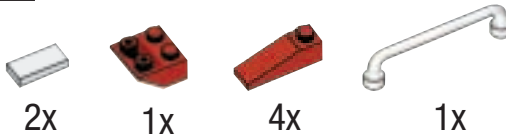

12



2x

1x

2x

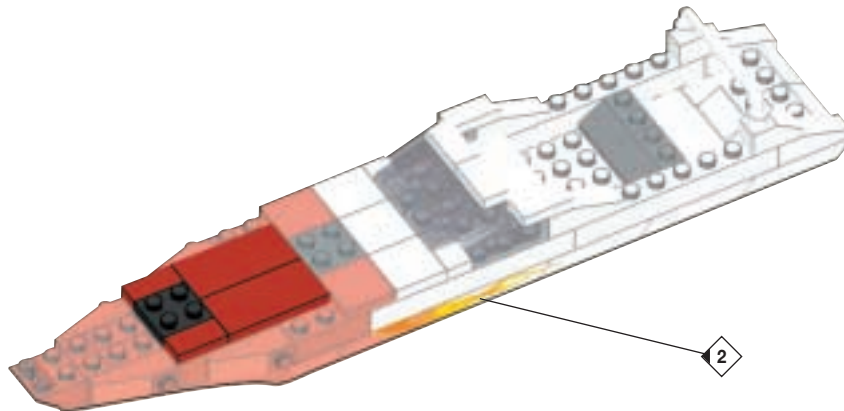

13

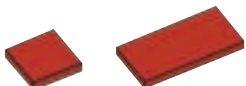

1x

1x

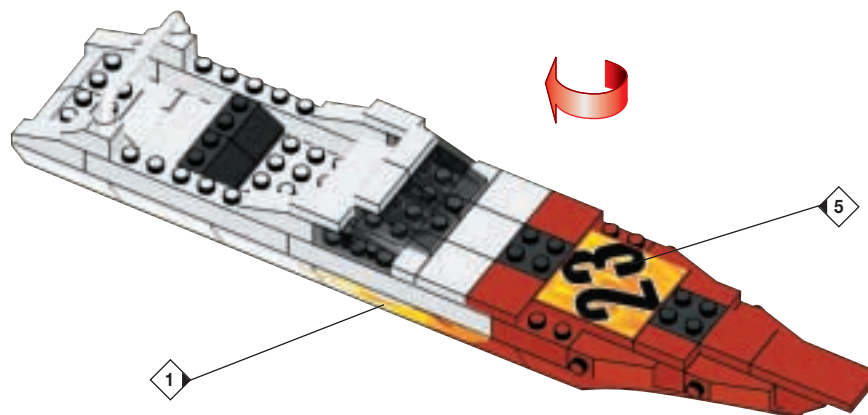

Section 5 • Sección 5
Section 5 • Deel 5

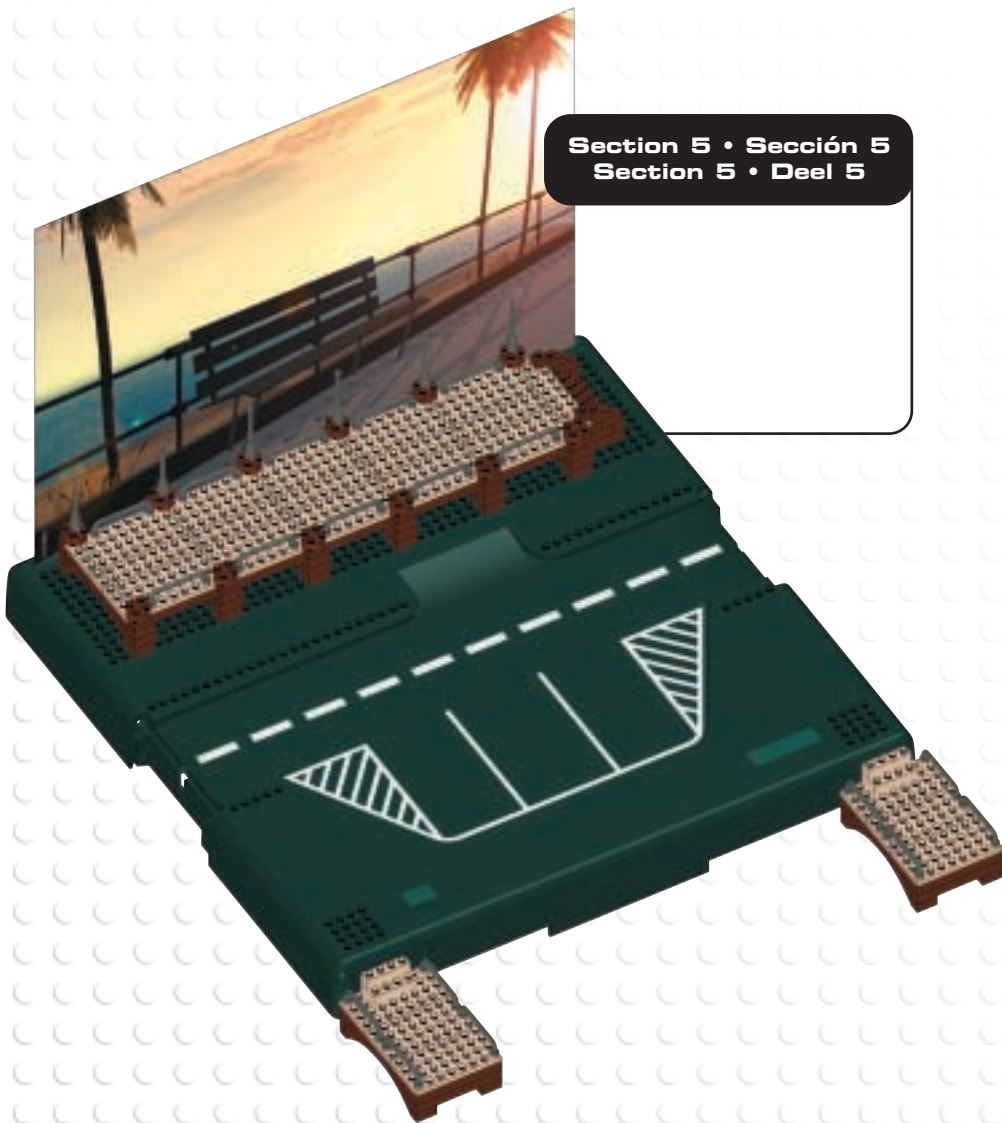

01

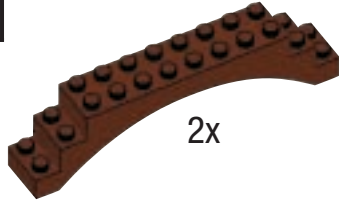

2x



02

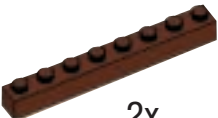

2x

03

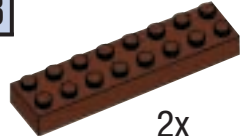

2x

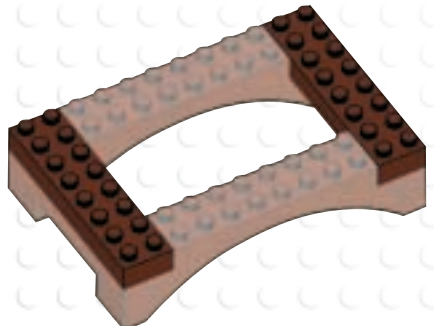
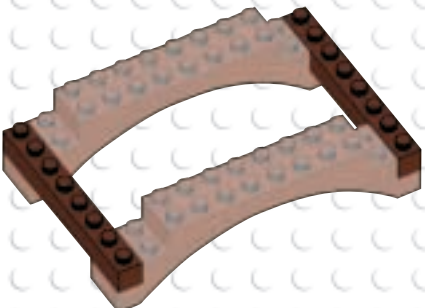

04

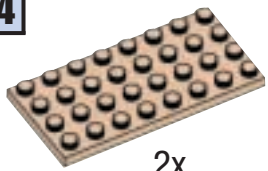

2x

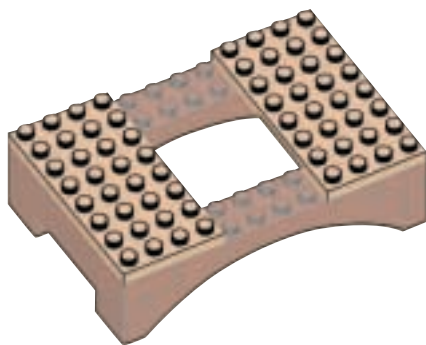

05

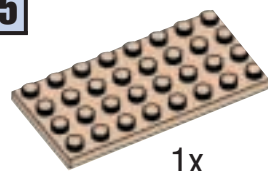

1x



1x

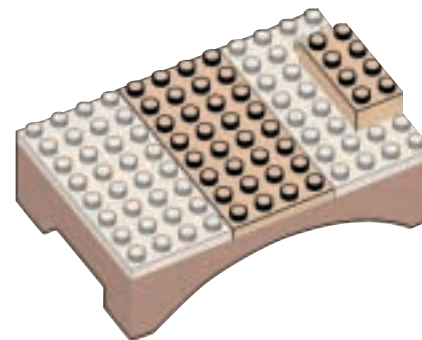

06



1x



4x

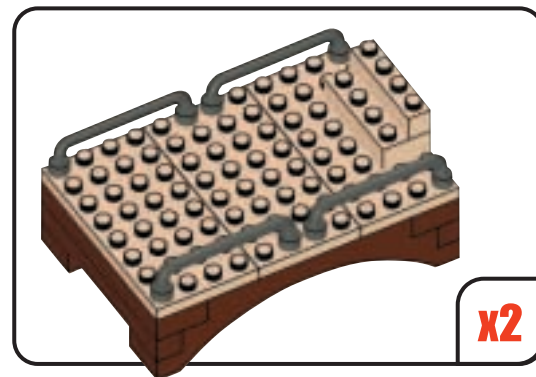

x2

07

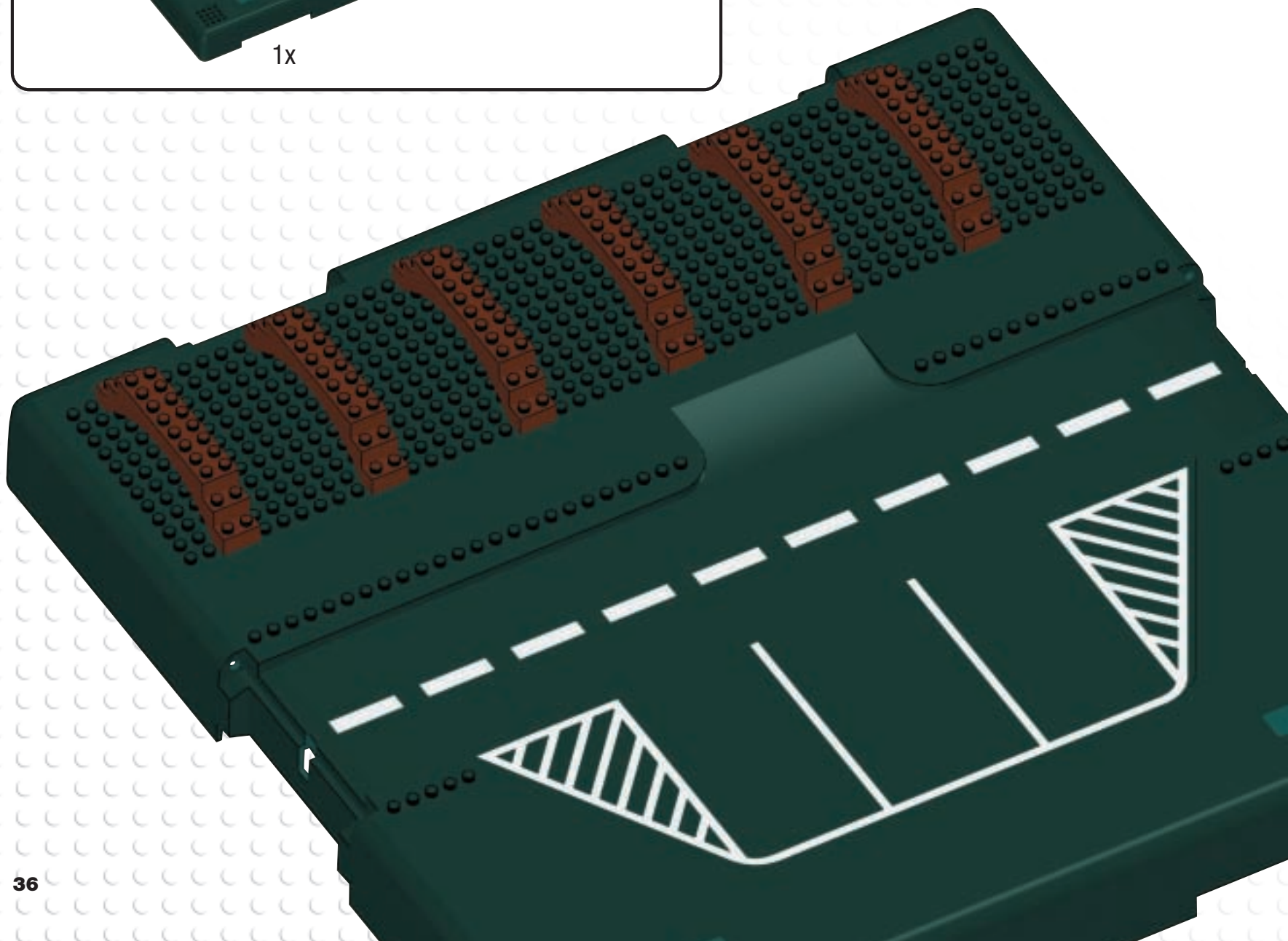
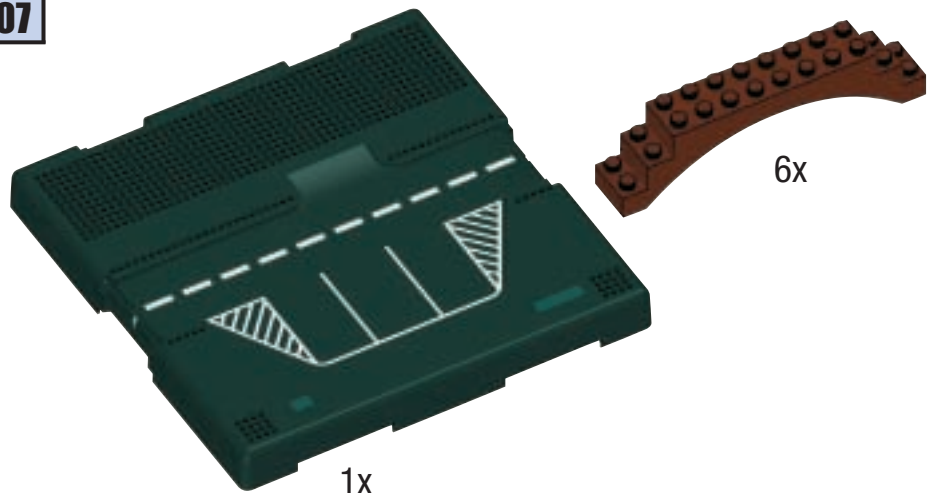

08



10x

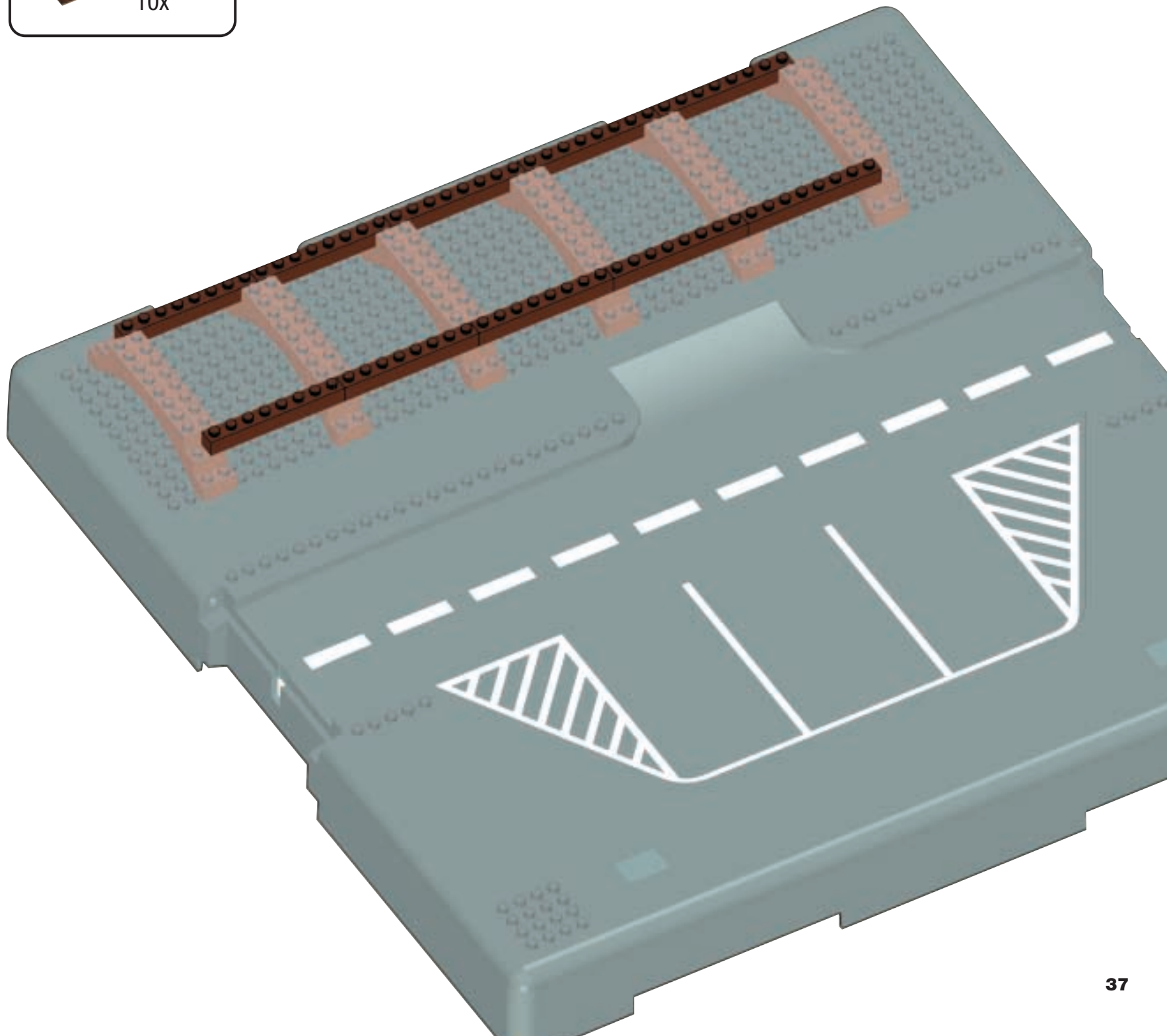

09



4x

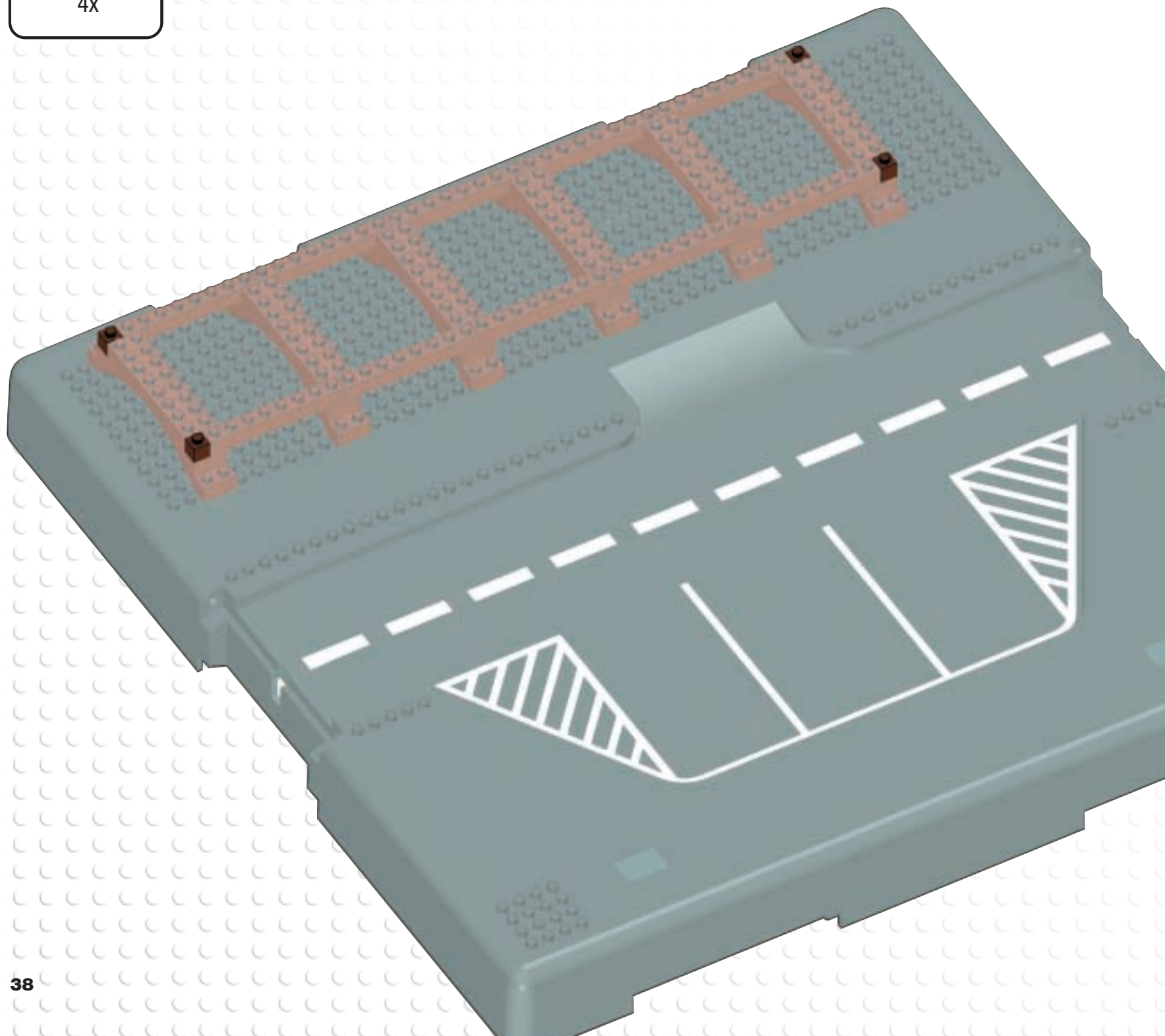

10



24x 12x

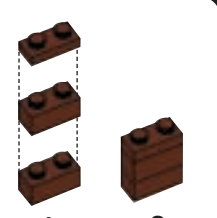

1 2 12x

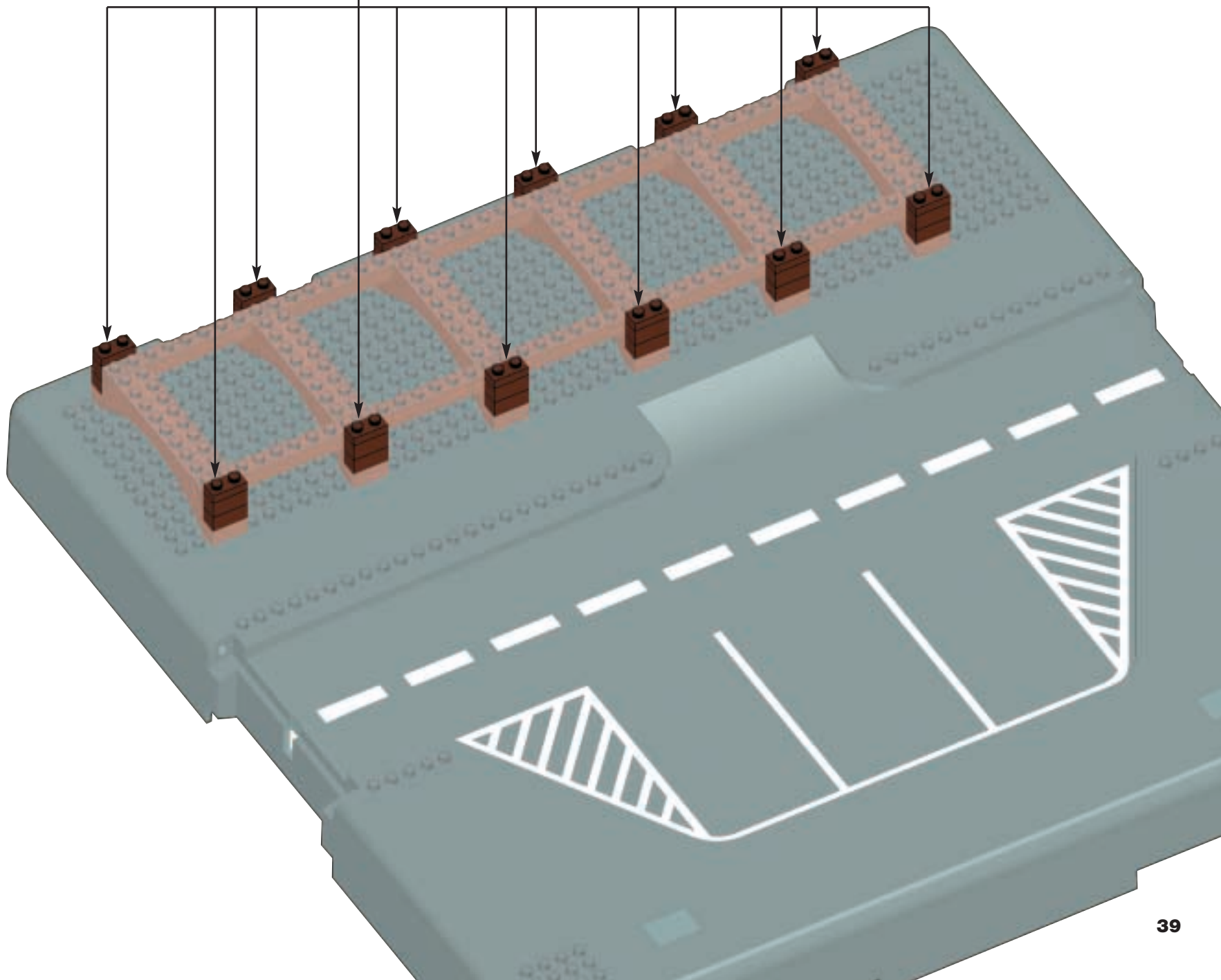

11

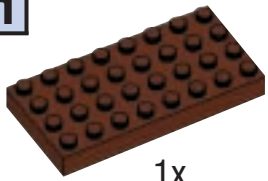

1x

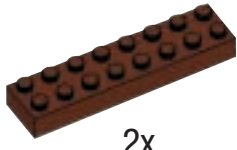

2x

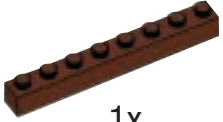

1x



4x



2x



1

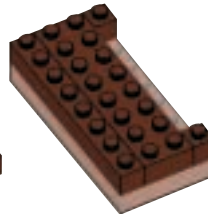

2

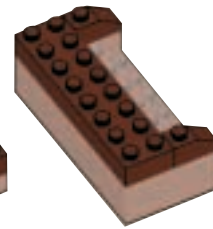

3

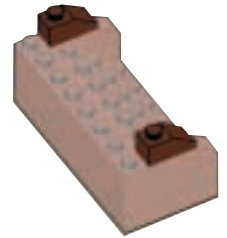

4

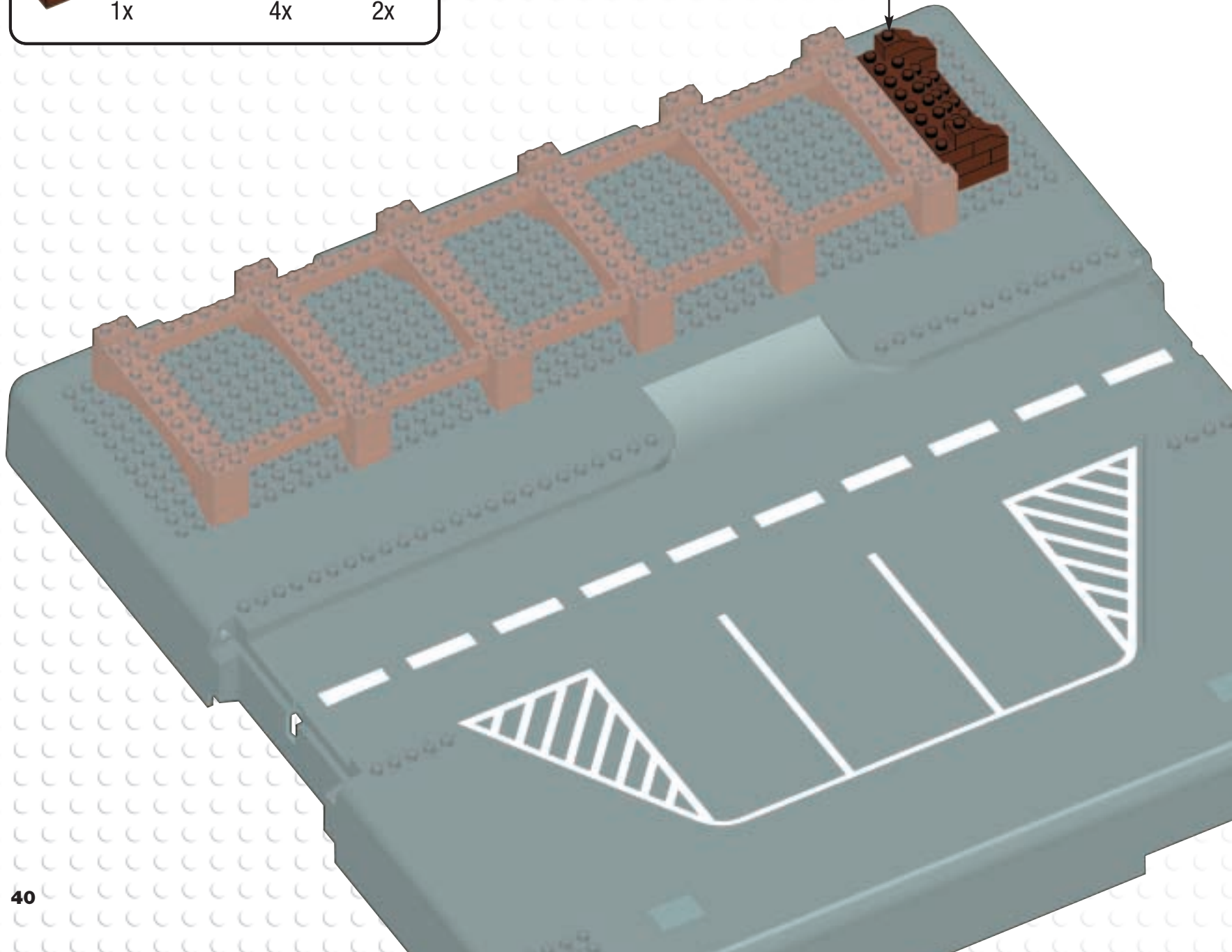

12

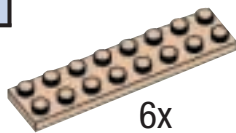

6x



2x

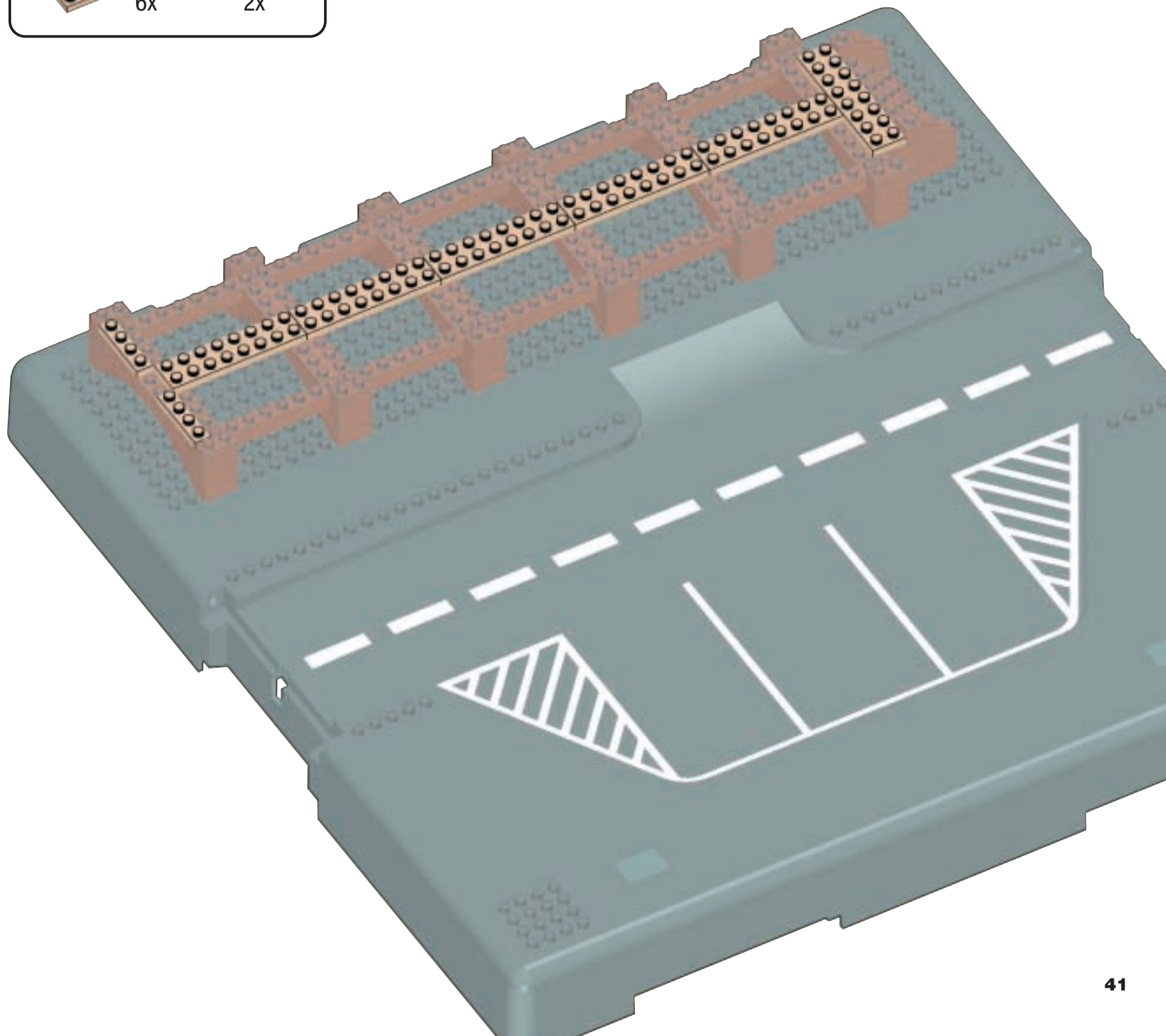

13

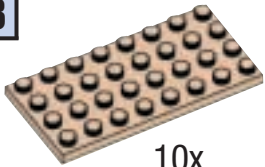

10x



1x



2x



2x

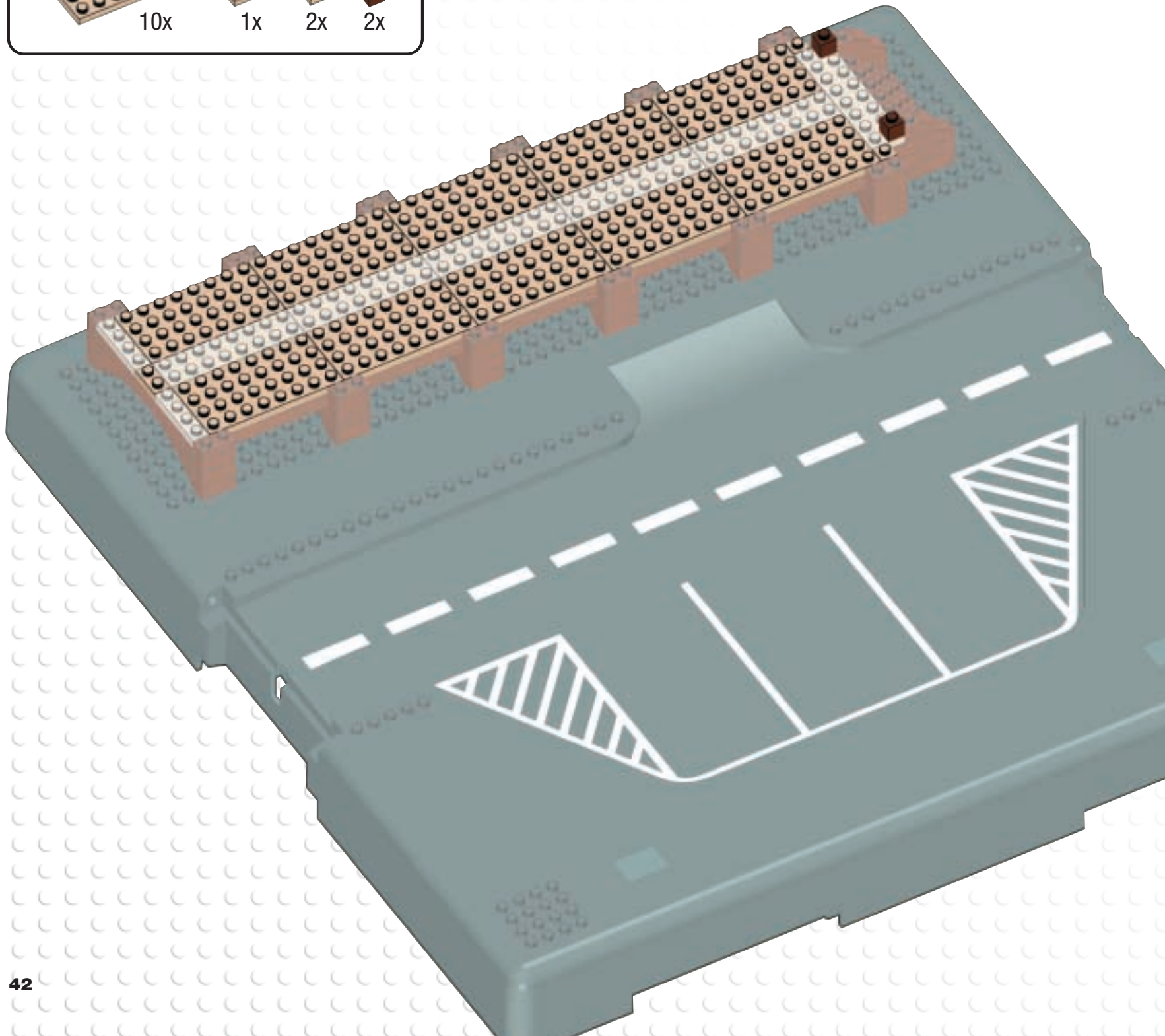

14



12x

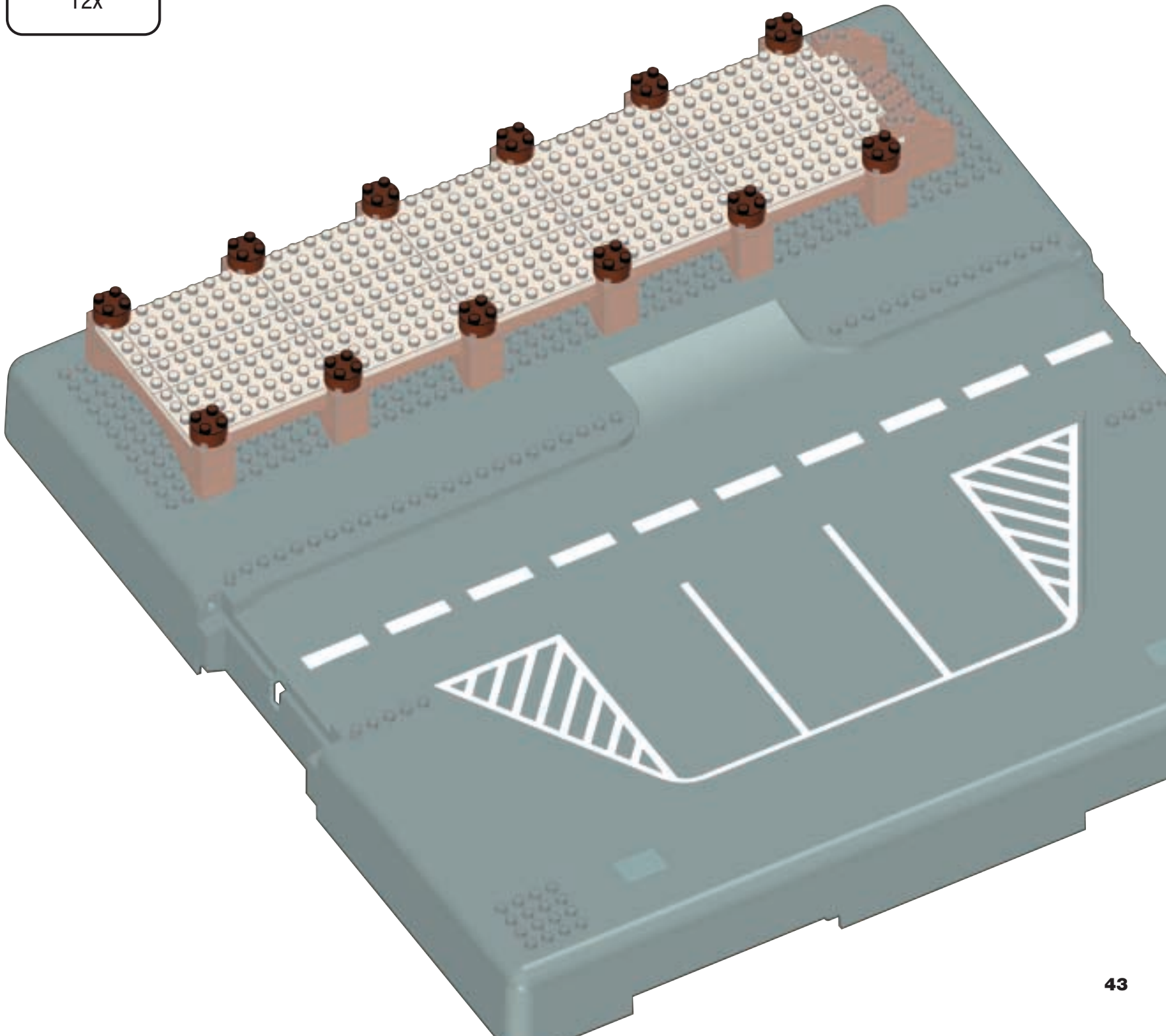

15



6x



10x

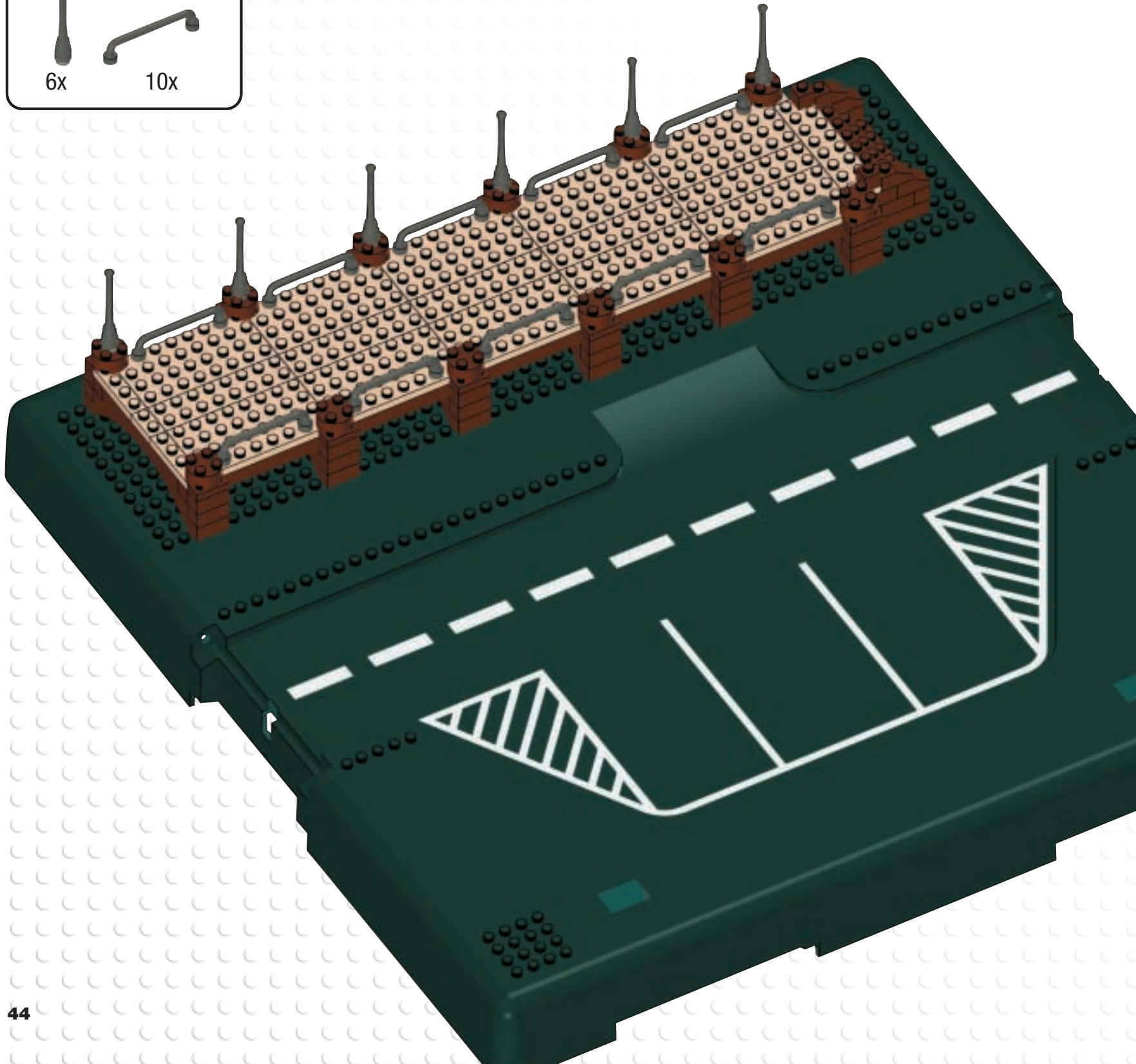

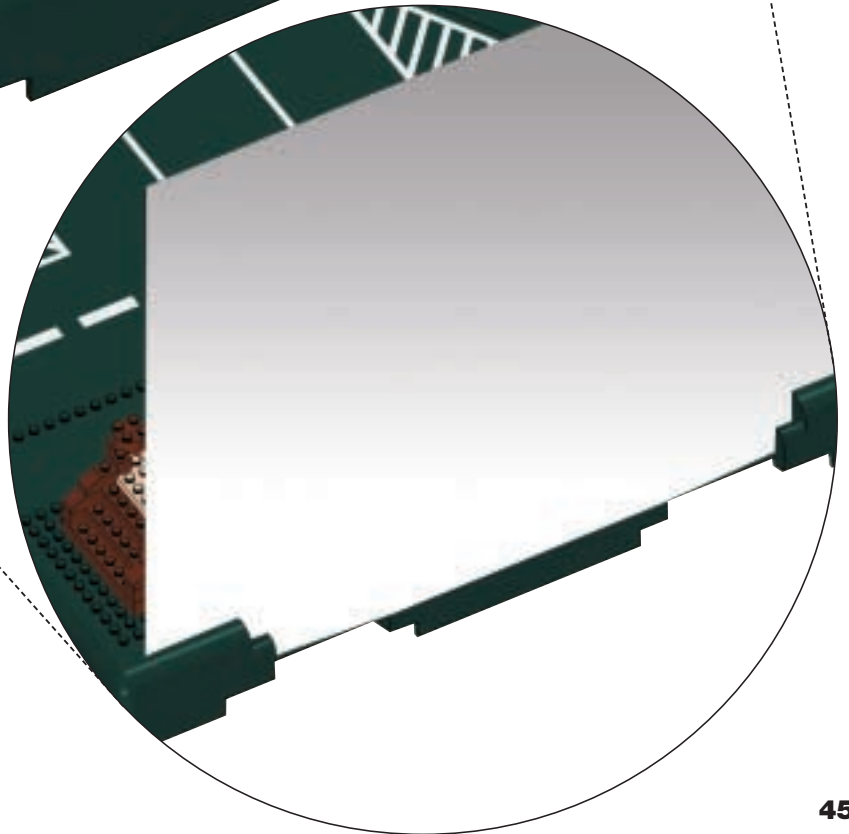
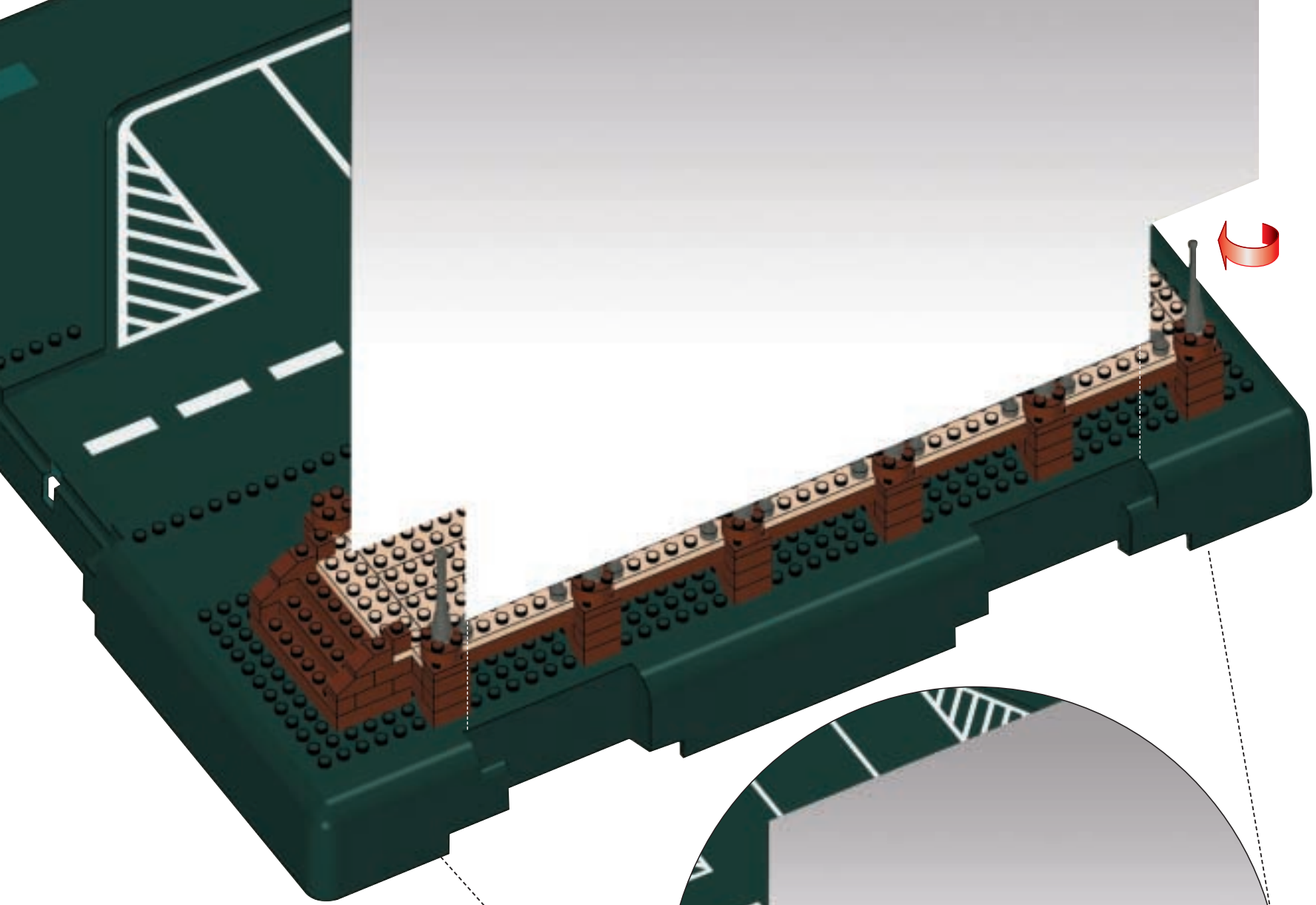

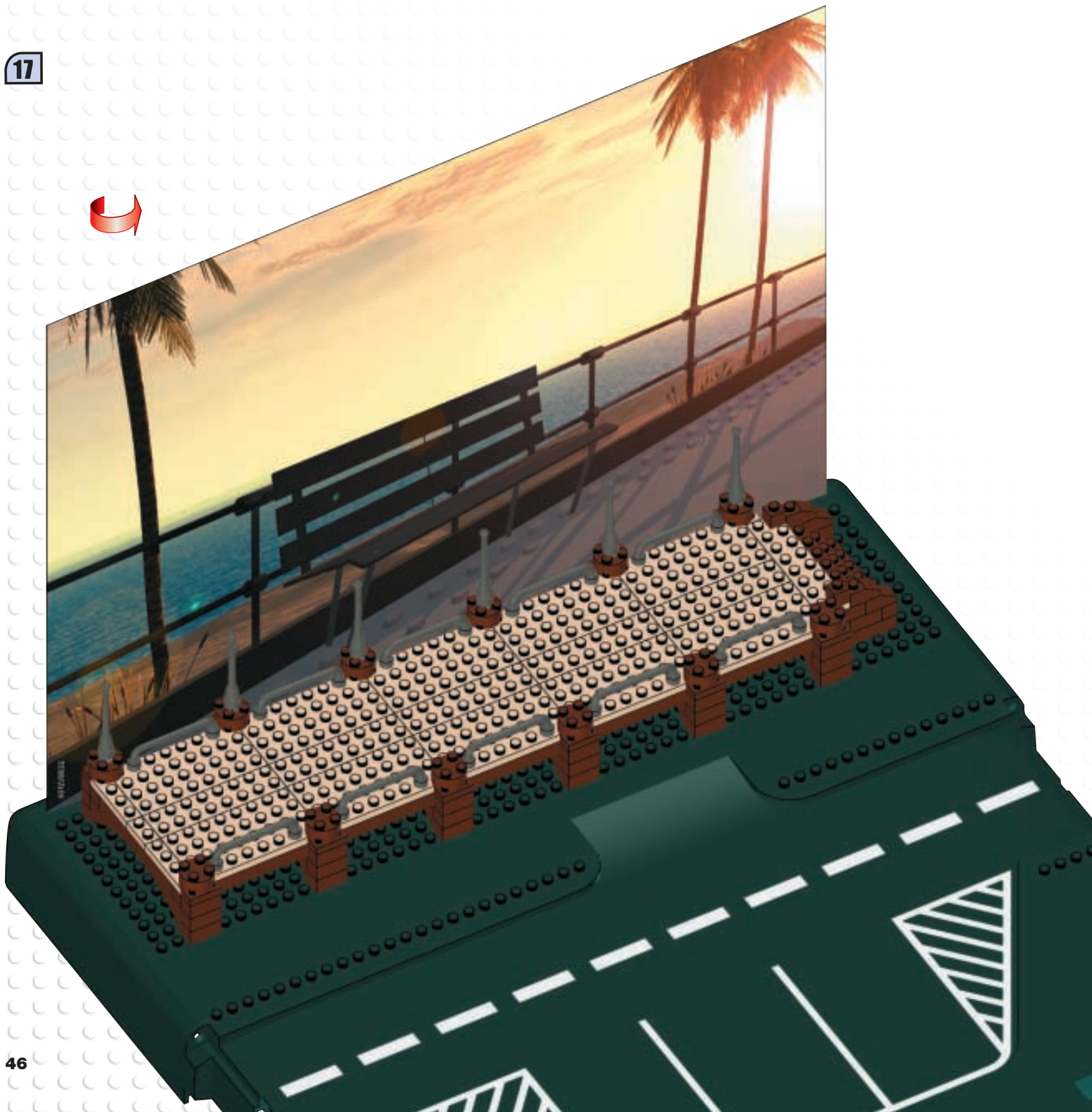

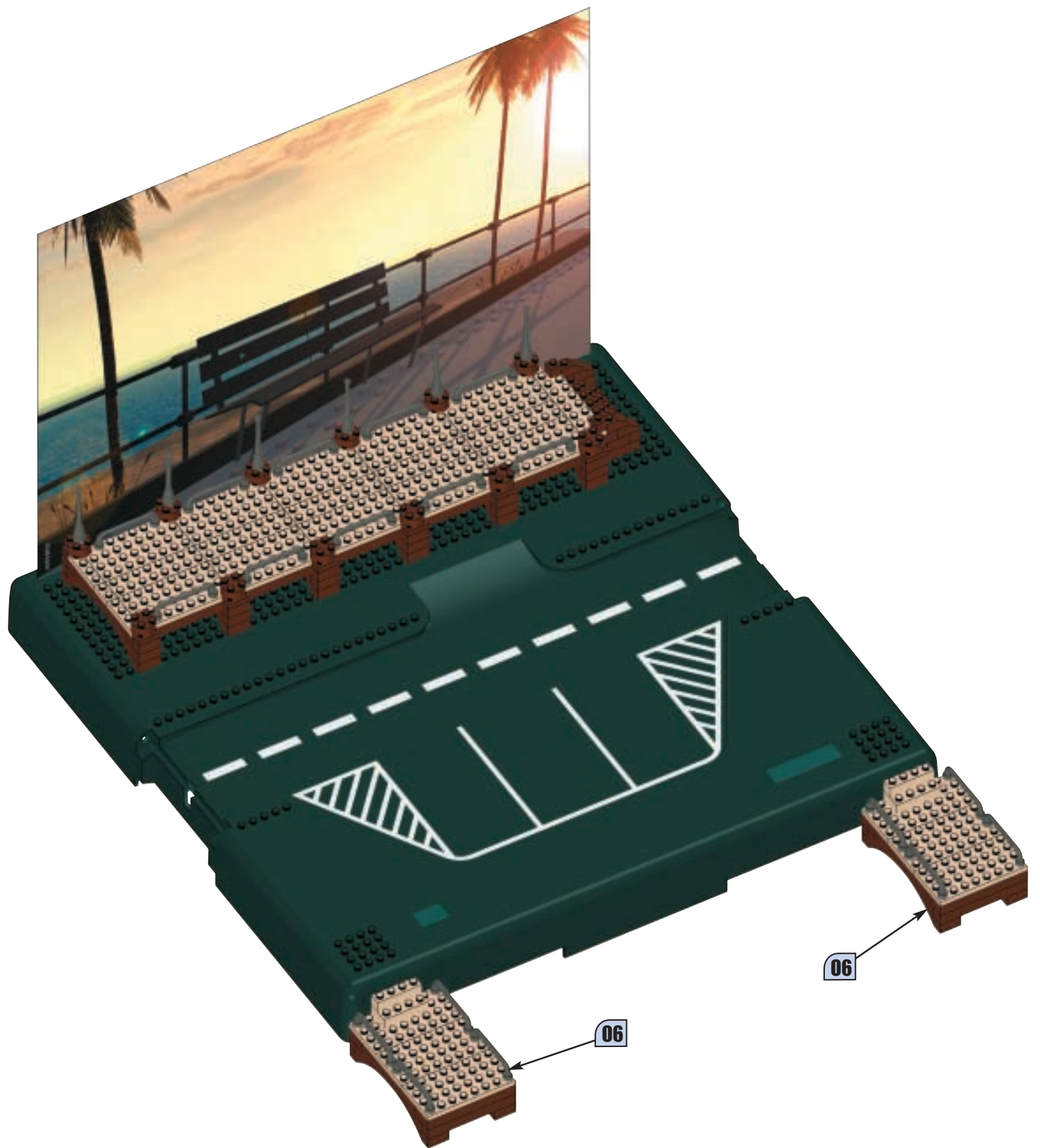

Connect
Empalmar
Relier
Verbinden

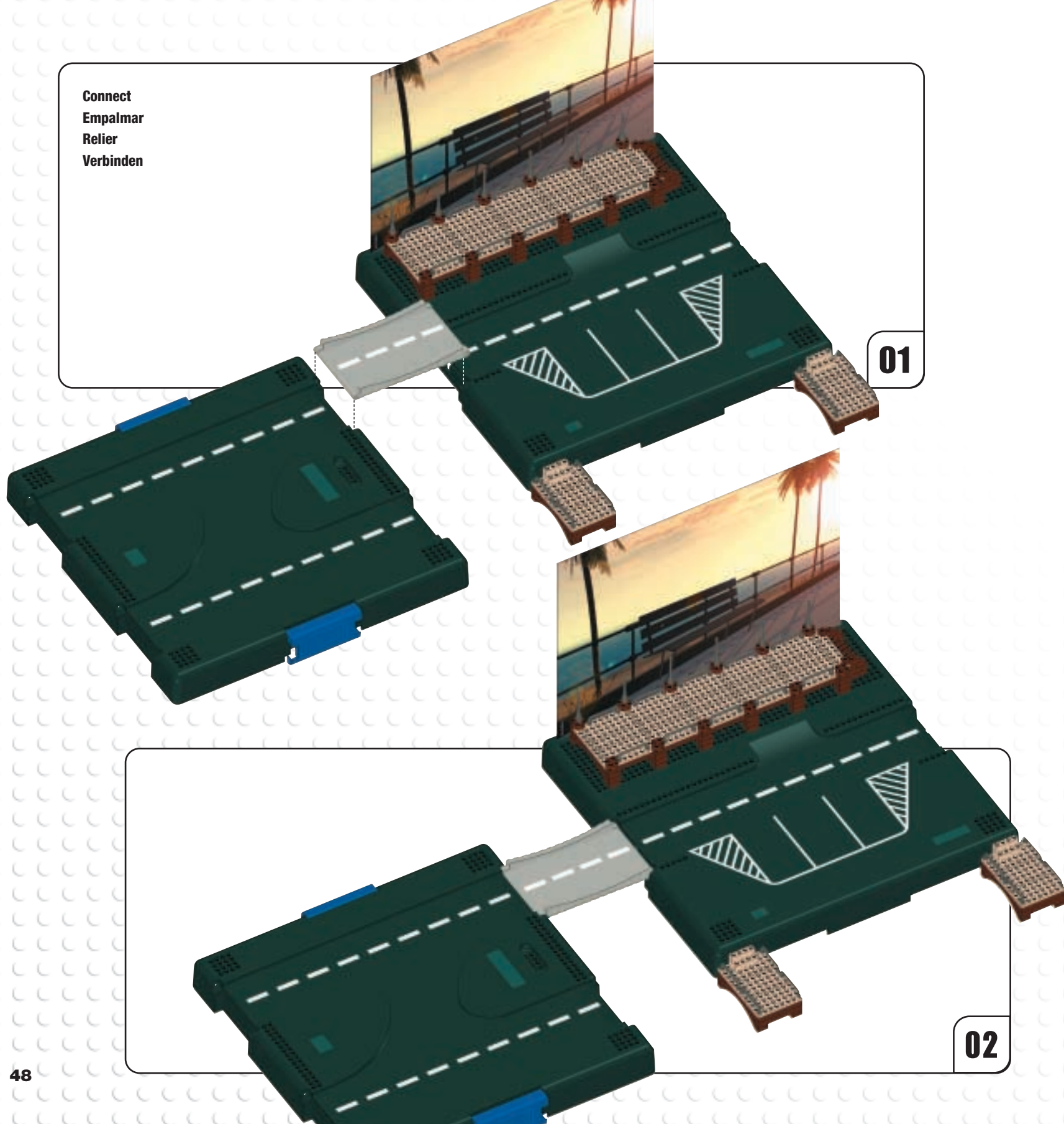

01

02

Canyon Cruiser™



5901

Turbo Rally Racer™



5902

Police Interceptor™



5903

Rebel Roadster™



5904

Off Road Runner™



5905

Sand Storm™



5906

Nano Speed Launcher
Lanzador Relámpago Nano
Lanceur rapide Nano
Nano snellanceerinstallatie

Military Chopper



**Sound / Sonido
Son / Geluid**

5951

Rescue Cutter™



5952

Construction Hauler



5954

Emergency Response™



5981



Lights and sound
Luces y sonido
Son et lumières
Licht en geluid

Off Shore Racing™



5983

5990

Power up launcher
Arranca la lanzadora
Activer le lanceur
Breng de lanceerinrichting op kracht

Stunt ramps
Rampas acrobáticas
Rampes à cascades
Stuntopritten



EN CAUTION:

- Do not leave this toy close to a source of heat or in direct sunlight.
- Do not operate this toy outdoors.
- Operate this toy in a dry area.
- Avoid sand and water. If moisture gets inside the electronic compartment, remove the batteries and allow it to dry thoroughly before using.

ES ADVERTENCIA:

- No exponer este juguete a una fuente de calor ni a los rayos directos del sol.
- No utilizar este juguete en el exterior.
- Utilizar este juguete en un lugar seco.
- Evitar el contacto con agua o arena. Si la humedad penetra en el compartimento eléctrica, retirar las pilas y dejar secar completamente antes de volver a utilizar el juguete.

EN CAUTION: TO AVOID BATTERY LEAKAGE:

- See the diagram to know how to remove and insert batteries.
- Non-rechargeable batteries must never be recharged.
- Rechargeable batteries must be removed from toy before being recharged and rechargeable batteries should be charged under adult supervision.
- Do not mix alkaline, standard (carbon zinc), or rechargeable (nickel cadmium) batteries. Do not mix used and new batteries together.
- Only batteries of the recommended type or of a similar type should be used.
- Batteries must be inserted according to the correct polarity. (see diagram)
- Remove batteries from toy when storing for an extended period of time or if batteries are exhausted.
- The supply terminals must not be short-circuited.

ES ADVERTENCIA: PARA EVITAR QUE LAS PILAS SE SULFATEN:

- Consultar el diagrama para saber cómo retirar e introducir las pilas.
- No recargar jamás pilas que no sean recargables.
- Retirar las pilas recargables del juguete antes de recargarlo; las pilas recargables deben cargarse bajo la supervisión de un adulto.
- No mezclar pilas alcalinas, con pilas standard (carbon zinc) ni tampoco con pilas recargables (níquel cadmio). No mezclar pilas usadas con pilas nuevas.
- Solamente deben utilizarse las pilas del tipo recomendado o de tipo similar.
- Colocar las pilas respetando la polaridad correcta. (ver diagrama)
- Retirar las pilas del juguete cuando vaya a guardarlo durante un periodo largo de tiempo o si las pilas están gastadas.
- No originar cortocircuitos en los bornes del compartimento de las pilas.

EN AVERTISSEMENT: POUR ÉVITER LA FUITE DES PILES:

- Consulter le diagramme pour savoir comment enlever ou mettre en place les piles ou les accumulateurs.
- Ne jamais recharger des piles (non-rechargeables).
- Les accumulateurs doivent être enlevés du jouet avant d'être chargés et les accumulateurs ne doivent être chargés que sous la surveillance d'un adulte.
- Différents types de piles alcalines, standard (carbone zinc) ou d'accumulateurs (nickel cadmium) ne doivent pas être mélangés. Des piles neuves et usagées ou des accumulateurs neufs et usagés ne doivent pas être mélangés.
- Seuls des piles ou des accumulateurs du type recommandé ou d'un type similaire doivent être utilisés.
- Les piles et les accumulateurs doivent être mis en place en respectant la polarité. (voir le diagramme)
- Retirer les piles avant rangement du jouet pour une longue période ou bien si les piles sont usées.
- Les bornes d'une pile ou d'un accumulateur ne doivent pas être mises en court-circuit.

EN 注意：電気洩れを防ぐために：

電池の取外し及び挿入については、ダイアグラムをご覧ください。
非再充電式電池へ充電しないで下さい。
再充電を行なう場合には再充電式電池をおもちゃから取り外し、再充電式電池の取扱いは大人が行なって下さい。
アルカリ、標準(炭素-亜鉛)、あるいは再充電式(ニッケルカドミウム)を混合しないで下さい。古い電池と新しい電池を混合して使用しないで下さい。
推奨タイプ、もしくは同等タイプの電池のみを使用して下さい。
電池は正しい電極に挿入して下さい(ダイアグラムを参照下さい)。
おもちゃを長時間使用しない時には、電池を取り外しておいて下さい、そのままにしておくとも電池が消耗します。
供給ターミナルは短絡してないこと。

EN 警告：避免電池洩漏。

參看附圖，了解如何裝卸電池。
非充電電池不能充電。
充電之前必須先把充電電池從玩具里取出來，充電過程必須由成人監督。
不要把鹼性電池、標準電池(碳化鋅電池)或充電電池(鎳鎘電池)混在一起使用。不要把新舊電池混在一起使用。
只應當使用我們推荐的電池或者類似型號的電池。
電池必須按正確的極性裝入玩具里。(見附圖)
如果一段時間不用玩具，請取出玩具里的電池，否則電池會消耗干。
電源的两極不能短路。

EN ΠΡΟΣΟΧΗ: ΓΙΑ ΤΗΝ ΑΠΟΦΥΓΗ ΔΙΑΡΡΟΗΣ ΤΗΣ ΜΠΑΤΑΡΙΑΣ

- Δείτε το διάγραμμα για να δείτε πως να αφαιρέτε και να τοποθετείτε τις μπαταρίες.
- Δεν πρέπει ποτέ να επαναφορτίσετε τις μη επαναφορτιζόμενες μπαταρίες.
- Θα πρέπει να αφαιρέτε τις επαναφορτιζόμενες μπαταρίες από το παιχνίδι πριν τις επαναφορτίσετε και θα πρέπει να φορτίζετε τις επαναφορτιζόμενες μπαταρίες κάτω από την επίβλεψη ενήλικου.
- Να μην αναμειγνύετε αλκαλικές, κανονικές (άνθρακα - ψευδάργυρου), ή επαναφορτιζόμενες (νικελίου καδμίου) μπαταρίες. Να μην τοποθετείτε καινούργιες και μεταχειρισμένες μπαταρίες μαζί.
- Να χρησιμοποιείτε μόνο μπαταρίες του συνιστούμενου τύπου ή ισοδύναμες.
- Θα πρέπει να εισάγετε τις μπαταρίες σύμφωνα με τη σωστή πολικότητα.
- Να αφαιρέτε τις μπαταρίες από το παιχνίδι όταν το αποθηκεύετε για παρατεταμένο χρονικό διάστημα ή εάν έχουν εξαντληθεί οι μπαταρίες.
- Δεν θα πρέπει να βραχυκυκλώνετε τα τερματικά παροχής.

EN AVERTISSEMENT:

- Ne pas laisser ce jouet près d'une source de chaleur ou directement au soleil.
- Ne pas utiliser ce jouet dehors.
- Utiliser ce jouet dans un endroit sec.
- Ne pas utiliser dans l'eau ni dans le sable. Si l'humidité pénètre dans le compartiment électronique, enlever les piles et laisser sécher complètement avant d'utiliser à nouveau.

EN WAARSCHUWING:

- Stel het speelgoed niet bloot aan een hittebron of aan direct zonlicht.
- Gebruik het speelgoed niet buitenshuis.
- Gebruik het speelgoed op een droge plek.
- Vermijd zand en water. Mocht er toch vocht in het elektronicavak terechtkomen, verwijder de batterijen dan en laat het speelgoed grondig drogen voordat het weer wordt gebruikt.

EN WAARSCHUWING: VOORKOMEN VAN LEKKENDE BATTERIJEN:

- Wijze waarop vervangbare batterijen moeten worden verwijderd en ingelegd (zie afbeelding).
- Niet-oplaadbare batterijen mogen niet worden opgeladen.
- Oplaadbare batterijen dienen vóór het opladen uit het speelgoed te worden verwijderd en alleen onder toezicht van een volwassene te worden opgeladen.
- Gebruik alkalische, standaard- (zinkkoolstof) of oplaadbare (nikkelcadmium) batterijen niet tesamen. Gebruik oude en nieuwe batterijen niet tesamen.
- Uitsluitend batterijen van het aanbevolen type of van een vergelijkbaar type mogen worden gebruikt.
- Batterijen moeten worden ingelegd met inachtneming van de juiste polariteit (zie afbeelding).
- Haal de batterijen uit het speelgoed wanneer het voor een lange periode niet wordt gebruikt of als de batterijen leeg zijn.
- De voedingskleem mag niet worden kortgesloten.

EN WARNING: UM DAS AUSLAUFEN DER BATTERIEN ZU VERMEIDEN:

- Einlegen und Auswechseln der Batterien. (Siehe Abbildung)
- Nichtwiederaufladbare Batterien dürfen nicht wieder aufgeladen werden.
- Wiederaufladbare Batterien müssen zum Aufladen aus dem Spielzeug herausgenommen werden und dürfen nur unter Aufsicht von Erwachsenen aufgeladen werden.
- Alte und neue Batterien nicht zusammen verwenden. Alkalibatterien, Standardbatterien (Kohle-Zink-Batterien), wiederaufladbare Batterien (Nickel-Cadmium) nicht mischen. Nur Batterien derselben Sorte verwenden.
- Nur Batterien der empfohlenen oder ähnlichen Sorte verwenden.
- Batterien gemäß Polarität einlegen. (siehe Abbildung)
- Batterien bei längerer Lagerung, oder wenn sie verbraucht sind, aus dem Spielzeug herausnehmen
- Die Batterieanschlüsse nicht kurzschliessen.

EN ADVARSEL: SÅDAN UDNDGÅS BATTERI-LÆKAGE:

- Se diagrammet om hvordan batterier udtages og indsættes.
- Ikke opladelige batterier må aldrig oplades.
- Opladelige batterier skal tages ud af legetøjet før det oplades, og opladelige batterier skal oplades i tilstedeværelse af en voksen.
- Opladelige (nikkel-kadmium) batterier og alkalisk-, standardbatterier (zink-kul) må ikke blandes. Nye og brugte batterier må ikke bruges sammen.
- Brug kun den foreslåede type batterier eller lignende type.
- Sæt batterier i med polerne vendt den rigtige vej. (se diagram)
- Tag batterierne ud, hvis legetøjet ikke skal bruges i længere tid eller hvis batterierne er udrændte.
- Batteriterminalerne må ikke kortsluttes.

EN VARO: PARISTOJEN VUOTAMISEN ESTÄMINEN:

- Katso kuvasta, kuinka paristat ja asennat paristot.
- Ei-ladattavia paristoja ei koskaan saa ladata.
- Ladattavat paristot on poistettava leikkikalusta ennen niiden lataamista ja lataaminen on tehtävä aikuisen valvonnassa.
- Älä sekoita alkali-, normaali- (hiili-sinkki) tai ladattavia (nikkelikadmium) -paristoja. Älä sekoita käytettyjä ja uusia paristoja keskenään.
- Käytä vain suositeltuja tai samankaltaisia paristoja.
- Paristot on asennettava navat oikein päin. (katso kuvaa)
- Poista paristot leikkikalusta, kun leikkikalua säilytetään pitkään aikaa tai jos paristot ovat lopussa.
- Virtanapoihin ei saa aiheuttaa oikosulkuja.

EN ATTENZION : PER EVITARE PERDITE DALLE PILE

- Osservare il diagramma per capire come togliere ed inserire le pile
- Le pile non ricaricabili non devono mai essere ricaricate.
- Le pile ricaricabili devono essere tolte dal giocattolo prima di essere ricaricate e devono essere ricaricate sotto la supervisione di un adulto.
- Non mescolare pile alcaline, normali (zinco carbonio) o ricaricabili (nickel cadmium). Non mescolare pile usate e nuove.
- Si dovrebbero usare solo pile del tipo raccomandato o di un tipo simile.
- Le pile devono essere inserite secondo la giusta polarità (vedi diagramma).
- Togliere le pile dal giocattolo prima di lunghi periodi di inutilizzazione o se le pile sono scariche.
- I terminali di alimentazione non devono essere corto-circuitati.

EN FORSIKTIG! SLIK UNNGÅR DU BATTERILEKKASJE:

- Illustrasjonen viser hvordan du skal ta ut og sette inn batteriene.
- Batterier som ikke er oppladbare, skal aldri lades opp på nytt.
- Oppladbare batterier må tas ut av leketøyet før de lades opp igjen, og oppladning må skje under oppsyn av en voksen.
- Alkaliske, standard og oppladbare batterier (nikkelkadmium) skal ikke brukes om hverandre. Nye og gamle batterier skal heller ikke brukes sammen.
- Bruk kun batterier av anbefalt type eller en tilsvarende type.
- Batteriene skal settes inn slik at polene vender riktig vei.
- Ta batteriene ut av leketøyet ved lengre tids oppbevaring og når de er oppbrukt.
- De elektriske polene må ikke kortsluttes.

EN ATENÇÃO:PARA EVITAR O ESCORRIMENTO DAS BATERIAS:

- Consulte o diagrama sobre a inserção das baterias.
- As baterias não recarregáveis nunca devem ser recarregadas.
- As baterias recarregáveis devem ser removidas do brinquedo antes de serem recarregadas. O recarregamento de baterias sempre deve ser supervisionado por um adulto.
- Não misture baterias alcalinas normais (zinco de carbono) com recarregáveis (níquel cádmio). Não combine baterias novas com usadas.
- Utilizar só baterias do tipo recomendado ou semelhantes.
- As baterias devem ser inseridas de acordo com a polaridade indicada. (veja o diagrama)
- Remova as baterias do brinquedo ao armazená-lo por um período prolongado ou se as baterias estiverem gastas.
- Os terminais de alimentação não devem ser ligados em curto circuito.

EN VAR FÖRSIKTIG! UNDVIK BATTERILÄCKAGE:

- I diagrammet visas hur batterierna ska bytas ut.
- Ladda aldrig batterier som inte är avsedda för att återladdas.
- Laddningsbara batterier måste avlägsnas från leksaken innan de laddas och laddningsbara batterier måste laddas under övervakning av vuxen.
- Blanda inte alkaliska, standard (kolzink) och laddningsbara (nickelkadmium) batterier. Blanda inte ihop använda och nya batterier.
- Endast batterier av rekommenderad typ eller liknande bör användas.
- Batterier måste föras in med polerna i rätt läge. (se diagrammet)
- Avlägsna batterierna från leksaken när den ska förvaras under längre tid eller om batterierna är urladdade.
- Strömtillförselterminalerna måste kortslutas.

IF YOU HAVE A PROBLEM, PLEASE DO NOT TAKE THIS TOY BACK TO THE STORE. CONTACT US
 EN CASO DE PROBLEMAS, NO DEVUELVA EL PRODUCTO A LA TIENDA DONDE LO COMPRÓ. CONTÁCTENOS
 VOUS AVEZ DES PROBLÈMES? ON VOUS PRIERAIT DE NE PAS RETOURNER CE JOUET AU MAGASIN. CONTACTEZ-NOUS
 HEEFT U PROBLEEMEN? BRENG HET SPEELGOED DAN NIET TERUG NAAR DE WINKEL. NEEM CONTACT MET ONS OP

1-800-465-MEGA
 U.S. & Canada only / Solamente en EEUU y Canadá
 É.U. et Canada seulement / Uitsluitend in de V.S. en Canada
WWW.MEGABLOKS.COM

TROUBLE SHOOTER GUIDE / PROBLEMAS Y SOLUCIONES / GUIDE DE DÉPANNAGE / GIDS VOOR PROBLEEMOPLOSSINGEN

Problem	Possible cause	Try this solution
<ul style="list-style-type: none"> • Weak and distorted sound. • Weak light intensity 	<ul style="list-style-type: none"> • Weak batteries 	<ul style="list-style-type: none"> • Replace batteries
<ul style="list-style-type: none"> • No power 	<ul style="list-style-type: none"> • Incorrect Battery placement. • Dirty battery contacts • Dead batteries 	<ul style="list-style-type: none"> • Remove batteries and install according to diagram • Clean terminals • Replace batteries

Problema	Causas posibles	Intente lo siguiente
<ul style="list-style-type: none"> • Sonido débil y deforme. • Baja intensidad luminosa 	<ul style="list-style-type: none"> • Pilas agotadas. 	<ul style="list-style-type: none"> • Reemplacer las pilas
<ul style="list-style-type: none"> • Sin carga 	<ul style="list-style-type: none"> • Pilas mal instaladas • Contactos de pila sucios • Pilas agotadas 	<ul style="list-style-type: none"> • Sacar las pilas y ponerlas según esquema • Limpiar los bornes. • Reemplacer las pilas

Problème	Causes possibles	Essayez cette solution
<ul style="list-style-type: none"> • Le son est sourd et déformé. • L'intensité des lumières est faible. 	<ul style="list-style-type: none"> • Les piles sont faibles. 	<ul style="list-style-type: none"> • Remplacer les piles.
<ul style="list-style-type: none"> • Il n'y a pas de courant. 	<ul style="list-style-type: none"> • Les piles sont mal positionnées. • Les bornes des piles sont sales. • Les piles sont mortes. 	<ul style="list-style-type: none"> • Retirer les piles et insérer-les selon le schéma. • Nettoyer les bornes des piles. • Remplacer les piles.

Problem	Mögliche Lösung	Mögliche Lösung
<ul style="list-style-type: none"> • Het geluid is zwak en vervormd. • Zwakke lichtsterkte 	<ul style="list-style-type: none"> • Zwakke batterijen. 	<ul style="list-style-type: none"> • Batterijen vervangen
<ul style="list-style-type: none"> • Geen energie 	<ul style="list-style-type: none"> • Verkeerde plaatsing van batterijen • Vuile batterijcontacten • Lege batterijen 	<ul style="list-style-type: none"> • Neem batterijen uit en installeer ze volgens het diagram • Maak de polen schoon. • Batterijen vervangen

CAUTION: Batteries are to be changed by an adult. Do not leave batteries within reach of children.
ADVERTENCIA: Las pilas debe cambiarlas un adulto. No dejar las pilas al alcance de los niños.
ATTENTION : Le changement de piles doit être réalisé par un adulte. Ne pas laisser les piles à la portée des enfants.
OPGEPAST: De batterijen moeten door een volwassene worden vervangen.

Non-rechargeable batteries included.
Incluye pilas no recargables.
Piles fournies non-rechargeables.
Niet-oplaadbare batterijen meegeleverd.

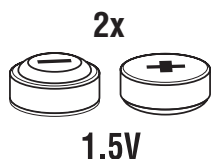

This toy uses 2 alkaline button cell batteries (SR41, 392, 1134SO or equivalent)
 Este juguete utiliza 2 pilas alcalinas de célula de botón (SR41, 392, 1134SO o equivalente)
 Ce jouet nécessite 2 piles boutons alcalines (SR41, 392, 1134SO ou l'équivalent)
 Dit speelgoed gebruikt 2 alkaline knoopcelbatterijen (SR41, 392, 1134SO of gelijkwaardig)

EN BATTERY INSTALLATION

- Use a phillips (star-bit) screwdriver to unscrew the door of the battery compartment.
- Lift and remove the compartment door.
- Insert the 1.5 volt batteries according to the correct polarity shown.
- Replace the door and the screws, do not over-tighten the screws.

ES INSTALACIÓN DE LAS PILAS

- Utilizar un destornillador en cruz (o con punta de estrella) para abrir la tapa del compartimiento de las pilas.
- Levantar y retirar la tapa del compartimiento de las pilas.
- Introducir las pilas de 1.5 voltios según la polaridad indicada.
- Reponer la puerta y los tornillos, evitando apretarlos demasiado.

EN CAUTION! Do not aim at eyes or face.

ES ¡ADVERTENCIA! NO dirigir nunca los proyectiles hacia los ojos o la cara.

FR ATTENTION! Ne pas viser les yeux ou le visage.

NL LET OP: Niet op ogen of gezicht richten.

DE VORSICHT! Nicht auf das Gesicht oder die Augen richten.

DA ADVARSEL! Peg ikke i retning af øjne eller ansigt.

EL ΠΡΟΣΟΧΗ! Να μην σκοπεύετε προς τα μάτια ή το πρόσωπο.

FI VARO! Älä tähtää silmiin tai kasvoihin.

IT Attenzione! Non puntare verso gli occhi o il viso.

NO FORSIKTIG! Sikt ikke mot øyne eller ansikt.

PT ATENÇÃO: Não apontar para os olhos ou o rosto.

SV VAR FÖRSIKTIG! Rikta inte med ögon eller ansikte.

JA 警告! 不要对准眼睛或脸。

ZH 注意! 目や顔に使用しないで下さい。

FR MISE EN PLACE DES PILES

- Avec un tournevis cruciforme, dévisser la porte du compartiment à piles.
- Soulever et ouvrir la porte du compartiment.
- Insérez les piles de 1.5 volts comme indiqué par les pôles + et -.
- Remettre en place la porte et les vis, sans trop les serrer.

NL INLEGGEN VAN DE BATTERIJEN

- Gebruik een kruiskopschroevendraaier om het klepje van het batterijenvak los te schroeven.
- Licht het klepje op en verwijder het.
- Steek de batterijen van 1.5 volt in met inachtneming van de juiste polariteit.
- Plaats het paneel en de schroeven terug en draai niet te vast aan.

EN ⚠ WARNING :
 CHOKING HAZARD. - Small parts.
 Not for children under 3 years.

ES ⚠ ADVERTENCIA :
 PELIGRO DE ASFIXIA. - Contiene piezas pequeñas.
 No recomendado para niños menores de 3 años.

FR ⚠ AVERTISSEMENT :
 RISQUE DE SUFFOCATION. - Présence de petits éléments.
 Ne convient pas aux enfants de moins de 3 ans.

NL ⚠ WAARSCHUWING:
 VERSTIKKINGSGEVAAR. - Bevat kleine onderdelen.
 Niet geschikt voor kinderen onder de 3 jaar.

DE ⚠ WARNUNG:
 ERSTICKUNGSGEFAHR. - Enthält kleine Teile.
 Nicht für Kinder unter 3 Jahren geeignet.

DA ⚠ ADVARSEL:
 KVÆLNINGSFARE. - Indeholder smådele.
 Ikke til børn under 3 år.

EL ⚠ ΠΡΟΕΙΔΟΠΟΙΗΣΗ:
 ΚΙΝΔΥΝΟΣ ΠΝΙΞΙΜΑΤΟΣ. - Περιέχει μικρά αντικείμενα.
 Όχι για παιδιά κάτω των 3 ετών.

FI ⚠ VAROITUS:
 TUKEHTUMISVAARA. - Sisältää pieniä osia.
 Ei alle 3-vuotiaille lapsille.

IT ⚠ ATTENZIONE:
 PERICOLO DI SOFFOCAMENTO. - Contiene piccole parti.
 Non indicato per bambini sotto i 3 anni.

NO ⚠ ADVARSEL:
 KVELNINGSFARE. - Inneholder små deler.
 Kun for barn over 3 år.

PT ⚠ ATENÇÃO:
 PERIGO DE ASFIXIA. - Contém peças pequenas.
 Não é concebido para crianças de menos de 3 anos.

SV ⚠ VARNING!
 KVÄVNINGSRISK. - Innehåller små delar.
 Inte för barn under 3 år.

JA ⚠ 警告:
 窒息の危険性 小さな部品が含まれています
 3歳以下の子供には与えないで下さい。

ZH ⚠ 警告:
 有窒息危險。包含有小部件
 不适合3岁以下的小孩玩。

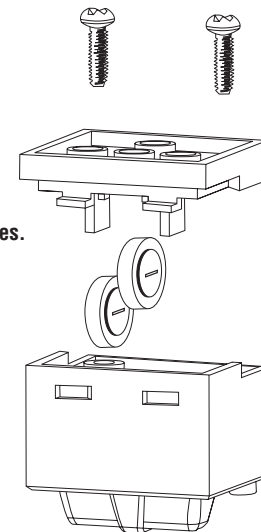

LIFETIME GUARANTEE*
GARANTIZADO DE POR VIDA*
GARANTIE À VIE*
LEVENSLANGE GARANTIE*

COMMENTS, QUESTIONS ? / ¿ COMENTARIOS, PREGUNTAS ?
 COMMENTAIRES, QUESTIONS ? / COMMENTAAR, VRAGEN ?

1-800-486-MEGA

U.S. & Canada only / Solamente en EEUU y Canadá
 É.U. et Canada seulement / Uitsluitend in de V.S. en Canada

www.megabloks.com

*Guarantee on blocks only.

*La garantía se aplica únicamente a los bloques.

*Garantie applicable sur les blocs seulement.

*Garantie geldt uitsluitend voor blokken.

5983 Off Shore Racing™



**MEGA
BLOKS**

© 2004, MEGA BLOKS INC.
® and ™ denote trademarks of MEGA BLOKS INC.
® y ™ designan la marca registrada y la marca comercial de MEGA BLOKS INC.
® et ™ désignent des marques de commerce de MEGA BLOKS INC.
® en ™ duiden op handelsmerken van MEGA BLOKS INC.

PRINTED IN CHINA AD059831