

# DRAGONS UNIVERSE™



95207 | Rapid Fire Dragon Fighter • Dragón Luchador de Fuego Rápido • Vaisseau combattant de dragons • Drachenjäger-Kampfjet mit Schnellfeuerkanone • Snelvurend Draak gevechtsvliegtuig • Dragone d'attacco a fuoco rapido • Nave de combate Dragon de disparo rápido

**MEGA  
BLOKS®**



10x AM01113AAV  
 2x AM01855B  
 1x AM01793F  
 2x AM17115AAV  
 4x AM01312AGV  
 6x AM07629MM  
 16x AM04428MM  
 4x AM09198MM  
 8x AM09393MM  
 4x AM16649AGV  
 2x AM01748AGV  
 4x MA11101MM  
 2x AM03019MM  
 4x AM09013MM  
 12x AM04429MM

1x AM09268MM  
 2x MA1146MM  
 4x AM03773MM  
 1x AM03773E  
 4x AM09106MM  
 7x AM01154MM  
 2x AM10273MM  
 2x AM01139MM  
 2x AS9520601  
 1x AM17275MM  
 2x AM17240MM  
 3x AM16764AAV

4x AM09493MM  
 2x AM15492MM  
 4x AM09593MM  
 1x AM15479MM  
 1x AM15478MM  
 1x AM09033MM  
 1x AM01313MM  
 2x AM01480MM  
 2x AS9520724  
 1x AM04984MM  
 2x AM08483MM

1x AM17242AAV  
 2x AX9520601AAV  
 1x AM16630E  
 1x AM16629E  
 1x AS9520728  
 1x AS9520727  
 1x AS9520707  
 1x AS9520725  
 2x AM16767AGV

2x AS9520729  
 1x AM17106MM  
 1x AS9520720  
 1x AS9520730  
 1x AS9520721  
 1x AS9520722

1x AS9520702  
 1x AS9520704  
 1x AS9520703  
 1x AS9520705  
 1x AS9520706  
 1x AS9520701  
 1x AS9520708  
 1x AM16769AGV

1x AS9520709  
 1x AS9520716  
 1x AS9520712  
 1x AS9520711  
 1x AS9520713  
 1x AS9520714  
 1x AS9520715  
 1x AS9520710  
 1x AM16835AGV

EN Please read these instructions carefully before first use and keep them for future reference. / ES Leer estas instrucciones cuidadosamente antes de la primera utilización y guardarlas para referencia futura. / FR Il est recommandé de lire attentivement ce feuillet avant la première utilisation et de le conserver pour référence future. / DE Die Gebrauchsanleitung bitte durchlesen und aufbewahren. / NL Wij raden u aan deze handleiding zorgvuldig te lezen en te bewaren voor eventuele raadpleging op een later tijdstip. / IT Leggere le istruzioni prima di cominciare ad usare il gioco e conservarle per referenze future. / PT Leia as instruções antes do primeiro uso e guarde-as para futura referência.

EN ⚠️ WARNING:  
 CHOKING HAZARD. - Small parts.  
 Not for children under 3 years.

ES ⚠️ ADVERTENCIA:  
 PELIGRO DE ASFIXIA. - Contiene piezas pequeñas.  
 No recomendado para niños menores de 3 años.

FR ⚠️ AVERTISSEMENT:  
 RISQUE DE SUFFOCATION. - Présence de petits éléments.  
 Ne convient pas aux enfants de moins de 3 ans.

DE ⚠️ WARNUNG:  
 ERSTICKUNGSGEFAHR. - Enthält kleine Teile.  
 Nicht für Kinder unter 3 Jahren geeignet.

NL ⚠️ WAARSCHUWING:  
 VERSTIKKINGSGEVAAR. - Bevat kleine onderdelen.  
 Niet geschikt voor kinderen onder de 3 jaar.

DA ⚠️ ADVARSEL:  
 KVELNINGSFARE. - Indeholder smådele.  
 Ikke til børn under 3 år.

EL ⚠️ ΠΡΟΕΙΔΟΠΟΙΗΣΗ:  
 ΚΙΝΔΥΝΟΣ ΠΝΙΓΙΜΑΤΟΣ. - Περιέχει μικρά αντικείμενα.  
 Όχι για παιδιά κάτω των 3 ετών.

FI ⚠️ VAROITUS:  
 TUKEHTUMISVAARA. - Sisältää pieniä osia.  
 Ei alle 3-vuotiaille lapsille.

IT ⚠️ ATTENZIONE:  
 PERICOLO DI SOFFOCAMENTO. - Contiene piccole parti.  
 Non indicato per bambini sotto i 3 anni.

NO ⚠️ ADVARSEL:  
 KVELNINGSFARE. - Inneholder små deler.  
 Kun for barn over 3 år.

PT ⚠️ ATENÇÃO:  
 PERIGO DE ASFIXIA. - Contém peças pequenas.  
 Não é concebido para crianças de menos de 3 anos.

SV ⚠️ VARNING:  
 KVÄVNINGSRISK. - Innehåller små delar.  
 Inte för barn under 3 år.

JA ⚠️ 警告:  
 窒息の危険性 - 小さな部品が含まれています  
 3歳以下の子供には与えないで下さい。

ZH ⚠️ 警告:  
 有窒息危險 - 包含有小部件  
 不适合3岁以下的孩兒玩。

AR ⚠️ تحذير:  
 خطر اختناق - قطع صغيرة.  
 غير صالحة للأطفال أقل من 3 سنوات.



**BLADEWING™**



1



2



3

**DECIMUS™**



1



2



1



2



OR • O • OU  
ODER • OF





**1**

x4

x1

x1

**2**

x2

x3

x2

x1

x2

1

2

1

2

3

x2

3

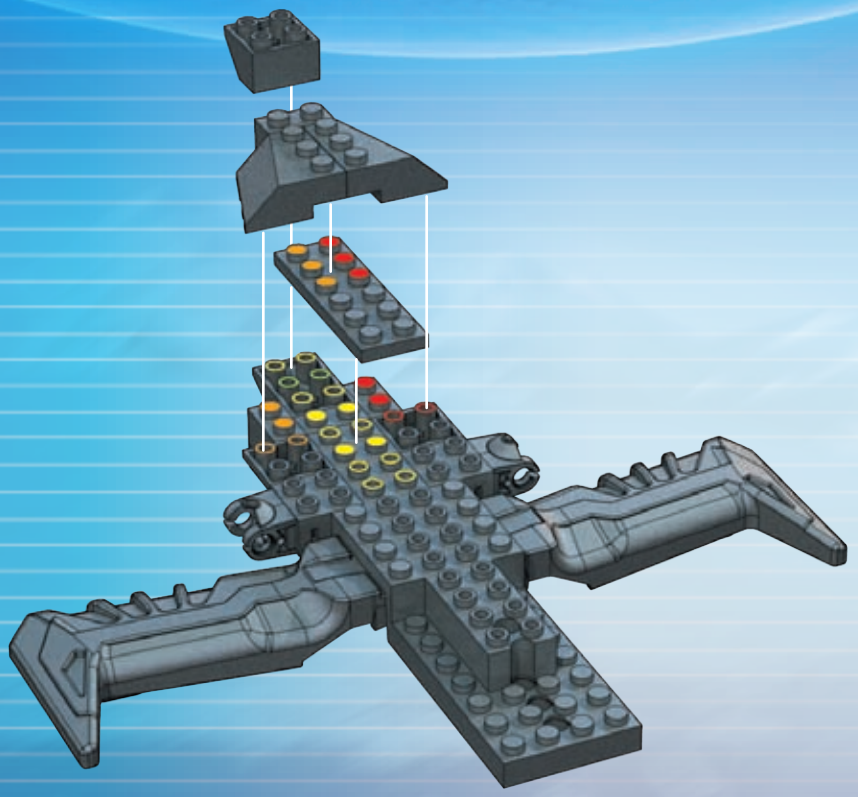
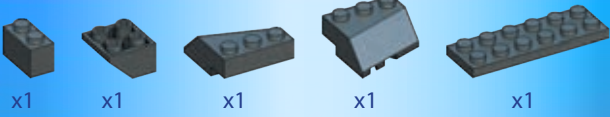

4

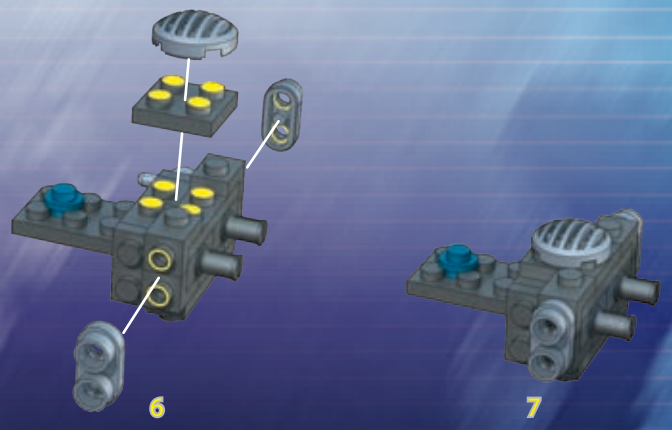
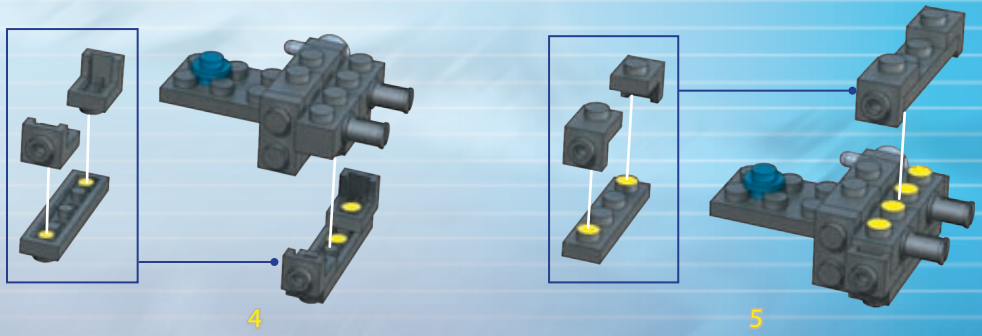
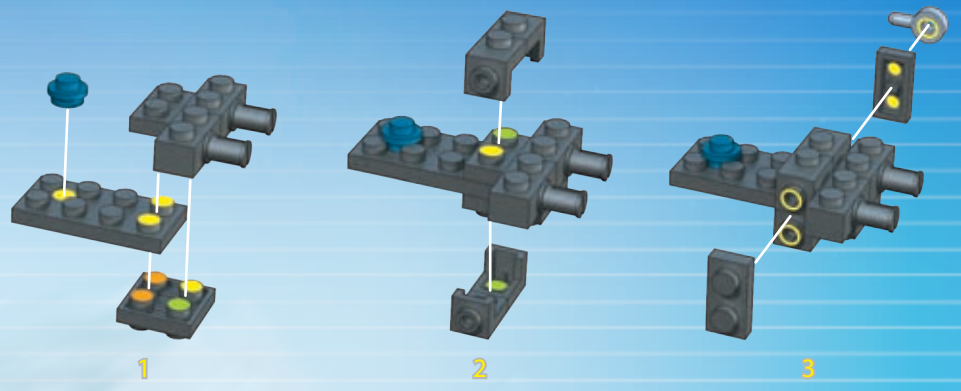
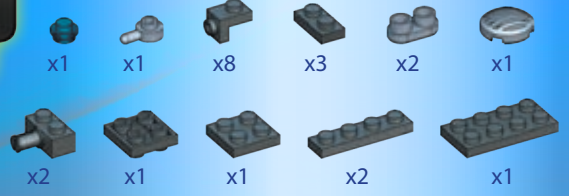



**5**

x1	x1	x8	x3	x2	x1
x2	x1	x1	x2	x1	

1

2

3

4

5

6

7

**6**

x1	x1
x1	

4

2

3

**7**

x1	x1
x1	

1

2

5

3

**8**

x2 x4



**9**

x1 x1 x1

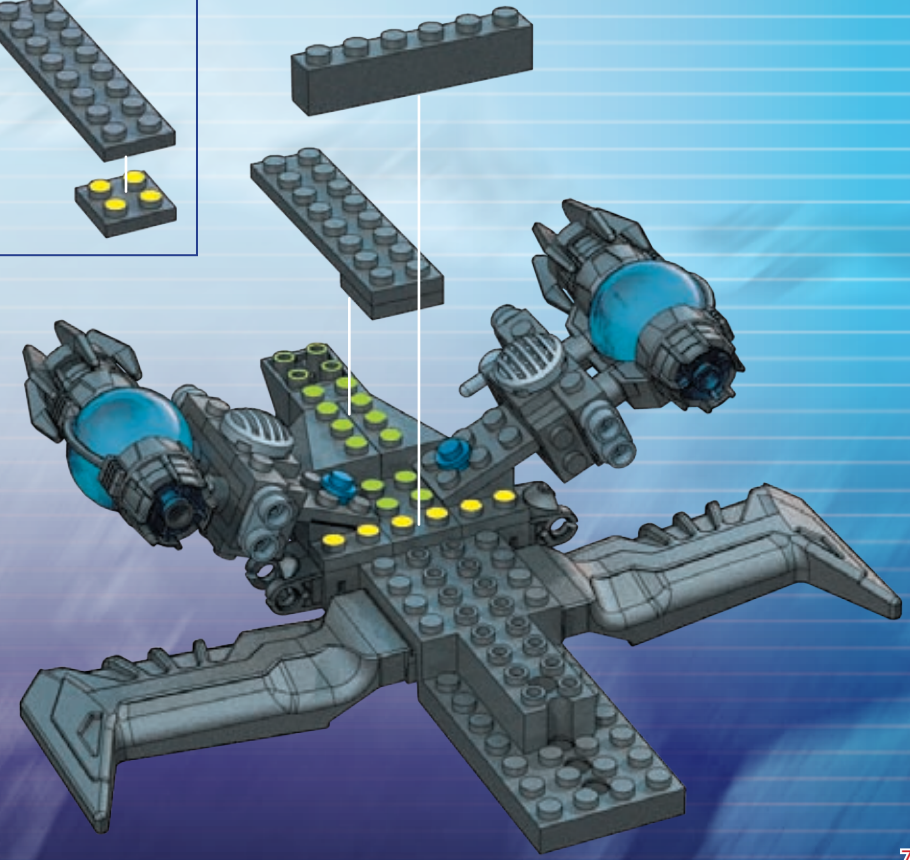
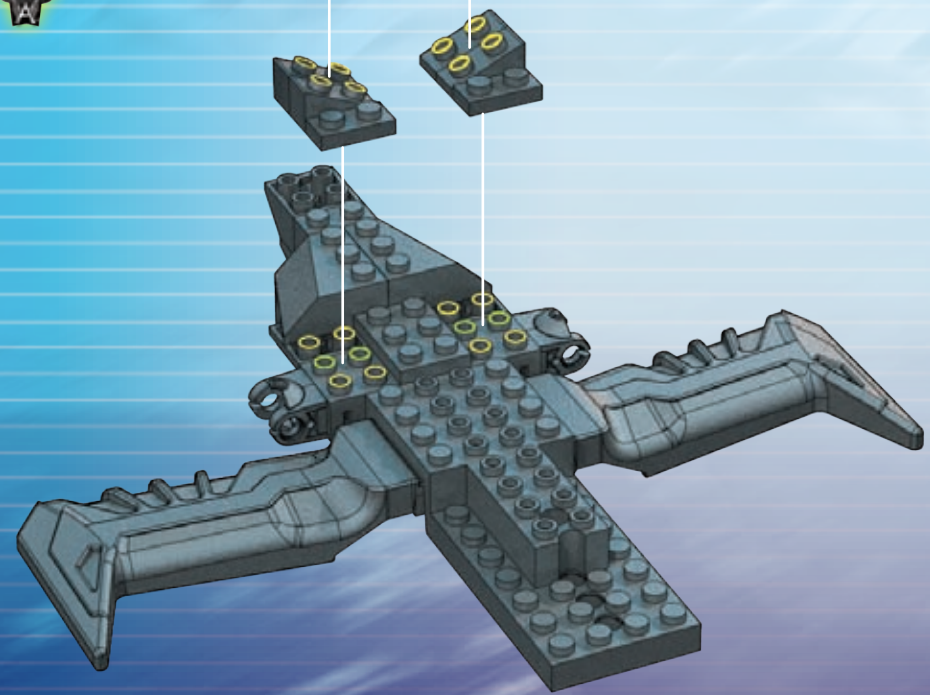



10

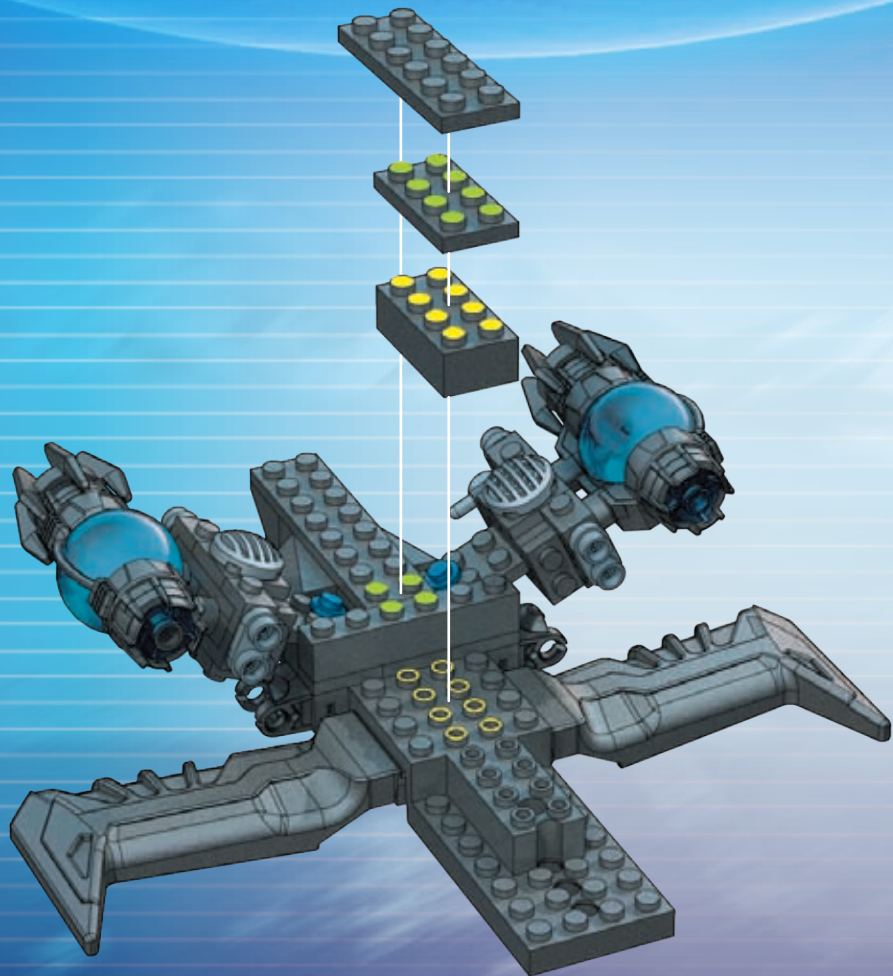

11

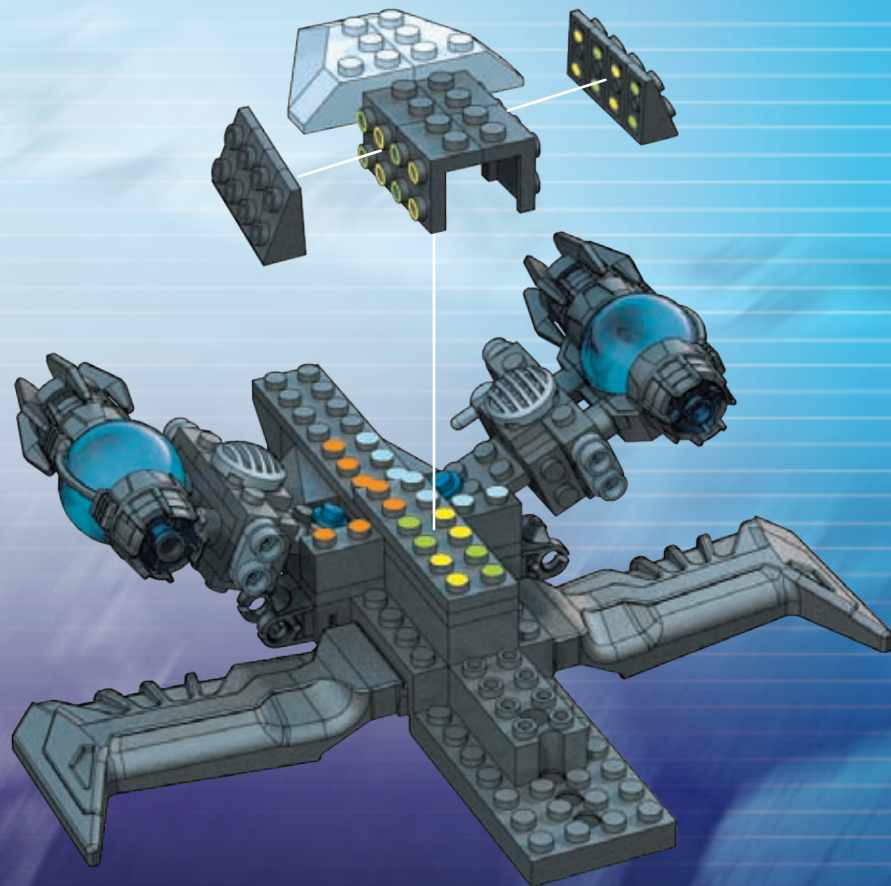



12

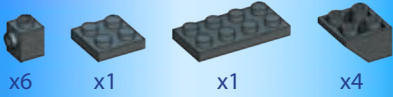

x6 x1 x1 x4

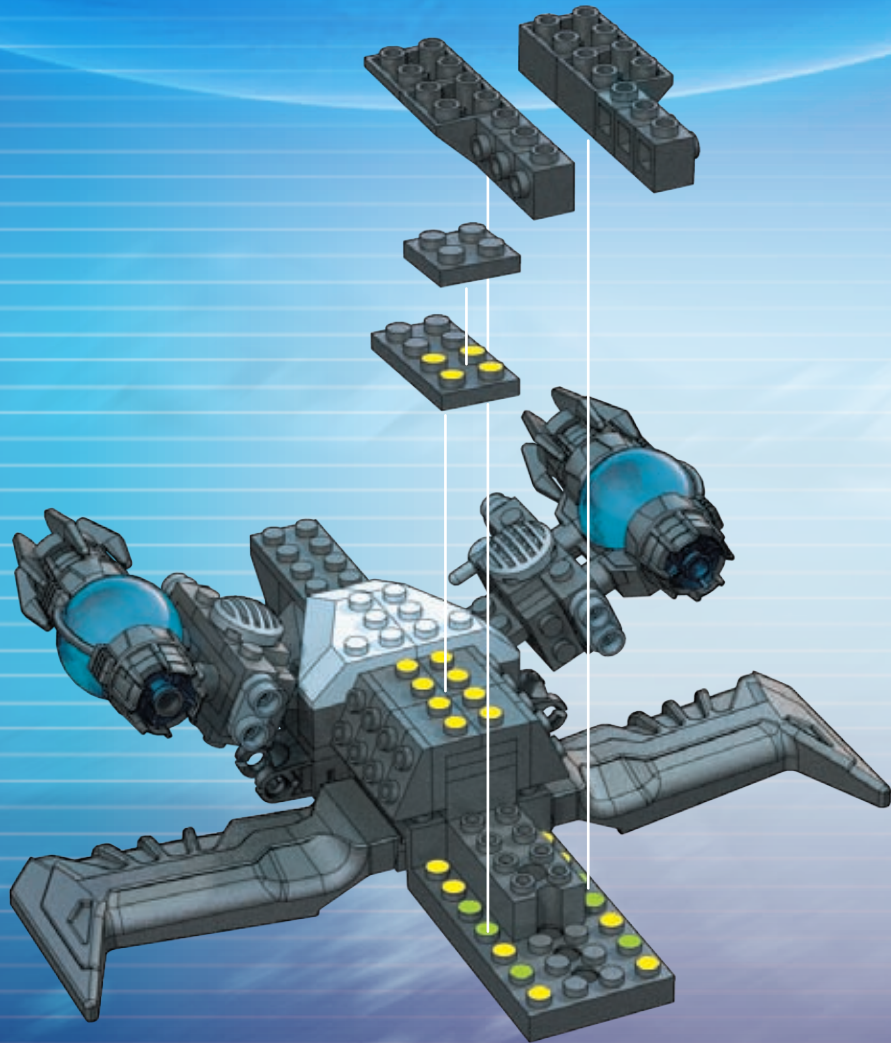

13



x2 x2 x1



x1



x1

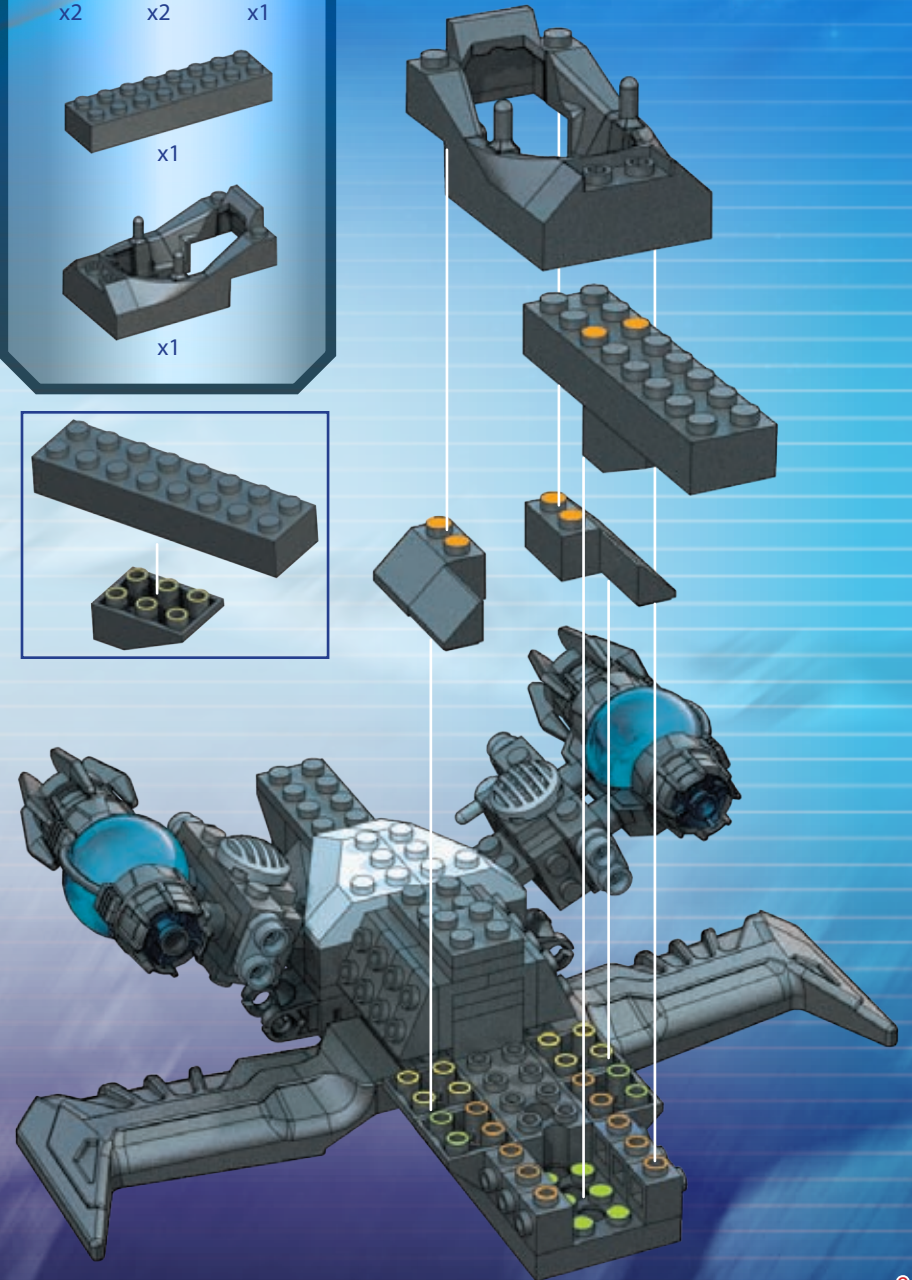
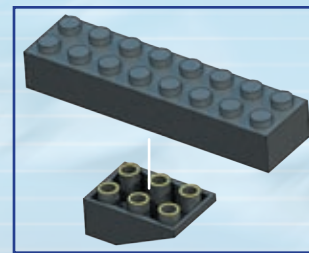



14



15

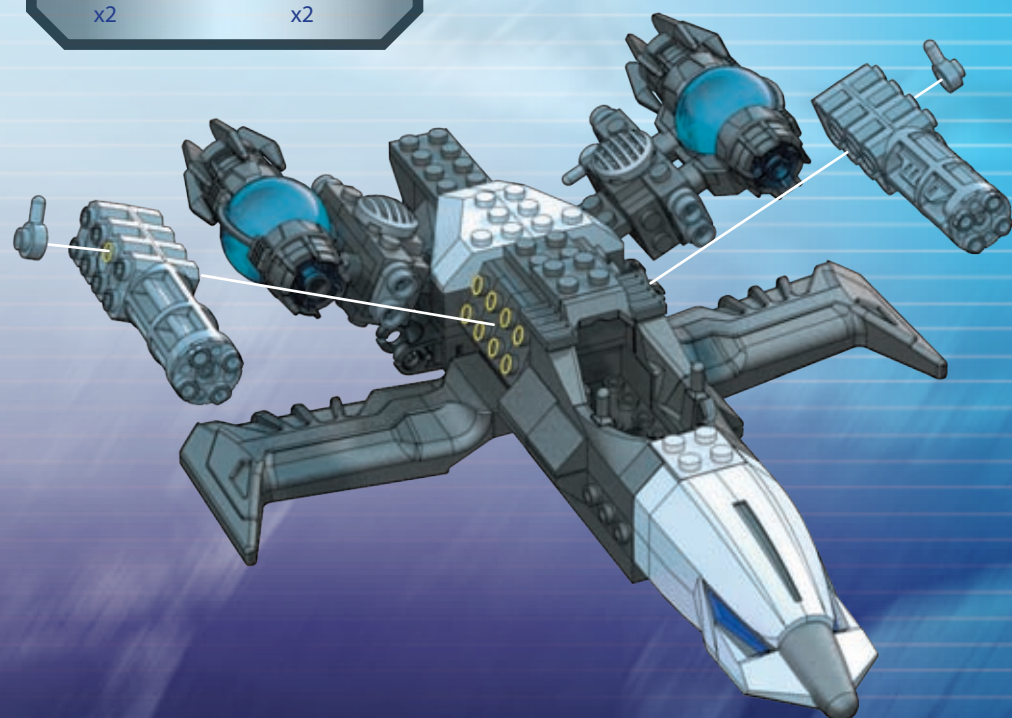
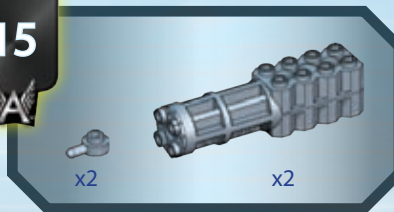



16

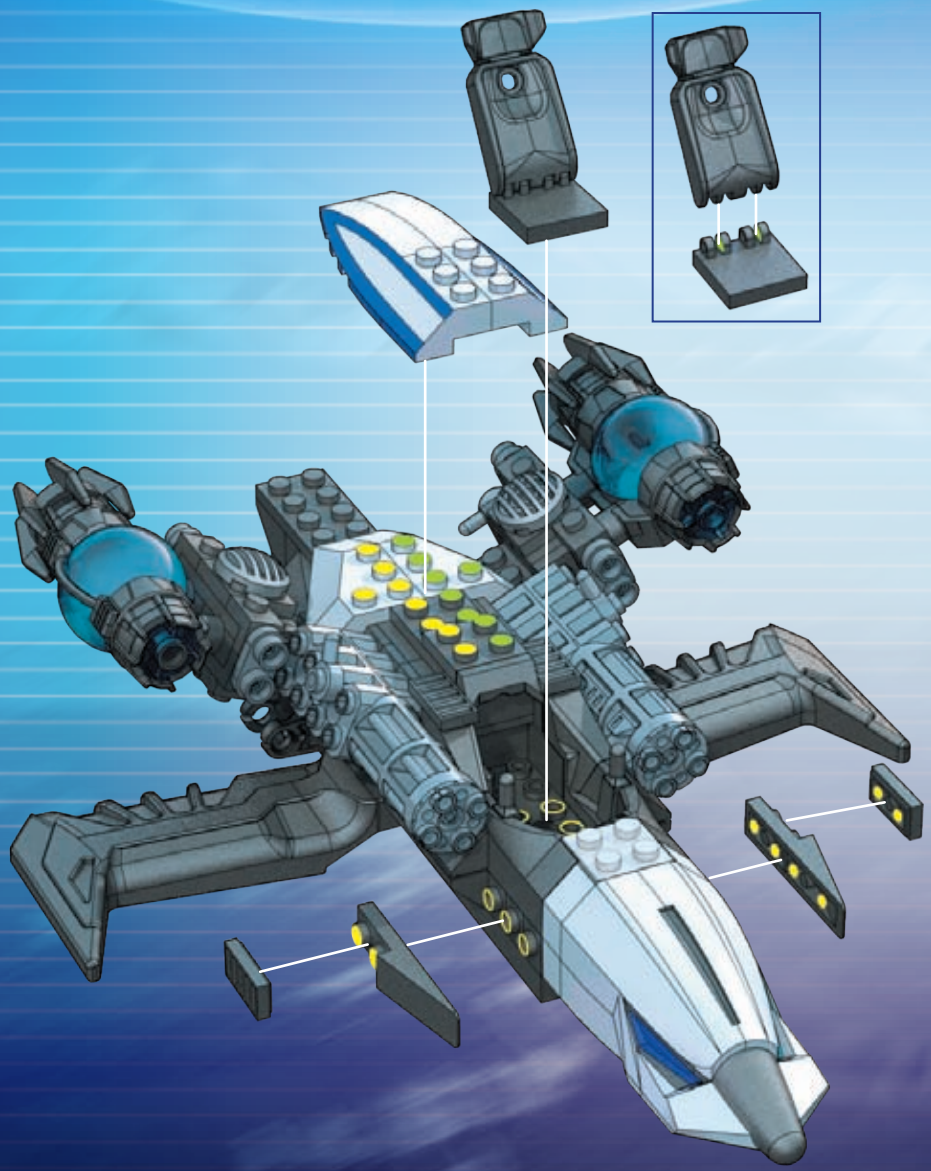

17

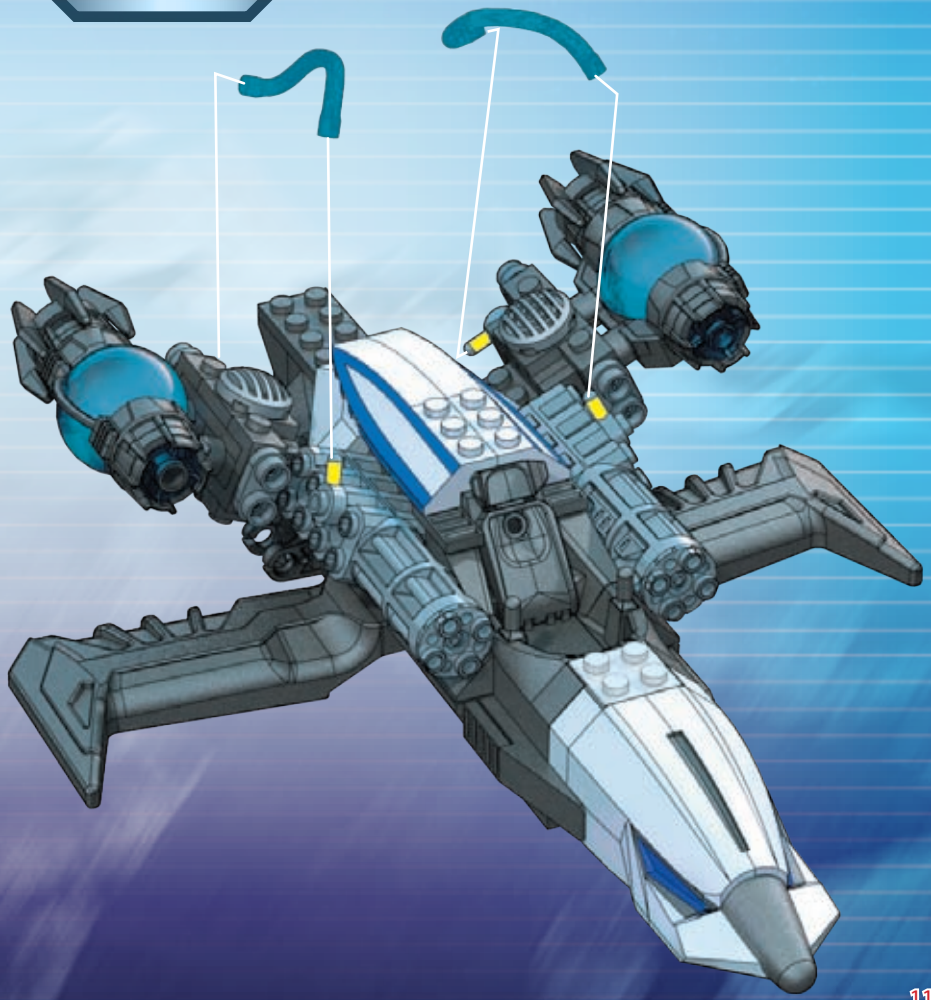



18

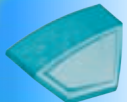

x1



x1

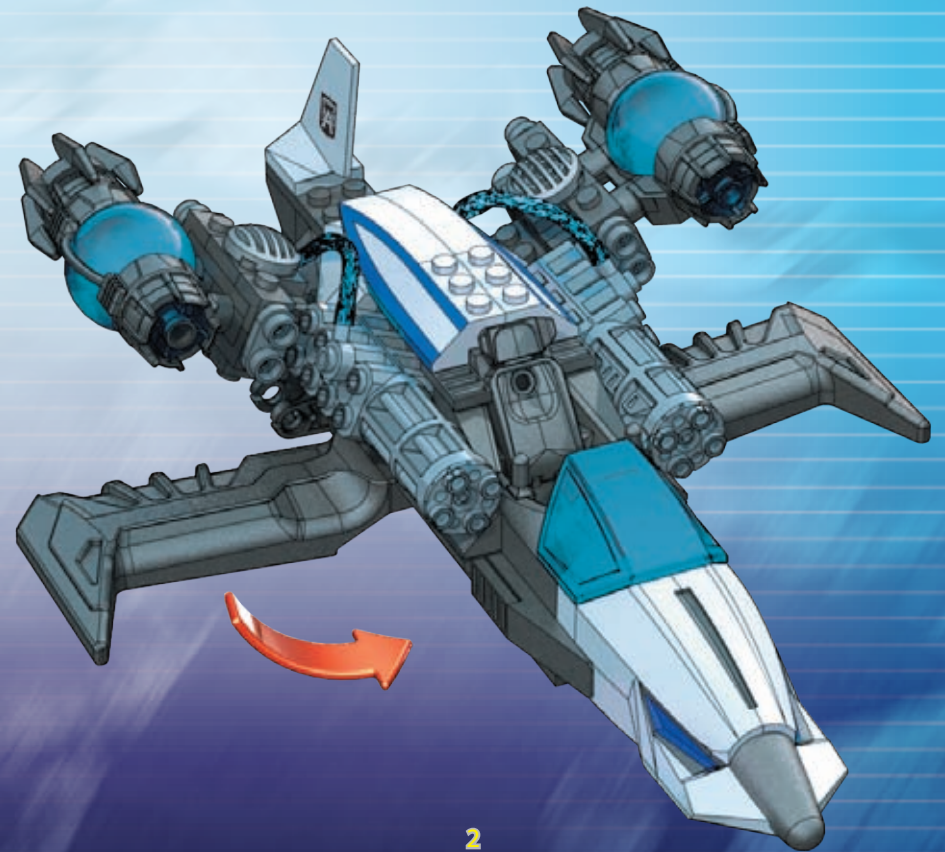
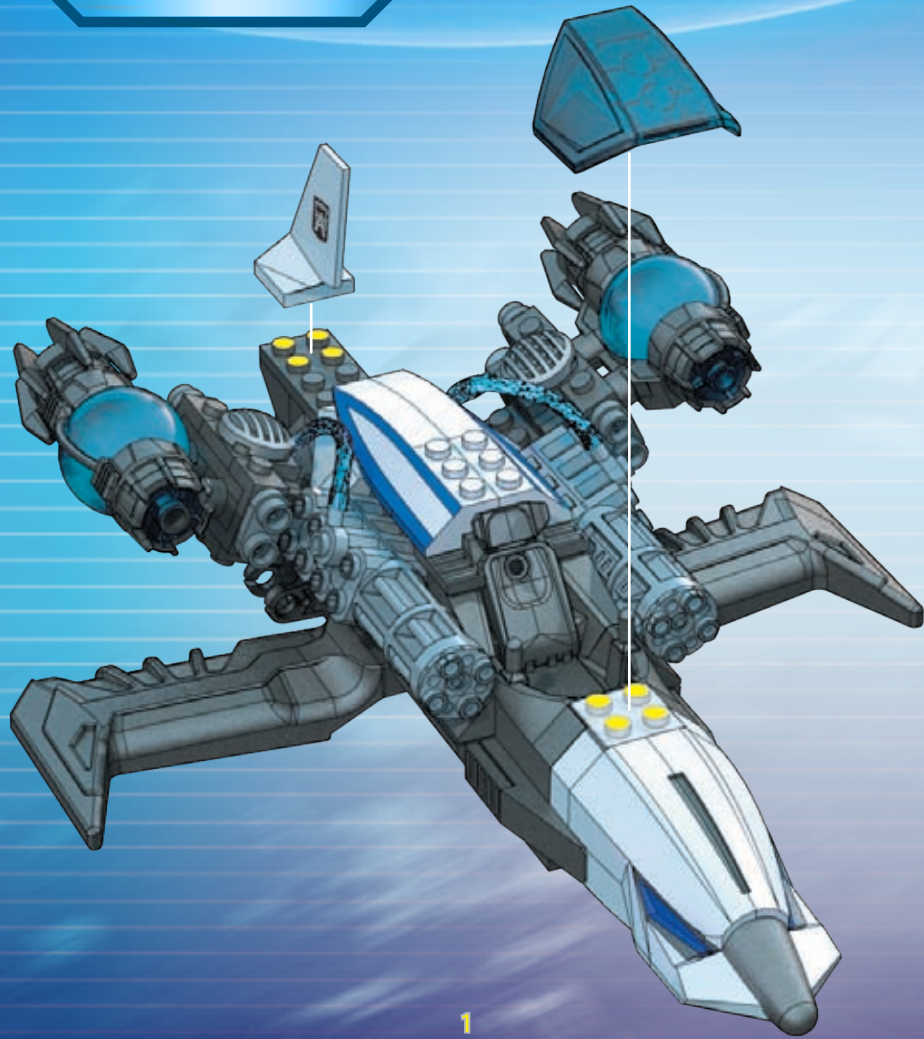



19



20

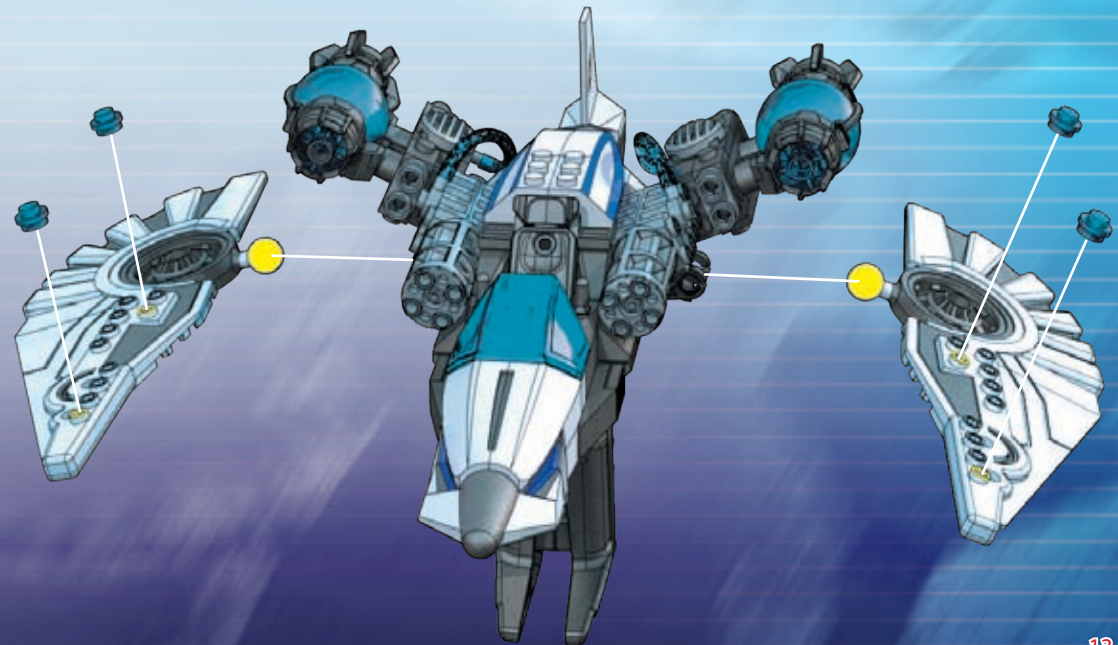
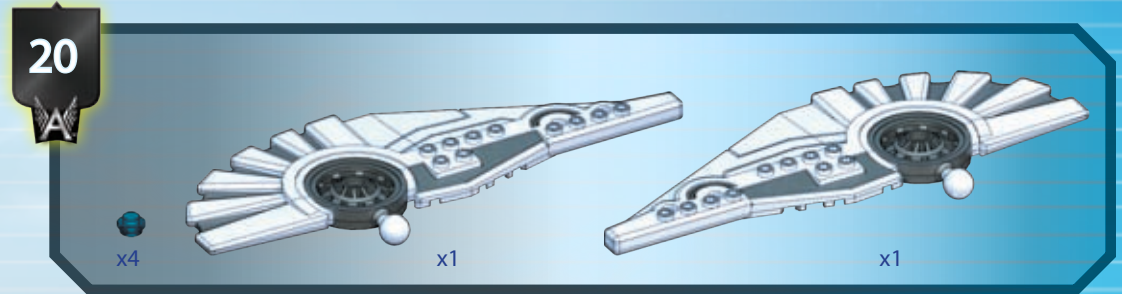



21



x1

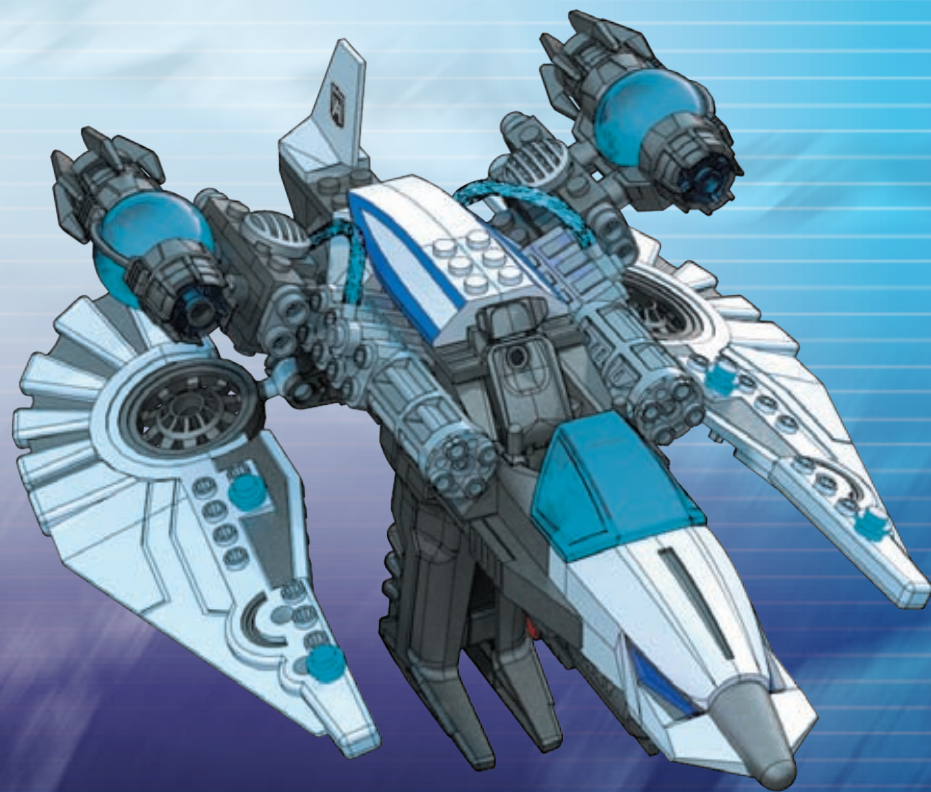
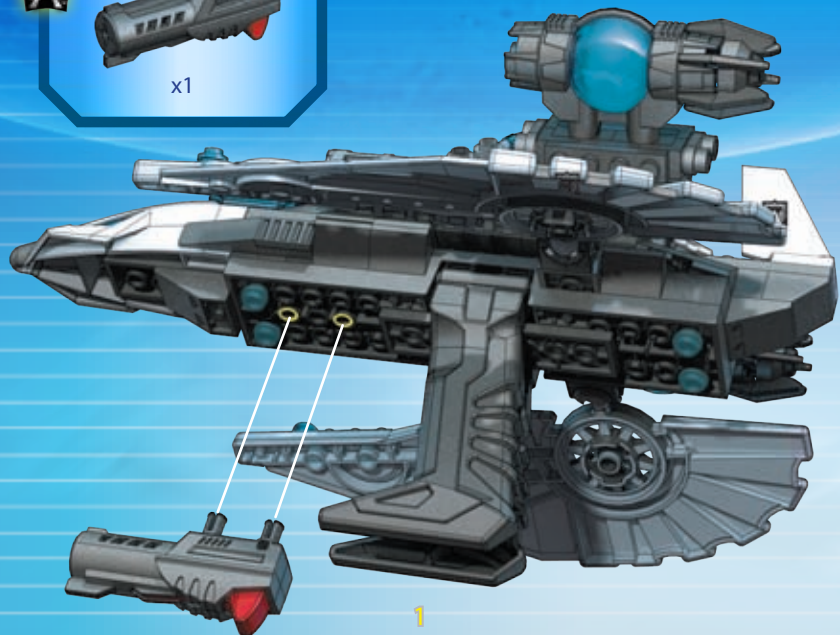



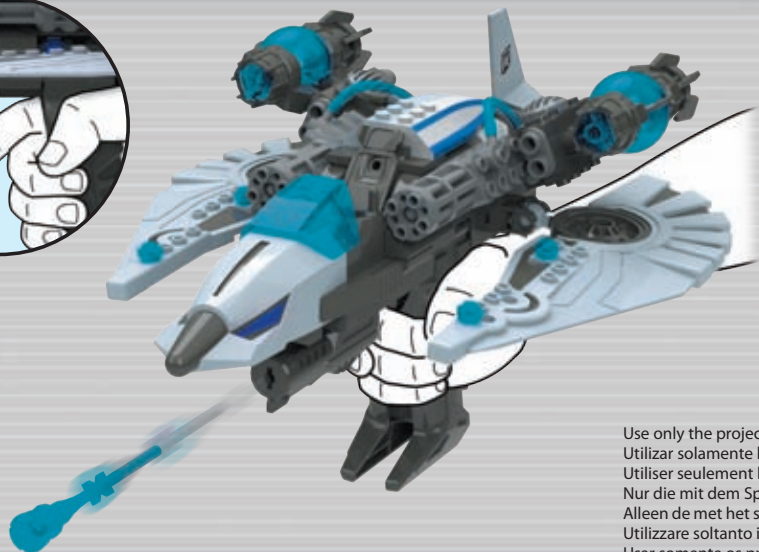

**WEAPON REALLY FIRES!  
ILANZA MISILES!  
LANCE DES MISSILES !  
RAKETENWERFER  
RAKETLANCEEINRICHTING  
LANCIAMISSILI  
LANÇADOR DE MISSEIS**



- EN** CAUTION! Do not aim at eyes or face.
- ES** ¡ADVERTENCIA! NO dirigir nunca los proyectiles hacia los ojos o la cara.
- FR** ATTENTION! Ne pas viser les yeux ou le visage.
- DE** VORSICHT! Nicht auf das Gesicht oder die Augen richten.
- NL** LET OP: Niet op ogen of gezicht richten.
- DA** ADVARSEL! Peg ikke i retning af øjne eller ansigt.
- EL** ΠΡΟΣΟΧΗ! Να μην σκοπεύετε προς τα μάτια ή το πρόσωπο.
- FI** VARO! Älä tähtää silmiin tai kasvoihin.
- IT** Attenzione! Non puntare verso gli occhi o il viso.
- NO** FORSIKTIG! Sikt ikke mot øyne eller ansikt.
- PT** ATENÇÃO: Não apontar para os olhos ou o rosto.
- SV** VAR FÖRSIKTIG! Rikta inte med ögon eller ansikte.
- JA** 注意！目や顔に使用しないで下さい。
- ZH** 警告！不要对准眼睛或脸。
- AR** تنبيه! لا توجه للعينين أو الوجه

Use only the projectiles included with this toy.  
Utilizar solamente los proyectiles incluidos con el juguete.  
Utiliser seulement les projectiles fournis avec le jouet.  
Nur die mit dem Spielzeug mitgelieferten Projektile verwenden.  
Alleen de met het speelgoed bijgeleverde projectielen gebruiken.  
Utilizzare soltanto i proiettili forniti con questo giocattolo.  
Usar somente os projéteis incluídos com este brinquedo.  
إستخدم فقط القذيفة المرافقة لهذه اللعبة

**BUILT-IN FLIGHT CONTROLLER WITH LANDING GEAR  
CONTROLADOR DE VUELO INCORPORADO CON TREN DE ATERRIZAJE  
CONTRÔLEUR DE VOL INTÈGRE AVEC TRAIN D'ATERRISSAGE  
EINGEBAUTE FLUGSTEUERUNG MIT FAHRWERK  
INGEBOWDE VLUCHTGELEIDER MET LANDINGSGESTEL  
UNITÀ DI CONTROLLO VOLO INTEGRATA CON SUPPORTI PER L'ATTEGGIO  
CONTROLADOR DE VOO INTEGRADO COM TREM DE ATERRAGEM**

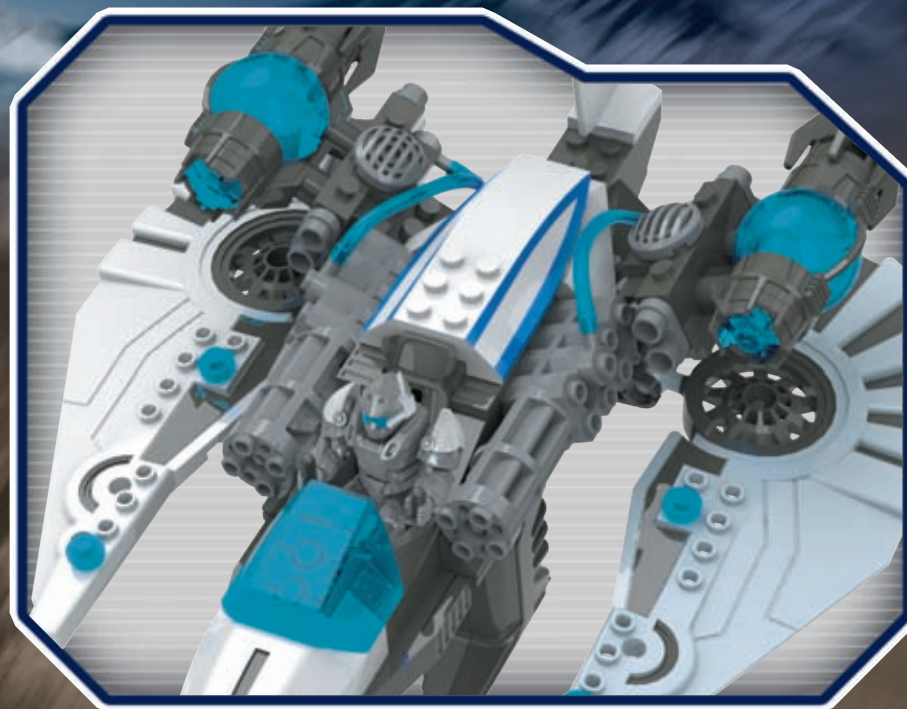
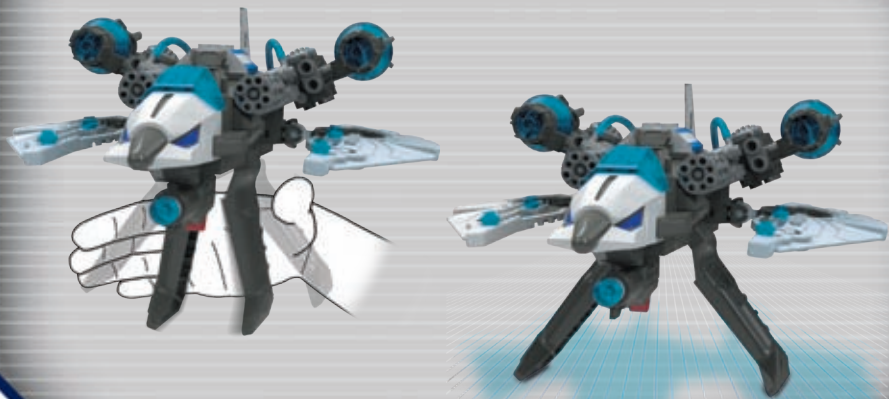



# DRAGONS UNIVERSE



**BUILT-IN FLIGHT CONTROLLER**  
 INTEGRIERTE FLUCHTSTEUERUNG  
 INGEBOUWDE VLUCHTGELEIDER  
 FLIGHT CONTROLLER INTEGRATO  
 CONTROLADOR DE VOO INCORPORADO



Bladewing™



**WEAPON REALLY FIRES!**  
 RAKETENWERFER  
 RAKETLANCEEERINRICHTING  
 LANCIAMISSILI  
 LANÇADOR DE MISSEIS



Alliance Hawk™

Captain  
Decimus™



**Collect Them All!**  
**¡Coleccionalos todos!**  
**Collectionne-les tous!**

Alle sammeln!/Verzamel ze allemaal!  
 Collezionali tutti!/Coleciona todos!



95231 Eagle™

95229 Falcon™

95230 Stallion™

95227 Skullcrush™

95228 Ironclaw™

95204 Torchwing™

95202 Clawripper™

95213

95207

95203 Blackheart™

95205 Tailspike™

95214



© 2010, MEGA Brands Inc.  
 MEGA Brands Inc. and the MEGA Brands Inc. logo are registered trademarks of MEGA Brands Inc. / MEGA Brands Inc. y el logotipo MEGA Brands Inc. son marcas registradas de MEGA Brands Inc.  
 MEGA Brands Inc. et le logo de MEGA Brands Inc. sont des marques de commerce déposées de MEGA Brands Inc. / MEGA Brands Inc. und das MEGA Brands Inc.-Logo sind eingetragene Warenzeichen von MEGA Brands Inc.  
 MEGA Brands Inc. en het MEGA Brands Inc. logo zijn gedeponeerde handelsmerken van MEGA Brands Inc. / MEGA Brands Inc. ed il logo di MEGA Brands Inc. sono marchi di fabbrica di MEGA Brands Inc.  
 MEGA Brands Inc. e o logo MEGA Brands Inc. são marcas registradas de MEGA Brands Inc.  
 Printed in China AD952071A



# ADDENDUM

18

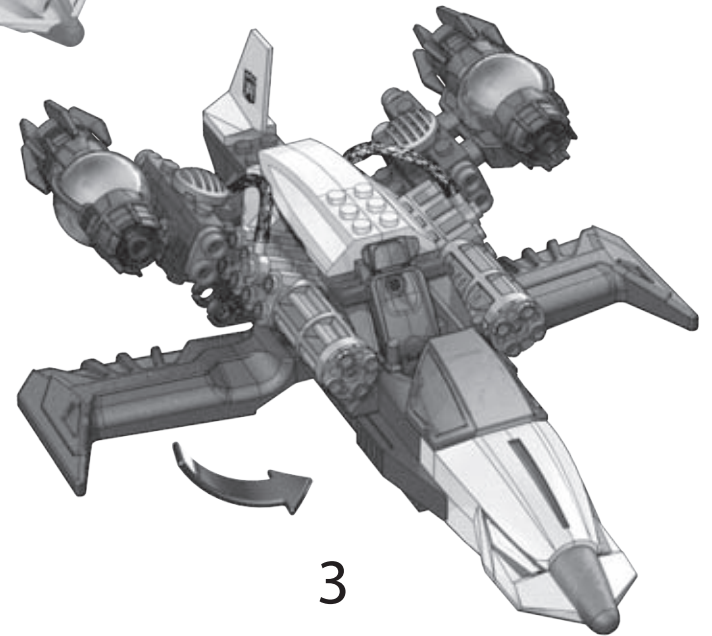
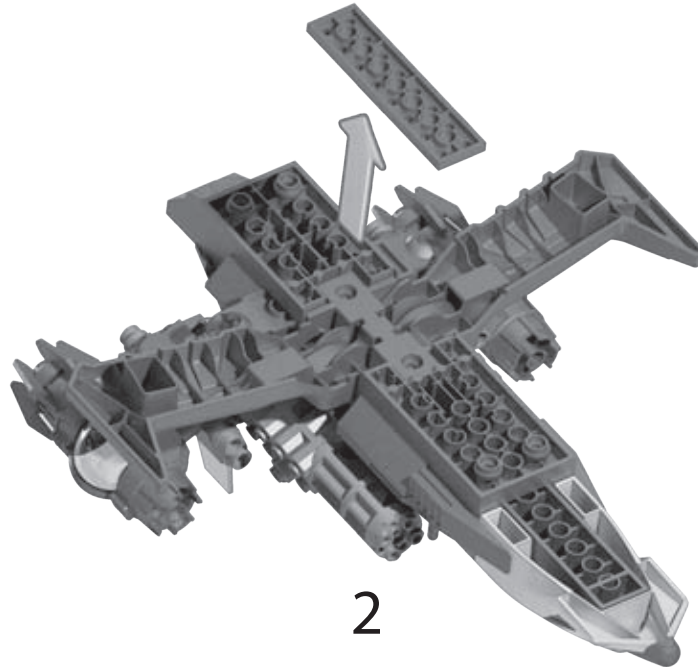
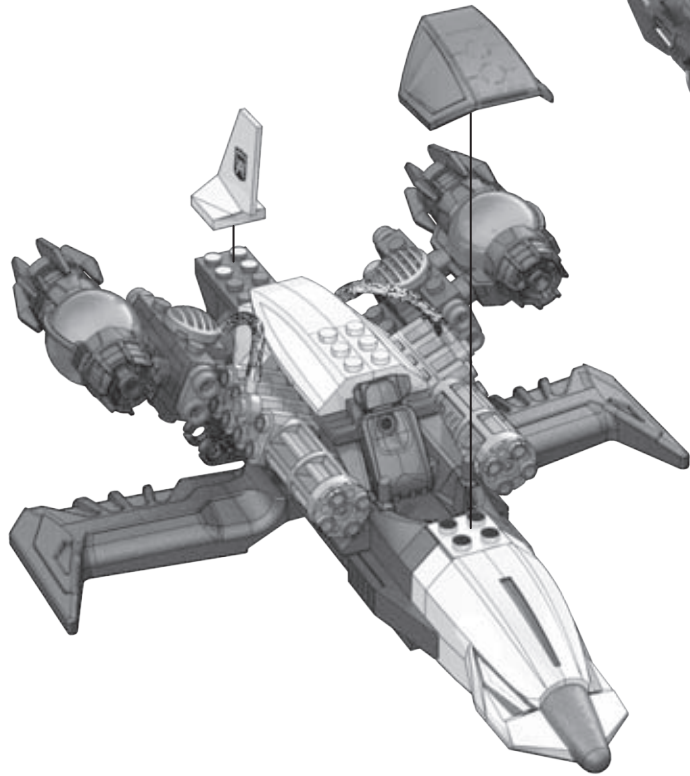
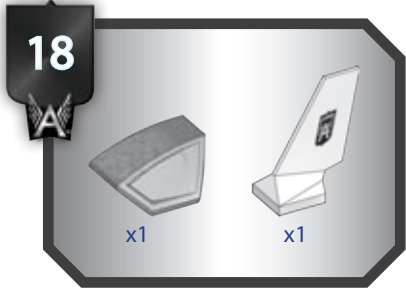

© 2010, MEGA Brands Inc.  
AD952072