

# HALO WARS™

THE AUTHENTIC COLLECTOR'S SERIES



96816

Green UNSC Spartan-II • Spartan-II UNSC verde • Spartan-II vert du CSNU •  
Grüner UNSC Spartan-II • Groene UNSC Spartan-II • UNSC Spartan-II verde • UNSC Spartan-II Verde

# HALO WARS™

THE AUTHENTIC COLLECTOR'S SERIES

## GREEN SPARTAN

96816

Spartans-III are the most powerful soldiers in the history of the Human race. Their dominance of the battlefield was absolute...until they met the Covenant.

Los Spartans-III son los soldados más poderosos de la historia de la humanidad. Su dominio en el campo de batalla fue absoluto... hasta que se enfrentaron a los Covenant.

Les Spartans-III sont les soldats les plus puissants de l'histoire de la race humaine. Leur domination du champ de bataille était absolue... jusqu'à ce que ils aient rencontré les Covenant.

Spartans-III sind die mächtigsten Soldaten in der Geschichte der Menschheit. Sie bestimmte die Schlacht... bis sie auf die Allianz trafen.

Spartans-III hebben zich bewezen als de beste soldaten in de geschiedenis van het menselijk ras. Zij domineerden elk slagveld... tot ze tegenover de Verdrag kwamen te staan.

Spartano-III sono i soldati più potenti della storia della razza umana. Il loro dominio del campo di battaglia era totale... finché non si sono scontrati con i Covenant.

Os Espartano-III são os soldados mais poderosos na história da Raça humana. O seu domínio no campo de batalha era absoluto... até depararem com o Covenant.

Fully Articulated  
Totalmente articulado  
Entièrement articulé  
komplett beweglich  
Volledig te bewegen  
Completamente snodato  
Totalmente articulado

9.5" (24 cm)



UNSC Spartan II  
Spartiate  
de l'UNSC II  
UNSC-Spartaner II  
VN Spartan II  
Spartano UNSC II  
Espartano da UNSC II

**CAMOUFLAGE**  
EFFECT

EFFETTO DE  
**CAMUFLAJE**

EFFET  
**CAMOUFLAGE**

TARNEFFEKT  
CAMOUFLAGE-EFFECT  
EFFETTO MIMETICO  
EFEITO CAMUFLAGEM







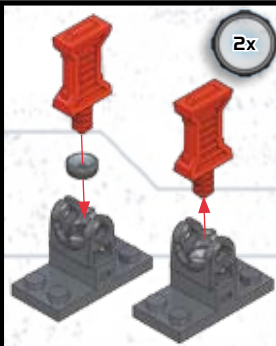
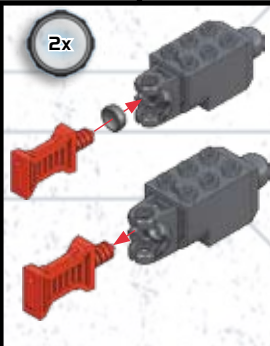
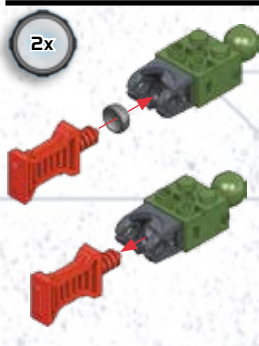
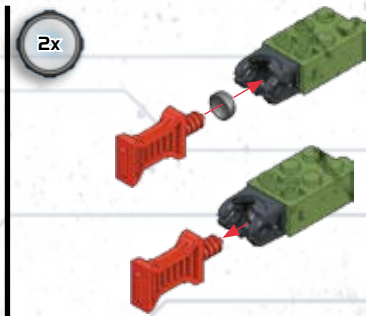
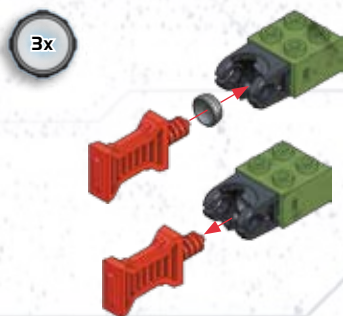

**EN** Please read these instructions carefully before first use and keep them for future reference. / **ES** Leer estas instrucciones cuidadosamente antes de la primera utilización y guardarlas para referencia futura. / **FR** Il est recommandé de lire attentivement ce feuillet avant la première utilisation et de le conserver pour référence future. / **DE** Die Gebrauchsanleitung bitte durchlesen und aufbewahren. / **NL** Wij raden u aan deze handleiding zorgvuldig te lezen en te bewaren voor eventuele raadpleging op een later tijdstip. / **IT** Leggere le istruzioni prima di cominciare ad usare il gioco e conservarle per referenze future. / **PT** Leia as instruções antes do primeiro uso e guarde-as para futura referência.

**EN** ⚠ **WARNING :**  
**CHOKING HAZARD.** - Small parts.  
 Not for children under 3 years.

**ES** ⚠ **ADVERTENCIA :**  
**PELIGRO DE ASFIXIA.** - Contiene piezas pequeñas.  
 No recomendado para niños menores de 3 años.

**FR** ⚠ **AVERTISSEMENT :**  
**RISQUE DE SUFFOCATION.** - Présence de petits éléments. Ne convient pas aux enfants de moins de 3 ans.

**DE** ⚠ **WARNUNG :**  
**ERSTICKUNGSGEFAHR.** - Enthält kleine Teile.  
 Nicht für Kinder unter 3 Jahren geeignet.

**NL** ⚠ **WAARSCHUWING :**  
**VERSTIKKINGSGEVAAR.** - Bevat kleine onderdelen. Niet geschikt voor kinderen onder de 3 jaar.

**DA** ⚠ **ADVARSEL :**  
**KVÆLNINGSFARE.** - Indeholder smådele.  
 Ikke til børn under 3 år.

**EL** ⚠ **ΠΡΟΕΙΔΟΠΟΙΗΣΗ :**  
**ΚΙΝΔΥΝΟΣ ΠΝΙΞΙΜΑΤΟΣ.** - Περιέχει μικρά αντικείμενα. Όχι για παιδιά κάτω των 3 ετών.

**FI** ⚠ **VAROITUS :** **TUKEHTUMISVAARA.** - Sisältää pieniä osia. Ei alle 3-vuotiaille lapsille.

**IT** ⚠ **ATTENZIONE :** **PERICOLO DI SOFFOCAMENTO.**  
 - Contiene piccole parti. Non indicato per bambini sotto i 3 anni.

**NO** ⚠ **ADVARSEL :**  
**KVELNINGSFARE.** - Inneholder små deler.  
 Kun for barn over 3 år.

**PT** ⚠ **ATENÇÃO :**  
**PERIGO DE ASFIXIA.** - Contém peças pequenas.  
 Não é concebido para crianças de menos de 3 anos.

**SV** ⚠ **WARNING :**  
**KVÄVNINGSRISK.** - Innehåller små delar.  
 Inte för barn under 3 år.

**JA** ⚠ **警告 :**  
 窒息の危険性 - 小さな部品が含まれています  
 3歳以下の子供には与えないで下さい。

**ZH** ⚠ **警告 :**  
 有窒息危险。 - 包含有小部件  
 不适合3岁以下的小孩玩。

**AR** ⚠ **تحذير :**  
 خطر اختناق - قطع صغيرة.  
 غير صالحة للأطفال أقل من 3 سنوات.



© 2009 MICROSOFT CORPORATION. ALL RIGHTS RESERVED. MICROSOFT, HALO, THE HALO LOGO, HALO WARS, XBOX, THE XBOX LOGO, ARE TRADEMARKS OF THE MICROSOFT GROUP OF COMPANIES.





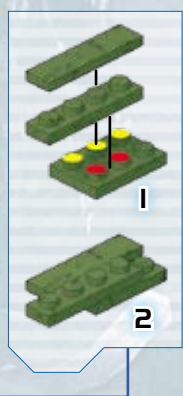
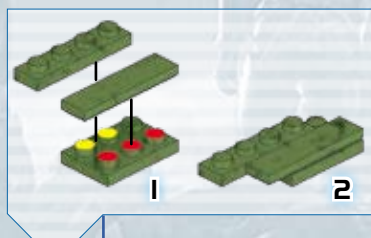
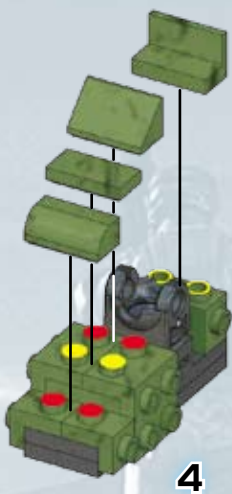
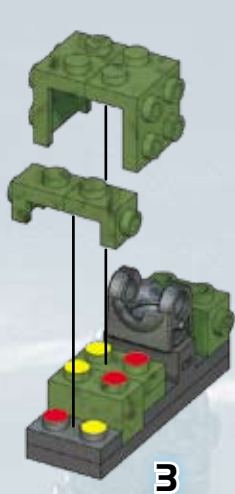





3

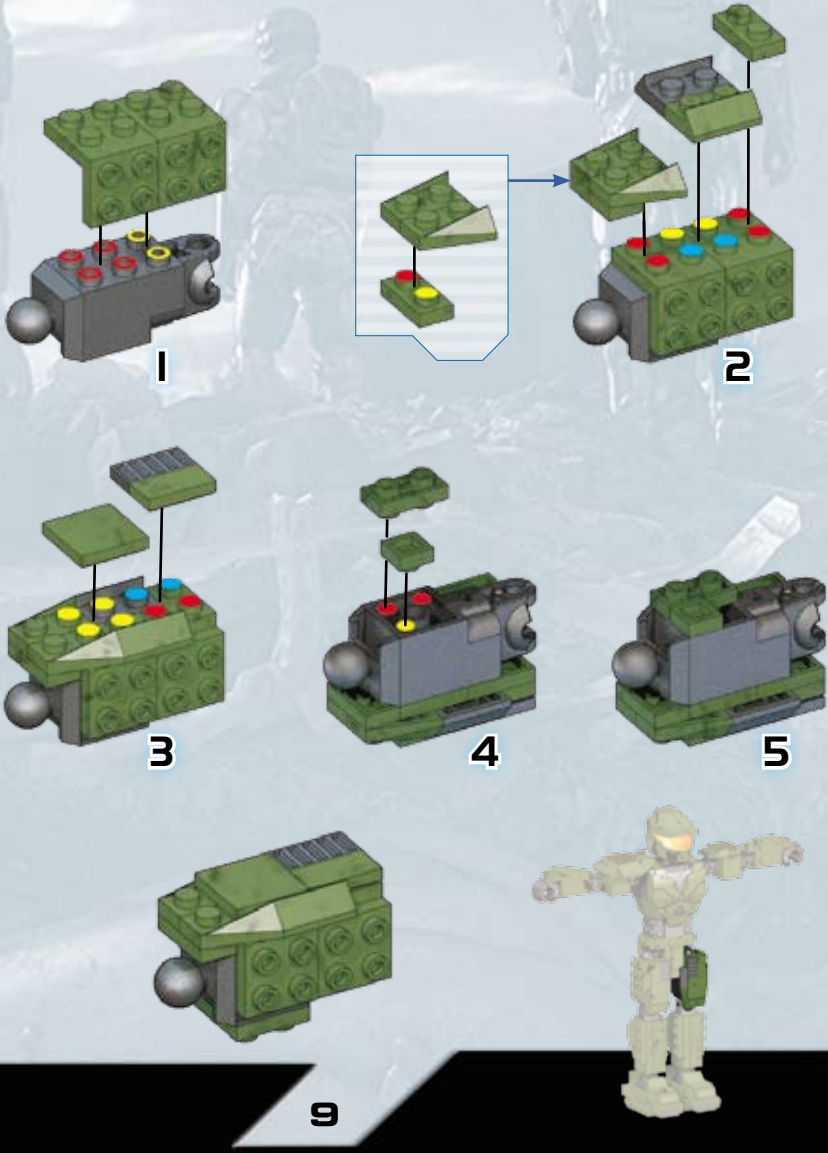
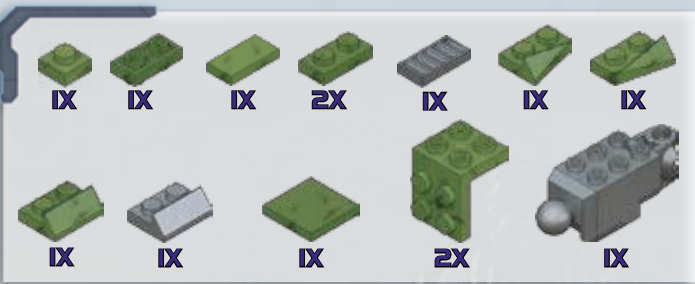

4

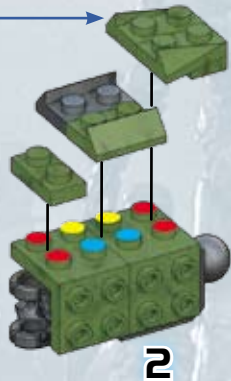
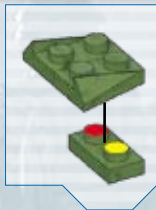
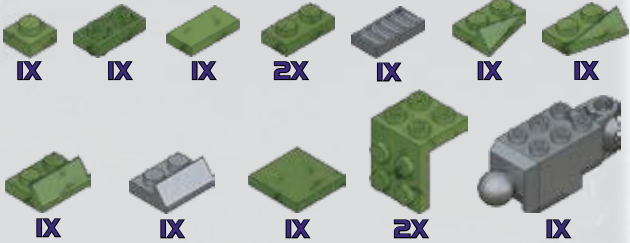

5

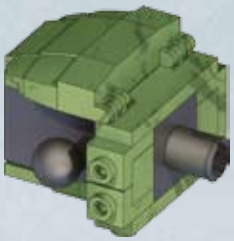
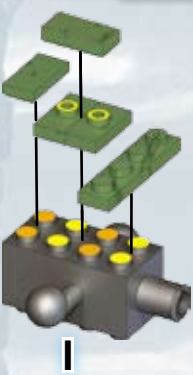



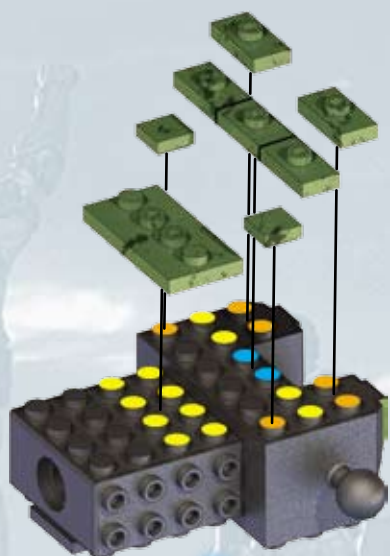

3

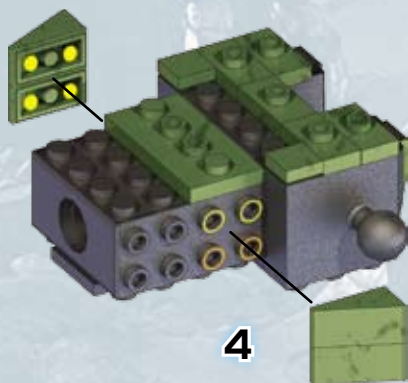

4



5





7



IX



IX

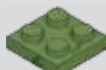

IX



IX

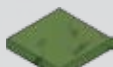

2X

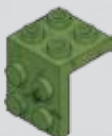

IX



IX



1

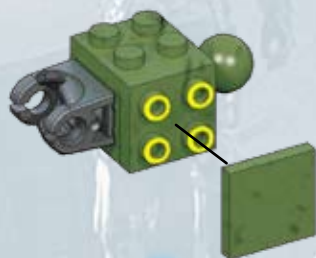

2



3



4



15

8



IX

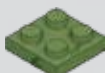

2X

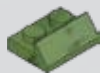

IX

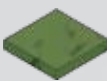

IX

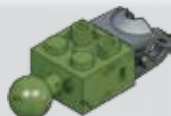

IX



IX

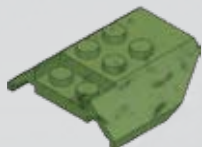

IX



1



2



3



4



HALO WARS™



9

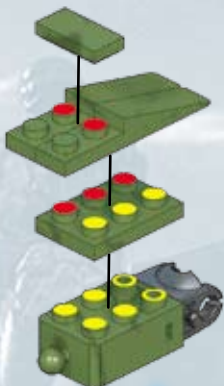

10



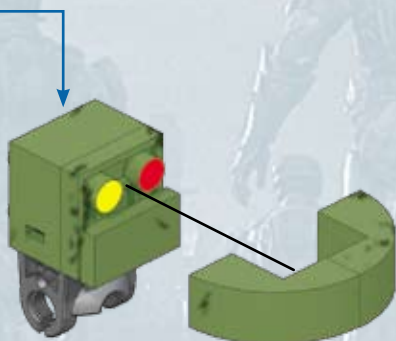
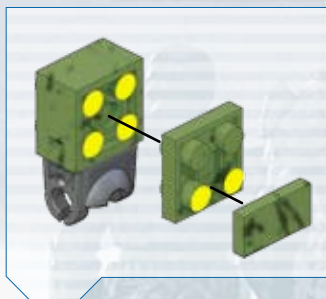

1

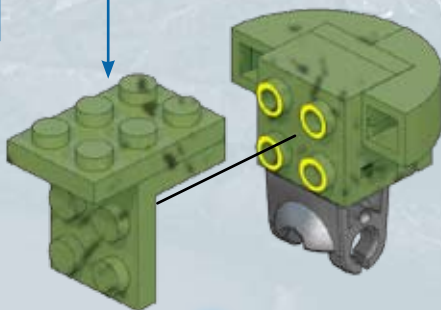

2



HALO WARS™

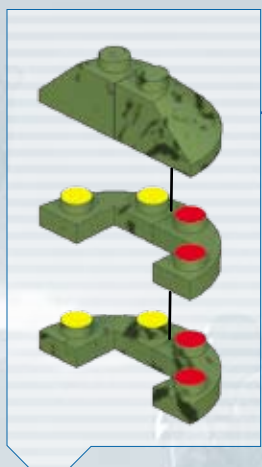

3



4



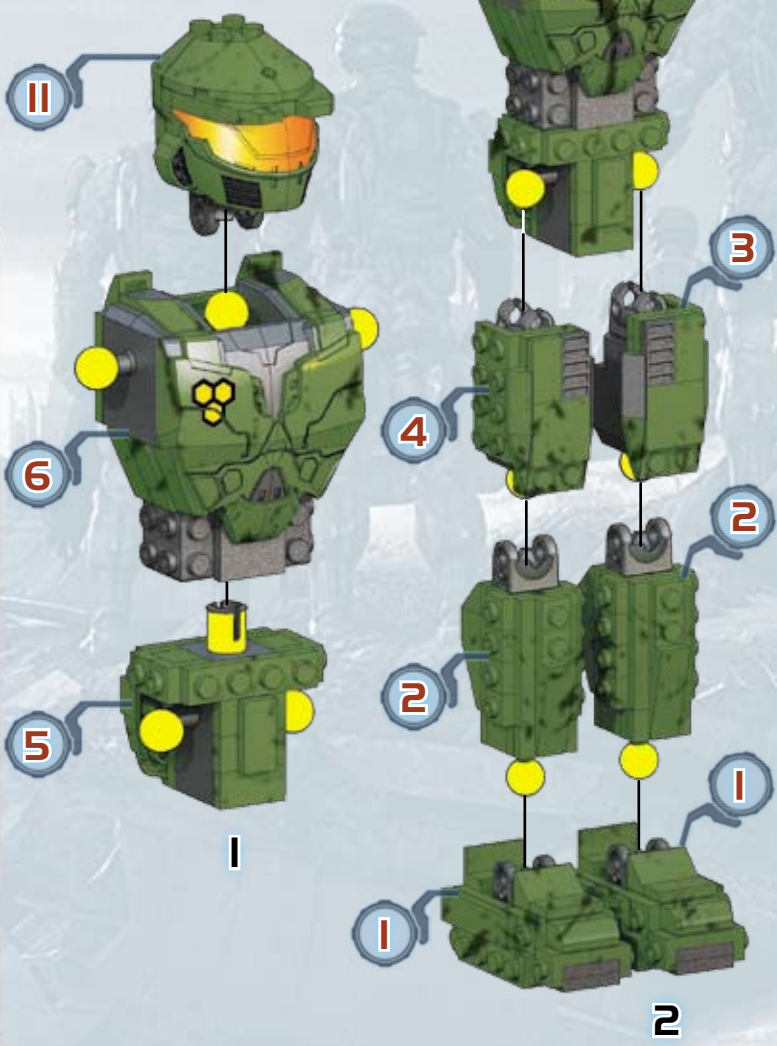





**Green UNSC Spartan II**

**MEGA** Printed in Canada ALM8103

Choose best place for extra stickers • Selecciona el mejor lugar para las pegatinas adicionales • Place les autres autocollants à l'endroit de ton choix • Wähle die ideale Stelle für Extra-Aufkleber • Kies de beste plek voor extra stickers • Scegli il posto migliore per gli altri adesivi • Escolha o melhor local para os adesivos extra

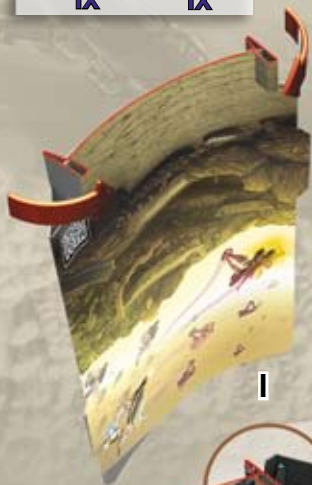
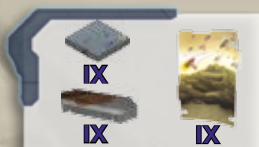

1

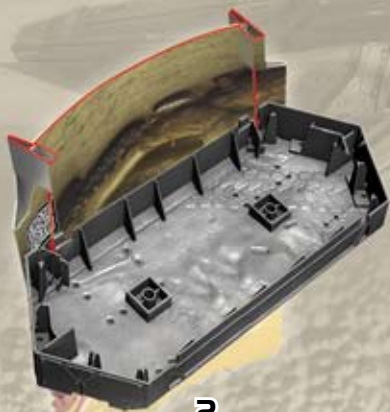

2

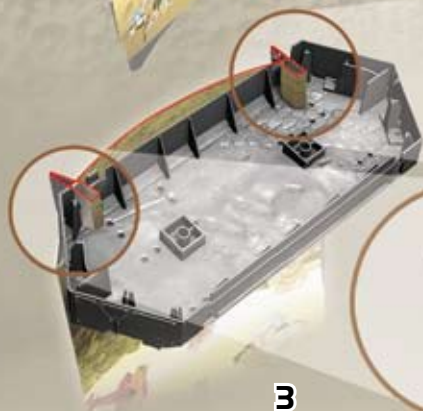

3

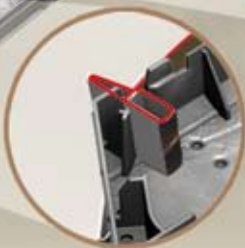
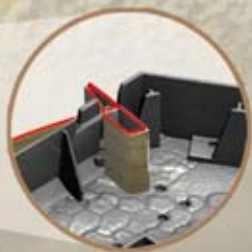

96820

96816

96819

Additional purchases required to collect all elements shown. • Para coleccionar todos los elementos mostrados se precisa realizar unas compras adicionales.

• Des achats additionnels sont nécessaires afin d'obtenir tous les articles de la collection illustrés. • Um alle dargestellten Elemente zu sammeln sind zusätzliche Käufe erforderlich. • Verdere aankopen zijn nodig om alle afgebeelde artikelen te verzamelen. • Acquisti supplementari necessari per collezionare tutti gli elementi illustrati • Compras adicionaissão necessárias para coleccionar todos os elementos exibidos.

# HALO WARS™

THE AUTHENTIC COLLECTOR'S SERIES

COLLECT THEM ALL!  
COLECCIONALOS TODOS!  
COLLECTIONNE-LES TOUS!  
HO! SIE DIR ALLEI!  
VERZAMEL ZE ALLEMAAL!  
COLLEZIONALI TUTTI!  
COLECCIONE TODOS ELES!



96801



96802



96805



96806



96807



96810



©2009, MEGA Brands International.  
® & ™ MEGA Brands Inc. & MEGA Brands International

Printed in China

AD968161B