

HALO

THE AUTHENTIC COLLECTOR'S SERIES



96824 UNSC Pelican • Carguero Pelican de la UNSC • Pelican du CSNU • Pelican der UNSC • Pelican van de UNSC • Pelican del UNSC • Pelican da UNSC



Thank you for purchasing UNSC PELICAN an authentic licensed product by MEGA BLOKS based on the legendary Halo universe. The collectible construction toy line features the heroic UNSC and enemy Covenant vehicles, characters and weapons. Choose an alliance, build the battle and emerge victorious!

Gracias por comprar CARGUERO PELICAN DE LA UNSC un producto auténtico con licencia de MEGA BLOKS según el legendario Halo universe. La línea de juguetes de construcción coleccionable ofrece vehículos, personajes y armas heroicos de UNSC y enemigos de Covenants. ¡Elije una alianza, elabora la batalla y sal victorioso!

Nous vous remercions d'avoir acheté PELICAN DU CSNU, un produit certifié authentique par MEGA BLOKS basé sur l'univers légendaire de Halo. La gamme d'articles de construction de collection met en vedette les membres héroïques du CSNU ainsi que les véhicules, personnages et armes de l'ennemi Covenant. Choisissez votre alliance, créez le combat et remportez la victoire.

Vielen Dank für den Kauf von PELICAN DER UNSC Hierbei handelt es sich um ein authentisches Lizenzprodukt von MEGA BLOKS, das auf dem legendären Halo-Universum beruht. Die Spielzeug-Baureihe zum Sammeln besteht aus heldenhaften UNSC- und feindlichen Allianz-Fahrzeugen, Figuren und Waffen. Entscheide Dich, auf welcher Seite du kämpfen willst, baue das Schlachtfeld auf und gehe aus der Schlacht als Sieger hervor!

Hartelijk dank voor het aanschaffen van de of het authentiek gelicentieerde PELICAN VAN DE UNSC van MEGA BLOKS dat op de legendarische Halo wereld gebaseerd is. De lijn waardevolle bouw pakketten bevat modellen van de heldhaftige Covenant voertuigen, personages en vuurwapens van de UNSC en de vijand. Kies je bondgenoten, vervaardig je slagveld en win het gevecht!

La ringraziamo per avere acquistato PELICAN DEL UNSC un prodotto autentico con licenza della MEGA BLOKS basato sul leggendario universo Halo. La linea di giocattoli da collezione costruibili presenta i veicoli dell'eroica UNSC della nemica Alleanza, con i personaggi e le armi. Scegli un alleato, costruisci la battaglia e vieni fuori vincitore!

Obrigado por adquirir PELICAN DA UNSC, um produto autêntico licenciado pela MEGA BLOKS baseado no lendário universo de Halo. A linha de brinquedos de construção colecionáveis conta com veículos dos heróis da UNSC e do inimigo Covenant, bem como personagens e armas. Escolha uma aliança, construa a batalha e saia vitorioso!

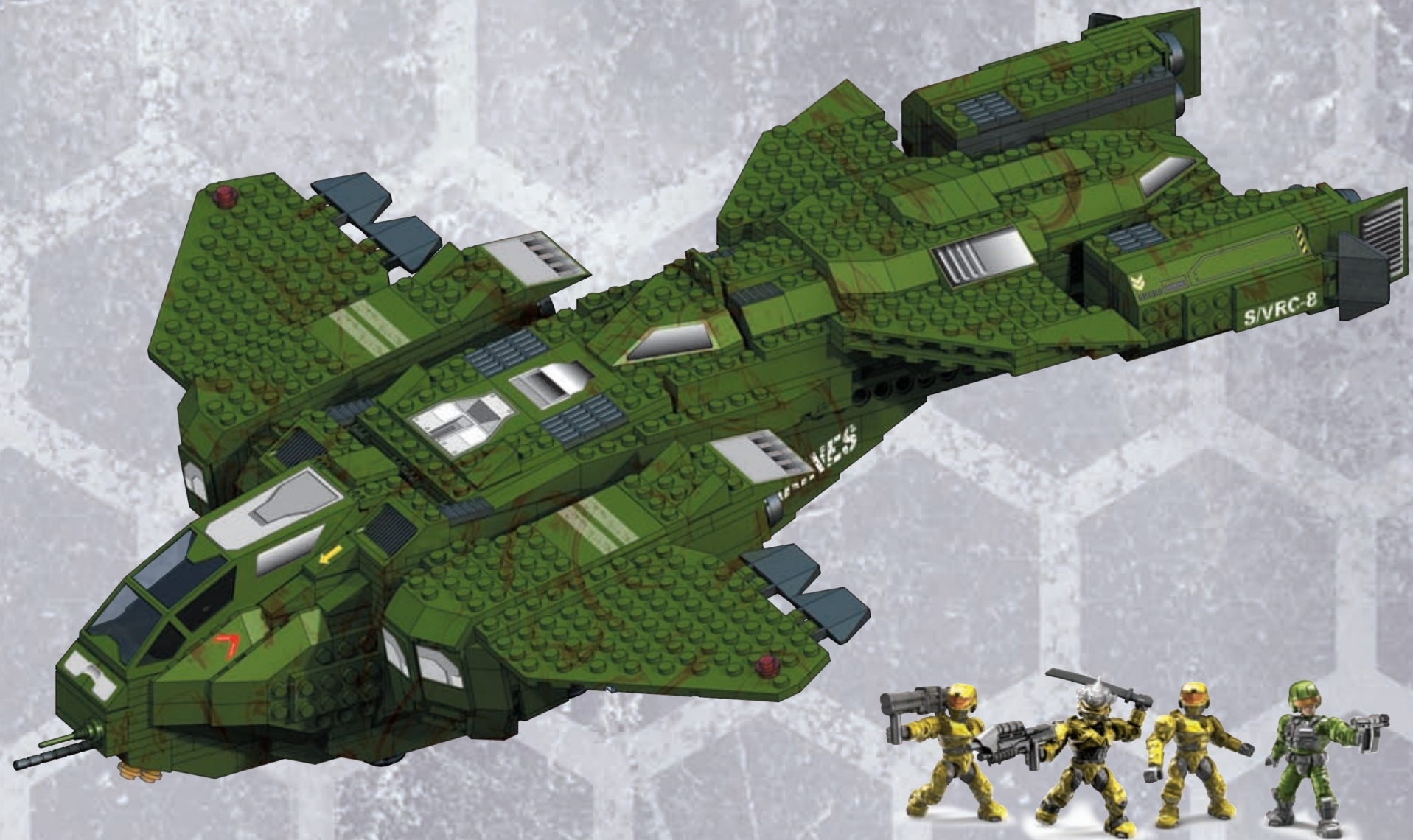



- 6X AM03328AJM
- 2X AM07223AJM
- 8X AM17127AJM
- 1X AM01683AJM
- 4X AM04428AJM
- 25X AM07629AJM
- 2X AM16649AJM
- 2X AM16680AJM
- 1X AM07590AJM
- 68X MA09393AJM
- 4X MA022501AJM
- 1X AM17130AJM
- 1X AM17129AJM
- 1X AM17131AJM
- 6X AM17128AJM
- 1X AM07228AJM

- 12X MA1086AJM
- 14X AM04430AJM
- 4X AM03019AJM
- 6X MA1146AJM
- 3X MA0948AJM
- 19X AM03773AJM
- 14X AM15484AJM
- 16X AM16975AJM
- 17X MA1314AJM
- 22X AM03772AJM
- 1X AM17073AJM
- 1X AM17074AJM
- 2X AM09487AJM
- 2X AM09488AJM
- 2X MA1142AJM
- 2X AM03091AJM

- 4X MA11101AJM
- 9X MA1417AJM
- 10X AM04429AJM
- 4X AM07658AJM
- 4X MA1322AJM
- 21X M09013AJM
- 22X MA1154AJM
- 8X AM17153AJM
- 12X MA09023AJM
- 10X MA10273AJM
- 16X MA1418AJM
- 4X MA1323AJM
- 13X AM16384AJM
- 16X MA1141AJM
- 25X MA1139AJM
- 6X AM03873AJM

- 1X MA1153AJM
- 1X AM03324AJM
- 1X AM03323AJM
- 6X AM04497AJM
- 43X MA09493AJM
- 1X AM04434AJM
- 1X AM04433AJM
- 1X AM09826AJM
- 1X AM09825AJM
- 6X AM17066AJM
- 2X AS9682402
- 28X MA1087AJM
- 30X MA09033AJM

- 57X MA09593AJM
- 3X MA1390AJM
- 8X AM09838AJM
- 2X AM16959AJM
- 12X AM07475AJM
- 19X AM09292AJM
- 2X AM09269AJM
- 2X AM17114AJM
- 12X MA1313AJM
- 17X MA1480AJM
- 6X AM16630AJM
- 6X AM16629AJM
- 4X AM03058AJM
- 4X AM04244AJM

- 3X AM16962AJM
- 3X AM16976AJM
- 4X AM16311AJM
- 5X MA1346AJM
- 6X AM17054AJM
- 6X AM04983AJM
- 7X AM08483AJM
- 11X MA10233AJM
- 6X AM04984AJM
- 2X AM09933AJM

- 2X AM03771AJM
- 2X AM03770AJM
- 6X AM17055AJM
- 1X AM07646AJM
- 4X AM04219AJM
- 8X AM09923AJM
- 8X AM04985AJM
- 2X MA1172AJM
- 3X AM09924AJM
- 2X AM17069AJM

- 4X AM02237AJM
- 5X MA1128AJM
- 1X AM15476AJM
- 1X AS9682403
- 1X AM17145AJM
- 1X AM17144AJM

2X
M1113X

4X
M1113ZD

7X
AM17057W

2X
AM16384W

1X
MA09033ACX

1X
AM02930F

4X
AM07010F

2X
AM04985W



1X
L968241

2X
AM09104MM

1X
AM03019MM

4X
AM17115MM

19X
AM09198MM

2X
MA1133MM

16X
AM17010MM

1X
AM09268MM

8X
AM17147MM

10X
MA1141MM

4X
AS9682404

4X
AM17285MM

1X
AM16966MM

4X
AM09923MM

1X
AM01525MM

1X
AM16612MM

1X
AM16698MM

1X
AM16700MM

1X
AM17035MM

1X
AM17062MM

1X
AS9682405

2X
AS9682406

1X
AS9682401

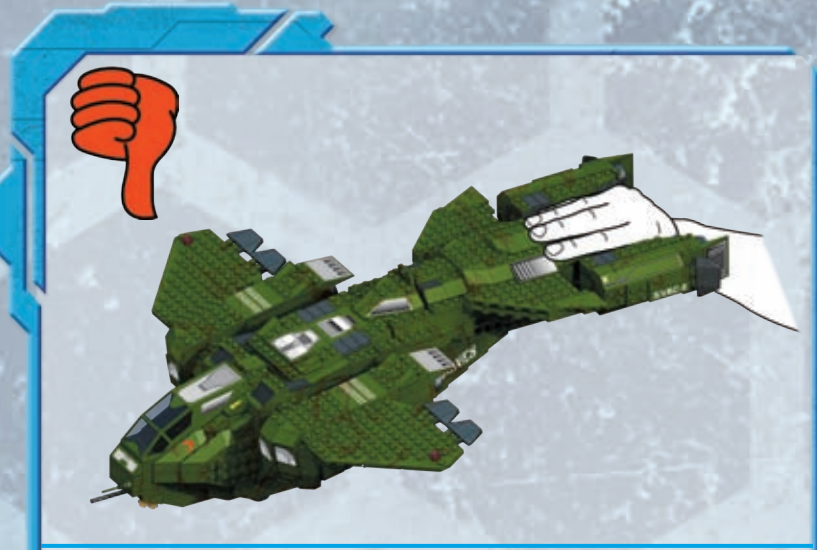

EN Please read these instructions carefully before first use and keep them for future reference. / ES Leer estas instrucciones cuidadosamente antes de la primera utilización y guardarlas para referencia futura. / FR Il est recommandé de lire attentivement ce feuillet avant la première utilisation et de le conserver pour référence future. / DE Die Gebrauchsanleitung bitte durchlesen und aufbewahren. / NL Wij raden u aan deze handleiding zorgvuldig te lezen en te bewaren voor eventuele raadpleging op een later tijdstip. / IT Leggere le istruzioni prima di cominciare ad usare il gioco e conservarle per referenze future. / PT Leia as instruções antes do primeiro uso e guarde-as para futura referência.

EN ⚠ WARNING: CHOKING HAZARD. - Small parts. Not for children under 3 years.

ES ⚠ ADVERTENCIA: PELIGRO DE ASFIXIA. - Contiene piezas pequeñas. No recomendado para niños menores de 3 años.

FR ⚠ AVERTISSEMENT: RISQUE DE SUFFOCATION. - Présence de petits éléments. Ne convient pas aux enfants de moins de 3 ans.

DE ⚠ WARNUNG: ERSTICKUNGSGEFAHR. - Enthält kleine Teile. Nicht für Kinder unter 3 Jahren geeignet.

NL ⚠ WAARSCHUWING: VERSTIKKINGSGEVAAR. - Bevat kleine onderdelen. Niet geschikt voor kinderen onder de 3 jaar.

DA ⚠ ADVARSEL: KVÆLNINGSFARE. - Indeholder smådele. Ikke til børn under 3 år.

EL ⚠ ΠΡΟΕΙΔΟΠΟΙΗΣΗ: ΚΙΝΔΥΝΟΣ ΠΝΙΞΙΜΑΤΟΣ. - Περιέχει μικρά αντικείμενα. Όχι για παιδιά κάτω των 3 ετών.

FI ⚠ VAROITUS: TUKEHTUMISVAARA. - Sisältää pieniä osia. Ei alle 3-vuotiaalle lapsille.

IT ⚠ ATTENZIONE: PERICOLO DI SOFFOCAMENTO. - Contiene piccole parti. Non indicato per bambini sotto i 3 anni.

NO ⚠ ADVARSEL: KVÆLNINGSFARE. - Inneholder små deler. Kun for barn over 3 år.

PT ⚠ ATENÇÃO: PERIGO DE ASFIXIA. - Contém peças pequenas. Não é concebido para crianças de menos de 3 anos.

SV ⚠ VARNING: KVÄVNINGSRISK. - Innehåller små delar. Inte för barn under 3 år.

JA ⚠ 警告: 窒息の危険性 - 小さな部品が含まれています。3歳以下の子供には与えないで下さい。

ZH ⚠ 警告: 有窒息危险。 - 包含有小部件。不适合3岁以下的小孩玩。

AR ⚠ تحذير: خطر اختناق. قطع صغيرة. غير صالحة للأطفال أقل من 3 سنوات.



© 2010 MICROSOFT CORPORATION. ALL RIGHTS RESERVED. MICROSOFT, 343 INDUSTRIES, THE 343 INDUSTRIES LOGO, HALO, THE HALO LOGO, XBOX, XBOX 360, AND THE XBOX LOGOS, ARE TRADEMARKS OF THE MICROSOFT GROUP OF COMPANIES.

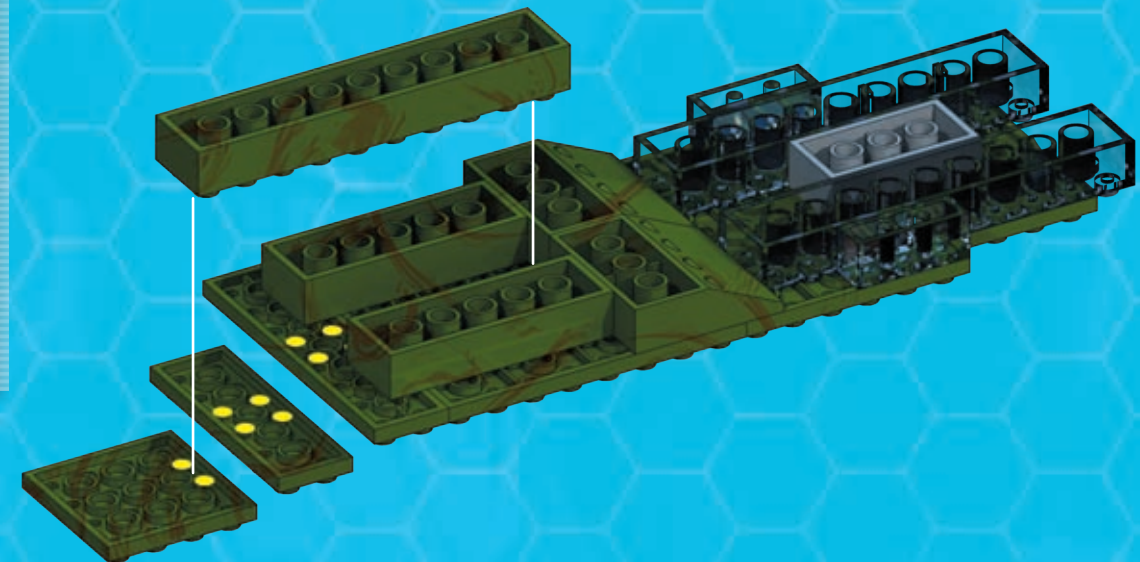
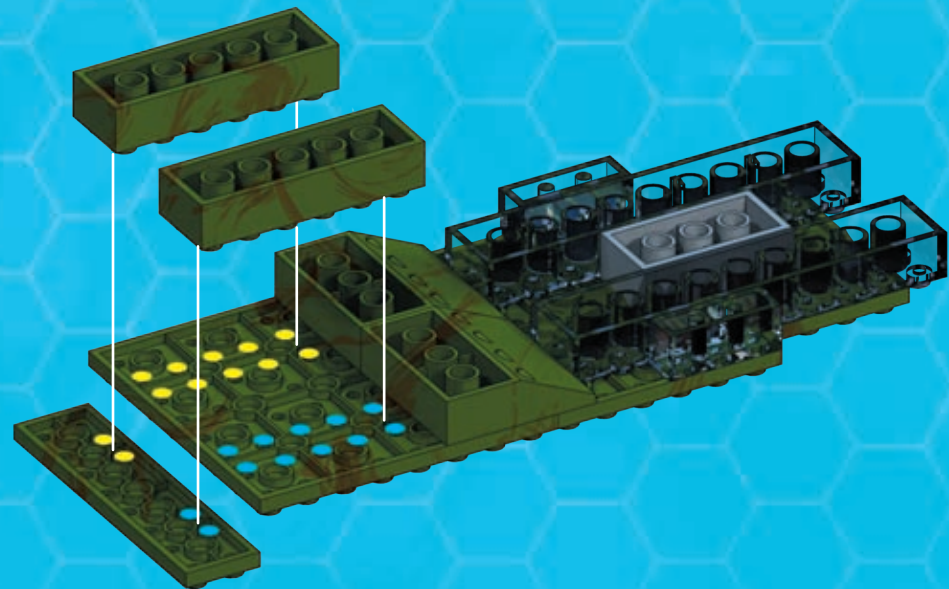
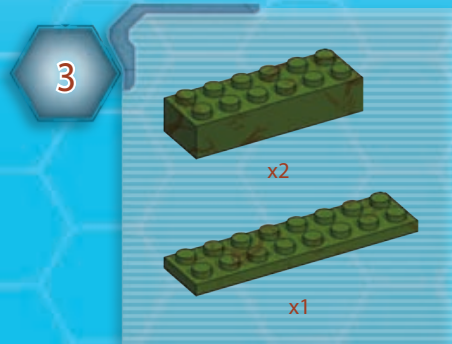
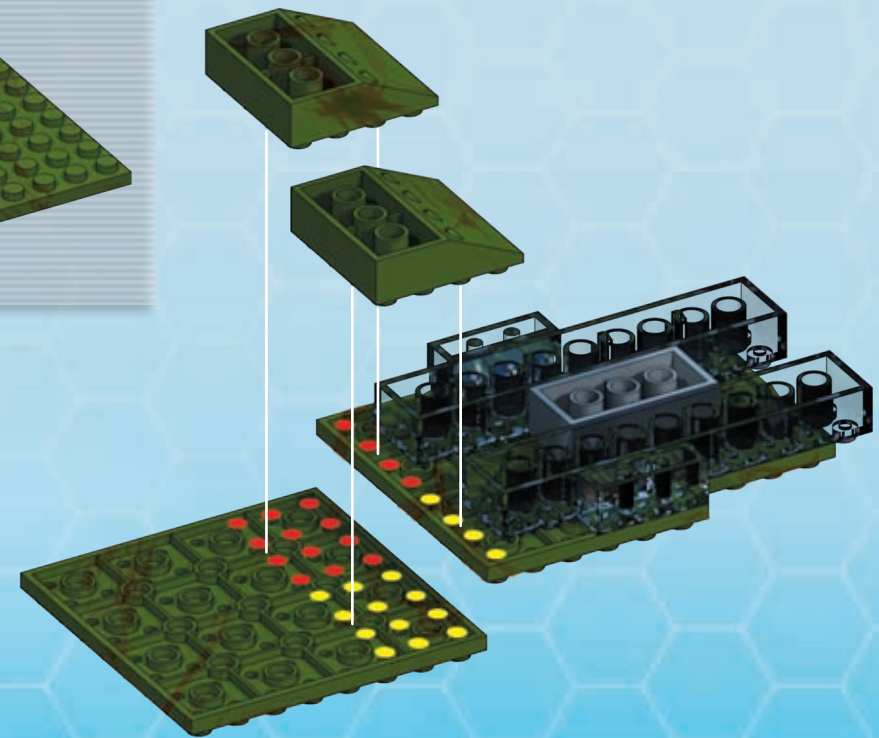
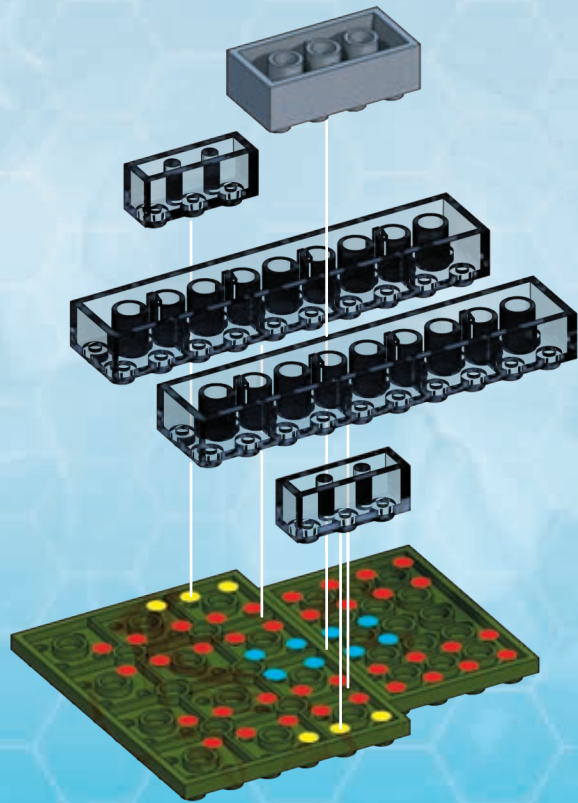

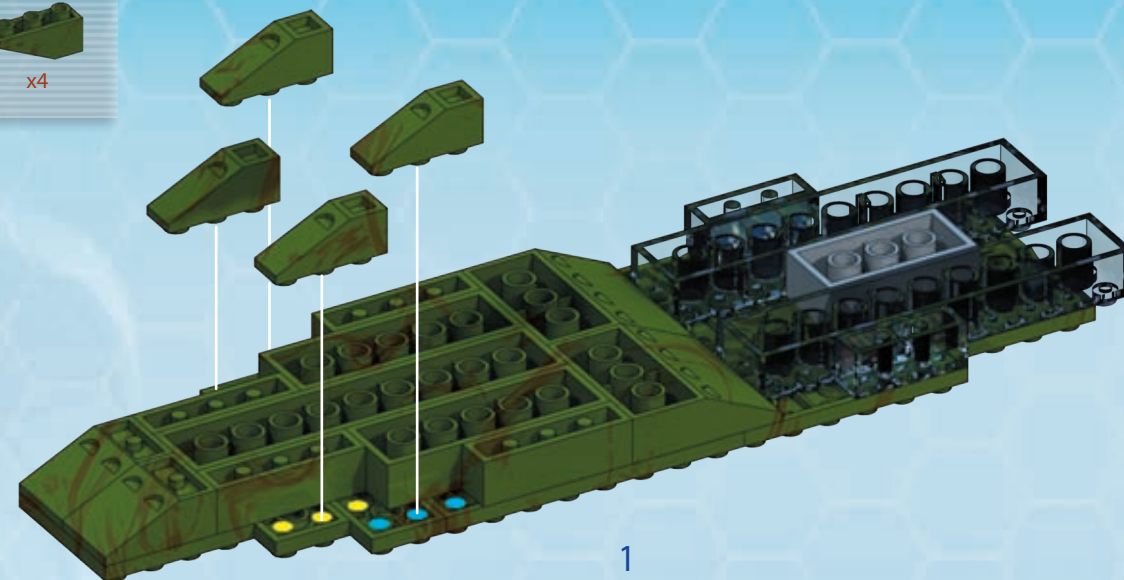
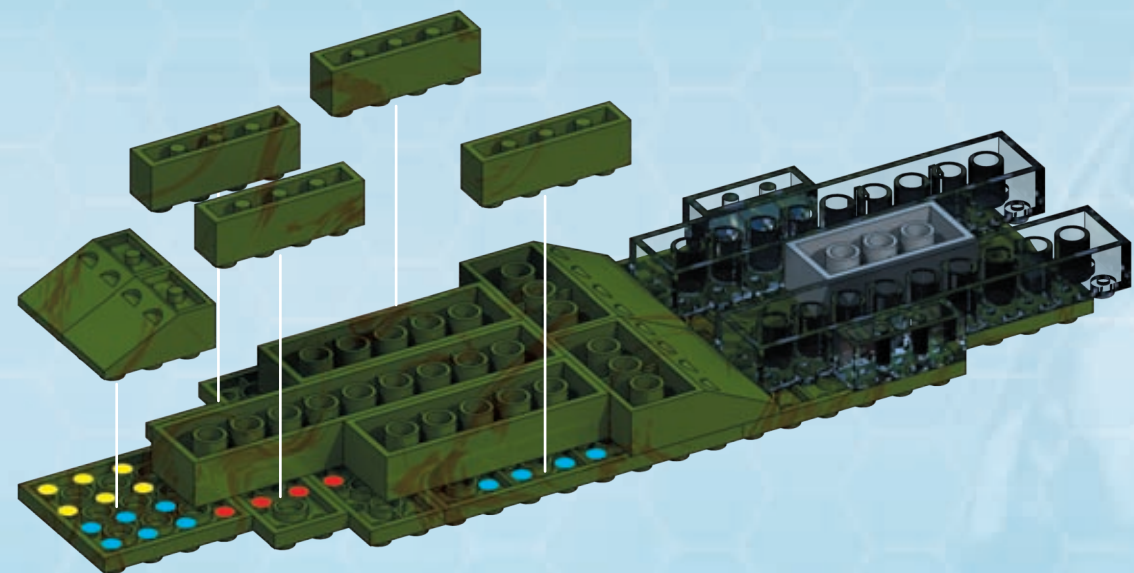

1

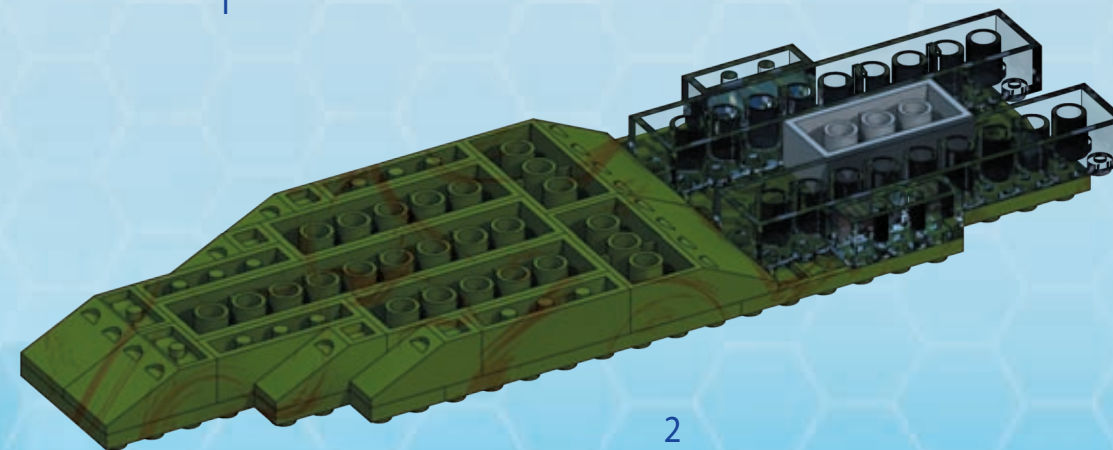

2

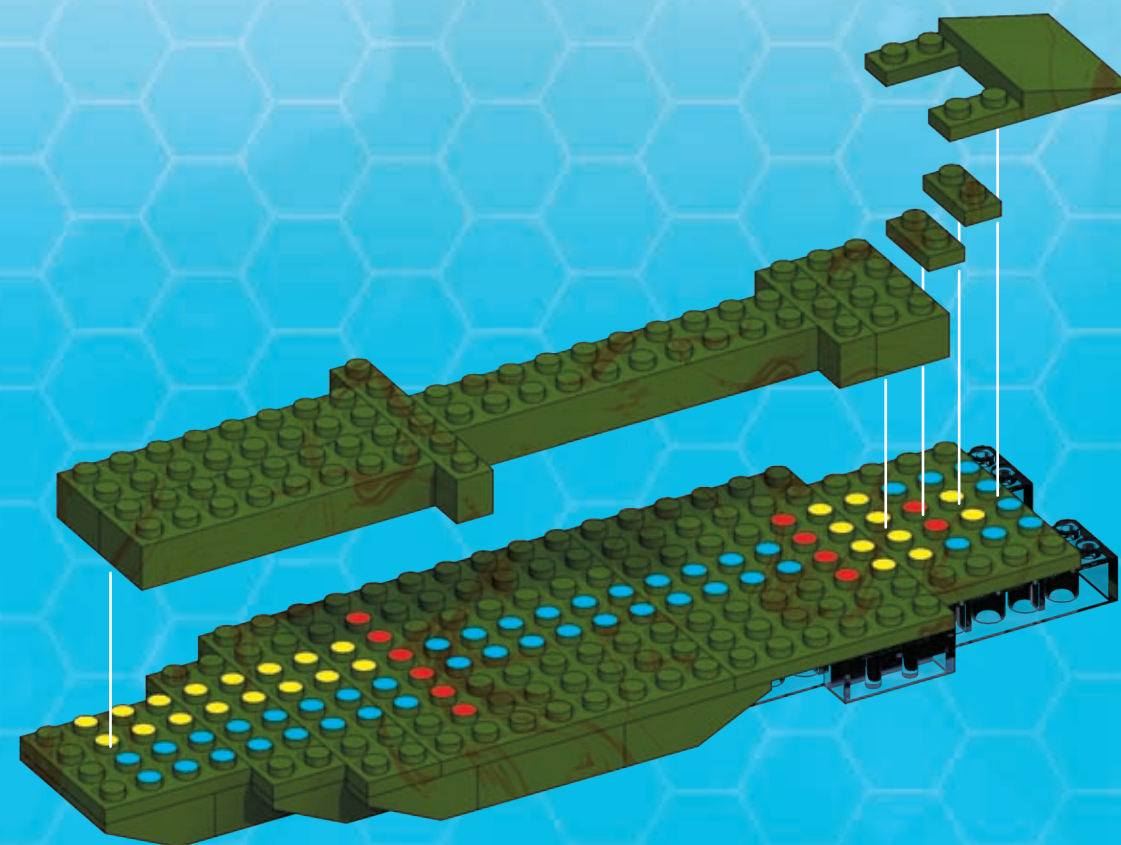
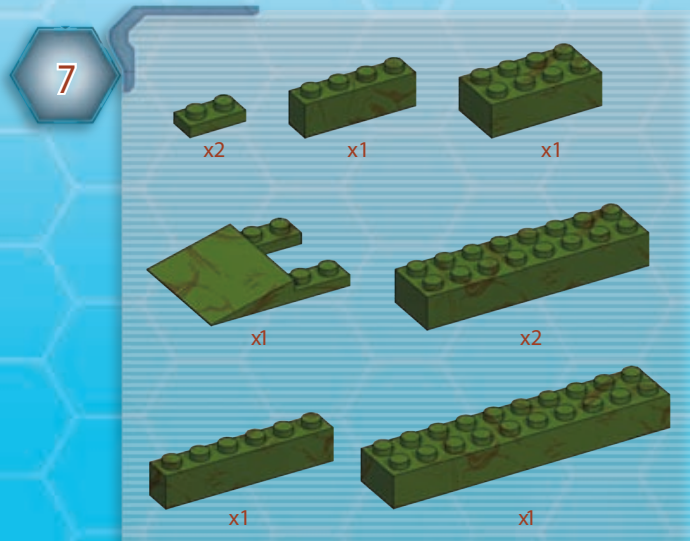

8

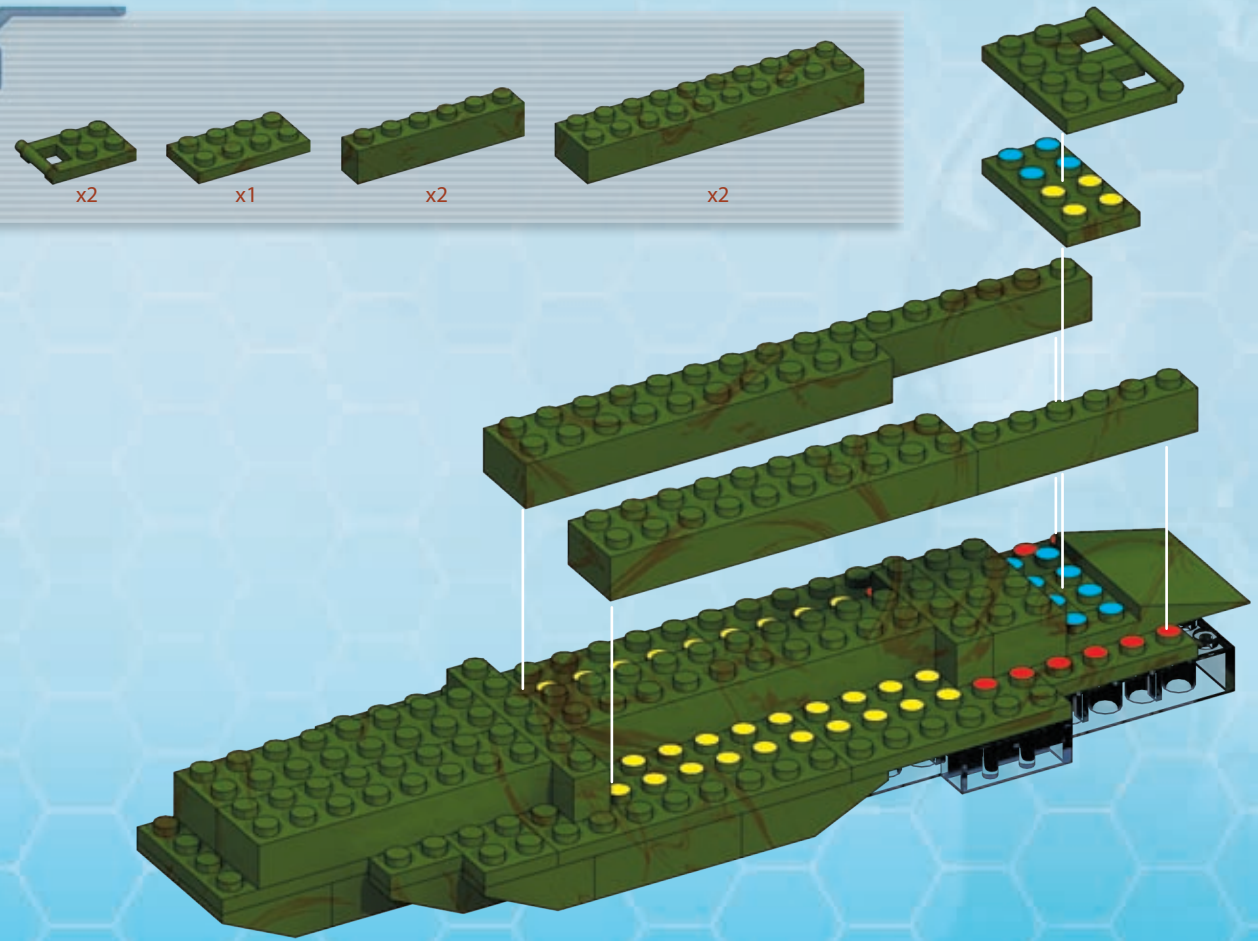

9

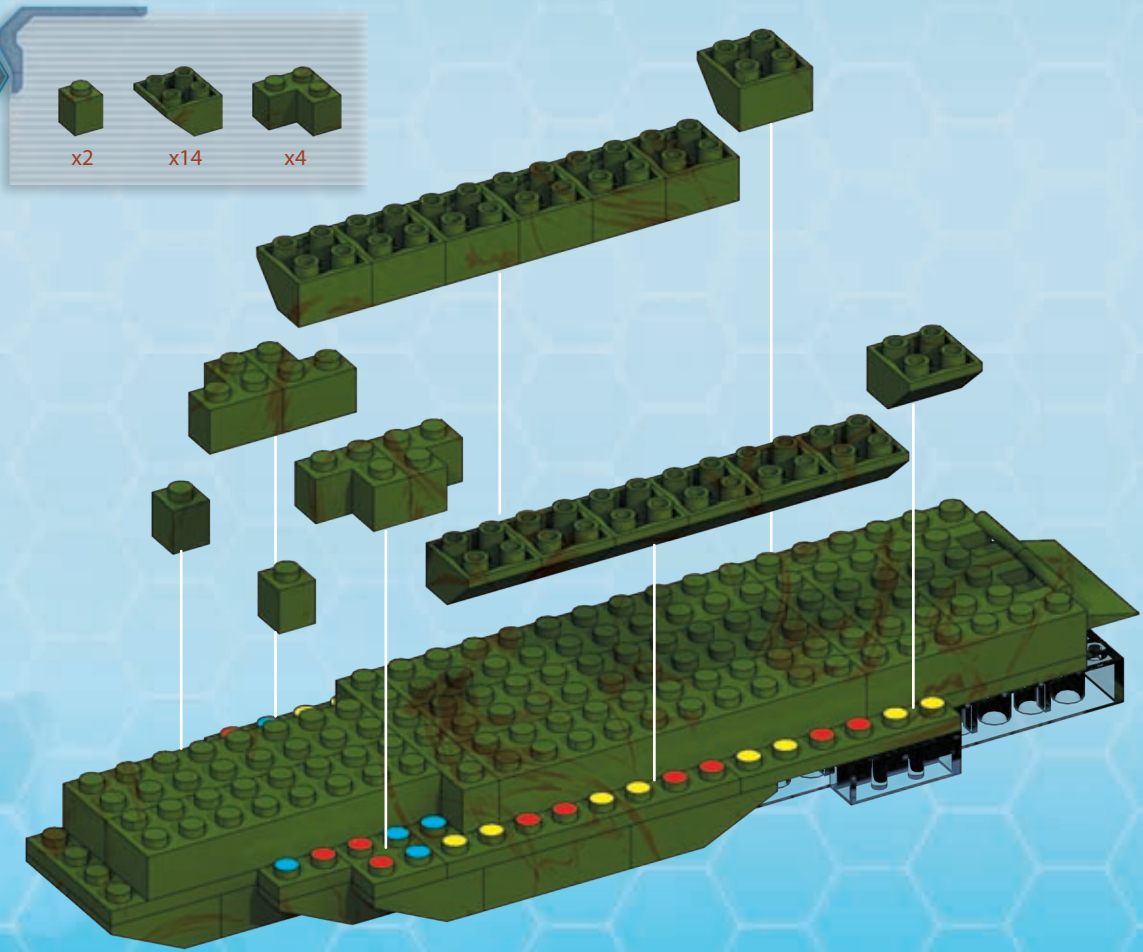

10

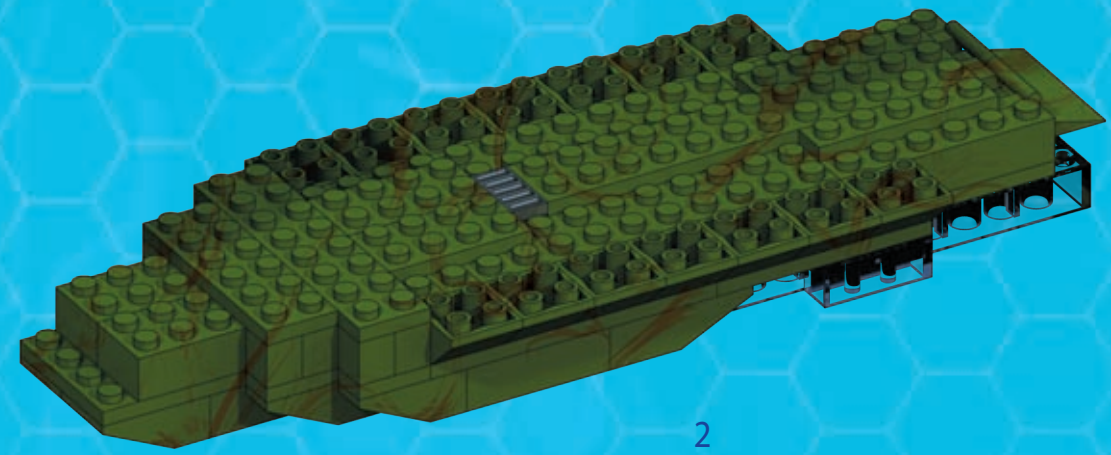
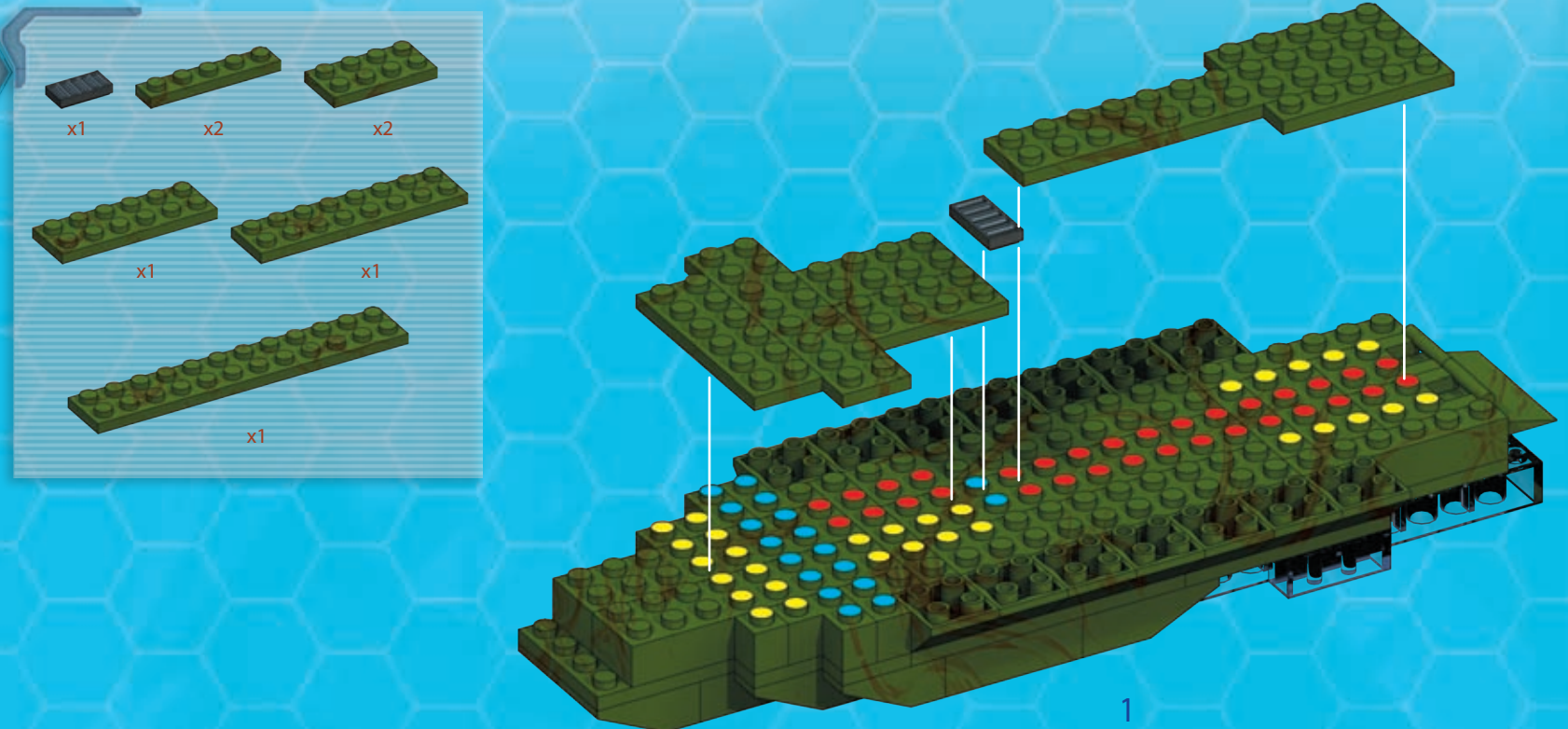

1

2

11

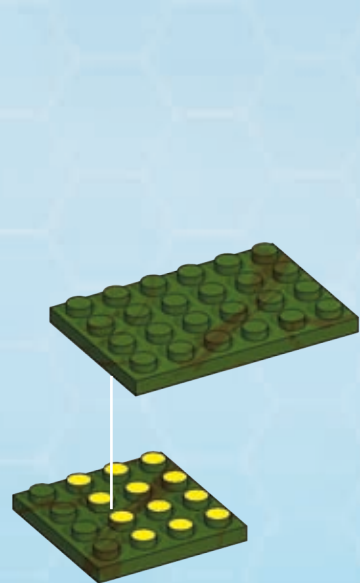
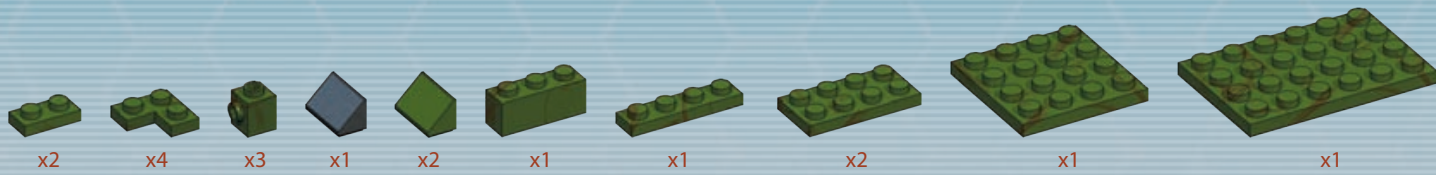

1

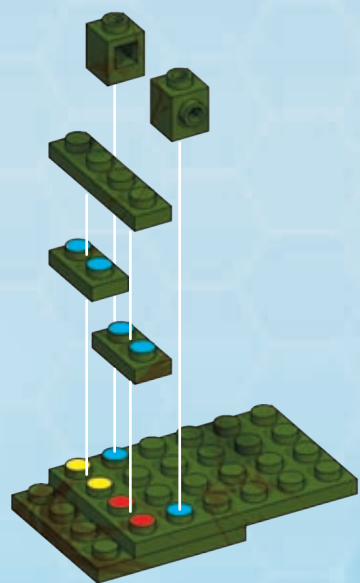

2

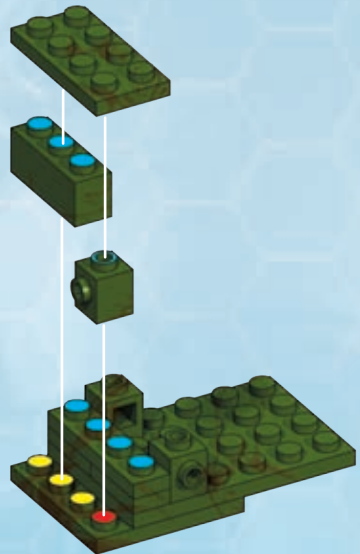

3

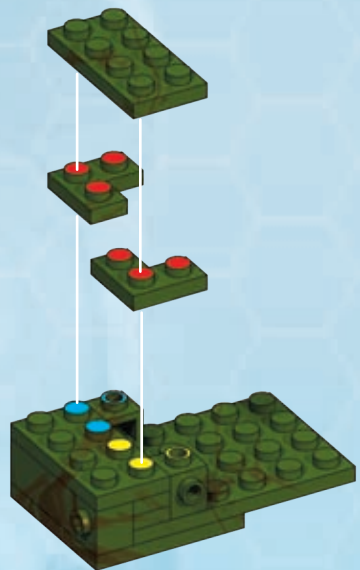

4

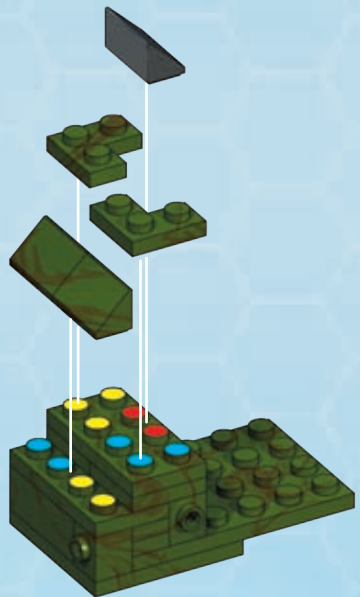

5

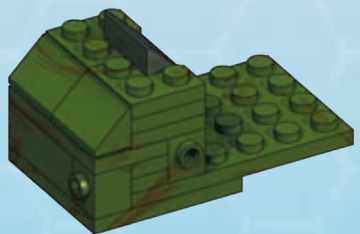

6

12

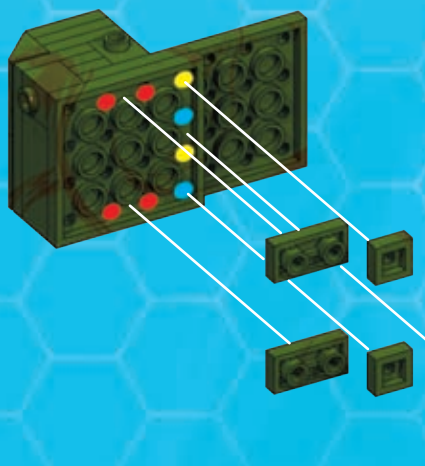

1

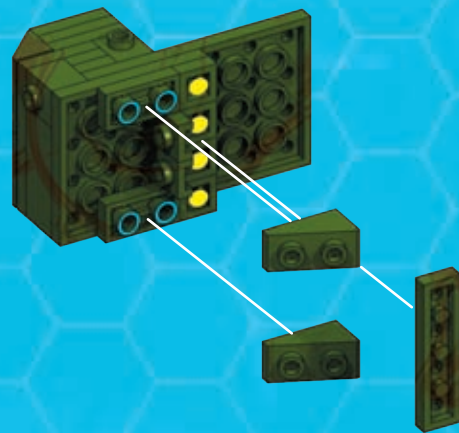

2

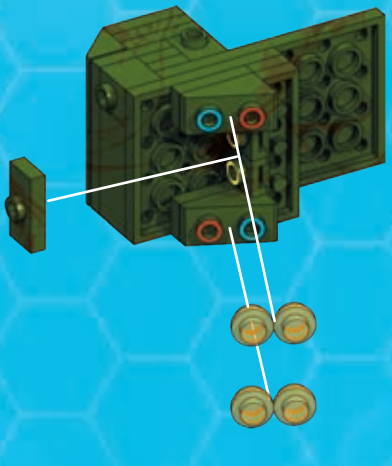

3



4

13

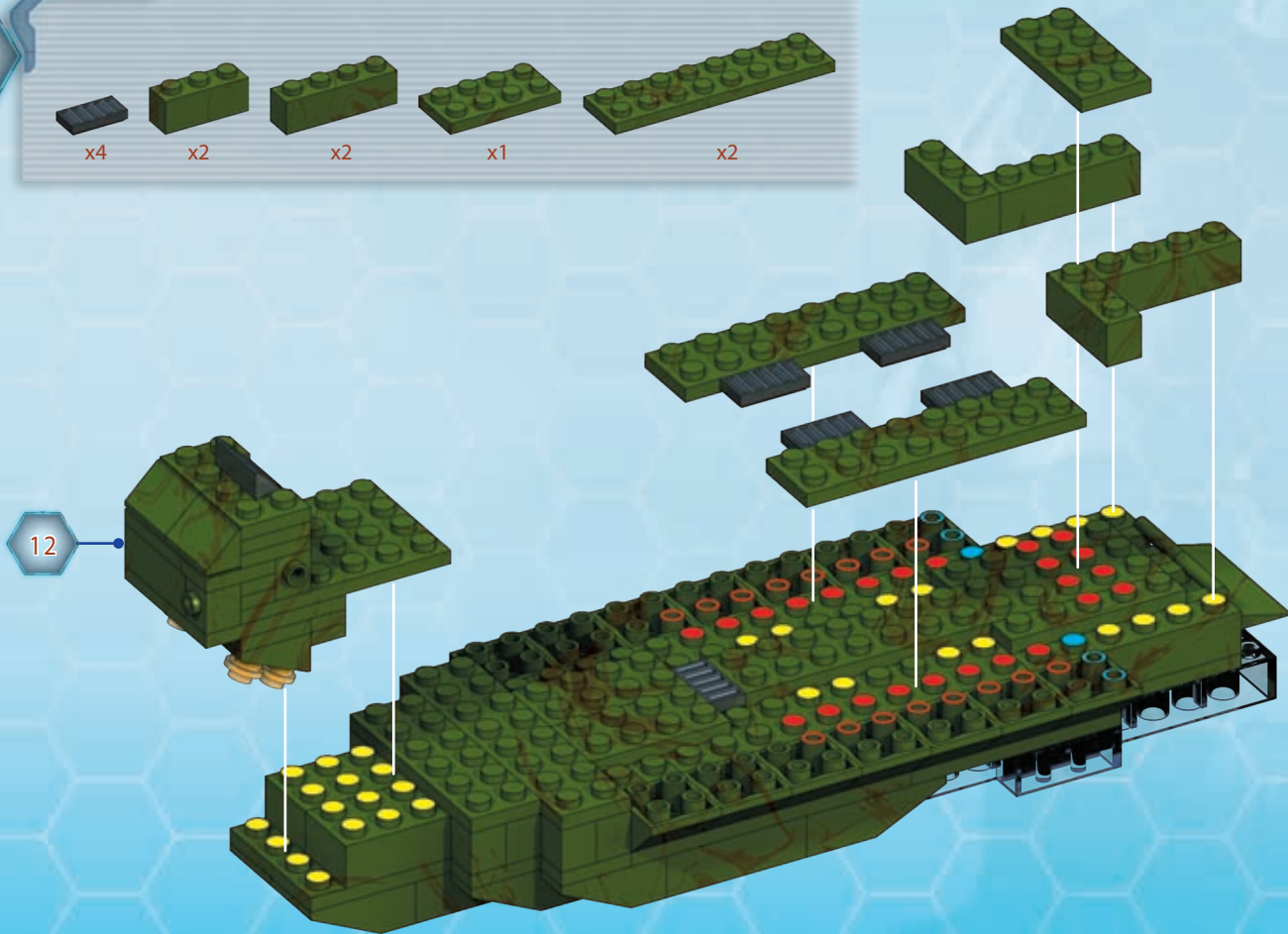
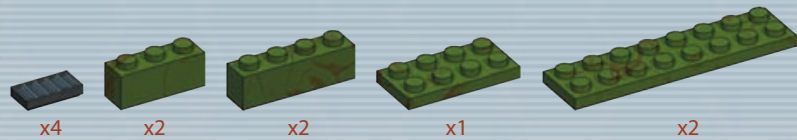

14

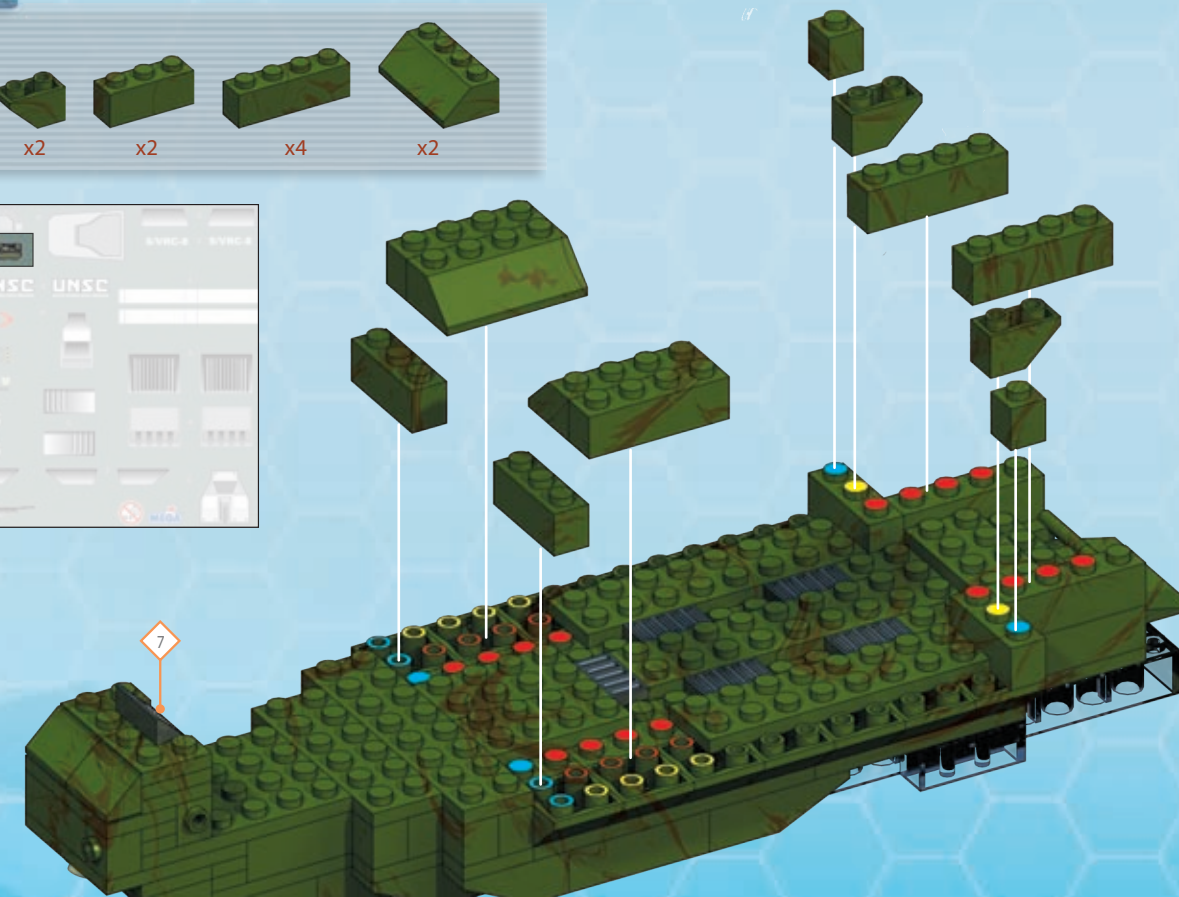
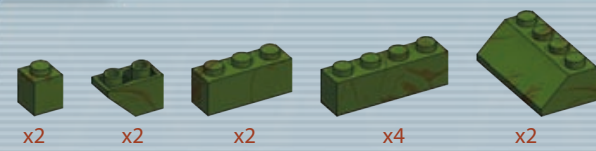

15

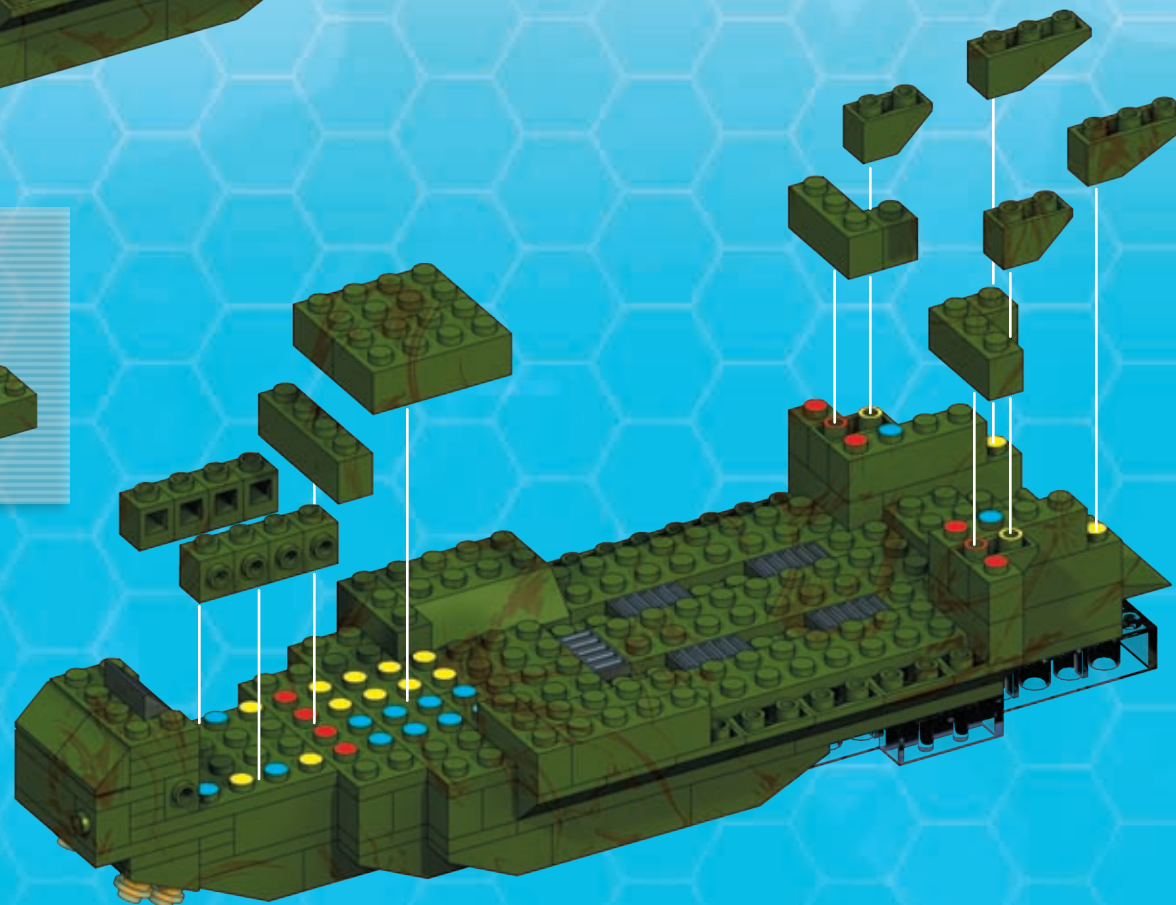
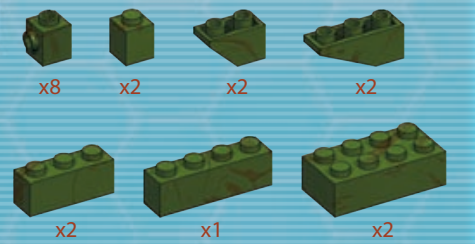

16

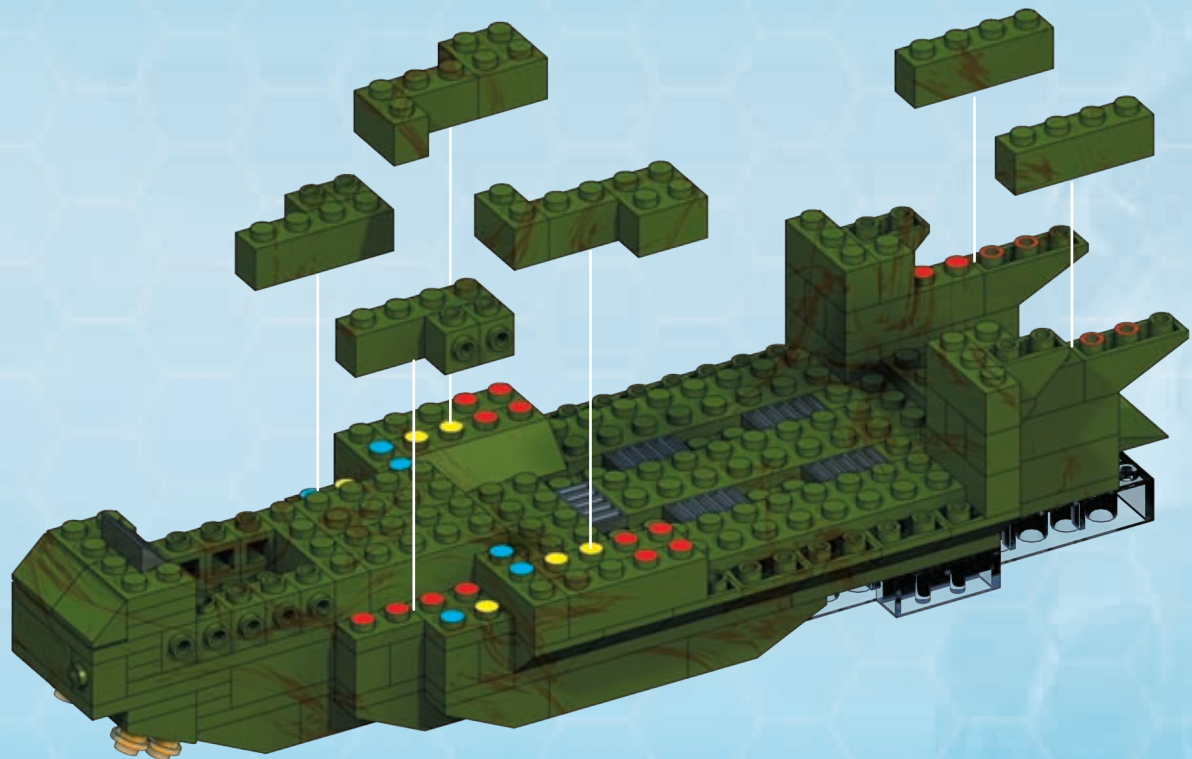

17

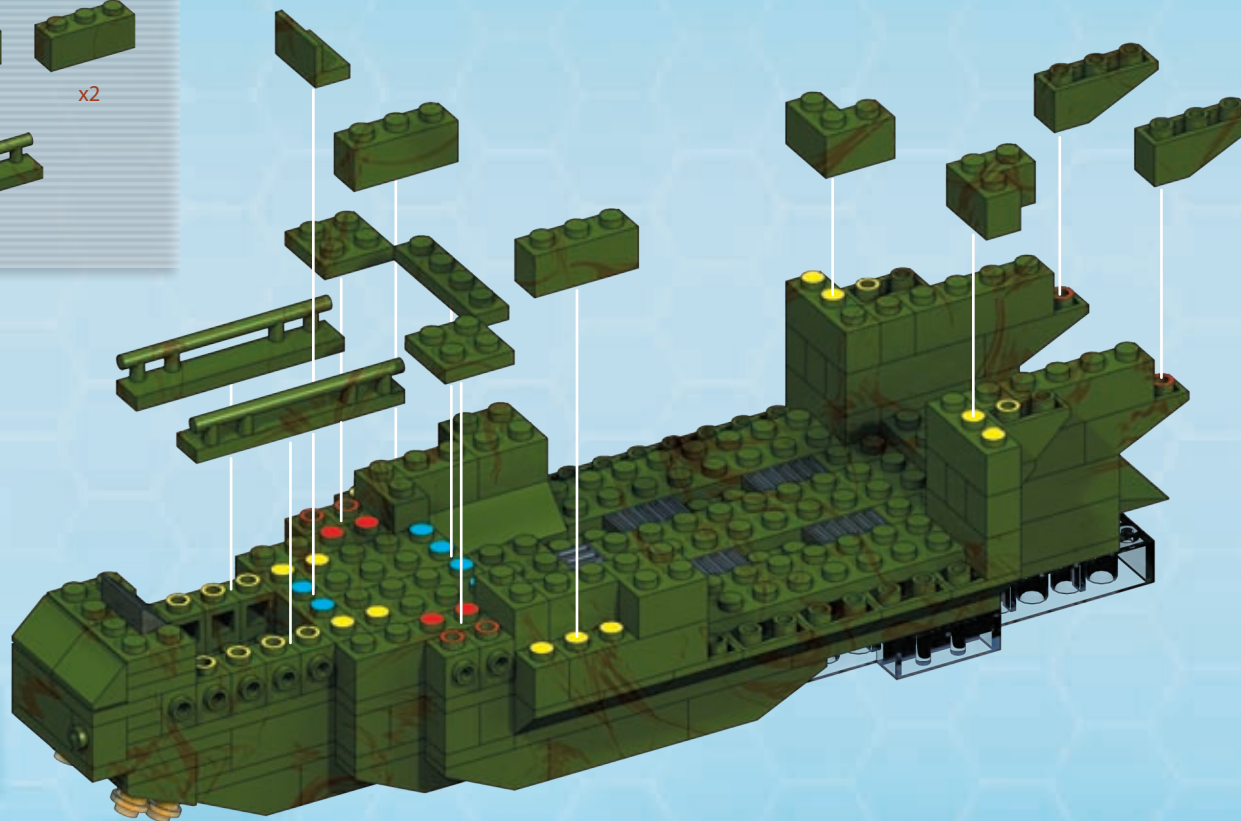
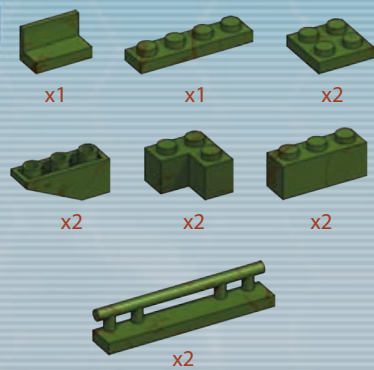

18

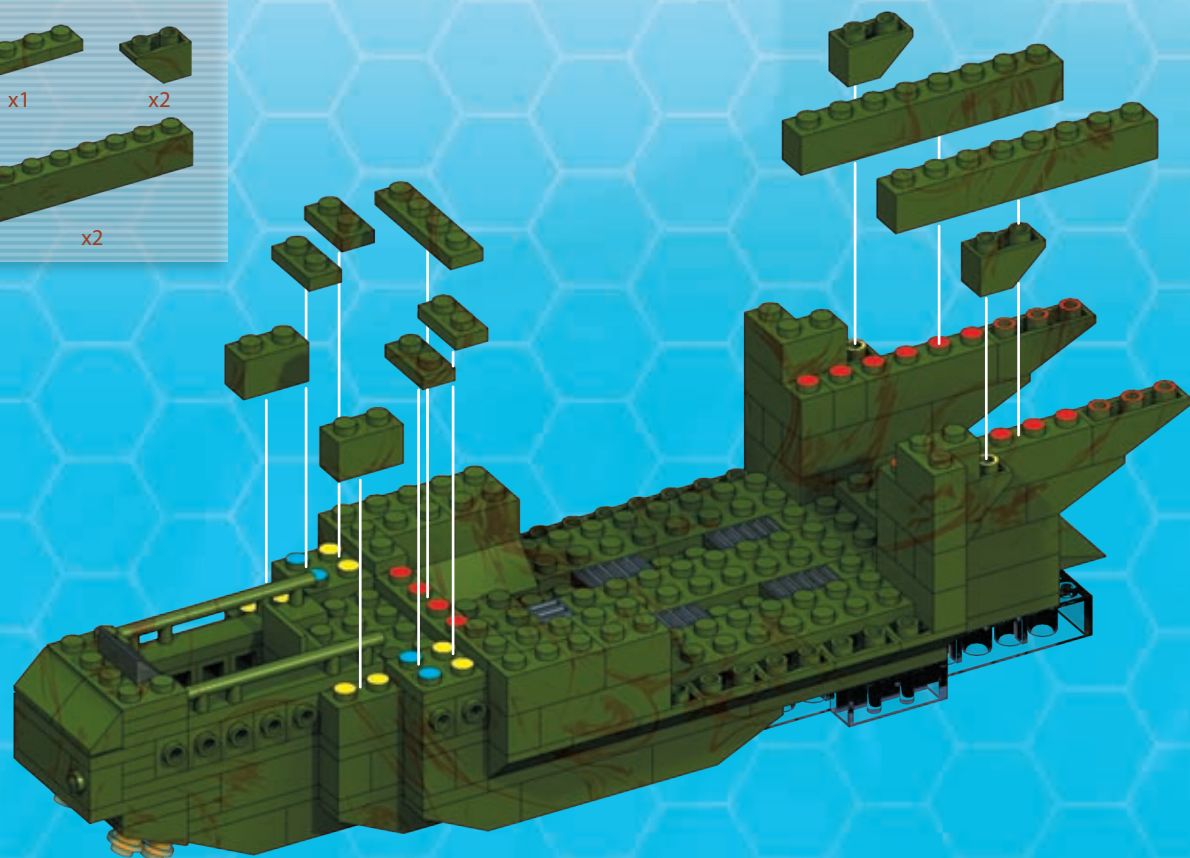
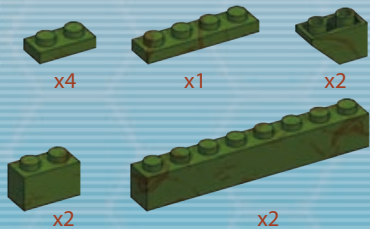

19

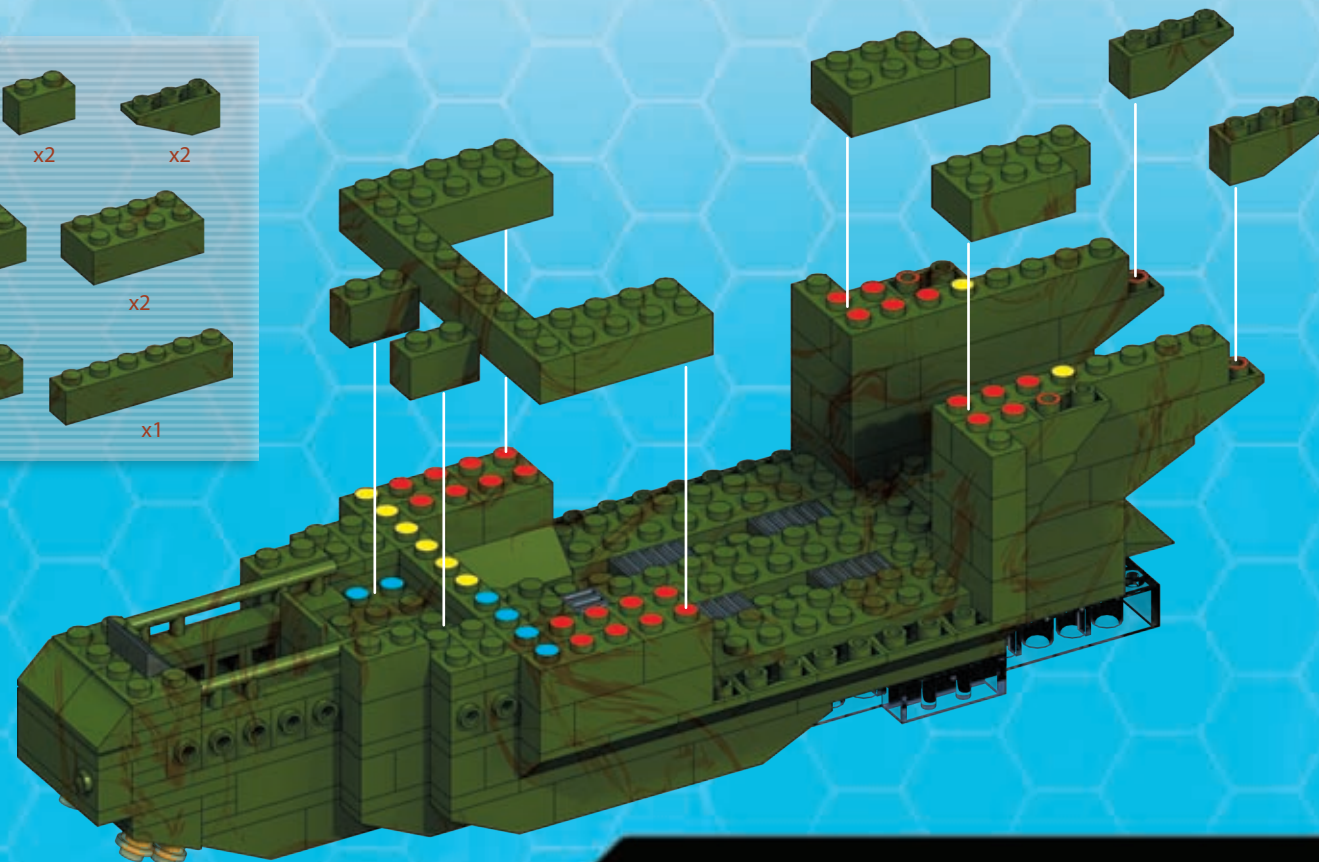
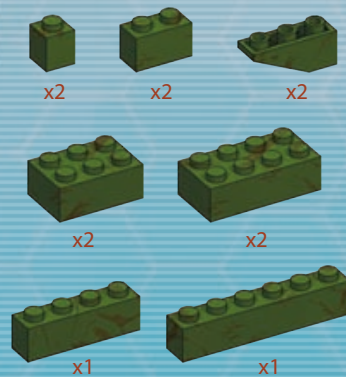

20

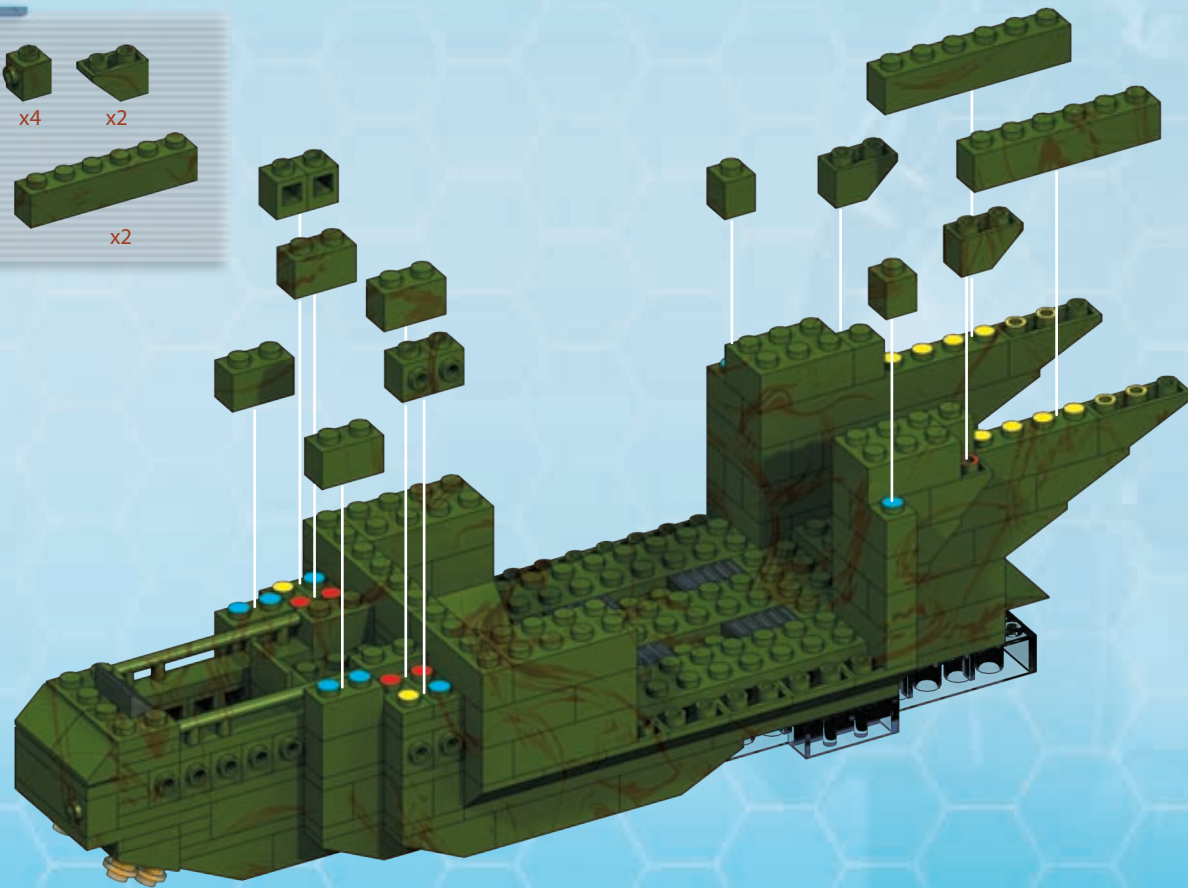
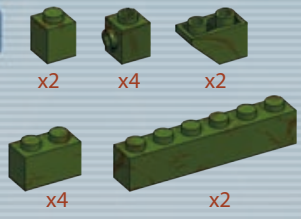

21

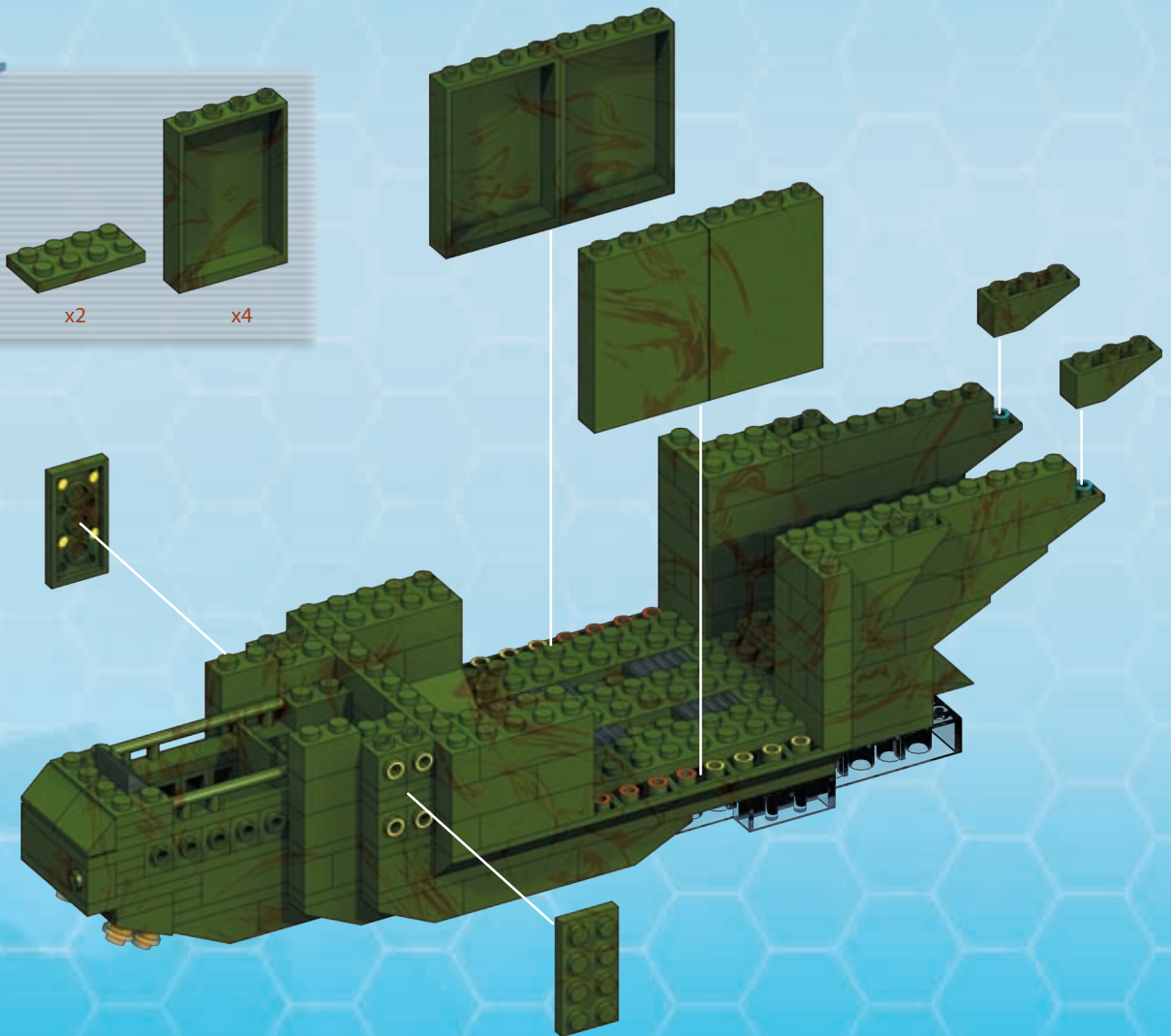
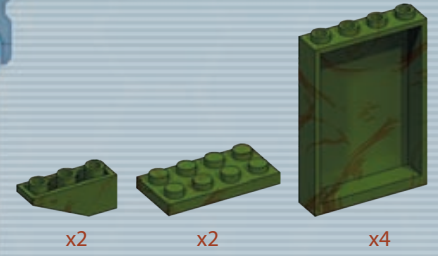

22

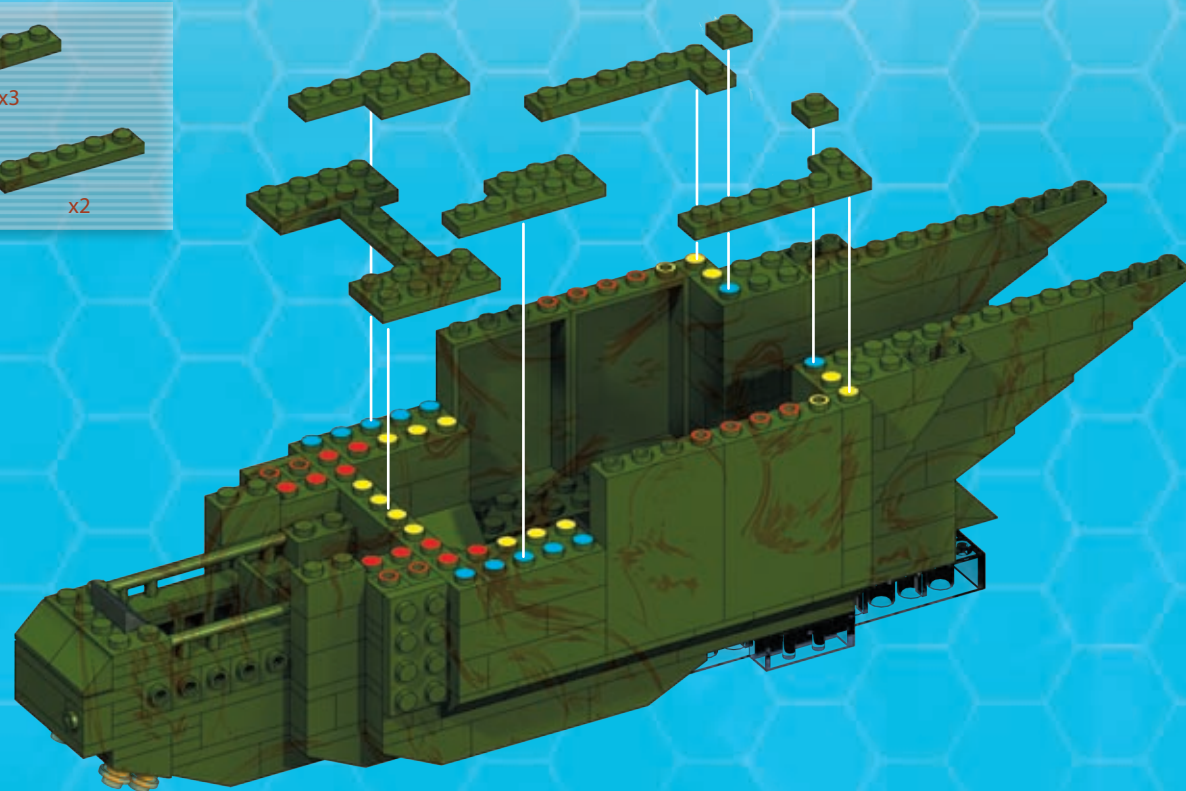

23

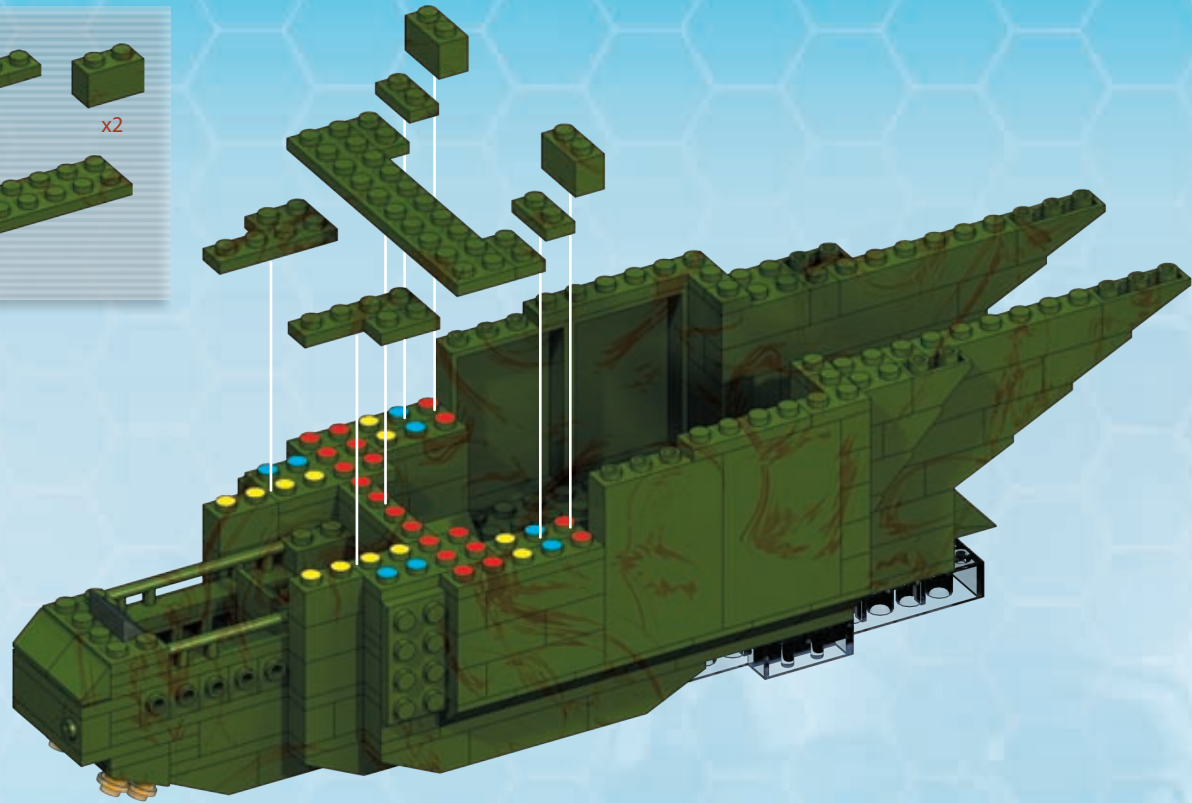
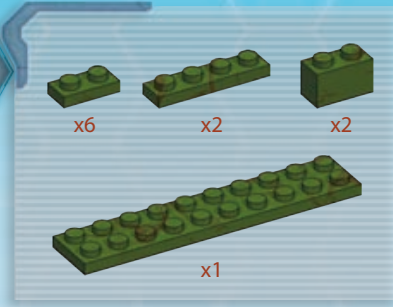

24

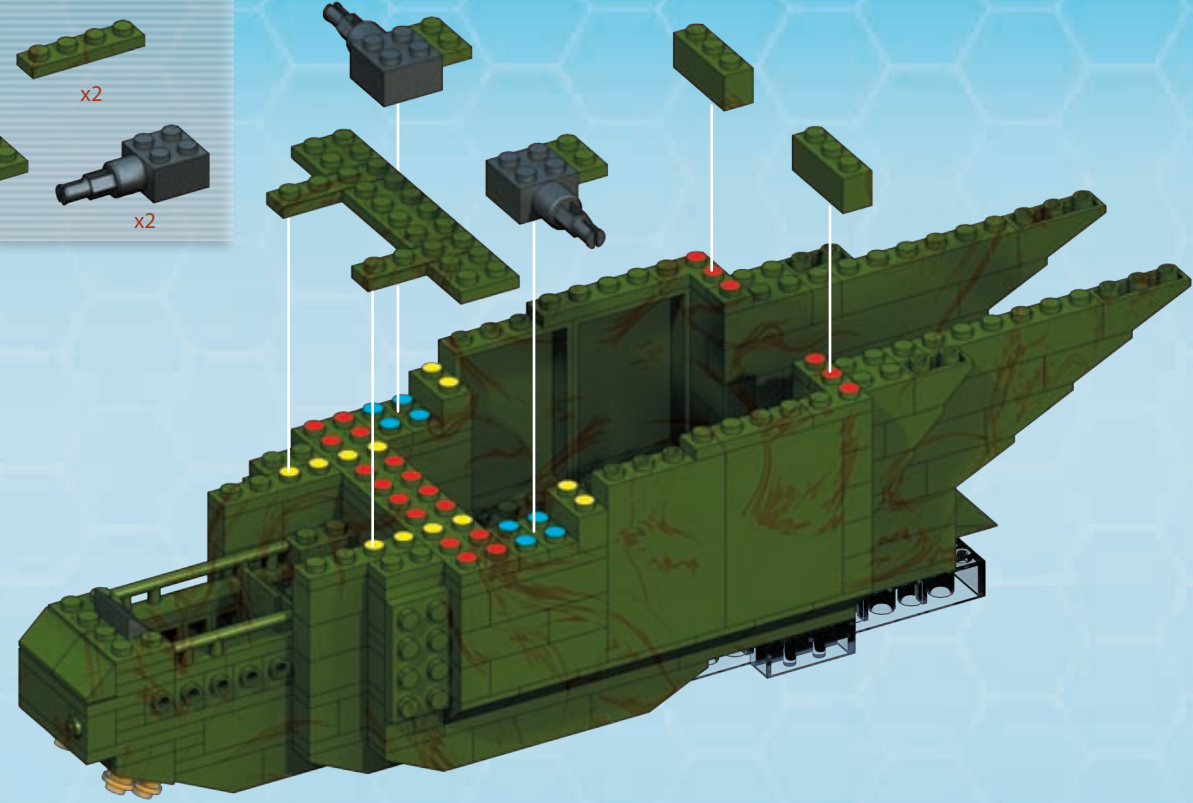

25

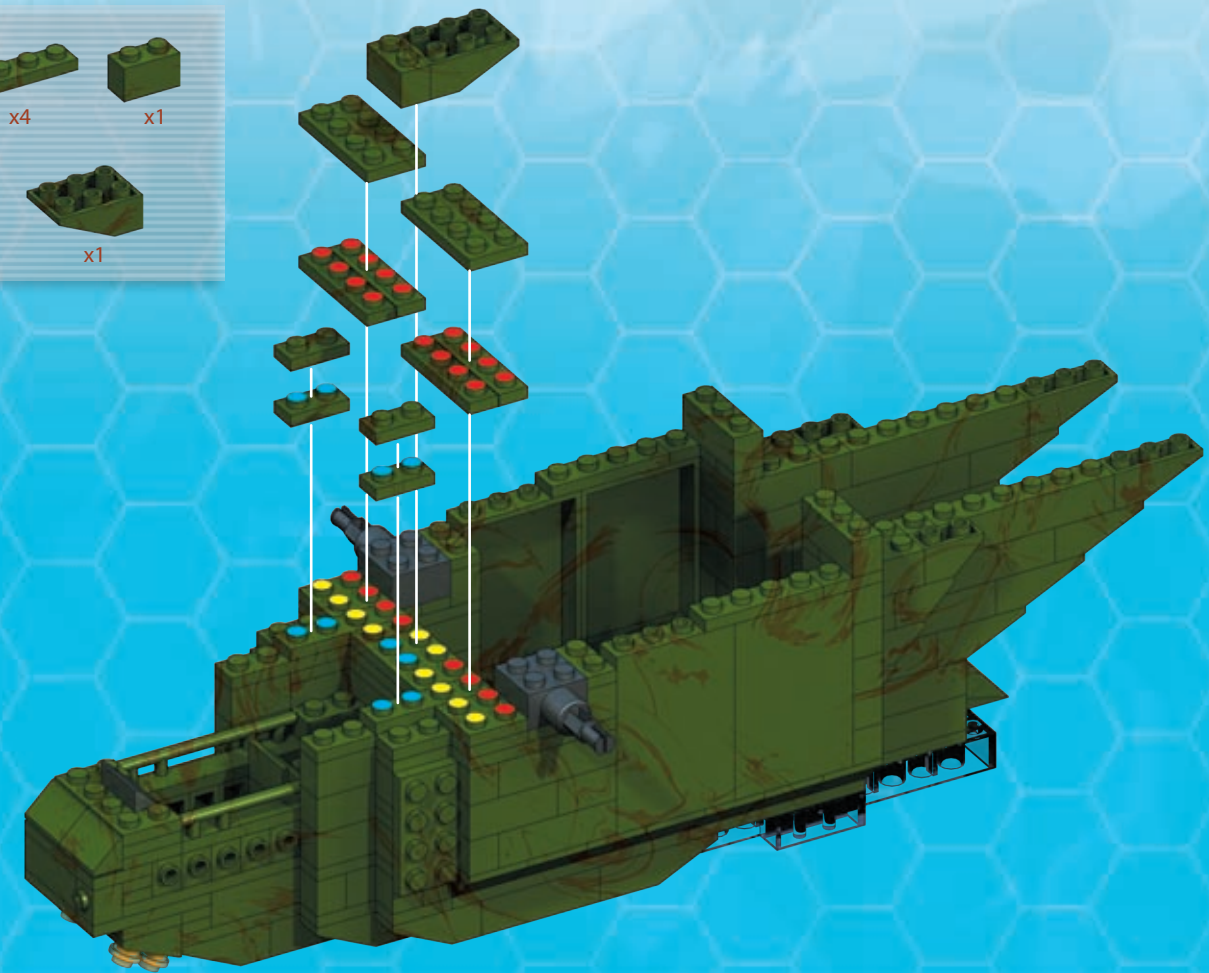

26

- x2
- x2
- x4
- x2

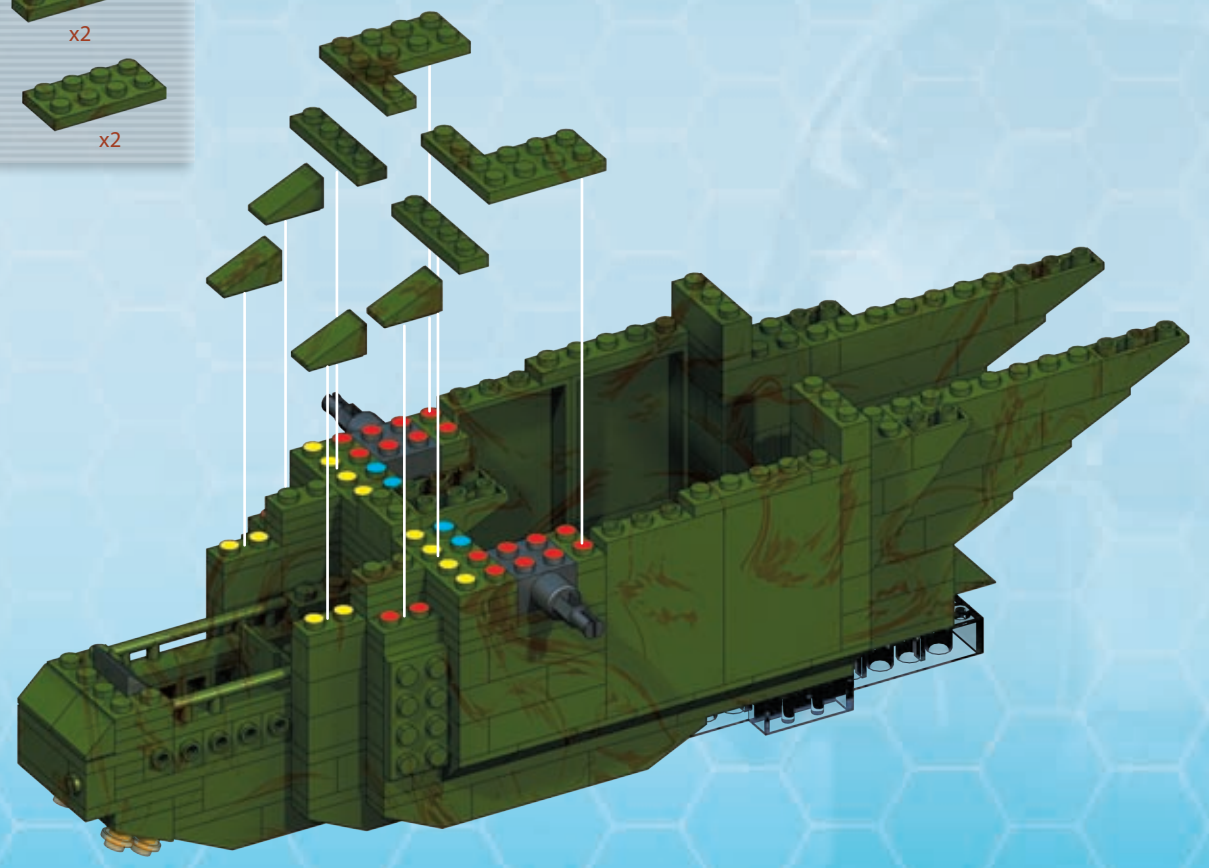

27

- x2
- x2
- x2
- x1

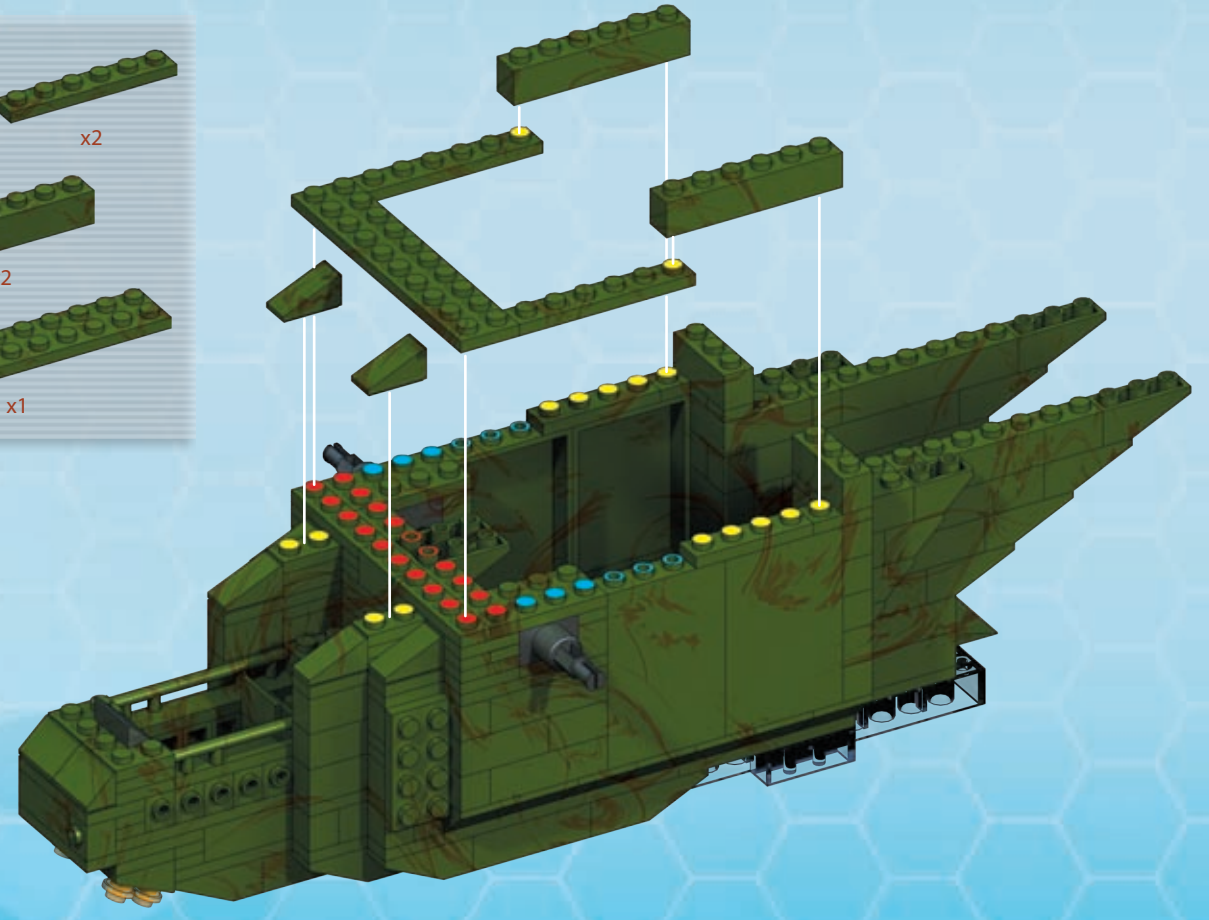

28

- x2
- x2
- x1
- x2
- x1
- x1

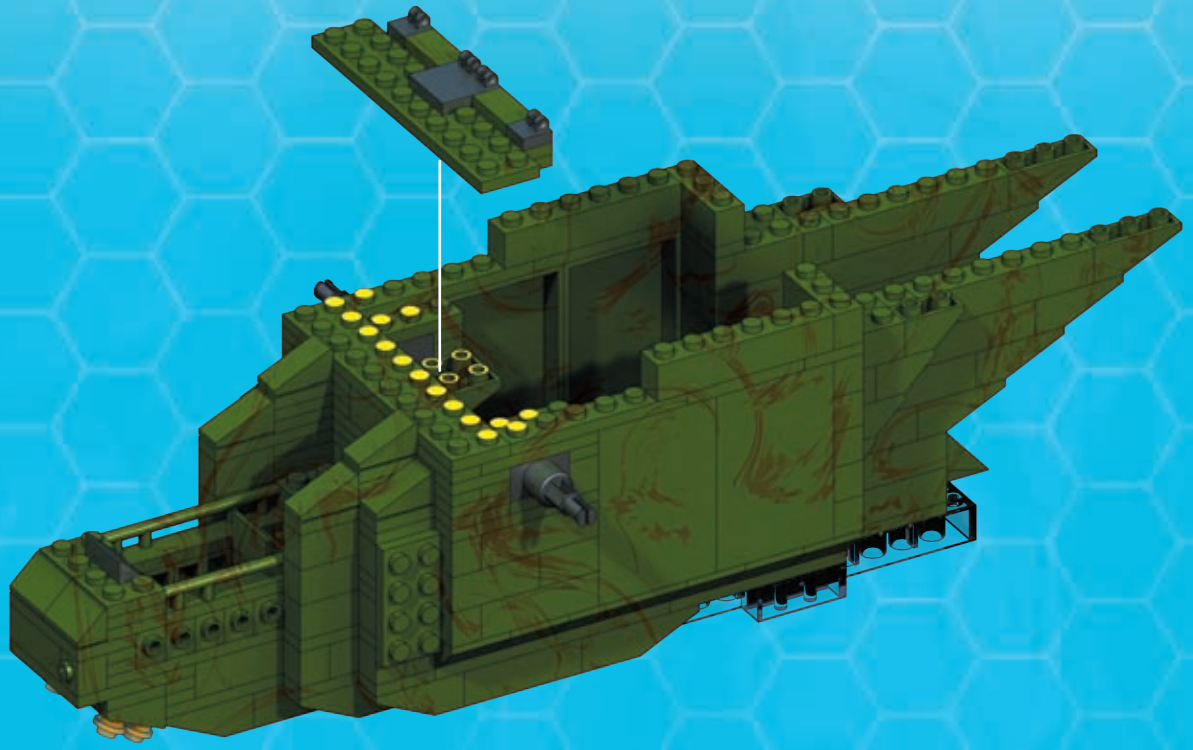
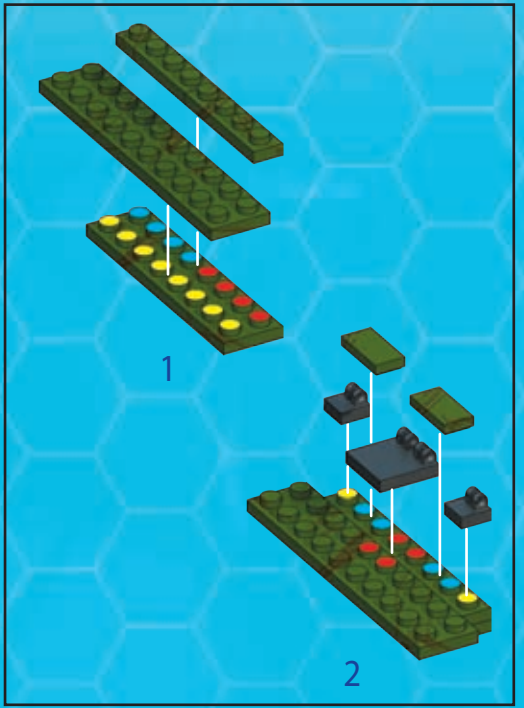

29



x2 x1 x2

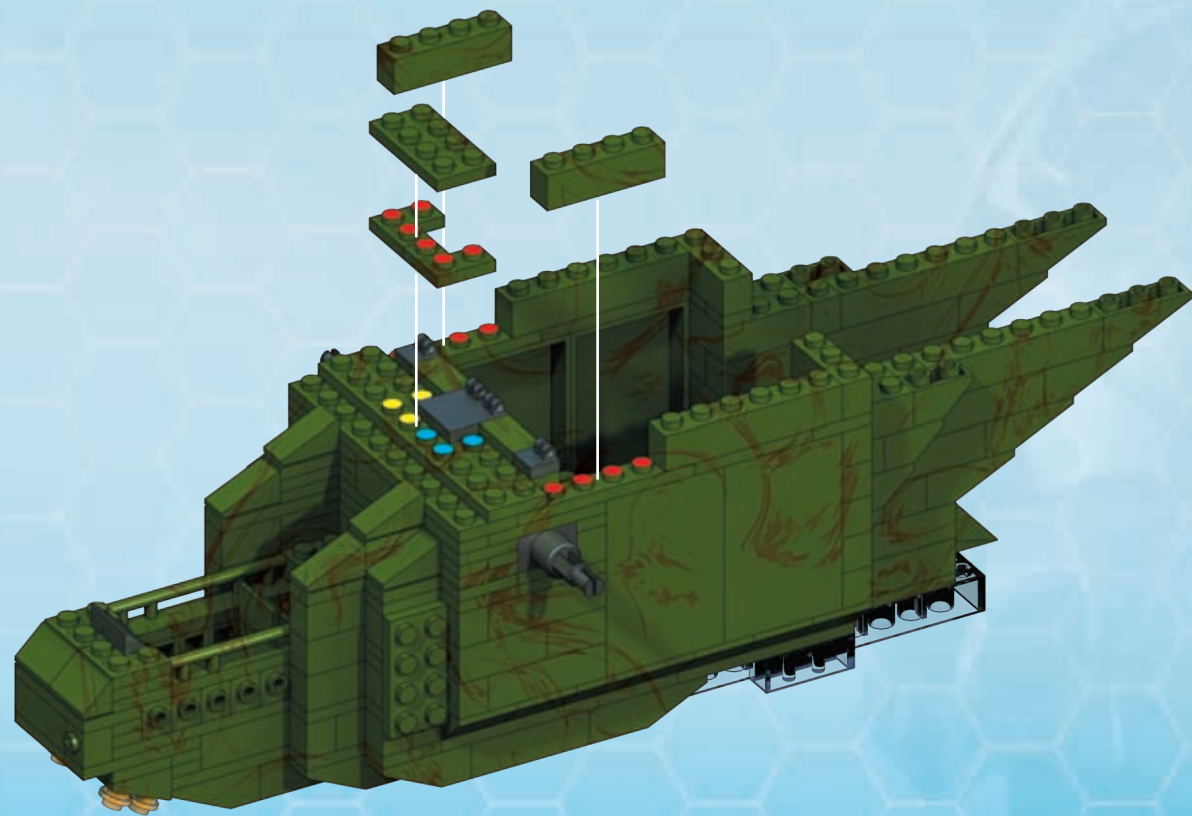

30



x2 x1 x1
x1 x2 x2

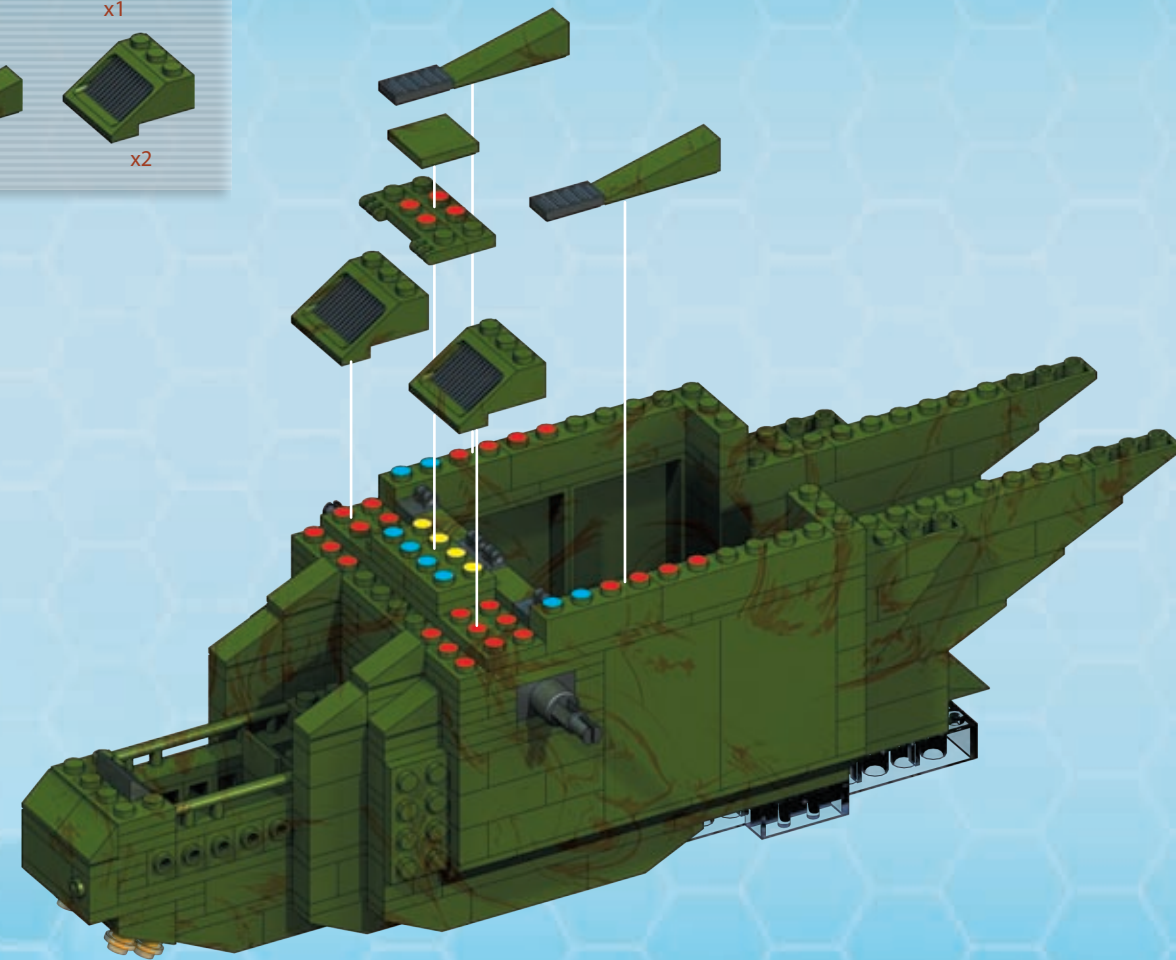

31



x1 x2 x1
x1 x1
x1

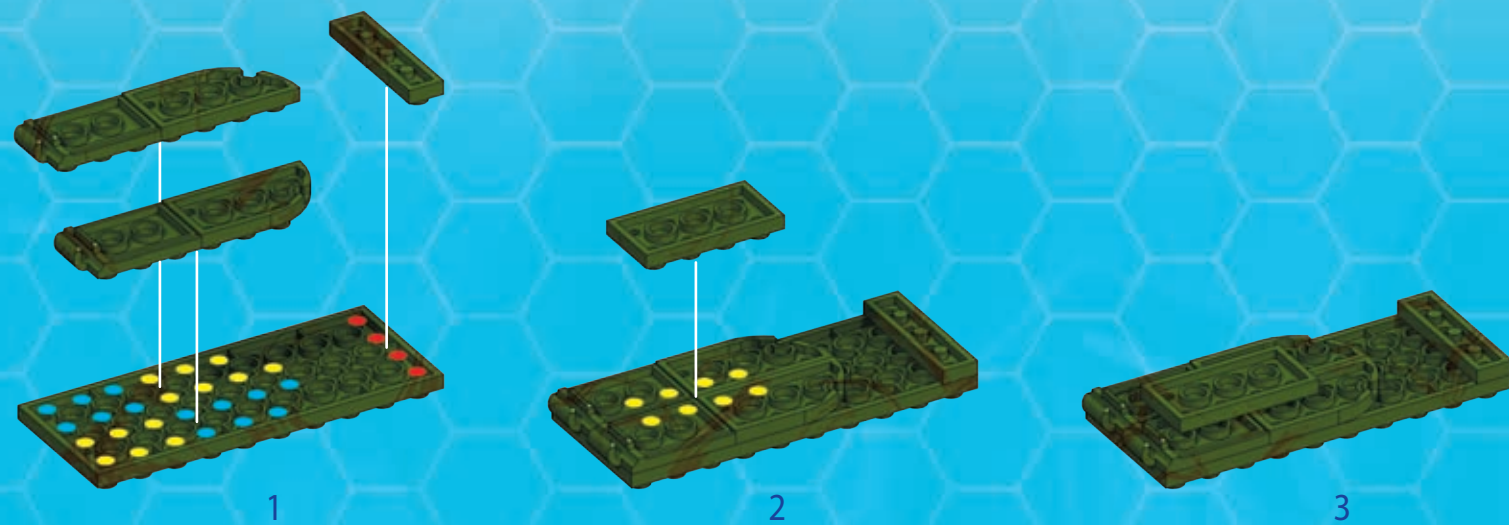

32

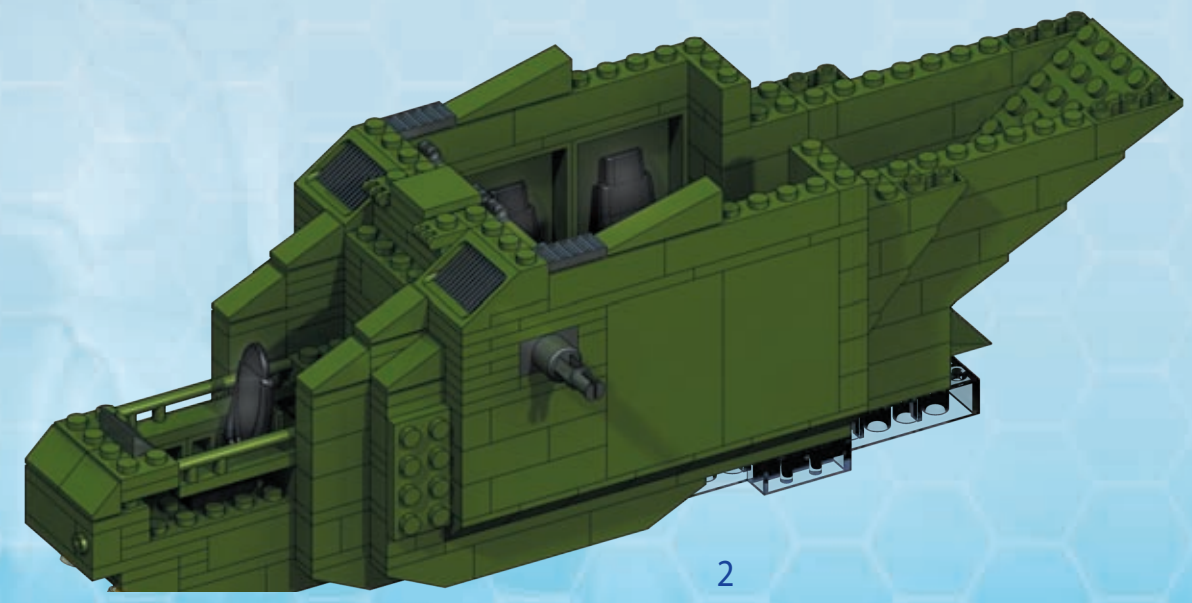
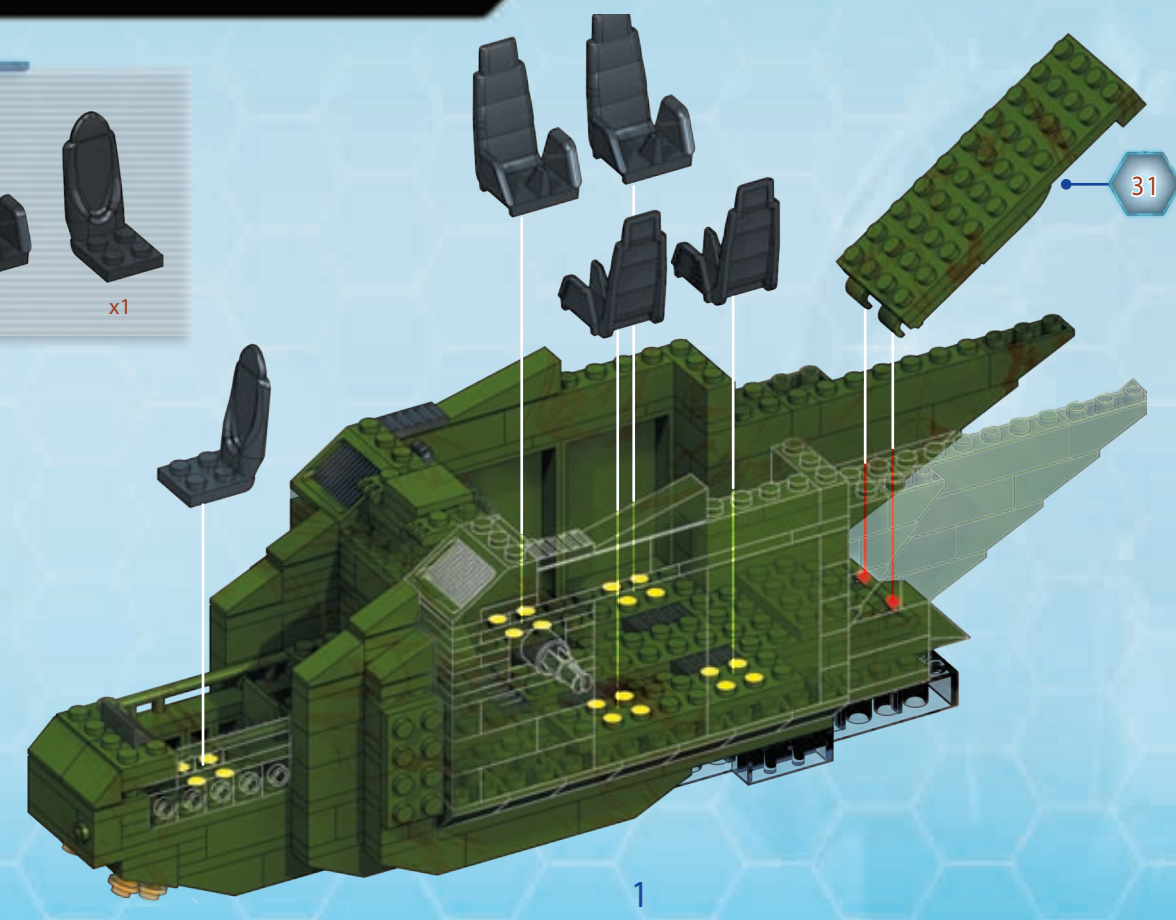

33

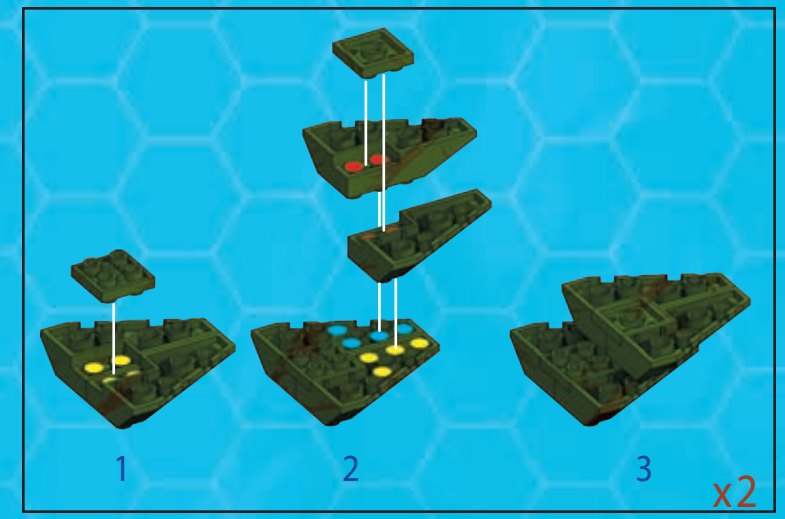
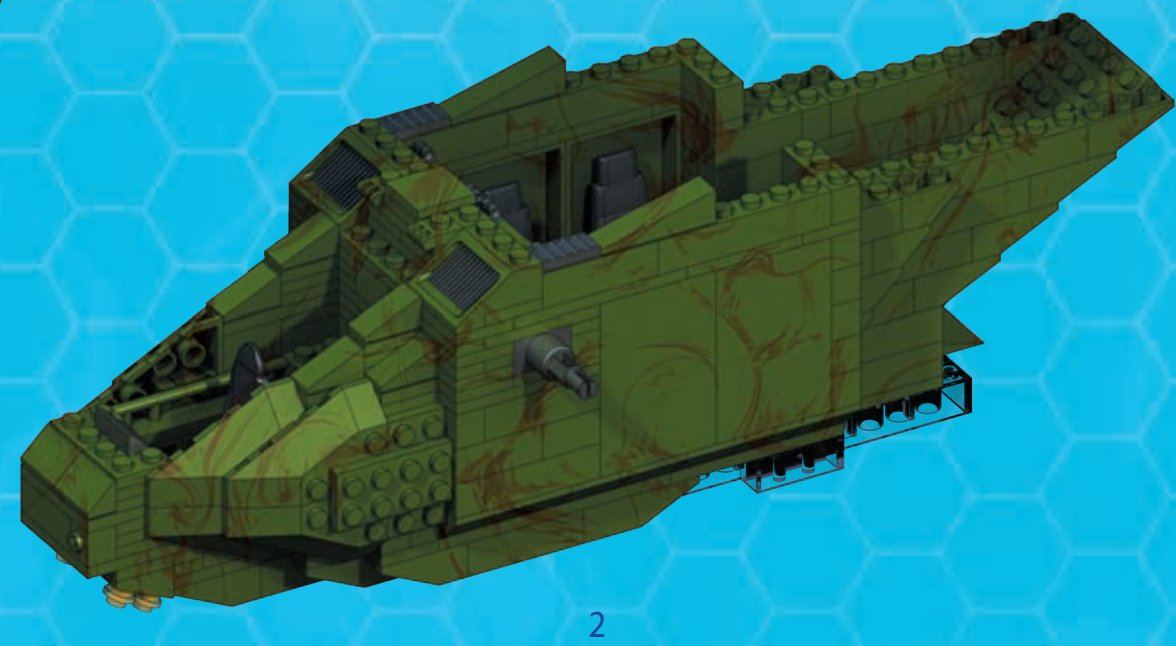
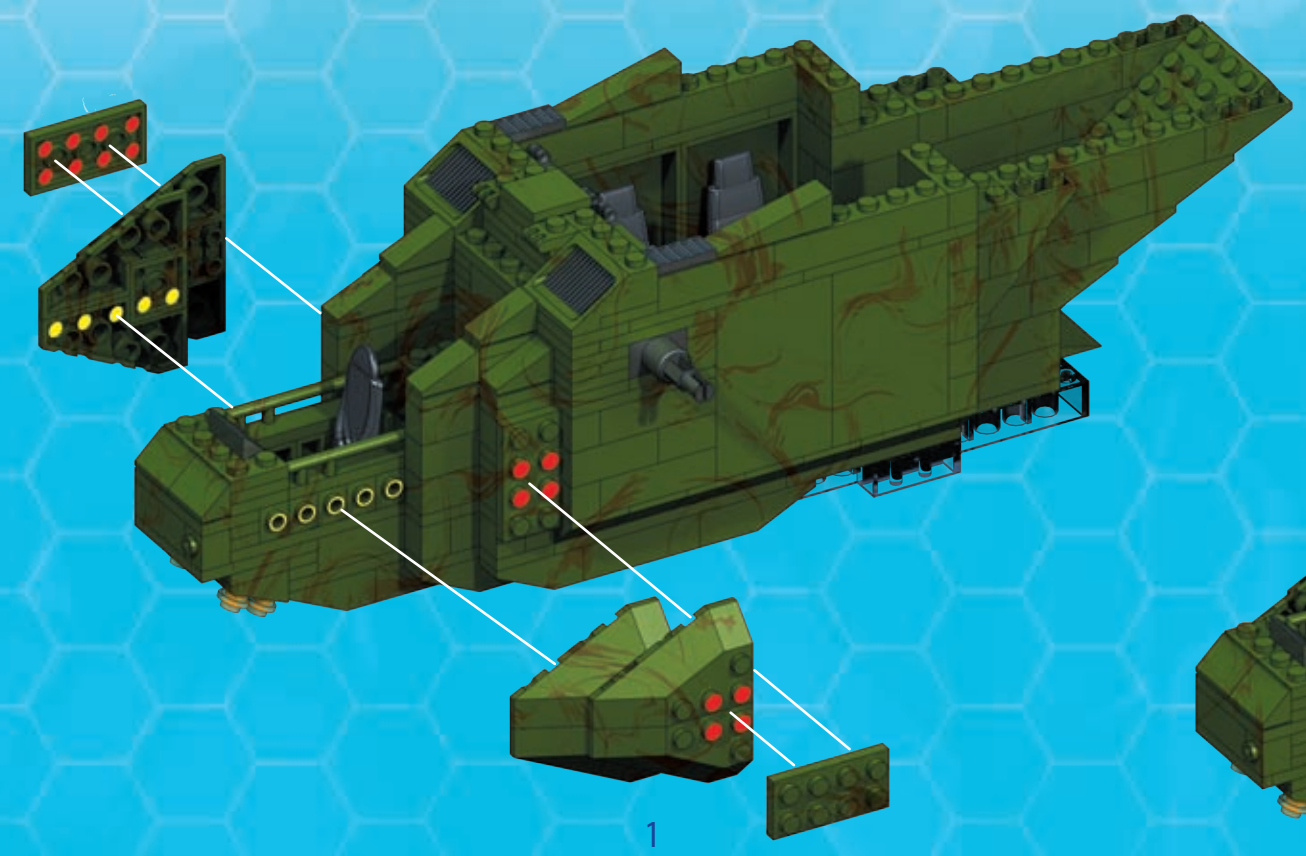



34

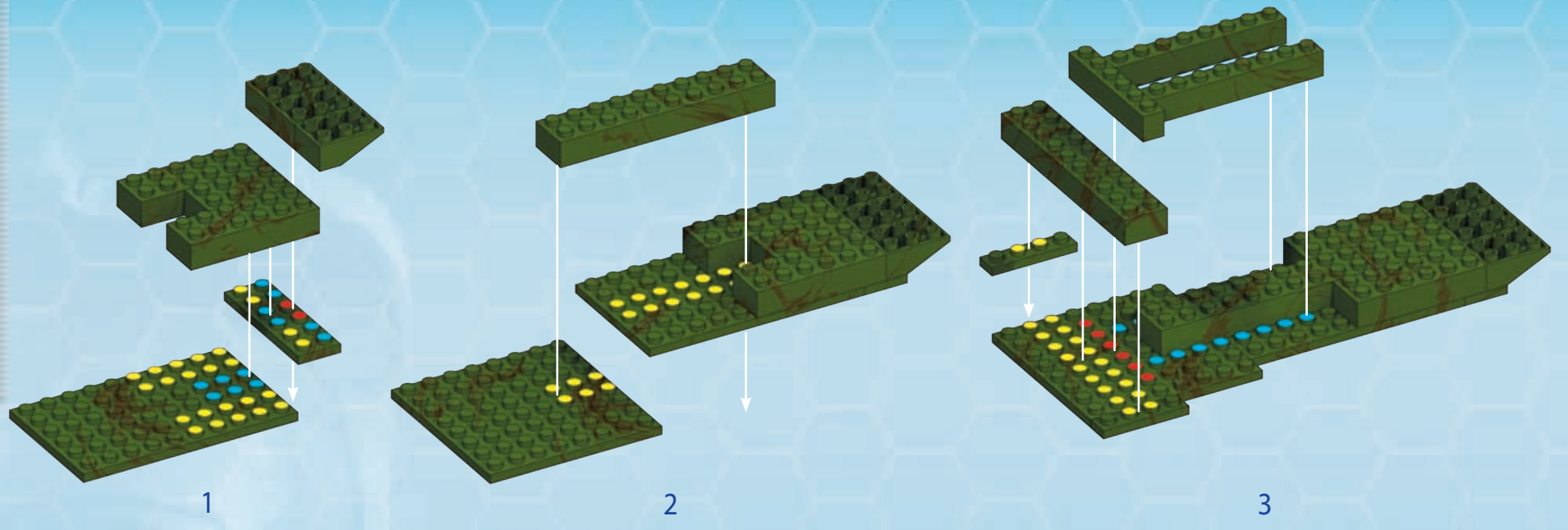
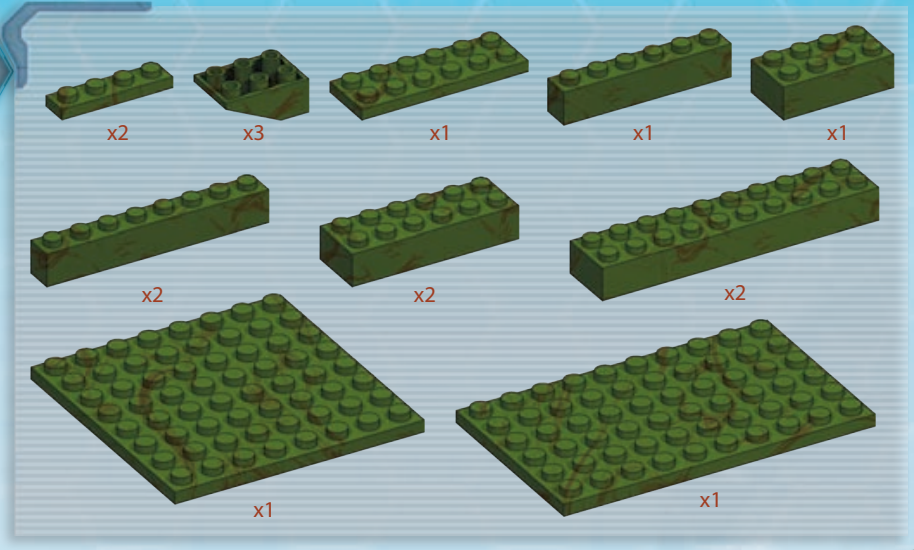

35

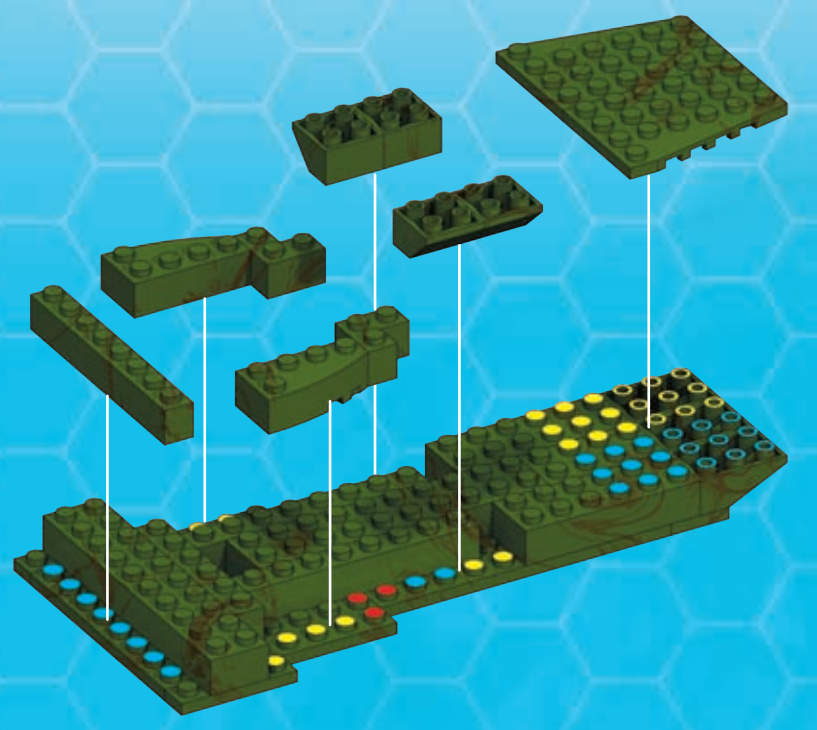
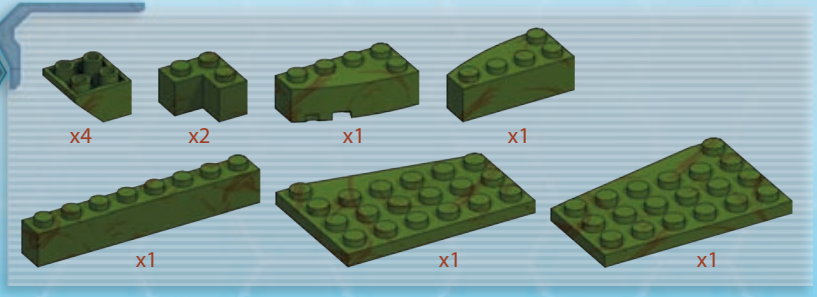

36

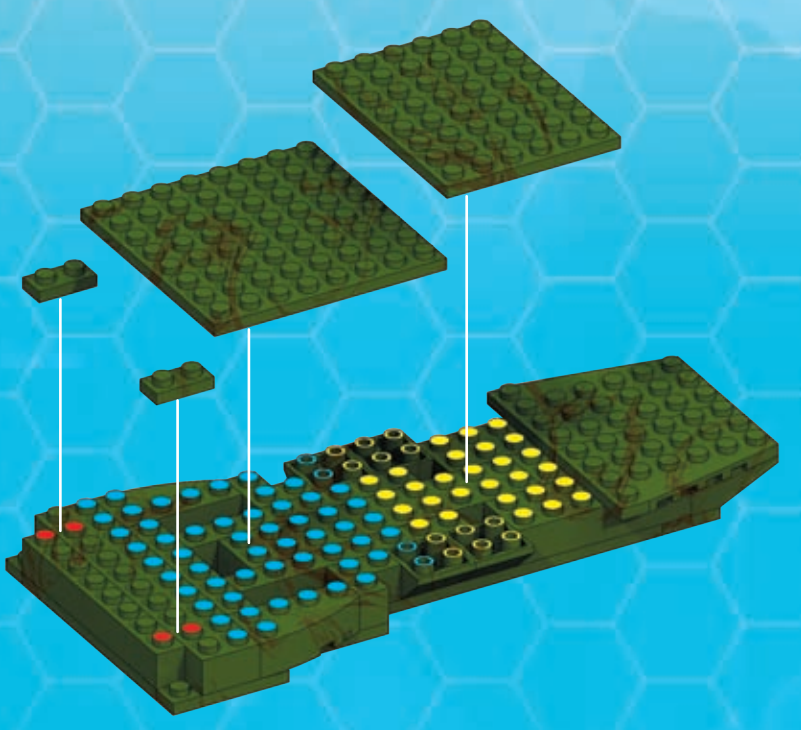
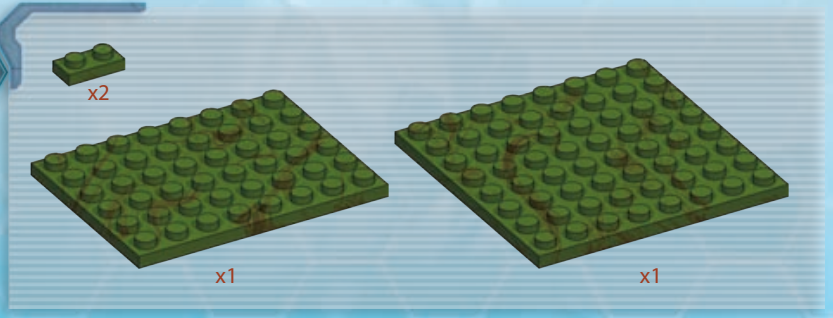

37

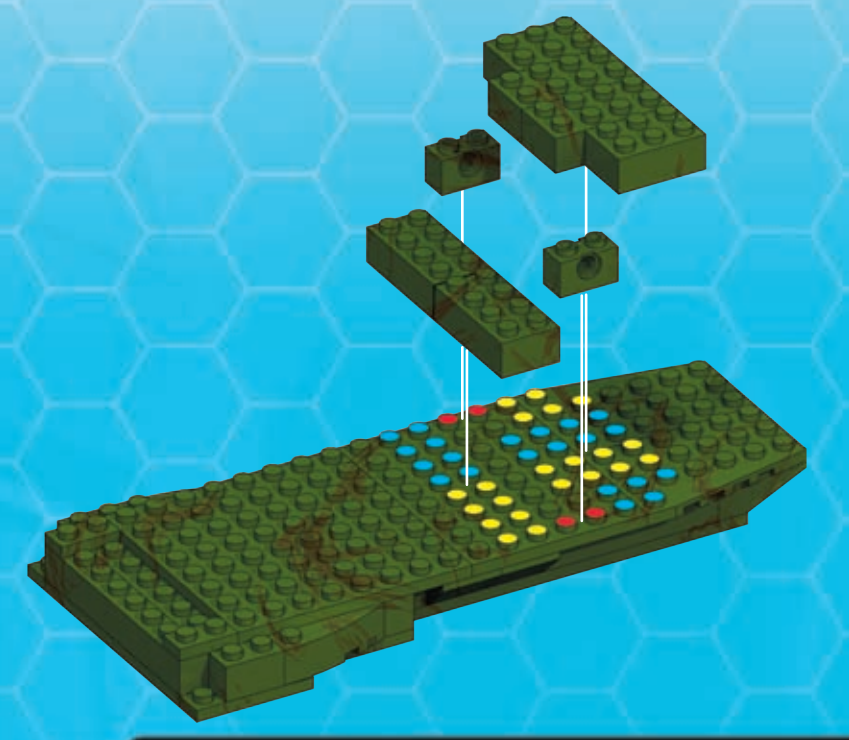

38

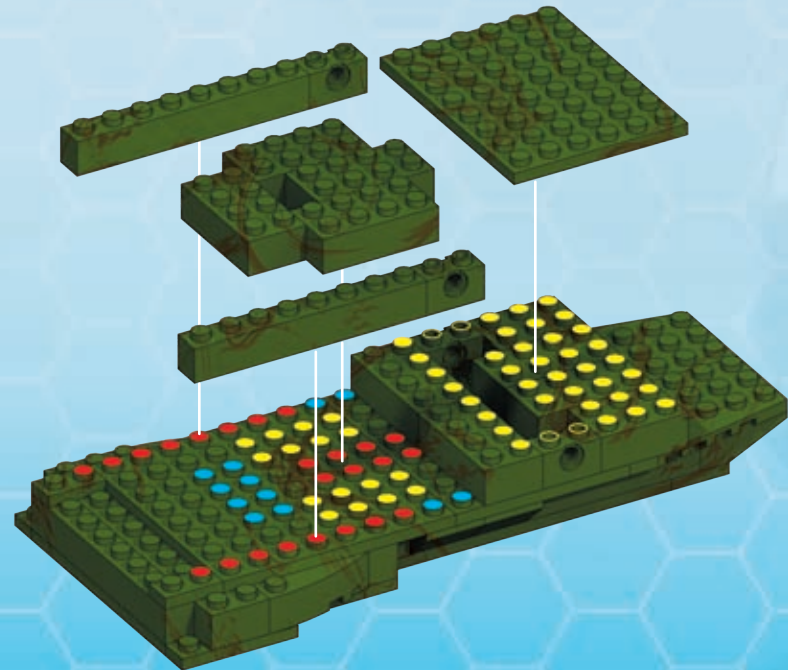
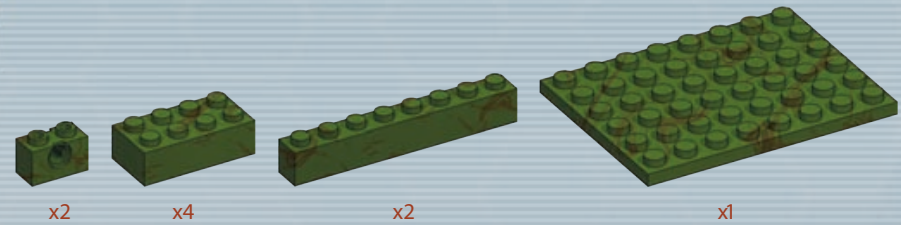

39

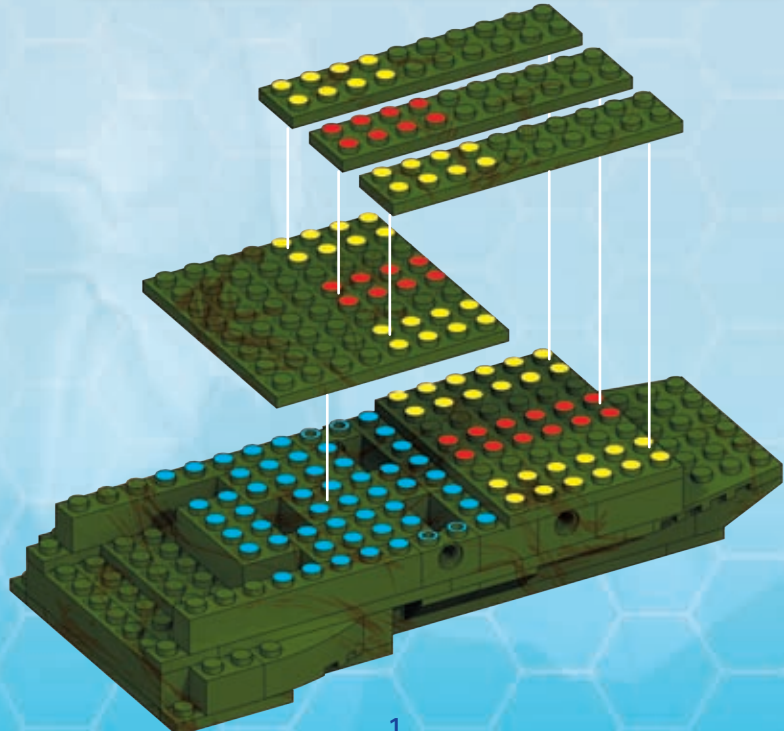
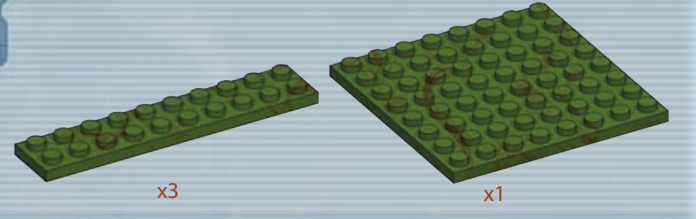

40

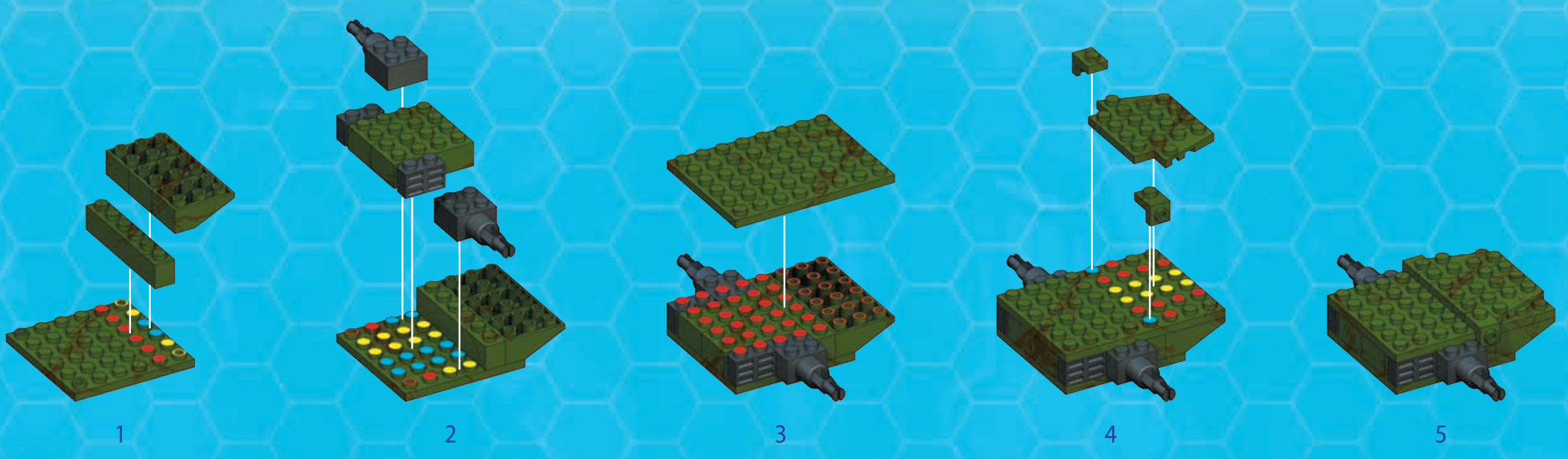

41

40

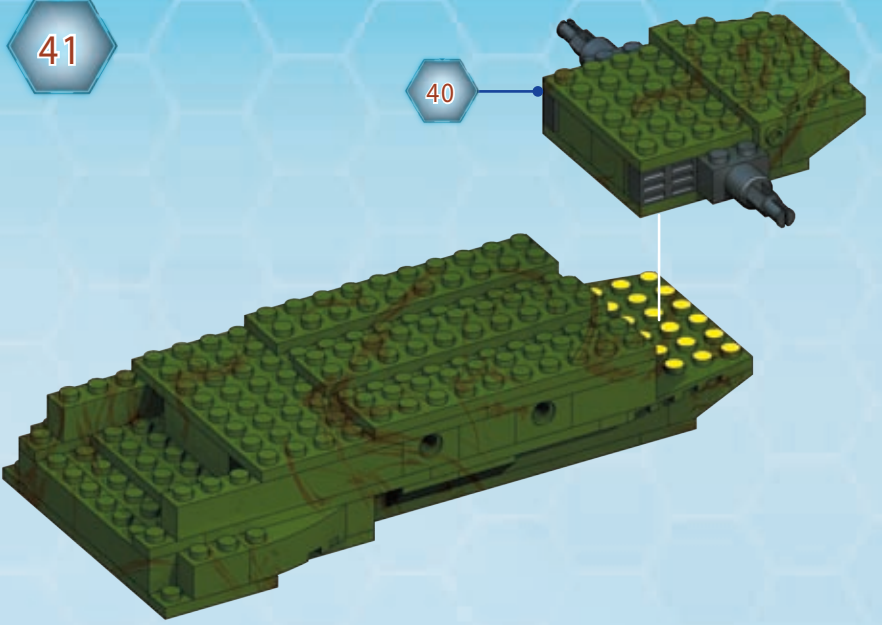

42

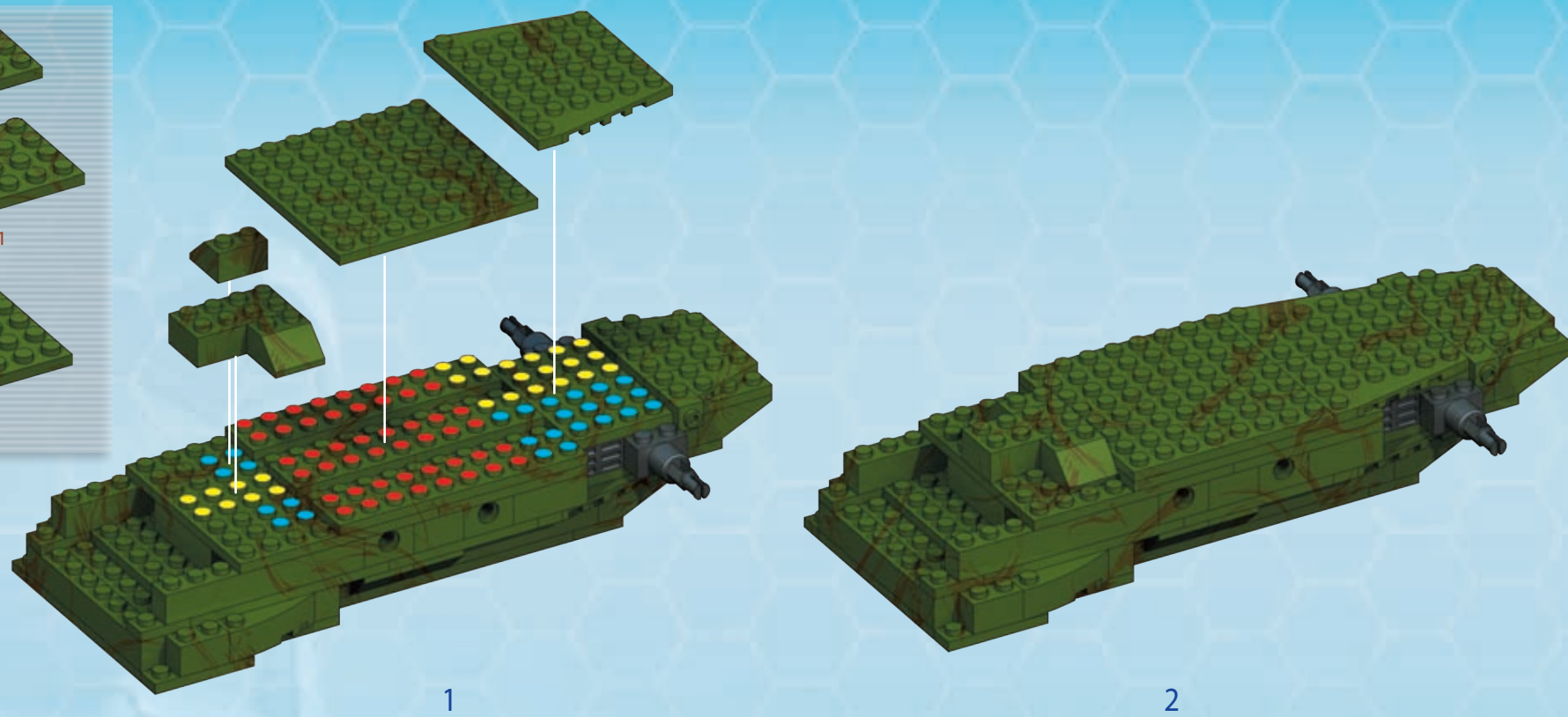

43

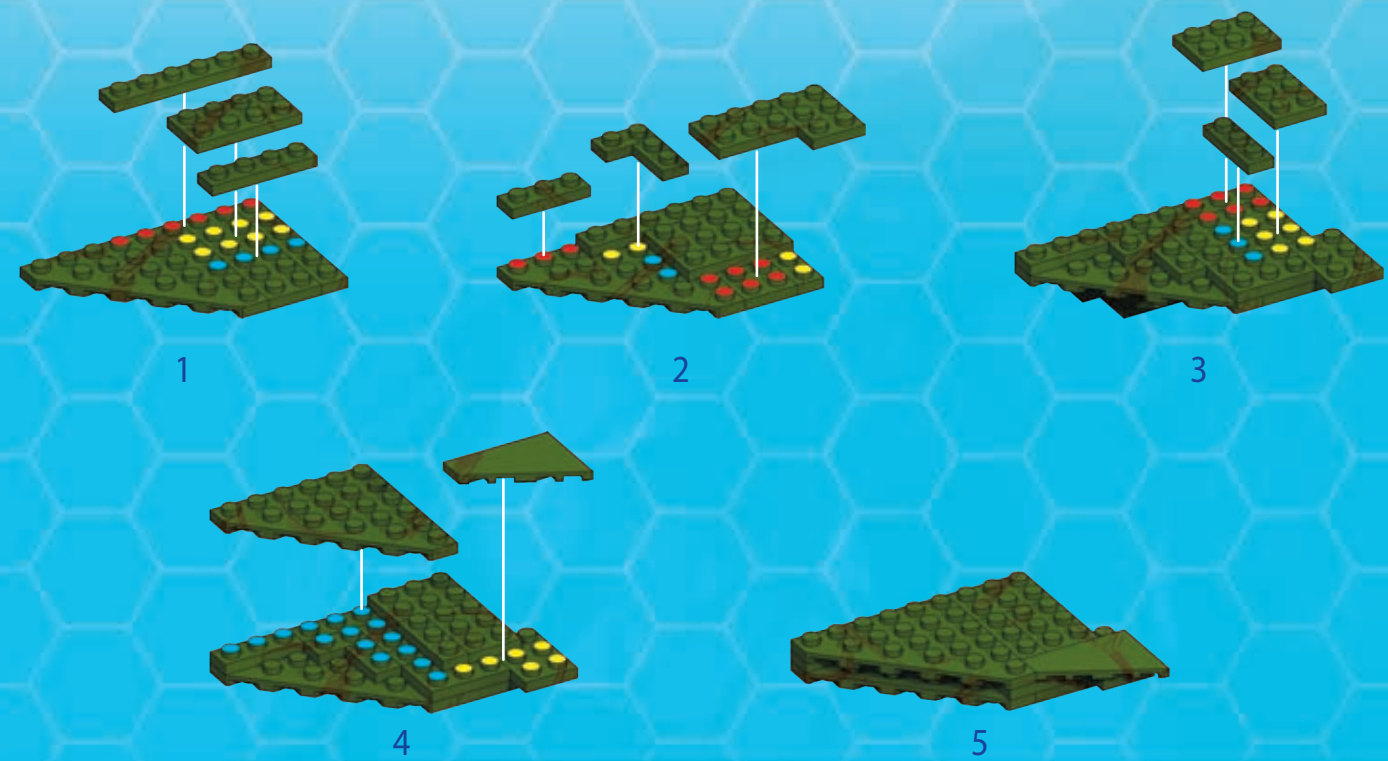
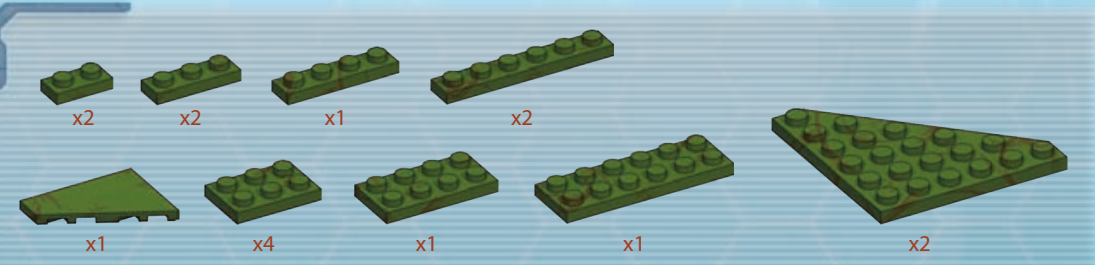

44

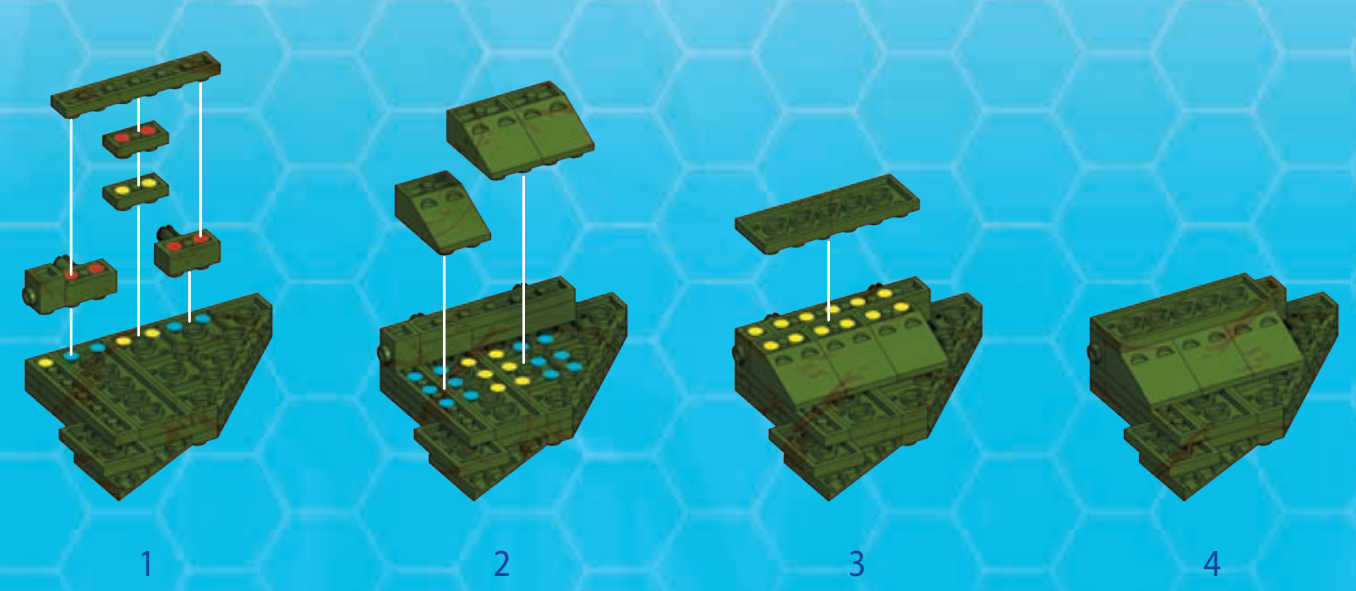

45

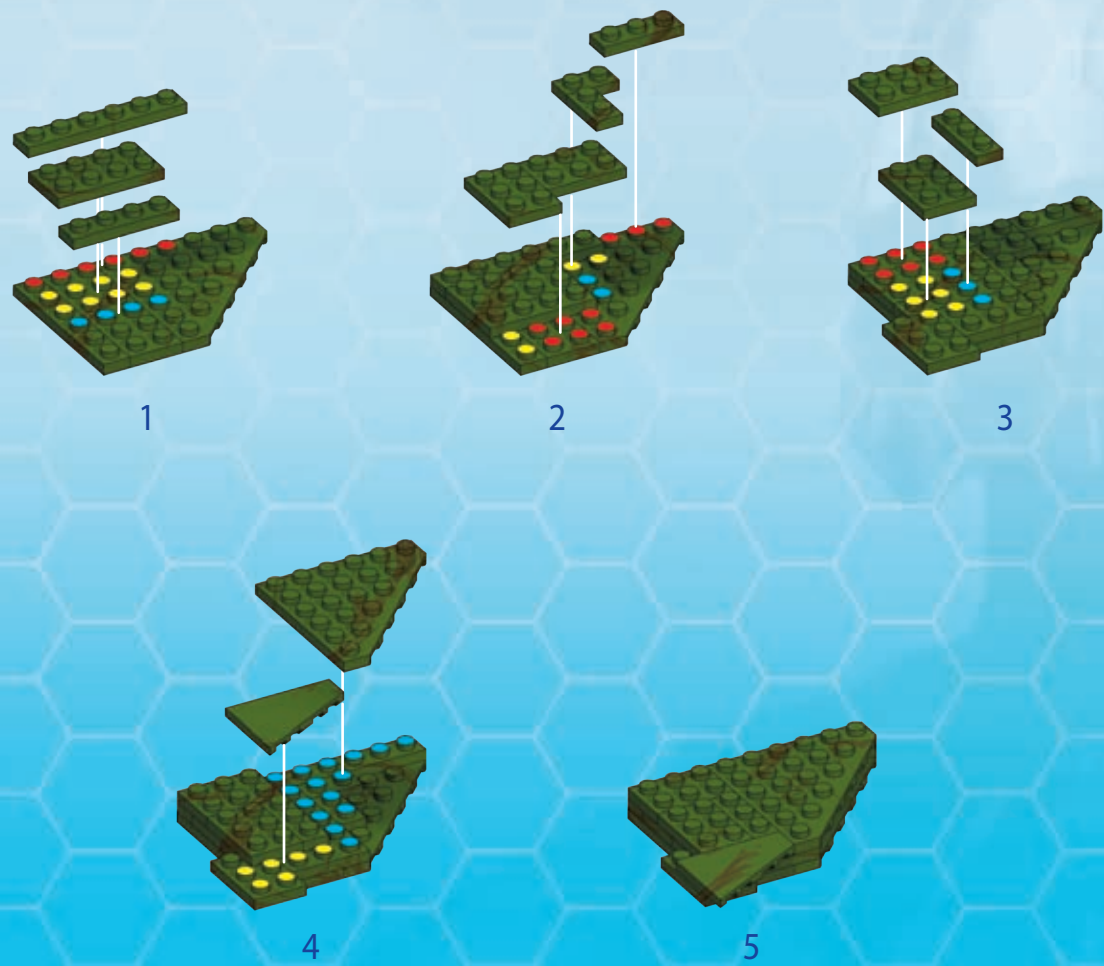
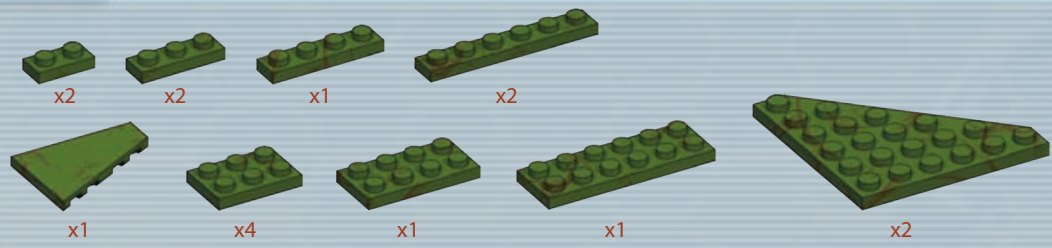

46

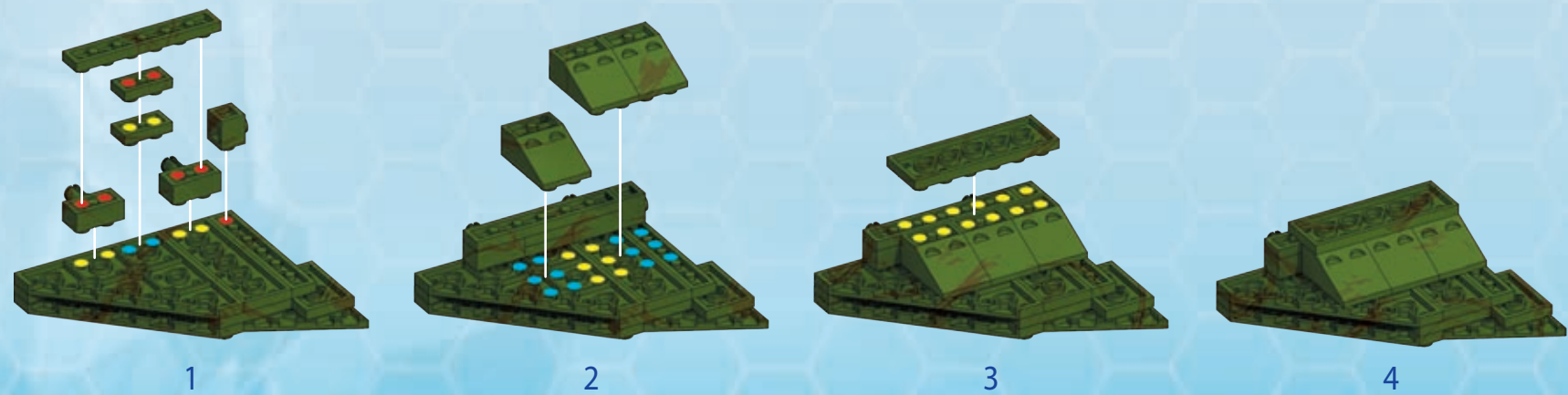
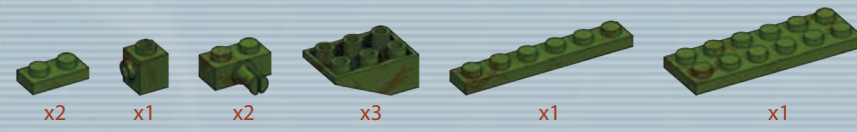

47

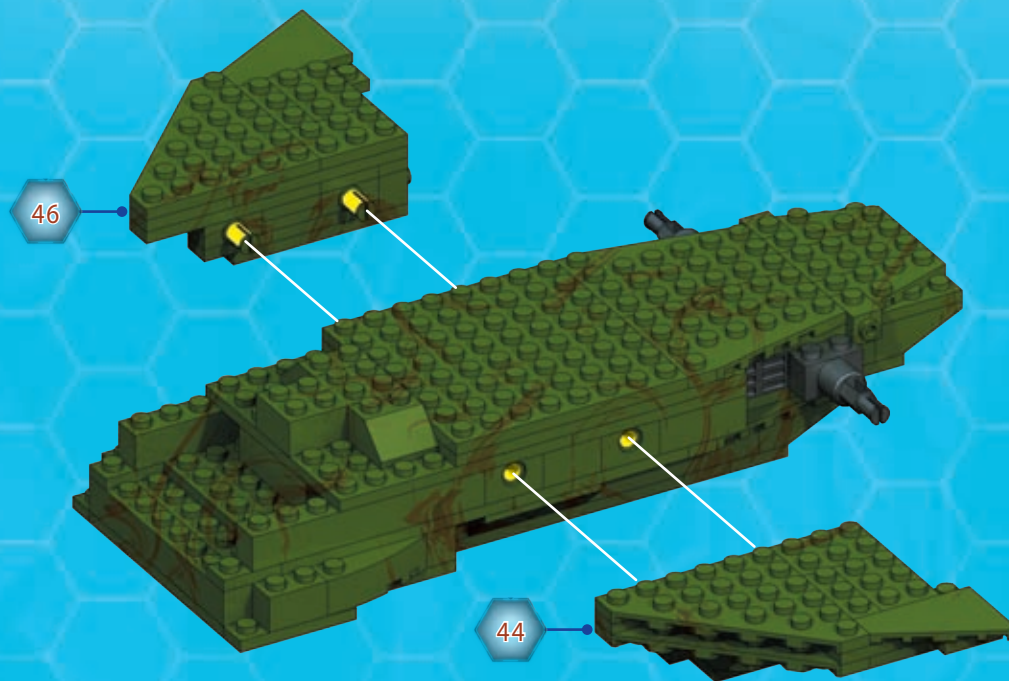

48

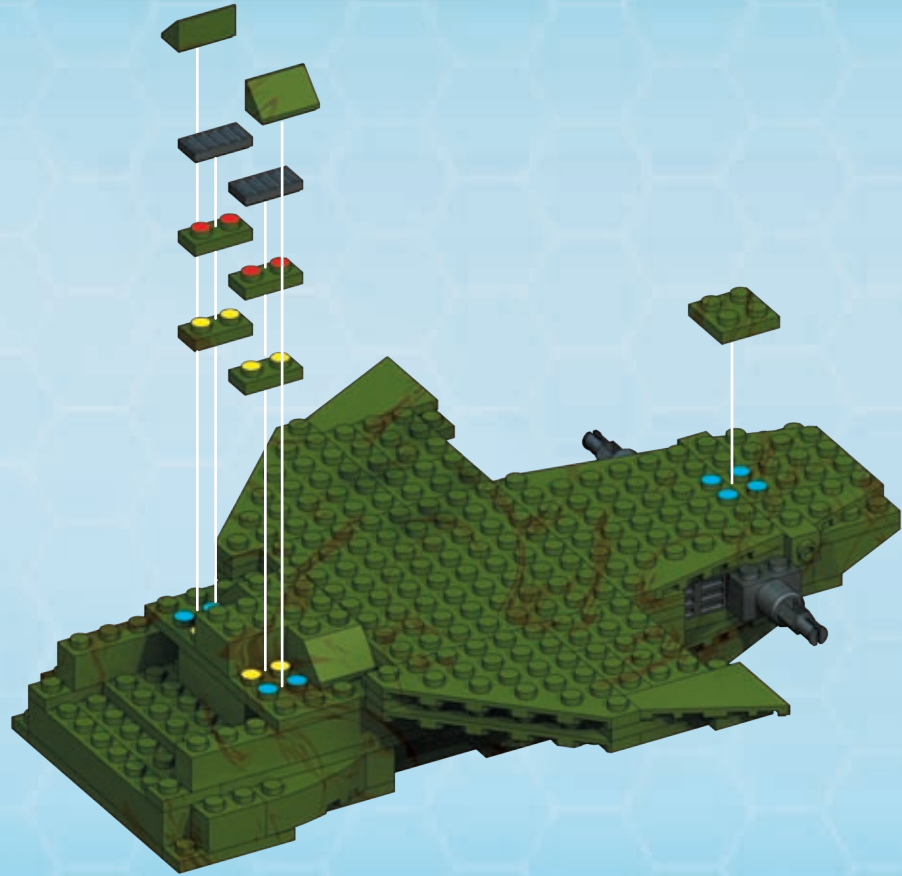
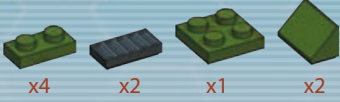

49

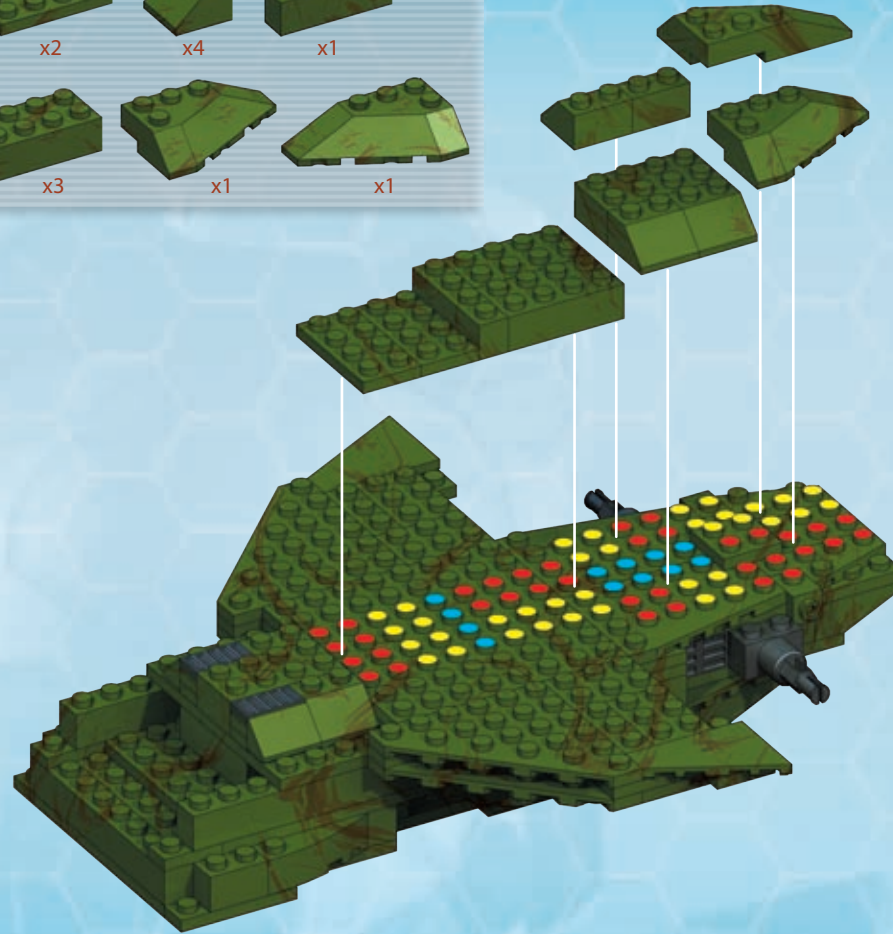
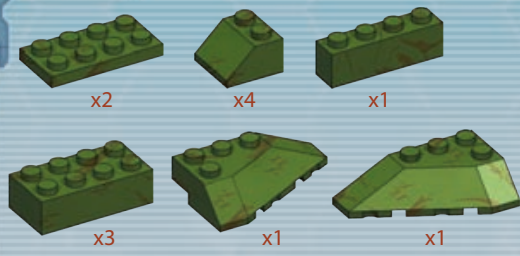

50

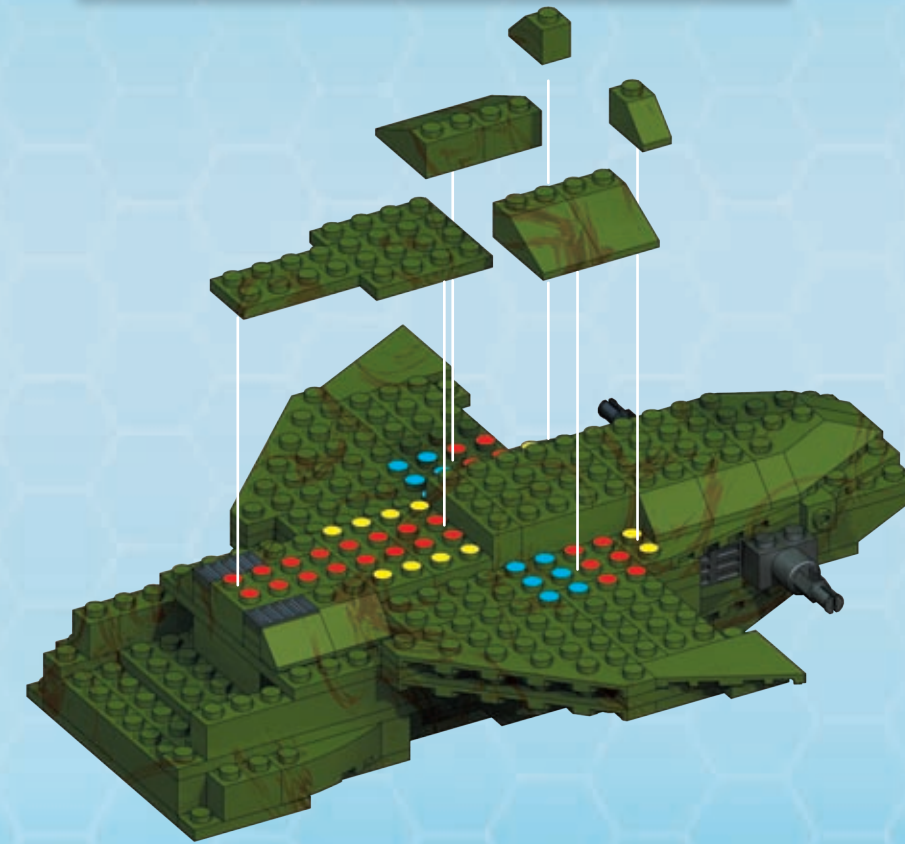

51

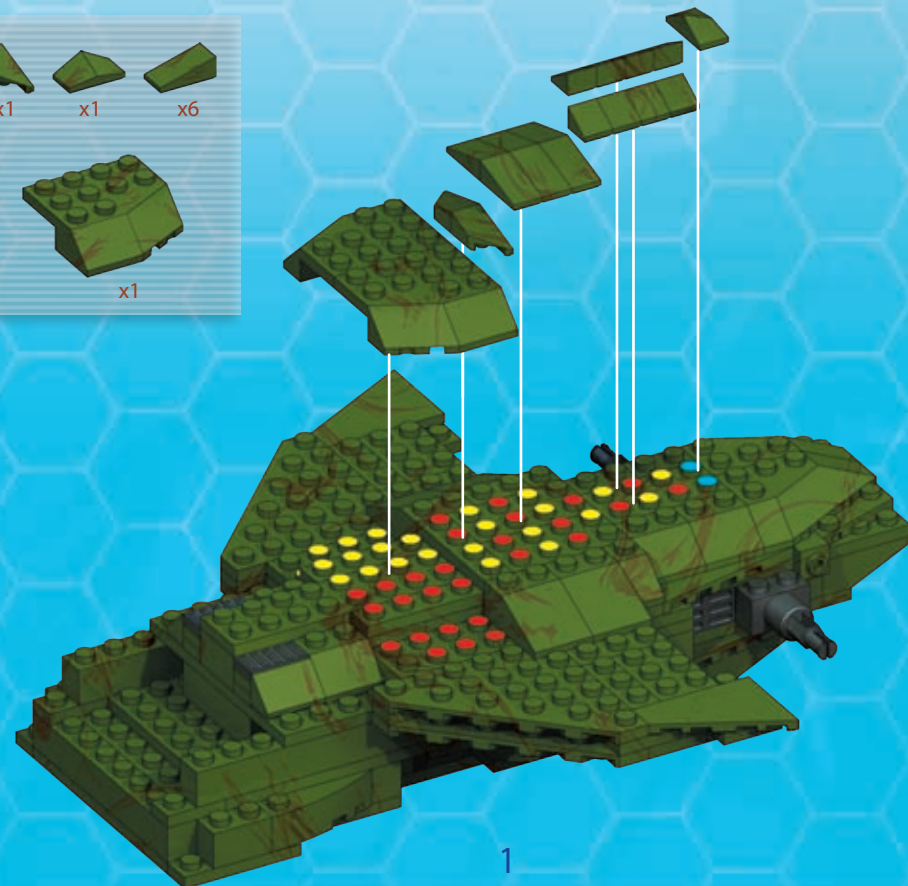
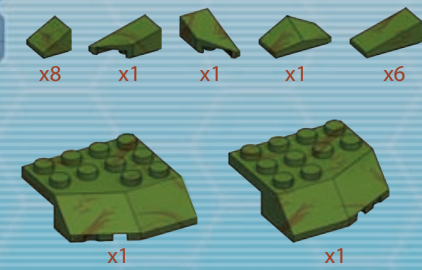

1



2

52

x2 x2

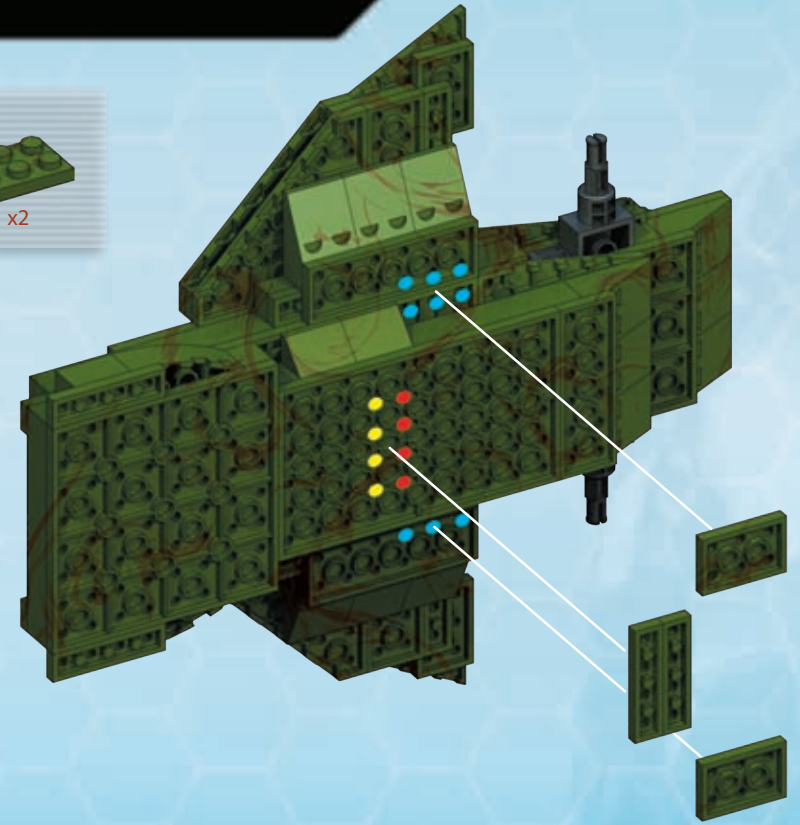

53

x2 x1 x1

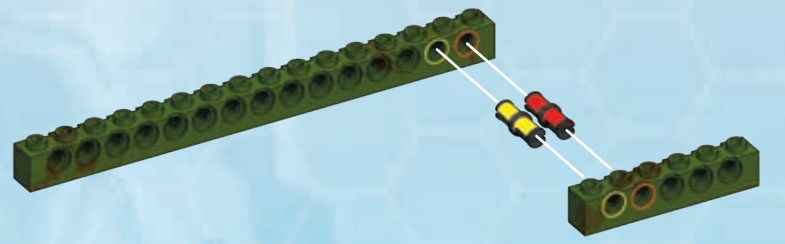

54

x2 x1 x1

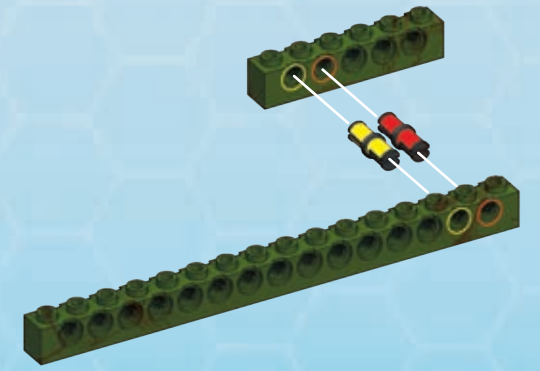

55

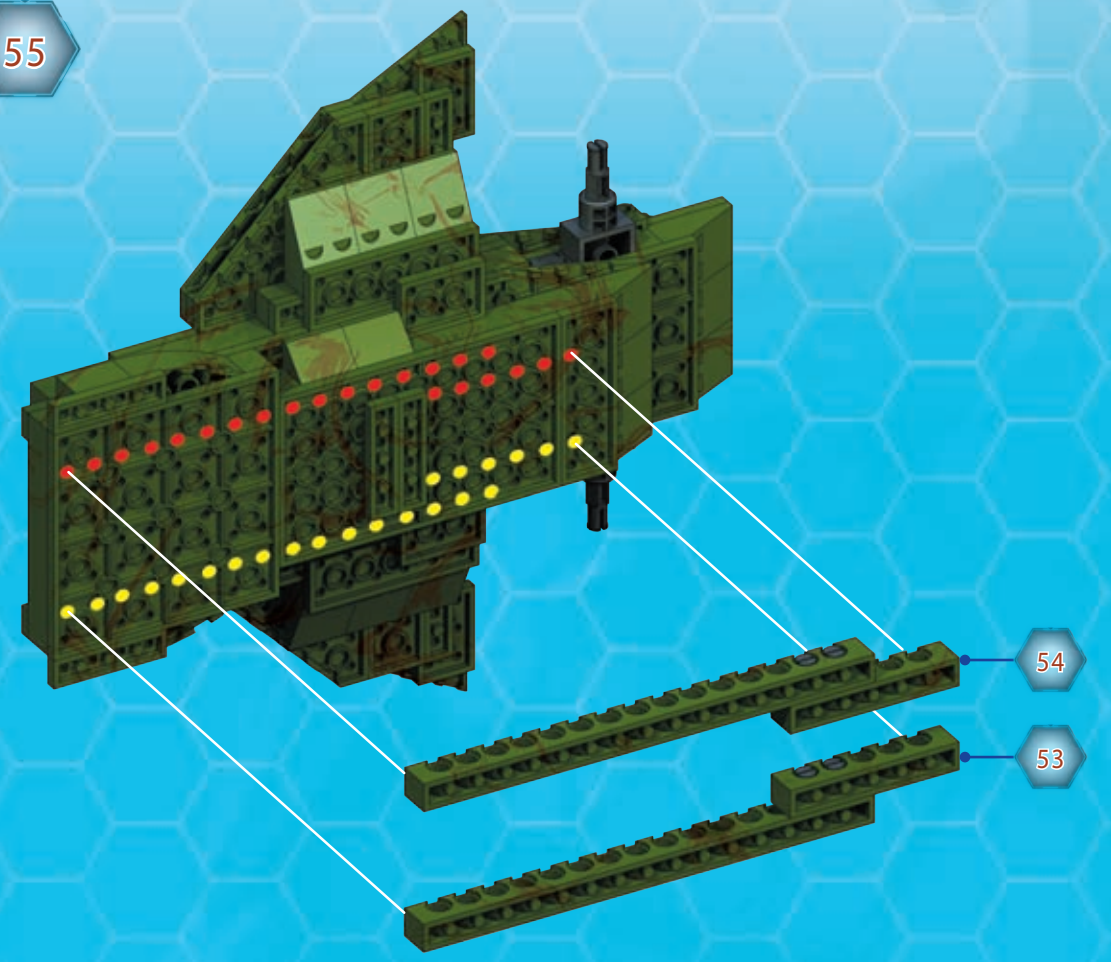

56

x4 x1

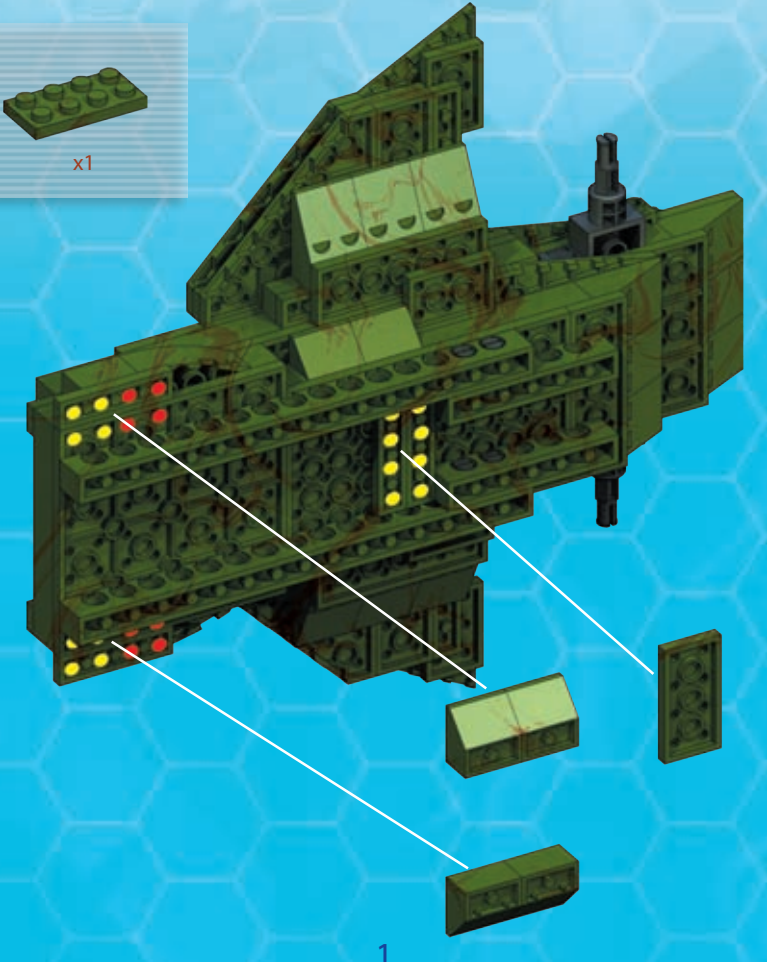

1

2



57

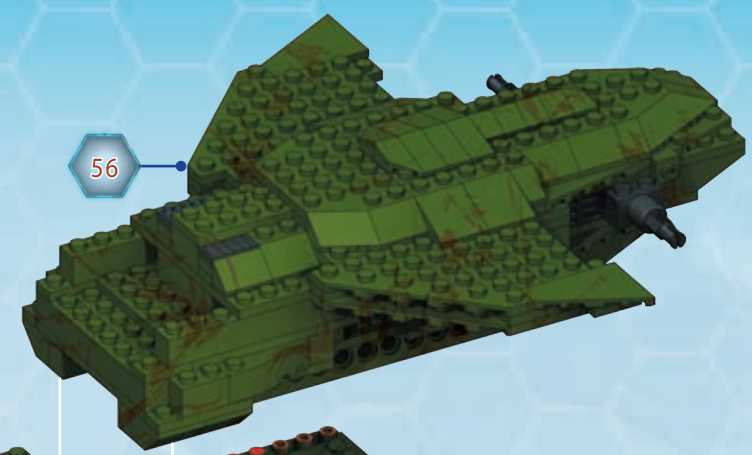

56

58

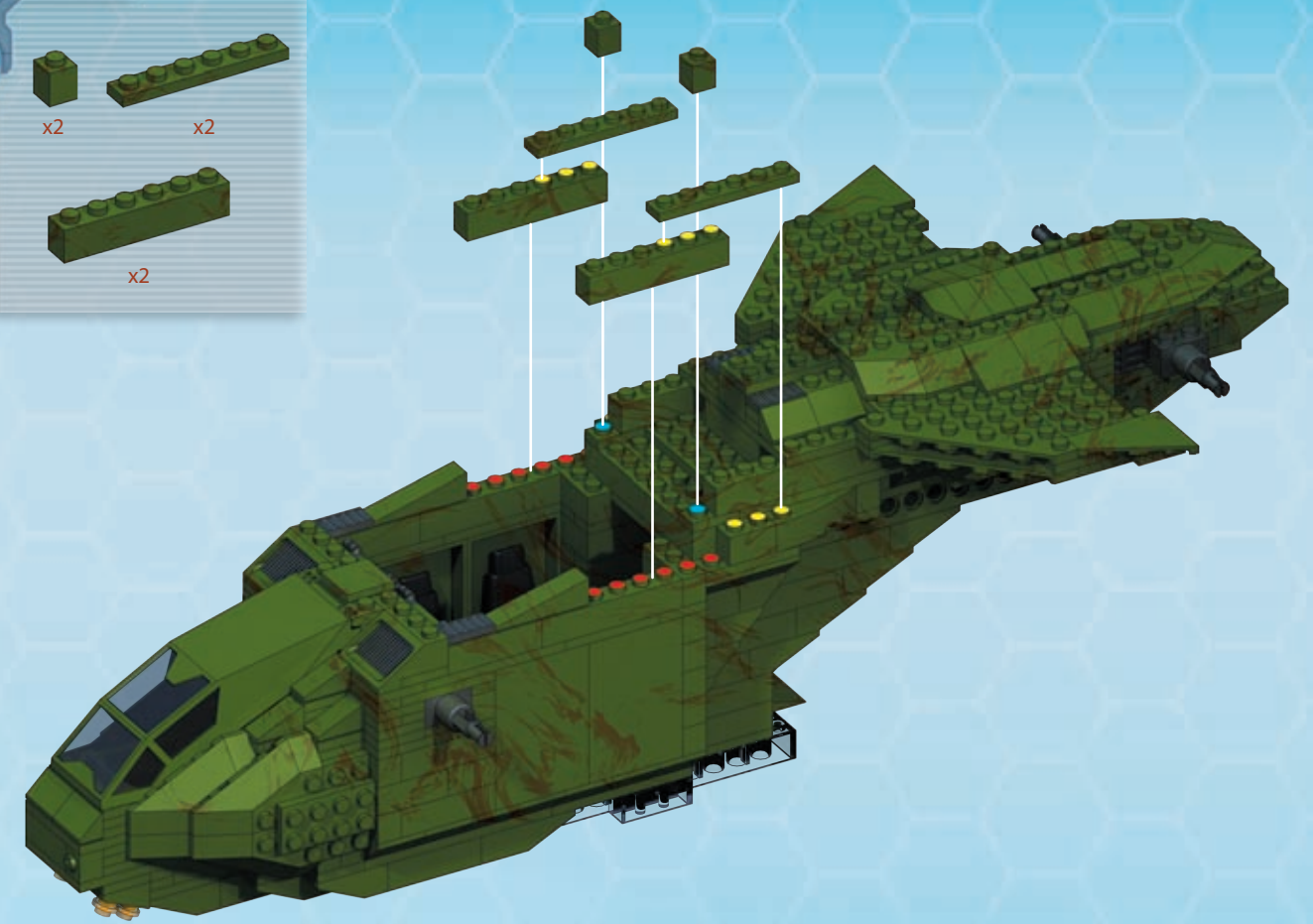
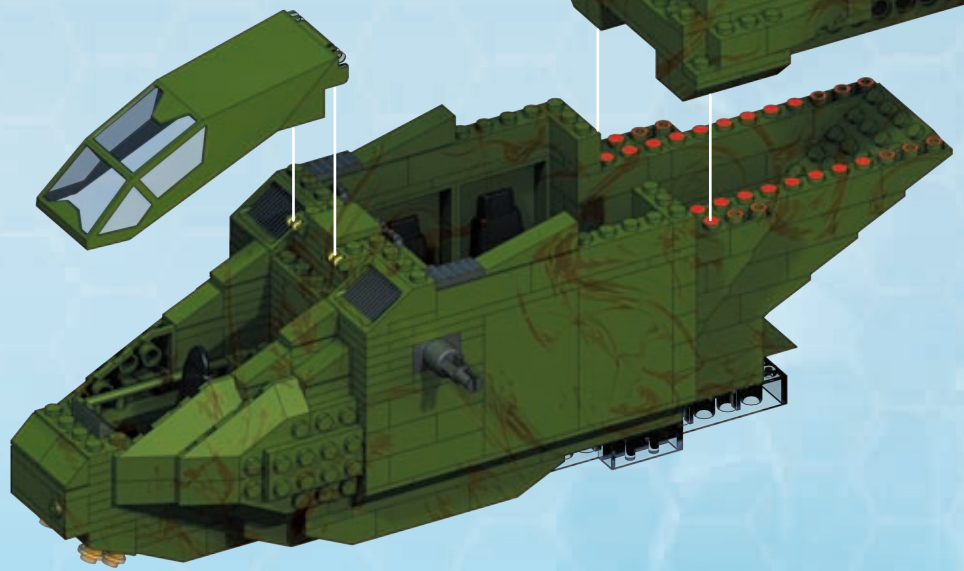
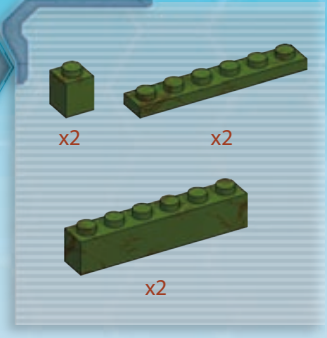

59



60

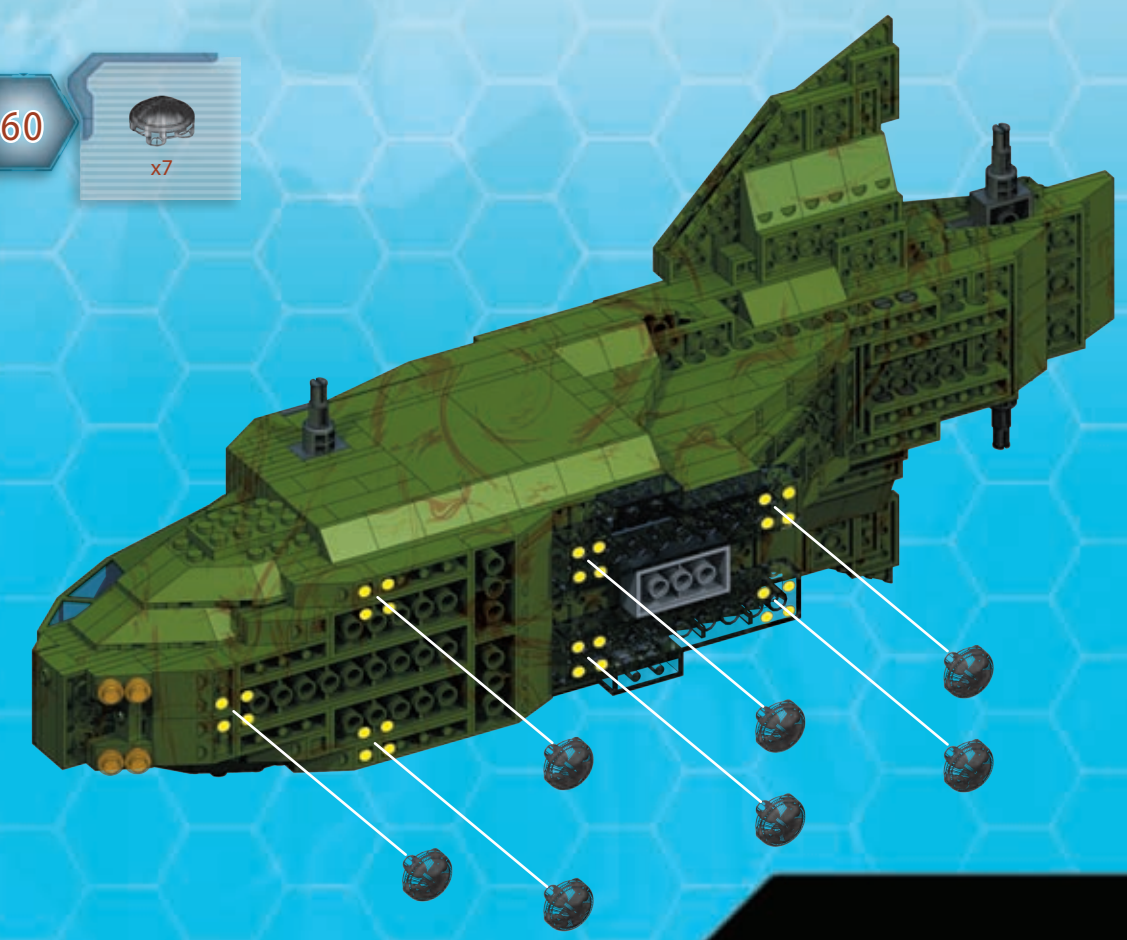
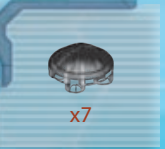

61



62

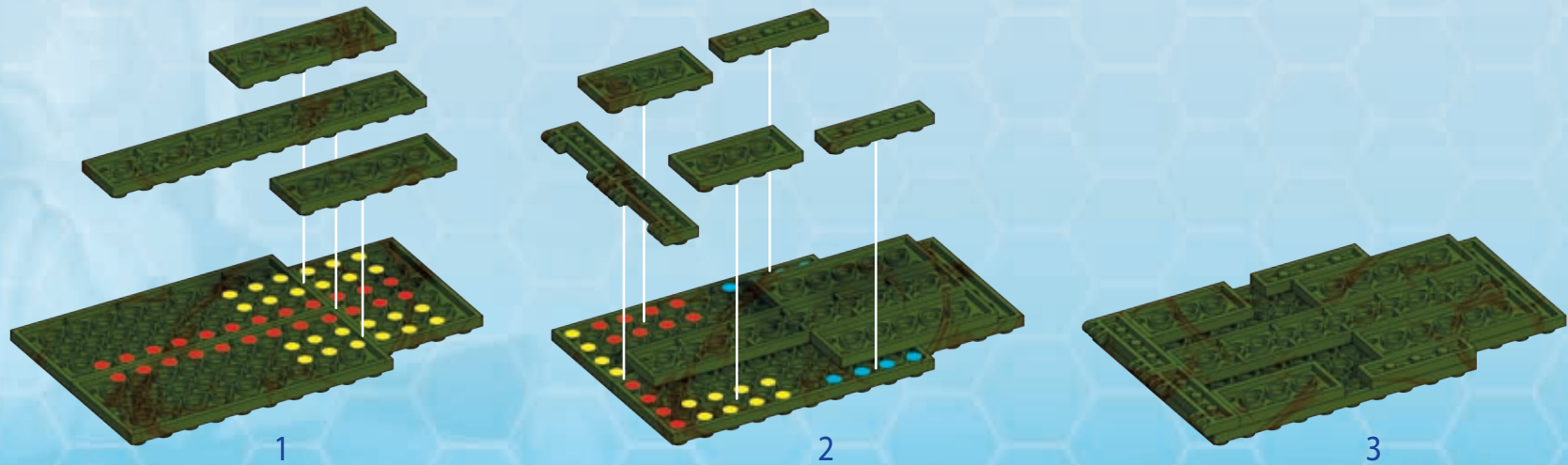
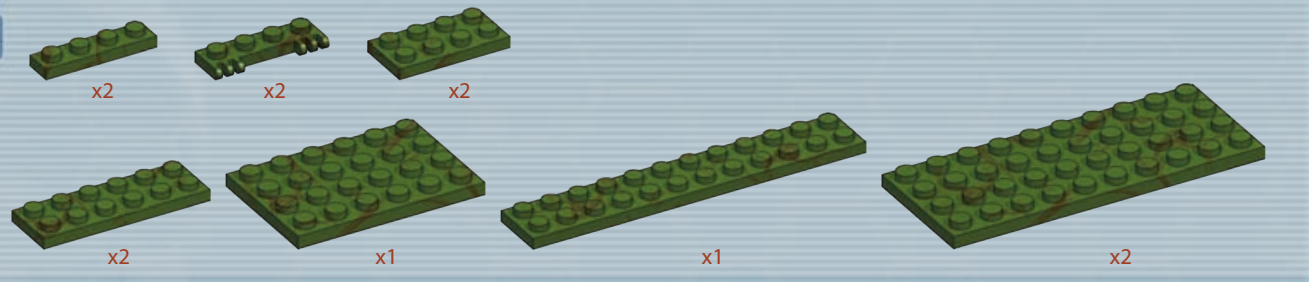

63

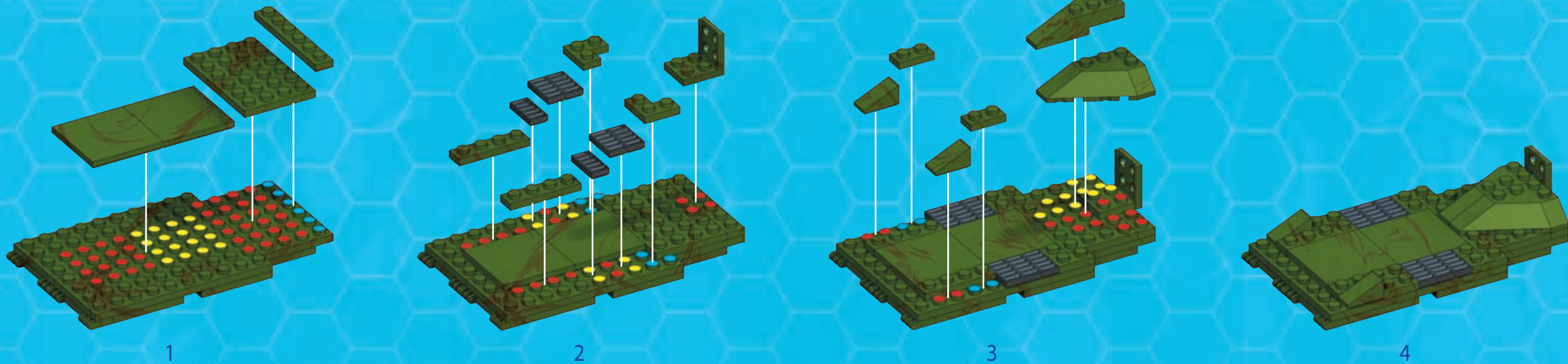
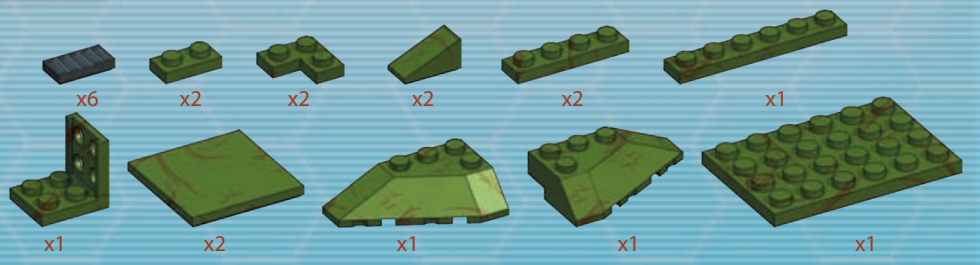

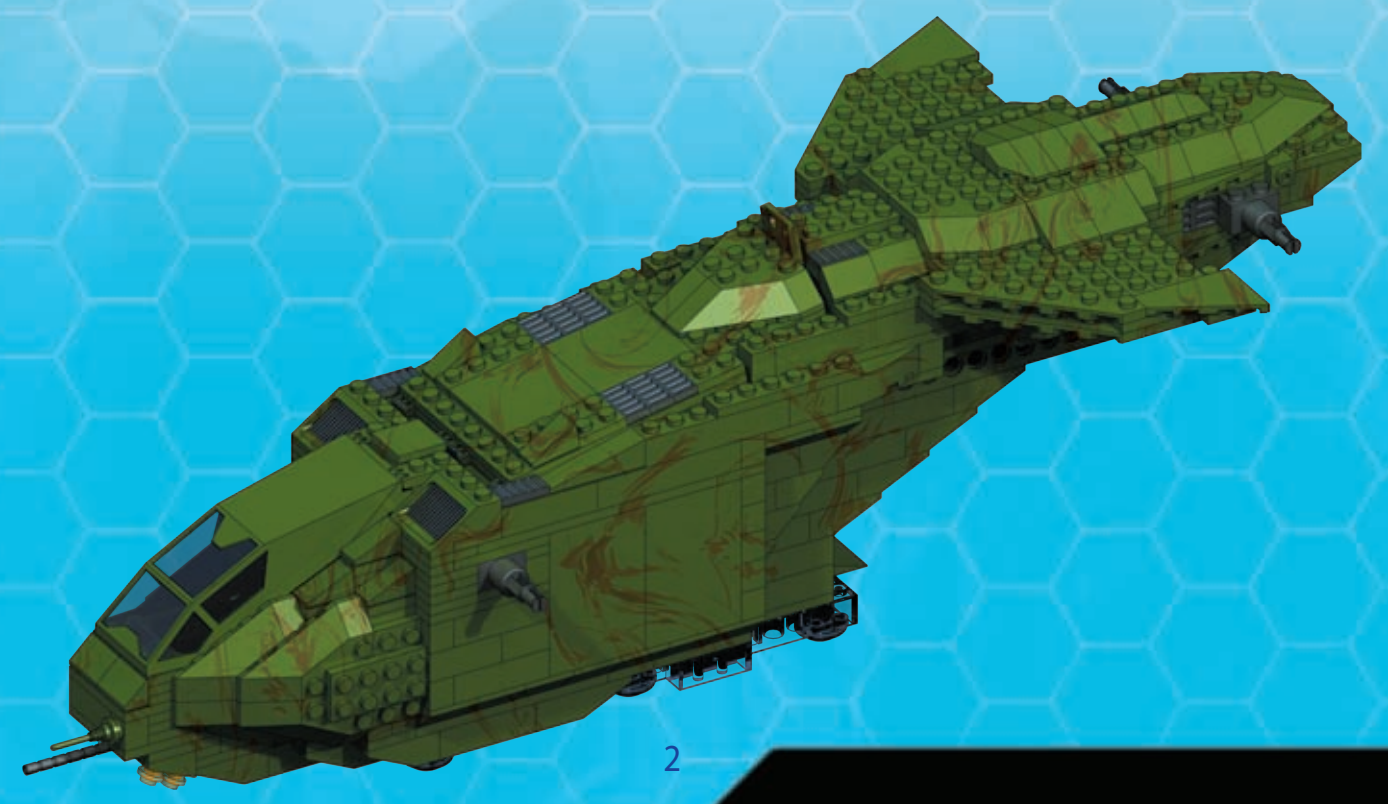
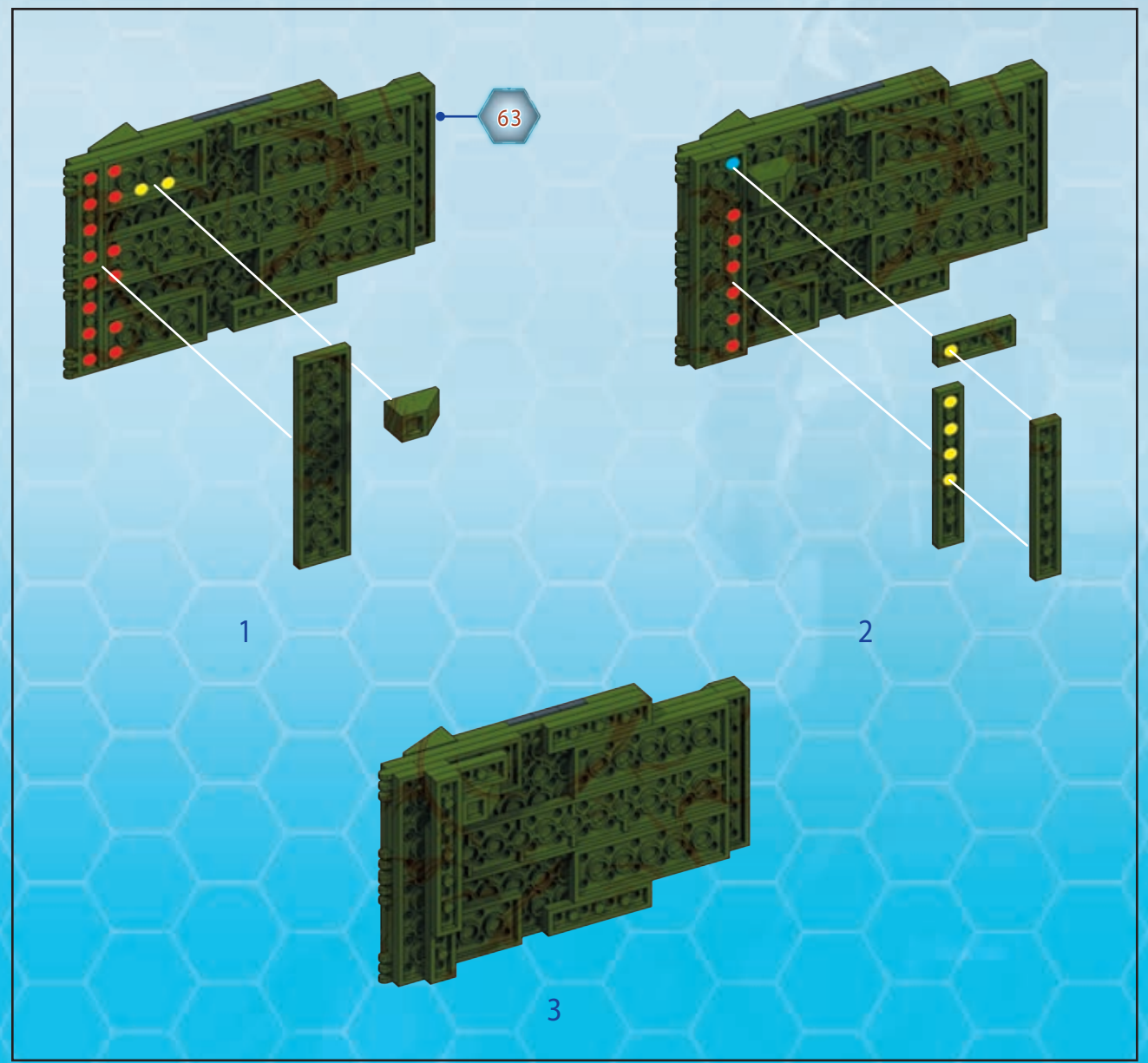
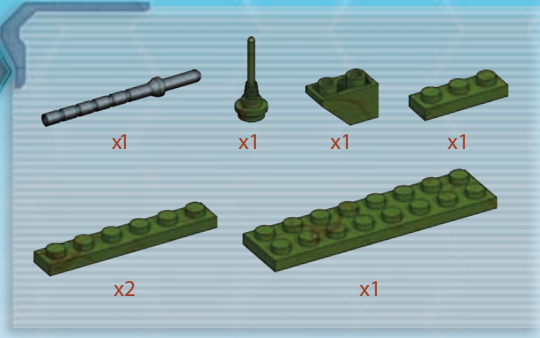



65

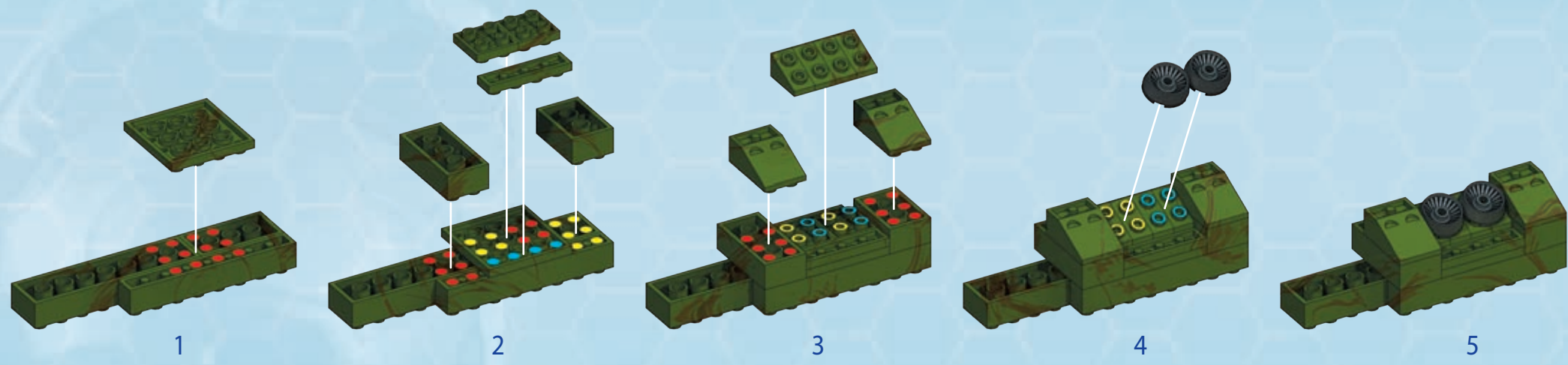
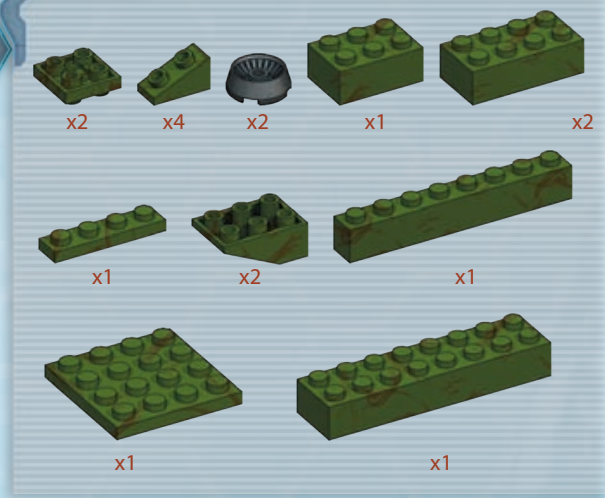

66

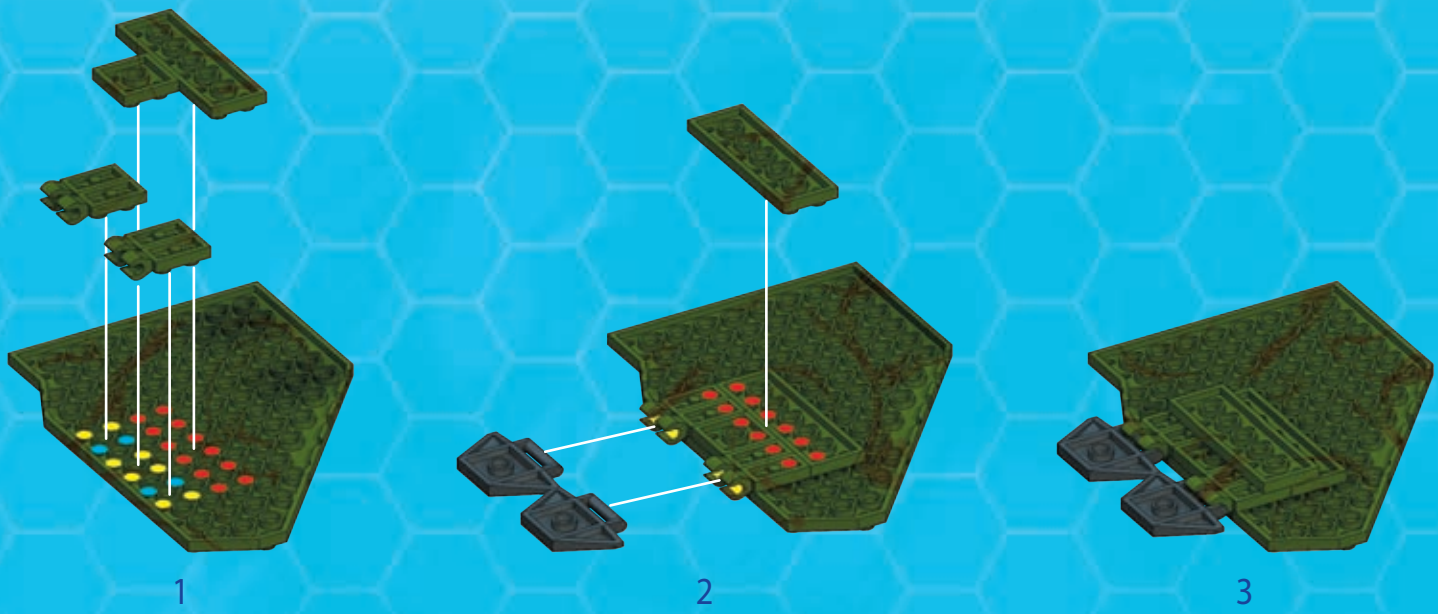
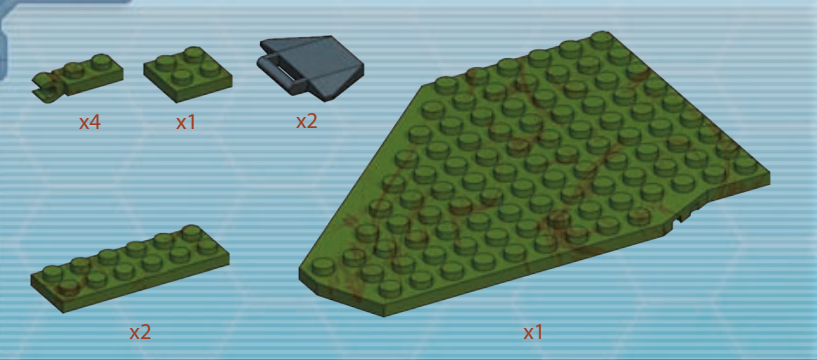

67

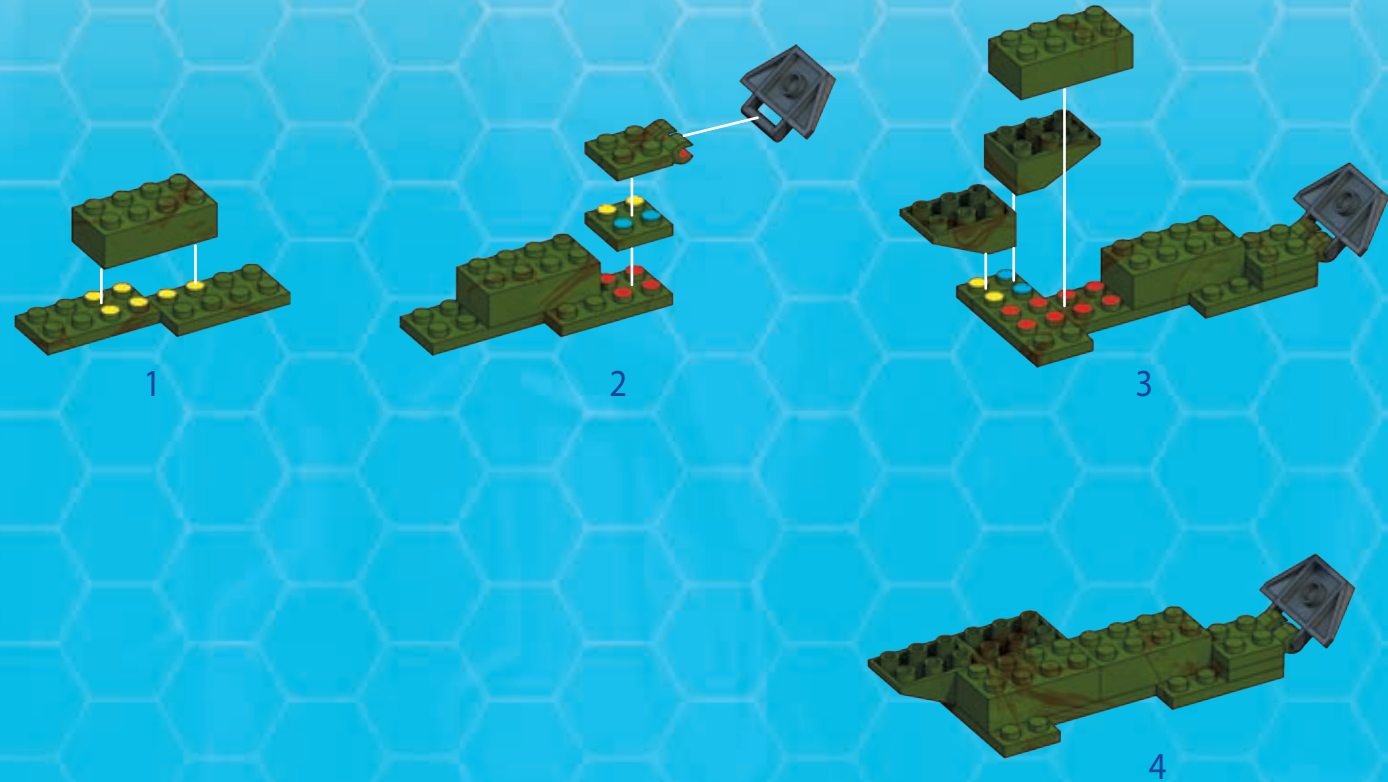
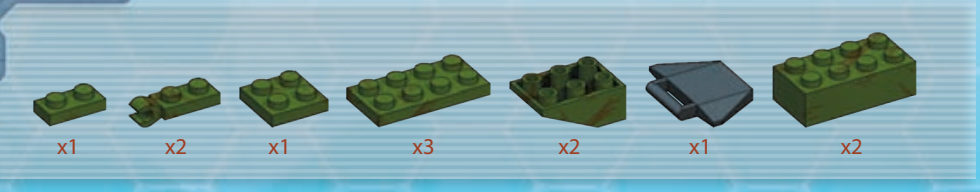

68

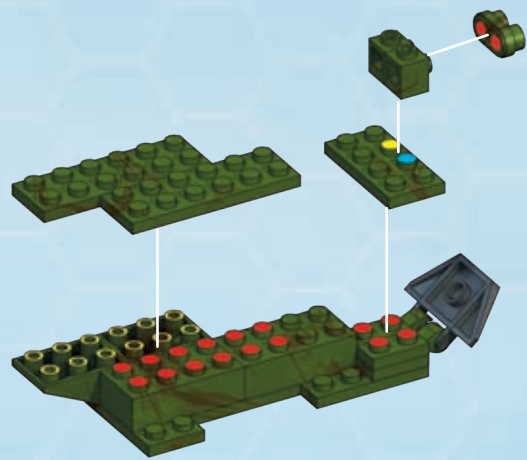
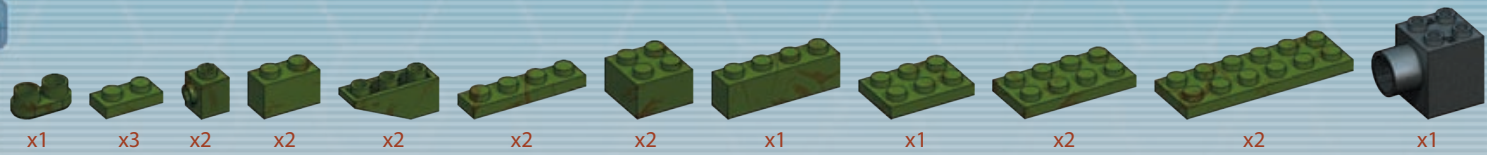

1

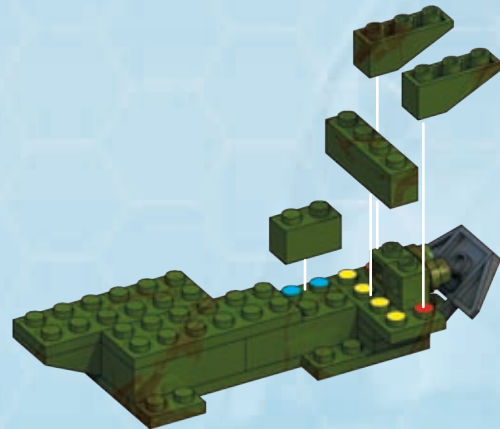

2

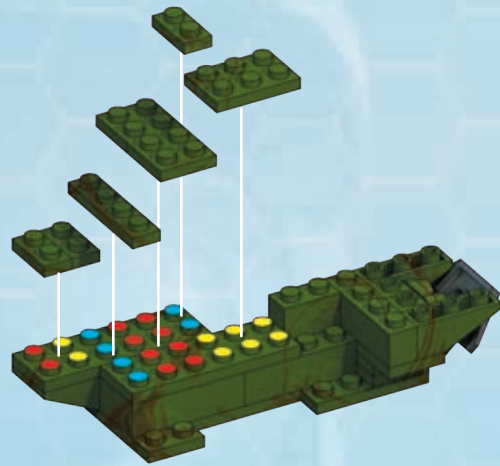

3

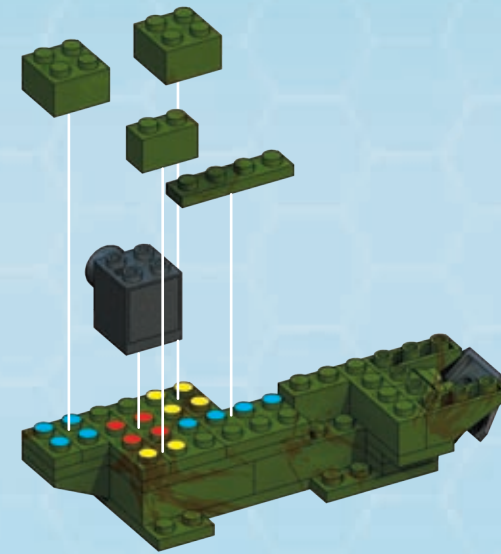

4



5

69

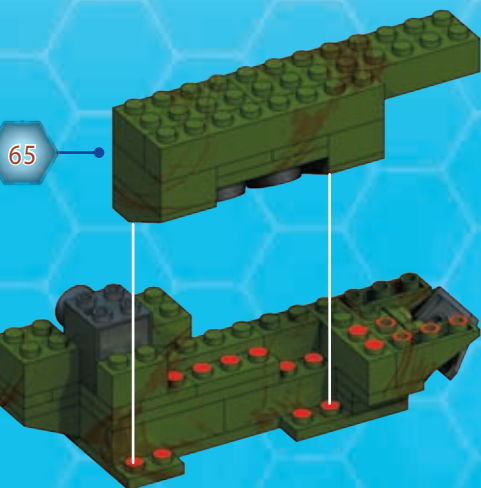
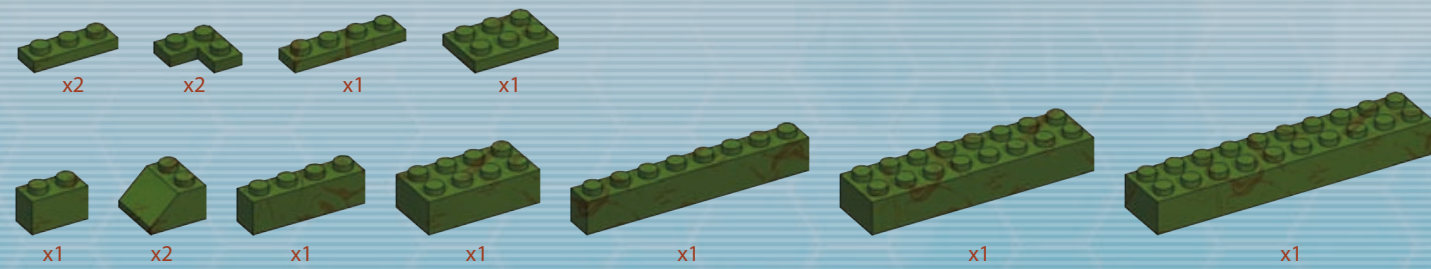

65

1

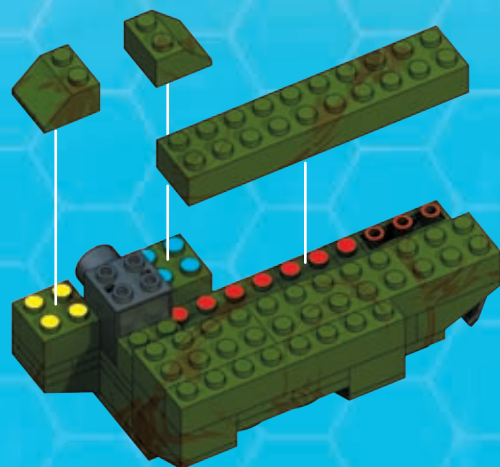

2

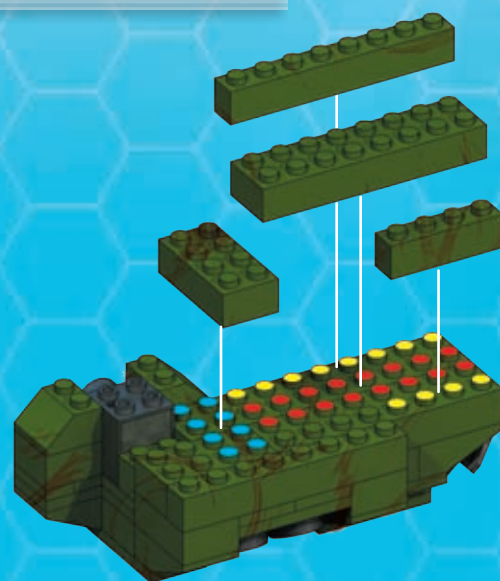

3

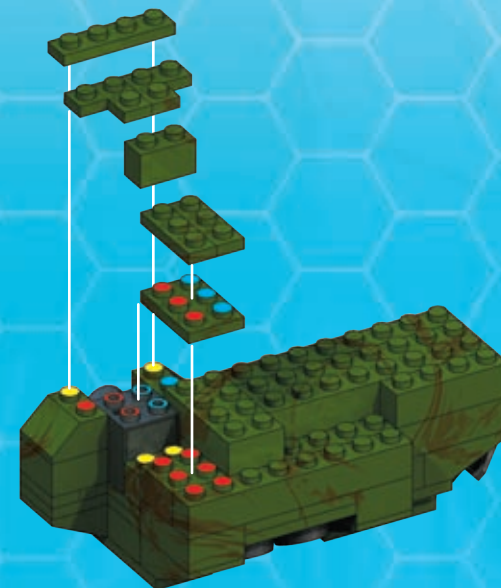

4



5

70

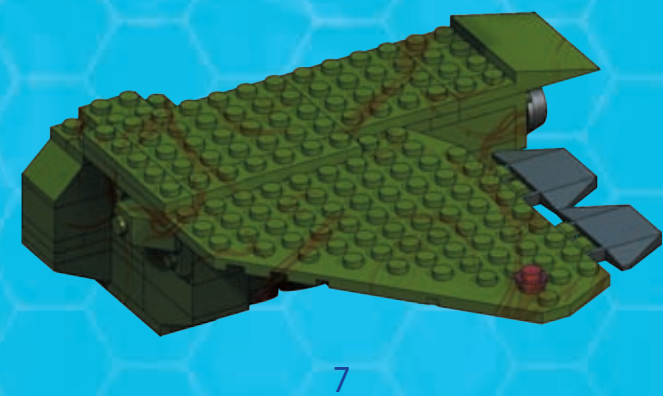
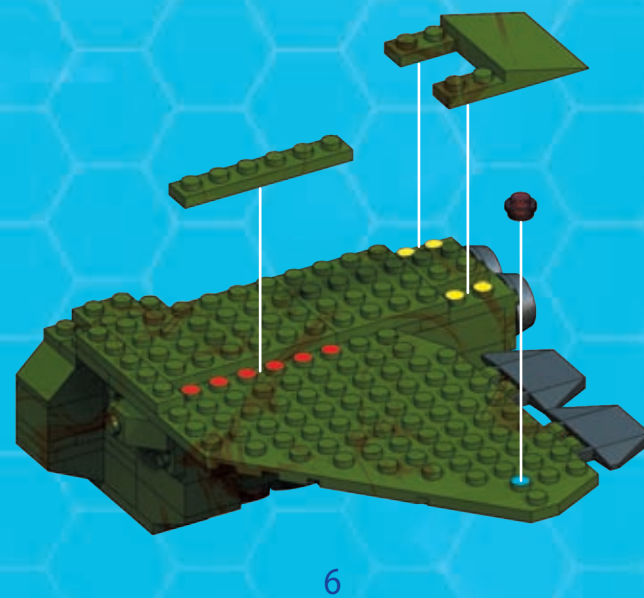
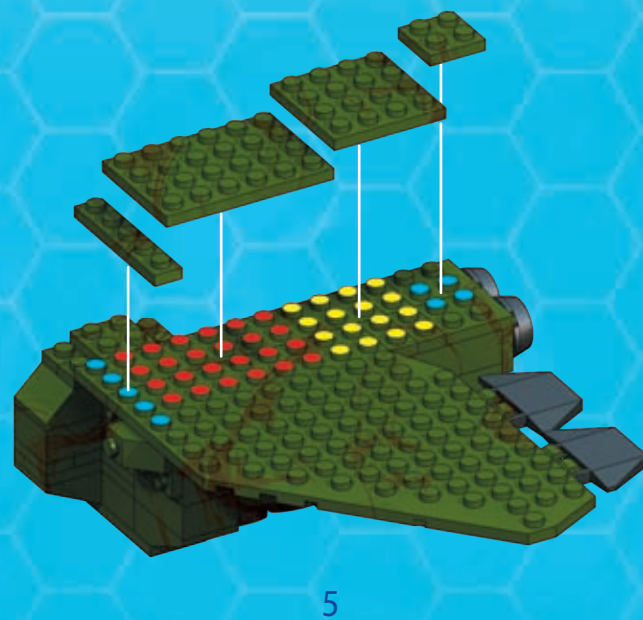
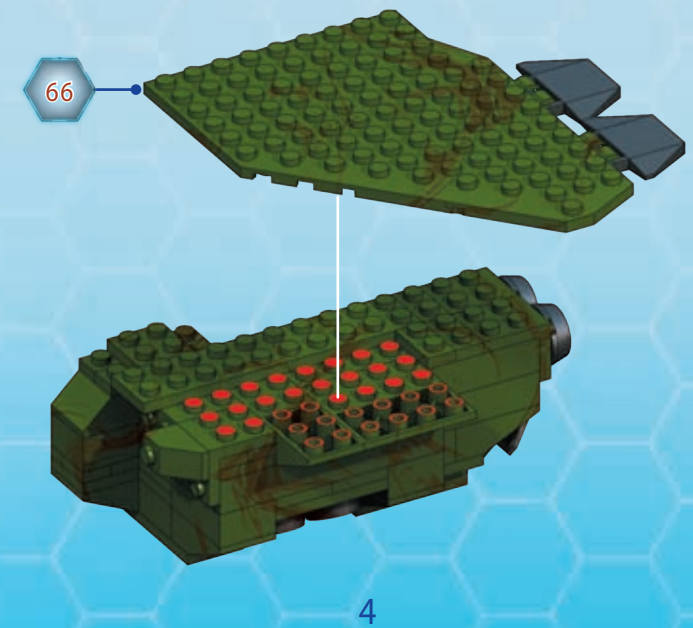
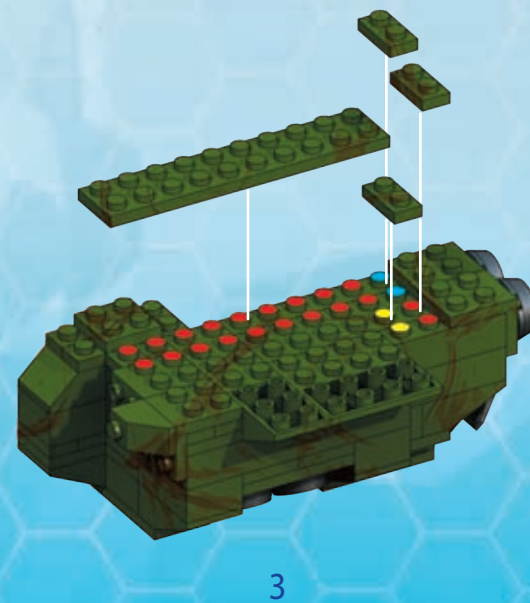
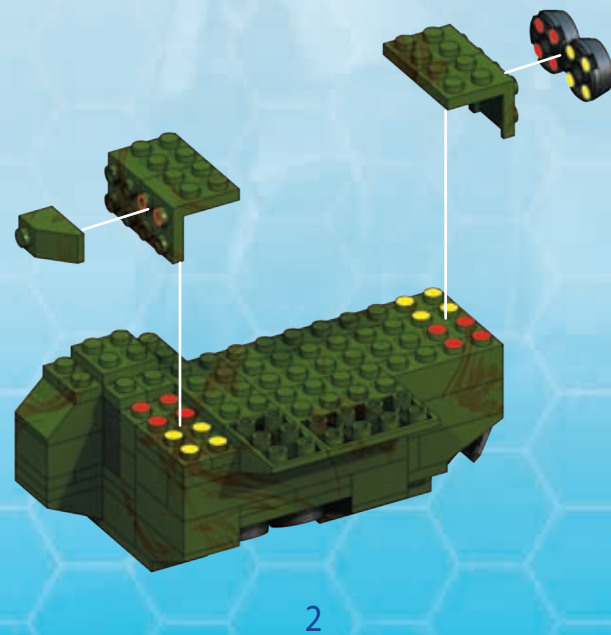
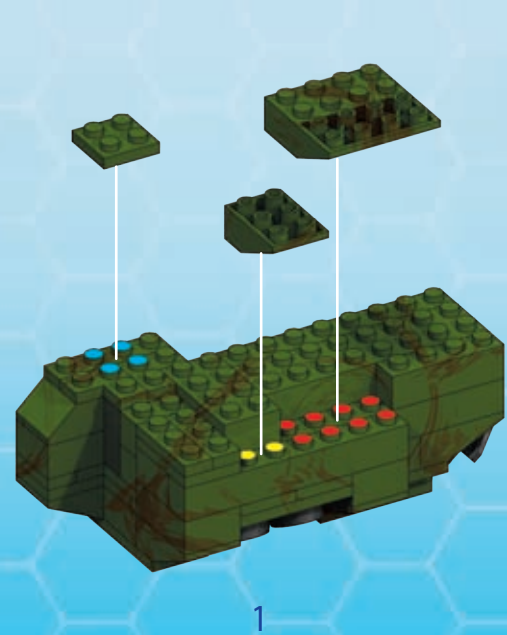
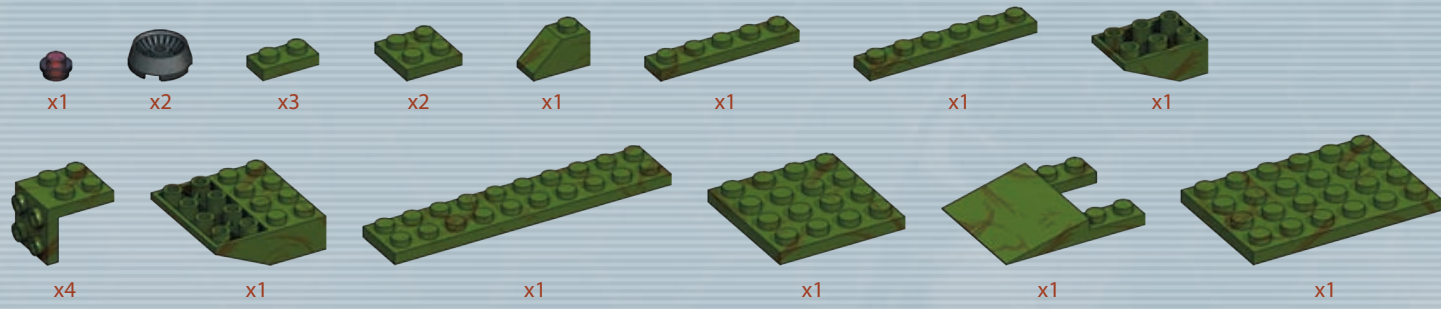

71

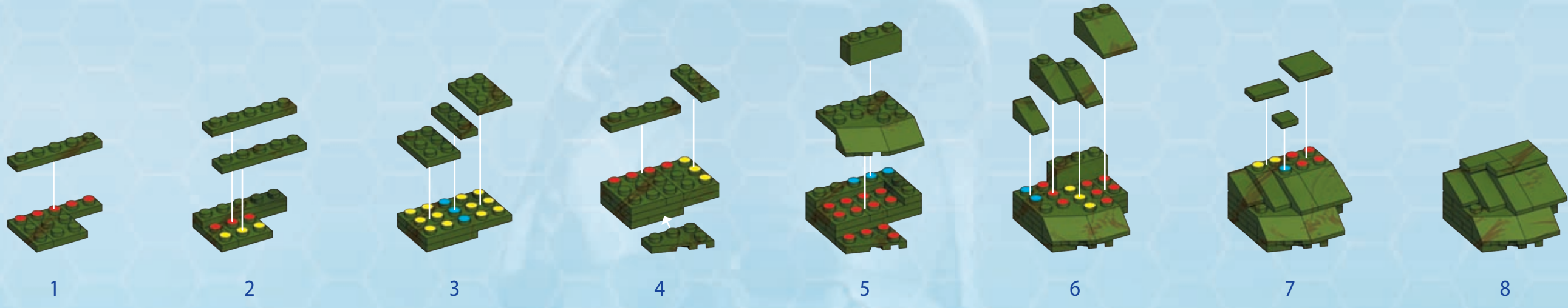
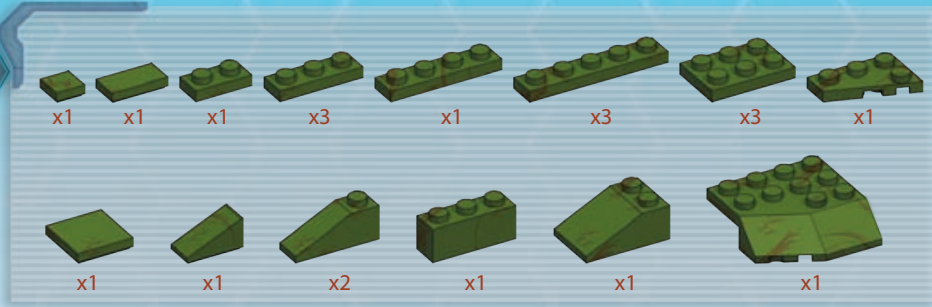

72

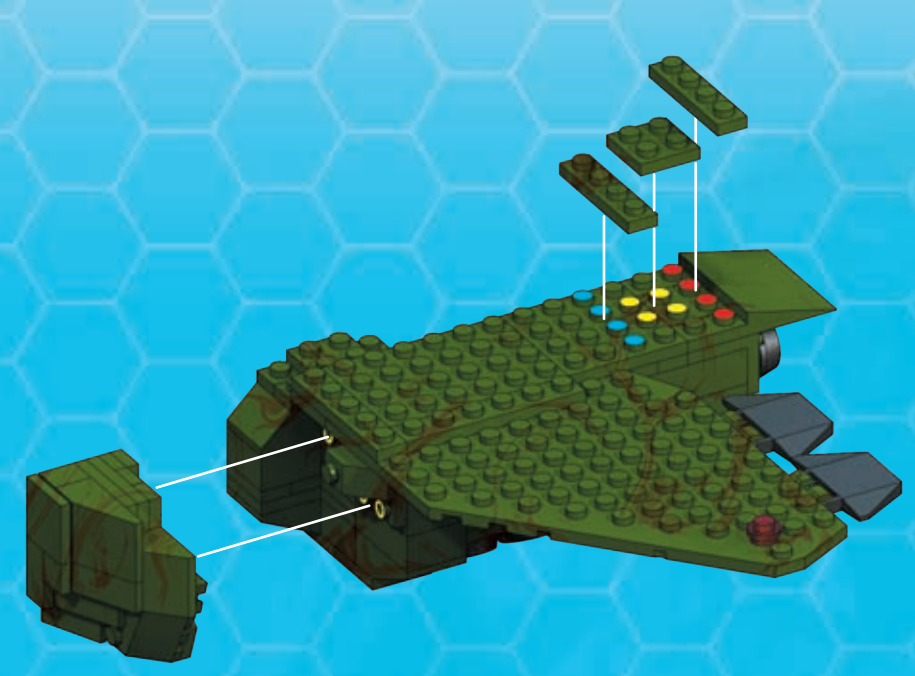

73

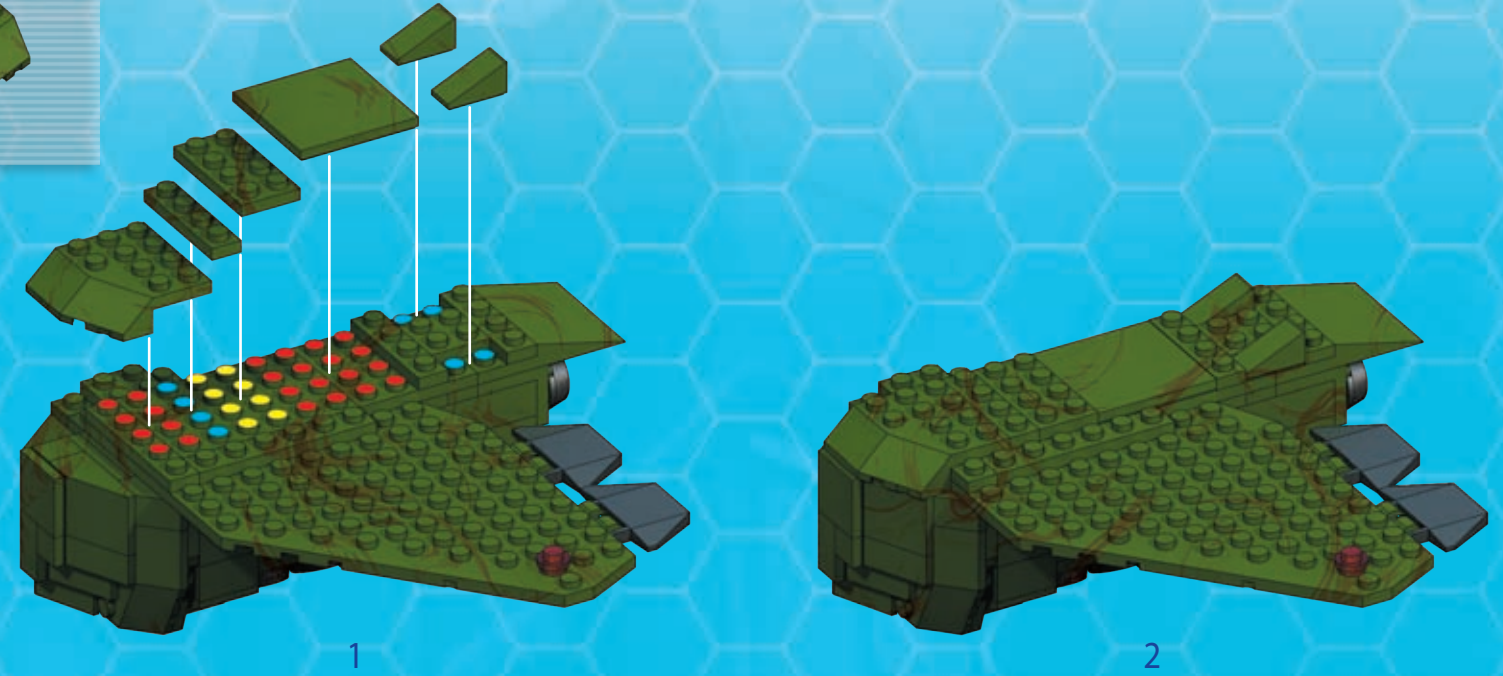
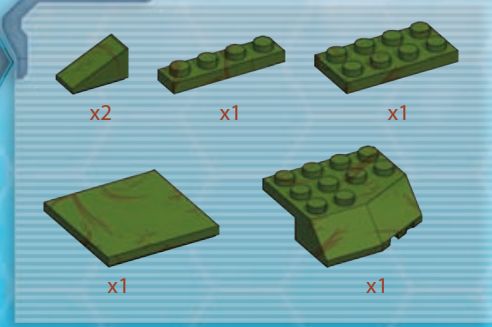

74

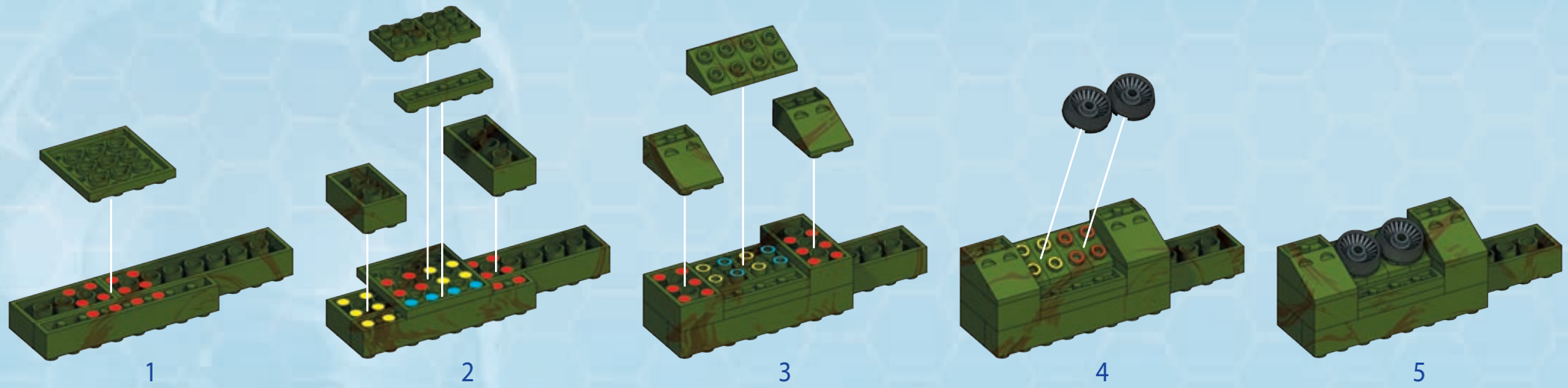
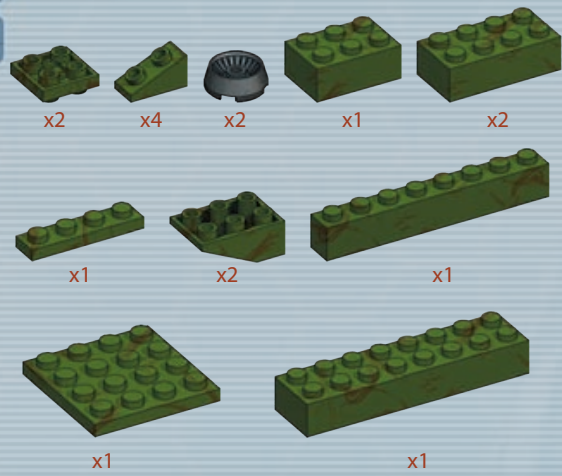

75

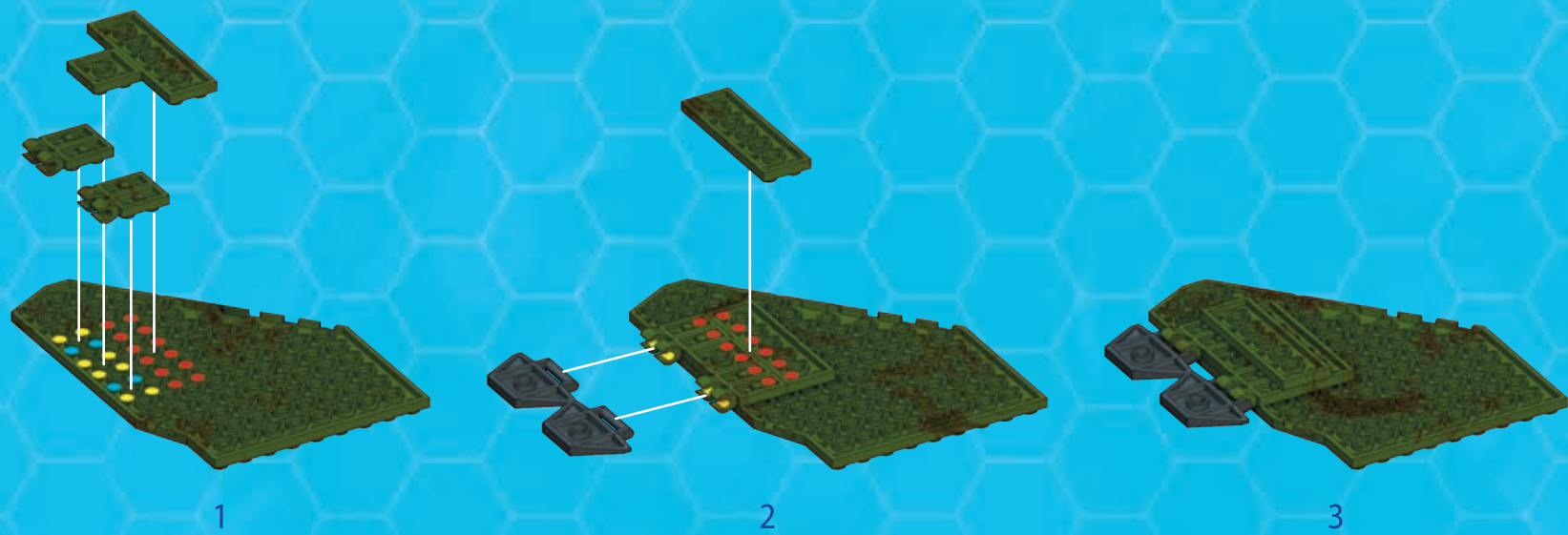
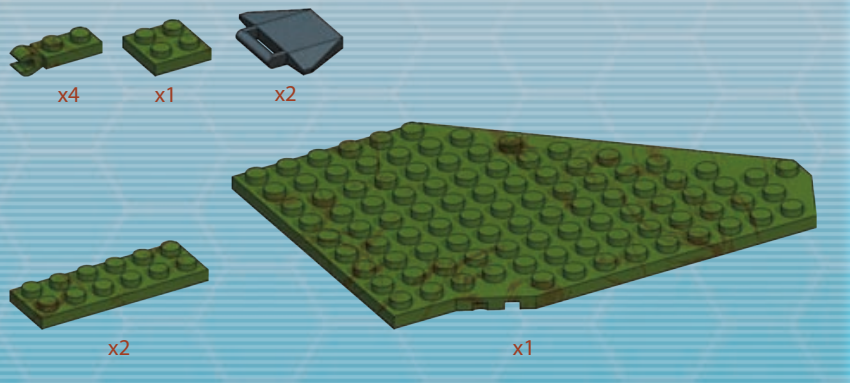

76

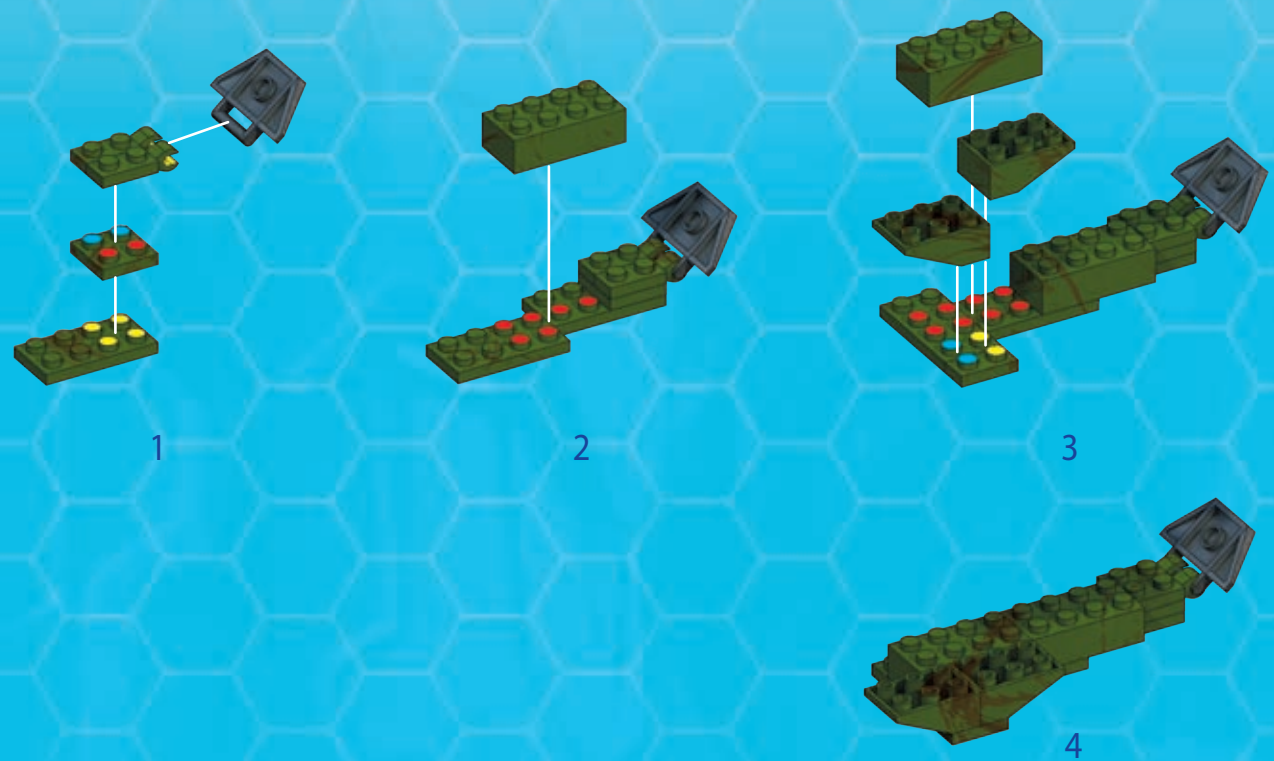
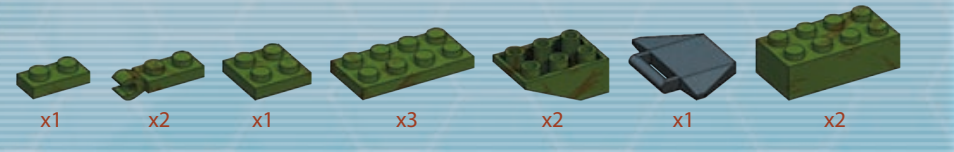

77

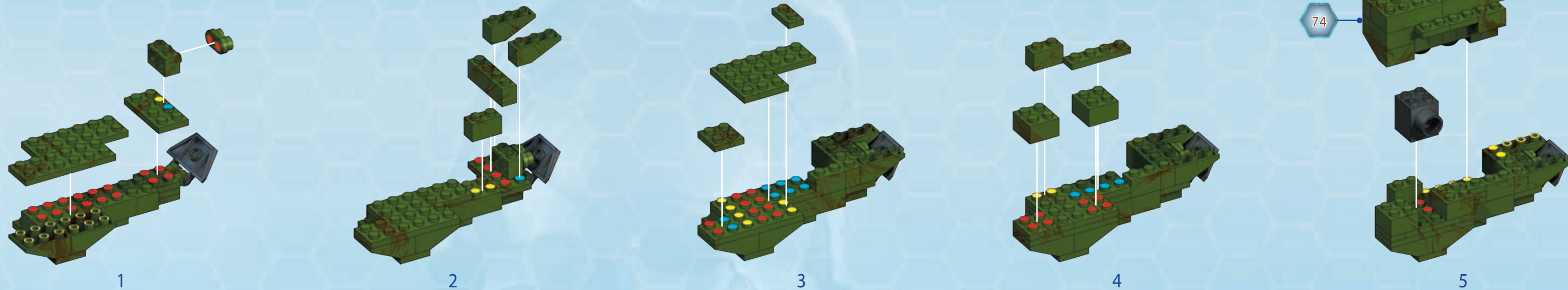
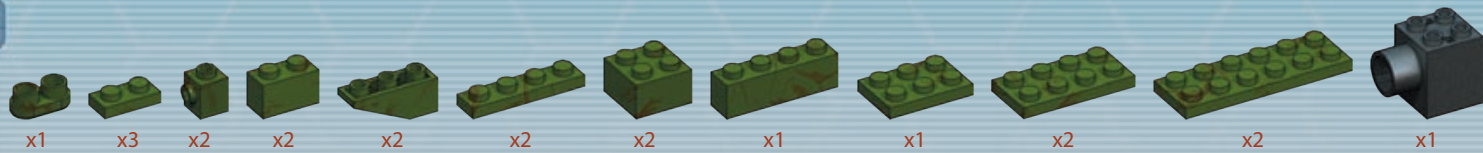

78

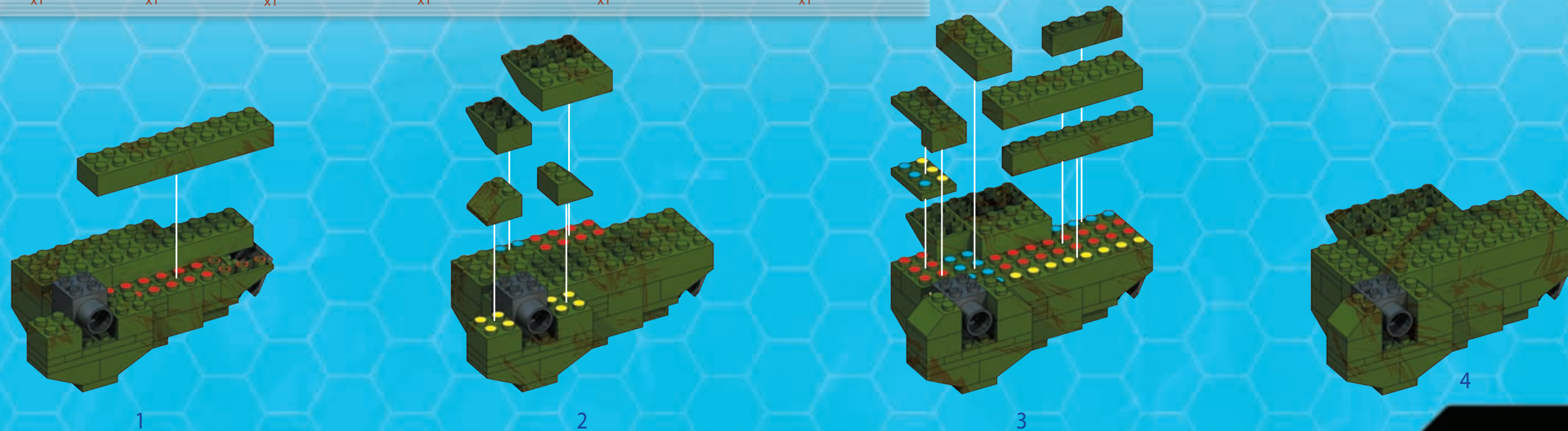
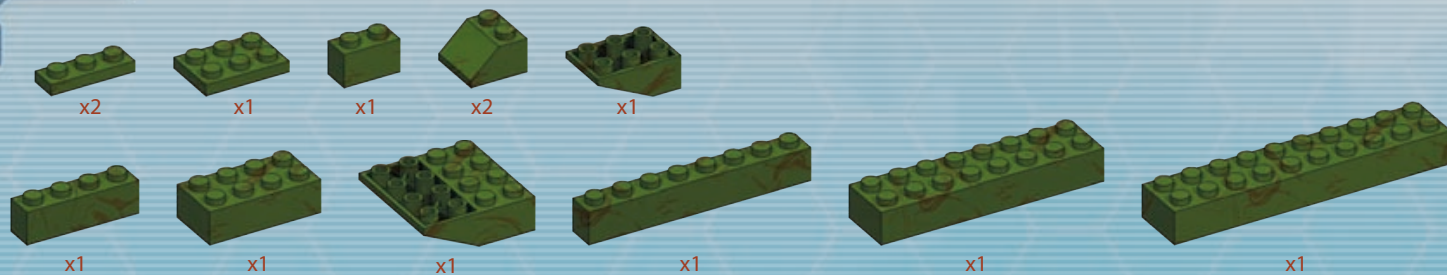

79

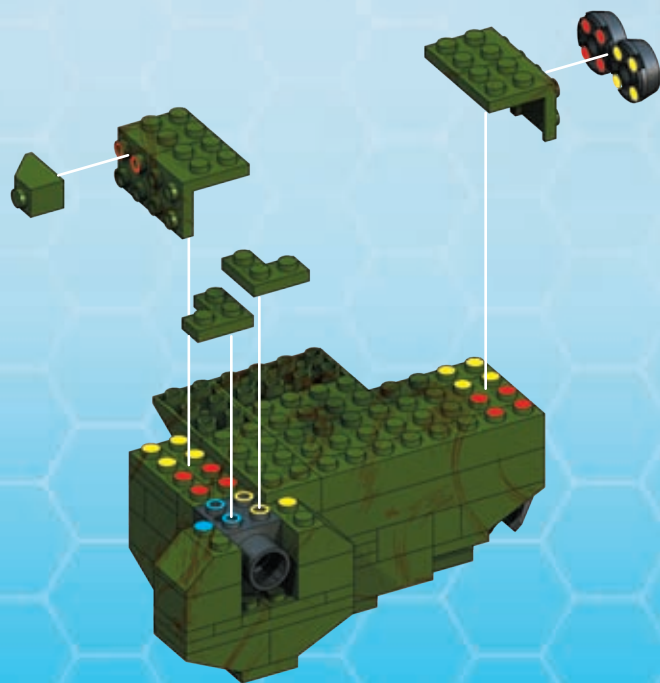
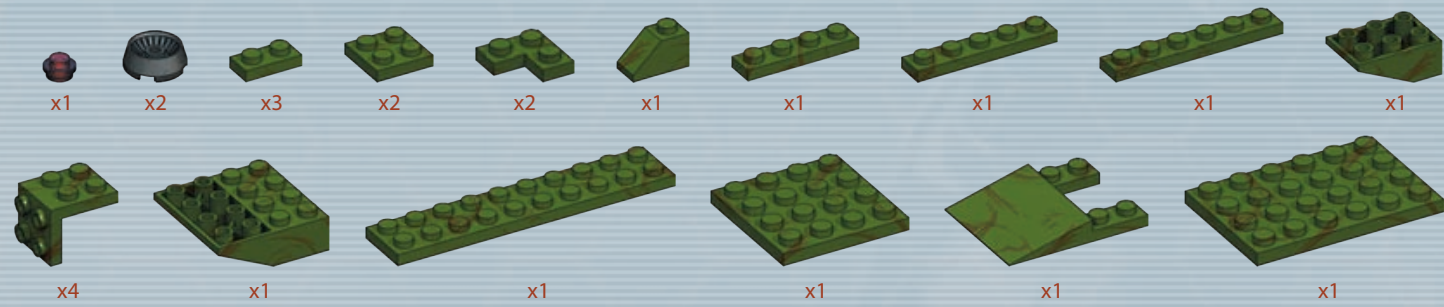

1

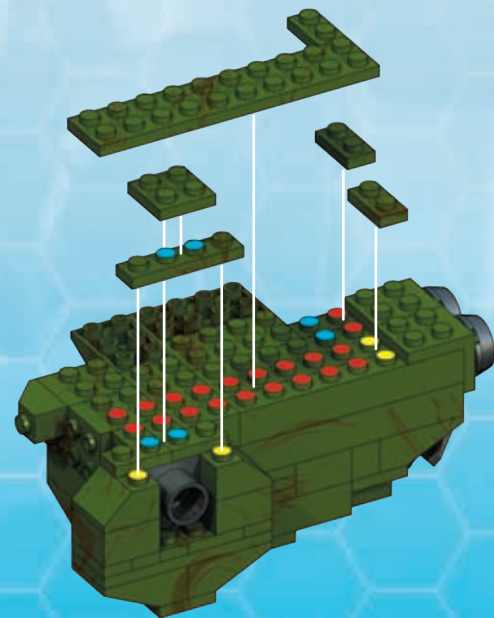

2

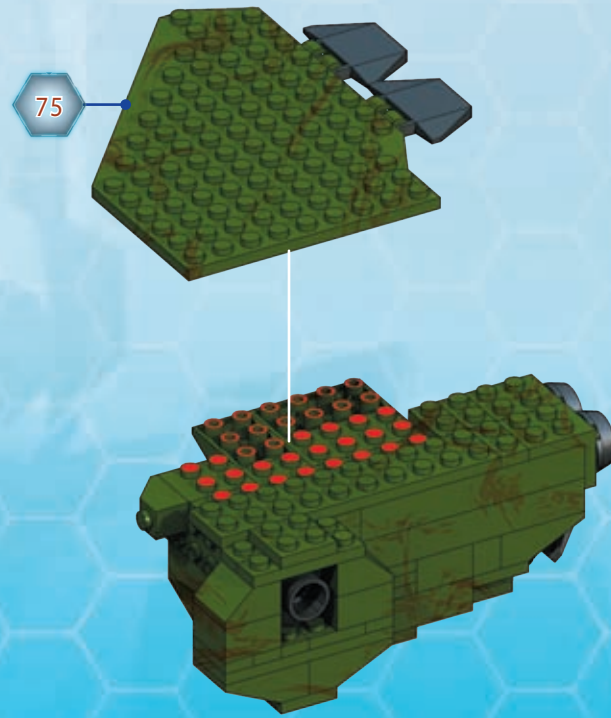

3

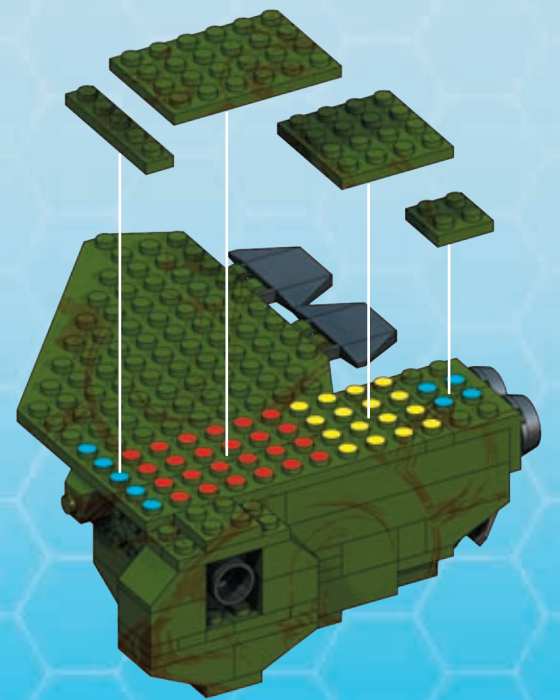

4

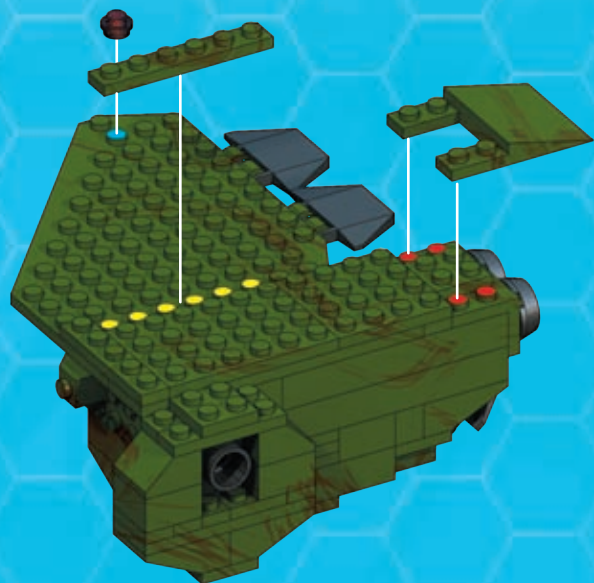

5



6

75

80

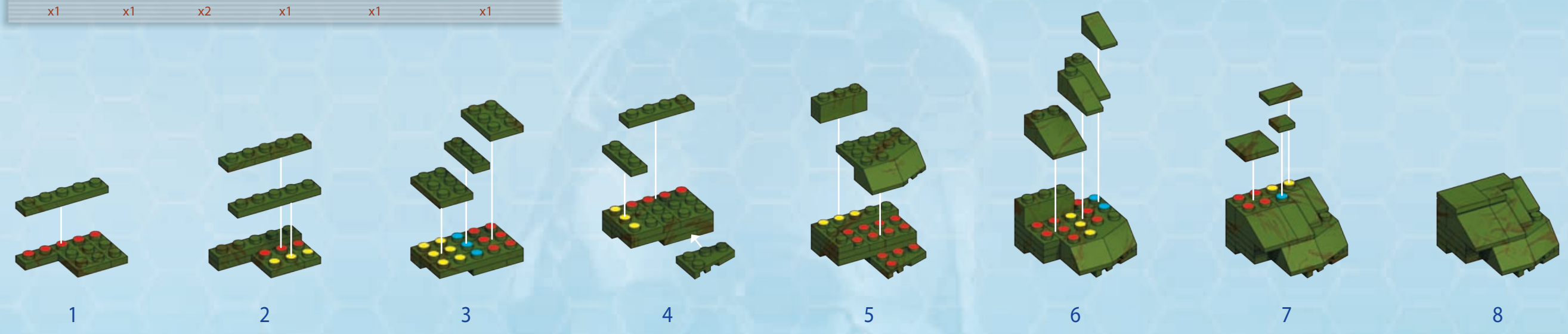
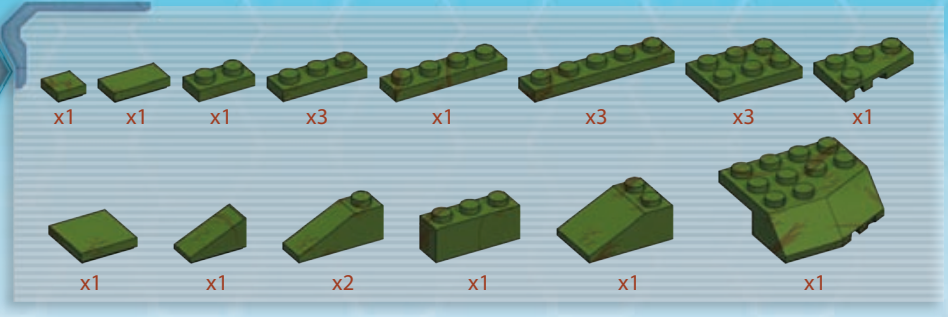

81

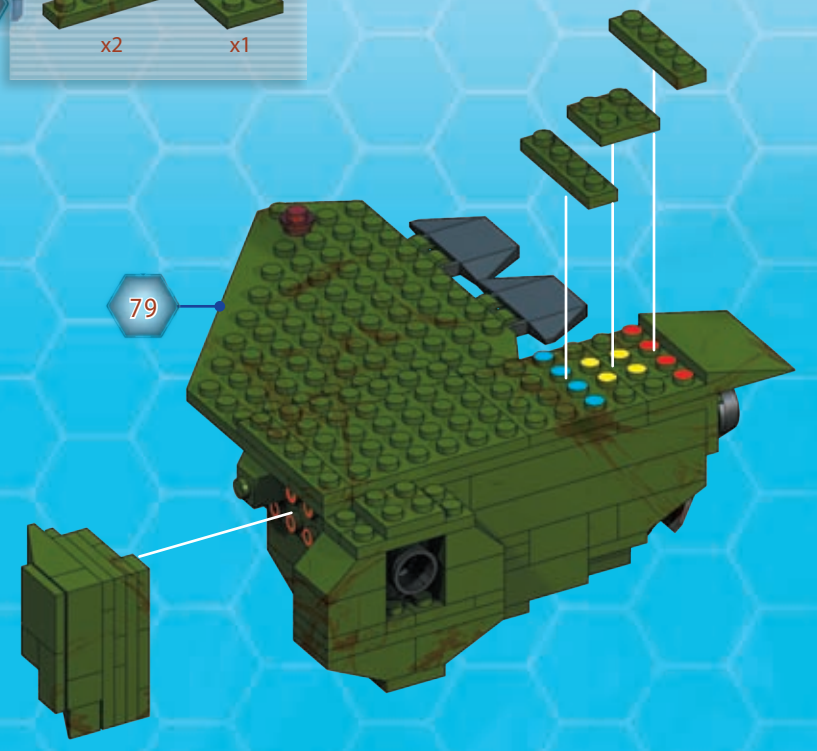

82

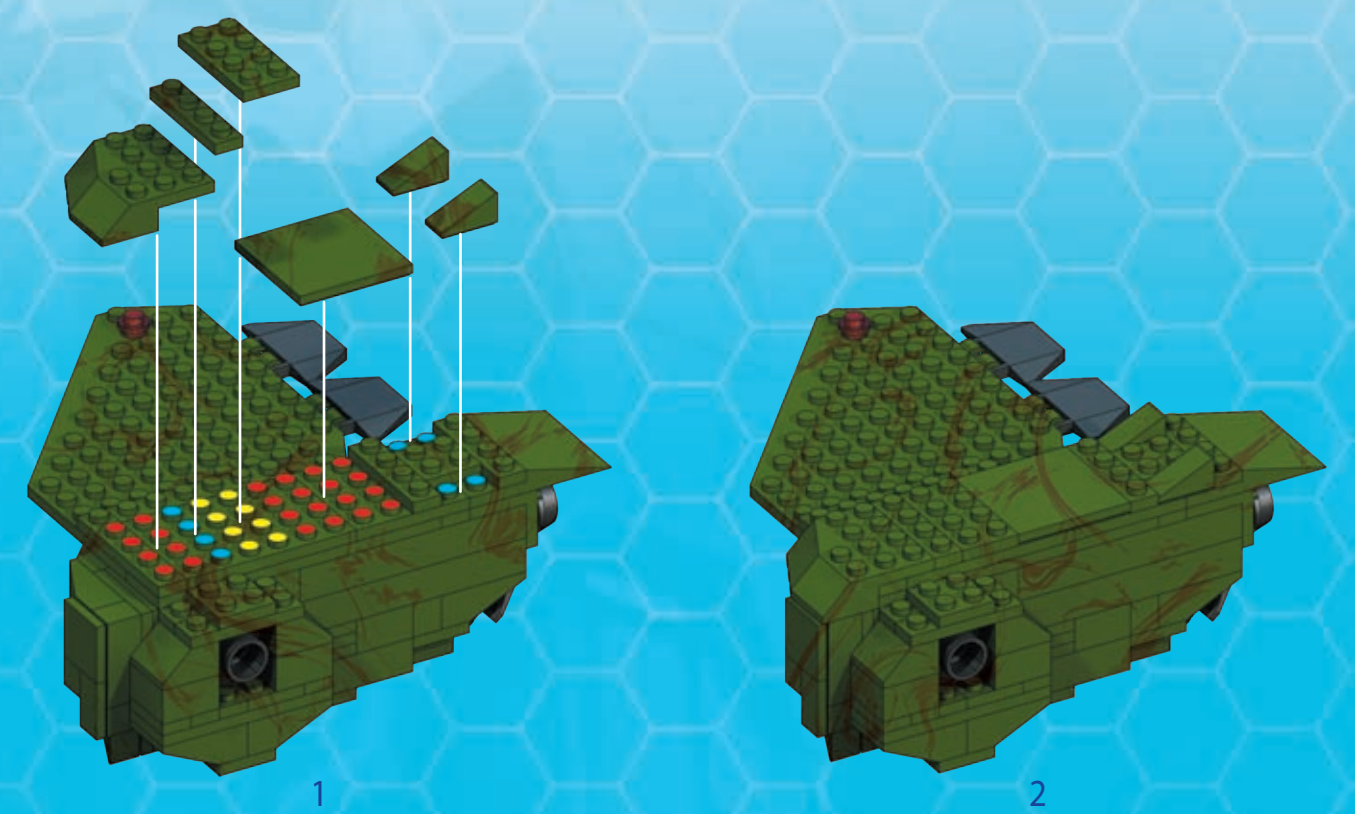
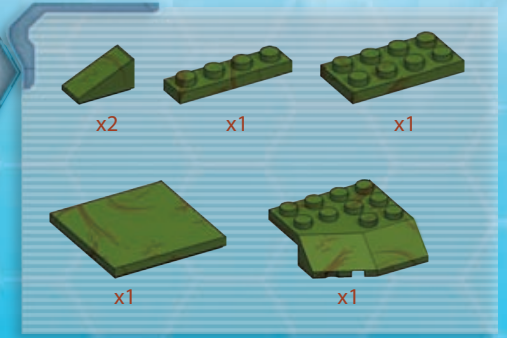



83

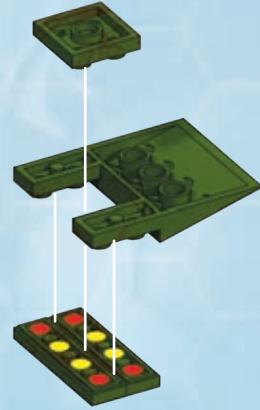
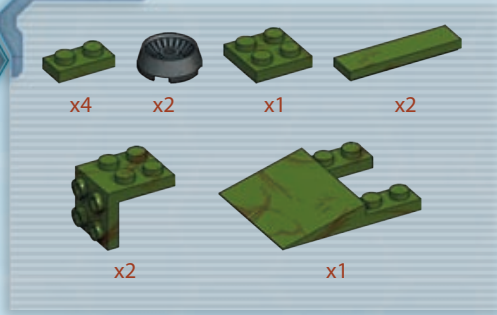

1



2

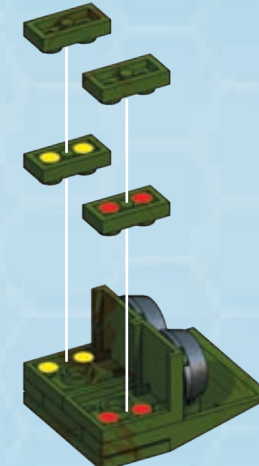
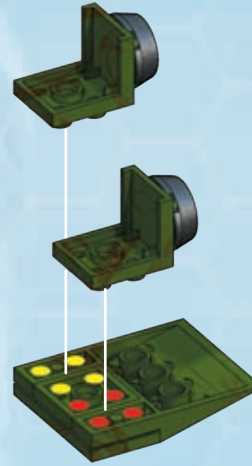

3



4

84

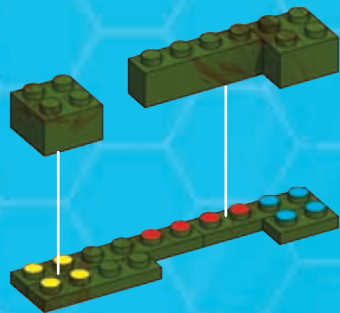
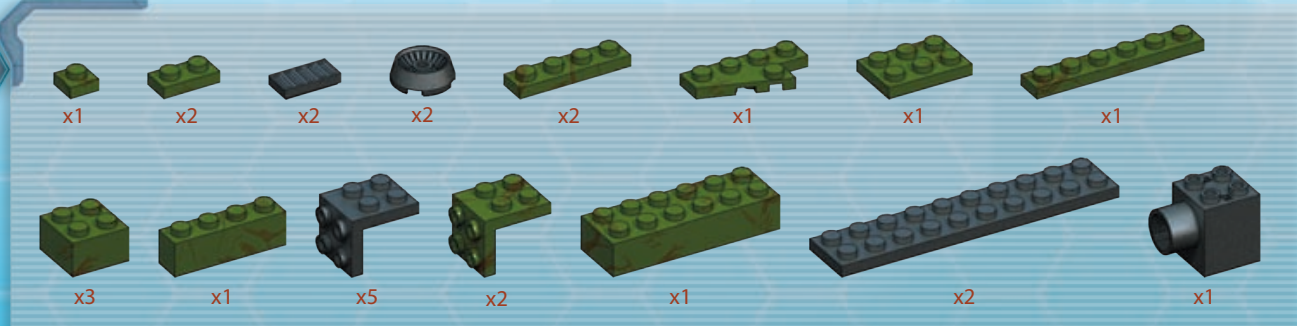

1

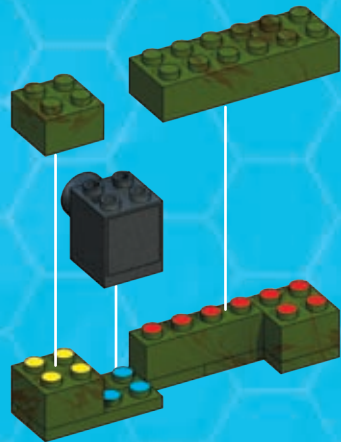

2

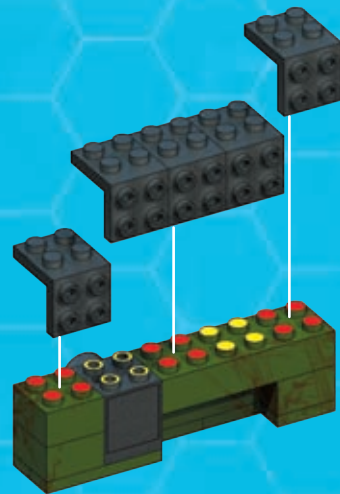

3

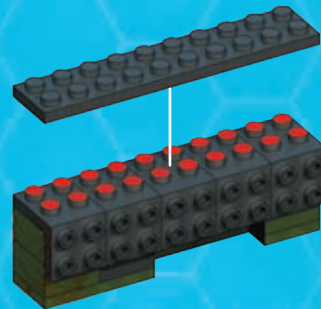

4

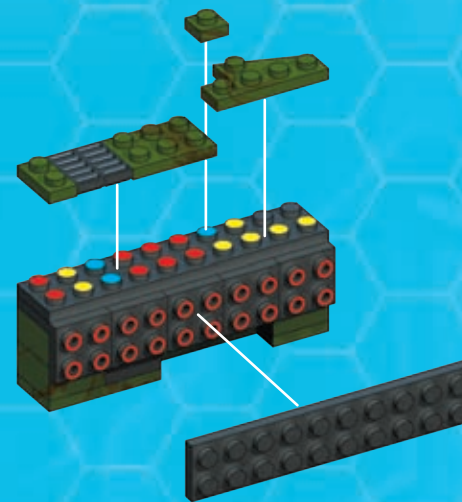

5

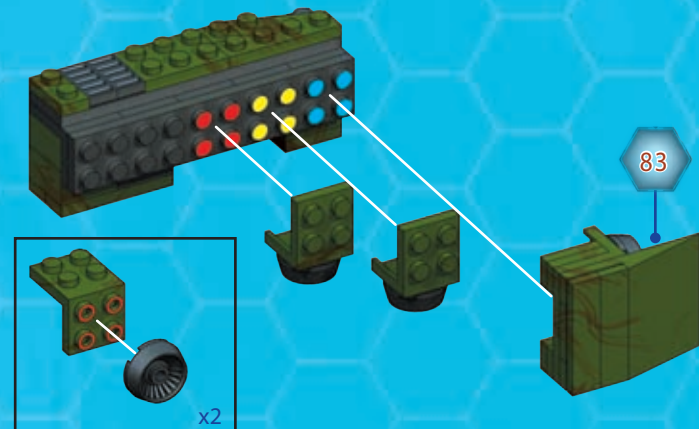

6

83

85

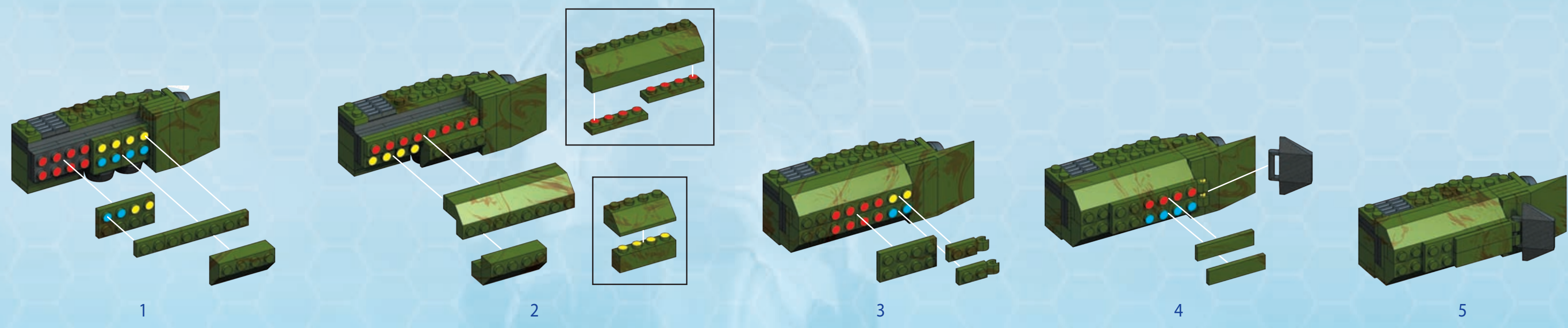

86

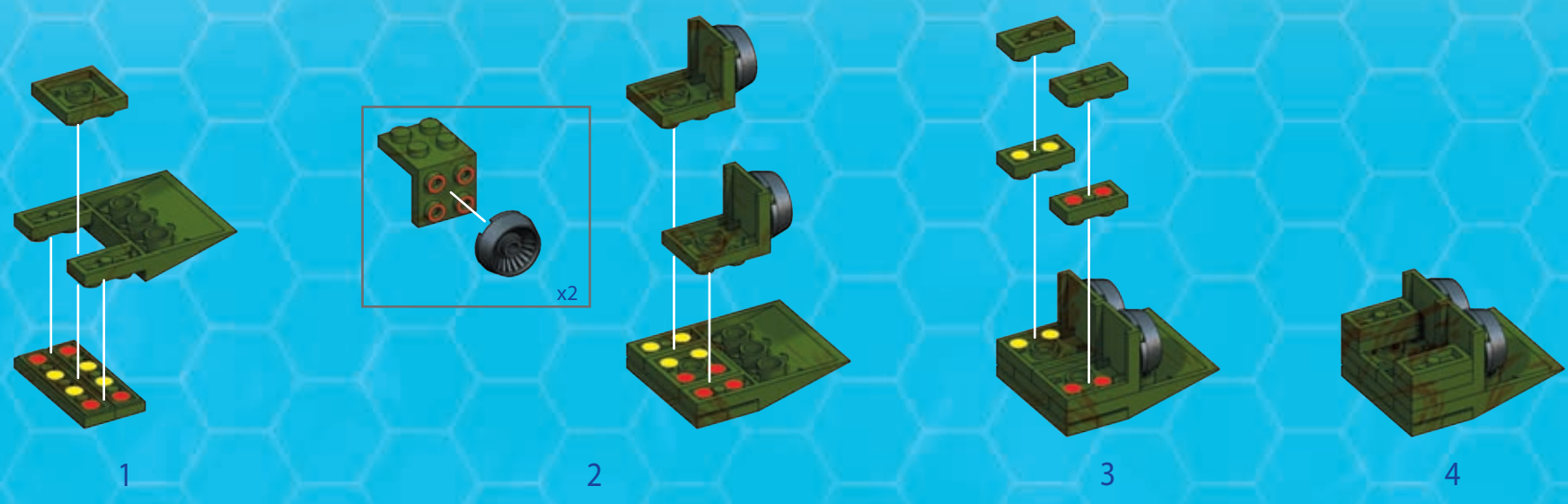

87

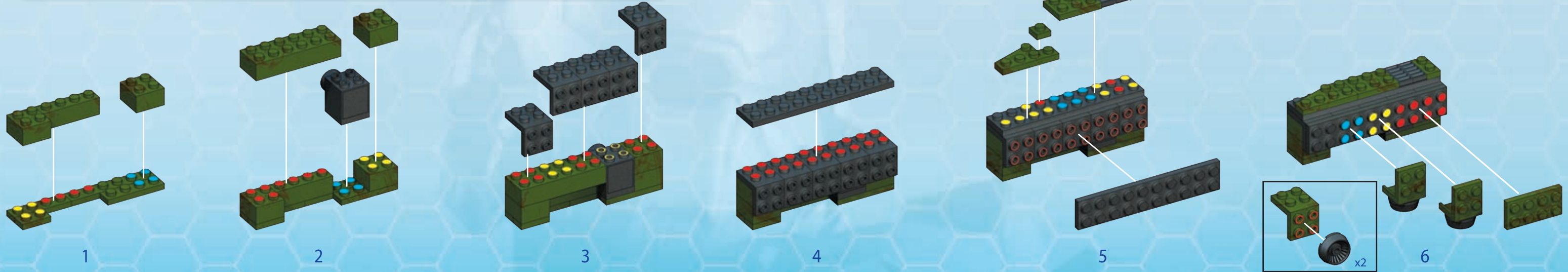
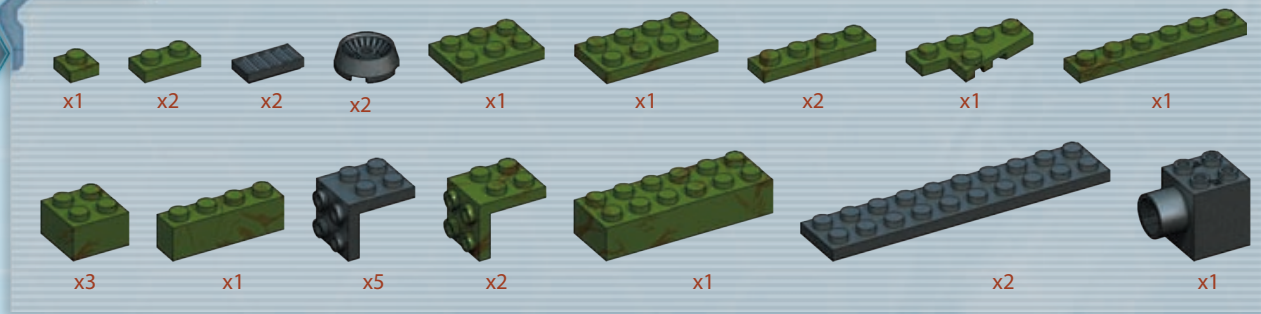

88

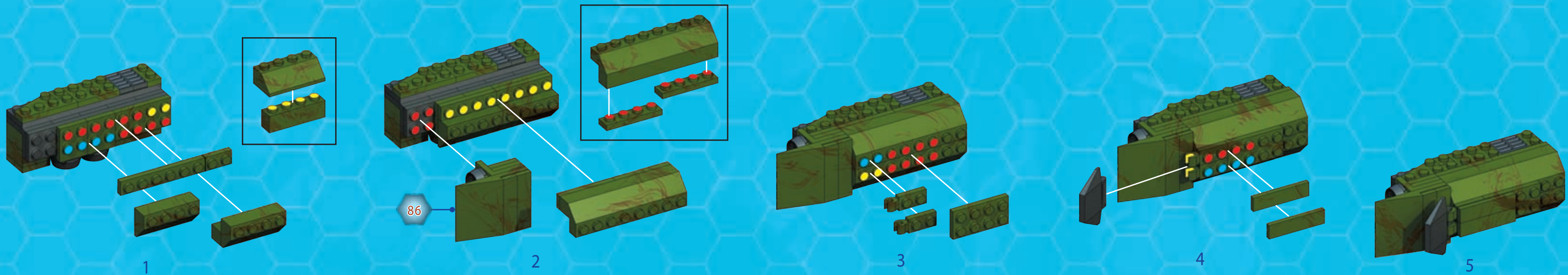



89

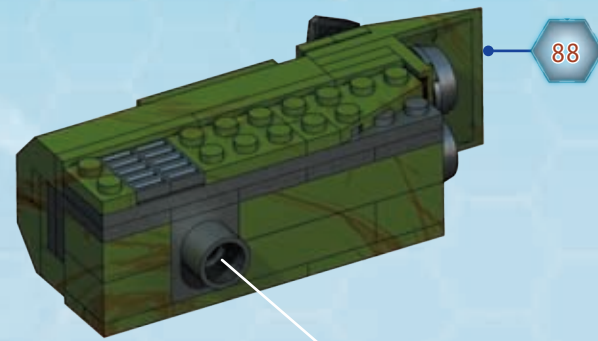

88



82

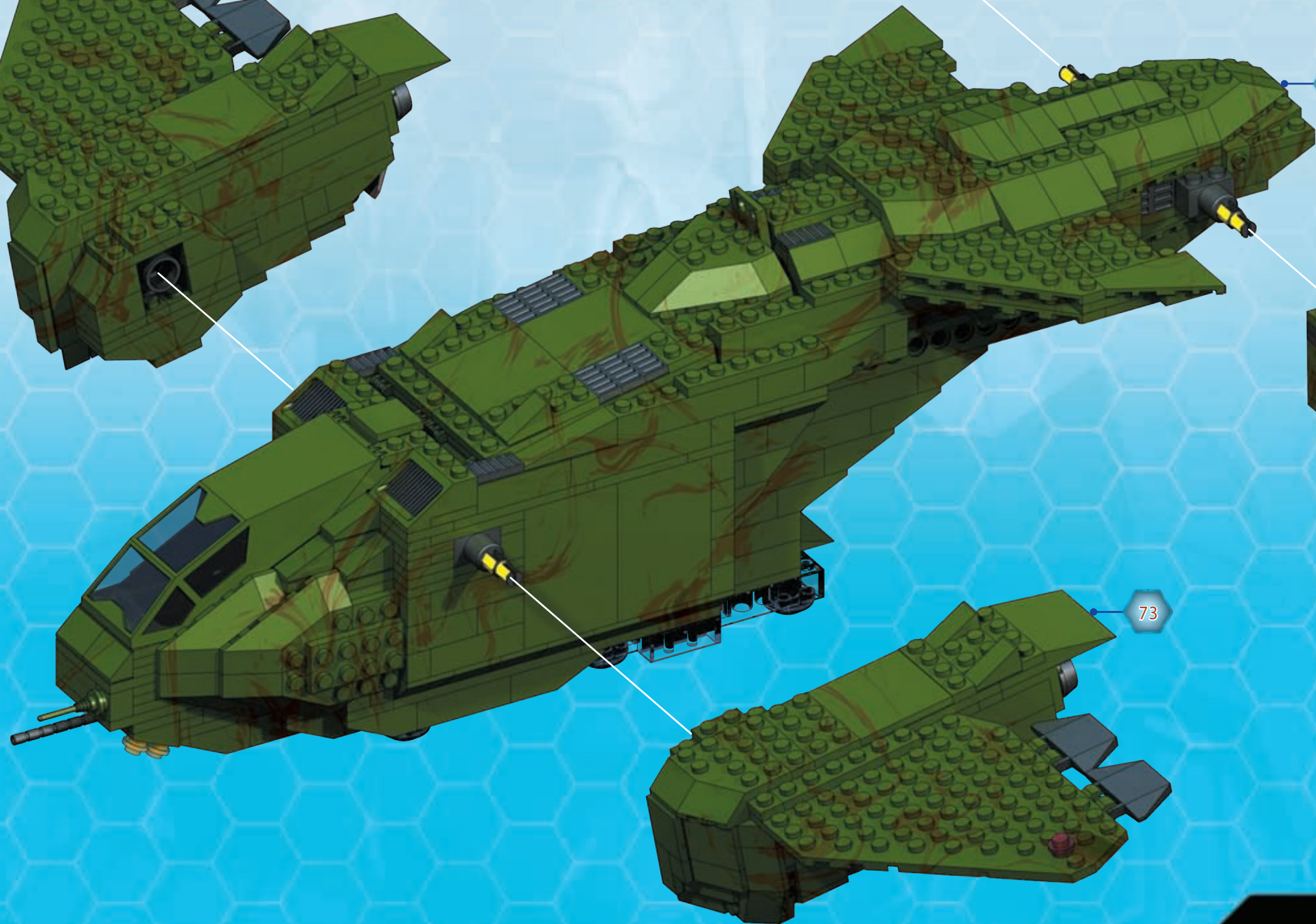

64



85



73

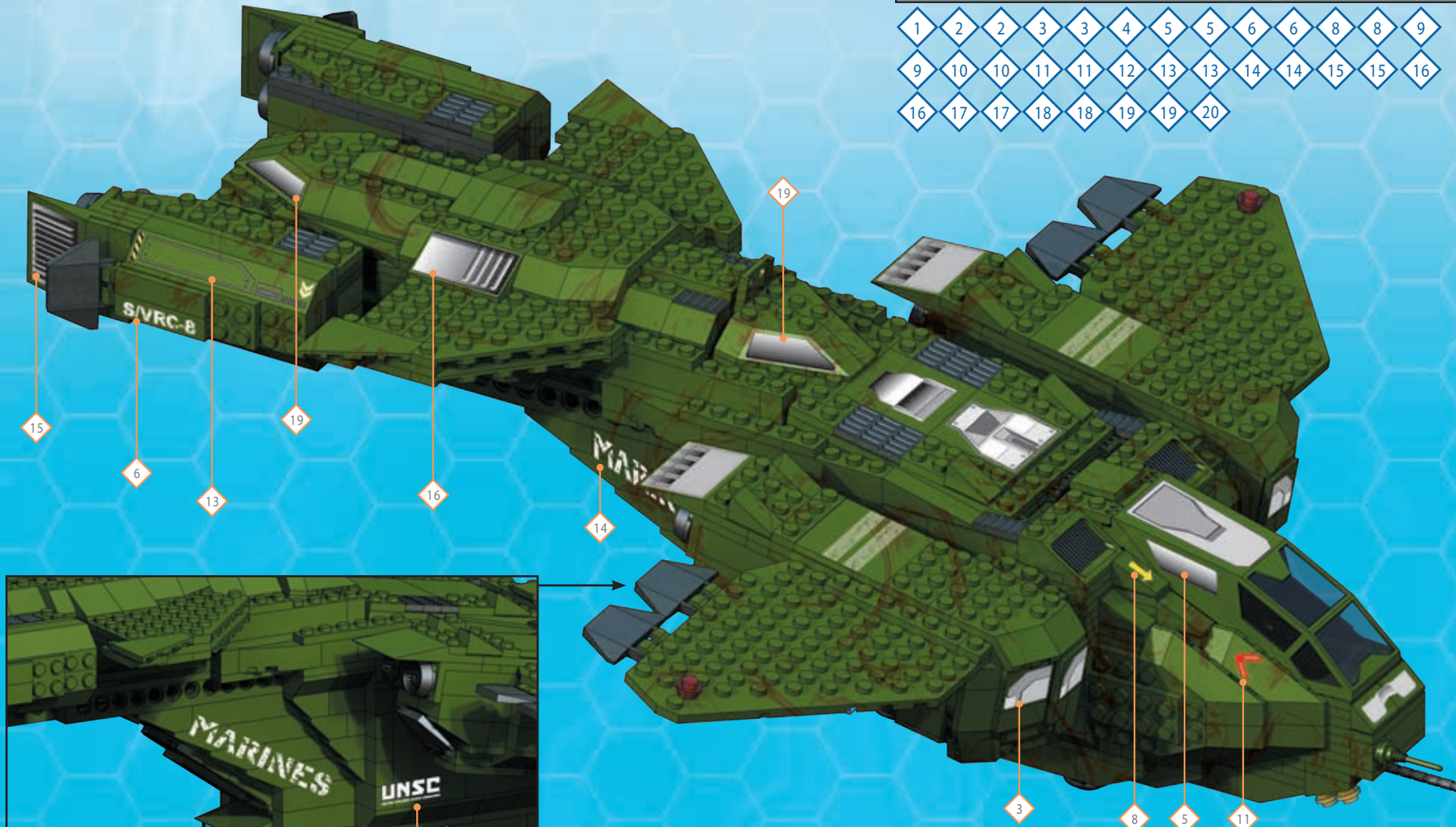
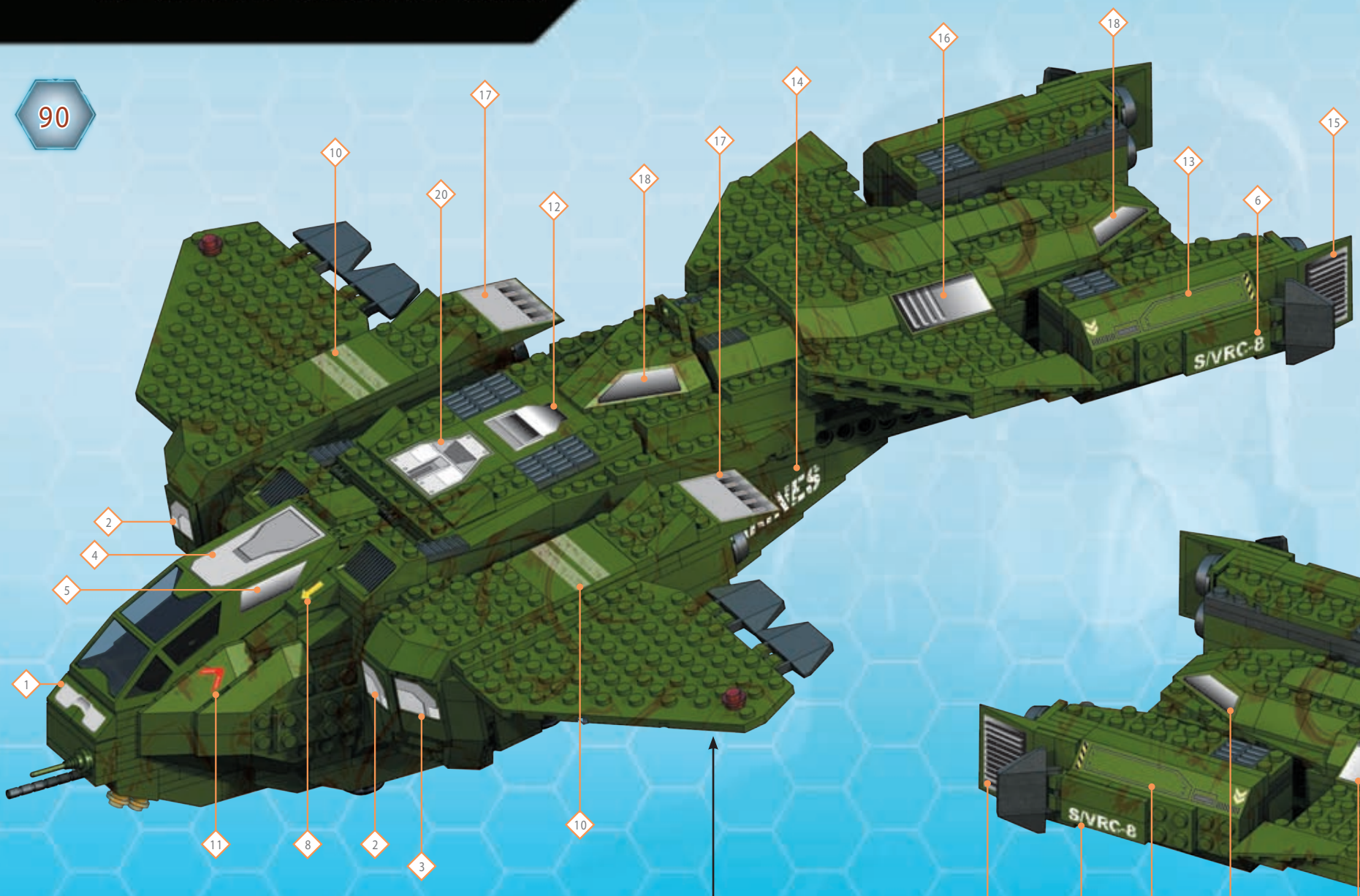

1	2	2	3	3	4	5	5	6	6	8	8	9
9	10	10	11	11	12	13	13	14	14	15	15	16
16	17	17	18	18	19	19	20					



UNSC PELICAN DROPSHIP

A mainstay of the UNSC military, the Pelican dropship's primary role is to deliver troops, equipment and weaponry to and from forward combat positions, making them an essential tool in the war against the Covenant. The Pelican can deploy or evacuate UNSC forces within moments of landing thanks to its easily accessible rear bay door.

Envío Pelicano UNSC

Uno de los pilares que soportan a la milicia del UNSC, la función principal del Pelican Dropship es llevar y traer a las tropas, equipo y armamento hacia las posiciones del frente de batalla, por lo que es una de las herramientas esenciales en la guerra contra el Pacto. El Pelican puede desplegar o evacuar fuerzas de la UNSC luego de que aterrizan los tanques a través de su fácilmente accesible puerta de carga posterior.

Voitureau Pelican du CSNU

Une pièce maîtresse des forces militaires de l'UNSC, le rôle principal du véhicule Pelican est de transporter les troupes, l'équipement et les armes de l'une à l'autre des positions de combat; ce qui en fait un outil essentiel à la guerre contre les Covenant. Le Pelican peut déployer ou évacuer les forces de l'UNSC dans les moments suivants son atterrissage grâce à sa porte de baie arrière facilement accessible.

Pelican Dropship der UNSC

Als Säule der UNSC-Streitkräfte besteht die Hauptaufgabe des Truppentransporters Pelican darin, Truppen, Ausrüstung sowie Waffen zum Kampfeschehen zu transportieren bzw. wieder abzutransportieren. Das Luftfahrzeug ist daher ein entscheidender Faktor im Kampf gegen die Allianz. Dank seiner leicht zugänglichen Heckklappe kann der Pelican UNSC-Streitkräfte innerhalb von Sekunden nach der Landung abladen bzw. evakuieren.

Pelican Dropship van de UNSC

Als steunpilaar van de militaire strijdkrachten van de UNSC is de primaire rol van het Pelican dropvliegtuig het vervoeren van troepen, uitrusting of wapens van en naar de meest geavanceerde posities, waardoor het een essentieel instrument is in de strijd tegen de Covenant. De Pelican kan in enkele momenten UNSC-krachten droppen of evacueren dankzij de gemakkelijk toegankelijke openzwalende achterdeur.

Pelican Dropship del UNSC

Un punto di forza dell'UNSC, il ruolo principale della navetta Pelican è trasportare truppe, attrezzature e armi alle e dalle posizioni di combattimento avanzate, rendendole quindi uno strumento essenziale nella guerra contro l'Alleanza. Il Pelican può trasportare o evacuare le forze UNSC in pochi momenti dall'atterraggio grazie alla sua porta posteriore facilmente accessibile.

Pelican CSNU

Um dos suportes principais do exército CSNU, o principal papel do cargueiro Pelican (Pelicano) é transportar tropas, equipamento e armamento de e para posições de combate avançadas, fazendo deles ferramentas essenciais na guerra contra os Covenant. O Pelican é capaz de mobilizar ou evacuar forças CSNU em instantes após a aterragem, graças à sua porta traseira de compartimento de cargas facilmente acessível. Os quatro propulsores rotatórios de VTOL (Vertical Takeoff and Landing ou Decolagem e Aterragem Vertical) do Pelican aumentam a sua versatilidade, ao permitir que este manobre e pouse em quase todo o terreno.

CAMOUFLAGE
EFFECT
EFFECTO DE
CAMUFLAJE
EFFET
CAMOUFLAGE
TARNEFFEKT
CAMOUFLAGE EFFECT
EFFETTO MIMETICO
EFEITO CAMUFLAGEM



Collect them all! - ¡Colecciónalos todos! - Collectionne-les tous!
Hol sie dir alle! - Verzamel ze allemaal! - Collezionali tutti! - Colecione todos eles!



Hayabusa Spartan
Spartiate hayabusa
Spartani Hayabusa



UNSC Spartan II
Spartiate du CSNU II
UNSC-Spartaner II
VN Spartan II
Spartano UNSC II
Espartano da UNSC II



UNSC Pelican Pilot
Piloto Pelicano de las fuerzas UNSC
Pilote Pelican du CSNU
Pelikaanpiloot voor UNSC
Pilota UNSC Pelican
Piloto Pelicano CSNU



96852

96818

96805

96823

96849

96845