

**MEGA
BLOKS**

HALO



97118

Cauldron Clash • Choque de Cauldron • Combat dans le Cauldron
Cauldron-Schlacht • Gevecht in de Cauldron • Scontro Calderone • Choque de Caldeirão

Cauldron Clash

Welcome to the Cauldron – a multi-player map on Requiem where the best troops mix it up in a fight for survival inside a Forerunner structure. Two new UNSC Marines are in tough against Promethean Knight, Watcher and Crawler that are programmed to defend its Forerunner secrets at any cost.

Choque de Cauldron

Bienvenido a Cauldron – un mapa de varios jugadores en réquiem donde las mejores tropas se mezclan en una lucha por sobrevivir dentro de una estructura de Forerunner. Dos nuevos Infantes de Marina de CENU que se encuentran en una fuerte lucha contra el caballero Promethean, el observador y el vehículo de cadenas que están programados para defender los secretos de Forerunner a cualquier precio.

Combat dans le Cauldron

Bienvenue au Cauldron – Une carte multijoueur de Requiem où les plus grands guerriers s'affrontent pour survivre à l'intérieur d'une structure Forerunner. Deux nouveaux Marines du CSNU combattent un Guerrier Promethean, un Observateur et un Marcheur qui sont programmés pour protéger les secrets de la structure Forerunner à tout prix.

Cauldron-Schlacht

Willkommen auf Cauldron – einer Multi-Player-Karte auf Requiem, wo die besten Truppen in einer Forerunner-Struktur einen erbitterten Kampf ums Überleben führen. Zwei neue VNWK-Marines richten sich gegen Promethean Ritter, Beobachter und Kettenraupe, die so programmiert, dass sie ihre Forerunner -Geheimnisse um jeden Preis verteidigen.

Gevecht in de Cauldron

Welkom bij de Cauldron – een Requiem-multiplayerplattegrond waar de beste troepen in een Forerunner-bouwwerk vechten voor hun leven. Twee nieuwe UNSC -mariniers nemen het op tegen de Promethean ridder, wachter en Crawler die zijn geprogrammeerd om de Forerunner-mysterie tegen elke prijs te verdedigen.

Scontro Calderone

Benvenuti a Cauldron: una mappa multiplayer su Requiem, dove le migliori truppe si scontrano in una lotta per la sopravvivenza all'interno della struttura Forerunner. Due nuovi Marine UNSC devono vedersela con un Cavaliere, un Osservatore e uno Strisciante Promethean programmati per difendere i segreti del Forerunner a qualsiasi costo.

Choque de Caldeirão

Bem vindo ao Caldeirão – um mapa para multijogadores em Requiem onde as melhores tropas se misturam em uma luta pela sobrevivência dentro de uma estrutura Forerunner. Dois novos UNSC Marines estão em luta contra o Cavaleiro Promethean, Sentinela e Rastejador, que são programados para defender seus segredos Forerunner a qualquer custo.



**MEGA
BLOKS**

HALO



Register for the Halo Bloks Brigade!
Apuntate a la brigada Halo Bloks!
Enrolez-vous dans la Brigade Halo Bloks!
Registriere dich fur die Halo-Bloks Brigade! • Schrijf je in voor de Halo Bloks Brigade!
Effetua la registrazione per la Brigata dei Blok Halo! • Regista-te para a Brigada Halo Bloks!

halo.megabloks.com

- 1X AMI7062W
- 2X AMI8260W
- 2X MI7506W
- 16X MII13KC
- 1X MAO7223MM
- 4X MO7223KC
- 2X MAO3328MM
- 1X MO3328KC
- 2X AMI7127AGV
- 6X MAI5258AGV
- 20X MAI086F
- 10X MAI086AGV
- 16X AM07629F
- 2X MAO9198AGV
- 7X MCO22502KC
- 6X MO7590KC

- 13X MO9393KC
- 10X MAO9393AGV
- 12X MAO9393MM
- 22X MO9393X
- 4X MAO3019AGV
- 1X MAO3019F
- 16X MAI417AGV
- 2X MAI417F
- 1X AM07658MM
- 14X MAO9013AGV
- 2X MO9013KC
- 1X MAII01MM
- 4X MAI133AGV
- 14X MAI322AGV

- 4X MO948KC
- 2X MCO3773KC
- 4X MCO3773X
- 4X MAO3773MM
- 2X MAI8328AGV
- 2X MAI8328MM
- 4X MAI8329MM
- 2X AMI6967W
- 2X MAI0273F
- 2X MAI0273MM
- 6X MAI0273AGV
- 23X MAI320AGV
- 2X AMI8658AGV

- 2X MAI154MM
- 2X MAI154F
- 7X MAI154AGV
- 6X MAO9023AGV
- 12X MAO9023F
- 1X MBI4X
- 2X MAI314AGV
- 5X MBI4KC
- 1X MAI314MM
- 2X MAI418AGV
- 10X MAI323AGV
- 2X AMI8562AGV

- 1X AMI7074MM
- 1X AMI7073MM
- 2X AMI6384F
- 2X AMI6384AGV
- 1X MCO3772X
- 4X MAO3772MM
- 5X MCO3772KC
- 4X MAO4497MM
- 7X MAI39AGV
- 4X MCO9593KC
- 4X MAO9593MM
- 3X MCO9593X

- 4X AMI6959AGV
- 4X MAI087AGV
- 10X MAI087F
- 2X MAI087MM
- 1X MIO87KC
- 9X MAO9033F
- 1X MCO9033KC
- 1X MCO9493KC
- 7X MAO9493MM
- 2X MAO7475MM
- 9X MAO9292MM
- 4X MAO9292AGV

- 1X MO9292KC
- 12X MAI480MM
- 1X MAI480AGV
- 4X MAO8483MM
- 1X MAO9923MM
- 2X AMO4985AGV
- 8X AMI5510AGV
- 2X MAI172F
- 2X MII72KC
- 2X MAI172MM

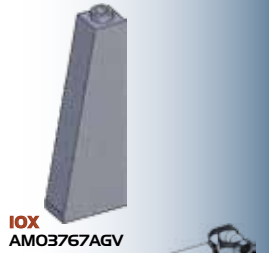

10X AM03767AGV



1X AMI7780W



1X AS9711812



2X AMI7055MM



2X AMO3770MM

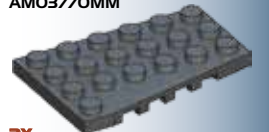

2X AMO3771MM



1X AM72659F



1X AM72660F



1X AMI6701MM

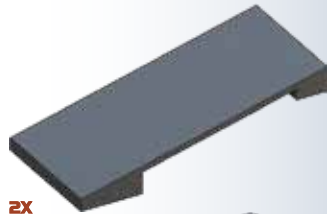

2X AMO1345MM

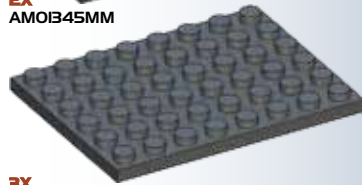

3X AMO2237MM

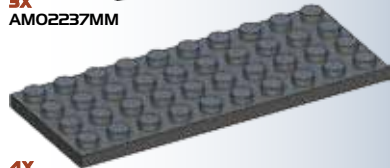

4X AMO9924MM

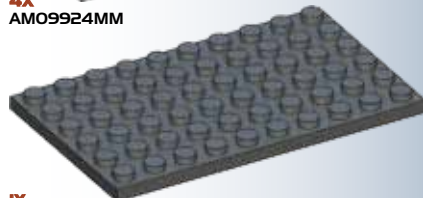

1X AMI5476MM



1X AMI8845ANW

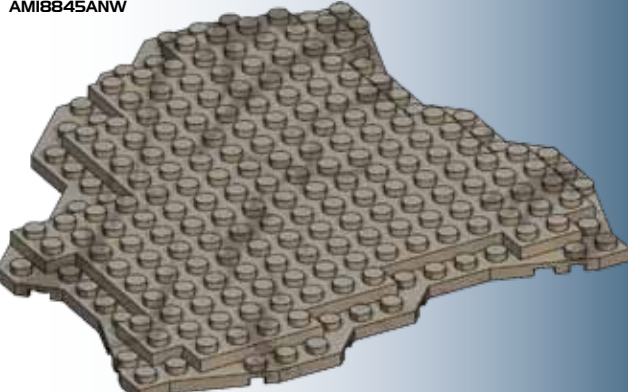

2X AMI8882ANW



1X A59711810



1X A59711809

1X A59711808

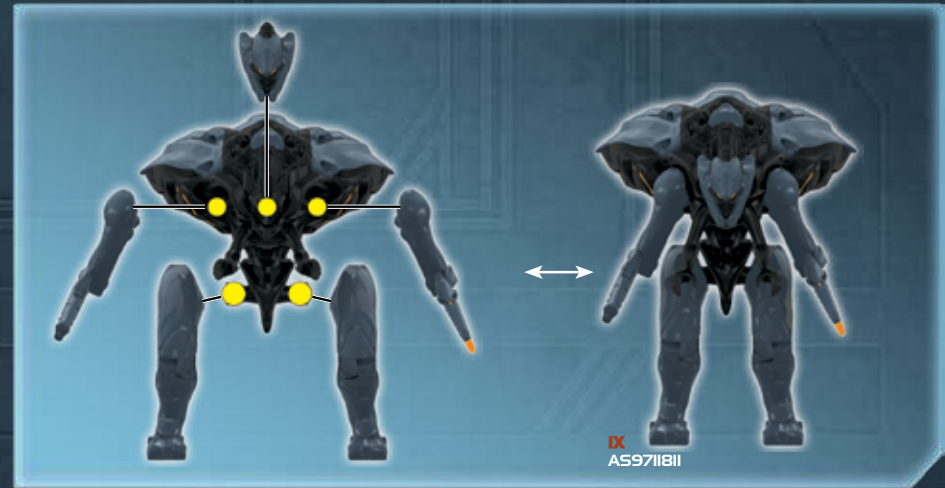

1X A59711811

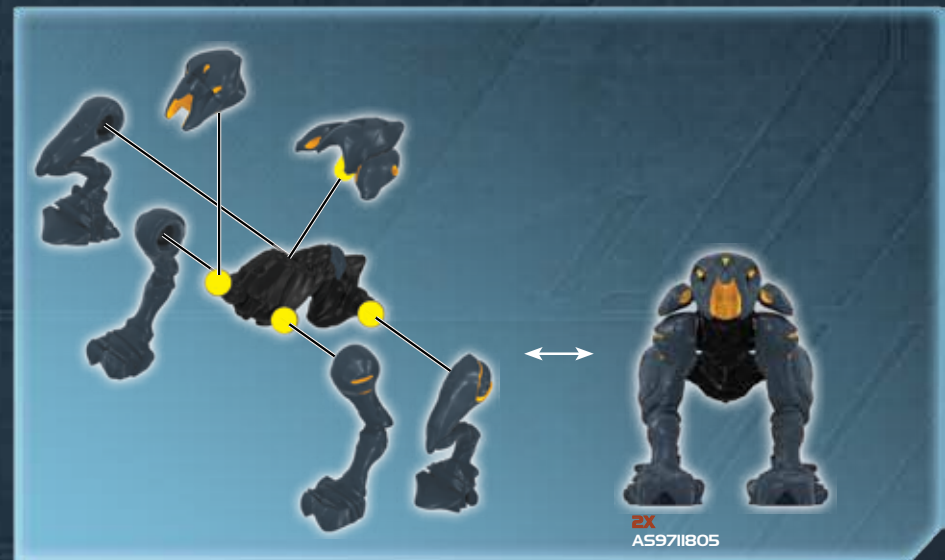

2X A59711805



- EN** Please read these instructions carefully before first use and keep them for future reference.
- FR** Il est recommandé de lire attentivement ce feuillet avant la première utilisation et de le conserver pour référence future.
- ES** Leer estas instrucciones cuidadosamente antes de la primera utilización y guardarlas para referencia futura.
- DE** Die Gebrauchsanleitung bitte durchlesen und aufbewahren.
- NL** Wij raden u aan deze handleiding zorgvuldig te lezen en te bewaren voor eventuele raadpleging op een later tijdstip.
- IT** Leggere le istruzioni prima di cominciare ad usare il gioco e conservarle per referenze future.
- PT** Leia as instruções antes do primeiro uso e guarde-as para futura referência.
- PL** Proszę uważnie przeczytać instrukcję obsługi przed pierwszym użyciem, a następnie zachować ją na przyszłość.
- DA** Vær venlig at læse disse instruktioner omhyggeligt inden ibrugtagten og opbevar dem til fremtidigt brug.
- EL** Διαβάστε αυτές τις οδηγίες προσεκτικά πριν χρησιμοποιήσετε το προϊόν για πρώτη φορά και φυλάξτε τις για μελλοντική αναφορά.
- FI** Lue nämä ohjeet huolellisesti ennen ensimmäistä käyttöä ja säilytä ne myöhempää tarvetta varten.
- NO** Les disse instruksjonene nøye før første gangs bruk, og ta vare på dem for fremtidige oppslag.
- SV** Läs noggrant igenom dessa instruktioner innan du använder produkten för första gången och spara dem för ev. framtida frågor.
- JA** 初めてご使用になる前に、この説明書をよくお読みください。また、本書は将来いつでも参照できるように保管してください。
- ZH** 请在初次使用前仔细阅读这些指示，并保留它们以便未来参考。
- AR** يرجى قراءة هذه التعليمات بدقة قبل البدء بالاستعمال والاحتفاظ بها كمرجع للمستقبل

- EN** ⚠ **WARNING :**
CHOKING HAZARD. - Small parts.
Not for children under 3 years.
- FR** ⚠ **ATTENTION :**
DANGER D'ÉTOUFFEMENT. - Présence de petits éléments.
Ne convient pas aux enfants de moins de 3 ans.
- ES** ⚠ **ADVERTENCIA :**
RIESGO DE ASFIXIA. - Contiene piezas pequeñas.
No recomendado para niños menores de 3 años.
- DE** ⚠ **ACHTUNG :**
ERSTICKUNGSGEFAHR. - Enthält kleine Teile.
Nicht für Kinder unter 3 Jahren geeignet.

- NL** ⚠ **WAARSCHUWING :**
VERSTIKKINGSGEVAAR. - Bevat kleine onderdelen.
Niet geschikt voor kinderen onder de 3 jaar.
- IT** ⚠ **AVVERTENZA :**
PERICOLO DI SOFFOCAMENTO. - Contiene piccole parti.
Non indicato per bambini sotto i 3 anni.
- PT** ⚠ **ATENÇÃO :**
PERIGO DE ASFIXIA. - Contém peças pequenas.
Não é concebido para crianças de menos de 3 anos.
- PL** ⚠ **OSTRZEŻENIE :**
ZAGROŻENIE ZADŁAWIENIEM. - Małe elementy.
Nie nadaje się dla dzieci poniżej 3 lat.

- DA** ⚠ **ADVARSEL :**
FARE FOR KVÆLNING. - Indeholder smådele.
Ikke til børn under 3 år.
- EL** ⚠ **ΠΡΟΕΙΔΟΠΟΙΗΣΗ :**
ΚΙΝΔΥΝΟΣ ΠΝΙΓΜΟΥ. - Περιέχει μικρά αντικείμενα.
Όχι για παιδιά κάτω των 3 ετών.
- FI** ⚠ **VAROITUS :**
TUKEHTUMISVAARA. - Sisältää pieniä osia.
Ei alle 3-vuotiaille lapsille.
- NO** ⚠ **ADVARSEL :**
KVELNINGSFARE. - Inneholder små deler.
Kun for barn over 3 år.

- SV** ⚠ **VARNING :**
KVÄVNINGSRISK. - Innehåller små delar.
Inte för barn under 3 år.
- JA** ⚠ **警告 :**
のどにつまる危険。小さな部品が含まれています。
3歳以下の子供には与えないで下さい。
- ZH** ⚠ **警告 :**
噎住危险。包含有小部件。
不适合3岁以下的小孩玩。
- AR** ⚠ **تحذير :**
خطر الاختناق - قطع صغيرة.
غير صالحة للأطفال أقل من 3 سنوات.



Get the free mobile app for your phone
<http://gettag.mobi>

WARNING ! ACHTUNG ! ATENÇÃO ! VAROITUS ! 警告 !
ATTENTION ! WAARSCHUWING ! OSTRZEŻENIE ! ADVARSEL ! 警告 !
ADVERTENCIA ! AVVERTENZA ! ADVARSEL ! ΠΡΟΕΙΔΟΠΟΙΗΣΗ !
تحذير !



XBOX 360. 343 INDUSTRIES

© 2012 MICROSOFT CORPORATION. ALL RIGHTS RESERVED.
MICROSOFT, 343 INDUSTRIES, THE 343 INDUSTRIES LOGO,
HALO, THE HALO LOGO, XBOX, XBOX 360, AND THE XBOX LOGOS,
ARE TRADEMARKS OF THE MICROSOFT GROUP OF COMPANIES.

3

- 1X 
- 2X 
- 1X 
- 1X 

4

- 10X 

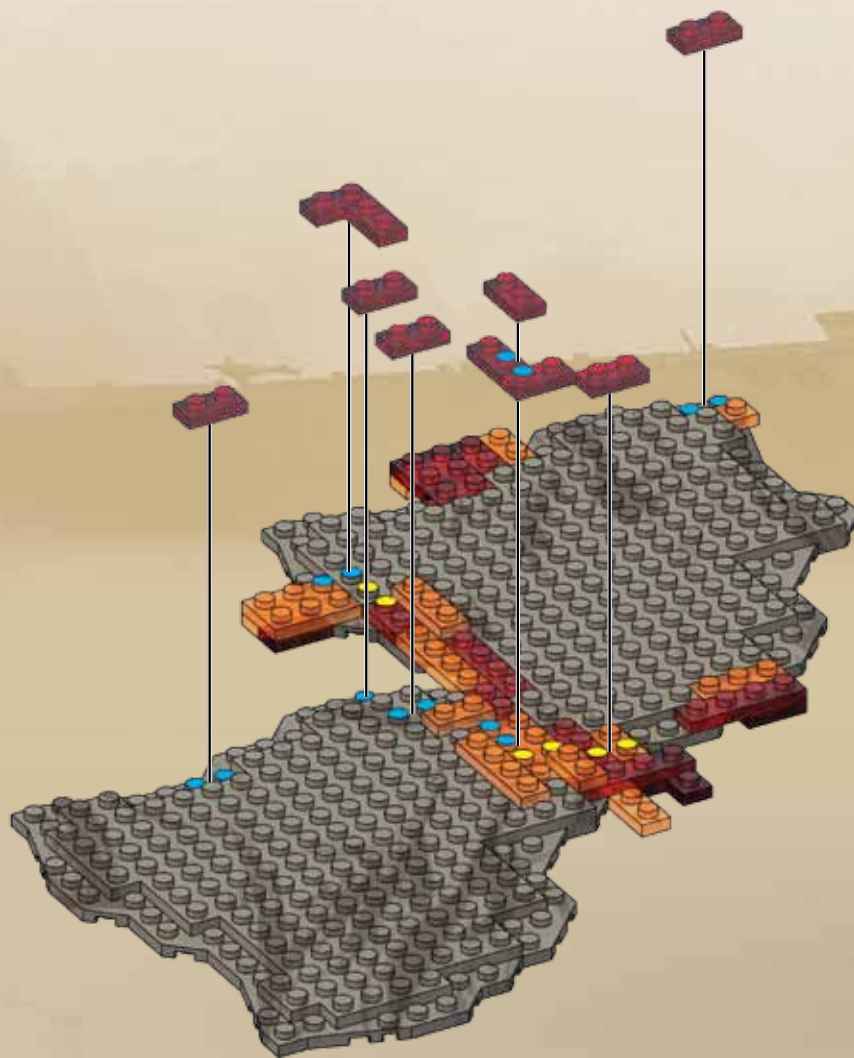
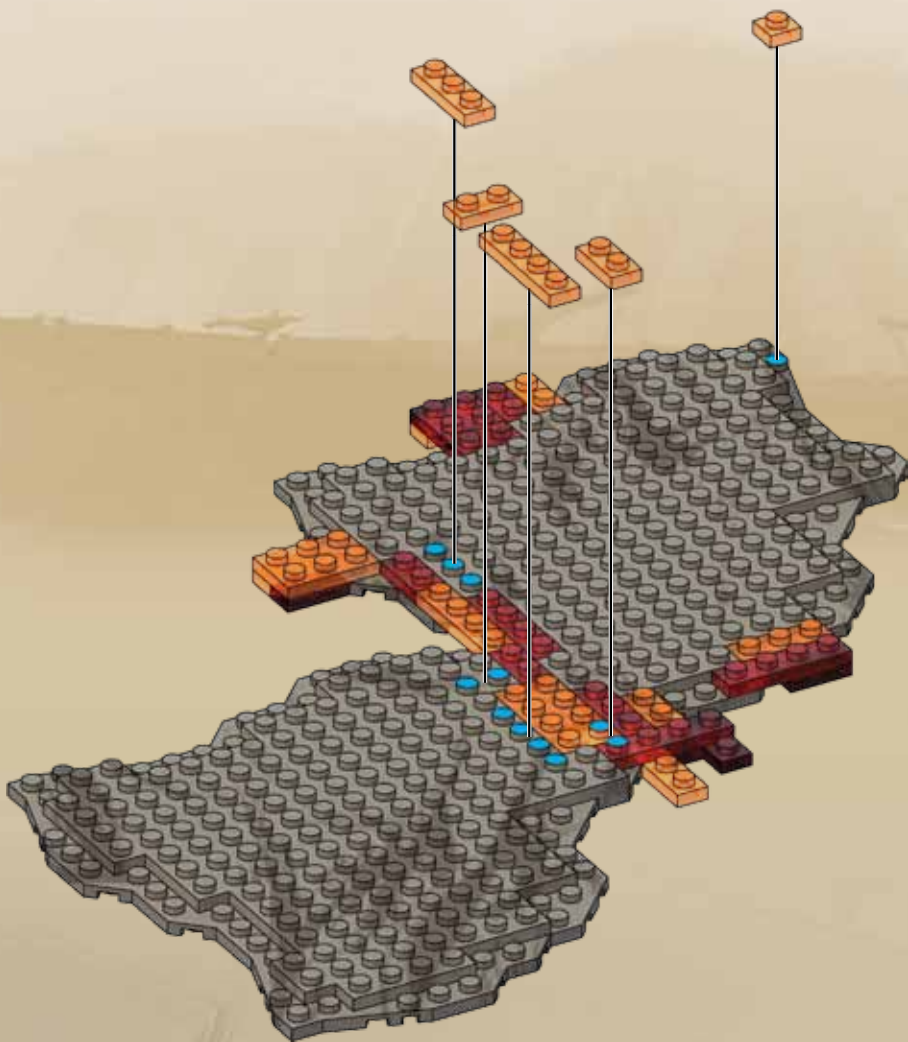

5

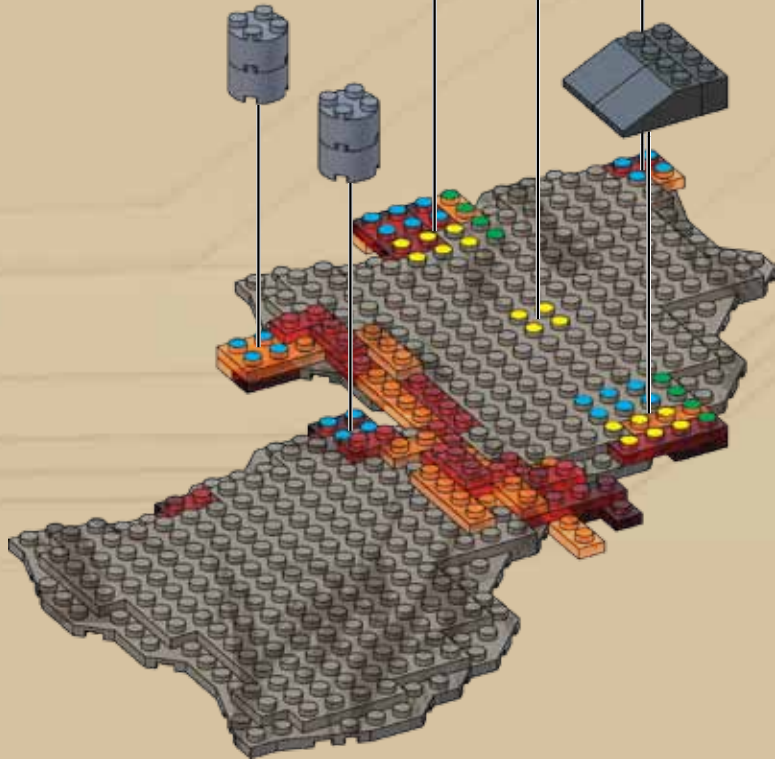

6

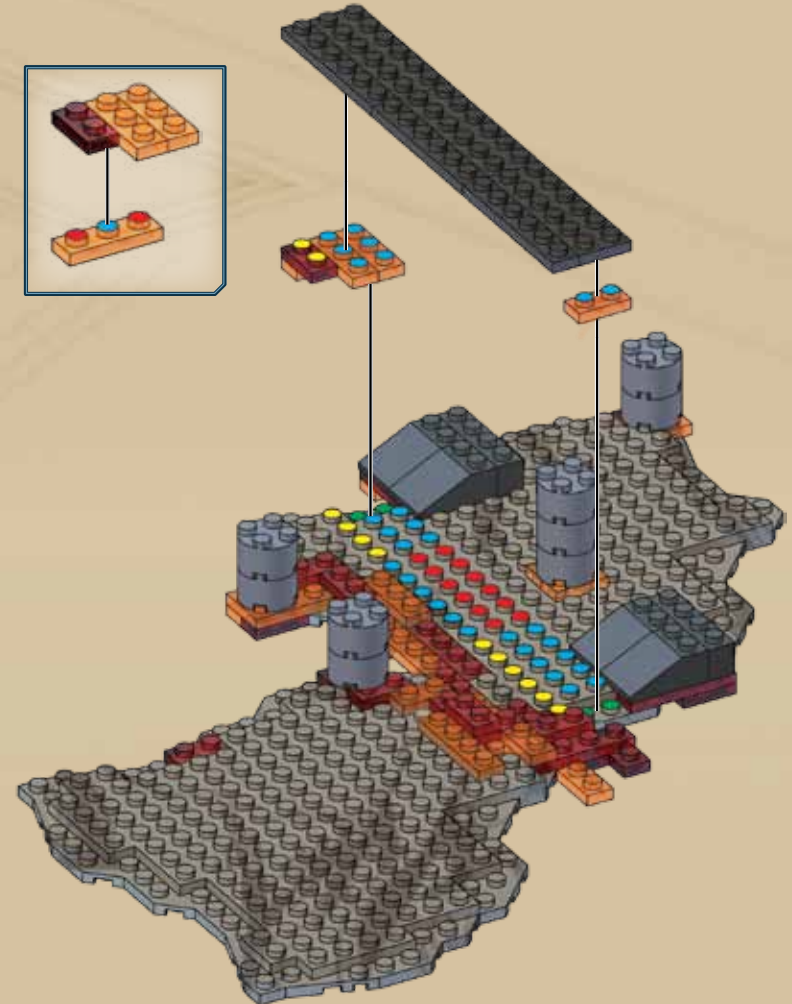

7

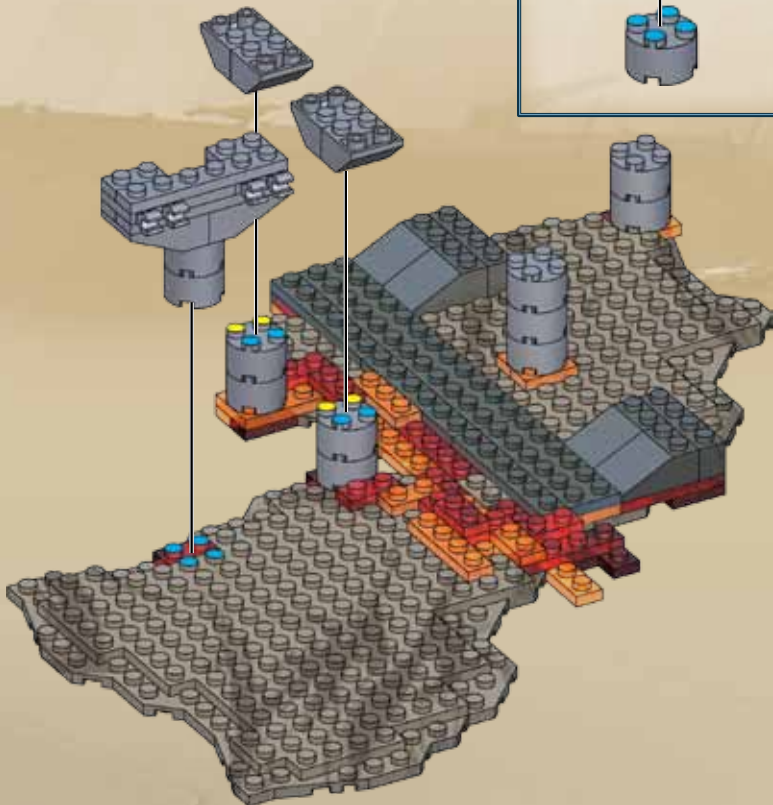
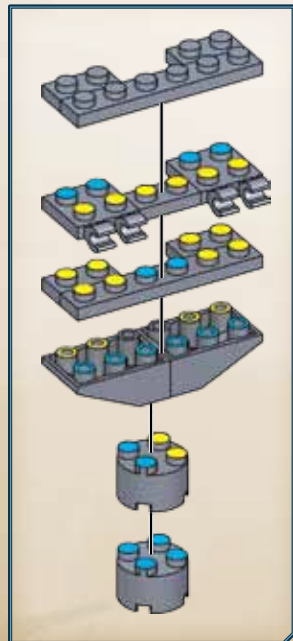

8

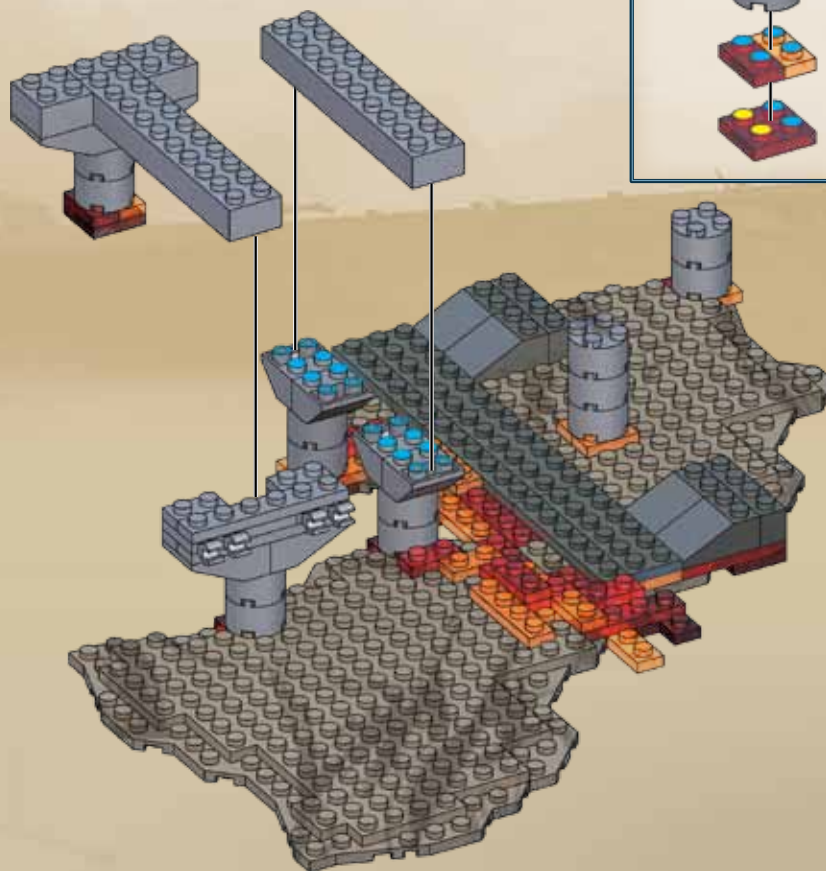
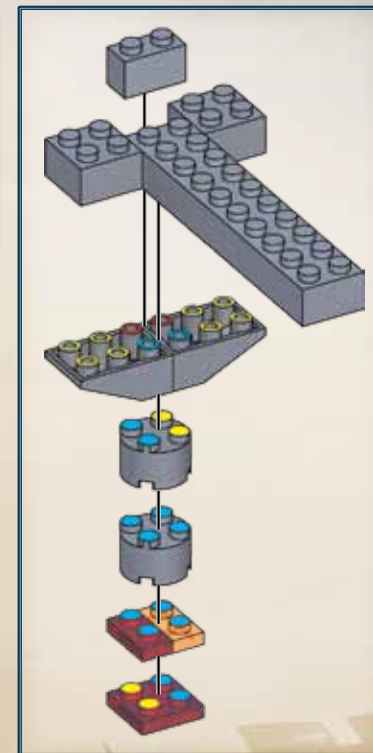

9

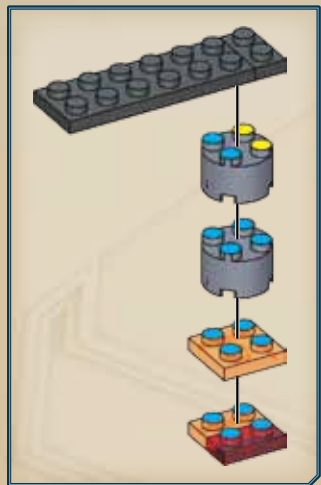
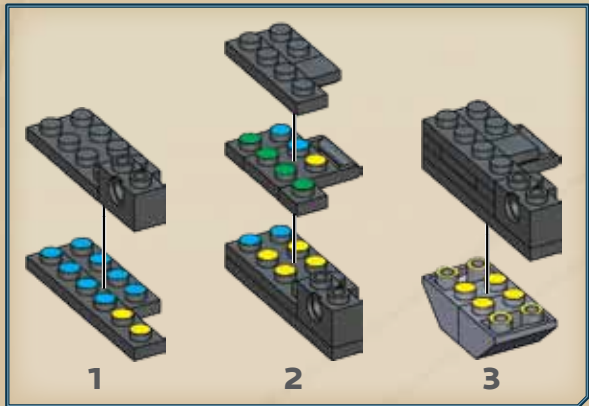
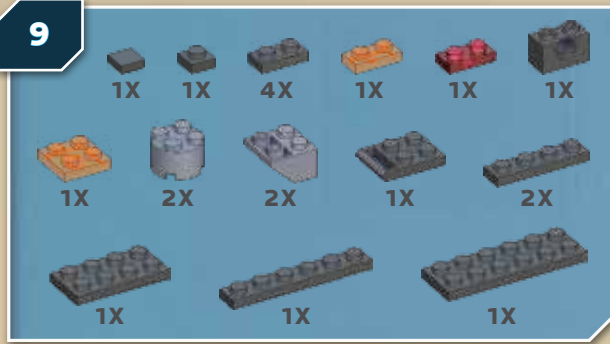

10

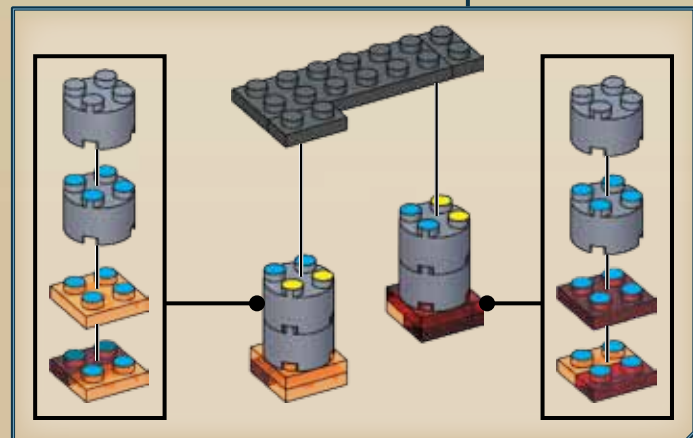
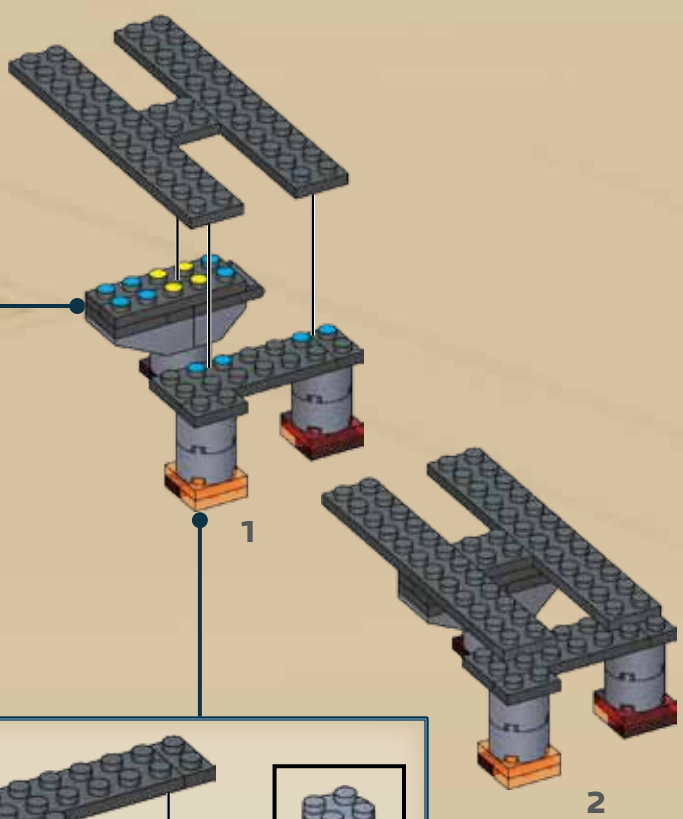
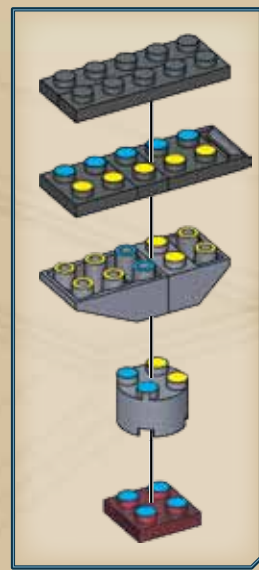
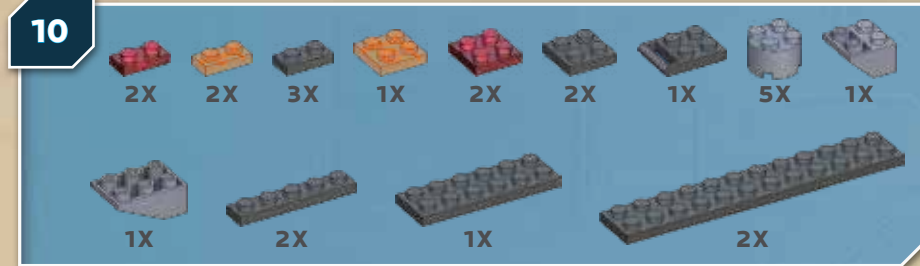

12

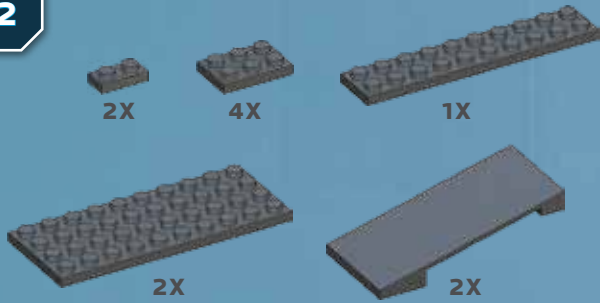

13

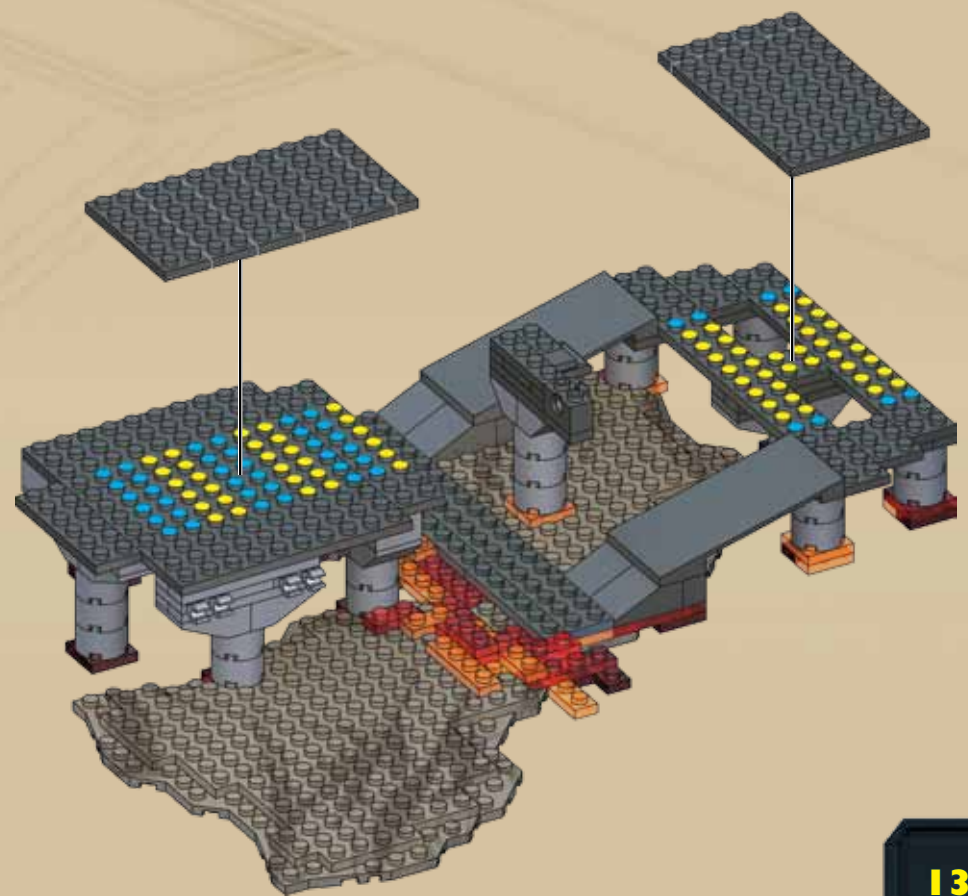
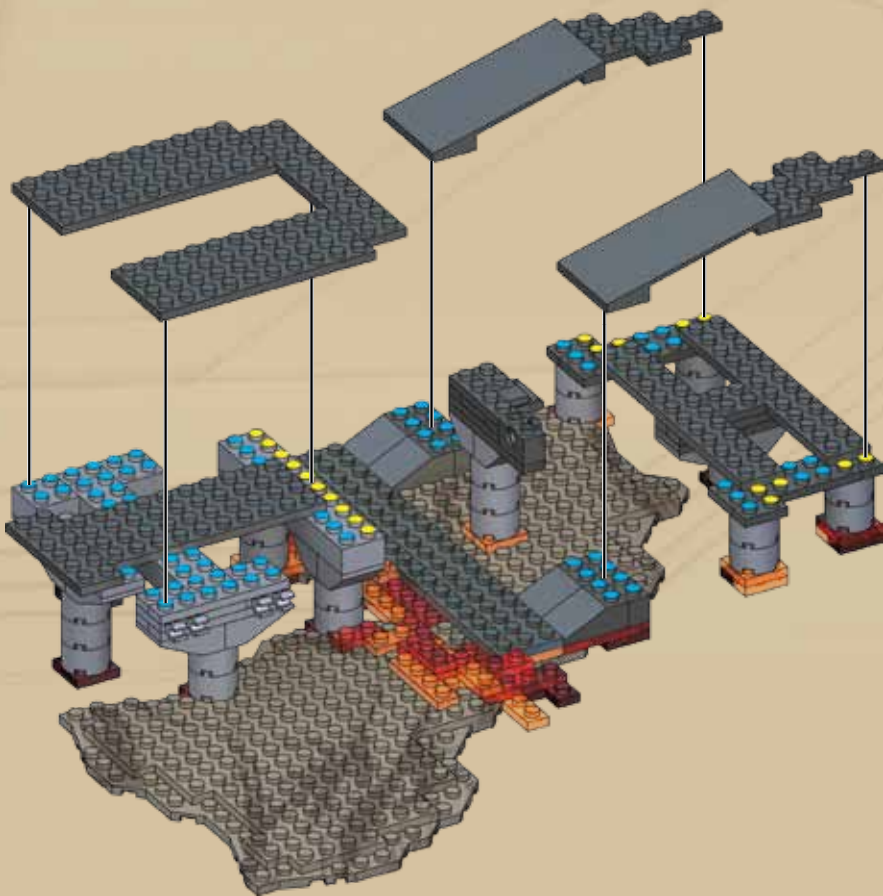

14



15

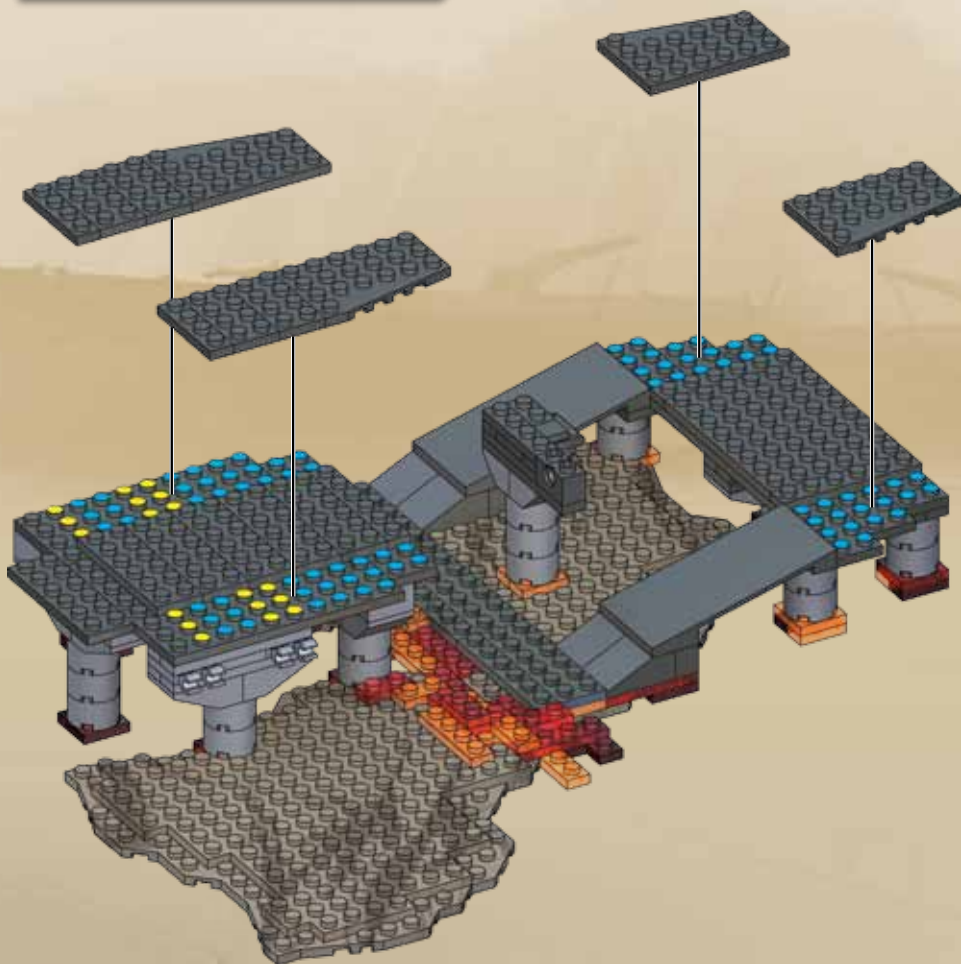

16

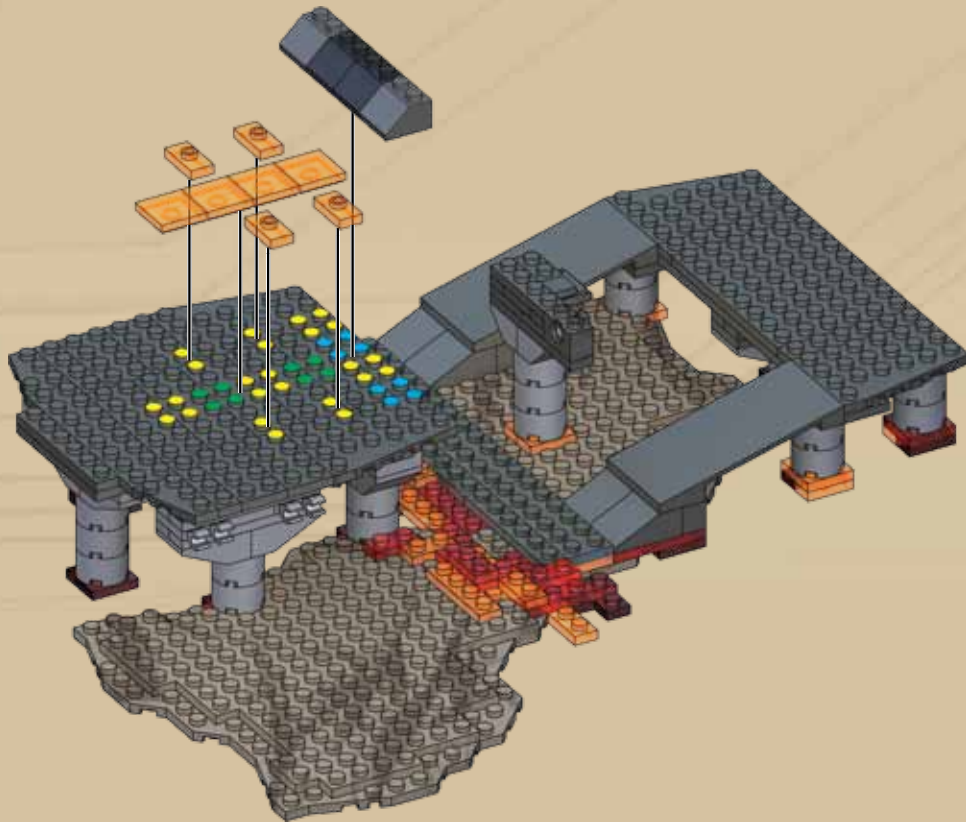

17

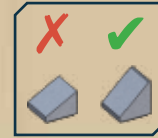
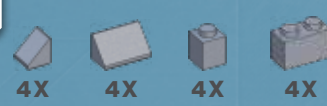

18



2X



2X



3X



2X



2X



3X



2X



3X



1X



1X

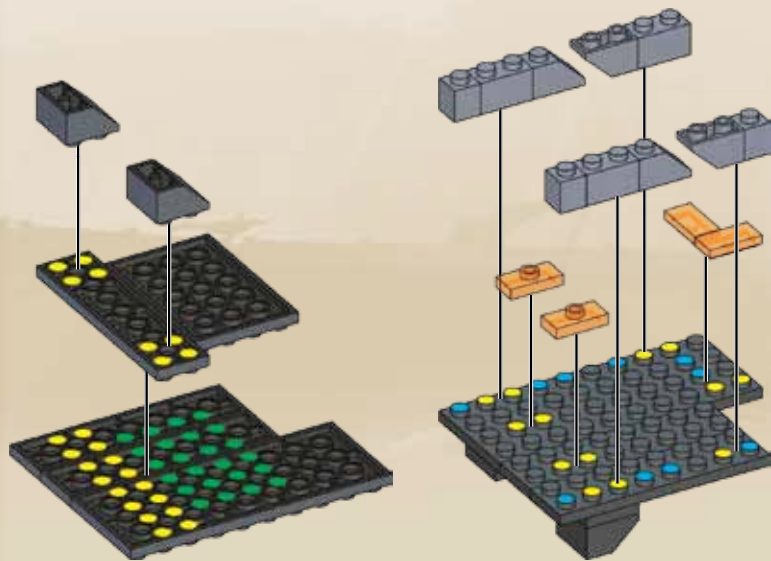

1

2



20

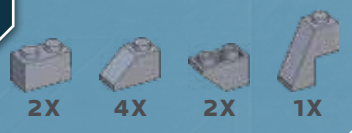



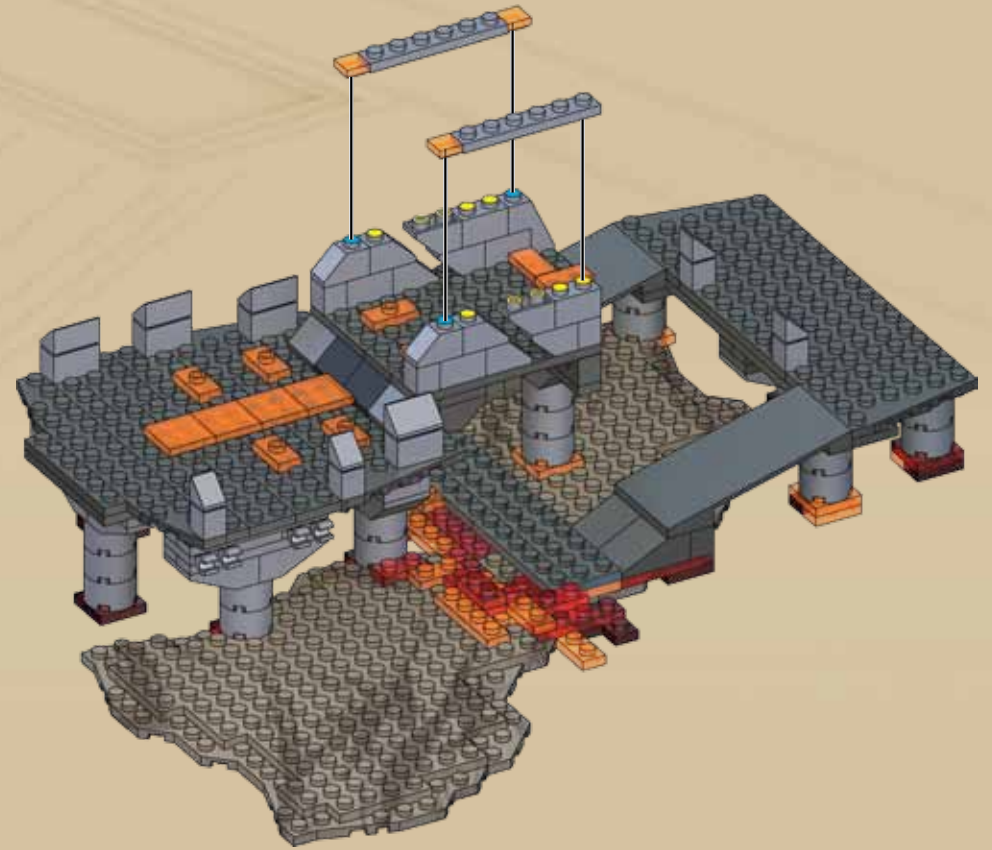

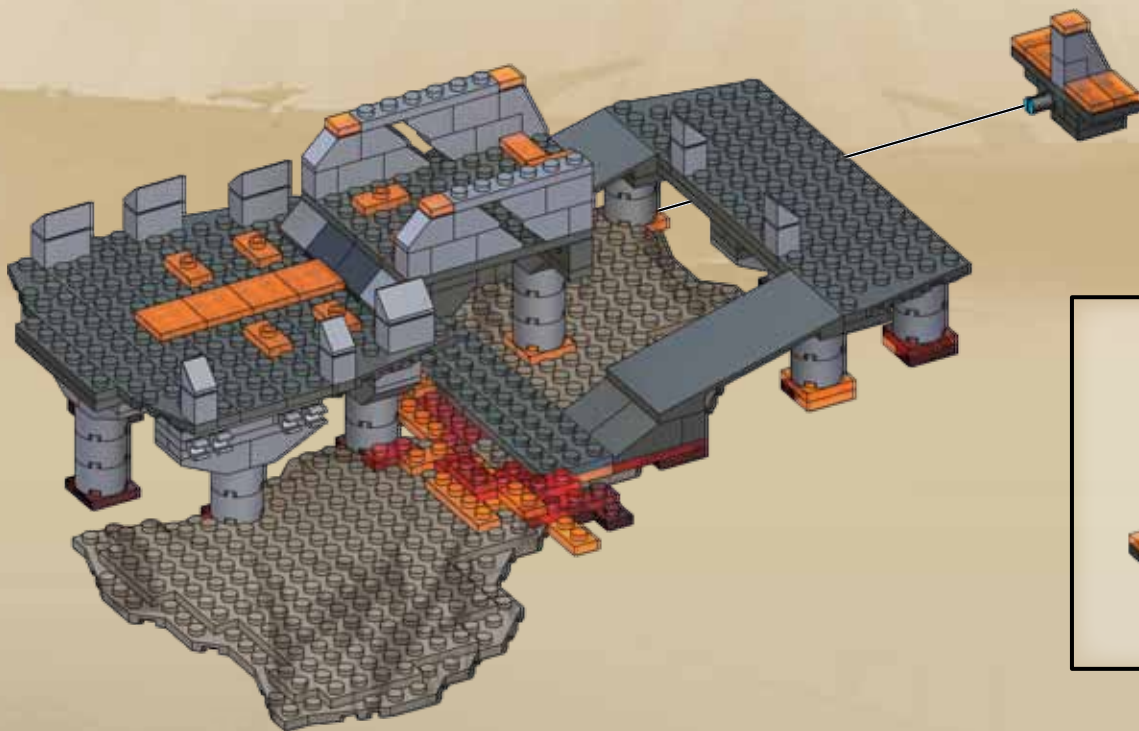
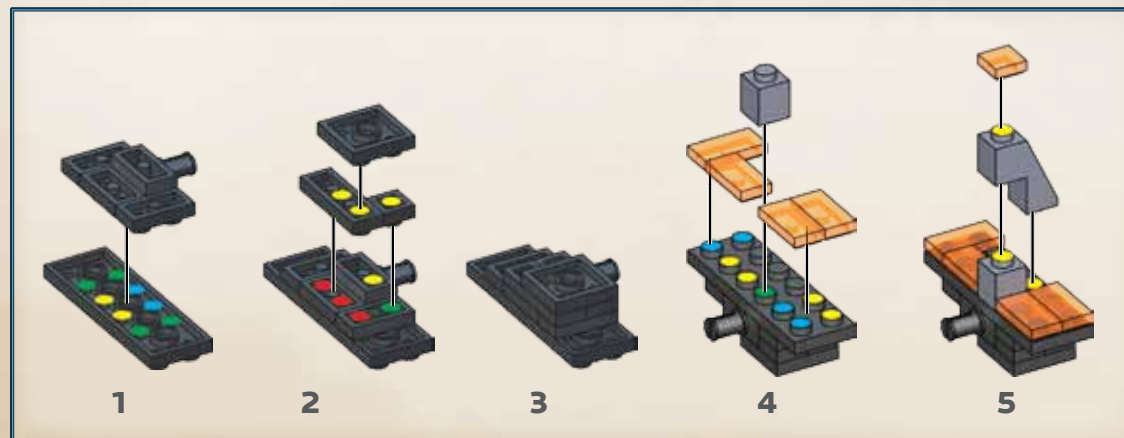

21



22



- 16X 
- 2X 
- 2X 
- 1X 
- 2X 
- 2X 
- 2X 

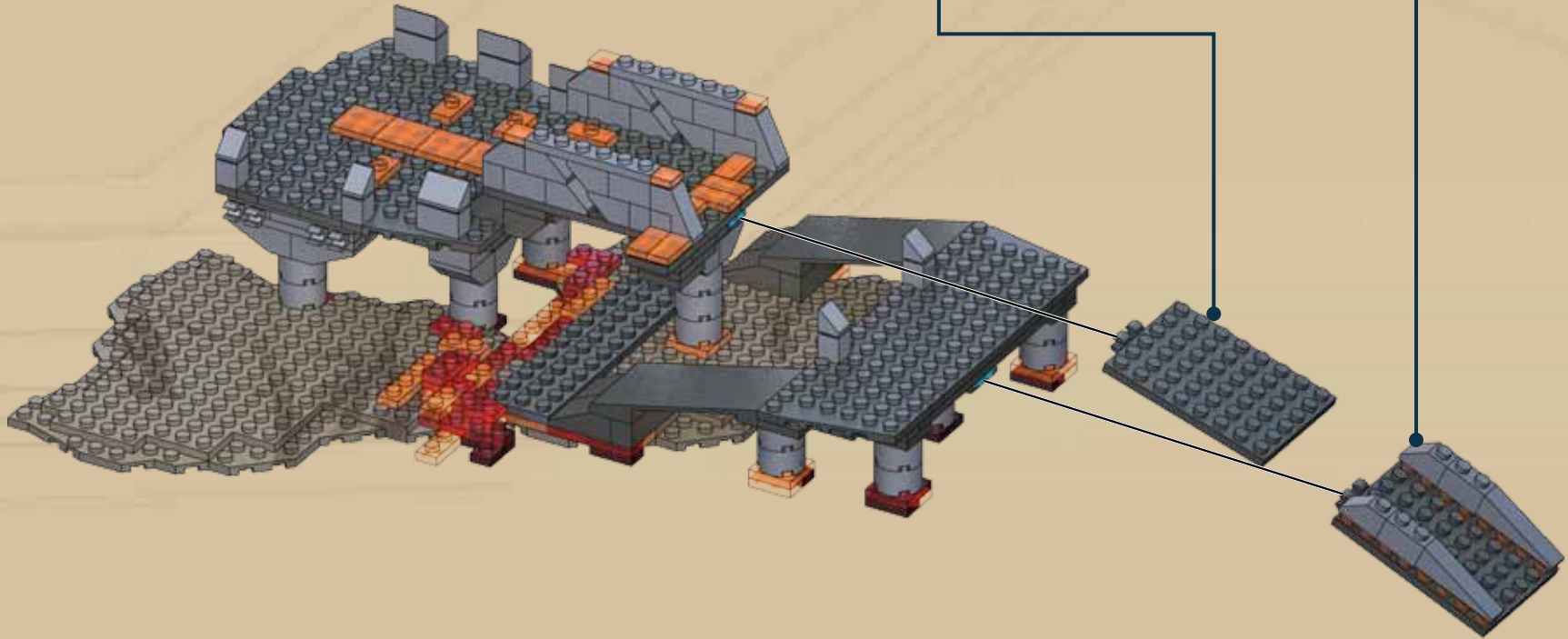
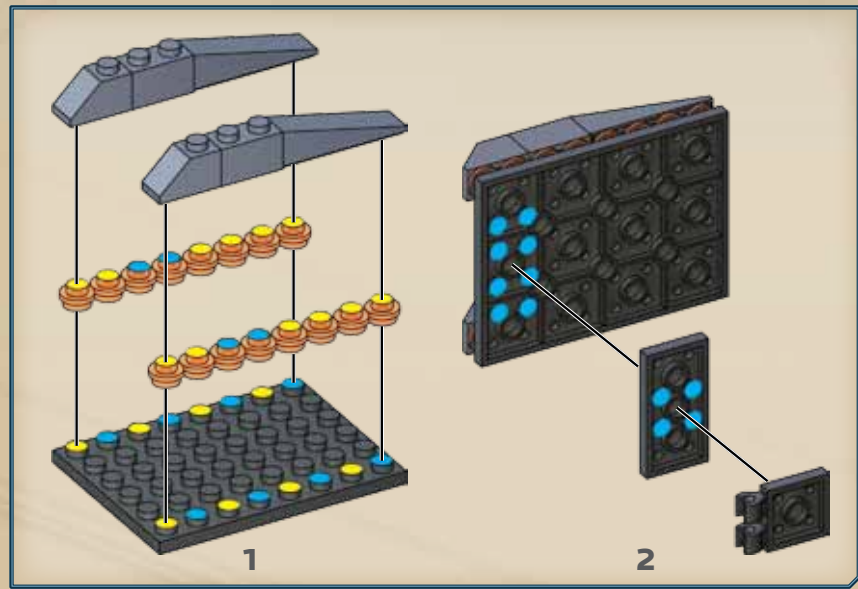
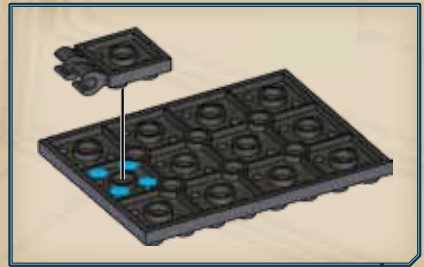

24

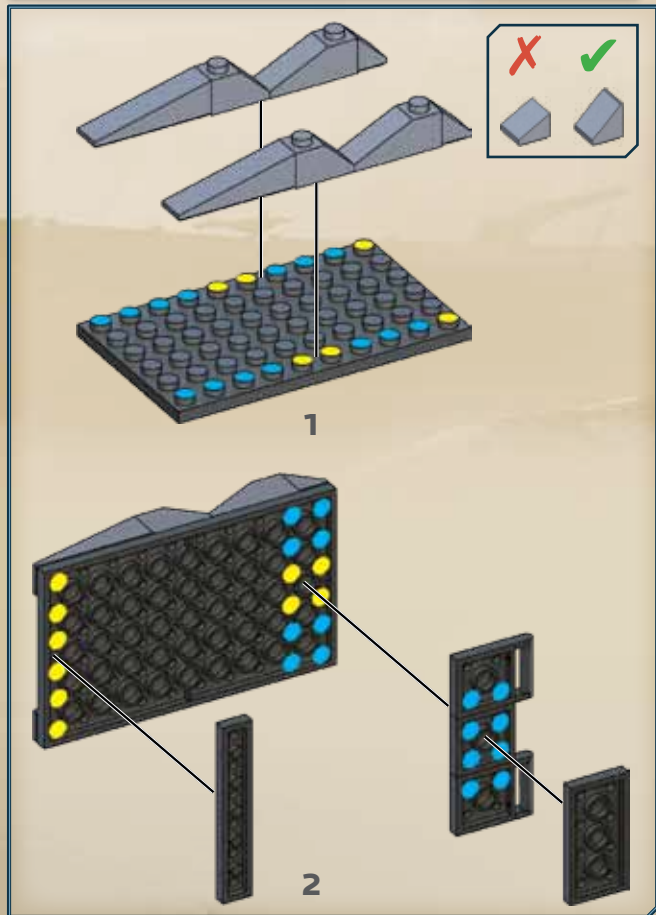
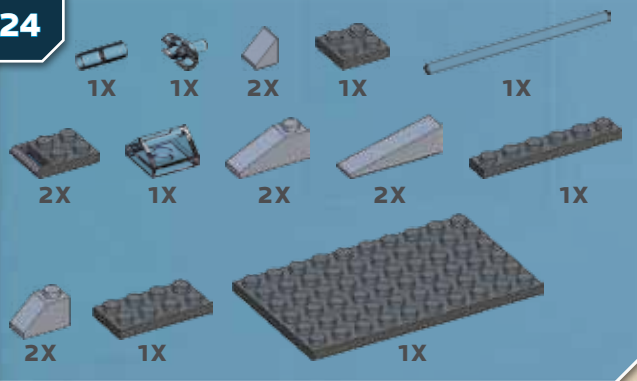

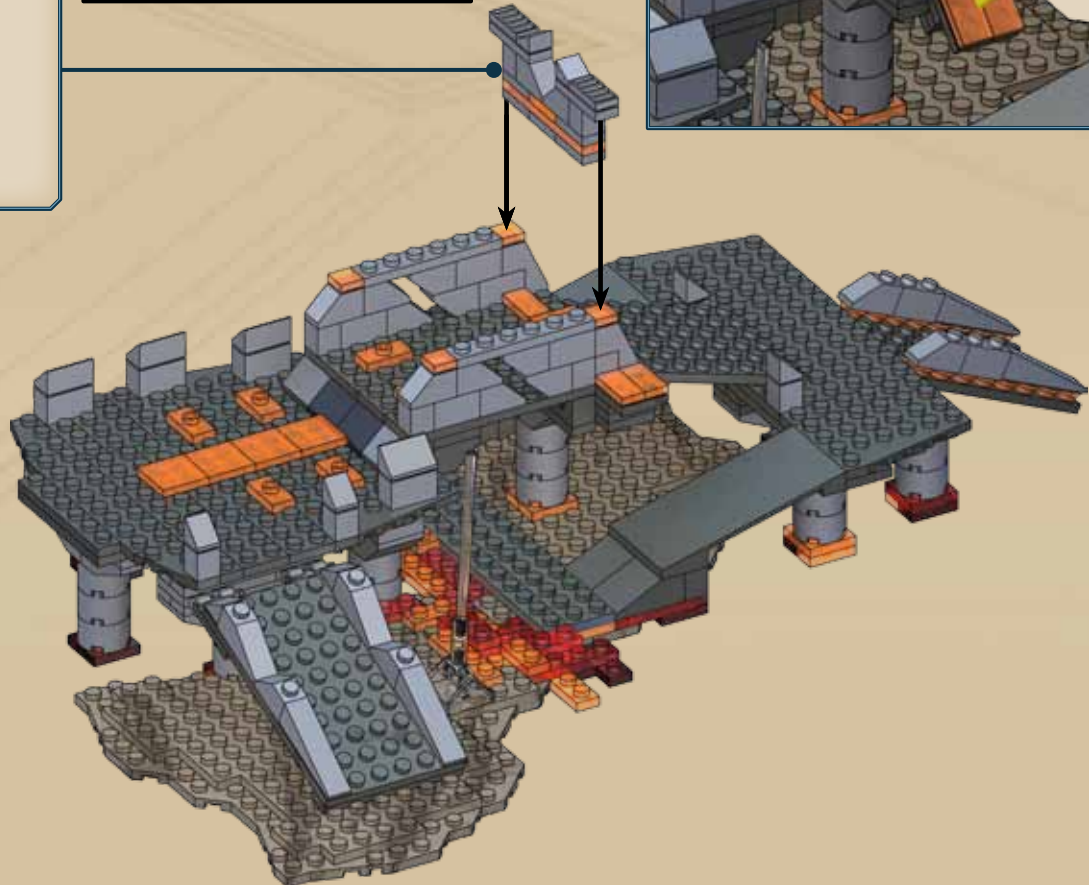
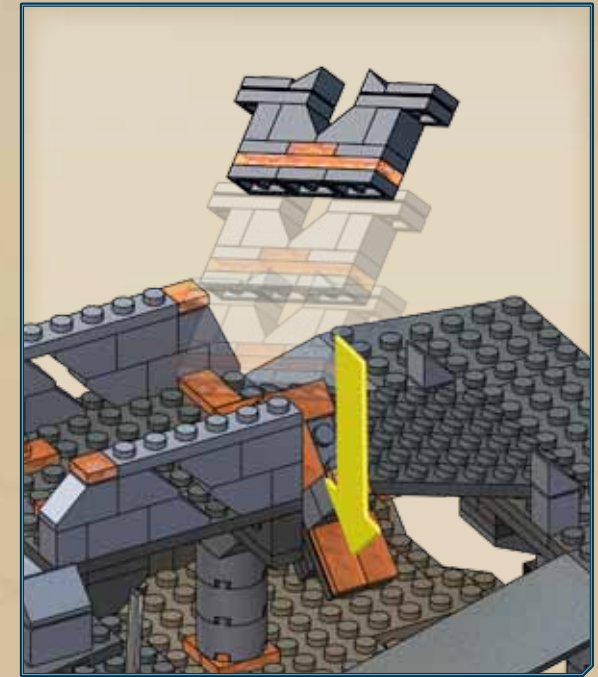
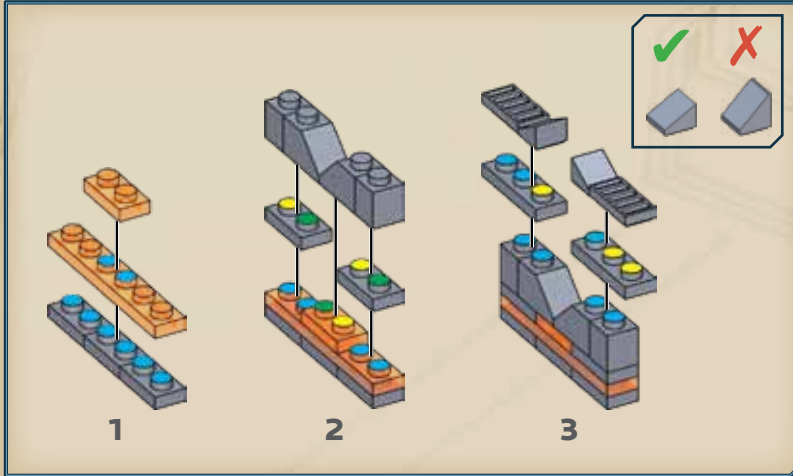

- EN** WARNING ! Do not aim at eyes or face.
- FR** ATTENTION ! Ne pas viser les yeux ou le visage.
- ES** ADVERTENCIA ! NO dirigir nunca los proyectiles hacia los ojos o la cara.
- DE** ACHTUNG ! Nicht auf das Gesicht oder die Augen richten.
- IT** AVVERTENZA ! Non puntare verso gli occhi o il viso.
- PT** ATENÇÃO ! Não apontar para os olhos ou o rosto.
- PL** OSTRZEŻENIE ! Nie celować w oczy lub twarz.
- NL** WAARSCHUWING ! Sikt ikke mot øyne eller ansikt.
- DA** ADVARSEL ! Peg ikke i retning af øjne eller ansigt.
- EL** ΠΡΟΕΙΔΟΠΟΙΗΣΗ !! Να μην σκοπεύετε προς τα μάτια ή το πρόσωπο.
- FI** VAROITUS ! Älä tähtää silmiin tai kasvoihin.
- NO** ADVARSEL ! Sikt ikke mot øyne eller ansikt.
- SV** VARNING ! Rikta inte med ögon eller ansikte.
- JA** 注意 ! 目や顔に使用しないで下さい。
- ZH** 警告 ! 不要对准眼睛或脸。
- AR** تنبيه ! لا توجه للعينين أو الوجه

Use only the projectile included with this toy.
 Utiliser seulement le projectile fourni avec le jouet.
 Utilizar solamente el proyectil incluido con el juguete.
 Nur das mit dem Spielzeug mitgelieferte Projektil verwenden.
 Alleen het met het speelgoed bijgeleverde projectiel gebruiken.
 Utilizzare soltanto il proiettile fornito con questo giocattolo.
 Usar somente o projéctil incluido com este brinquedo.
 Nie celować w oczy lub twarz. Należy stosować jedynie nabój dołączony do zabawki.

استخدم فقط القذيفة المرافقة لهذه اللعبة

26



1



2



3

27

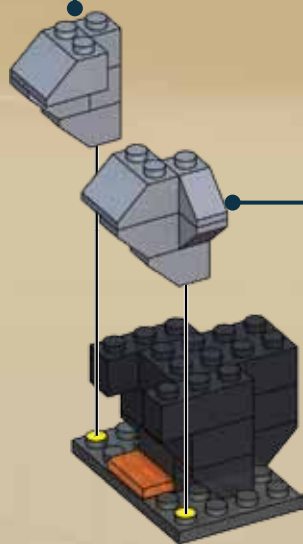
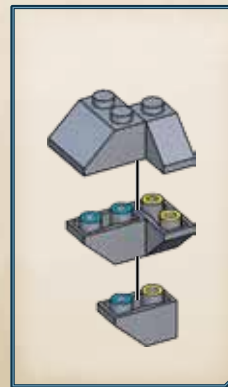
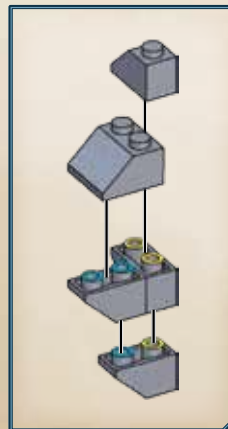

28

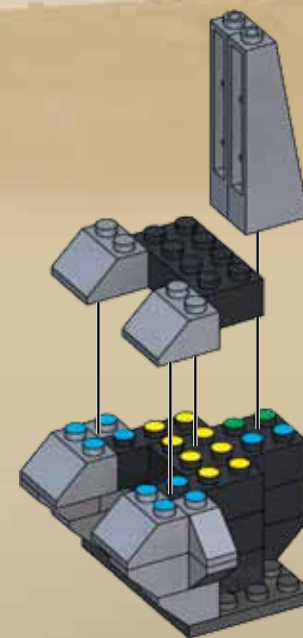

29



4X



2X



1X

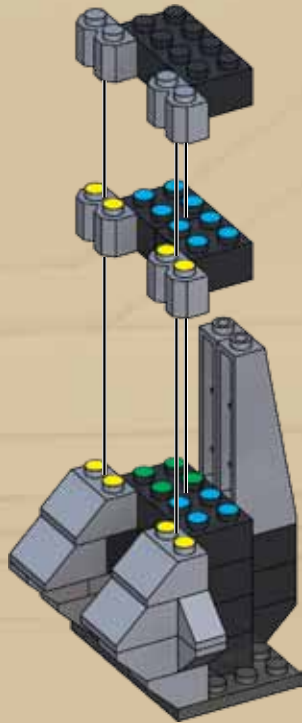

30



4X



4X



x4

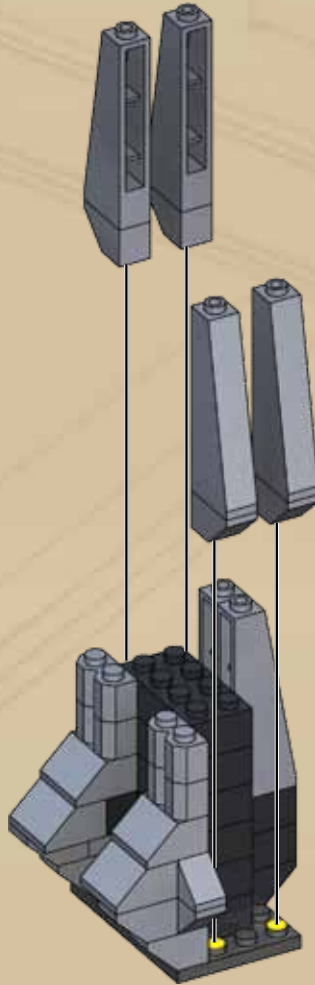

31



2X



2X

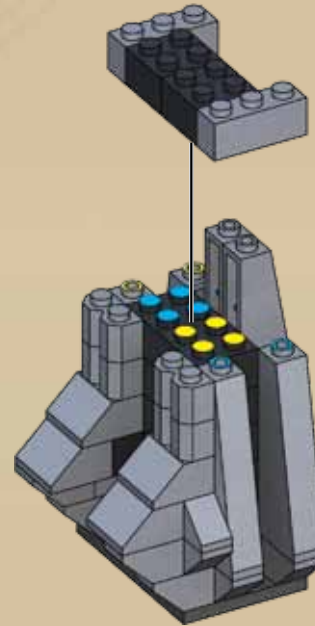

32



1X



2X



2X

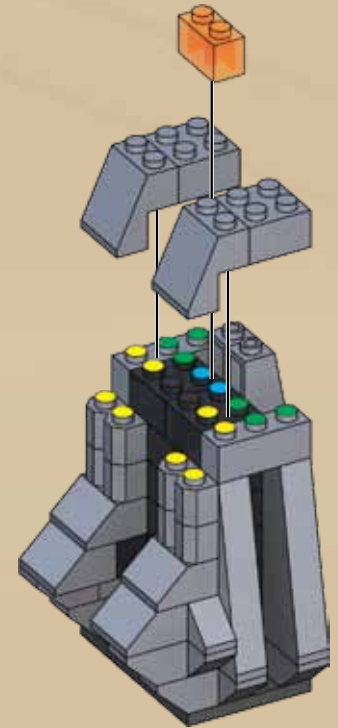

33



34



35



36

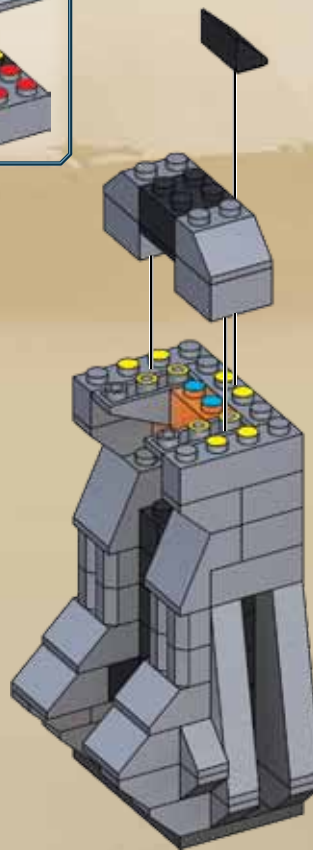
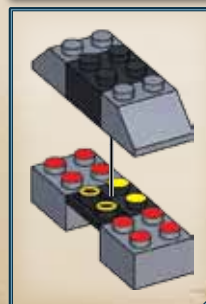
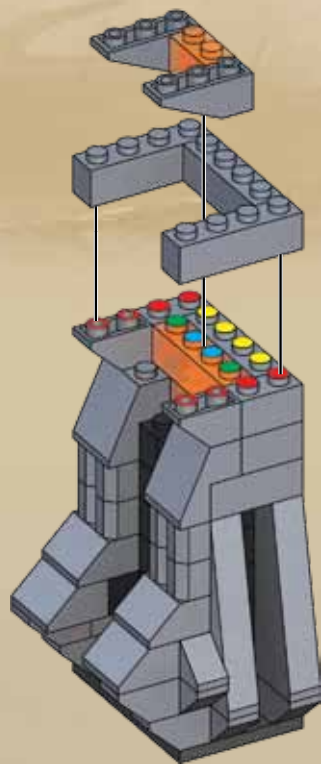
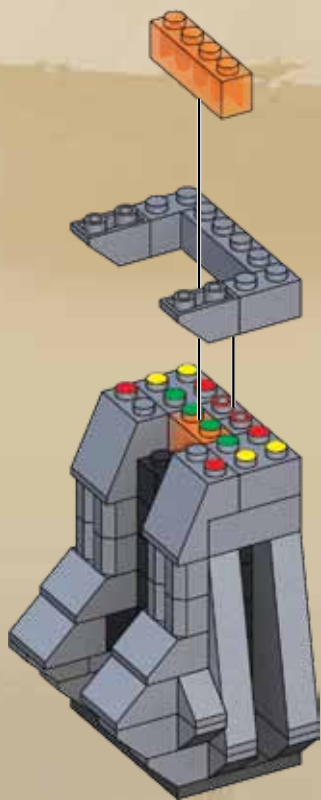

37



8X 1X

38



4X

39



1X 2X

40



4X 1X

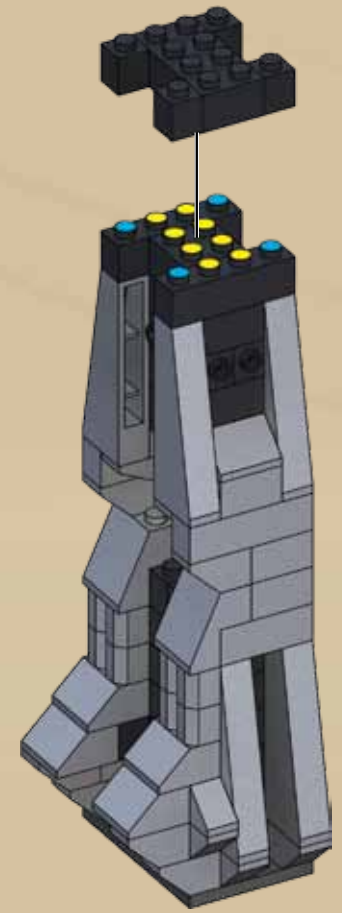
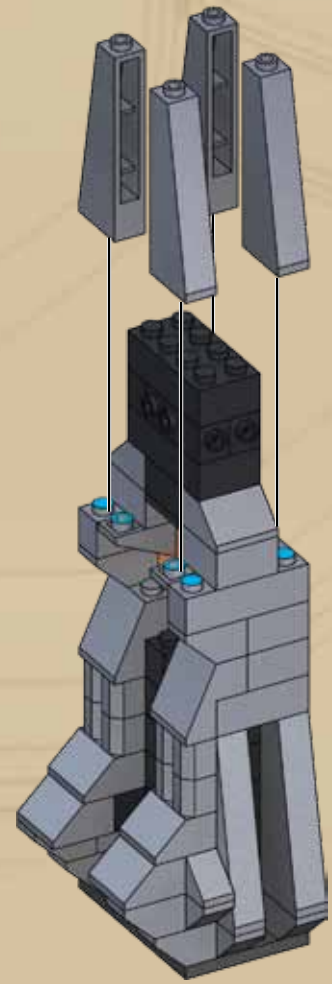
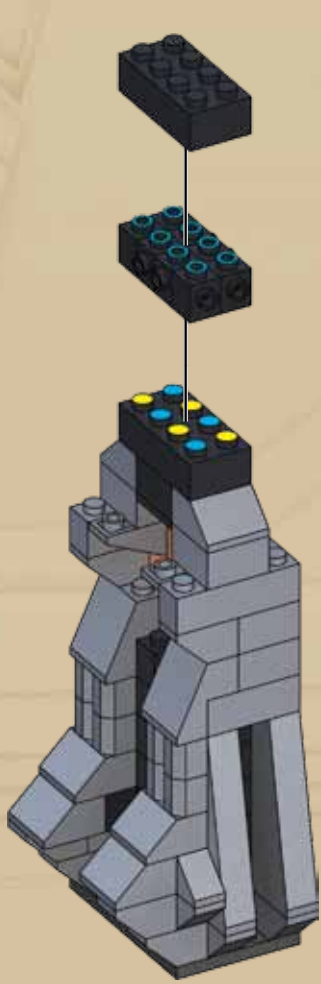

41



1X



2X



42



4X



8X

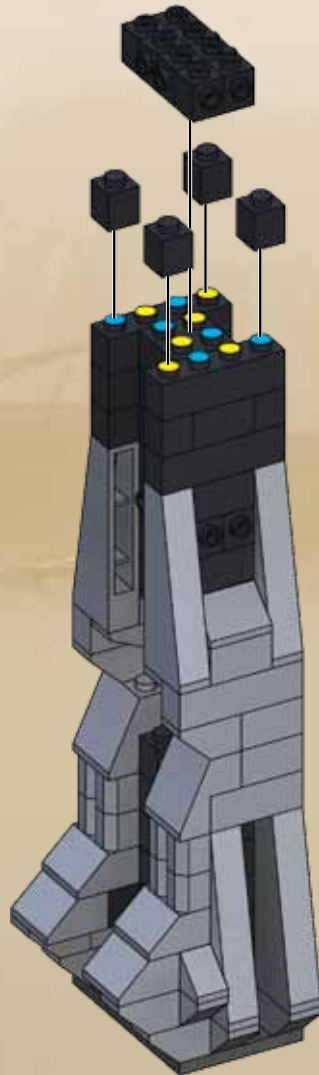

43



1X



2X

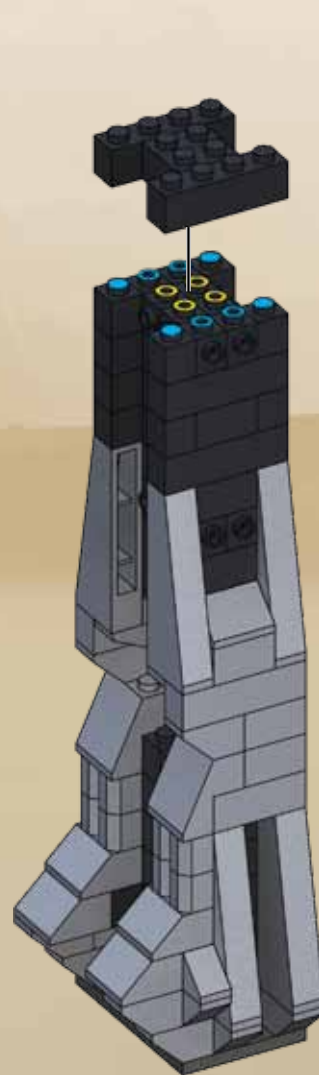

44



4X



1X

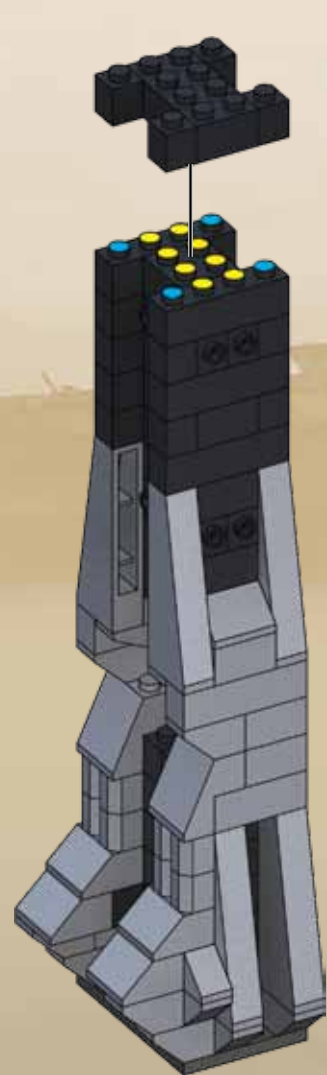

45



46



47



48

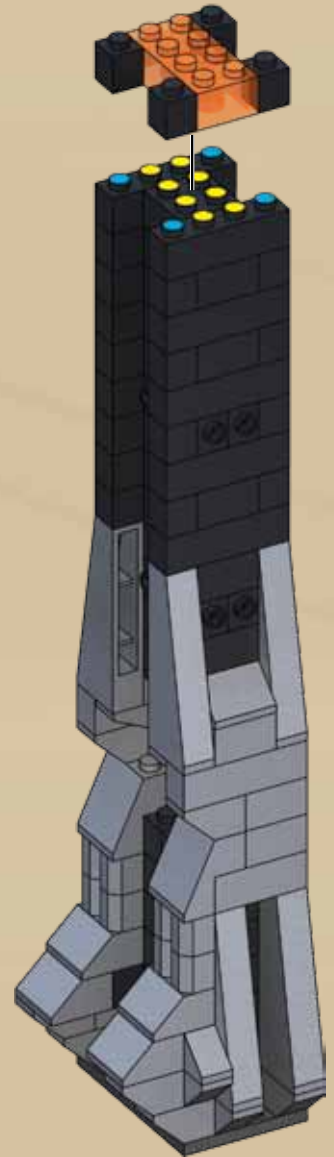
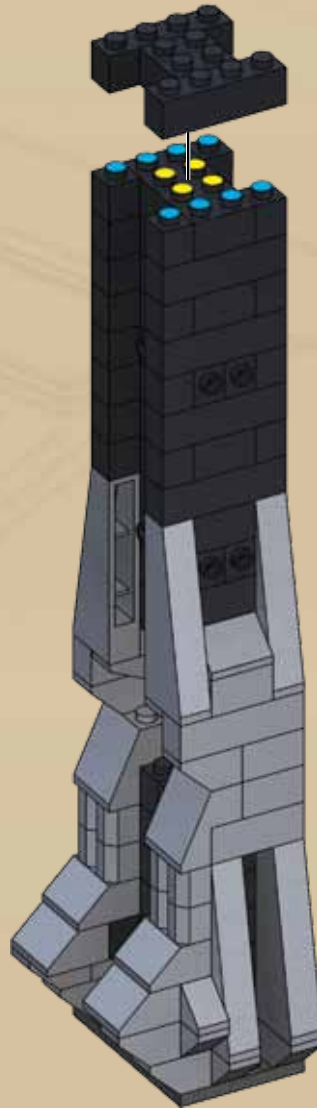
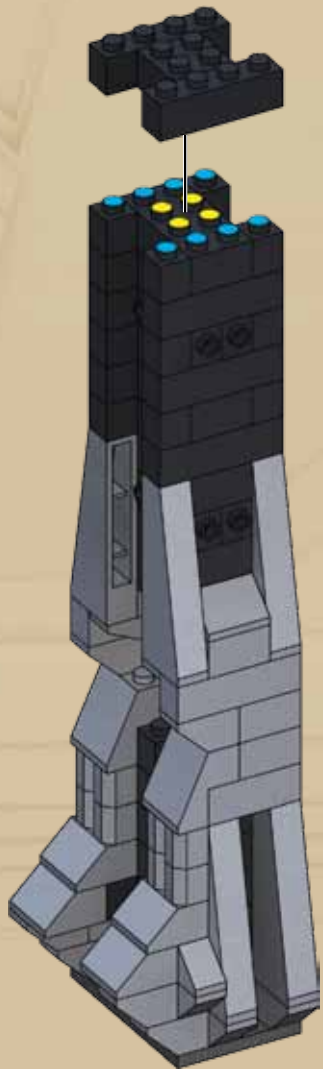

49

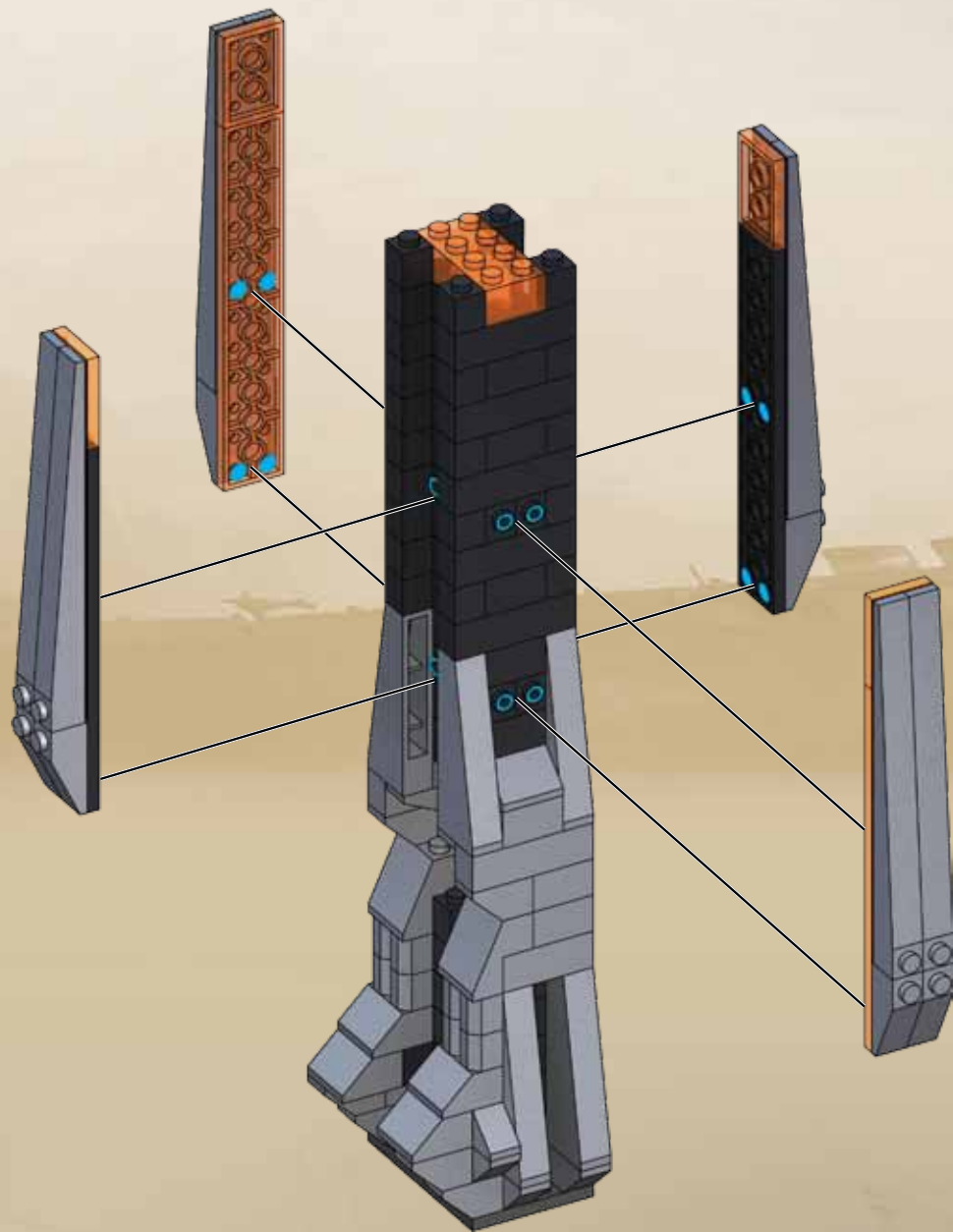
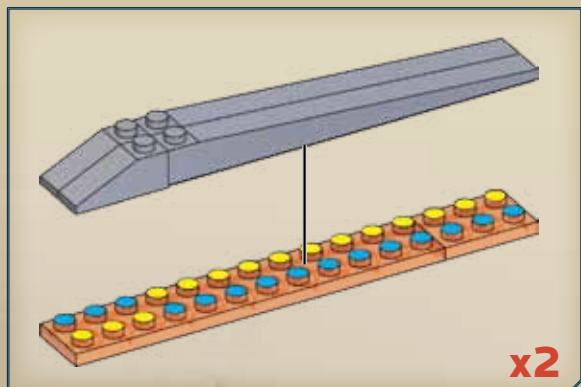
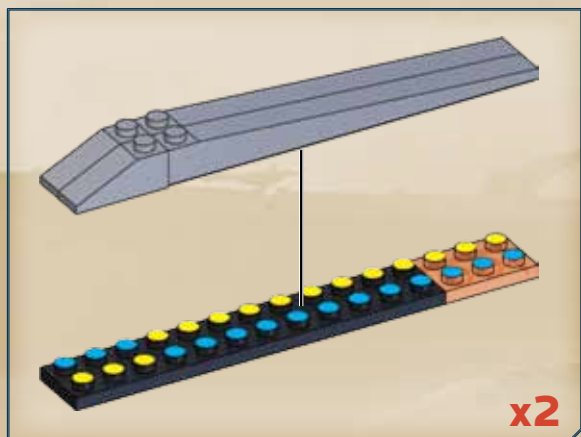
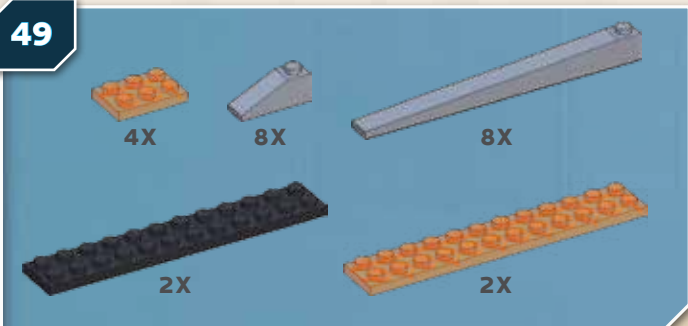



49



1



2



3

HALO





PROMETHEAN KNIGHT
Guerrero Promethean - Guerrier
Promethean - Promethean Krieger -
Promethean Krijger - Guerriero
Promethean - Guerreiro Promethean

HALO

CAULDRON CLASH

Welcome to the Cauldron – a multi-player map on Requiem where the best troops mix it up in a fight for survival inside a Forerunner structure.

Combate en la Cauldron

Bienvenido a la Cauldron – un mapa de varios jugadores en requiem donde las mejores tropas se mezclan en una lucha por sobrevivir dentro de una estructura de Forerunner.

Combat dans le Cauldron

Bienvenue au Chaudron – Une carte multijoueur de Requiem où les plus grands guerriers s'affrontent pour survivre à l'intérieur d'une structure Forerunner.

Cauldron-Schlacht

Willkommen auf Cauldron – einer Multi-Player-Karte auf Requiem, wo die besten Truppen in einer Forerunner-Struktur einen erbitterten Kampf ums Überleben führen.

Gevecht in de Cauldron

Welkom bij de Cauldron – een Requiem-multiplayerplattegrond waar de beste troepen in een Forerunner-bouwwerk vechten voor hun leven.

Combattimento nel Cauldron

Benvenuti nel Cauldron: una mappa multiplayer su Requiem, dove le migliori truppe si scontrano in una lotta per la sopravvivenza all'interno della struttura Forerunner.

Combate no Cauldron

Bem-vindo ao Cauldron – um mapa para multijogadores em Requiem onde as melhores tropas se misturam em uma luta pela sobrevivência dentro de uma estrutura Forerunner.

NEW / NUEVO / NOUVEAU / NEU / NIEUW / NUOVO / NOVO

PROMETHEAN KNIGHT

Guerrero Promethean - Guerrier Promethean - Promethean Krieger - Promethean Krijger - Guerriero Promethean - Guerreiro Promethean

PROMETHEAN WATCHER

Observador Promethean - Observateur Promethean - Promethean Beobachter - Promethean Wachter - Osservatore Promethean - Sentinela Promethean

PROMETHEAN CRAWLER

Rastreador Promethean - Marcheur Promethean - Promethean Kettenraupe - Promethean Strisciante - Promethean Rastreador

UNSC Spartan Soldier

Soldado Spartan de CENU - Soldat Spartan du CSNU - RVN Spartan-Soldat - RVN Spartan-soldat - Soldato Spartan del CSNU - Soldado Espartano do CENU

UNSC MARINE

Marine de CENU - Marine du CSNU - RVN Marine - Soldato del CSNU - Fuzileiro do CENU



DEPLOY WATCHER!
¡DESPLIEGA EL OBSERVADOR!
DEPOSEZ L' OBSERVATEUR!
EIRRAZT BEOBACHTER
WÄTCHER HESTETEN
SCHIENA L' OSSERVATORE
L'IRRE II SENTINELA

UNSC INTEL

