

**MEGA
BLOKS**

PROBUILDER

9744

















RACING RIG



















**MASTER
SERIES**

















10+ Ages/Edades
Ages/Leeflijden

1580 Pieces/Piezas
Pièces/Stuks









	2x
M1113X	
	30x
M1113N	
	21x
AM02802F	
	4x
AM03328W	
	4x
AM03328KC	
	2x
AM03328N	
	4x
M1225F	
	13x
M1312F	
	2x
AM02804F	
	9x
M1140F	
	3x
M0910F	
	4x
AM03017N	
	1x
AM03008N	
	1x
AM03016N	
	1x
AM01296N	
	3x
M01684JX	















	8x
AM3325N	
	43x
M02250F	
	38x
M02250GP	
	2x
M02250EA	
	2x
M02250KZ	
	82x
M09393F	
	23x
M09393KZ	
 	43x
M09393N	
	4x
M09393KC	
	4x
M09393X	
	4x
M09393A	
	2x
M09393W	
	9x
AM02803F	
	4x
M1166N	
	21x
M1086F	
	4x
M1086N	
	15x
M1086KZ	
	27x
M09013F	

	1x
M09013W	
	22x
M09013N	
	21x
M09013KZ	
	2x
M09013A	
	9x
M1419F	
	8x
M1419N	
	2x
M1419KZ	
	4x
M11101A	
	1x
AM02768F	
	2x
AM03330F	
	16x
M1133F	
	6x
M1133N	
	6x
M1322F	
	6x
M1322N	
	5x
M1146F	

	2x
M1417KZ	
	4x
M1417N	
	6x
M1417F	
	2x
M1418N	
	2x
AM02206N	
	9x
M1154F	
	10x
M1154N	
 	2x
M1139N	
	14x
M10273F	
	6x
M10273N	
	2x
M10273W	
	1x
M1141F	
 	2x
M1141N	
	4x
M1141KZ	
	4x
M1153A	
	3x
AM01531N	

	17x
M0948F	
	23x
M0948N	
	6x
M0948KZ	
	2x
M0948W	
	8x
AM03329N	
	3x
M1142N	
	4x
M1142A	
 	2x
AM03091N	
 	3x
AM03555N	
 	2x
M1346N	
	15x
M09023F	
	18x
M09023N	
	4x
M1320F	
	1x
M1320N	
	3x
M1320JG	
	2x
AM02212N	
	4x
AM02212KZ	
	34x
M1314F	

	22x
M1314N	
	1x
M1314KZ	
	82x
M09593F	
	18x
M09593N	
	9x
M09593KZ	
	96x
M09493F	
	50x
M09493N	
	8x
M09493KZ	
	3x
AM03323N	
	1x
AM03323KZ	
	3x
AM03324N	
	1x
AM03324KZ	
	58x
M1480F	
	25x
M1480N	
	2x
M1480KZ	
	19x
M1172F	
	6x
M1172N	

	5x
M1389F	
	5x
M1390F	
	8x
M1087F	
	9x
M1087N	
	11x
M1087KZ	
	28x
M1313F	
	10x
M1313N	
	9x
M1313KZ	
	25x
M10233F	
	17x
M10233N	
	4x
M10233KZ	
	31x
M09033F	
	85x
M09033N	
	10x
M09033KZ	
	3x
AM01555F	

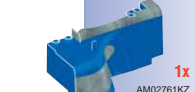
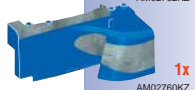
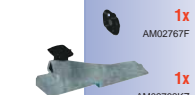
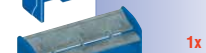
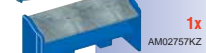
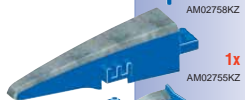
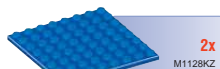
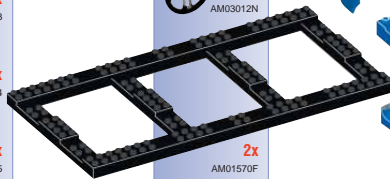
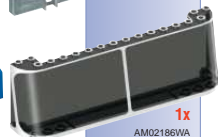
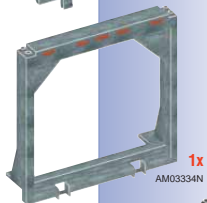
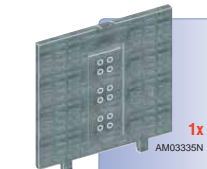
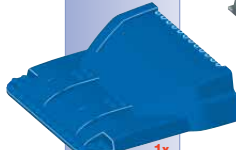
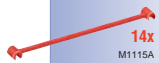
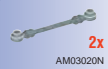
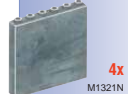
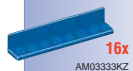
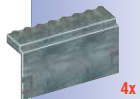
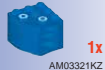
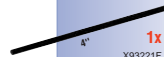
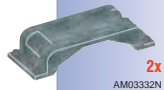
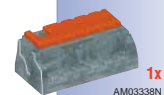



Color chart.
Cuadro cromático
Kleurenkaart.
Quadro cromatico.

Charte de couleurs.
Färgtabell.
カラーチャート
色彩表

Active step / Etapa activa / Étape active / Aktivt skede
Active step / Azione attiva / アクティブなステップ / 積極歩驟

Previous step / Etapa precedente / Étape précédente
Føregående skedet / Vorige stap / Azione precedente
前のステップ / 上一歩驟

Active step / Etapa activa / Étape active / Aktivt skede
Active step / Azione attiva / アクティブなステップ / 積極歩驟

Previous step / Etapa precedente / Étape précédente
Føregående skedet / Vorige stap / Azione precedente
前のステップ / 上一歩驟

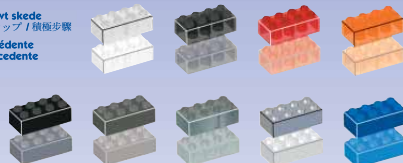

Please read these instructions carefully before first use and keep them for future reference.
Leer estas instrucciones cuidadosamente antes de la primera utilización y guardarlas para referencia futura.
Il est recommandé de lire attentivement ce feuillet avant la première utilisation et de le conserver pour référence future.
Wij raden u aan deze handleiding zorgvuldig te lezen en te bewaren voor eventuele raadpleging op een later tijdstip.

⚠️ **WARNING :**
CHOKING HAZARD. - Small parts.
Not for children under 3 years.

⚠️ **ADVERTENCIA :**
PELIGRO DE ASFIXIA. - Contiene piezas pequeñas.
No recomendado para niños menores de 3 años.

⚠️ **AVERTISSEMENT :**
RISQUE DE SUFFOCATION. - Présence de petits éléments.
Ne convient pas aux enfants de moins de 3 ans.

⚠️ **WAARSCHUWING:**
VERSTIKKINGSGEVAAR. - Bevat kleine onderdelen.
Niet geschikt voor kinderen onder de 3 jaar.

⚠️ **WARNING:**
ERSTICKUNGSGEFAHR. - Enthält kleine Teile.
Nicht für Kinder unter 3 Jahren geeignet.

⚠️ **ADVARSEL:**
KVELNINGSFARE. - Inneholder smådele.
Ikke til barn under 3 år.

⚠️ **ΠΡΕΙΔΟΠΟΙΗΣΗ:**
ΚΙΝΔΥΝΟΣ ΠΝΙΞΙΜΑΤΟΣ. - Περιέχει μικρά αντικείμενα
Όχι για παιδιά κάτω των 3 ετών.

⚠️ **VARDITUS:**
TUKENTUMISVAARA. - Sisältää pieniä osia.
Ei alle 3-vuotiaille lapsille.

⚠️ **ATTENZIONE:**
PERICOLO DI SOFFOCAMENTO. - Contiene piccole parti.
Non indicato per bambini sotto i 3 anni.

⚠️ **ADVARSEL:**
KVELNINGSFARE. - Inneholder små deler.
Kun for barn over 3 år.

⚠️ **ATENÇÃO:**
PERIGO DE ASFIXIA. - Contém peças pequenas.
Não é concebido para crianças de menos de 3 anos.

⚠️ **WARNING!**
KVÄVNINGSRISIK. - Innehåller små delar.
Inte för barn under 3 år.

⚠️ **警告:**
窒息の危険性。小さな部品が含まれています
3歳以下の子供には与えないで下さい。

⚠️ **警告:**
有窒息危險。包含有小部件
不適合3岁以下的小孩玩。



PROBUILDER

RACING RIG

Section 1 • Sección 1
Section 1 • Deel 1



6

Section 2 • Sección 2
Section 2 • Deel 2



15

Section 3 • Sección 3
Section 3 • Deel 3

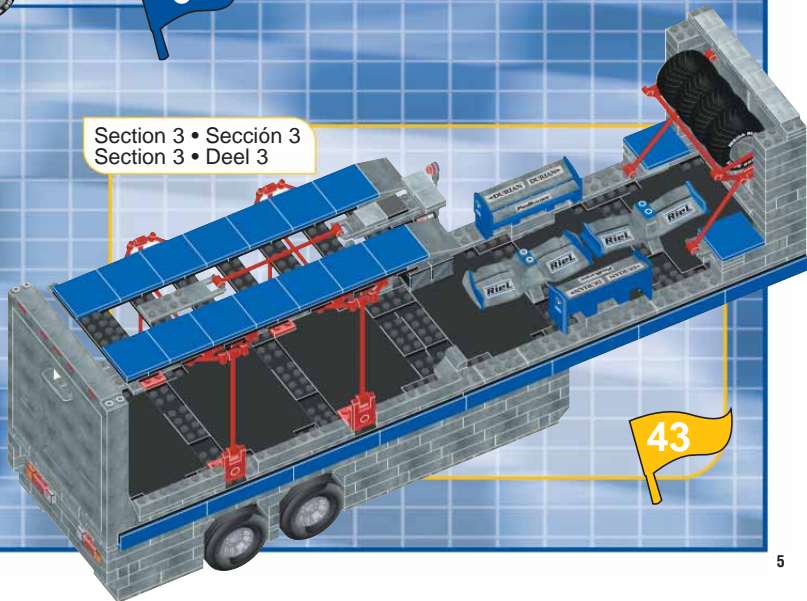

43

Page • Página • Page • Bladzijde

6

15

43

Section 1 • Sección 1
Section 1 • Deel 1

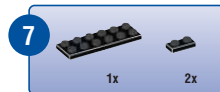
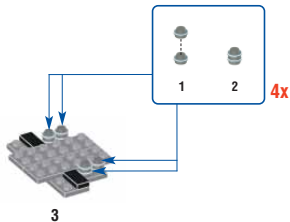
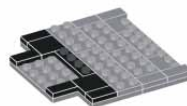
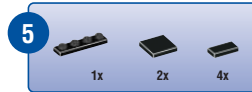
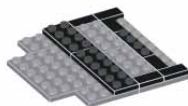
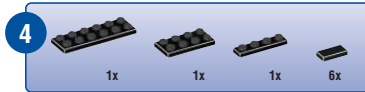
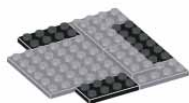
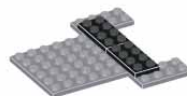
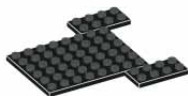
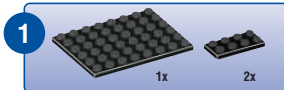

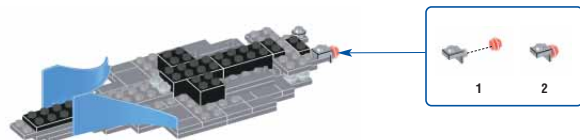
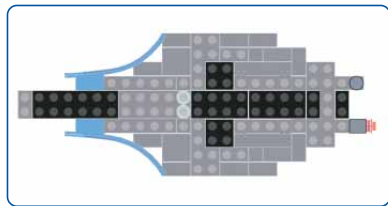
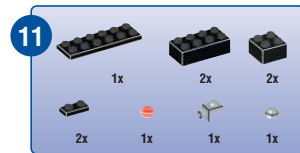
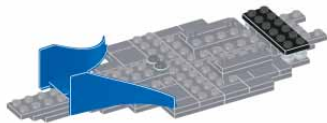
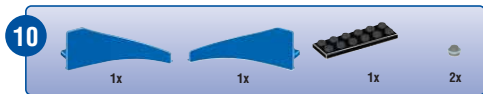
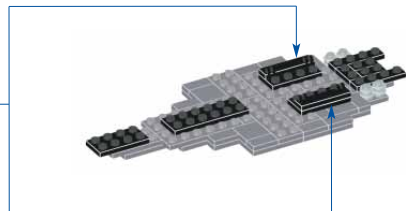
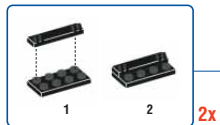
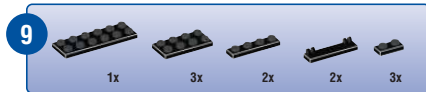
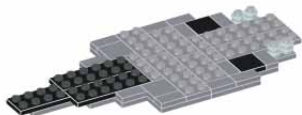
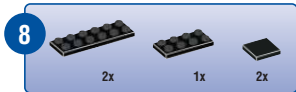

12

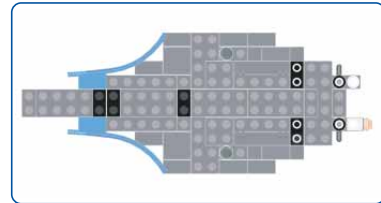
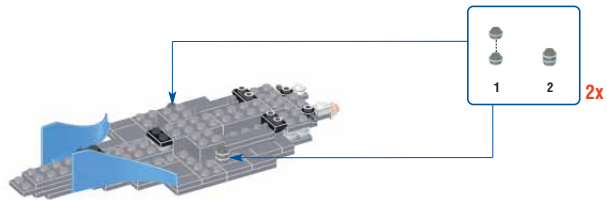

13

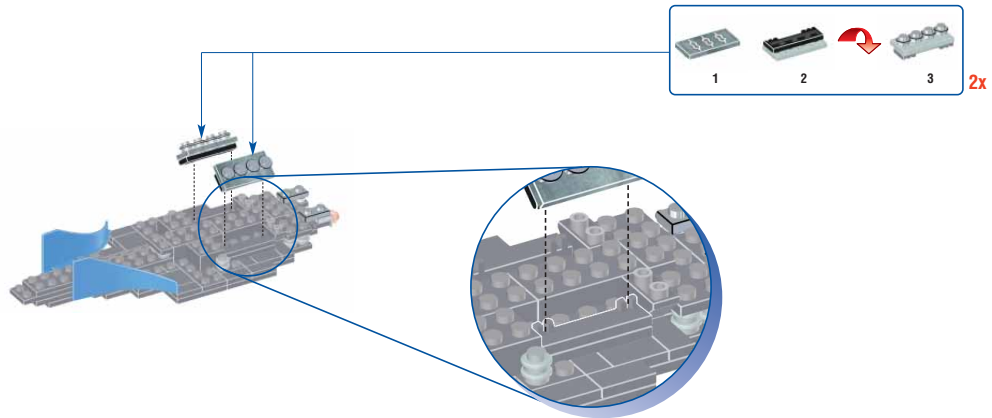

14

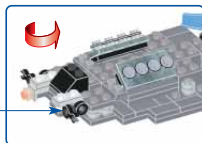
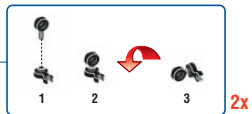
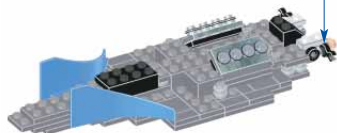

15

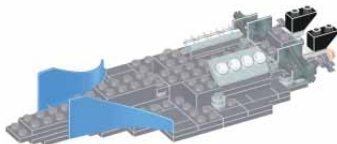

16

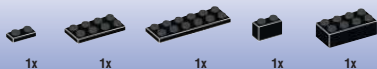

17

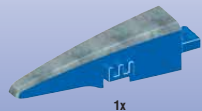

16

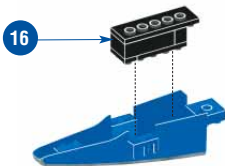

1



2

Place temporary piece • Colocar la pieza provisional
Poser la pièce temporaire • Tijdelijk deel plaatsen



3



4



5

18

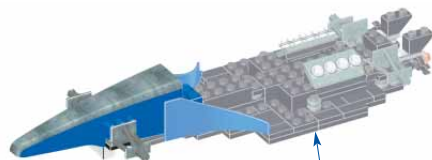

15

19



2x

20



2x

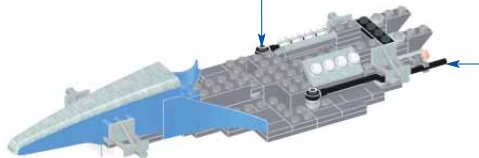
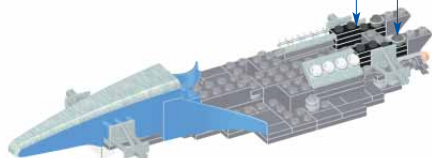

21

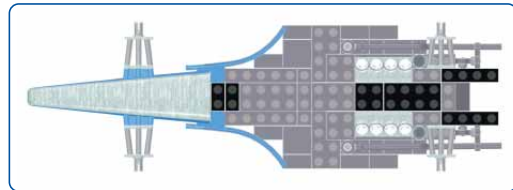
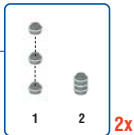
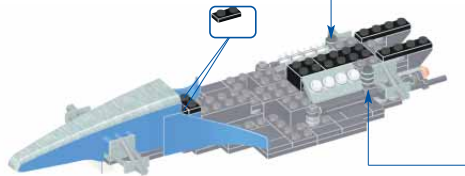

22

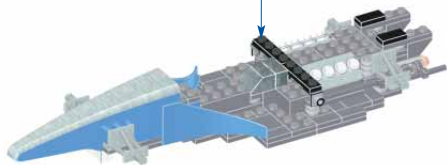
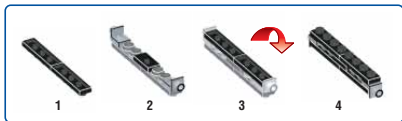

23

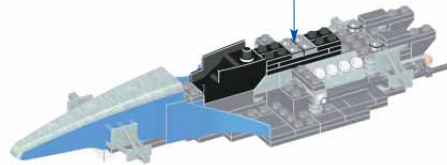
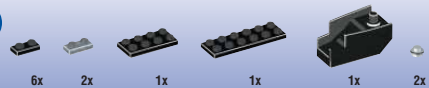

24

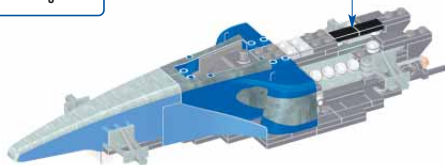
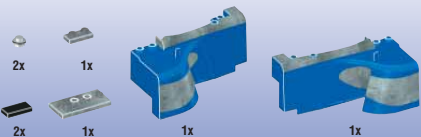

25

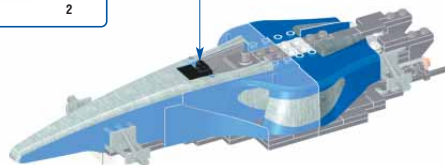
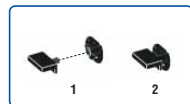
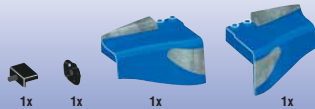

26

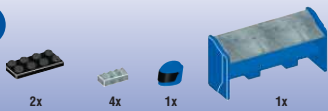

2x

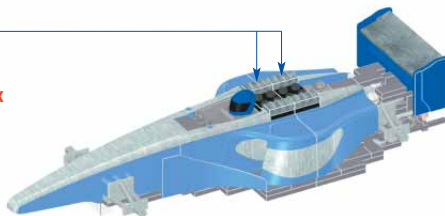

27

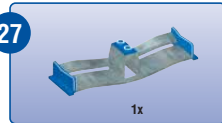

Remove temporary piece
Retirar la pieza provisional
Retirer la pièce temporaire
Verwijder tijdelijk deel

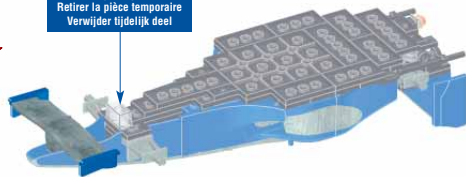

28

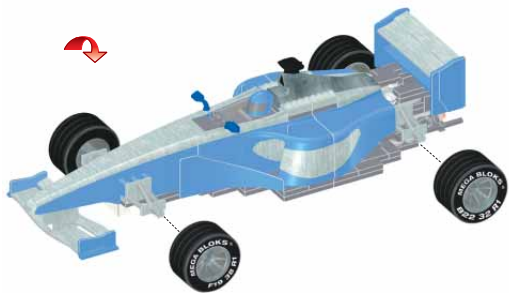

30

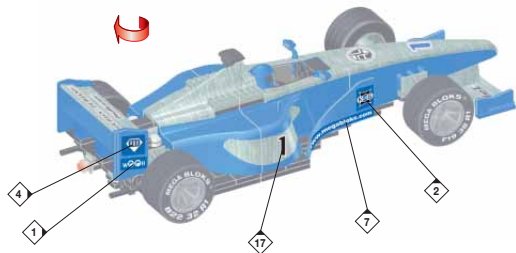

29

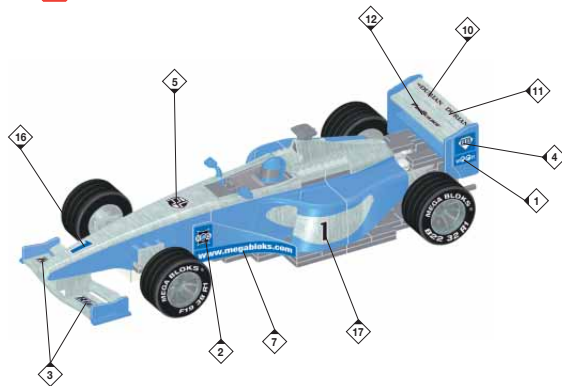

31

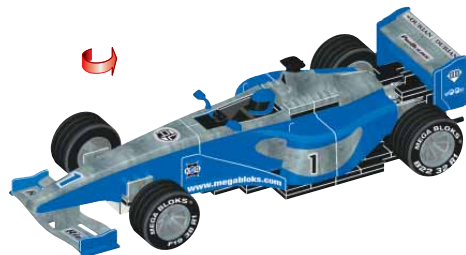

PROBUILDER RACING RIG



*Interior holds 1 complete Formula Racer (included)
plus diagnostic center and spare parts*

*El interior incluye 1 auto de carreras de formula (incluido)
además del centro de diagnóstico y piezas de repuesto*

*L'intérieur renferme 1 voiture de course de formule complète (incluse)
en plus d'un centre de diagnostic et de pièces de rechange*

*Interieur bevat 1 complete Formula Racer (inbegrepen)
met diagnosecentrum en reservdelen*



Section 2 • Sección 2
Section 2 • Deel 2

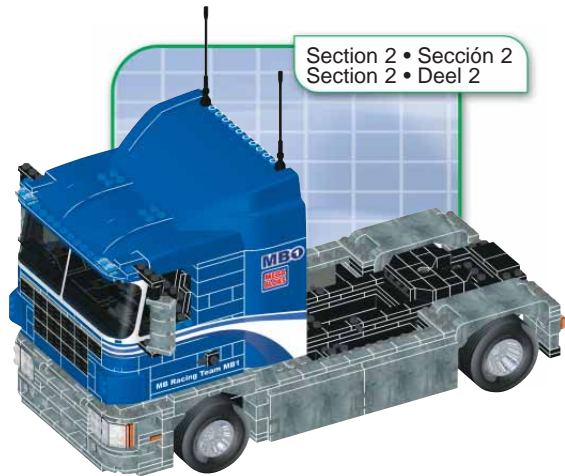

1

2x 2x

2

2x 2x 2x

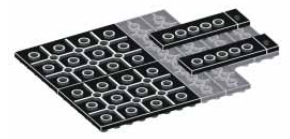

3

1x 2x



4

1x 2x 1x 2x

5

1x 1x 2x 2x 2x 2x 2x

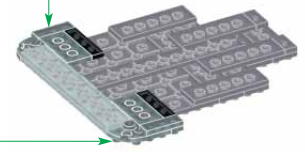
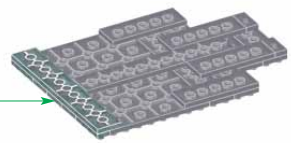
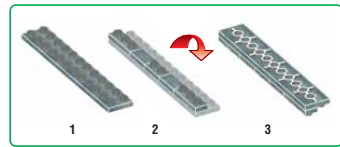

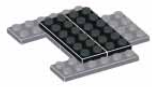
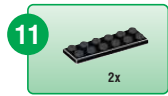
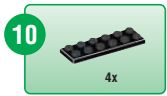
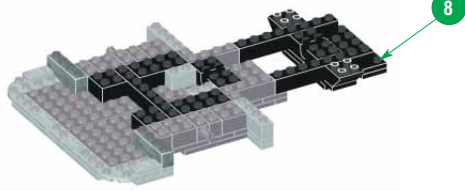
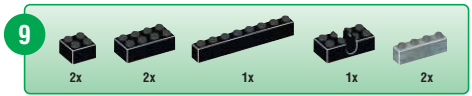
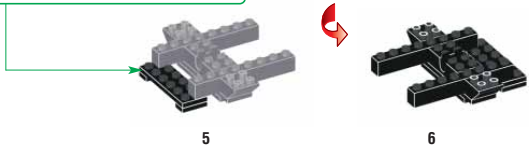
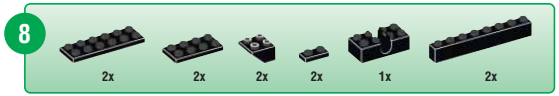
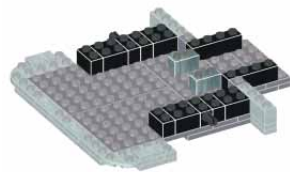
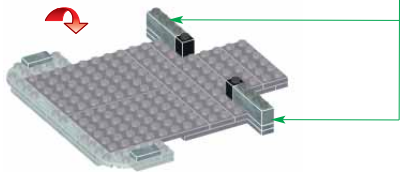
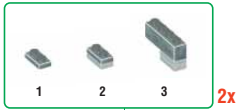
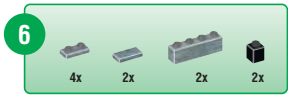

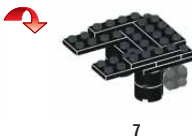
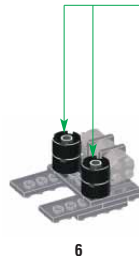
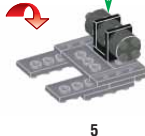
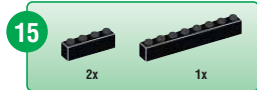

17

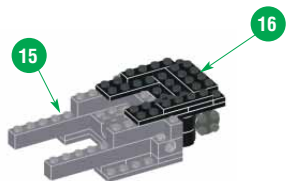

18

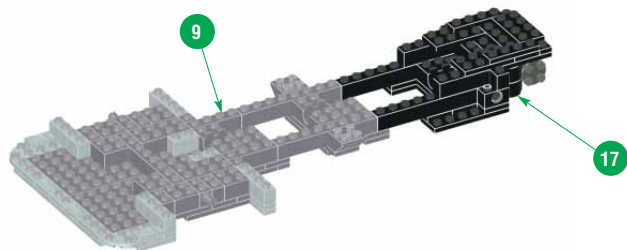

19

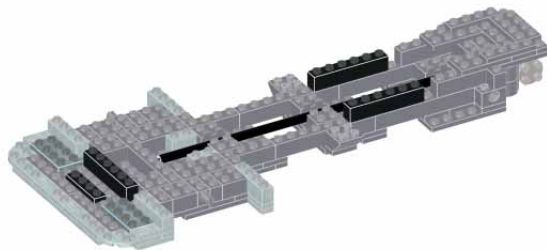

20

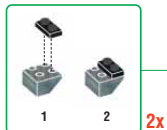
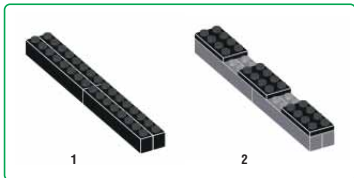
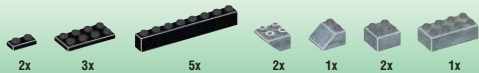

21

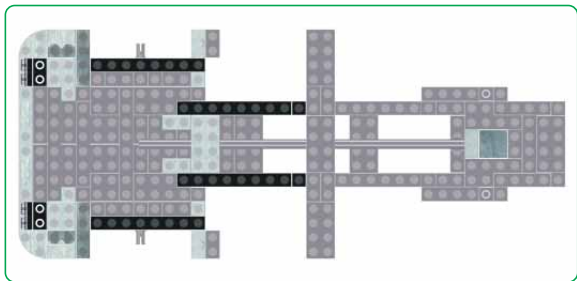
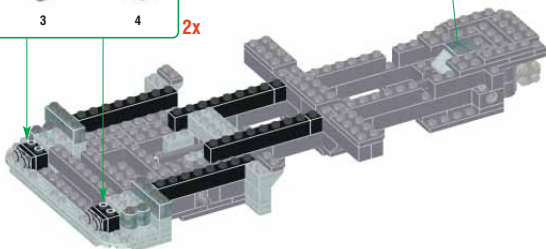
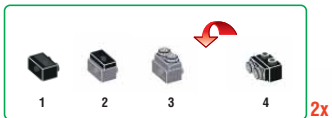
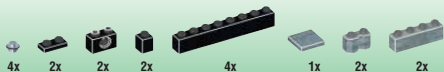

22

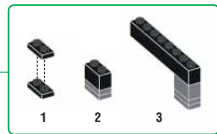
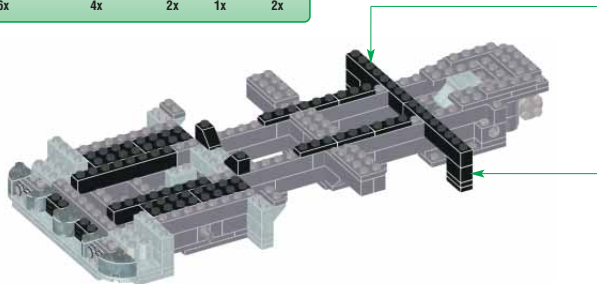
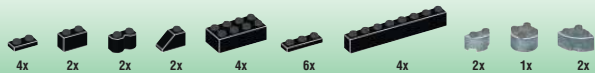

23



24

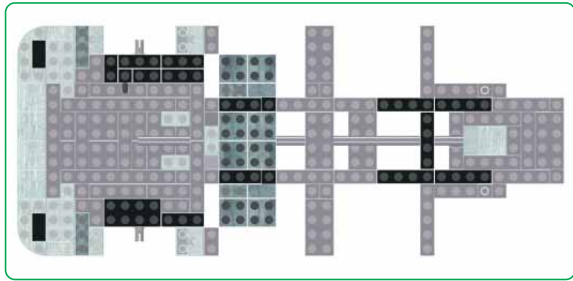
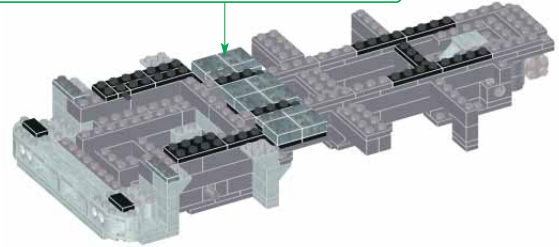
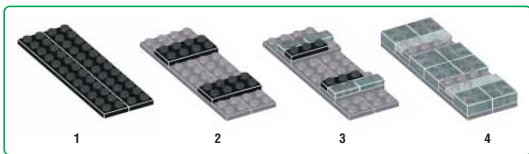
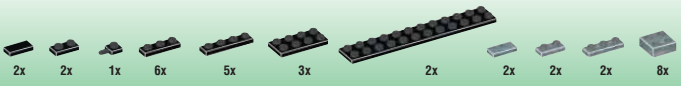

25

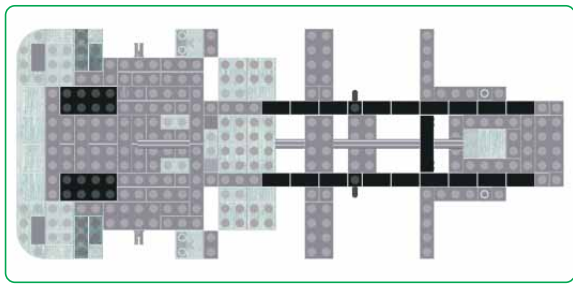
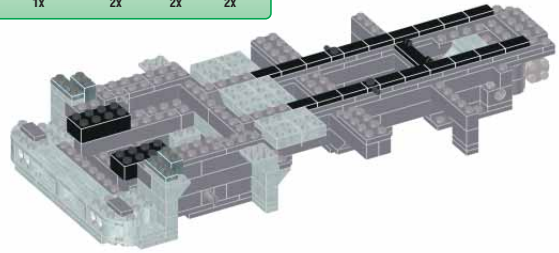
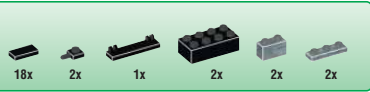

26



27



28



29



30

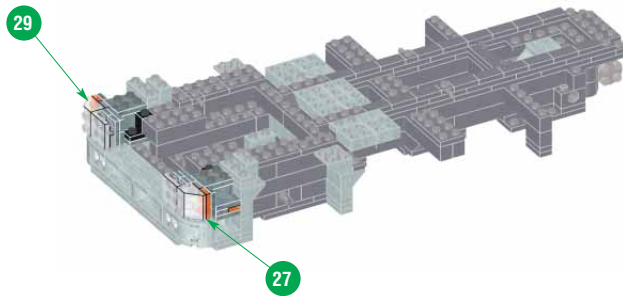

31



32



33

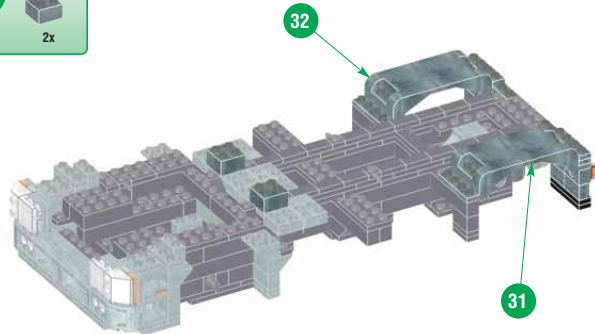

34

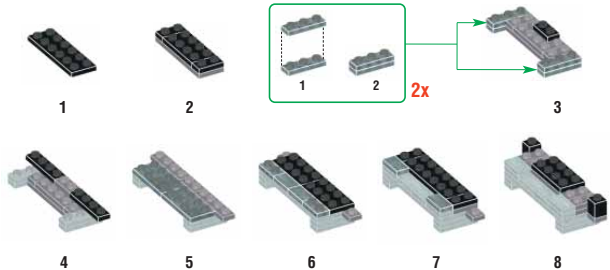

35

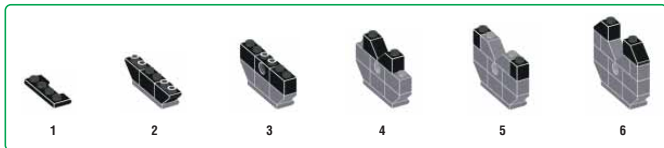
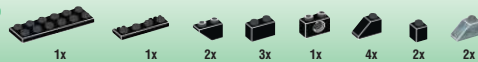

34

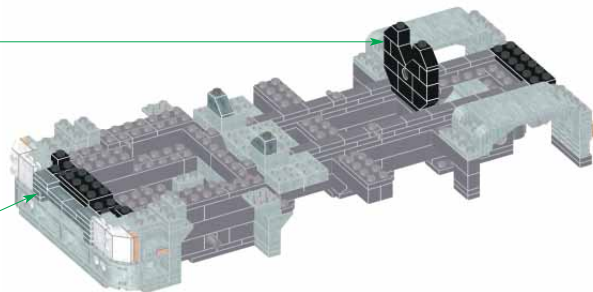

36

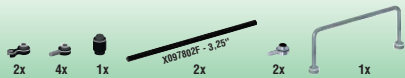

2x



37

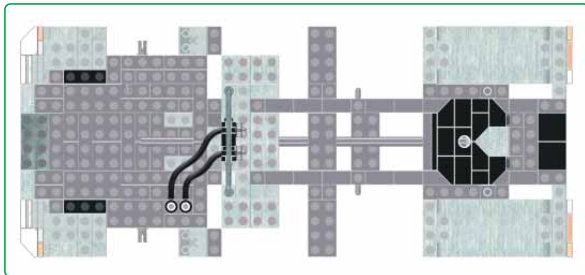
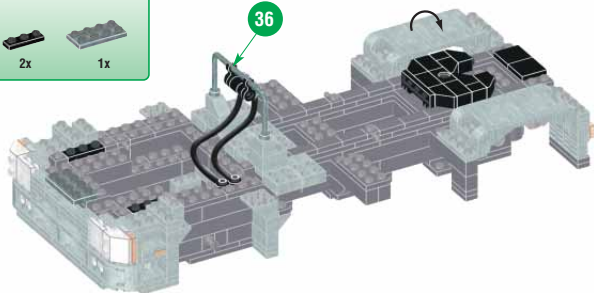

38

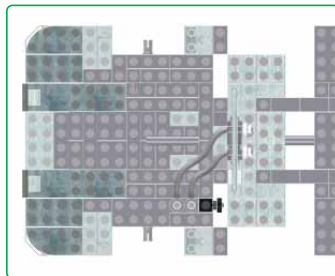
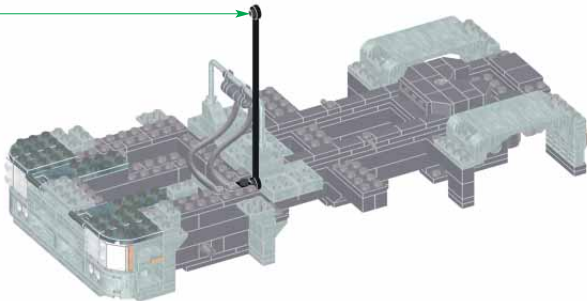
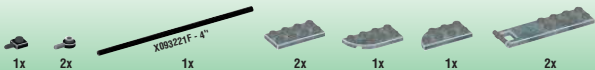

39

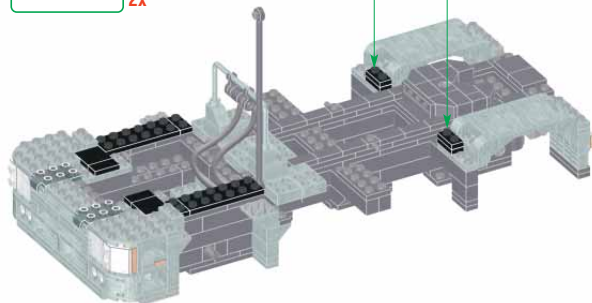
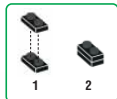
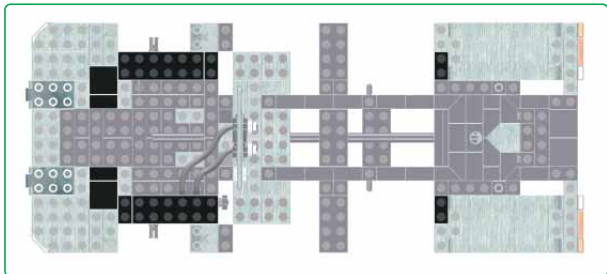

40

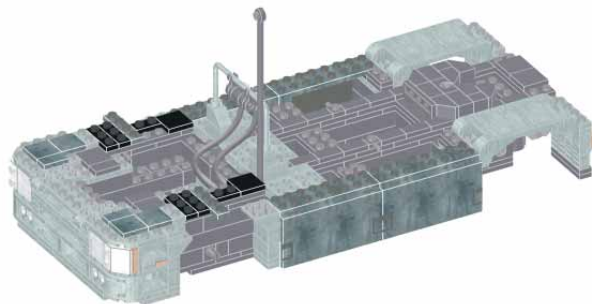
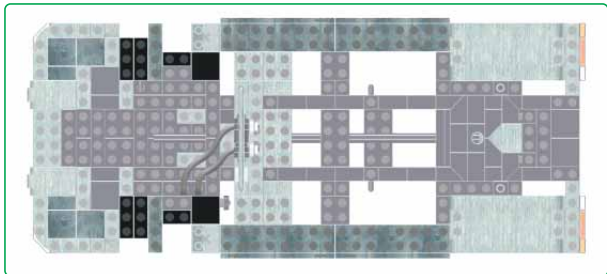
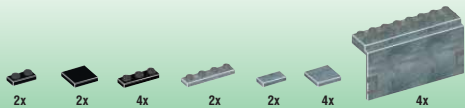

41

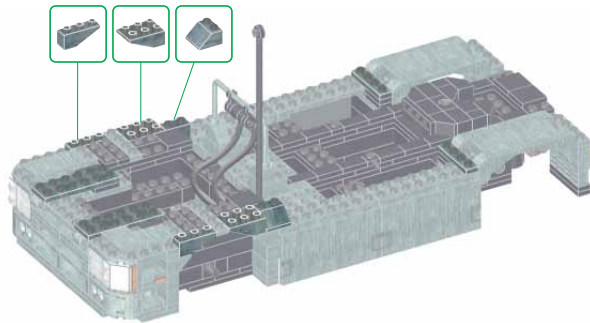
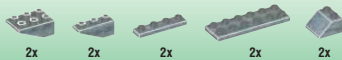

42

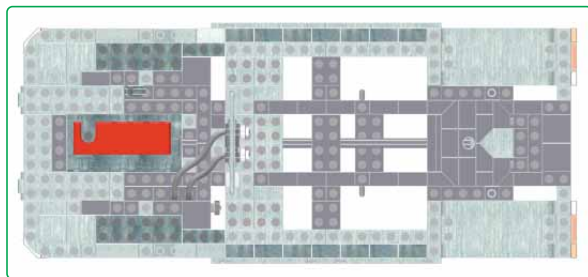
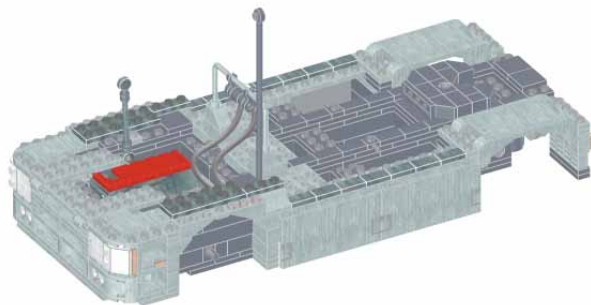
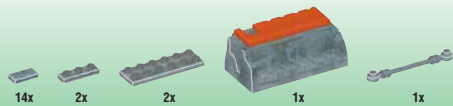

43

10x 2x 2x 4x

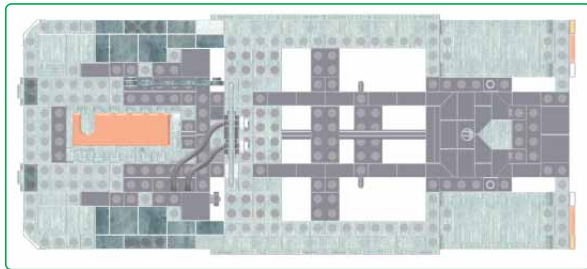
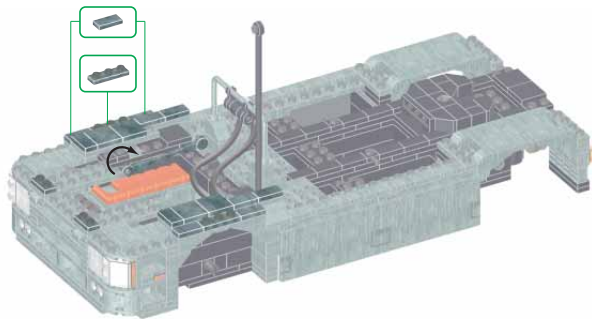

44

2x 2x



45

1x 2x



46

4x 2x 2x

1 2

2x

45

1 2 2x

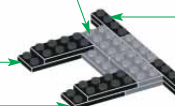

47

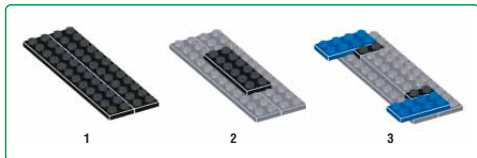
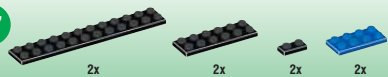

48



Place temporary piece • Colocar la pieza provisional
Poser la pièce temporaire • Tijdelijk deel plaatsen

49

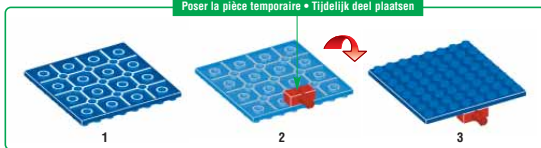
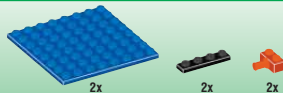

2x



50

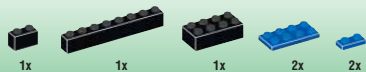

51

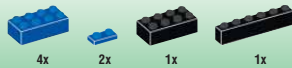

52

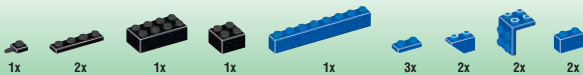

53

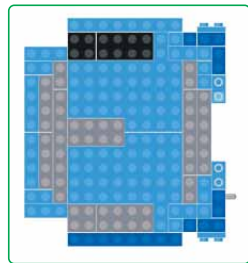
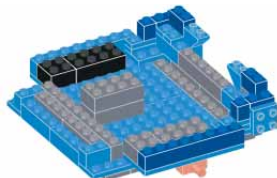
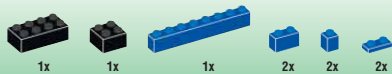

54



55

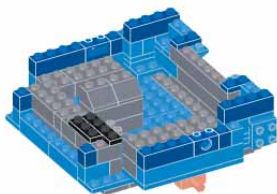
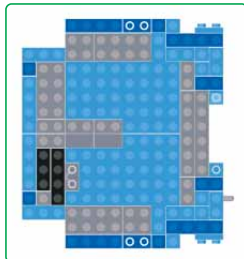

56

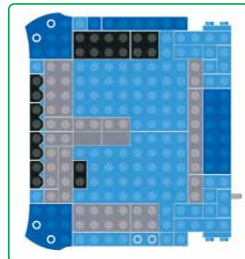
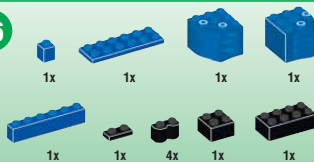

57



2x

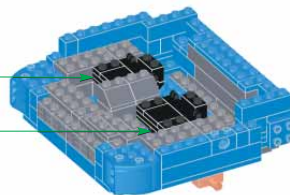
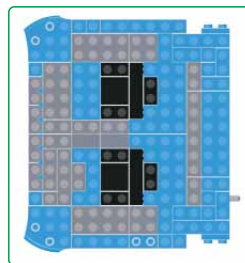

58

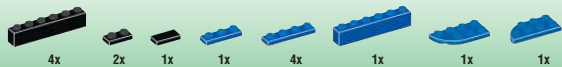

59



60

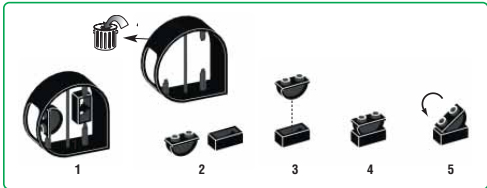
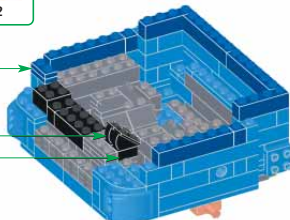
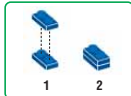
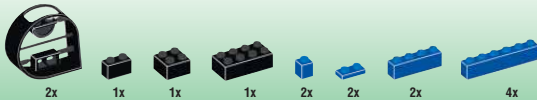

2x

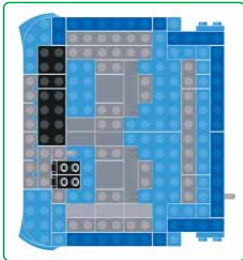

33

61

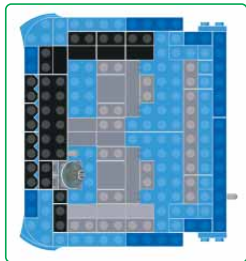
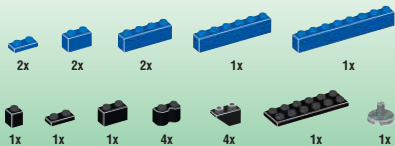

62

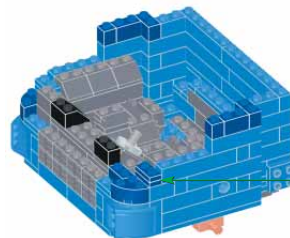
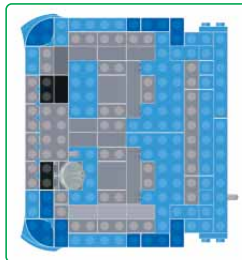

63



2x

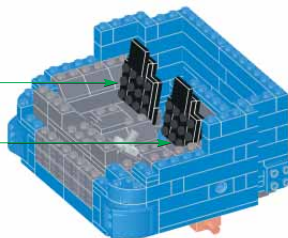

64

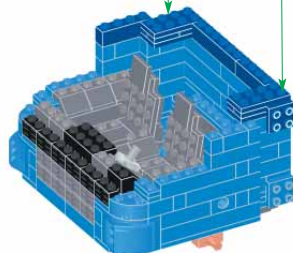
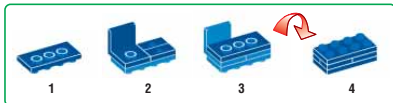
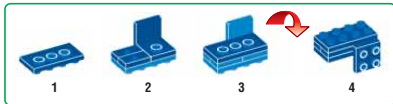
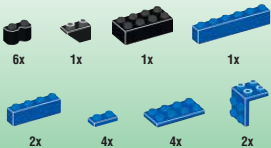

65

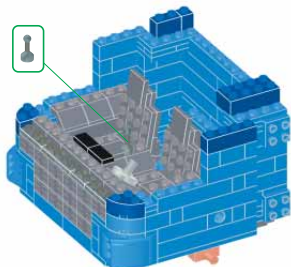
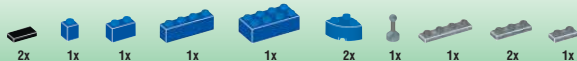

66

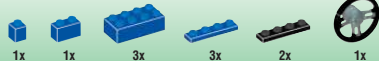

67

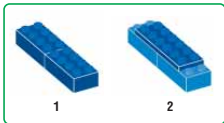
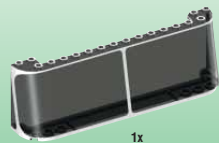
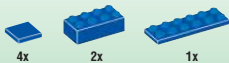

68

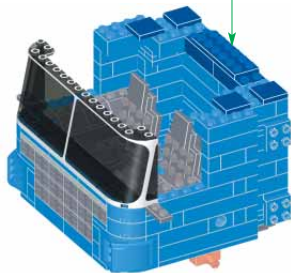

69

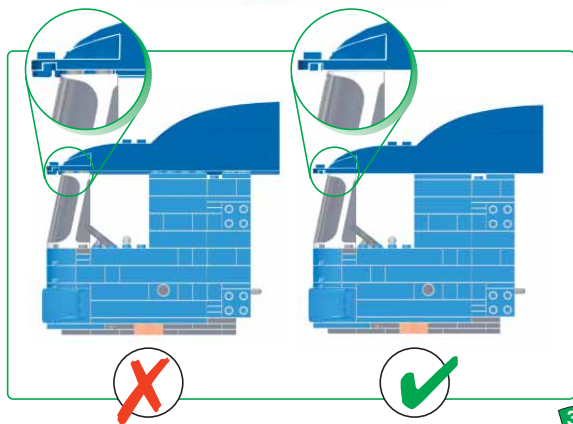
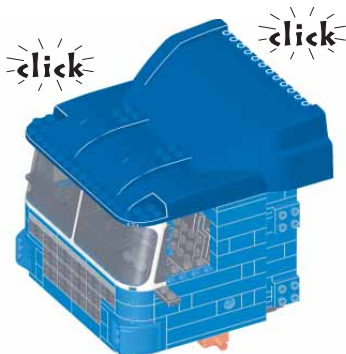
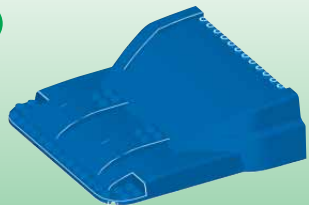

70

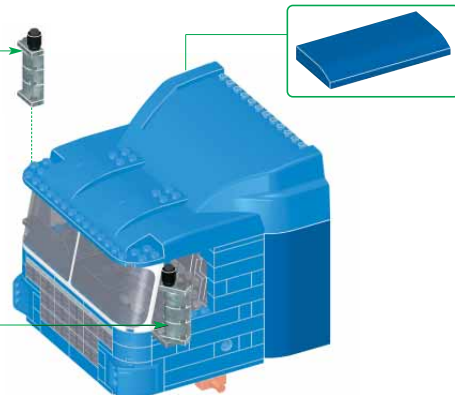
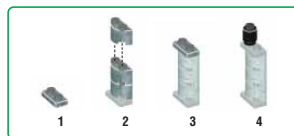
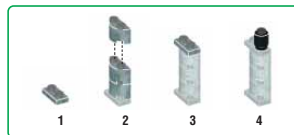

71

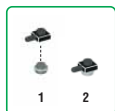
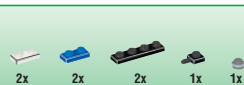

72

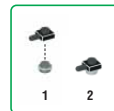

Remove temporary piece
Retirar la pieza provisional
Retirer la pièce temporaire
Verwijder tijdelijk deel



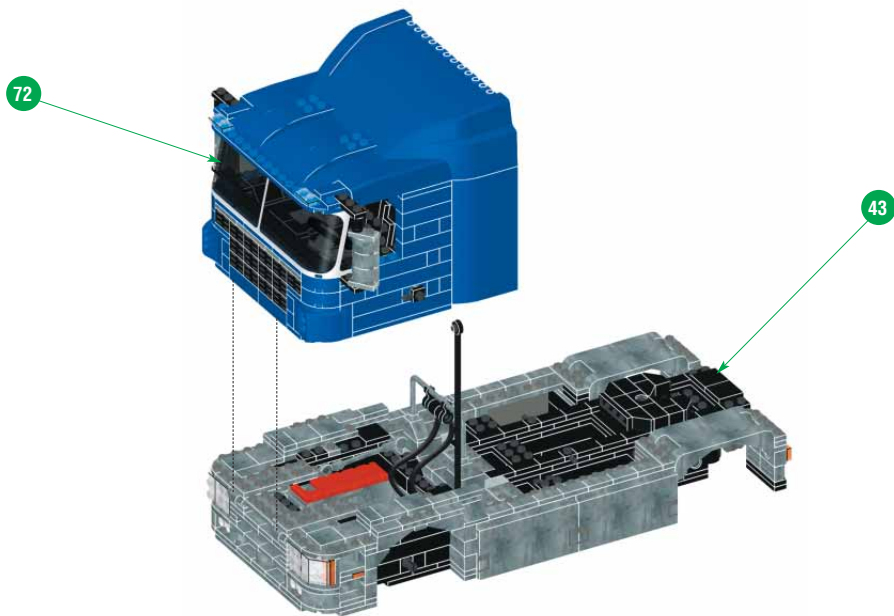

74



2x

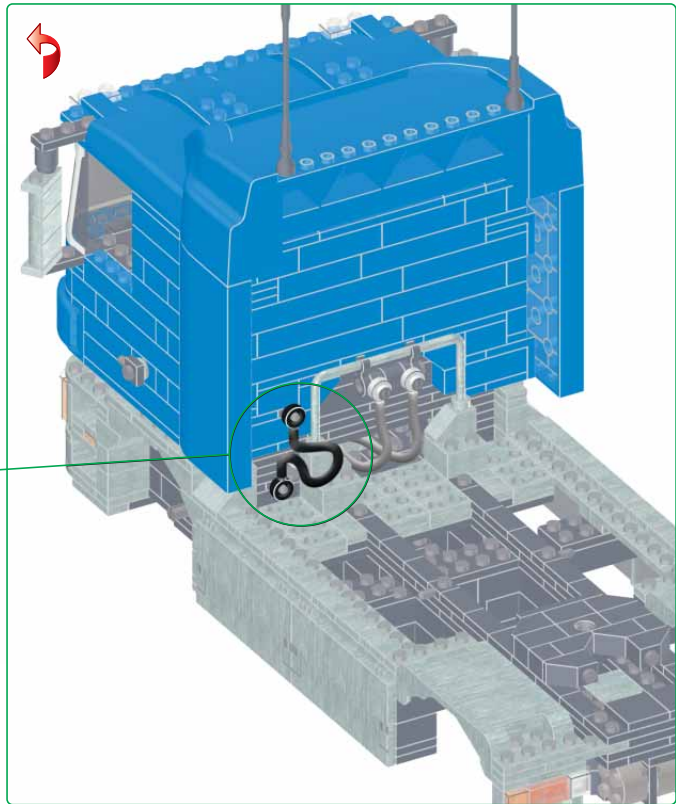

75

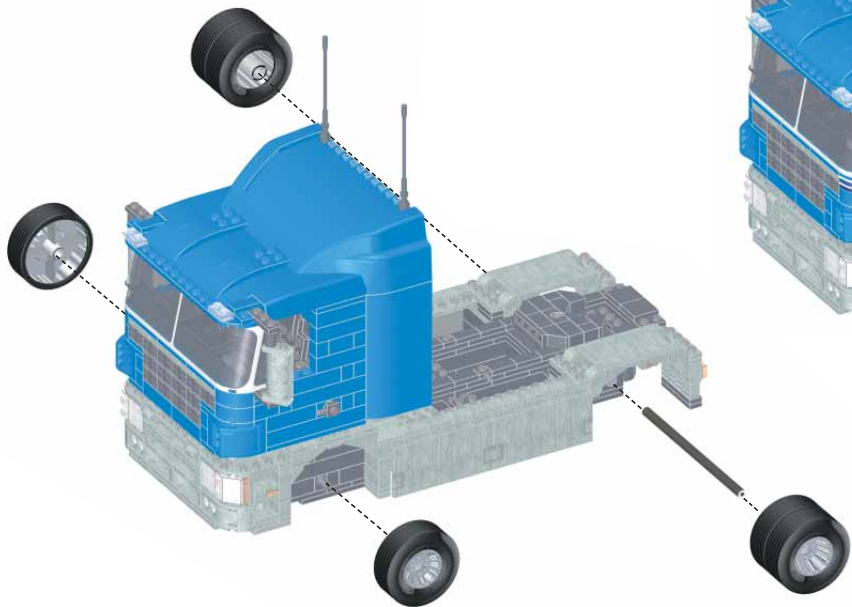

76



77

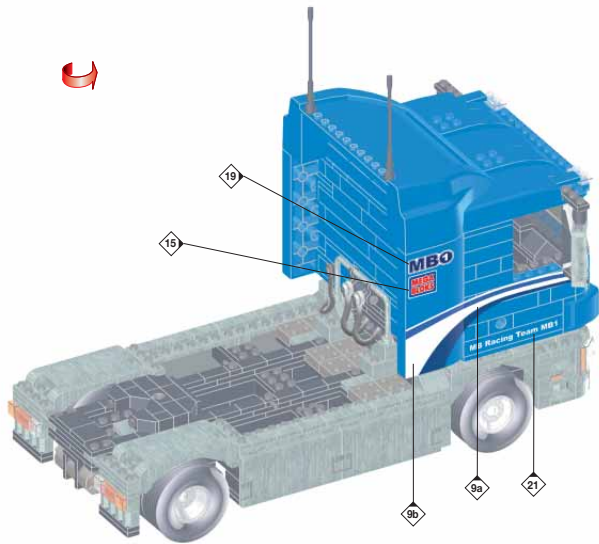

78



PROBUILDER

RACING RIG



Flip-up cab & detailed engine compartment
Cabina accionada y detallado compartimiento del motor
Cabine escamotable et compartiment moteur détaillé
Opklappende cabine en gedetailleerde motorcompartiment

Section 3 • Sección 3
Section 3 • Deel 3

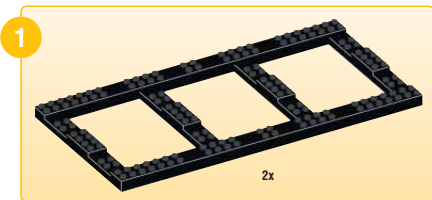
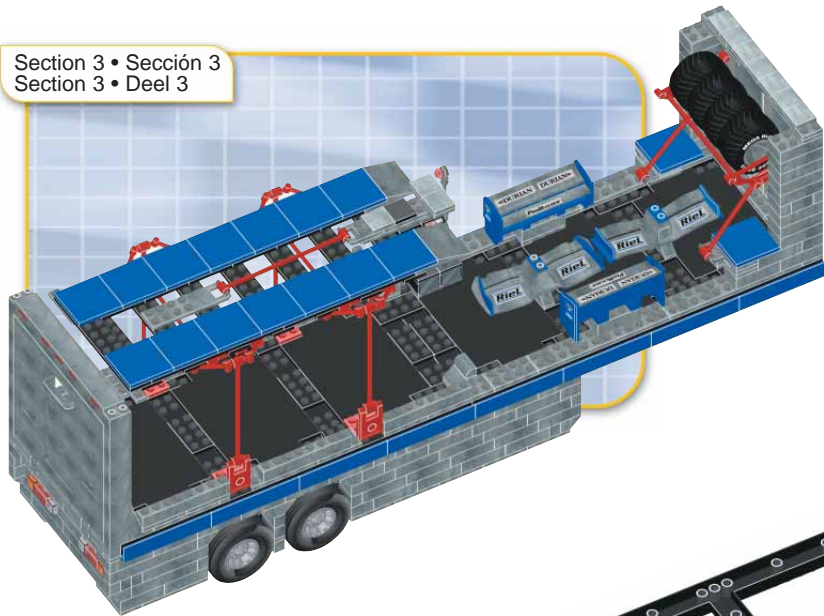

2

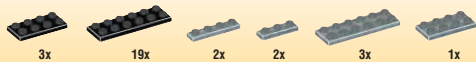

3

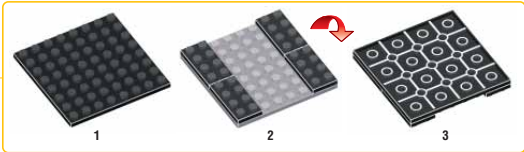
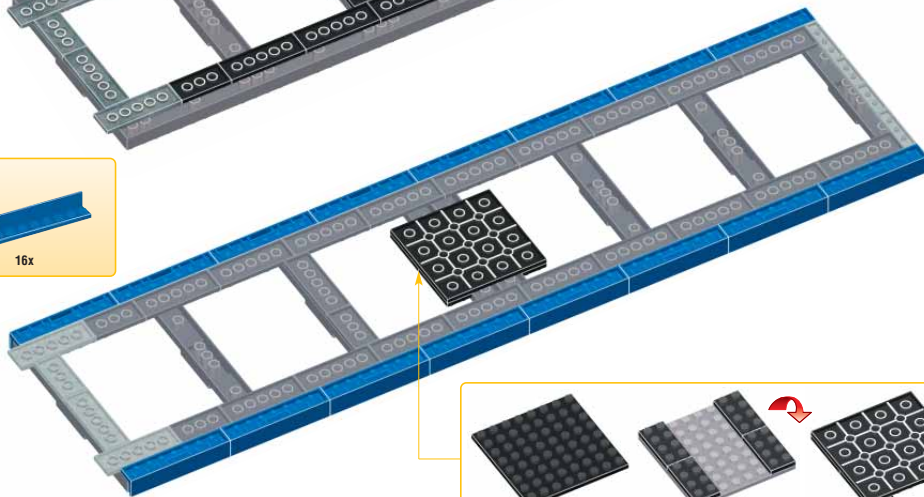
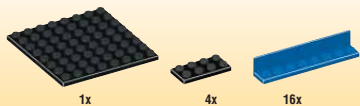

4



4x



2x

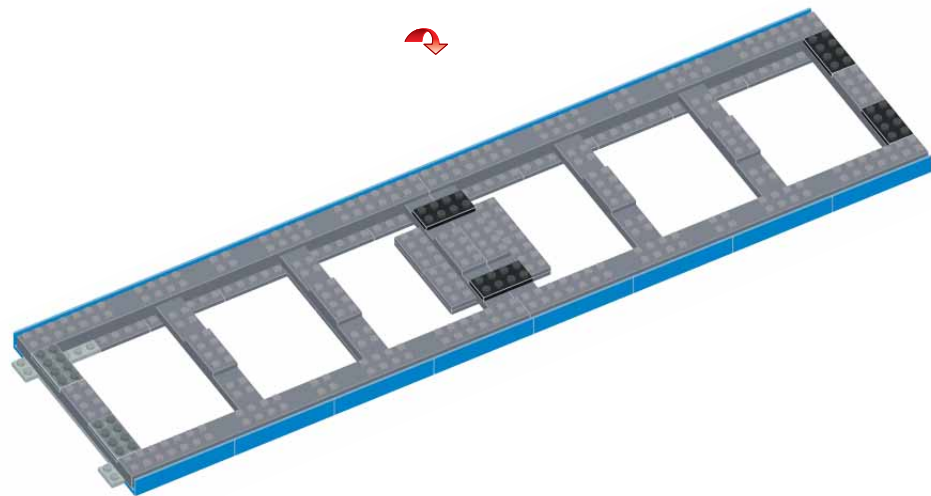

5



6x

24x



1



2



3

6x

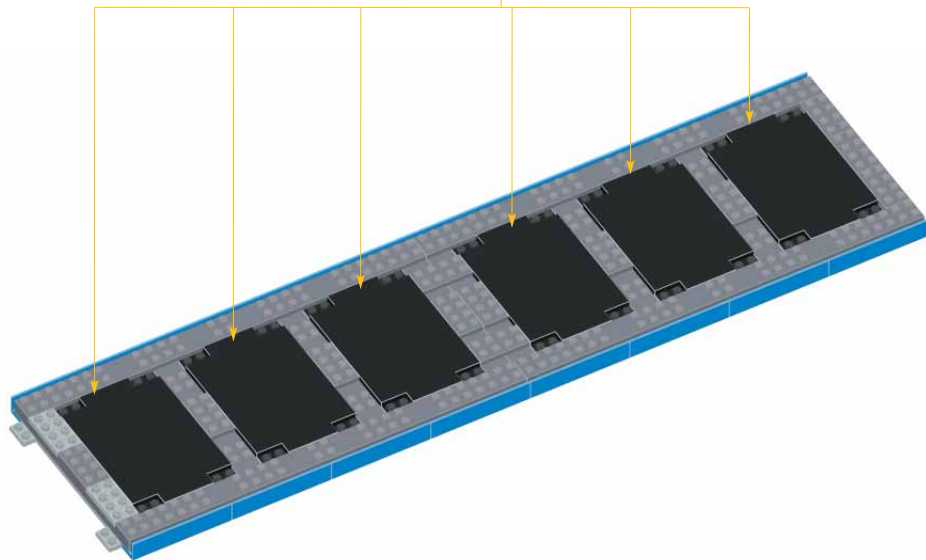

6
12x

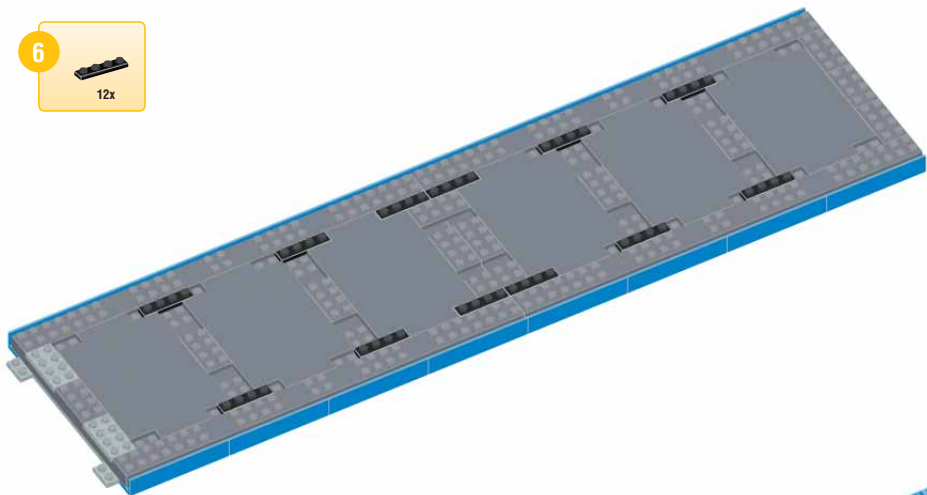

7
1x 2x 8x 2x

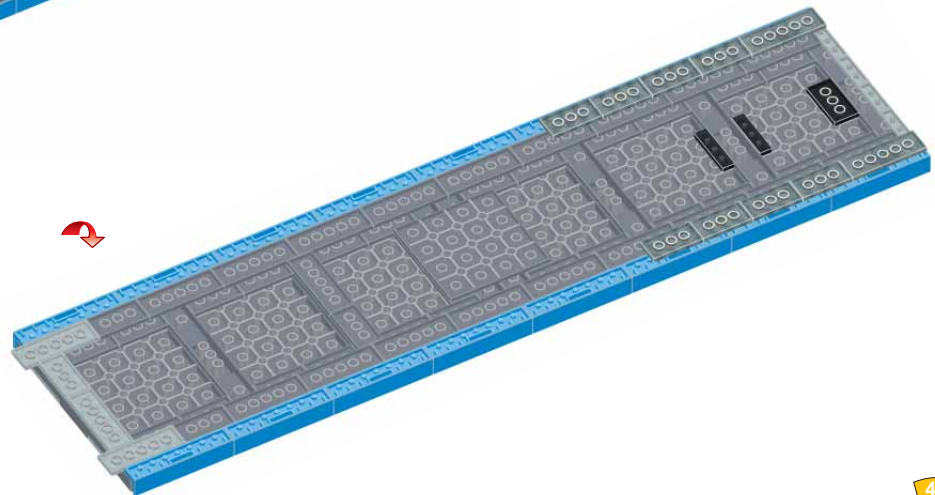

8



3x



8x

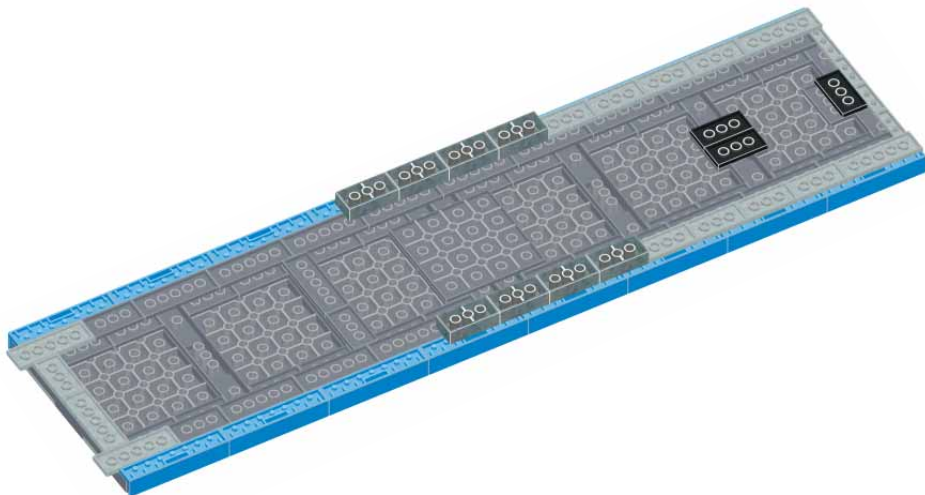

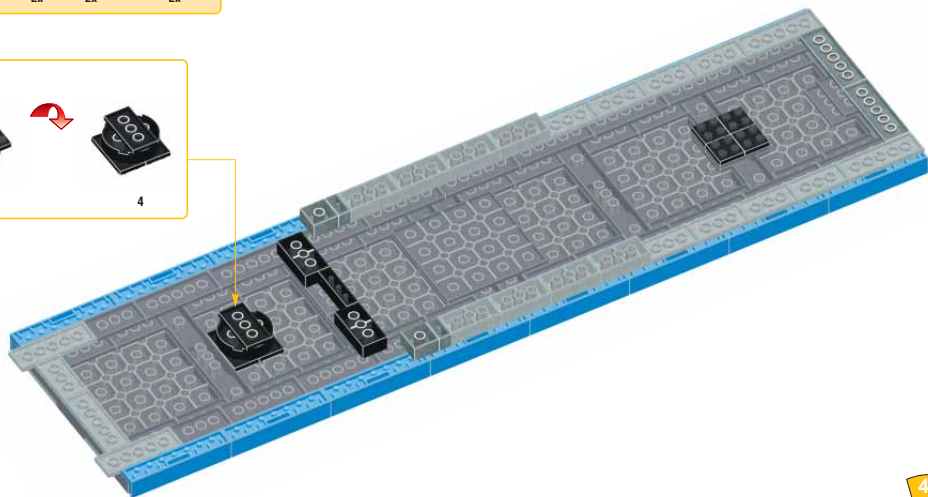
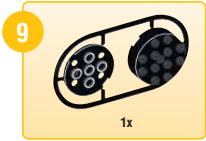

11

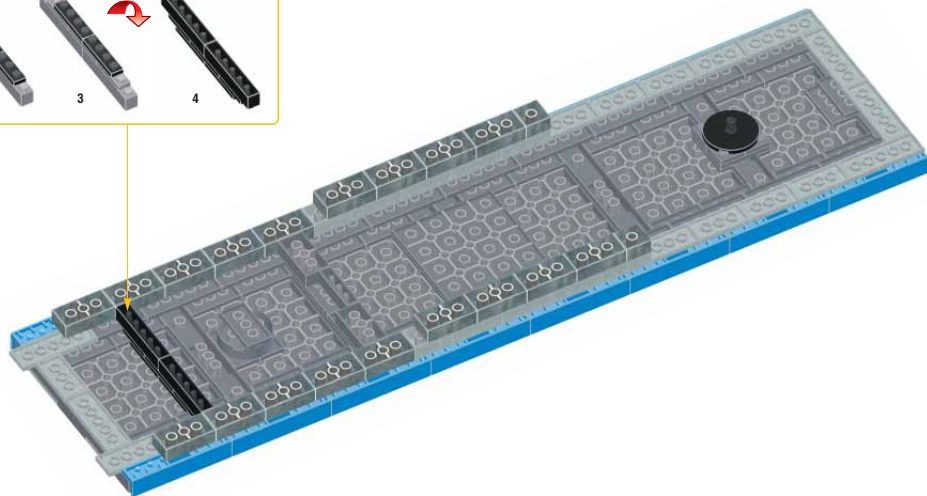
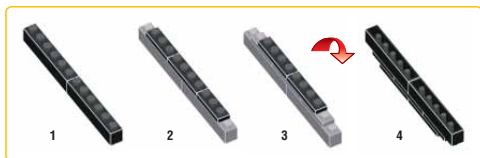
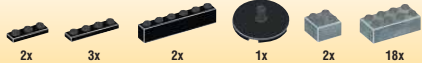

12

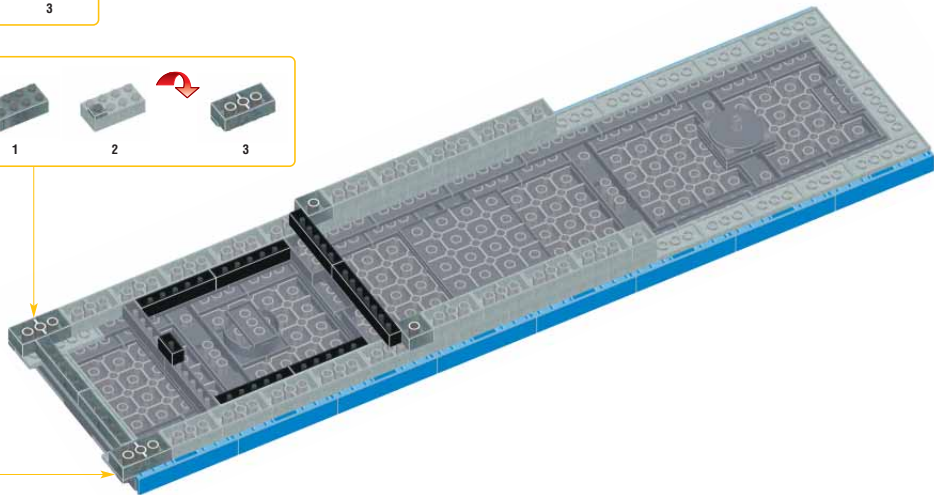

13

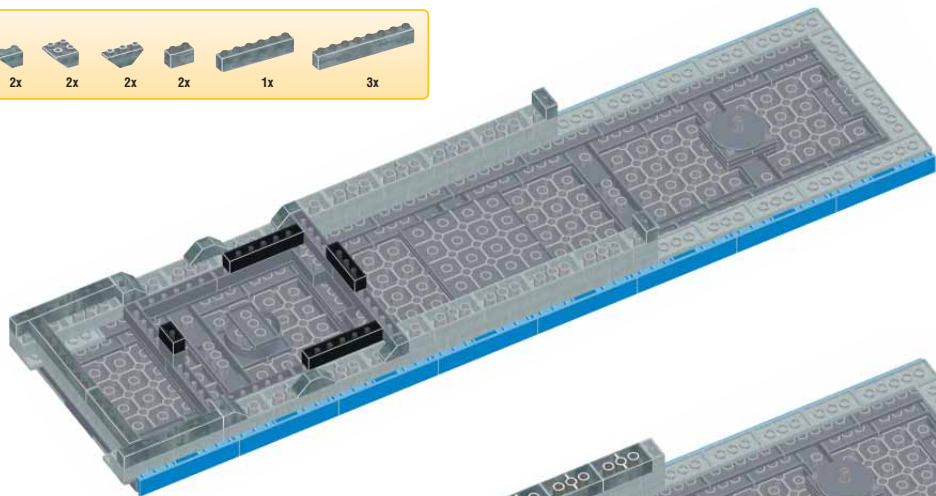
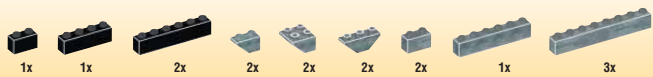

14

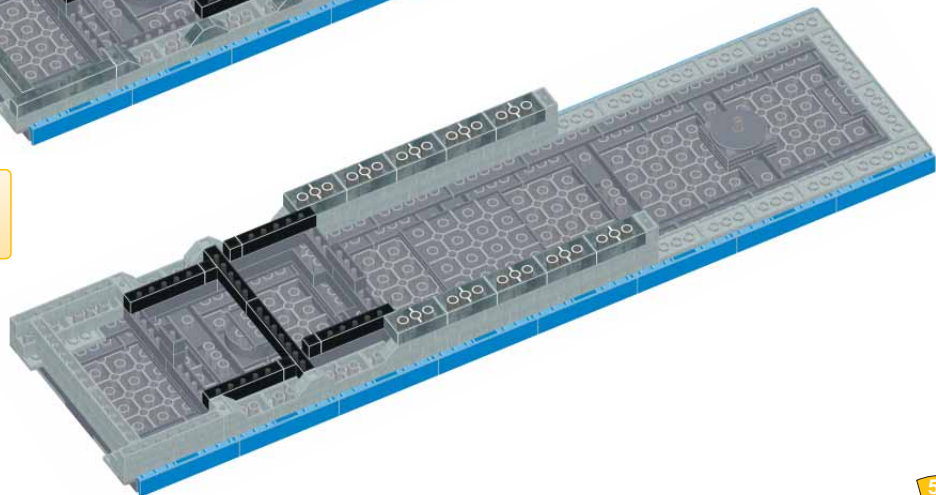

15

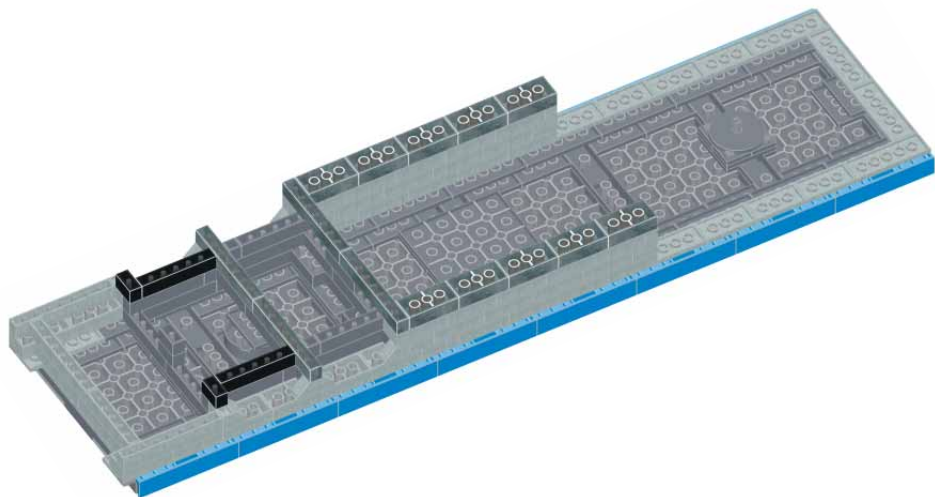

16

- 2x [1x black 1-hole Technic brick]
- 4x [1x black 2-hole Technic brick]
- 2x [1x black 3-hole Technic brick]
- 2x [1x grey 1-hole Technic Technic pin]
- 2x [1x red 1-hole Technic Technic pin]
- 2x [1x red 2-hole Technic Technic pin]
- 4x [1x grey 1-hole Technic Technic pin]
- 6x [1x grey 2-hole Technic Technic pin]
- 4x [1x grey 3-hole Technic Technic pin]
- 2x [1x grey 4-hole Technic Technic pin]
- 2x [1x grey 5-hole Technic Technic pin]
- 8x [1x grey 6-hole Technic Technic pin]
- 1x [1x grey 7-hole Technic Technic pin]
- 2x [1x grey 8-hole Technic Technic pin]

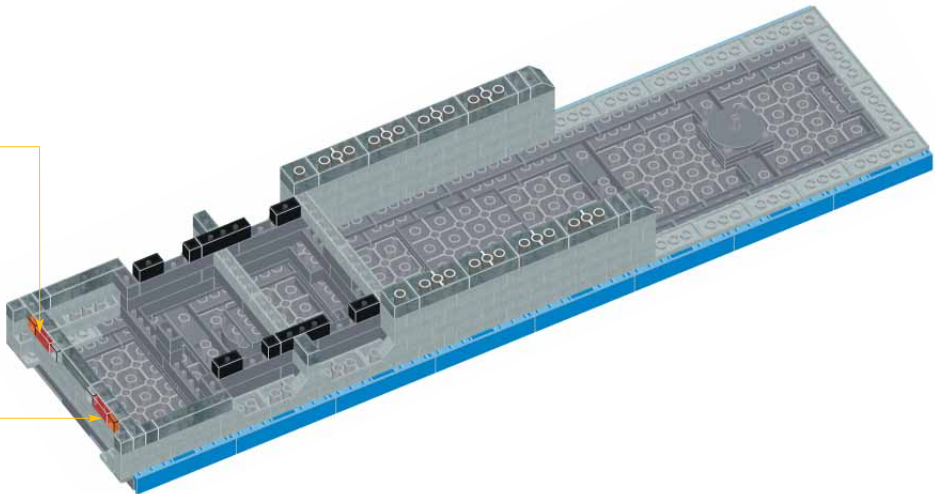
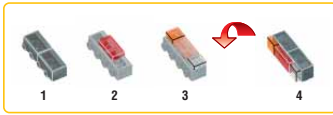

17

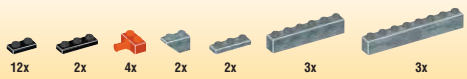

4x

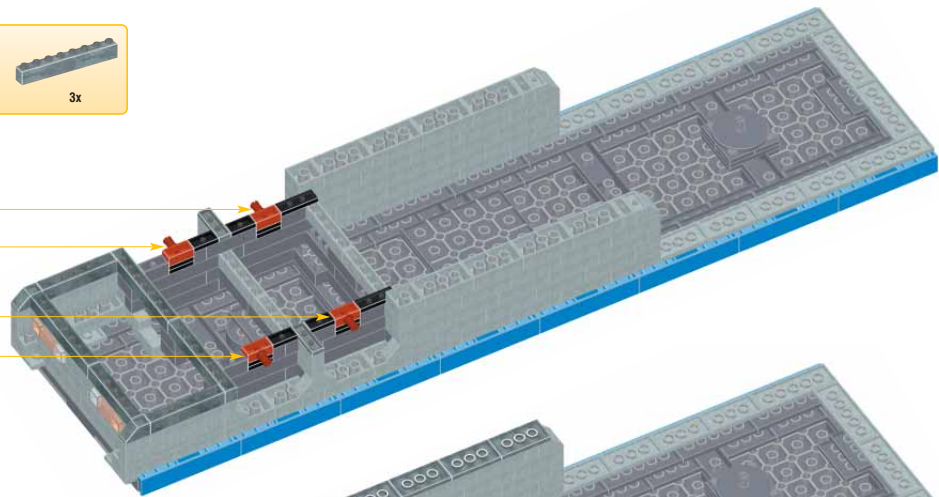

18

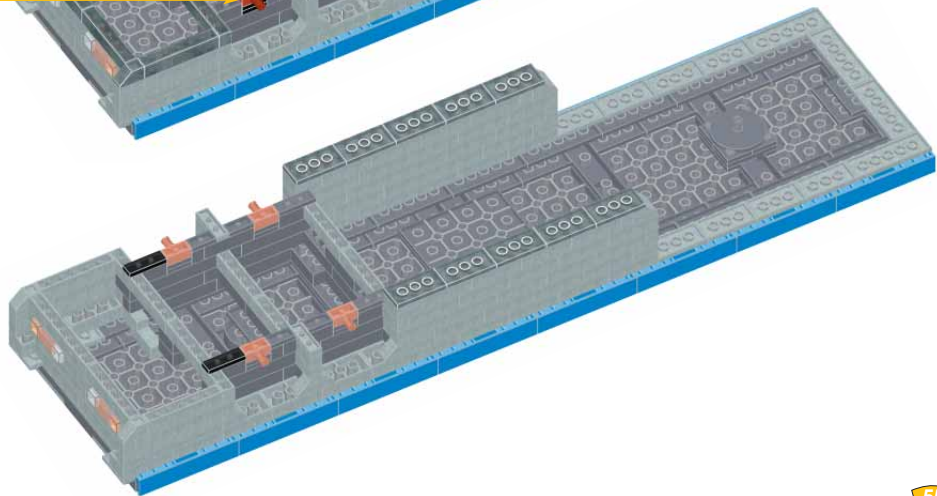

19

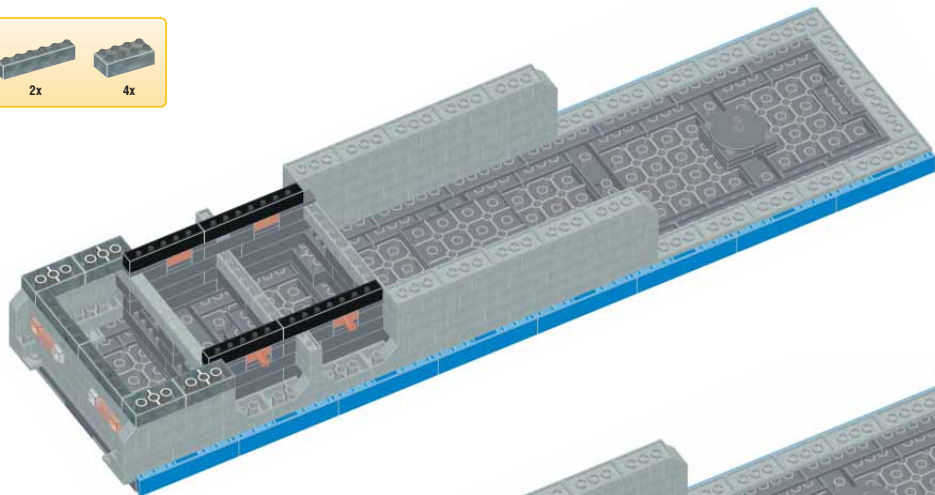
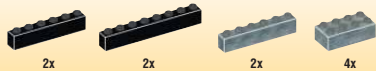

20

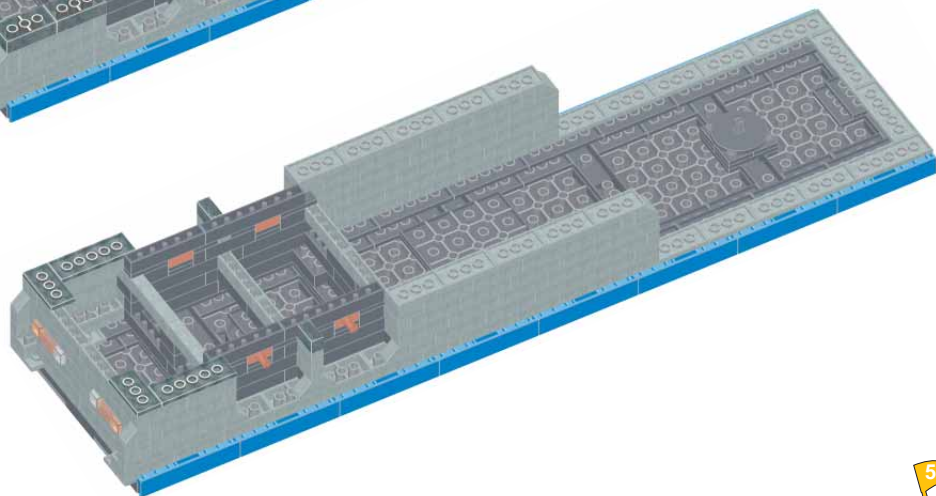

21



2x

4x

2x

Place temporary piece • Colocar la pieza provisional
 Poser la pièce temporaire • Tijdelijk deel plaatsen

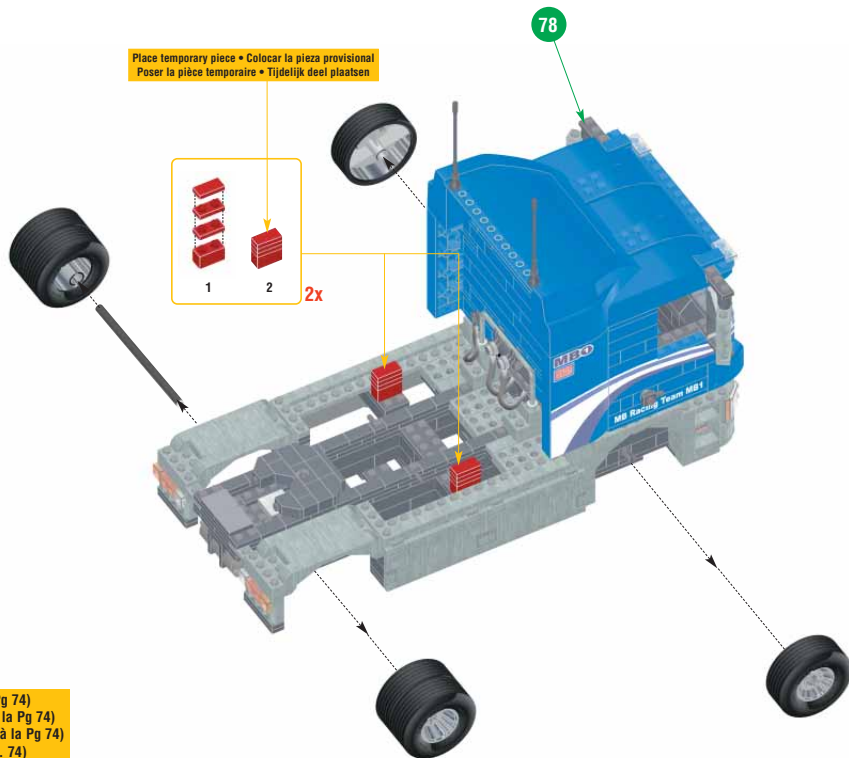
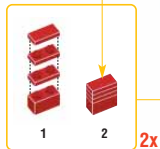

Remove wheels (Temporarily until Pg 74)
 Remover Llantas (Temporalmente hasta la Pg 74)
 Enlever les roues (Temporairement jusqu'à la Pg 74)
 Wielen verwijderen (tijdelijk tot blz. 74)

22

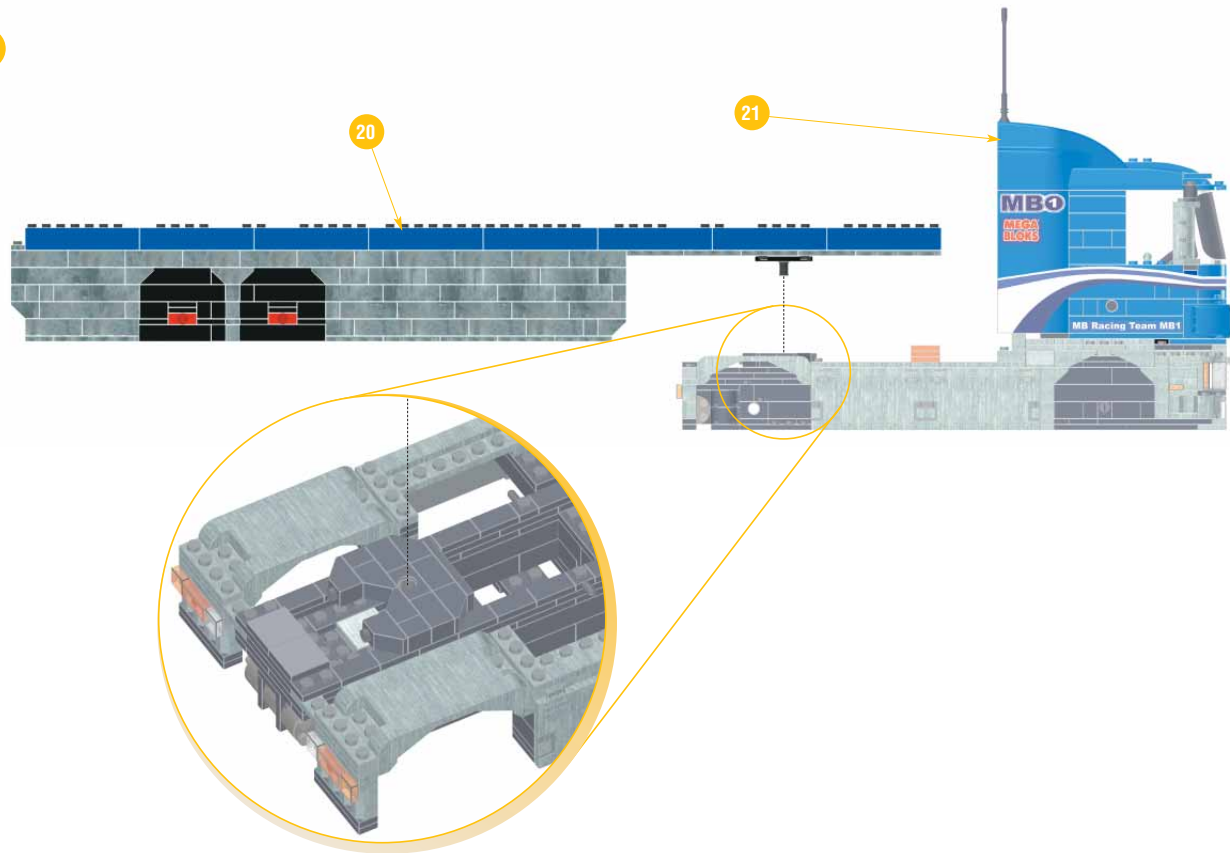

23



6x



7x



4x

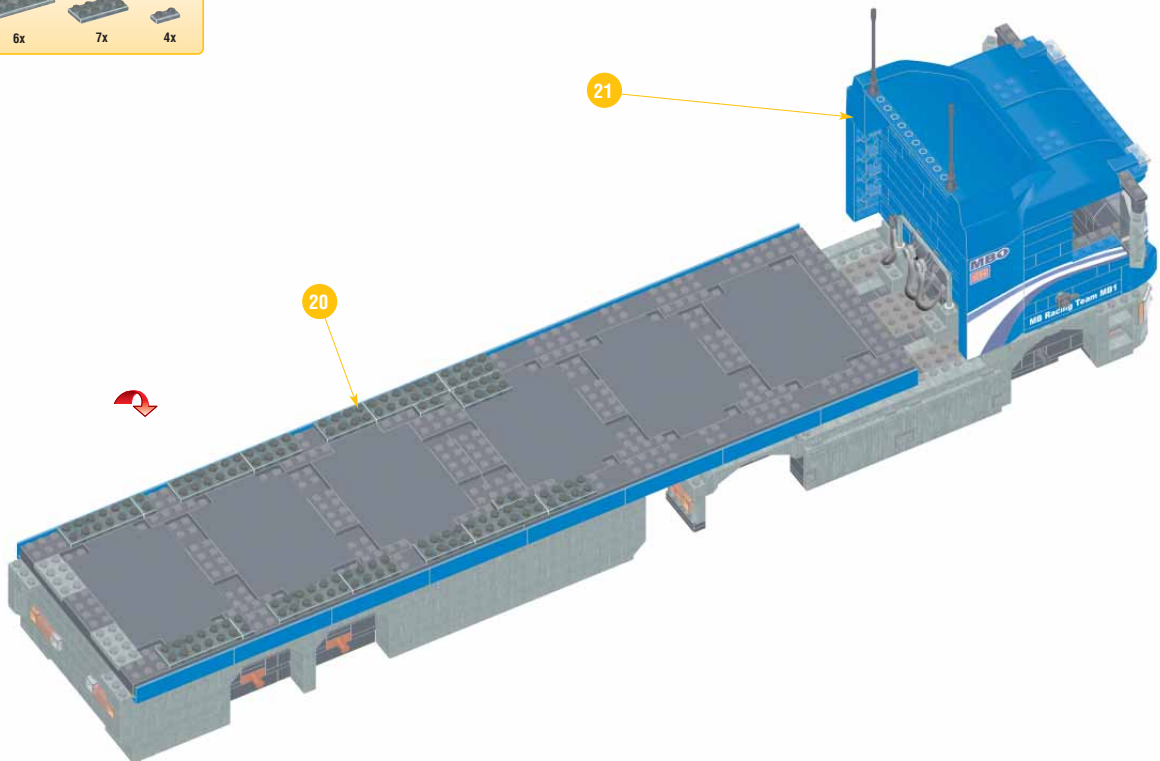

21

20

24

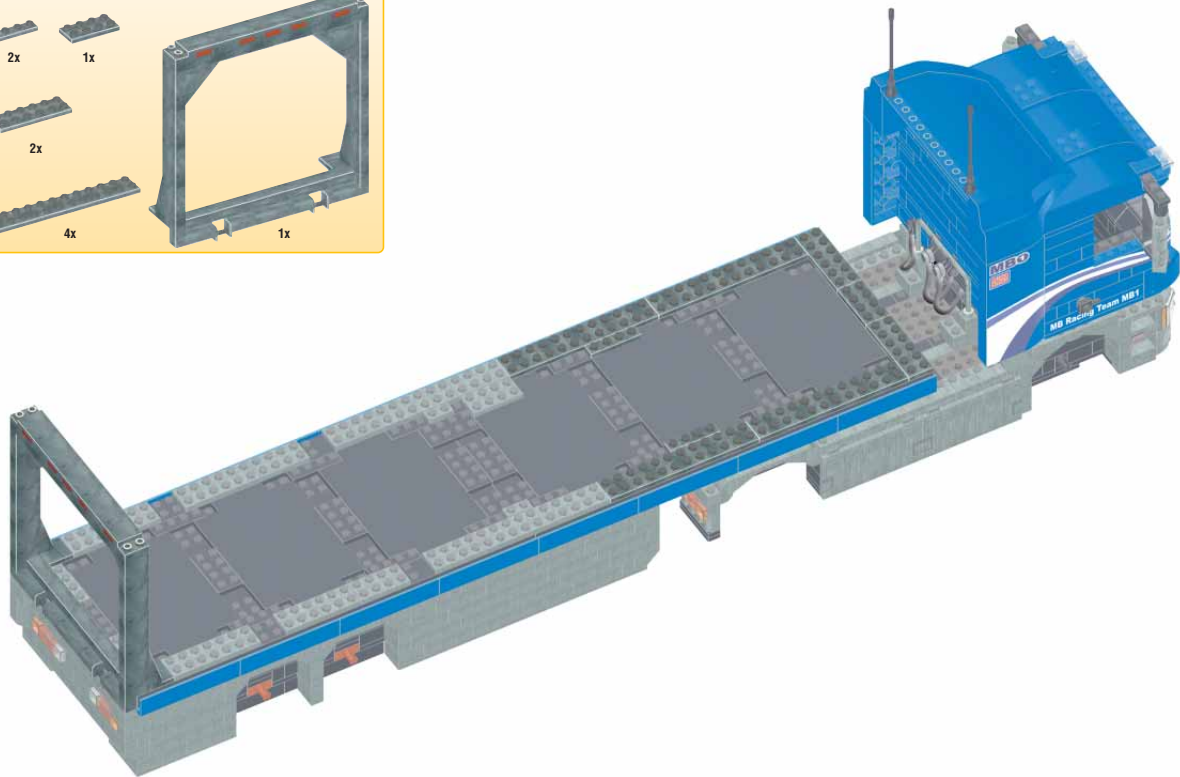
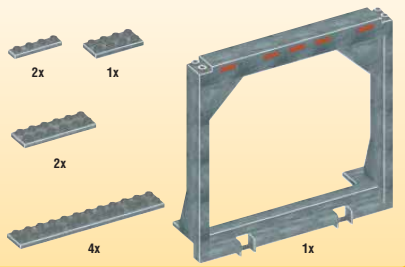

25

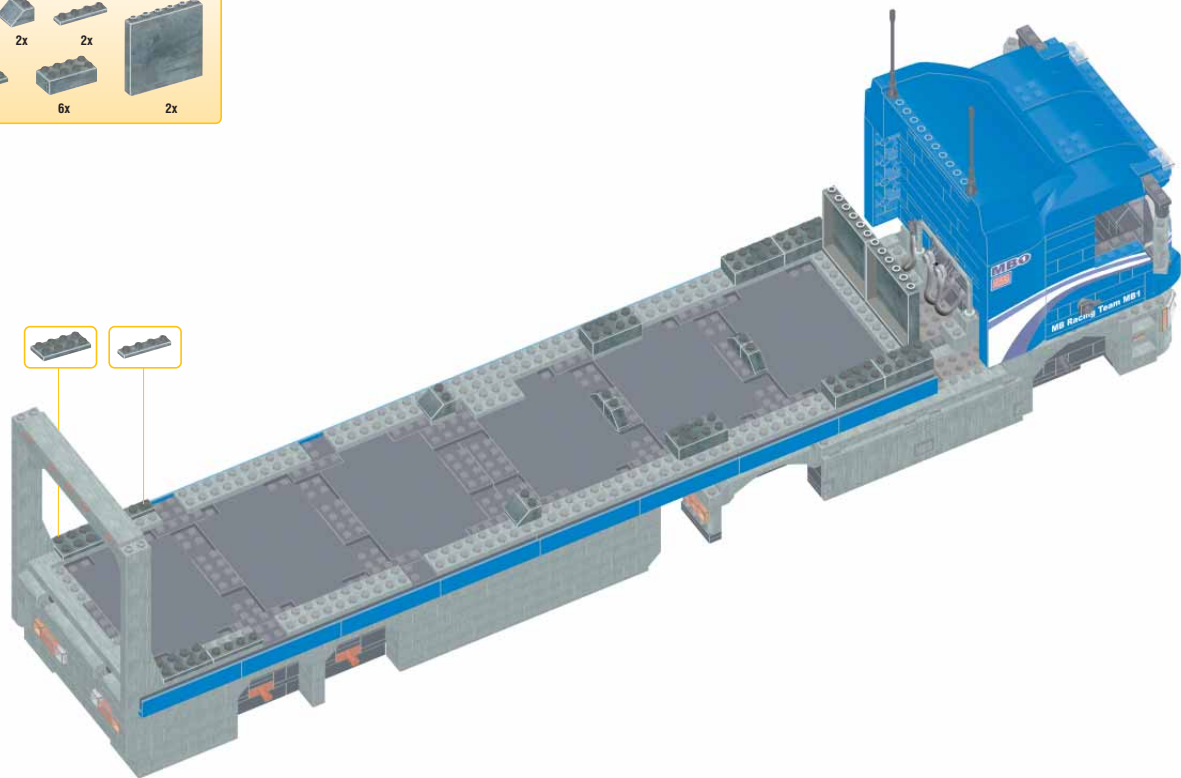
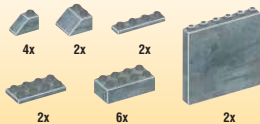

26

2x

1x

6x







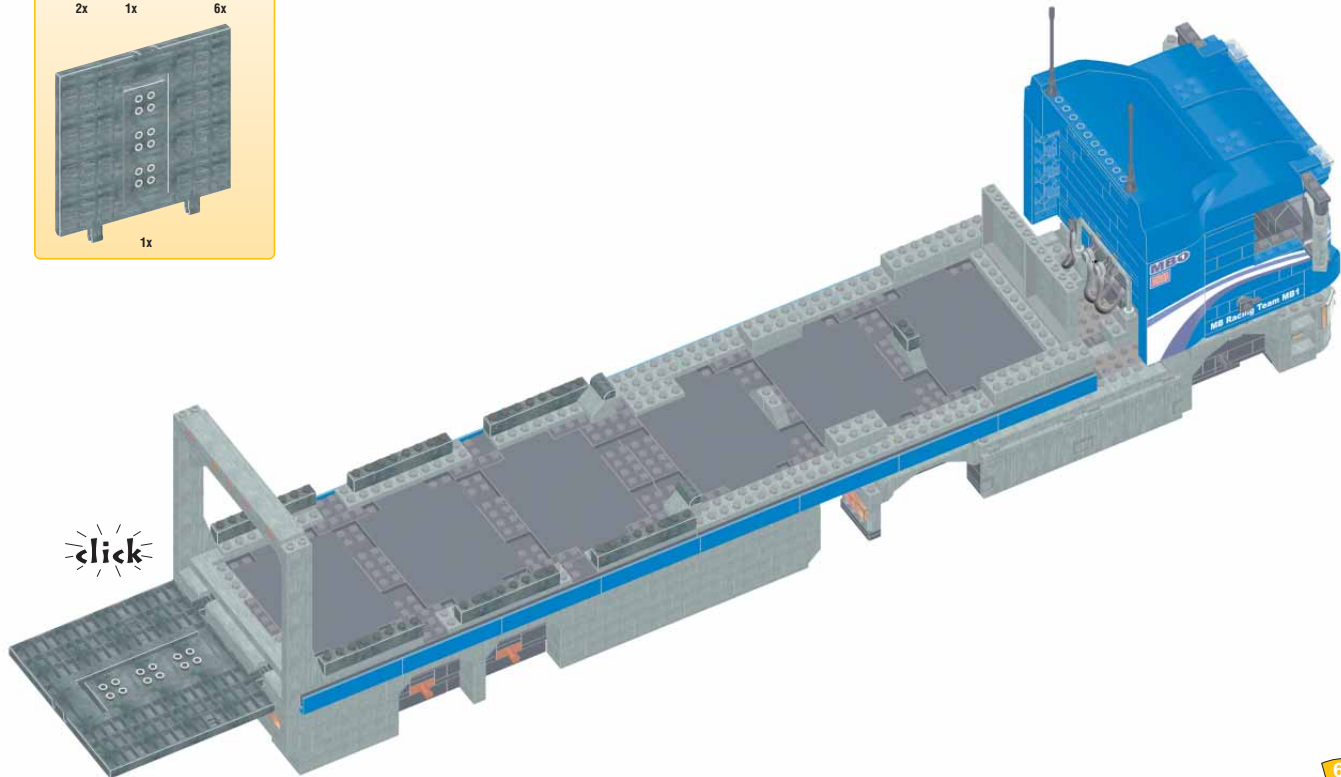







1x

click



27

- 1x 
- 1x 
- 1x 
- 1x 
- 2x 
- 1x 
- 1x 
- 2x 
- 2x 
- 2x 
- 2x 
- 3x 
- 1x 

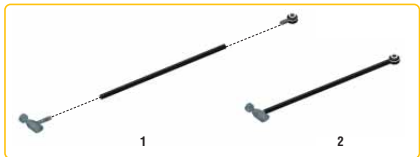

1



2



3



4



5



6

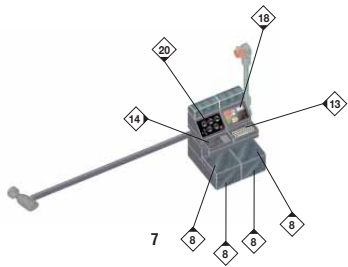

28



2x

2x

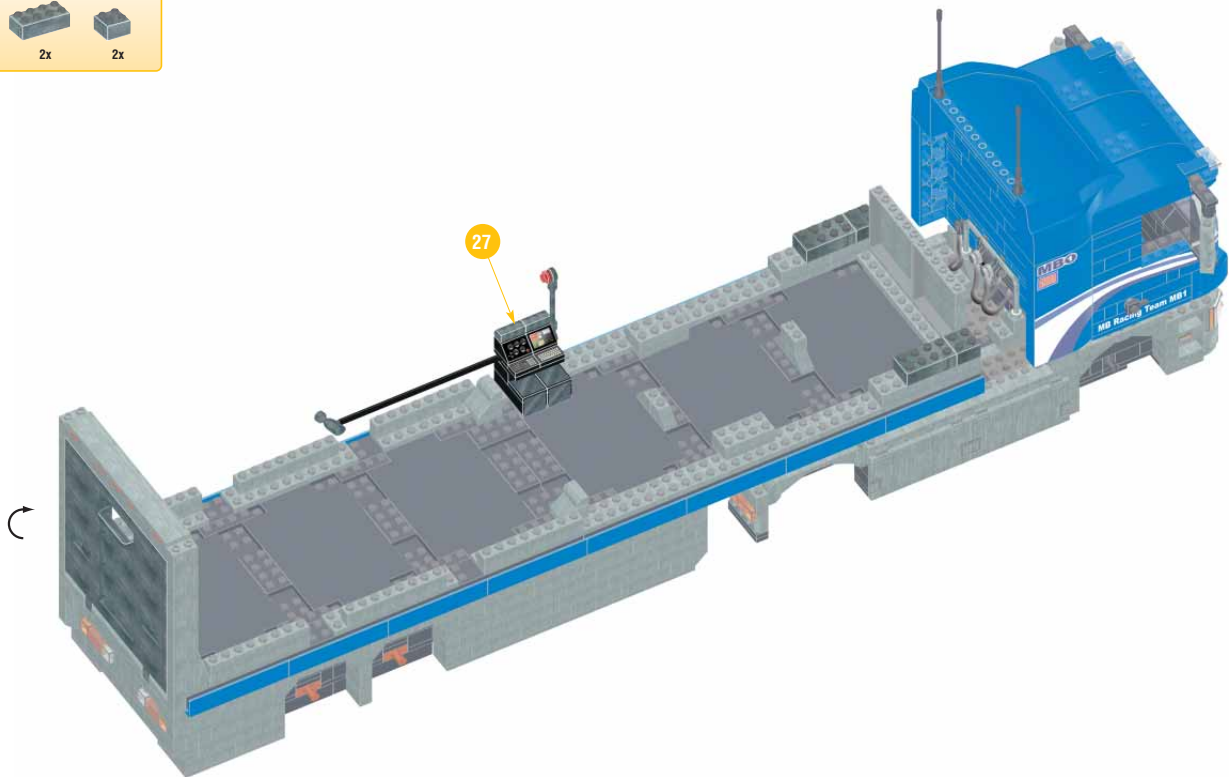

29



6x

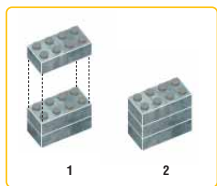

1

2

2x

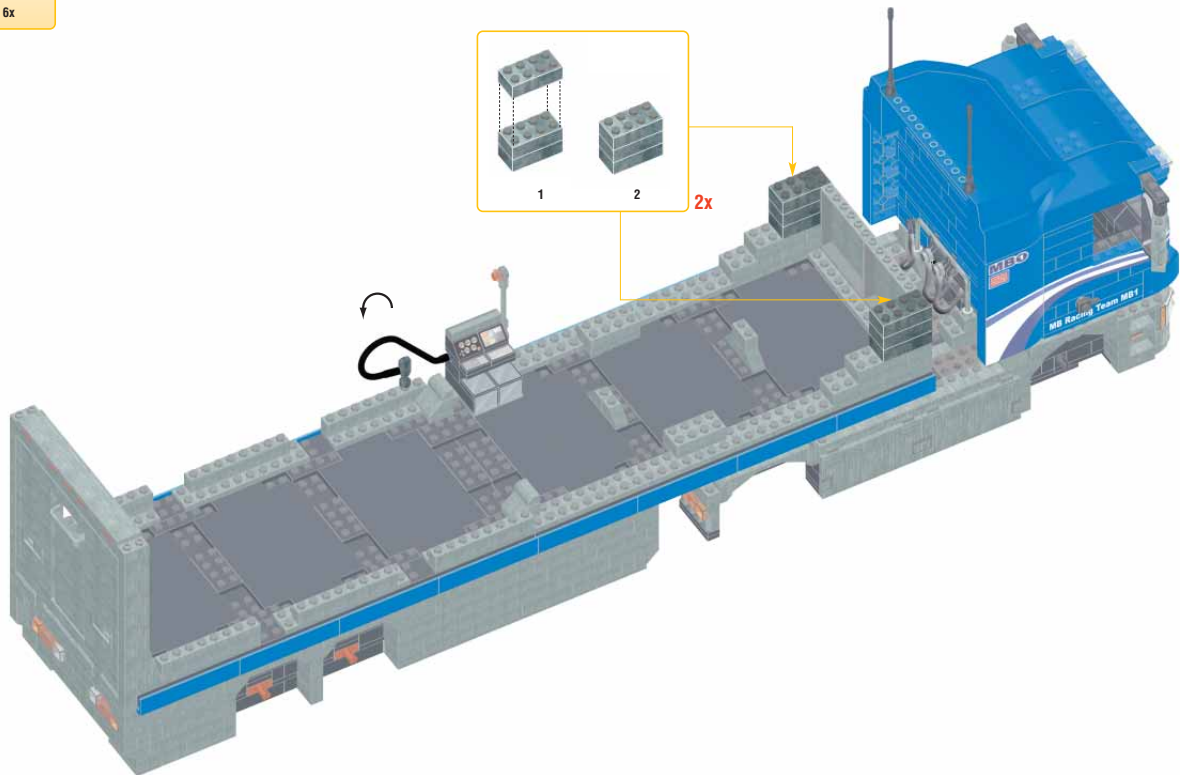

30

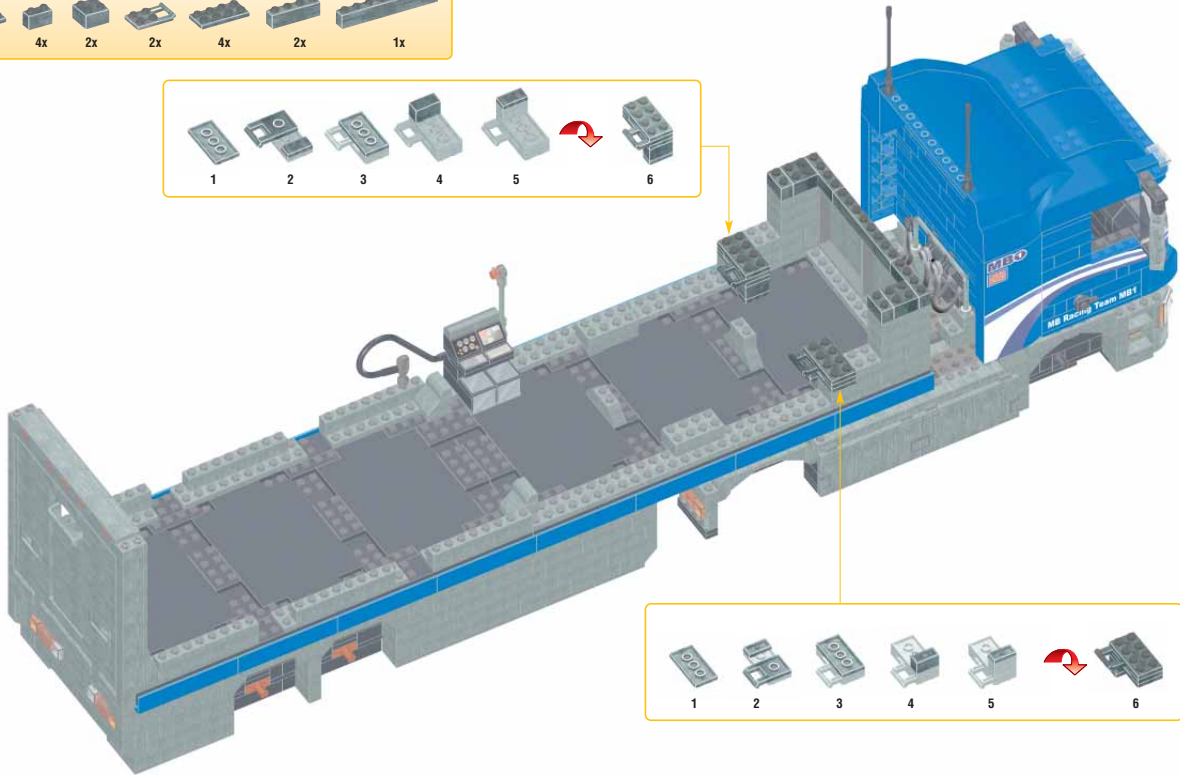
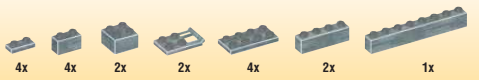

31



2x

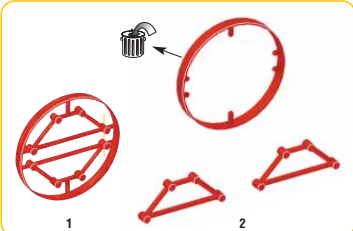

1

2

2x

32



8x

4x

4x

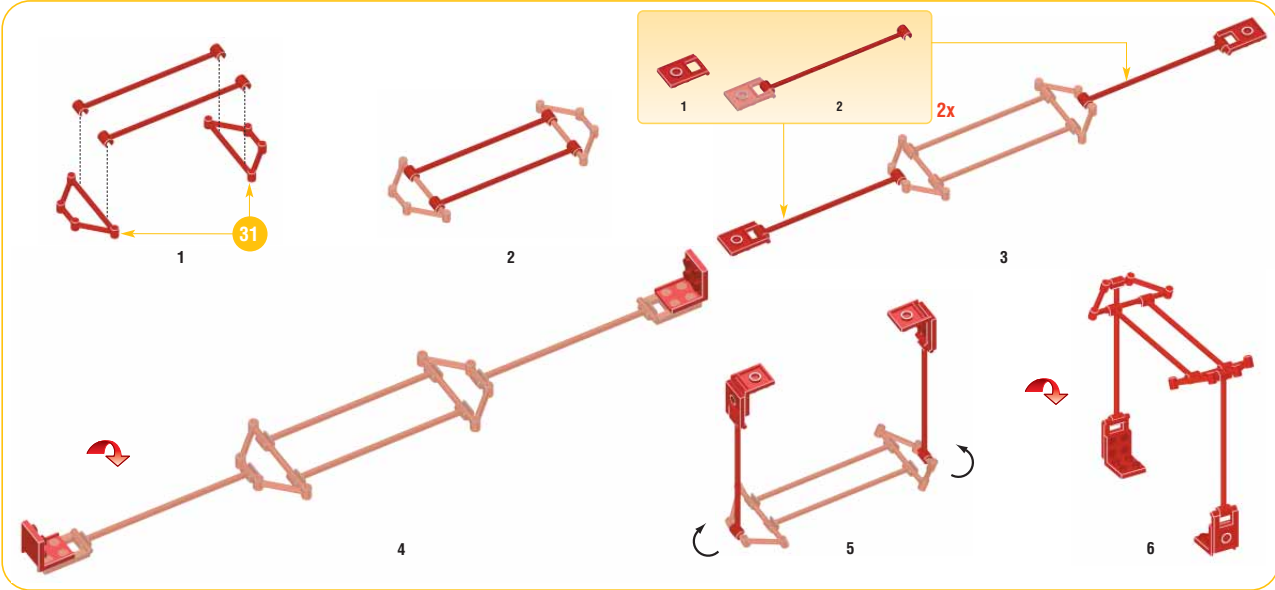

31

1

2

1

2

2x

3

4

5

6

2x

67

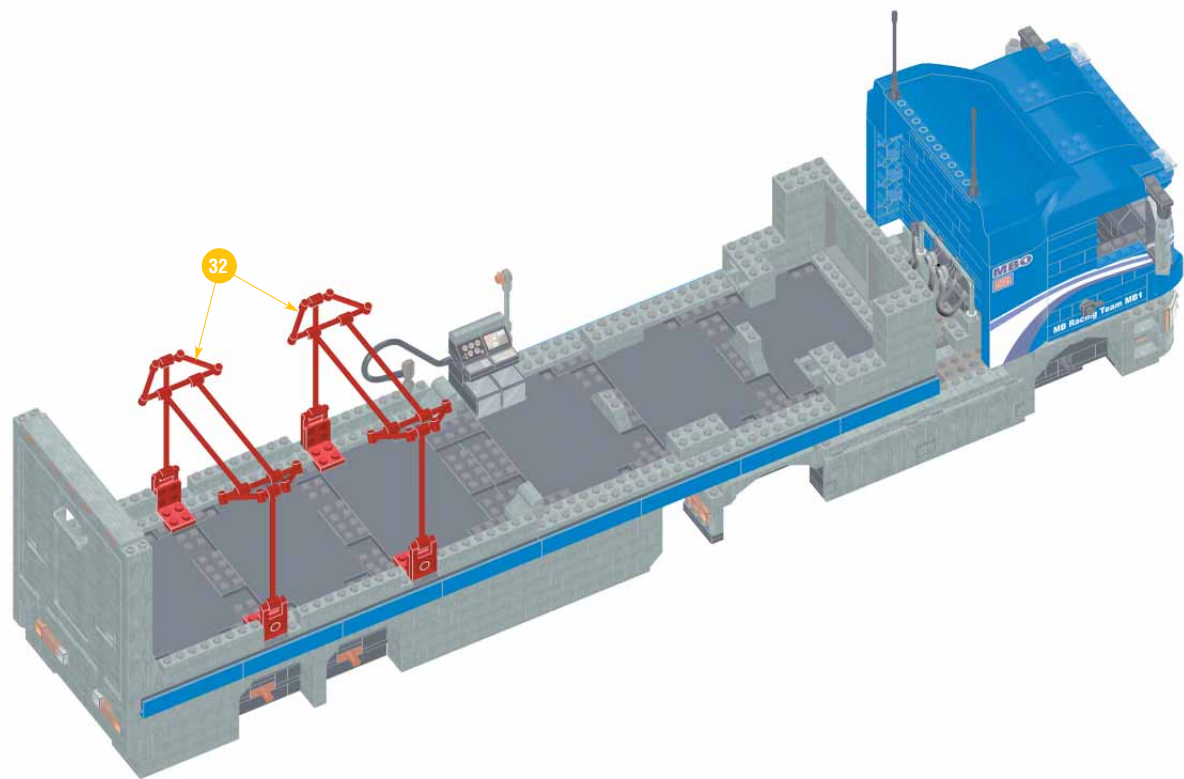

34



1x



1x



2x



2x

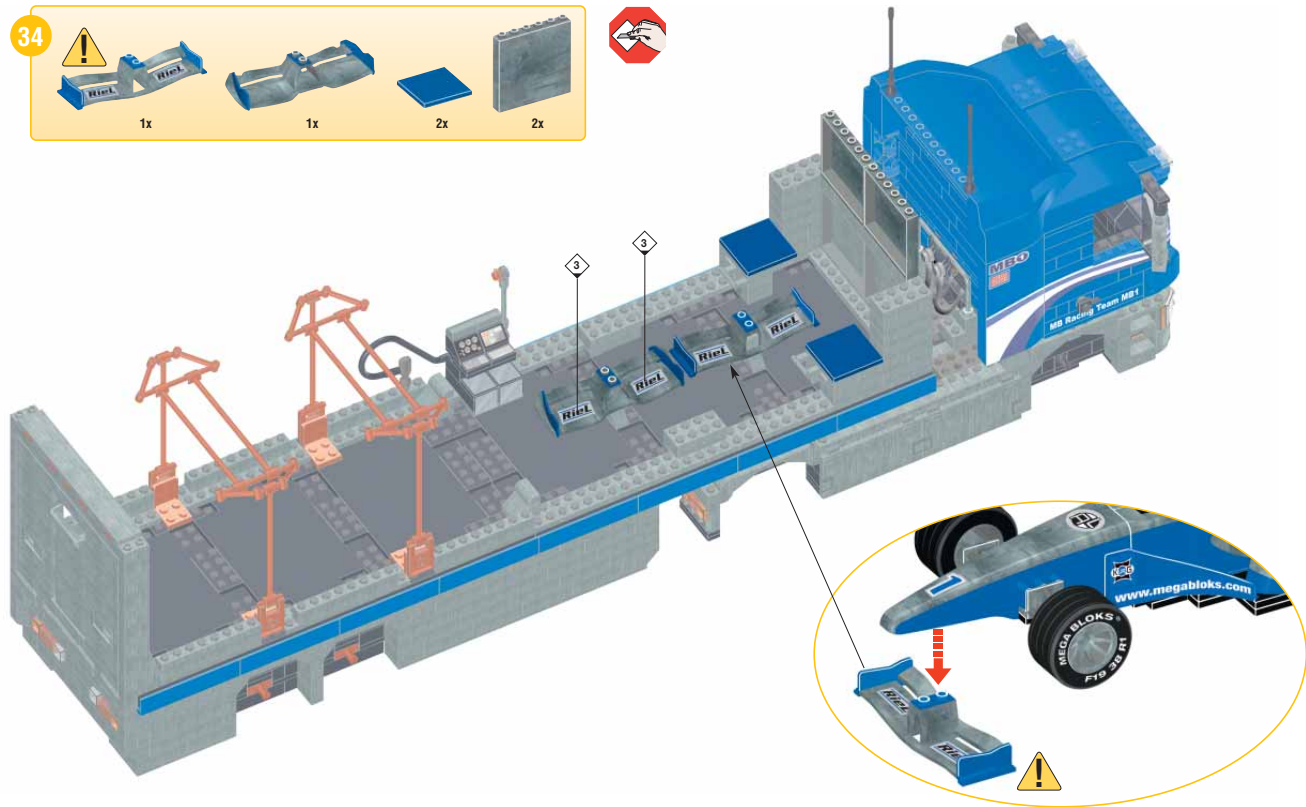

35



1x

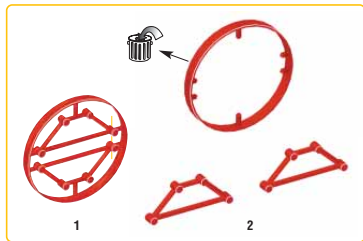

1

2

36



5x

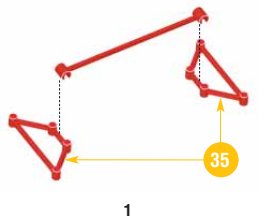

1



2



3



4



5



6

37



10x

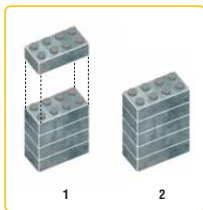

1

2

2x

36

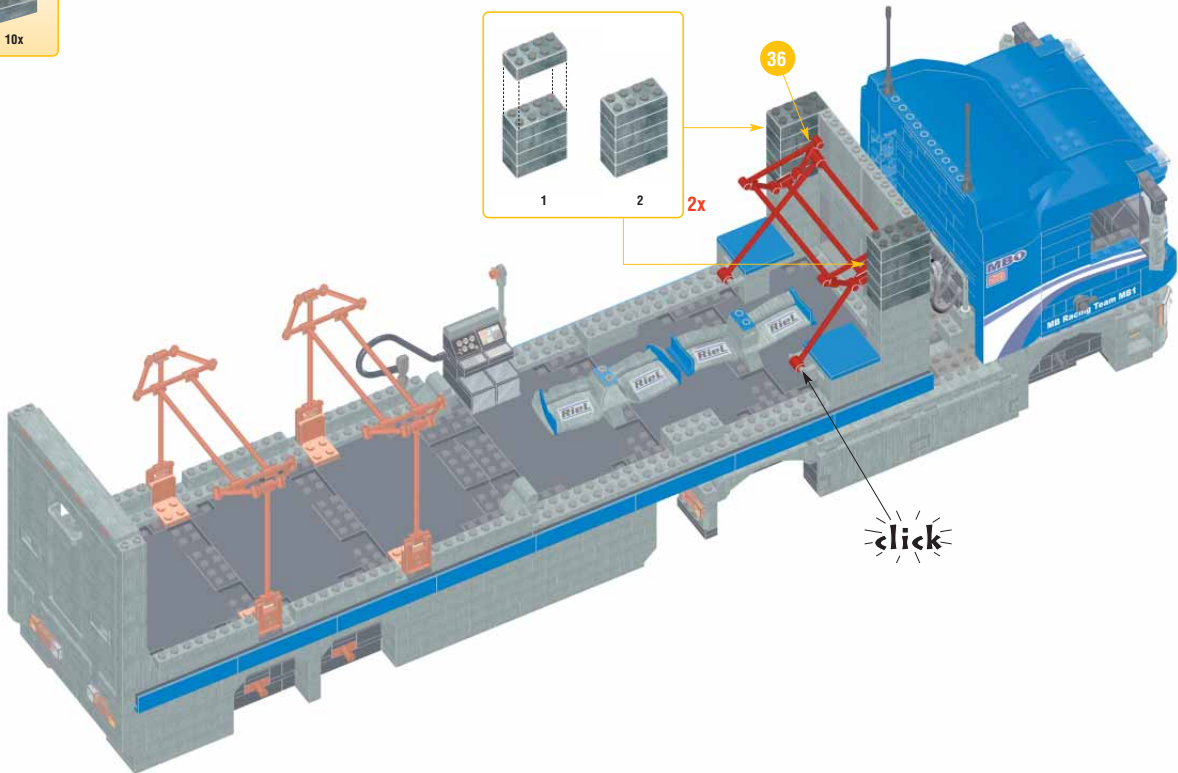

click

38

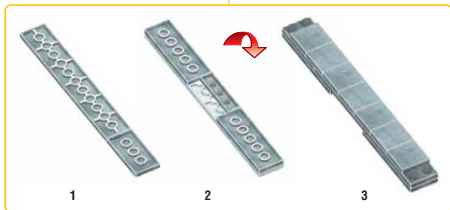
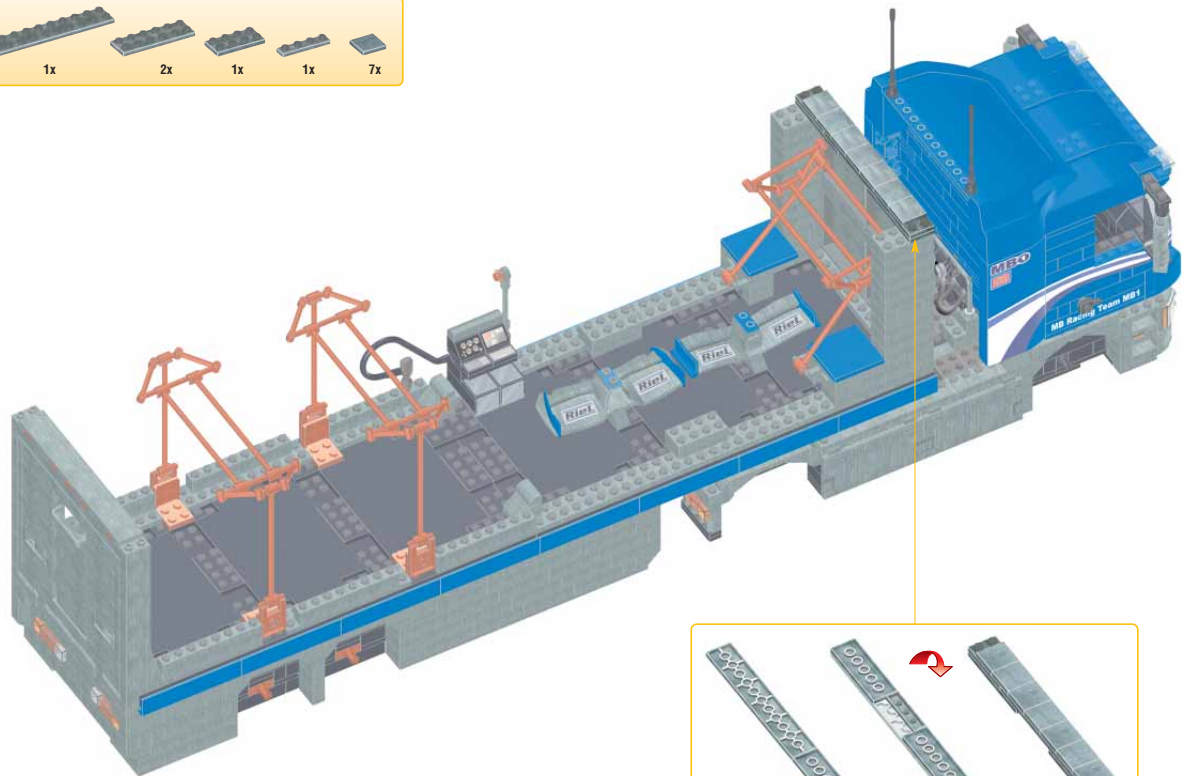
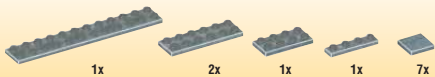

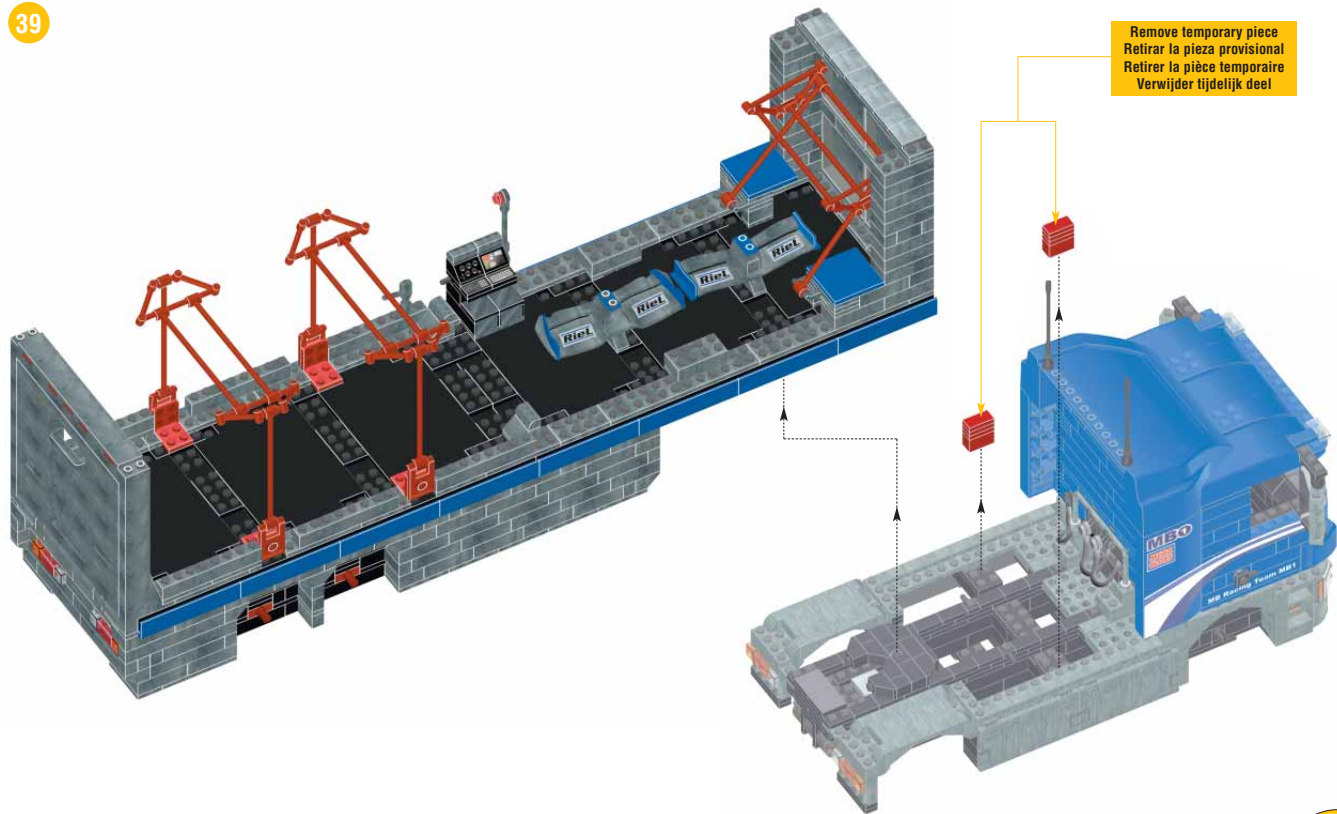

40

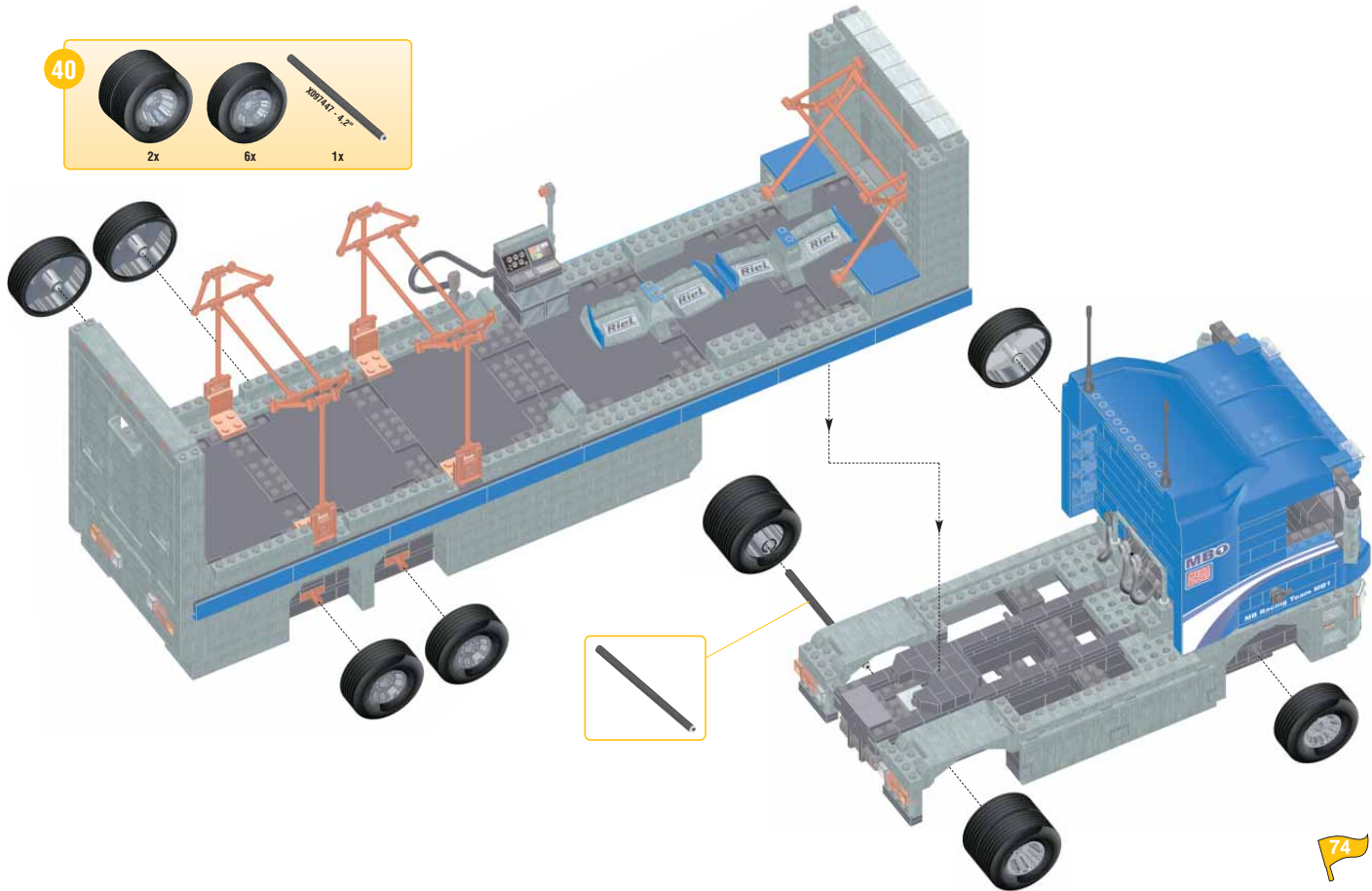

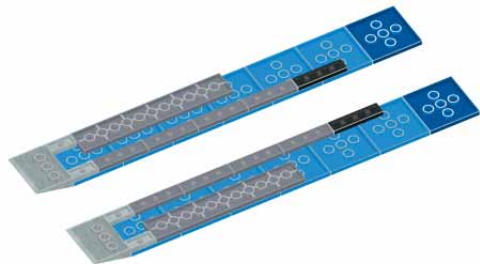
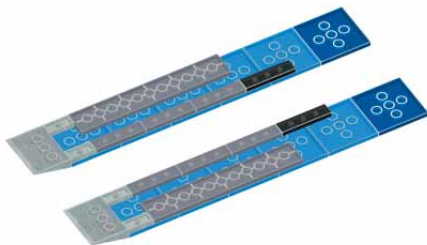
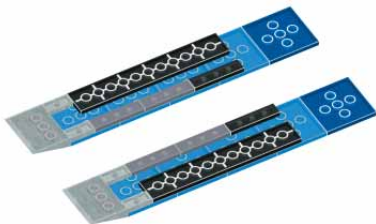
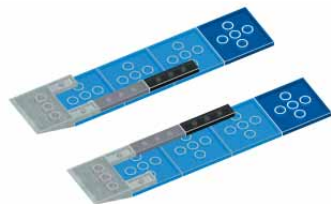
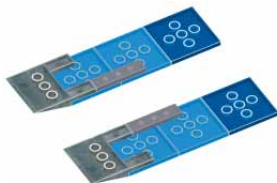
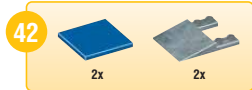
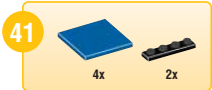

47



48

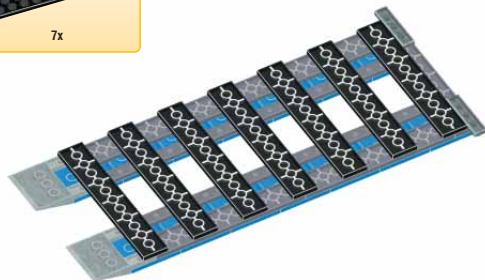

49

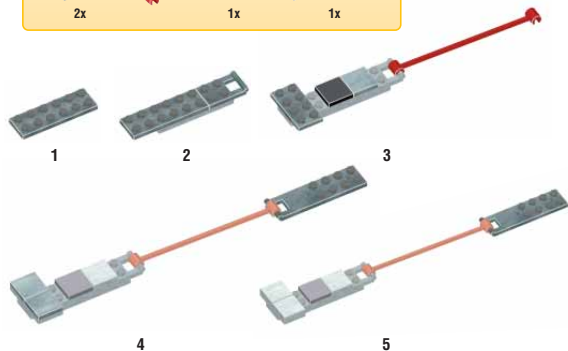
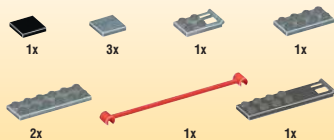

50

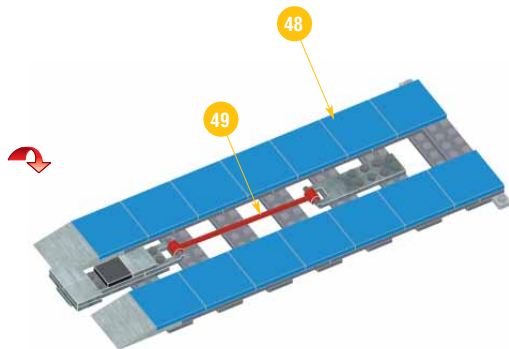

51



1x



1x



1x



1x



1x



1x



50

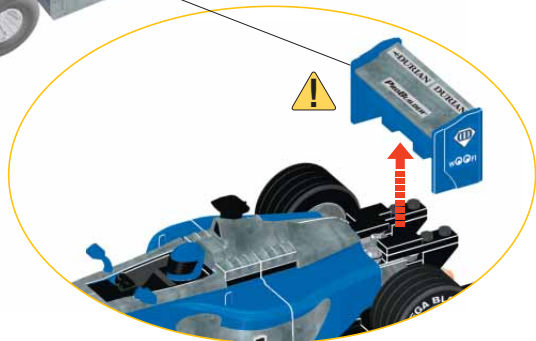
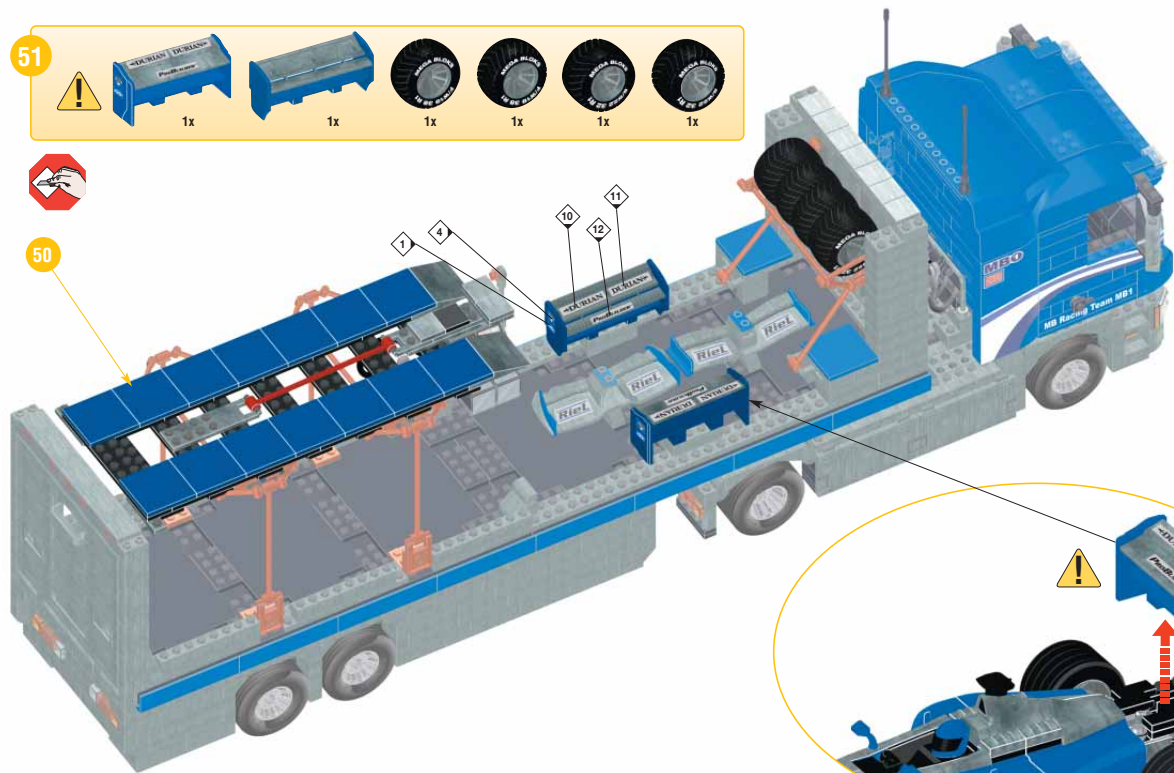

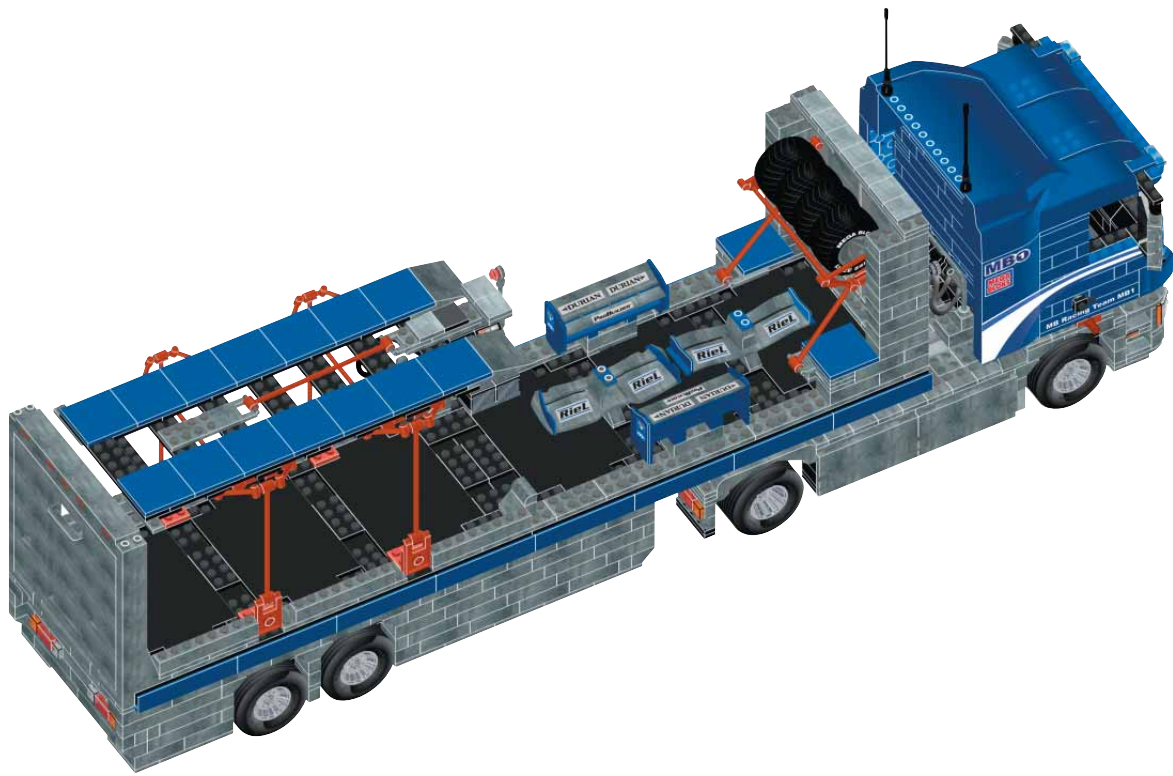

PROBUILDER RACING RIG



Removable top
Capota removable
Toit amovible
Verwijderbare bovenkant

