

**MEGA  
CONSTRUX™**

 **American Girl®**



**Mia's  
Skating  
Rink**

**FDY88**

# LET'S GET STARTED

IT'S TIME TO BUILD YOUR STORY

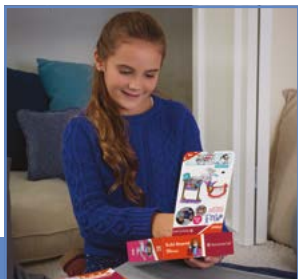

P.3

MEET MIA



P.4

START BUILDING



P.7

MIA'S ACTIVITIES



P.24

# IT'S TIME TO BUILD YOUR STORY

The journey begins when you open the box. Find everything you need to build your story, and get ready to start building!

Take all the bags of pieces out of the box—you're almost ready to start building. Make sure you have your instructions handy!

Let's get organized! Take all the pieces out of the bags and lay them out where you can see them. Be careful not to lose any.

Pull the tab to take your American Girl mini figure out of the window.





## Meet Mia!



Girl of the Year® Mia St. Clair is passionate about figure skating. Gliding along the ice at the arena, she knows this is where she belongs. Even if mastering new jumps *does* mean she has to fall and get back up, again and again.

### **She's a girl with guts and grace.**

Mia is also a solid hockey player. She grew up playing with her three older brothers on the pond behind their house. Her brothers don't always understand her love for figure skating, but they're happy she's ready to take to the ice with them for a family hockey game today.

Mia's ready to play. "Come on you guys," says Mia.  
"You may be bigger, but I'm quicker!"

**Mia's not afraid to try, and try again.**

Whether she's figure skating or playing hockey, Mia knows that picking herself up after she falls is a sure way to improve. "No guts, no glory." says Mia. "That's our family motto!"



# YOUR BUILDABLE FIGURE



## DID YOU KNOW THAT YOU CAN PERSONALIZE YOUR AMERICAN GIRL MINI FIGURES?

Collect them all, then mix and match pieces from each to customize them. Use the different parts and accessories to change their look and style. You can even create totally new characters that look like you and your friends!



Each sold separately and subject to availability.



# START BUILDING

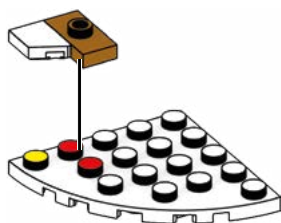
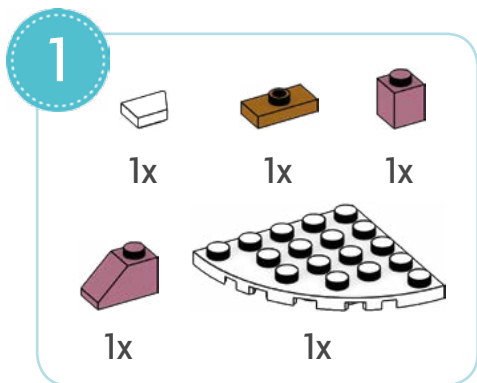

1

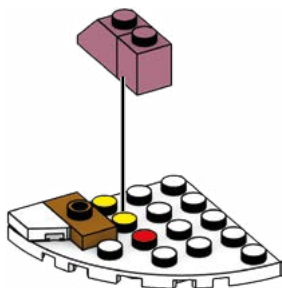

2



3



2



1x



1x



1x



1x



1x

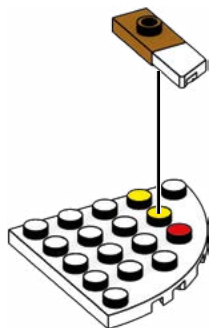

1

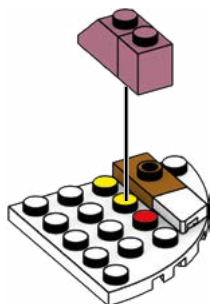

2

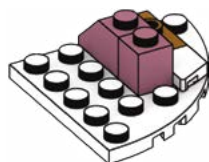

3

3

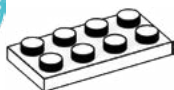

1x

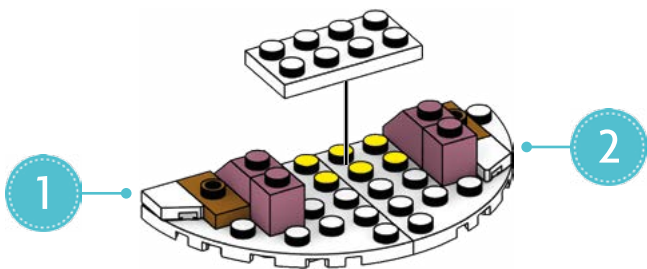





4



2x

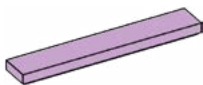

2x

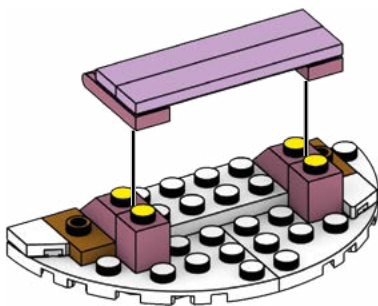
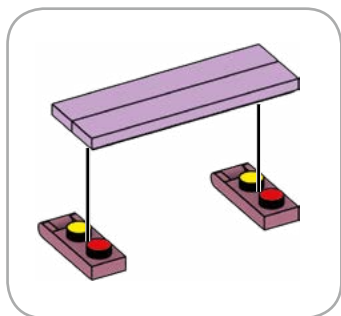



5



2x

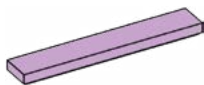

2x

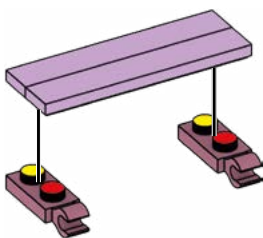

1

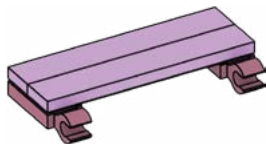

2

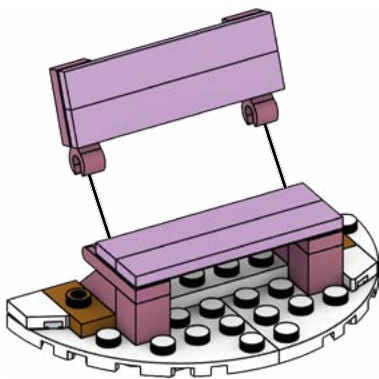



6



2x



1x

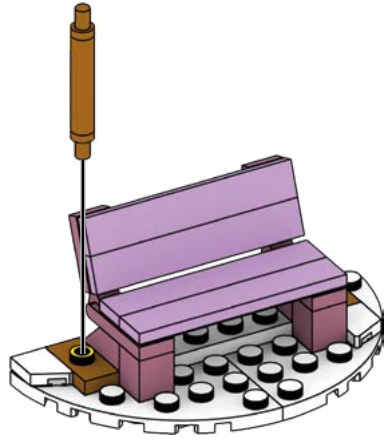
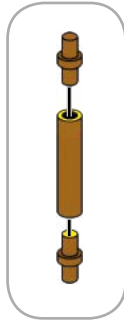

7



1x



1x



1x

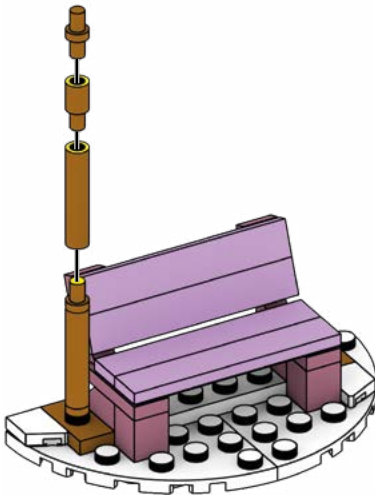

1

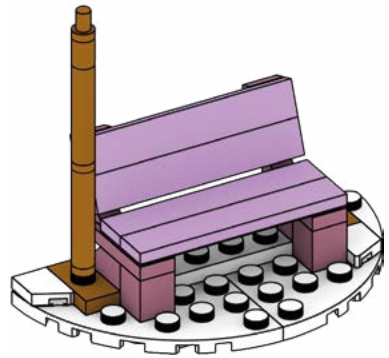

2



8



2x



1x

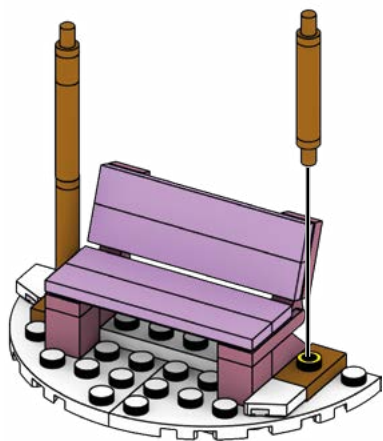
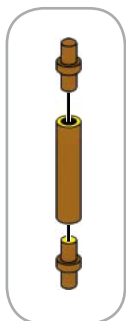

9



1x



1x



1x

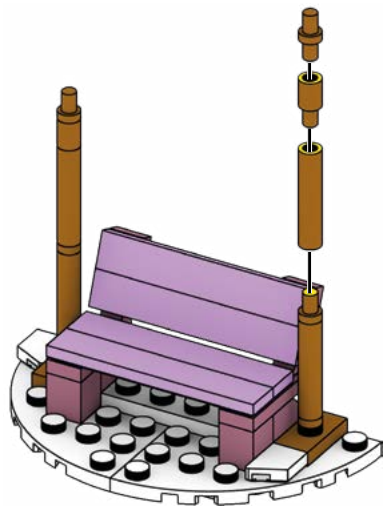



10



4x



2x

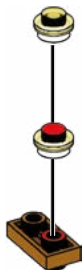

1



2

x2

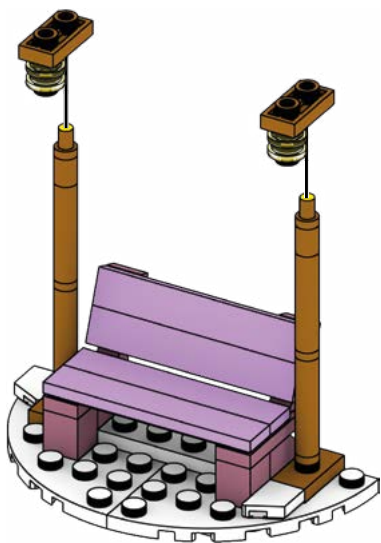

1

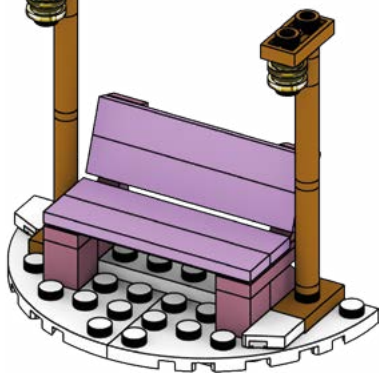

2



11

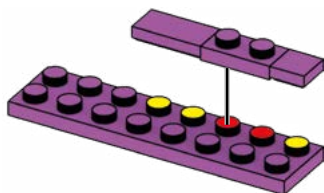
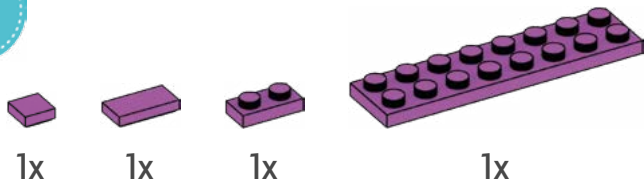

12

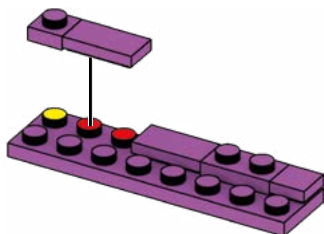
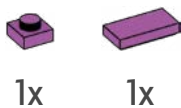



13



4x

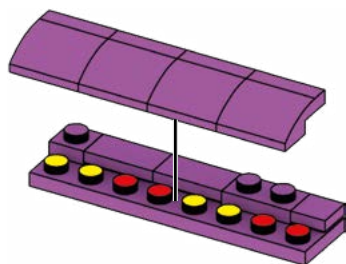

14



1x



2x

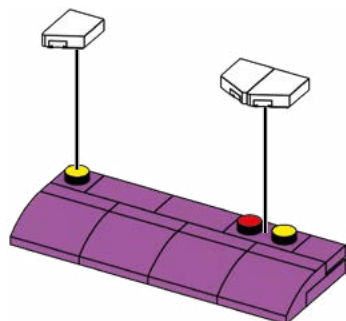



15

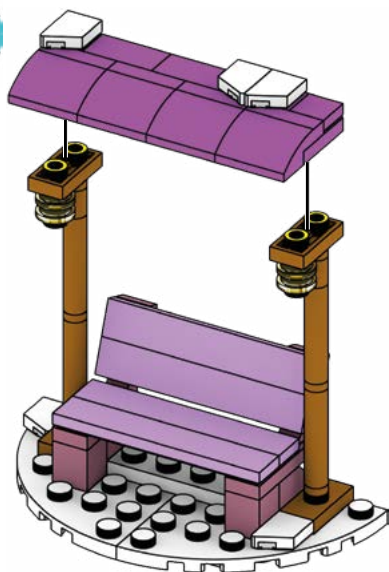

1

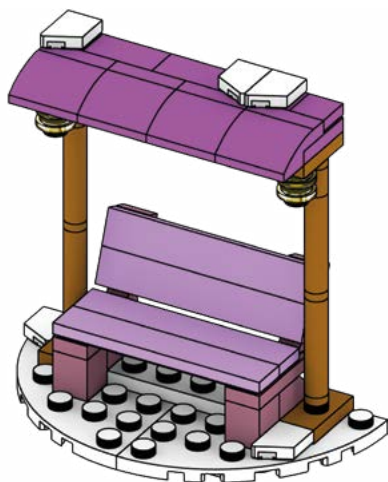

2



## BUILDING TIP

When attaching the bench roof, make sure to fasten it securely with two hands, pushing down firmly to connect it to the two posts. Nice job. Now Mia can take a break on this cozy seat!







Build the net!



16



1x



2x

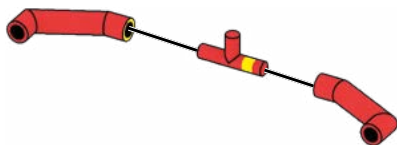

17



2x



2x

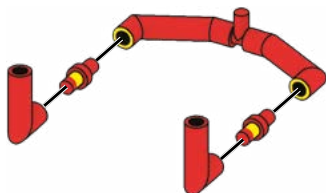



18



2x

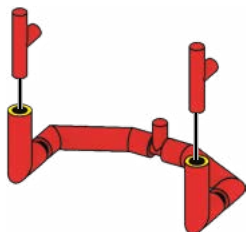

1

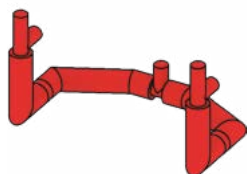

2

19



1x



2x

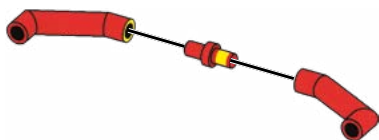

1



2



20

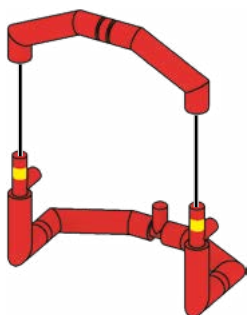

1

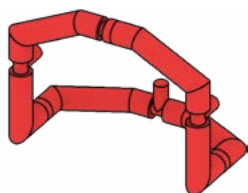

2



## BUILDING TIP

To build the hockey net, connect the post pieces together one at a time. Match the pieces up and insert the connector rods to connect them together. Way to hustle!





21



1x

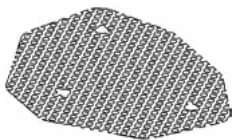

1x

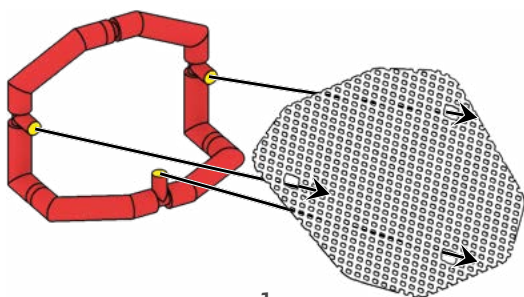

1

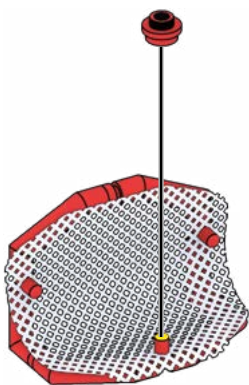

2



22



2x

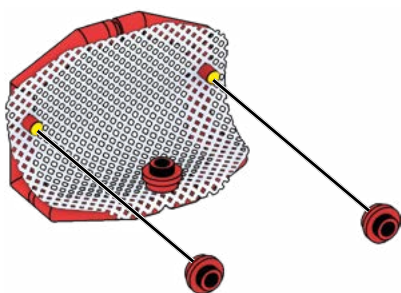

1



2



## BUILDING TIP

Add the mesh to the net by lining up its three holes with the three pegs on the back of the net. Hold the mesh in place over one of the pegs, and place a cap over the peg to secure the mesh. Repeat for the other two pegs. She shoots. She scores!

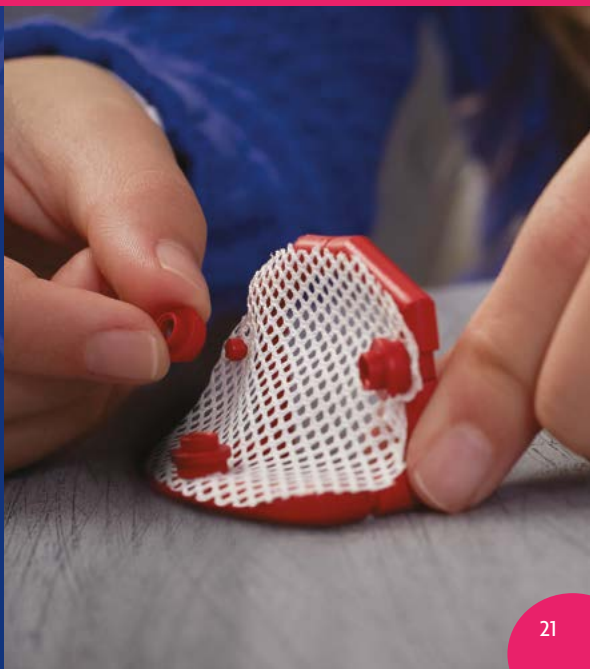



23



1x



1x



1x



1x



1x



1x



1x

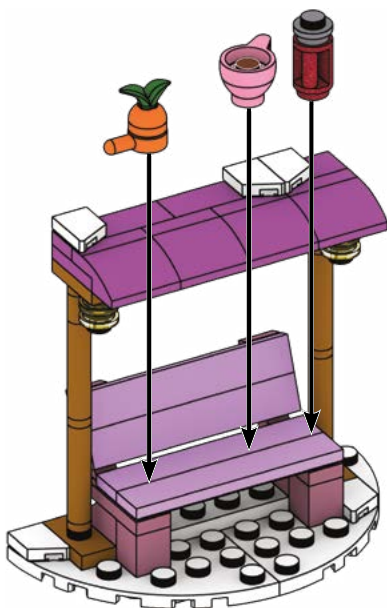
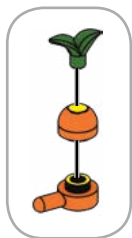



# GREAT JOB!

You've built Mia's Skating Rink!



## CREATE YOUR STORY

You can create even more American Girl stories online.

Build your own stories and discover what other girls have created. Because together, we build beyond!





# MIA'S ACTIVITIES



ANSWER: 5





Color it in



1x  
AM75332F



1x  
AM01113AGV



1x  
AM01113DH



4x  
AM01113ZD



3x  
AM18560EA



1x  
AM01312BOR



1x  
AM78803ARD



1x  
AM78802BOR



2x  
AM74397MY



3x  
AM17003EA



6x  
AM17003MY



1x  
AM03328AEN



1x  
AM07223AEN



3x  
AM74299E



2x  
AM74300E



1x  
AM19611EE



1x  
AM76776AKM



2x  
AM01086AWF



2x  
AM07590MY



2x  
AM16680MY



2x  
AM022501AEN



1x  
AM09393AEN



2x  
AM16975AWF



2x  
AM16954AWF



2x  
AM01322AWF



2x  
AM74645EA



3x  
AM18287EA



4x  
AM72233MY



4x  
AM74657EA



2x  
AM78787AGV



1x  
AM78786I



1x  
AM77703CV



1x  
AM78804ASU



1x  
FIG-FDY88-A

1x  
AM77307I



1x  
AM76570ASU



4x  
AM74106AEN



4x  
AM16331NL



1x  
AM08483AEN



2x  
AM09622E



1x  
AX-FDY88-01



1x  
AS-DPK83-06



1x  
AM09493E



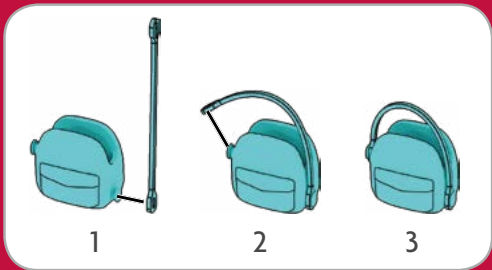

⚠ WARNING :  
 CHOKING HAZARD. - Small parts.  
 Toy contains a small ball.  
 Not for children under 3 years.



Please read these instructions carefully before first use and keep them for future reference.

© 2016 American Girl. All rights reserved. All American Girl marks are trademarks of American Girl.



Collect them all!

ⓅD714, 887



Each sold separately and subject to availability.

# MEGA CONSTRUX™

Build Beyond™

Au-delà de la  
construction!

¡Construye sin límites!

Mais do que Construção!

Costruisci oltre ogni limite!

Es gibt keine Grenzen!

Więcej niż budowanie!

Meer dan alleen bouwen!

Больше, чем конструктор!

Χτίσε έναν ολόκληρο κόσμο!

Hayallerini İnşa Et!

لنبني .. وأكثر!

©2016, MEGA Brands Inc. &™ MEGA Brands Inc.  
CONSTRUX™ is owned by Mattel and used under license.  
Printed in China AD-FDY88-DOM02



[play.megaconstrux.com](http://play.megaconstrux.com)

