



MINECRAFT

21246





Get excited about our new packaging!

We're switching from plastic to paper-based packaging. That's why you might find a mix of paper and plastic in our boxes!

Nos nouveaux emballages vous emballeront !

Nous passons des emballages en plastique aux emballages à base de papier. C'est pourquoi vous pourriez trouver un mélange de papier et de plastique dans nos boîtes !

¡Te presentamos nuestros nuevos empaques!

Estamos sustituyendo las bolsas de plástico por bolsas con base de papel. ¡Por eso, puedes encontrar una mezcla de papel y de plástico en nuestras cajas!

[LEGO.com/sustainable-packaging](https://www.lego.com/sustainable-packaging)

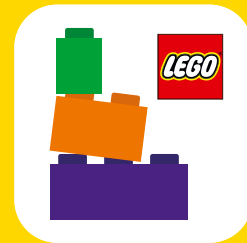

BUILDER



Apple and the Apple logo are trademarks of Apple Inc., registered in the U.S. and other countries and regions. App Store is a service mark of Apple Inc. Google Play and the Google Play logo are trademarks of Google LLC. Tencent and the Tencent logo are trademarks of Tencent Inc.

Q [LEGO.com/devicecheck](https://www.lego.com/devicecheck)

EN Ask parents' permission before going online | **DE** Eltern um Erlaubnis bitten, bevor du online gehst | **FR** Demande l'autorisation d'un parent avant d'aller en ligne | **IT** Chiedi il permesso ai tuoi genitori prima di andare online | **ES** Pídeles permiso a tus papás antes de conectarte a Internet | **PT** Peça autorização aos pais antes de acederes online | **JA** オンラインになる前に 保護者の方のきょかをもらおう | **ZH** 上网前应先征得父母的同意 | **KO** 온라인 접속 전에 보호자 동의가 필요합니다 | **RU** Спроси разрешения у родителей, прежде чем заходить в интернет | **PL** Poproś rodziców o zgodę, zanim wejdiesz do Internetu | **CS** Než půjdeš na internet, požádej rodiče o svolení | **SK** Skôr než pôjdeš na internet, vypýtaj si povolenie od rodičov | **HU** Kérj szülői engedélyt, mielőtt online csatlakoznál! | **RO** Cere permisiunea părinților înainte de a te conecta online | **BG** Поискайте разрешение от родител, преди да влезете онлайн | **LV** Pirms došanās tiešsaistē palūdz atļauju vecākiem | **ET** Enne Interneti kasutamist küsi vanematelt luba | **LT** Prieš prisijungdami prie interneto, atsilkauskite tėvų

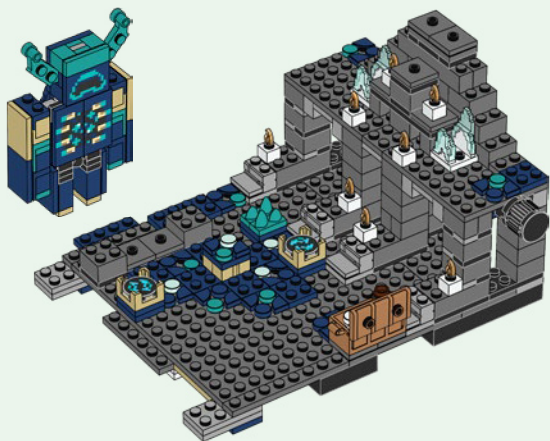
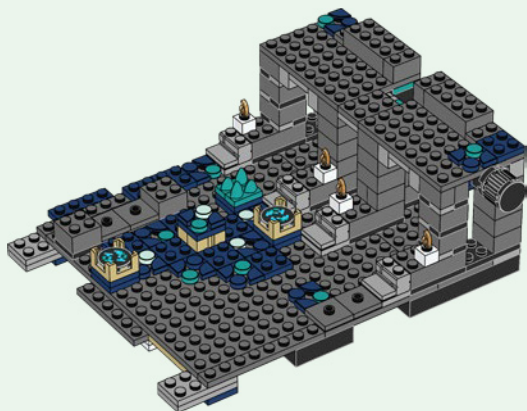
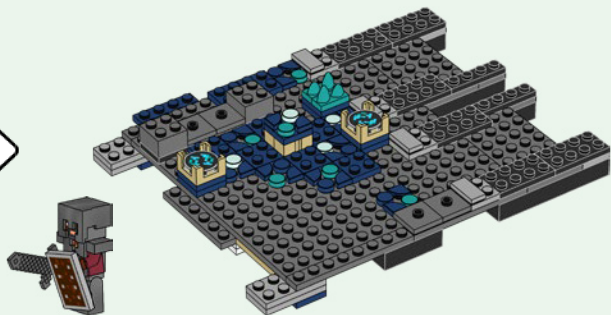

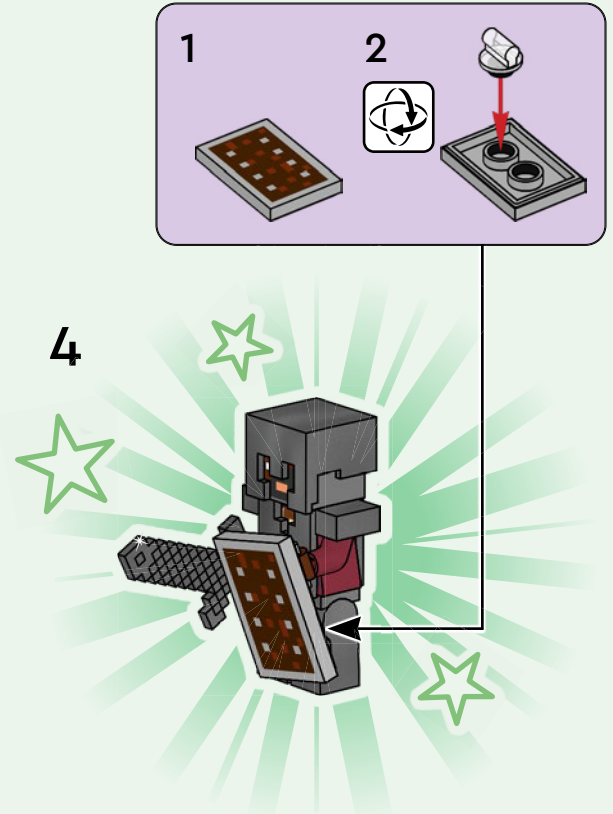
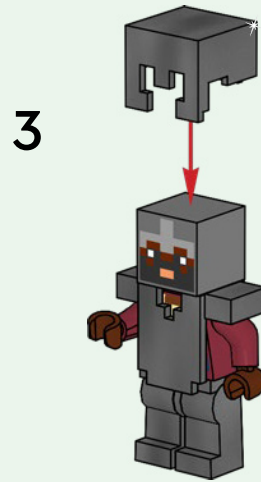
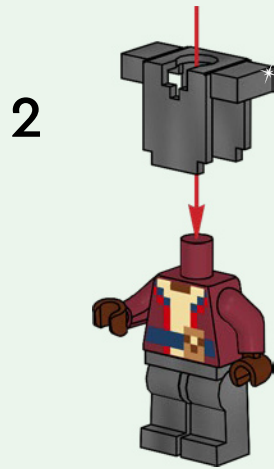
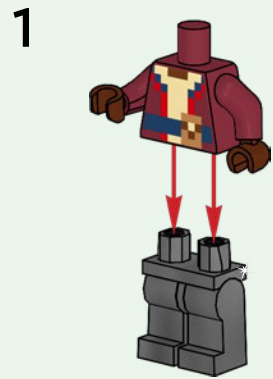
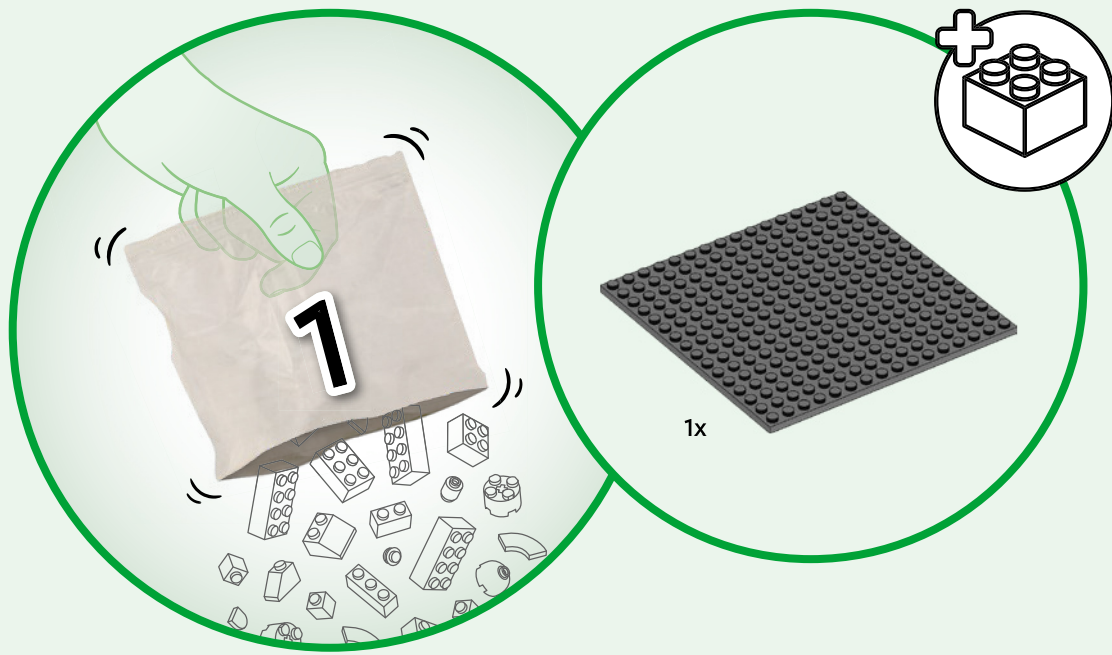

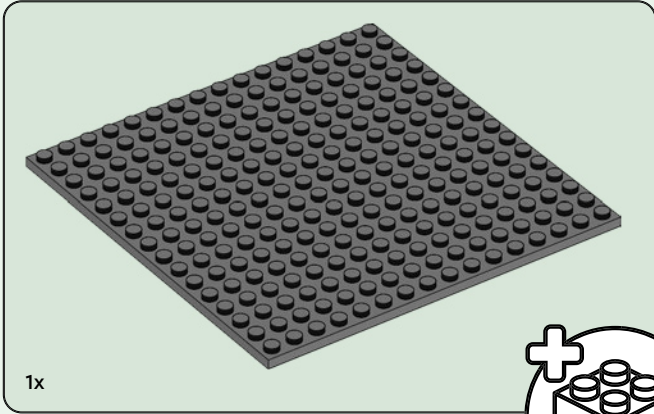
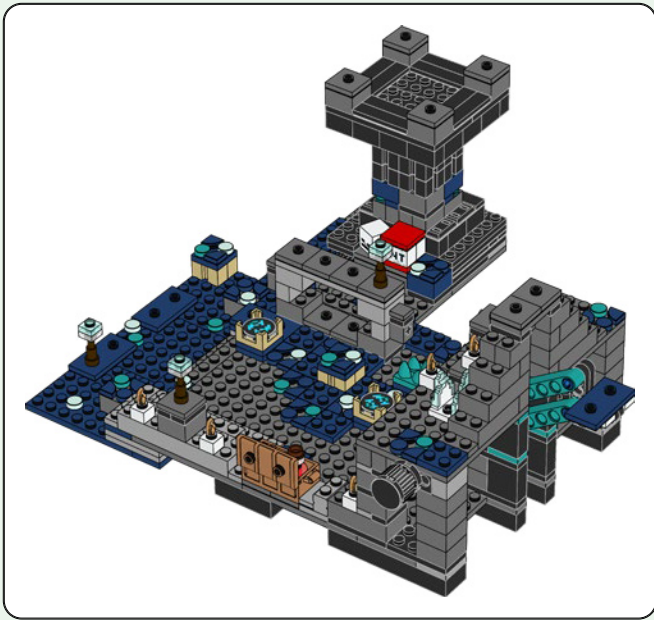

1x

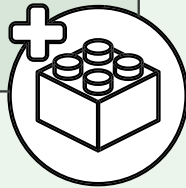

1

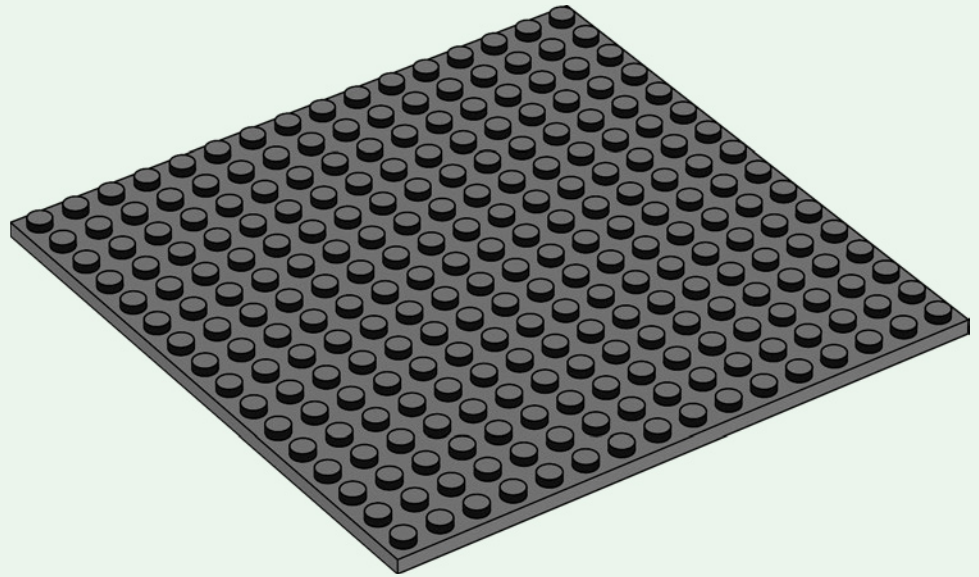

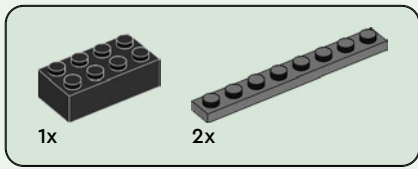

2

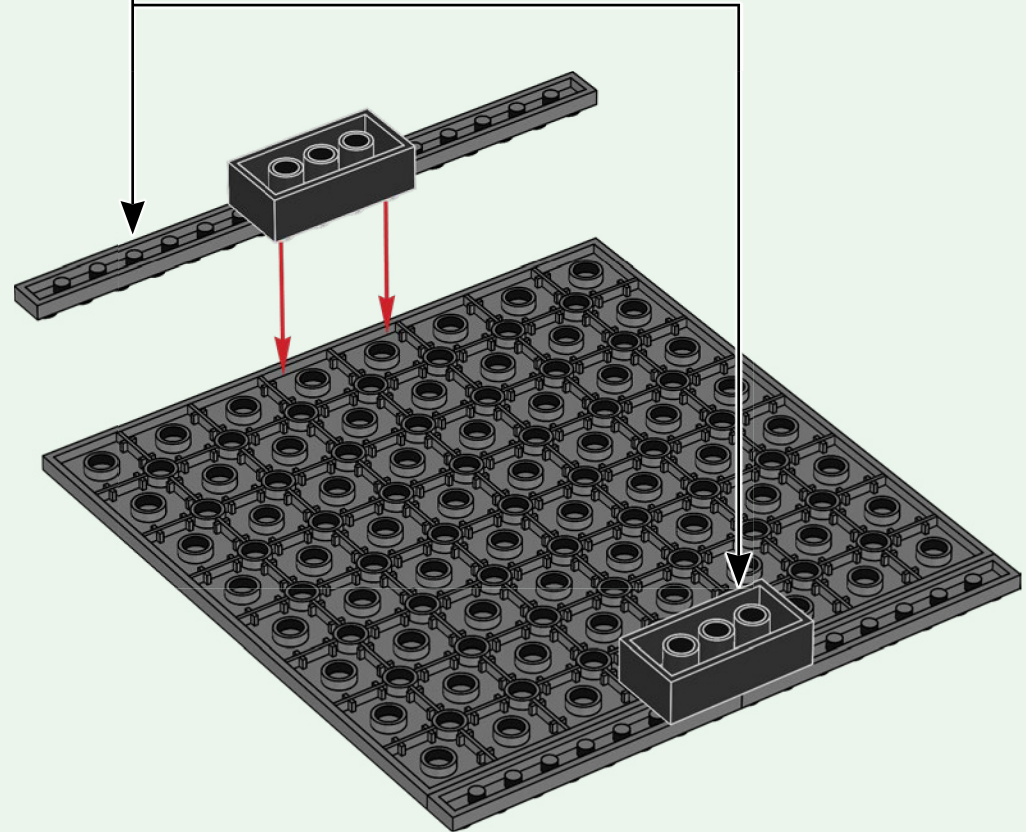
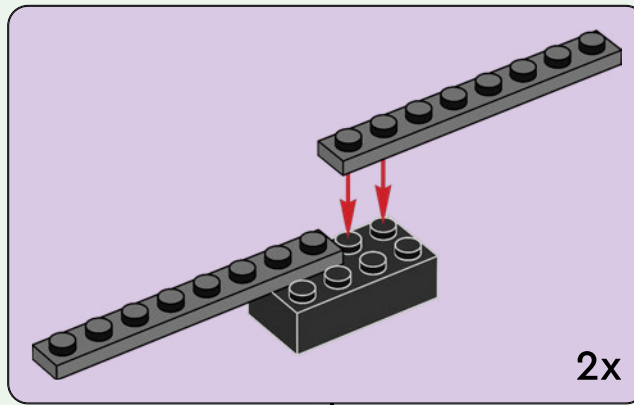



2x

3

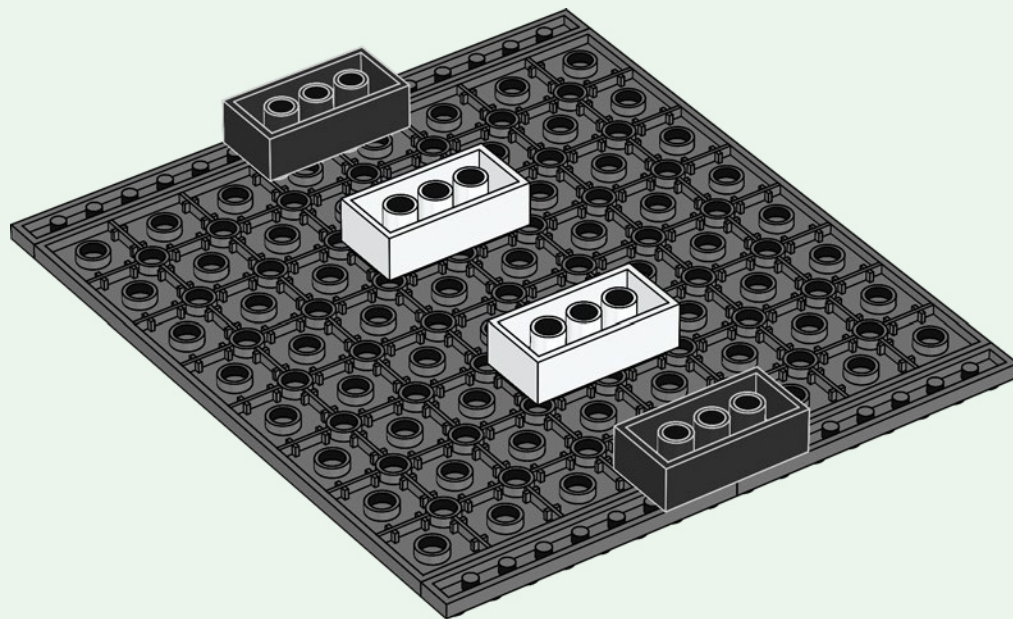

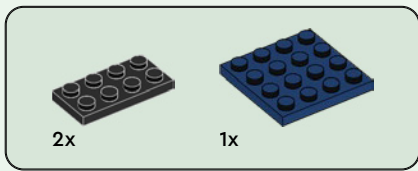

4

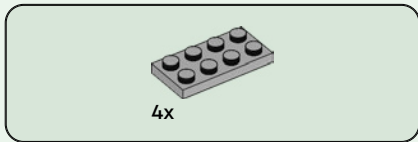
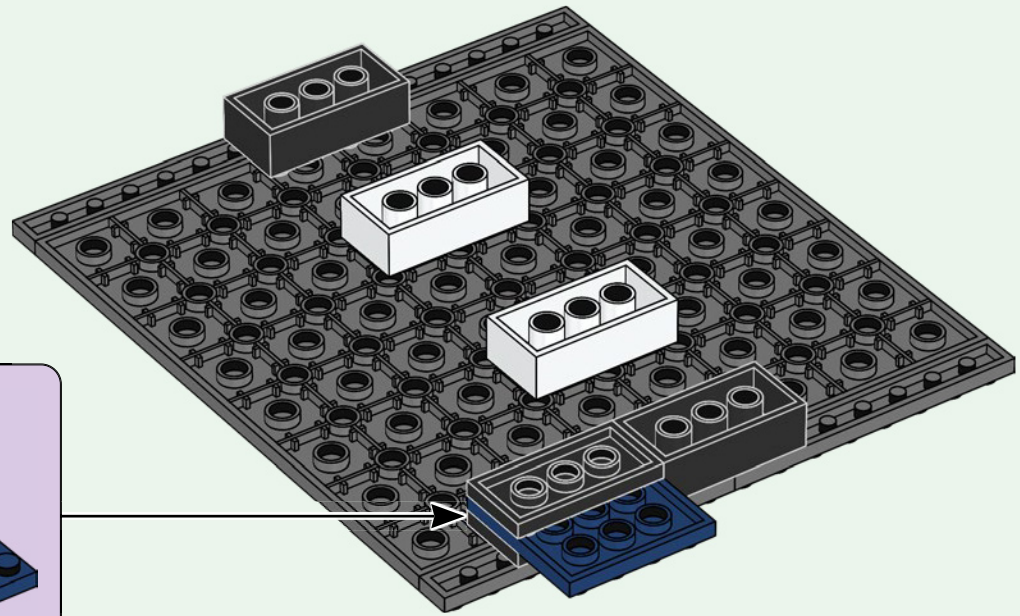
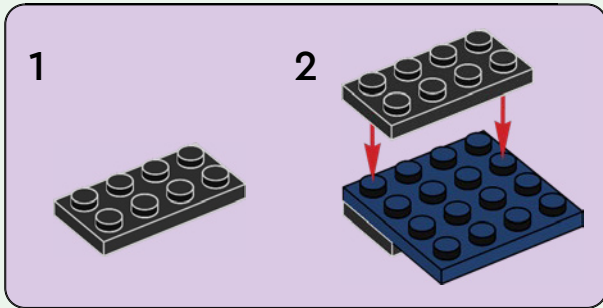

5

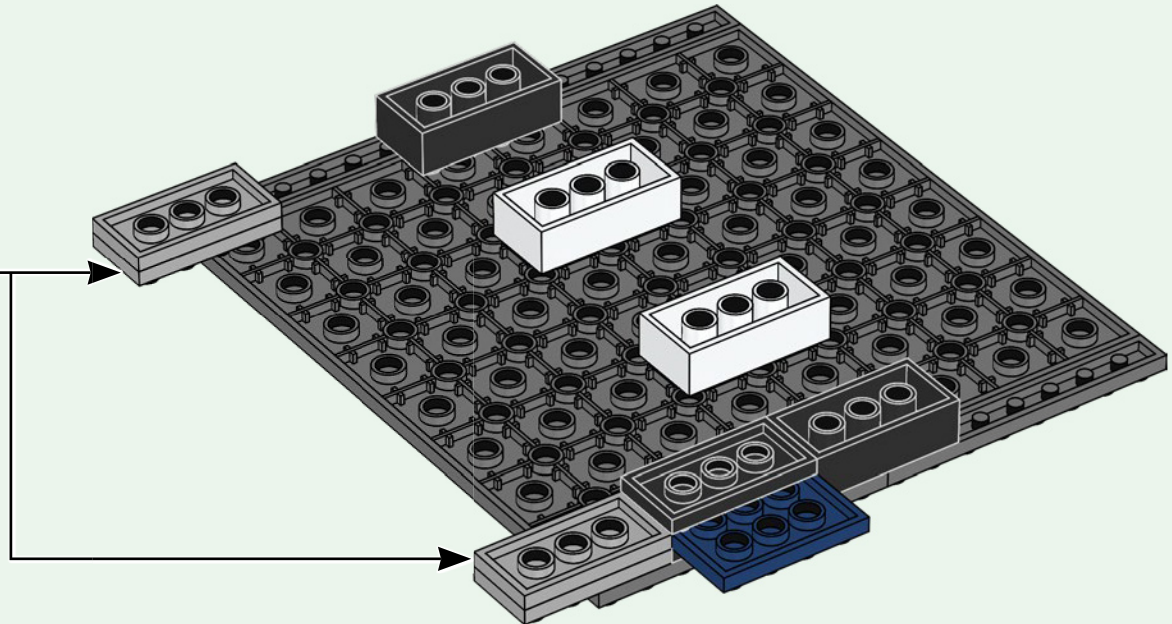
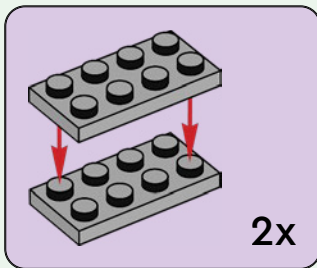

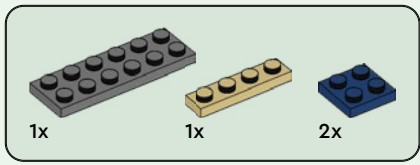

6

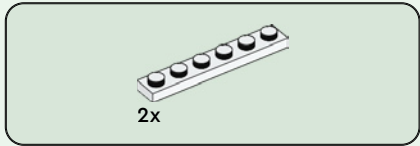
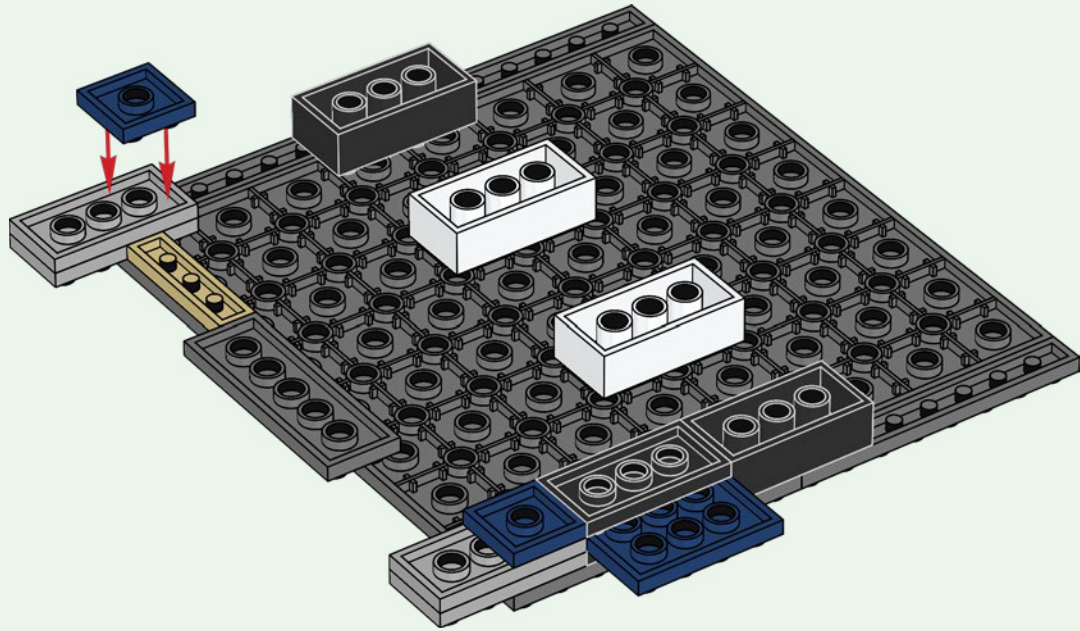

7

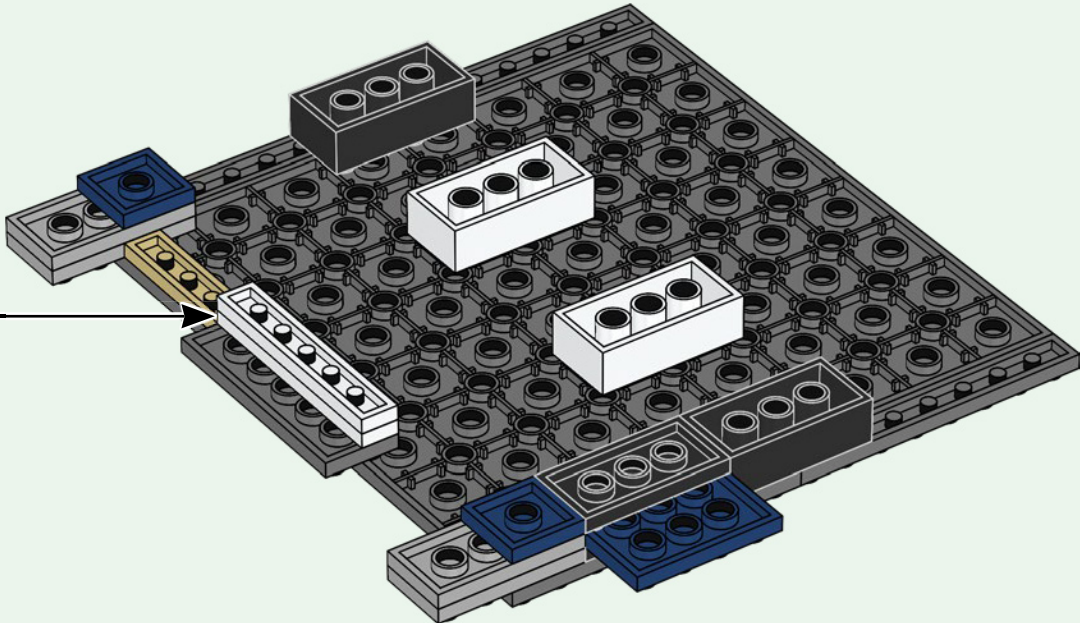
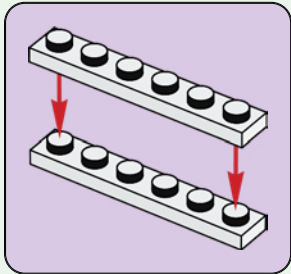

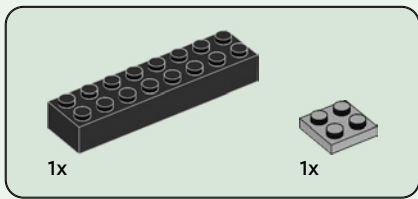

8

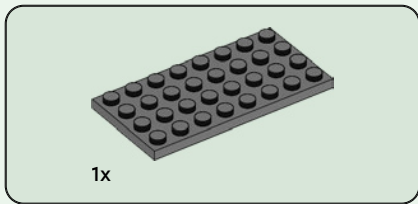
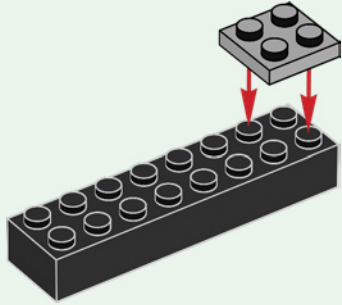

9

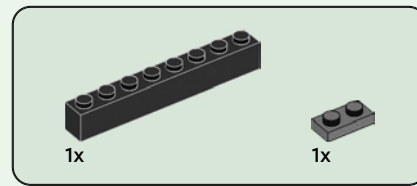
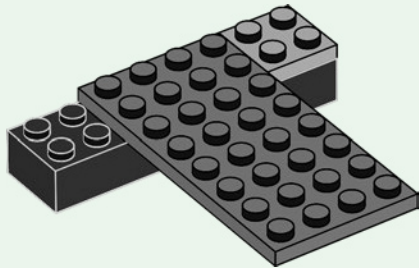

10

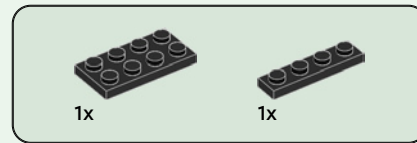
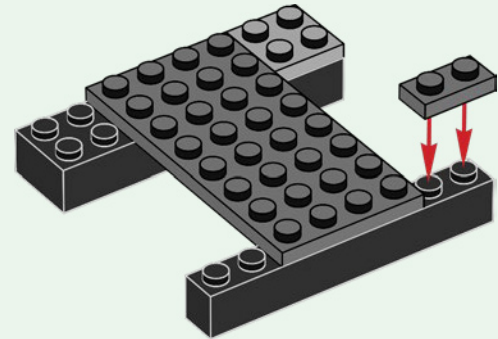

11

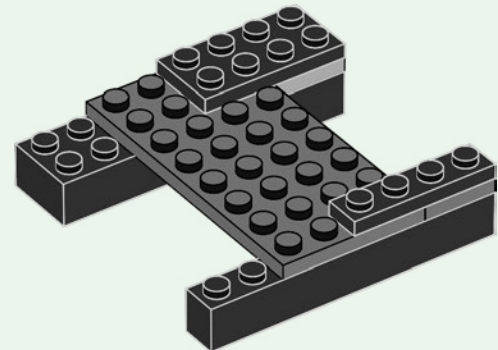

12

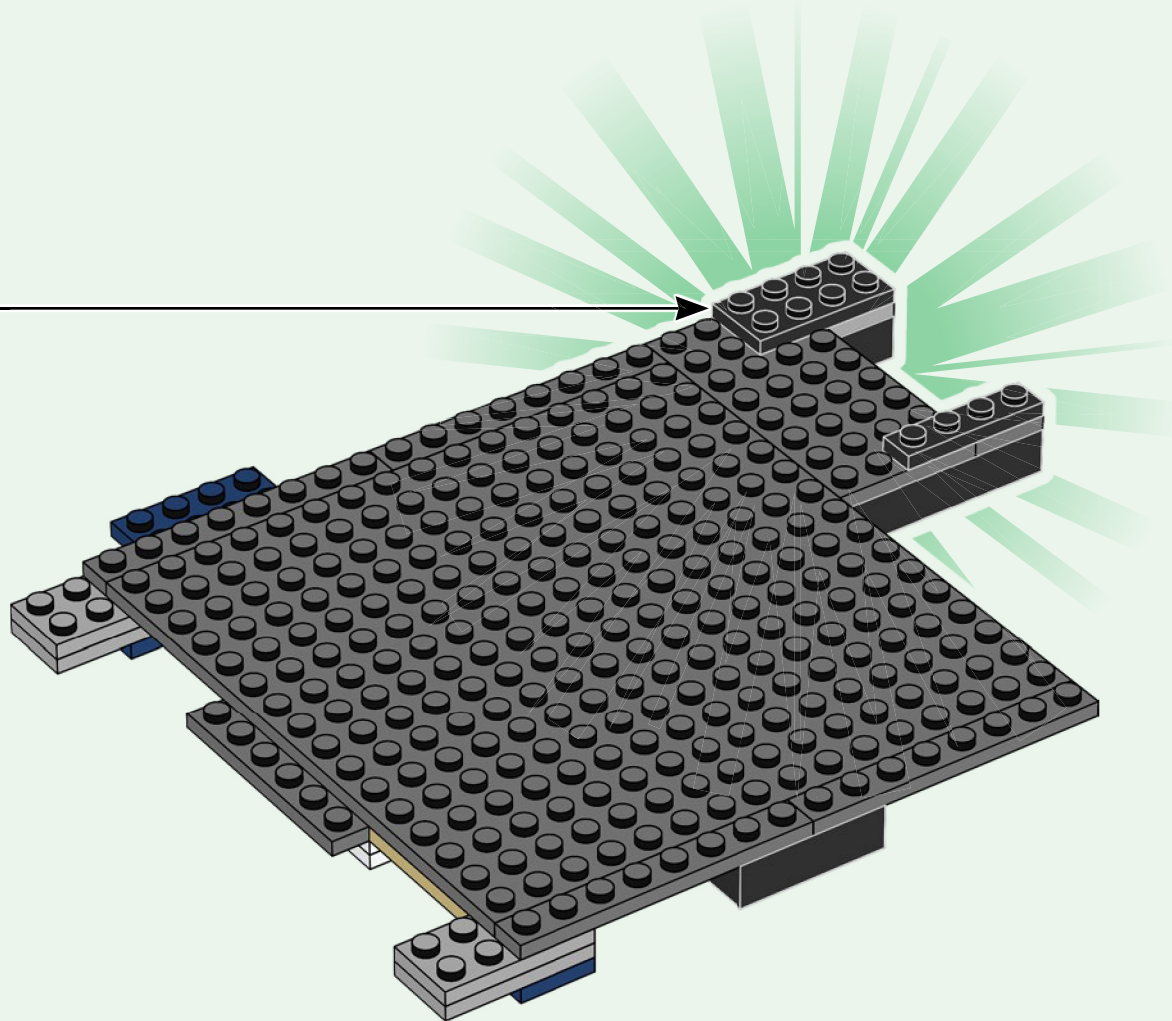

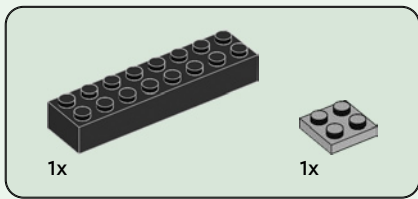

13

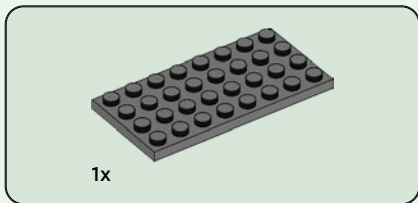
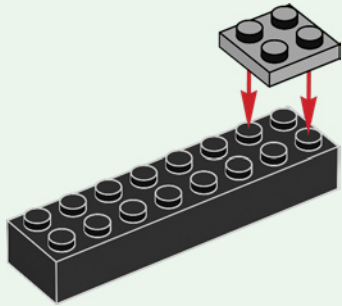

14

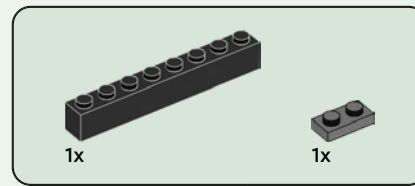
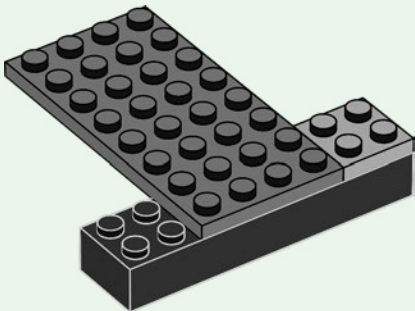

15

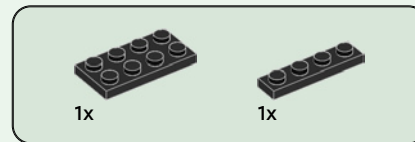
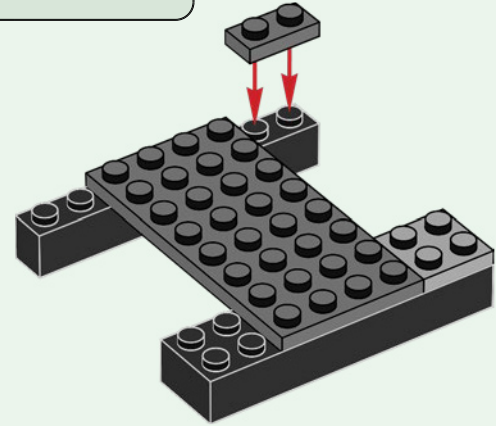

16

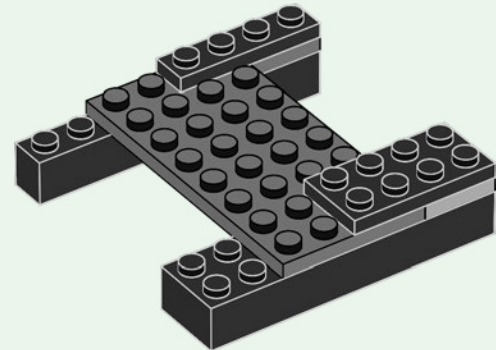

17

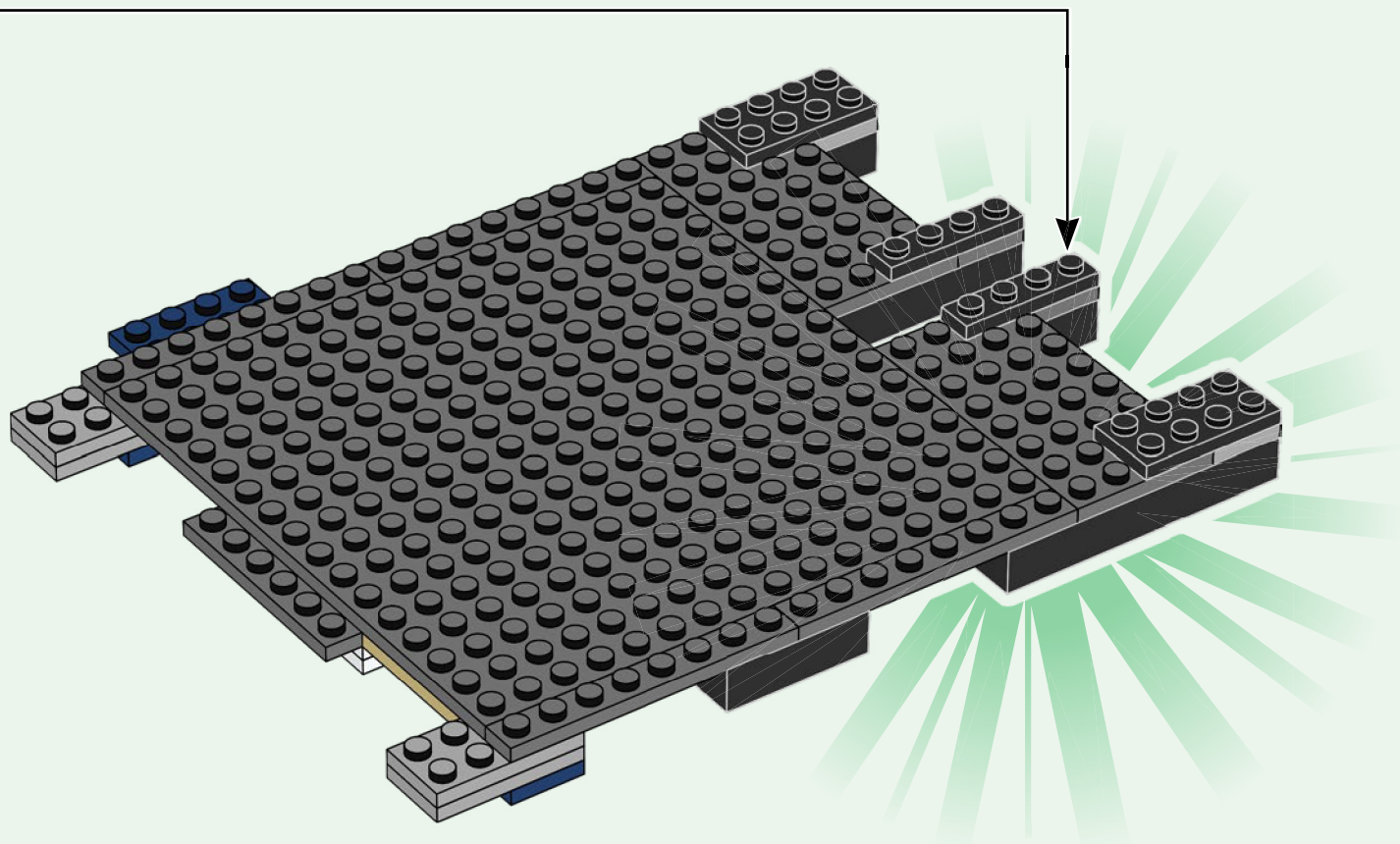

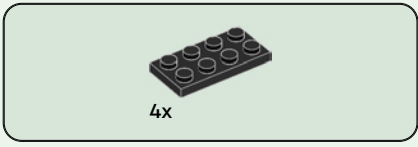

18

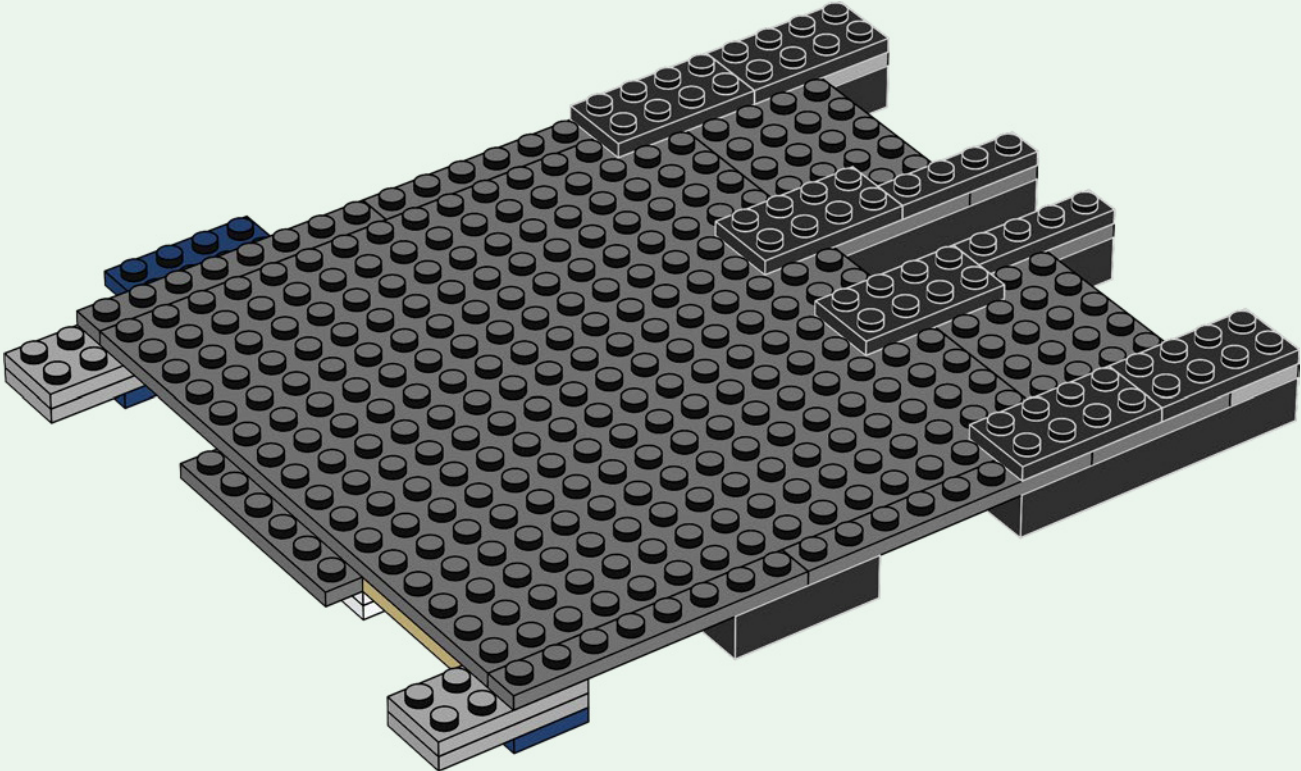

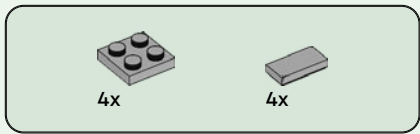

19

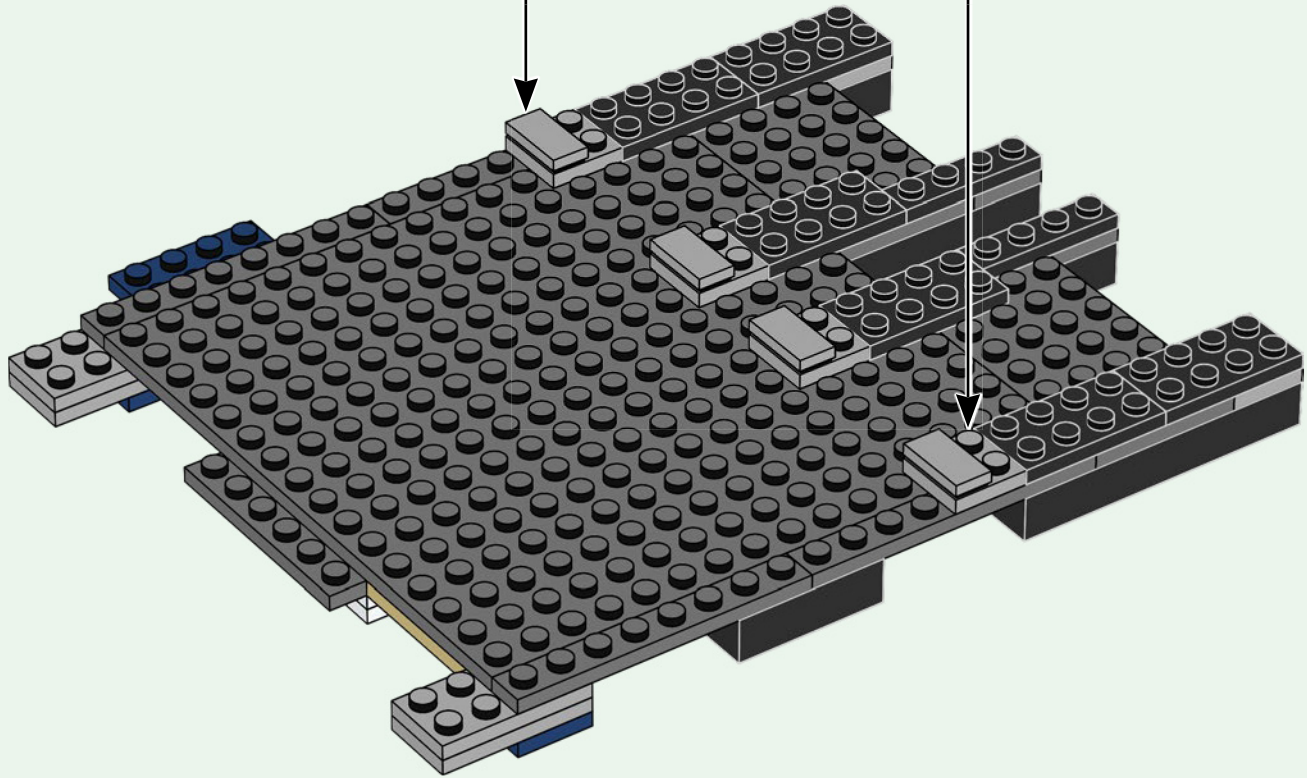
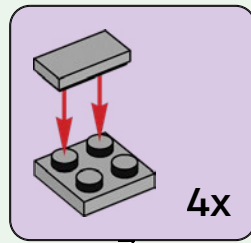

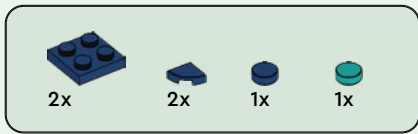

20

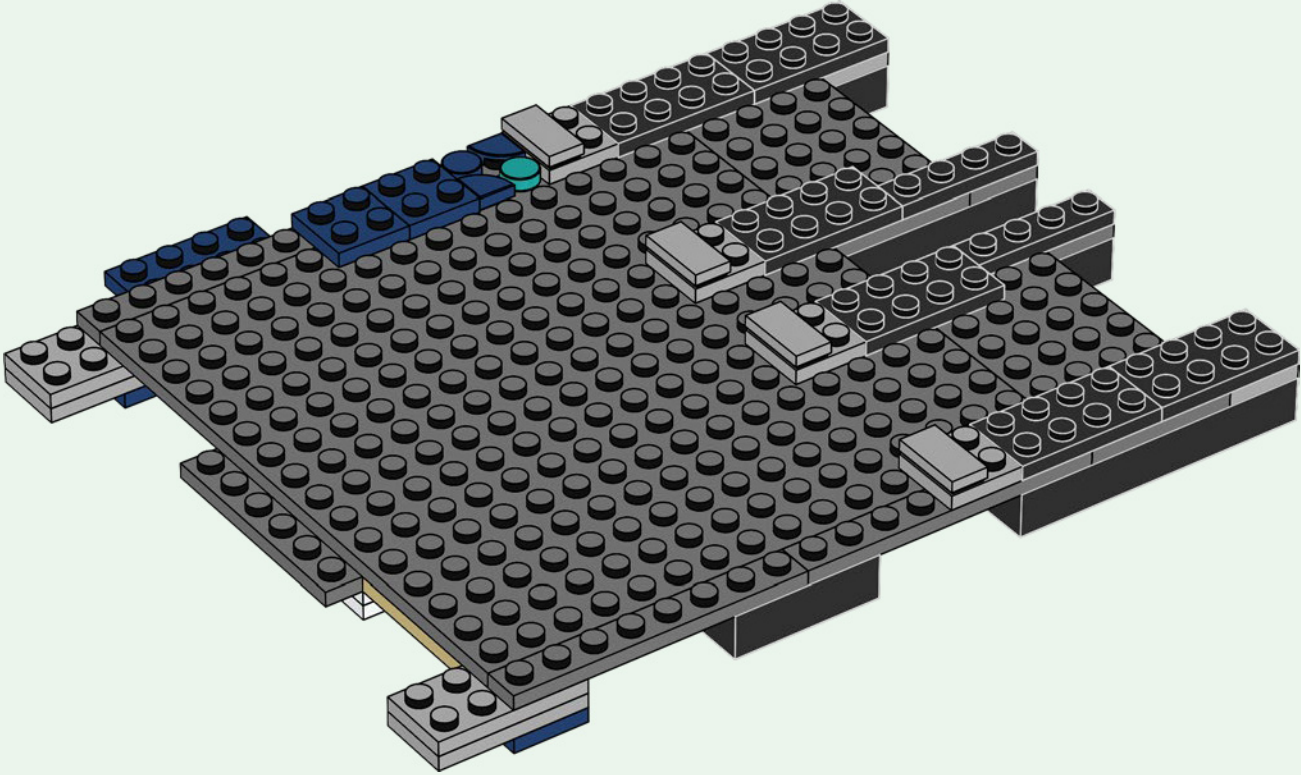



2x

21

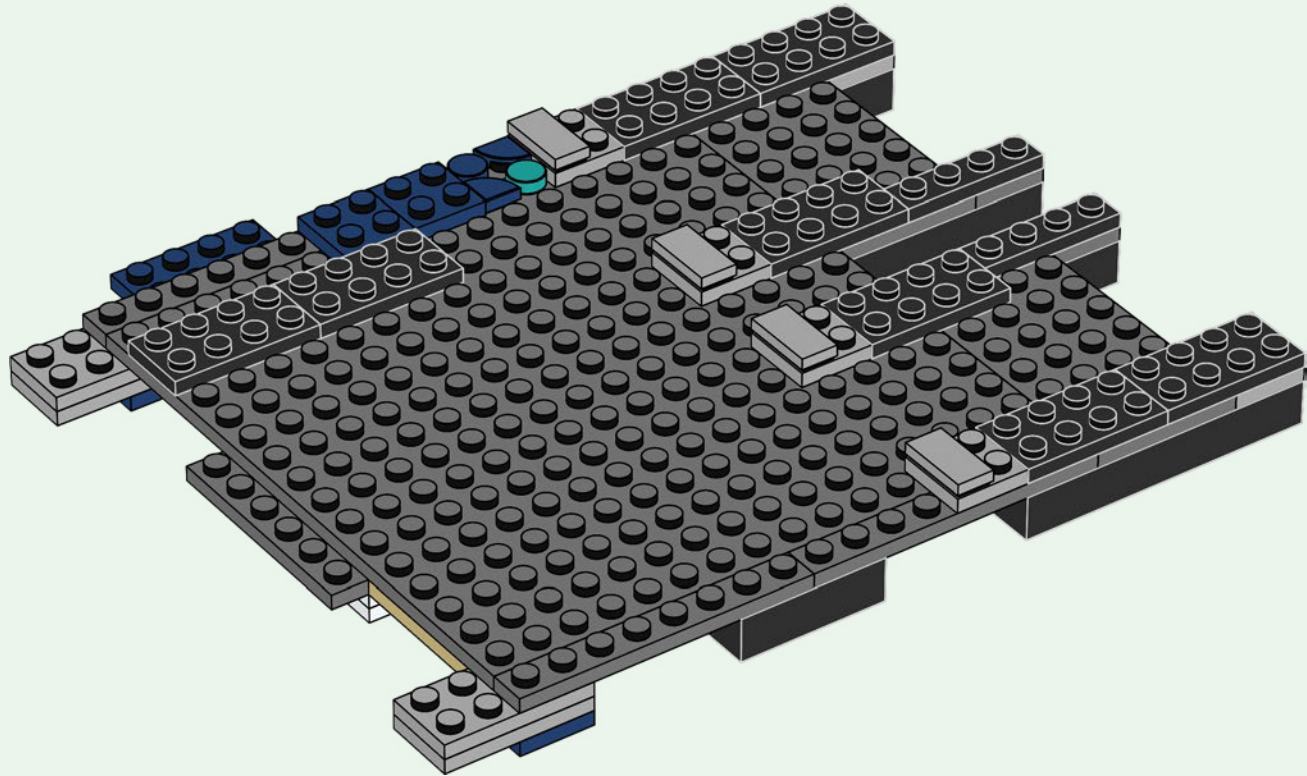

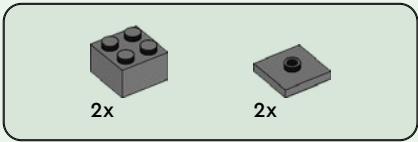

22

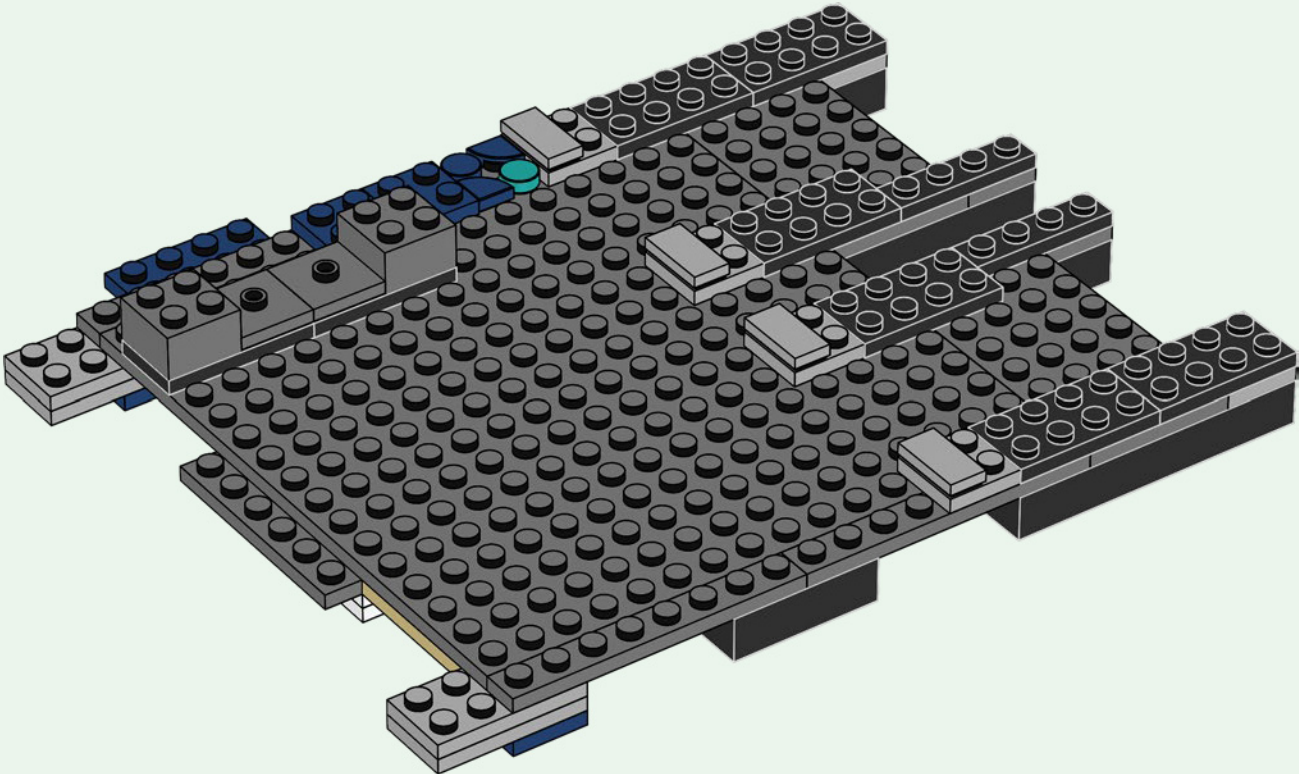

2x 2x 1x 1x

23

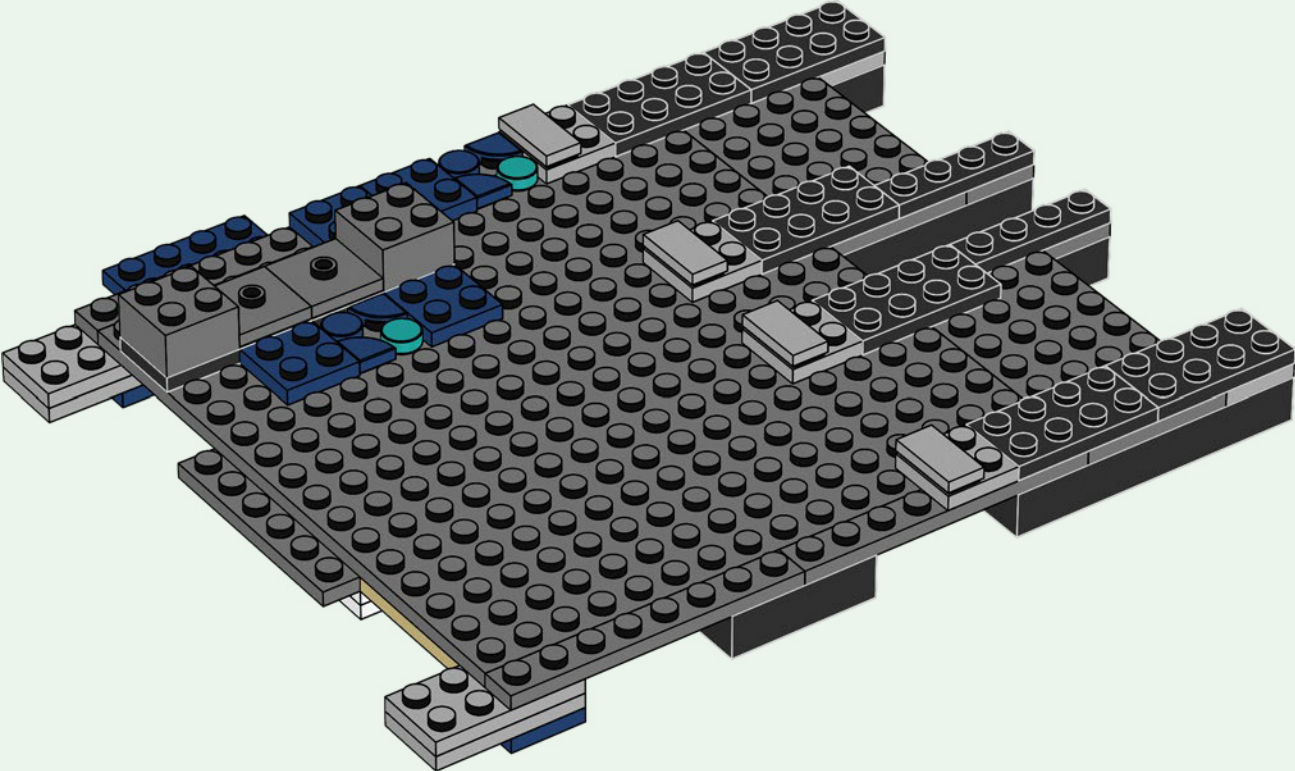

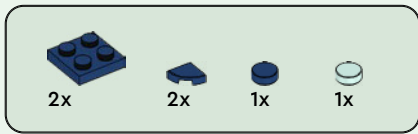

24

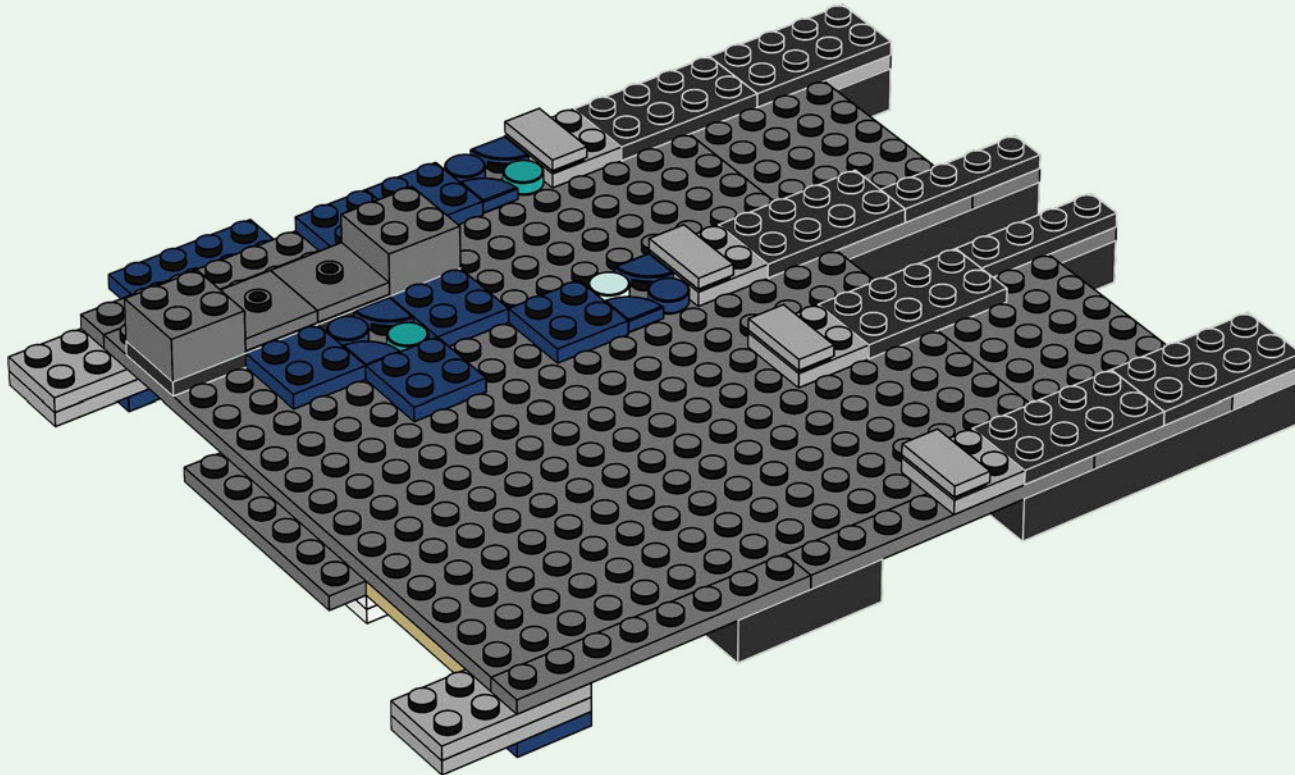

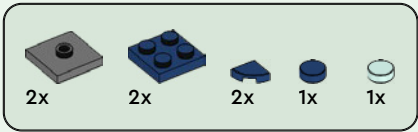

25

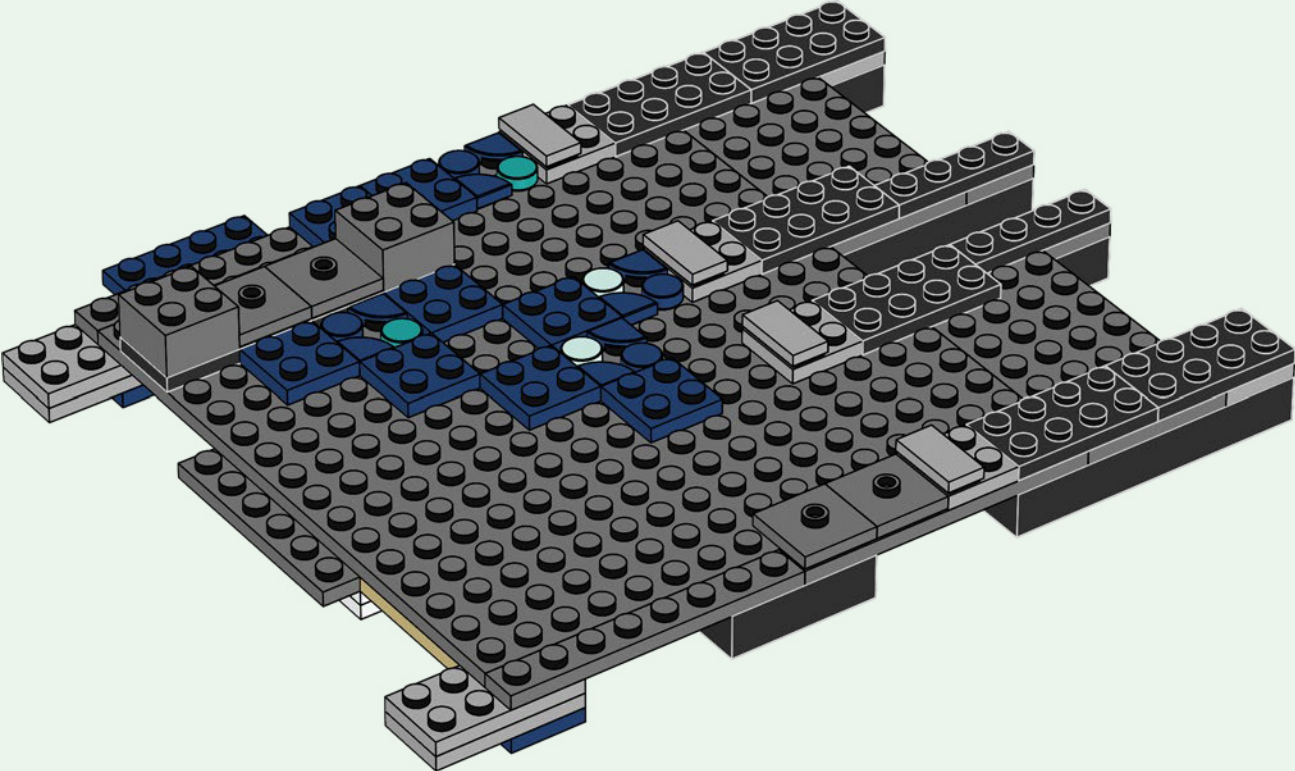

8x 4x 3x 1x

26

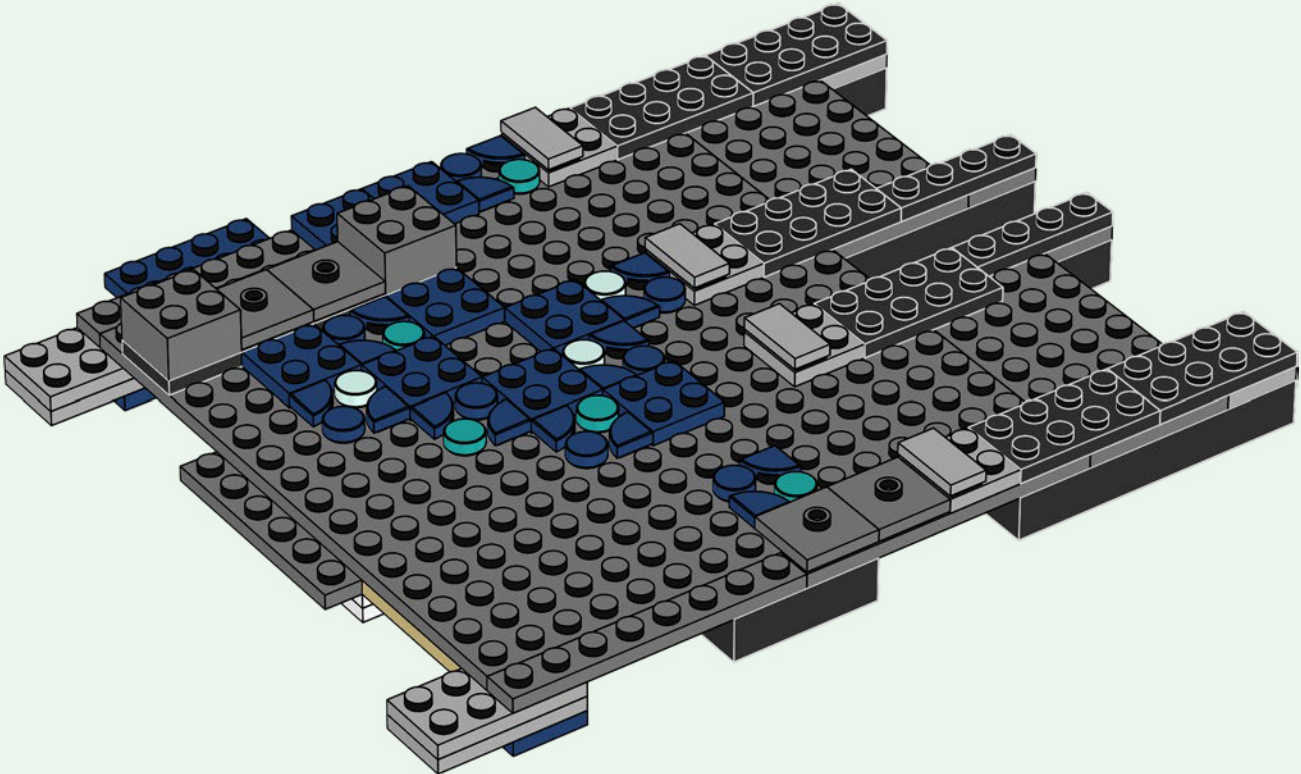

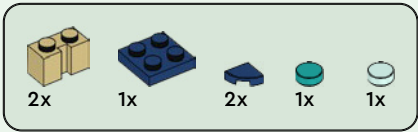

27

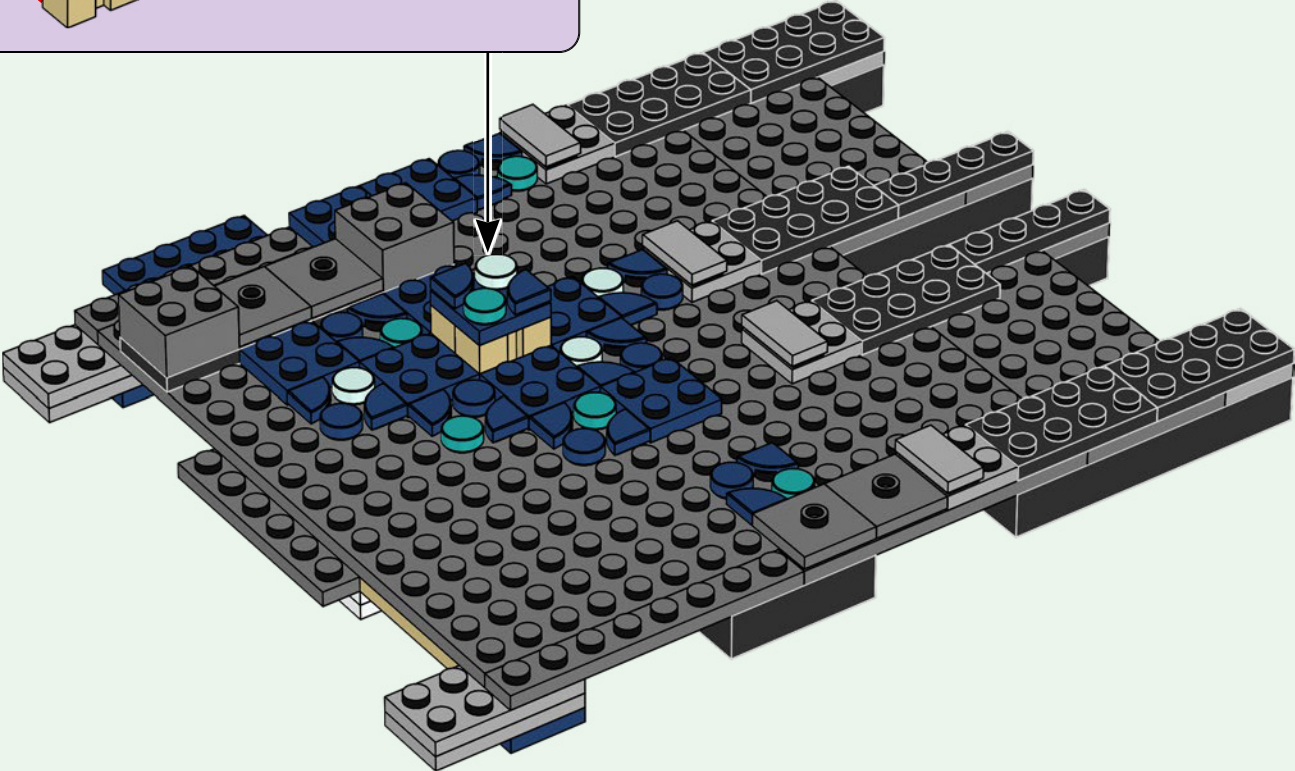
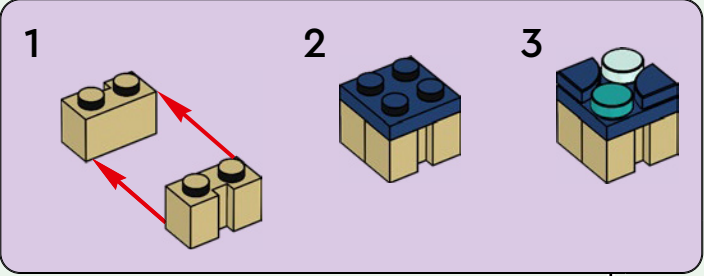

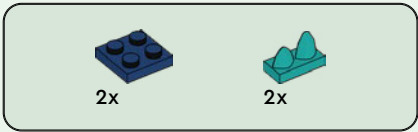

28

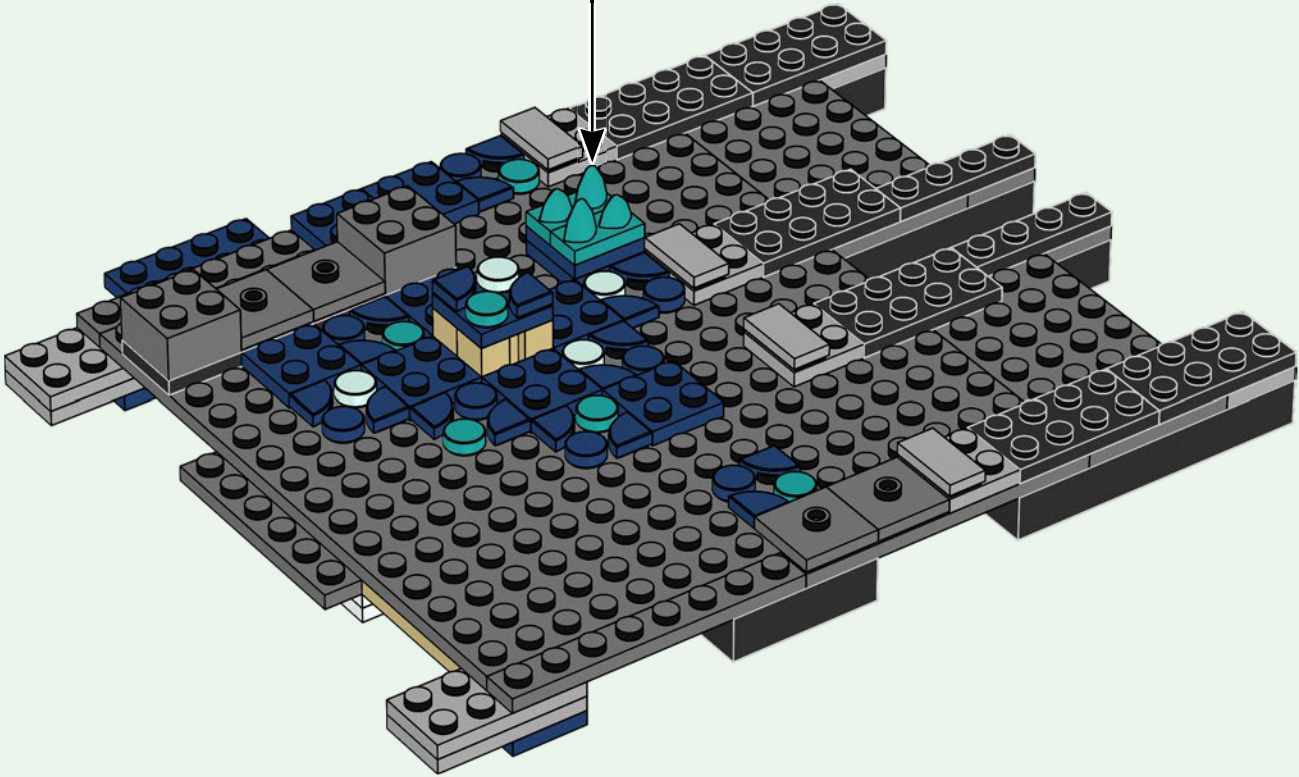
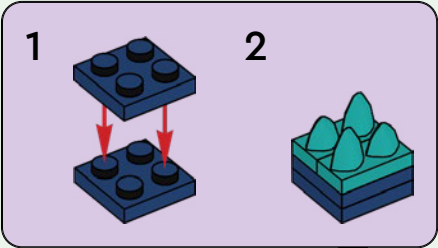

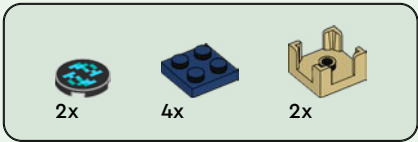

29

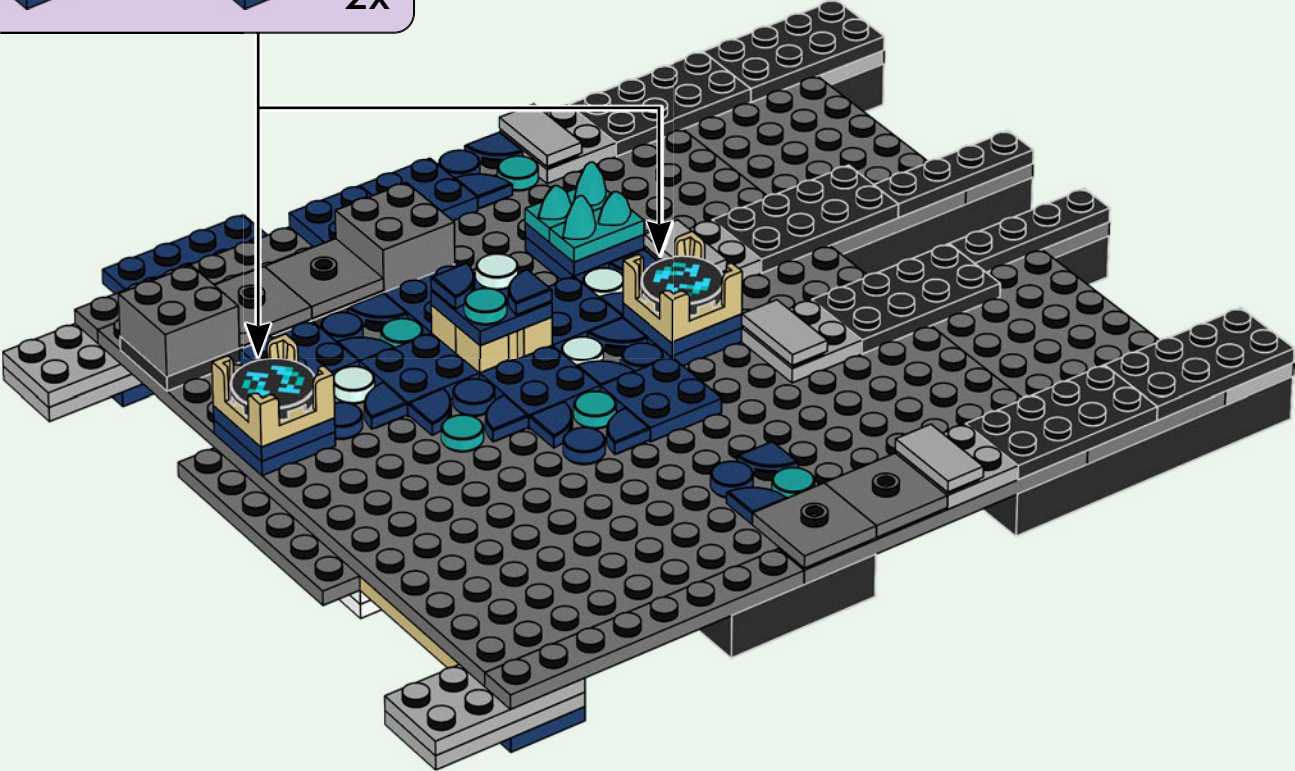
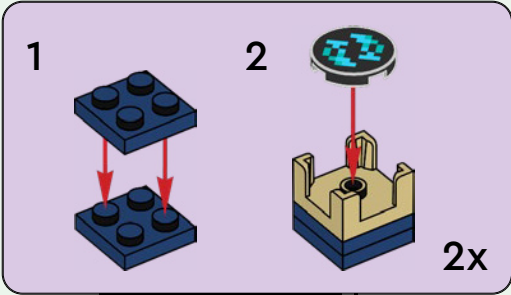

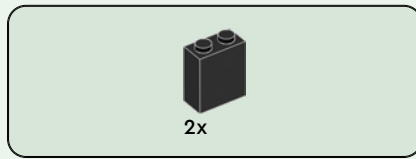

30

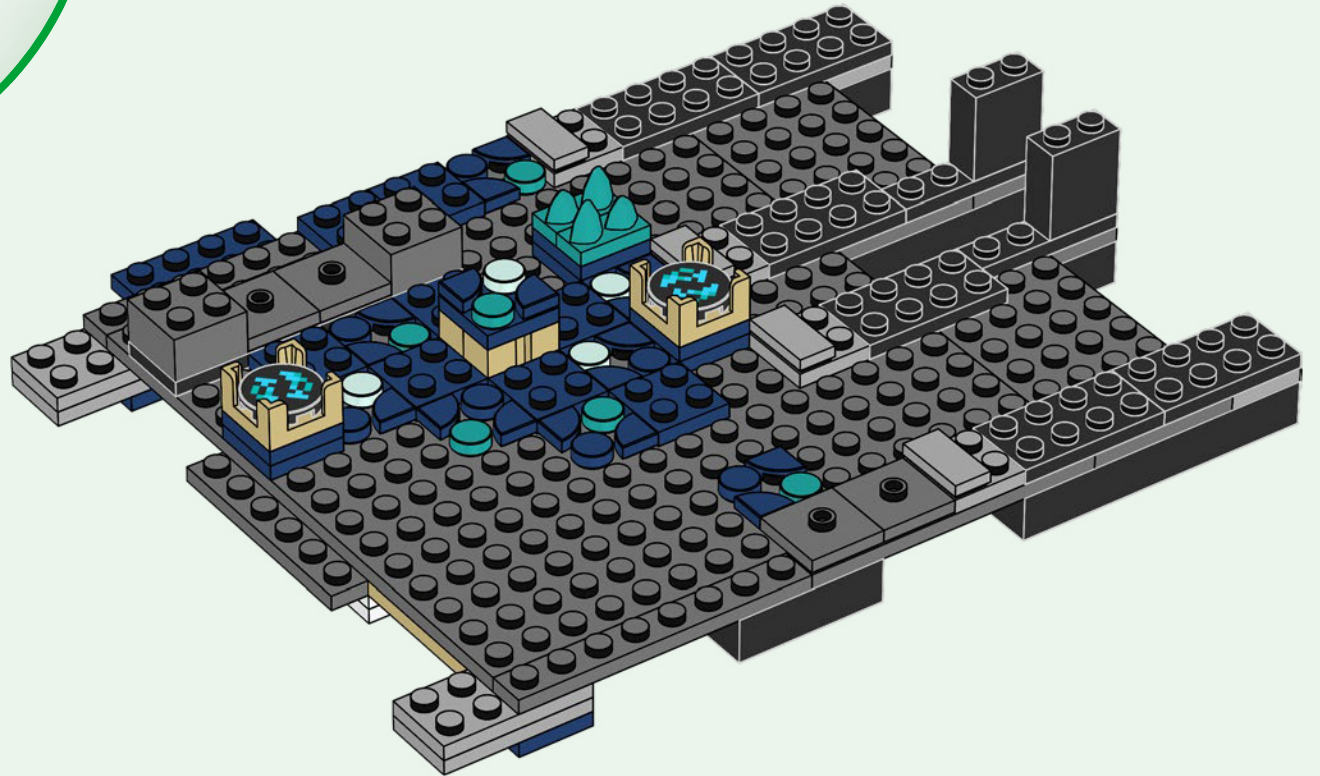

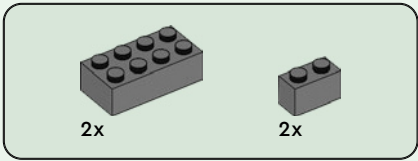

31

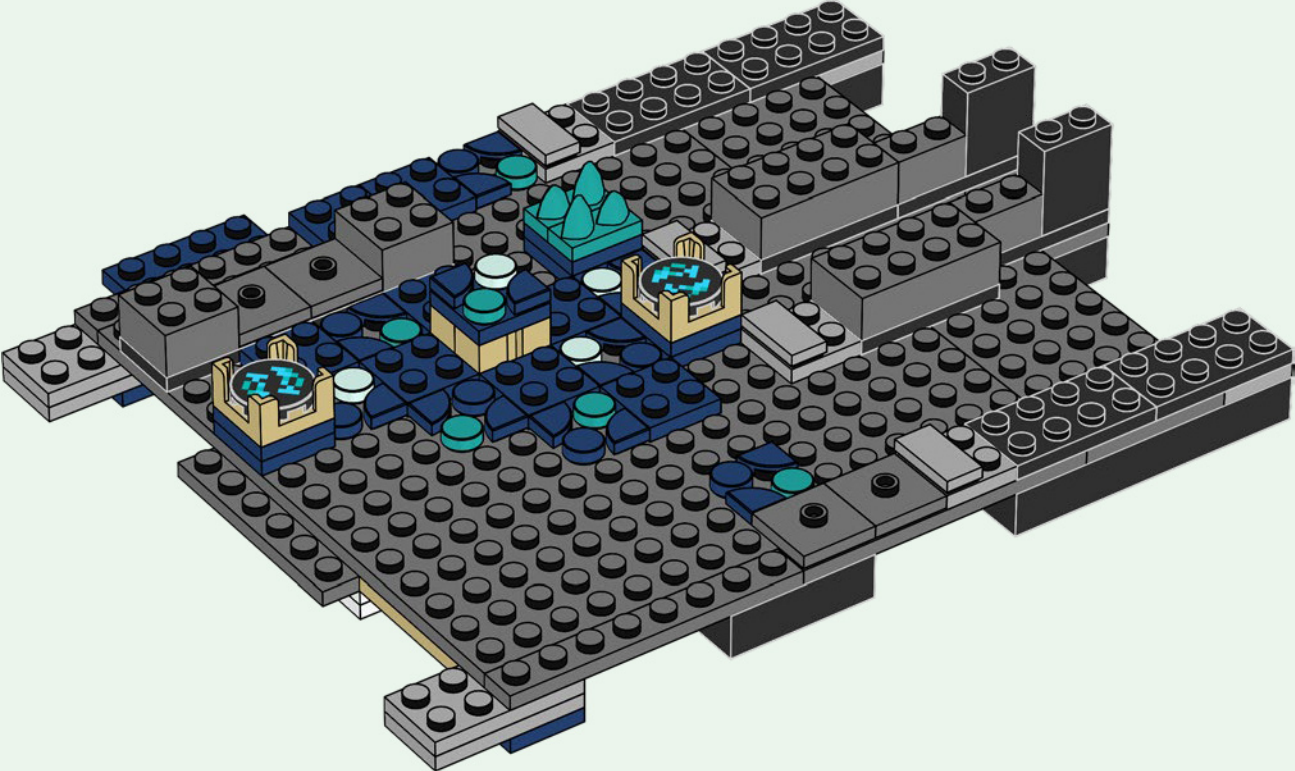



4x

32

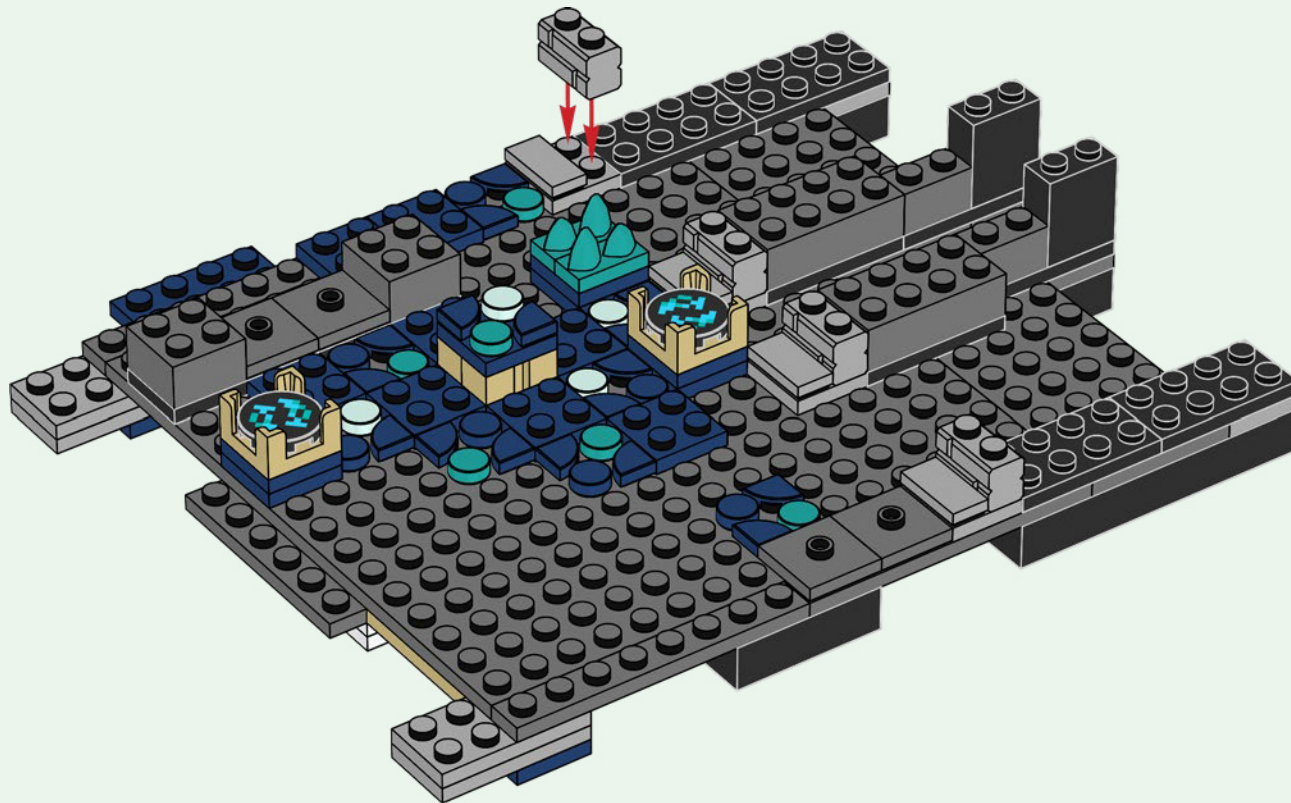

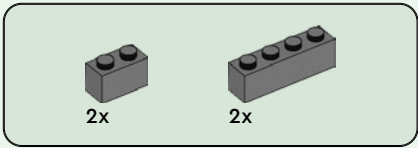

33

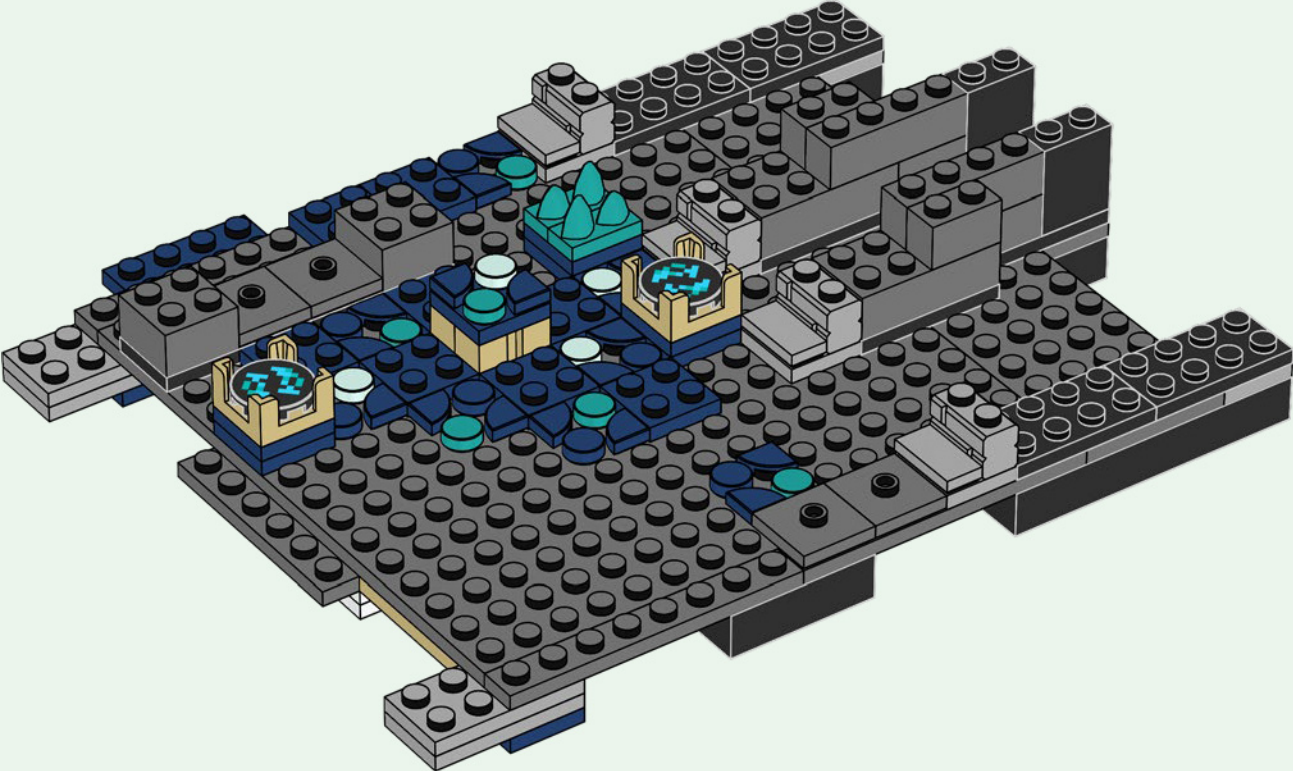

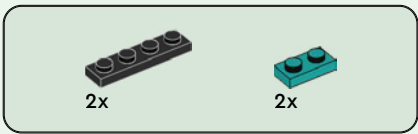

34

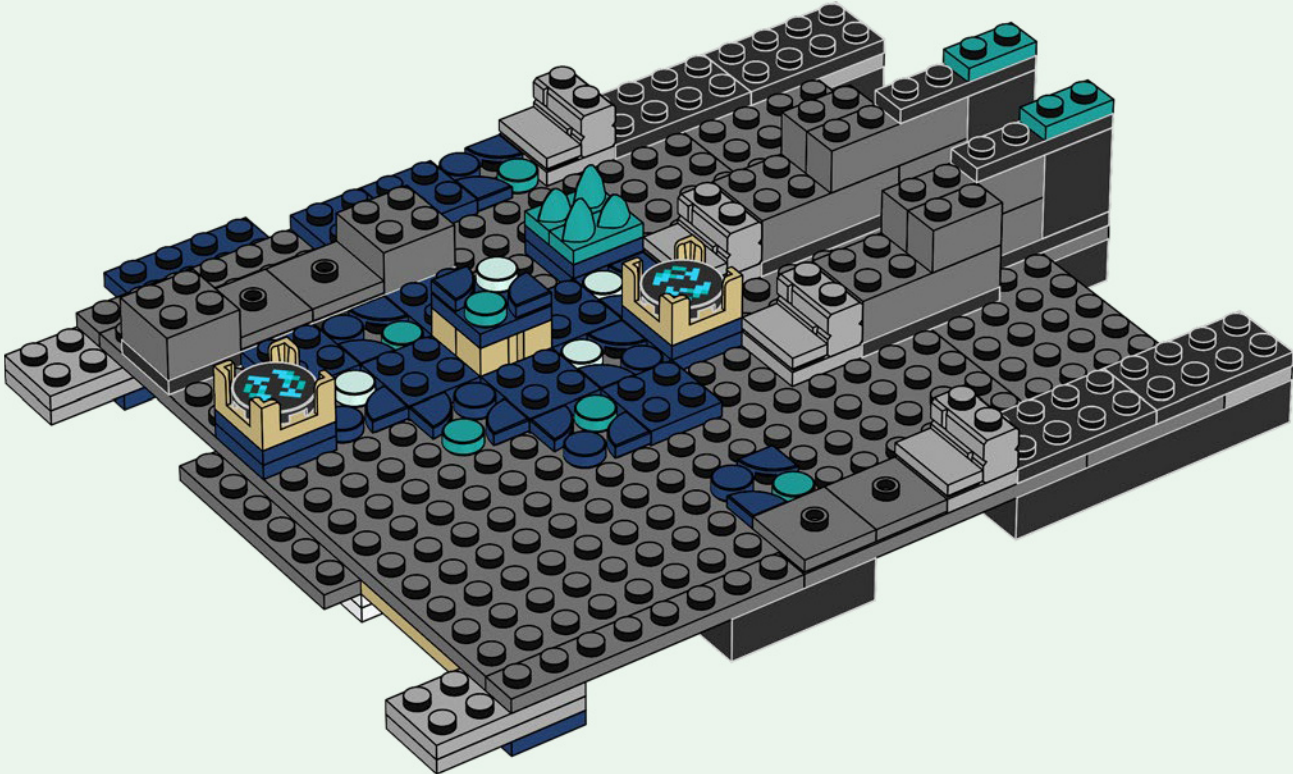

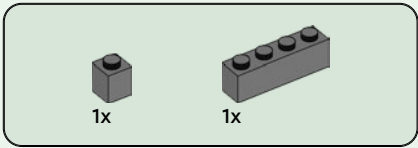

35

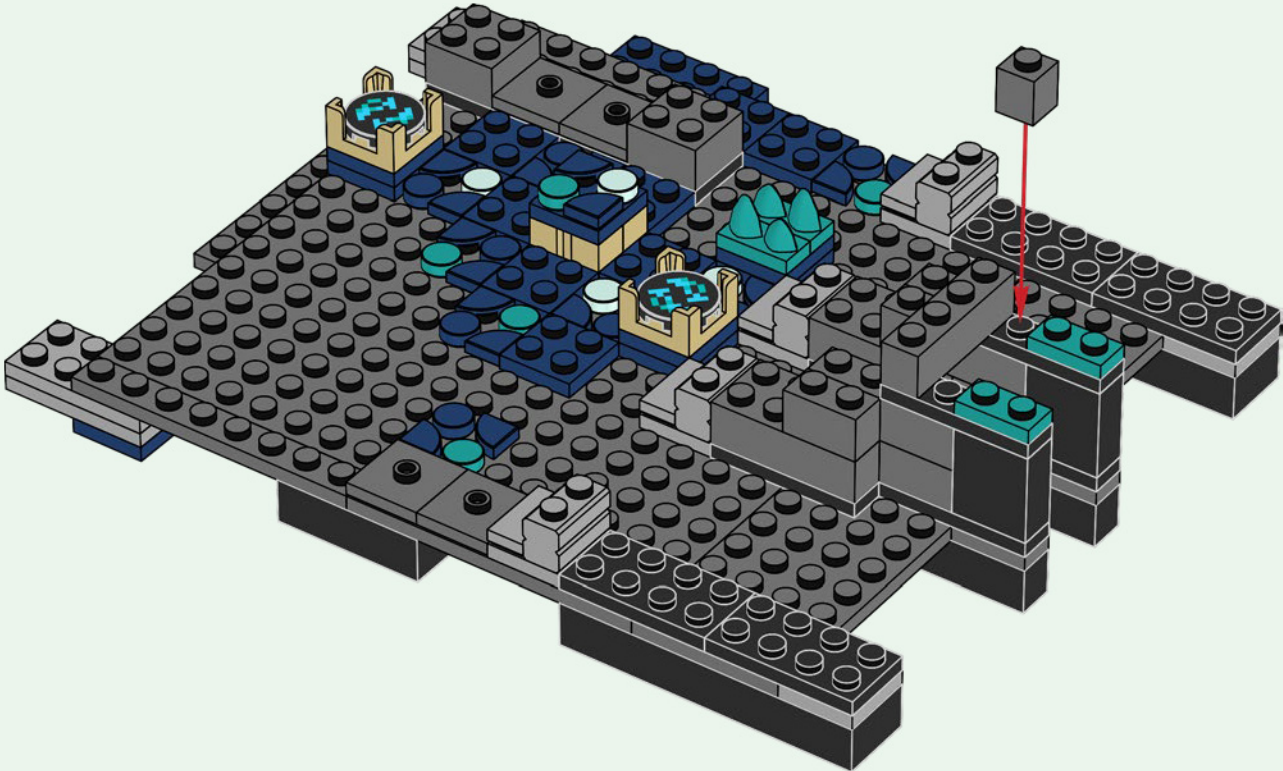

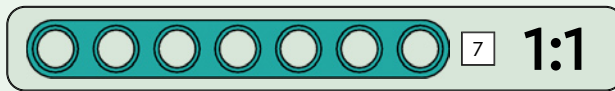
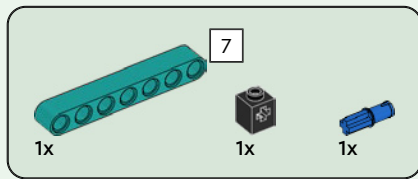

36

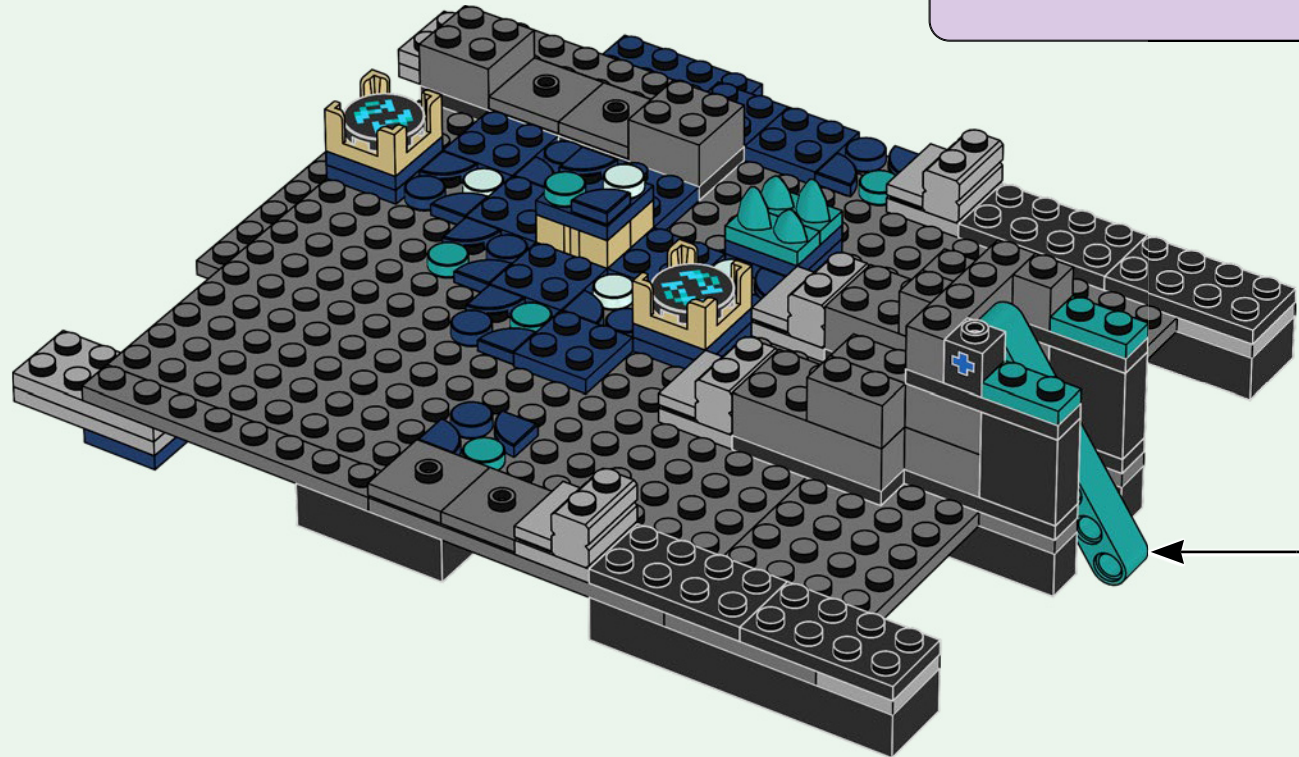
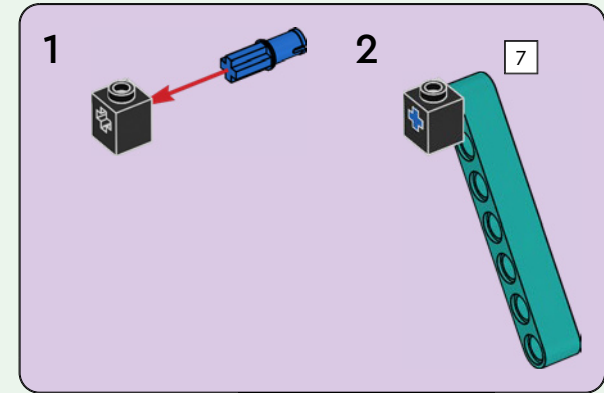



4x

37

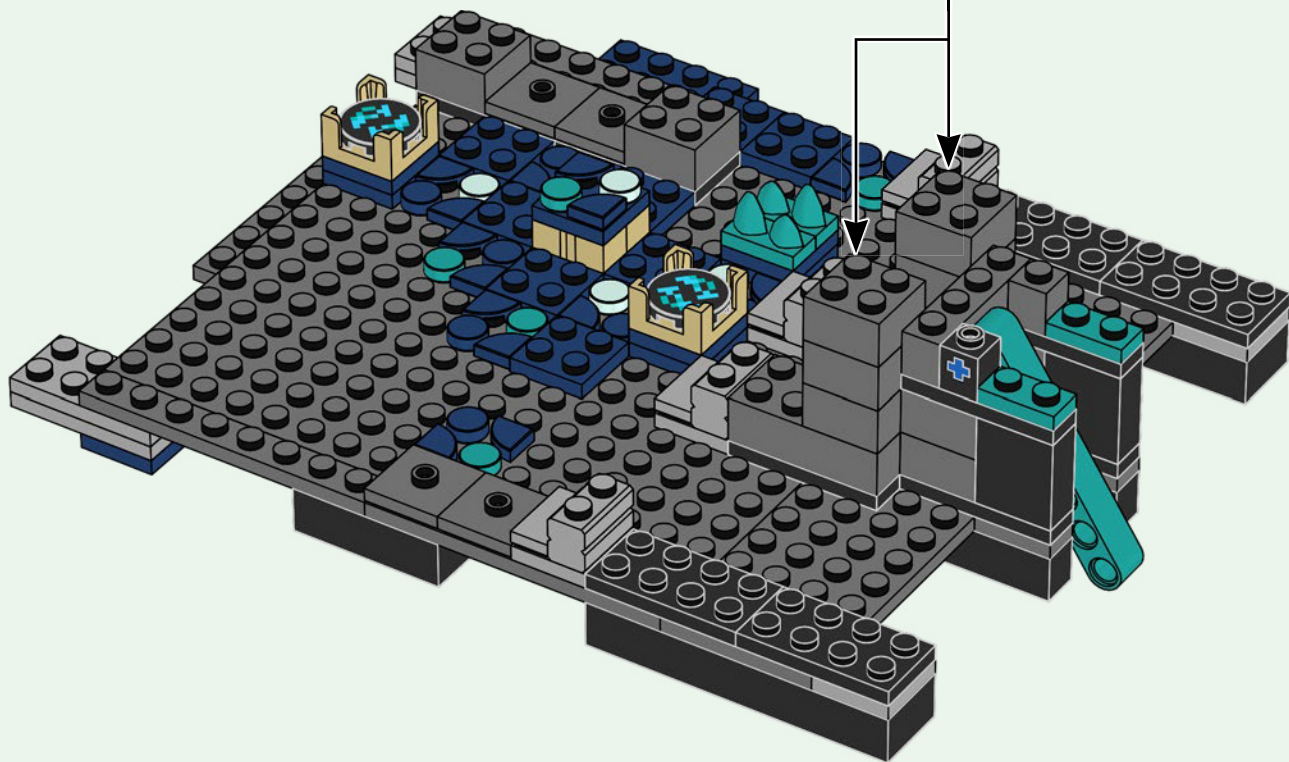
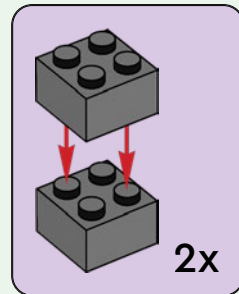



4x

38

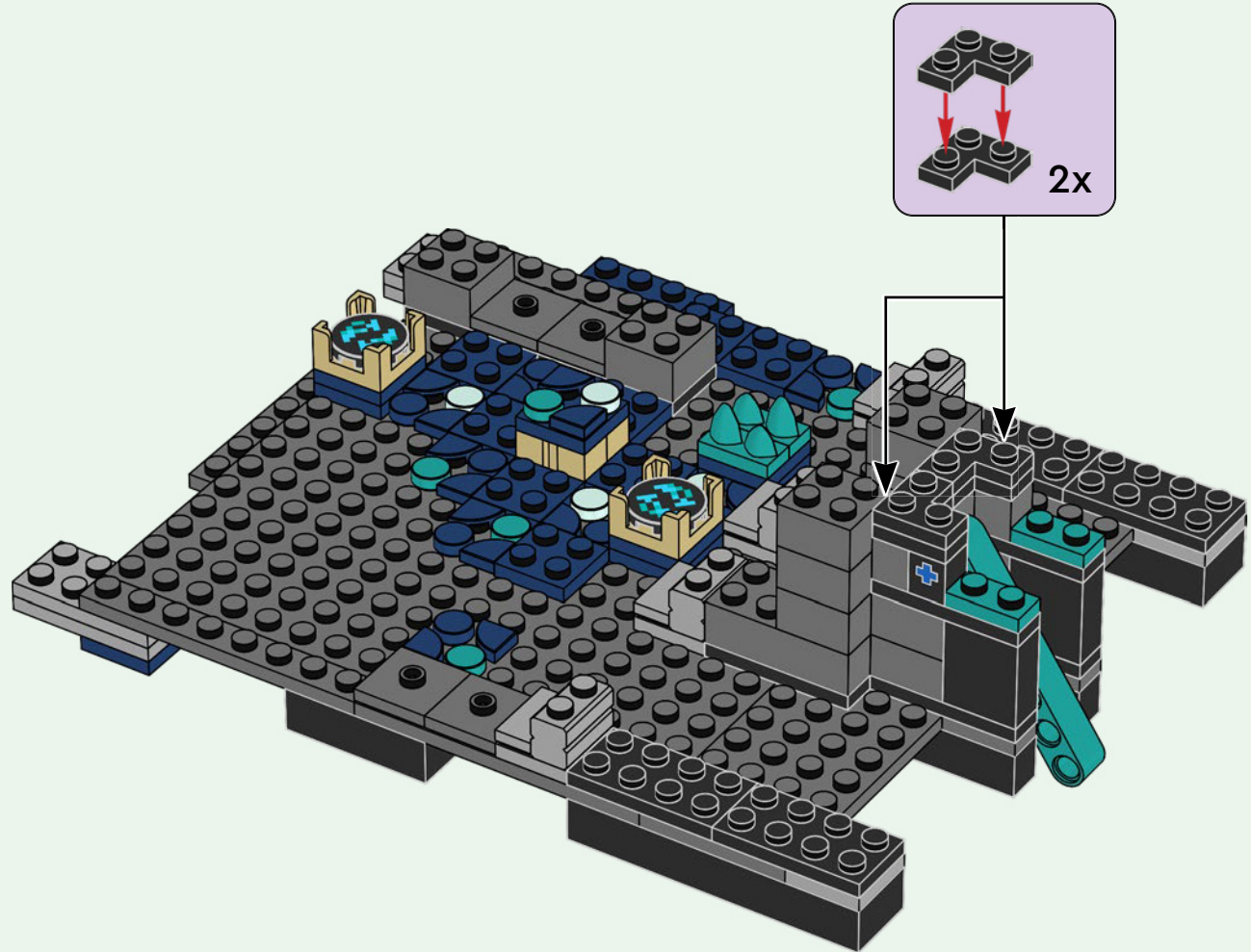



2x



2x

39

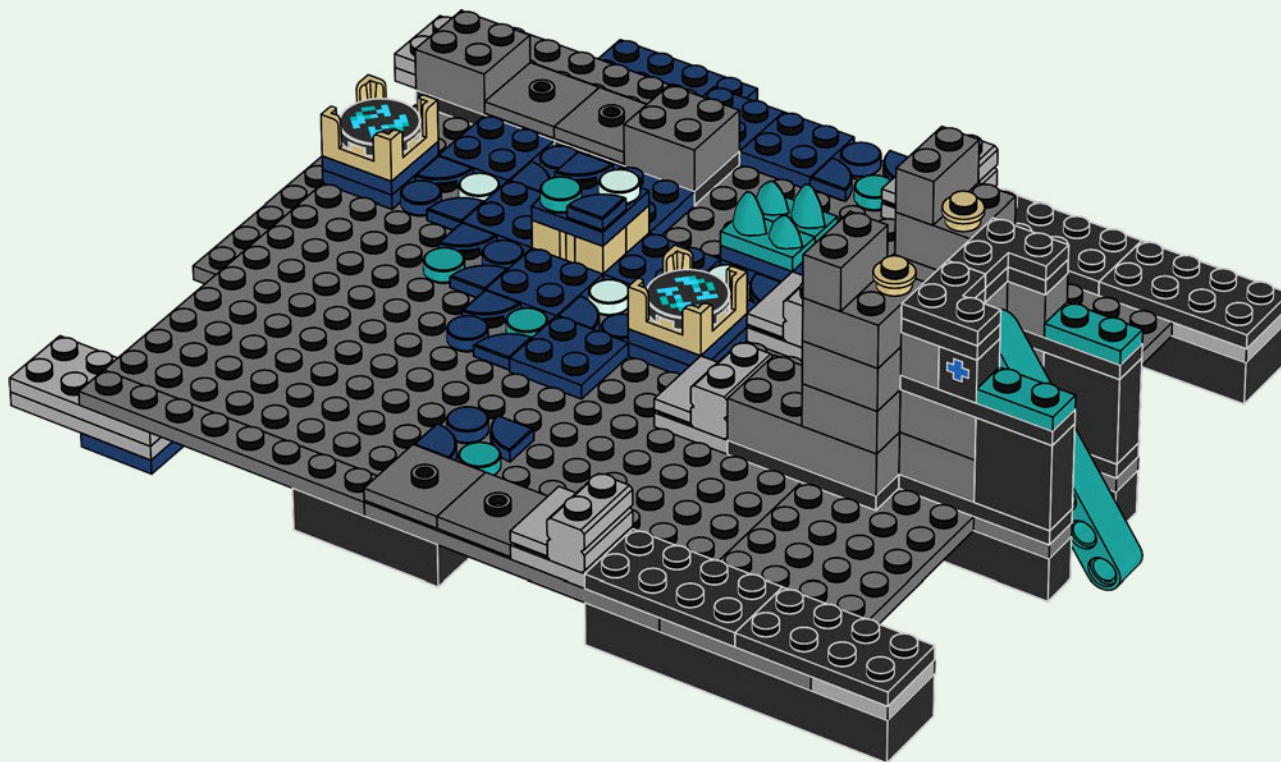

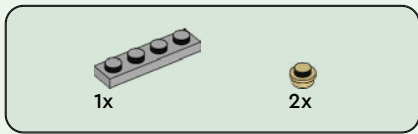

40

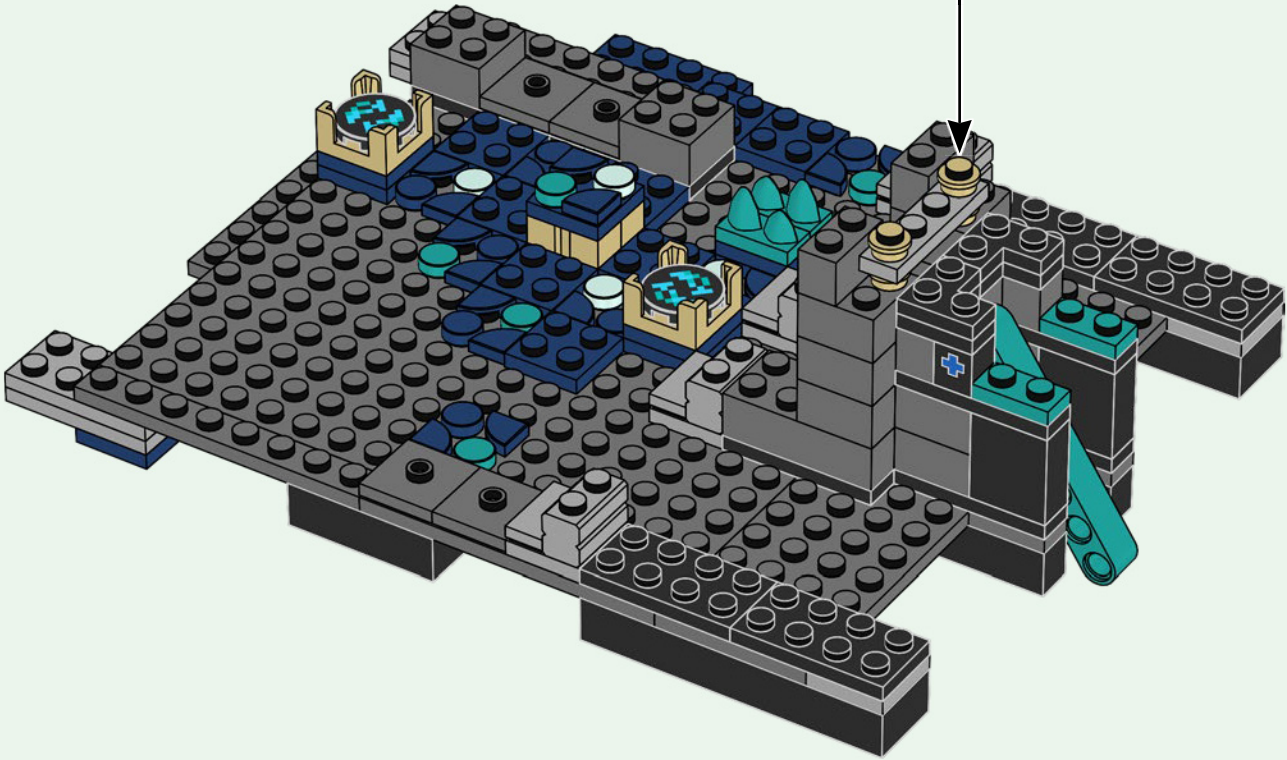
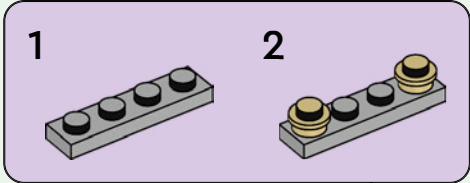



1x

41

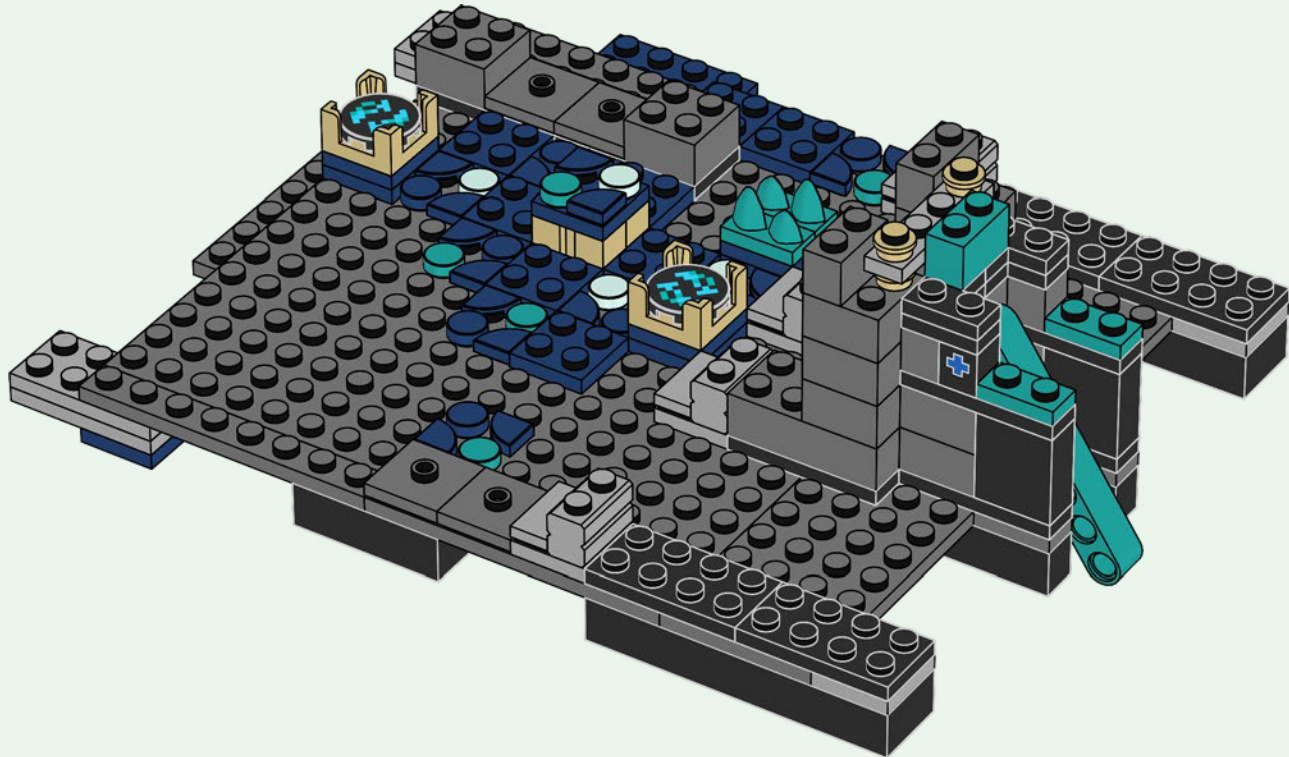

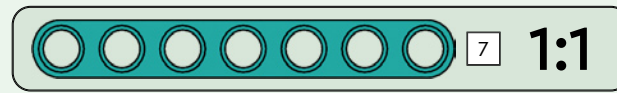
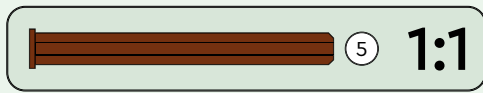
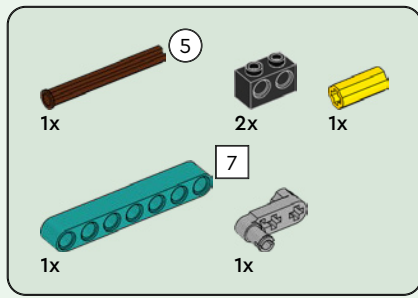

42

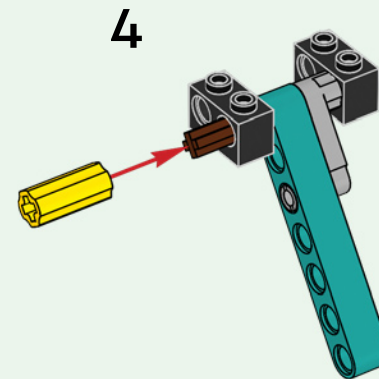
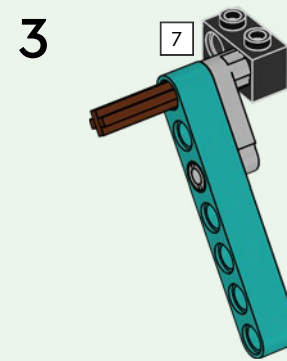
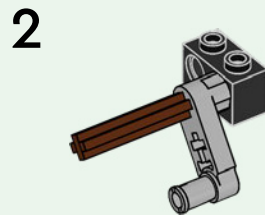
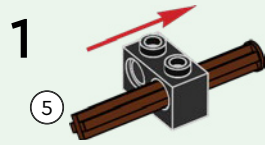

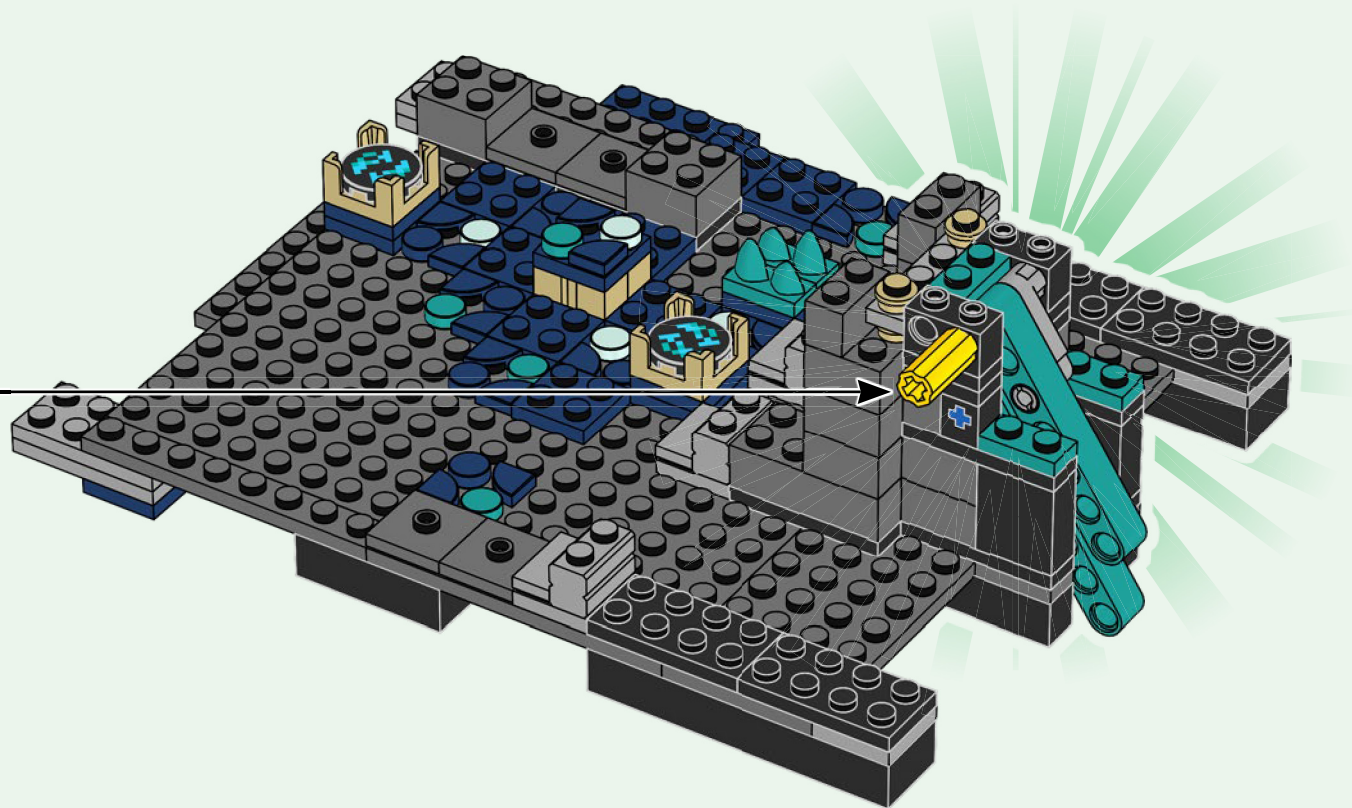

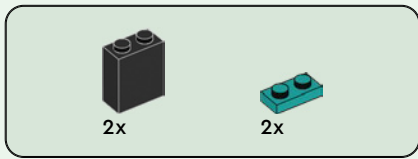

43

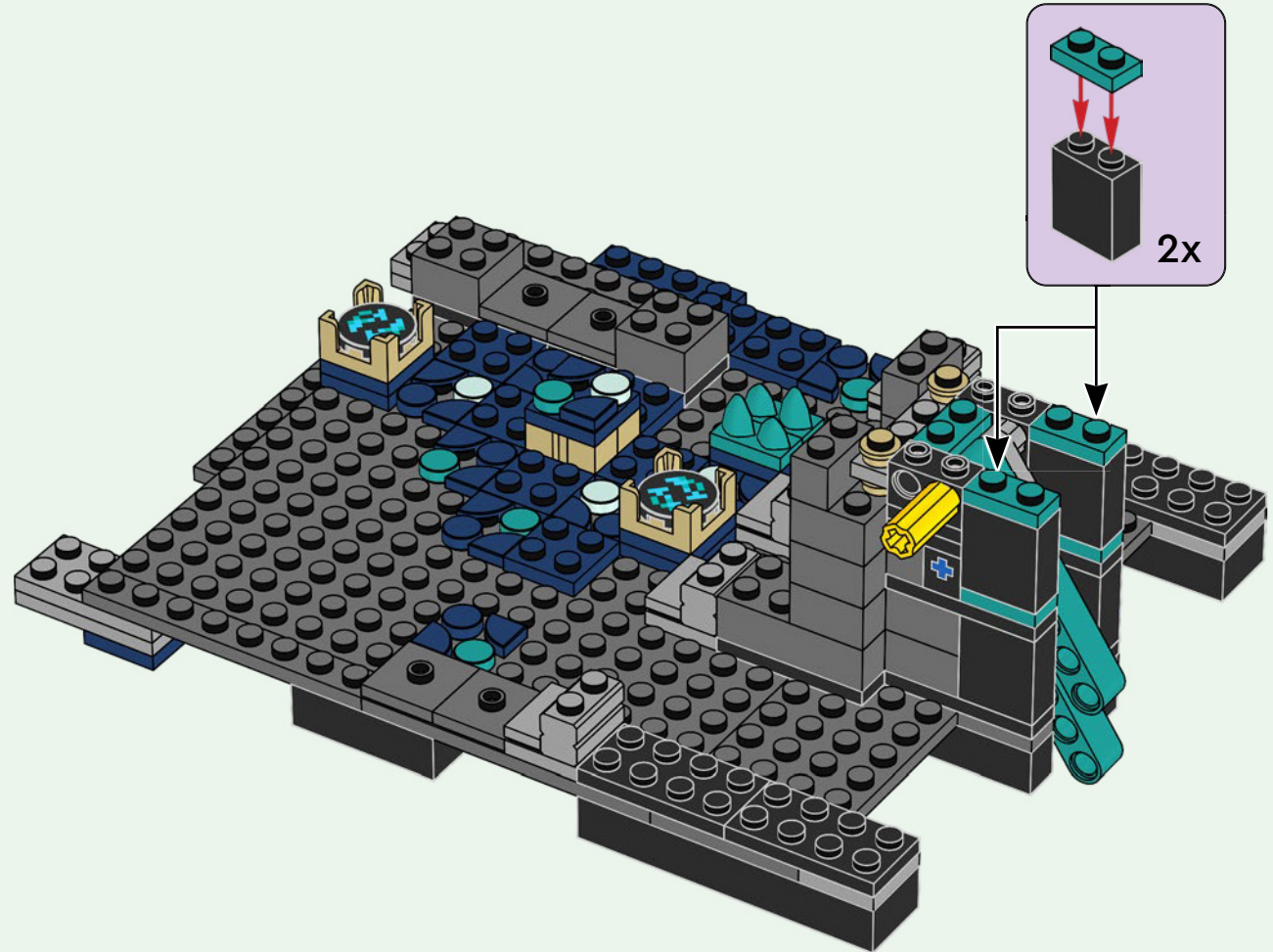

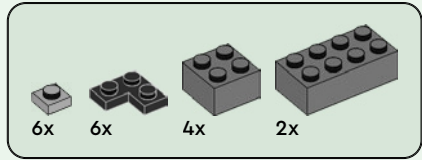
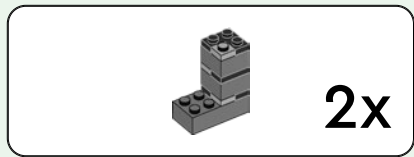

44

1

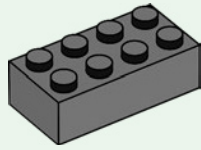

2

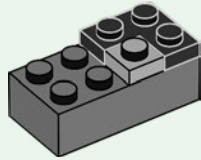

3

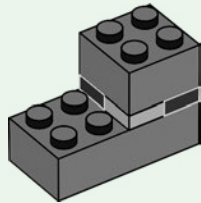

4

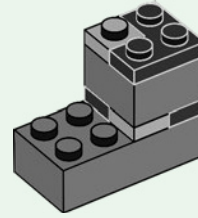

5

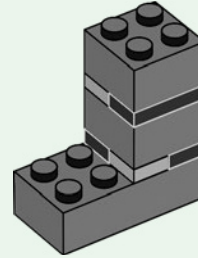

6

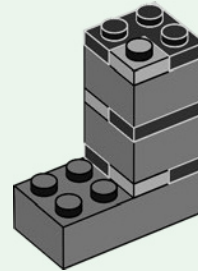

2x



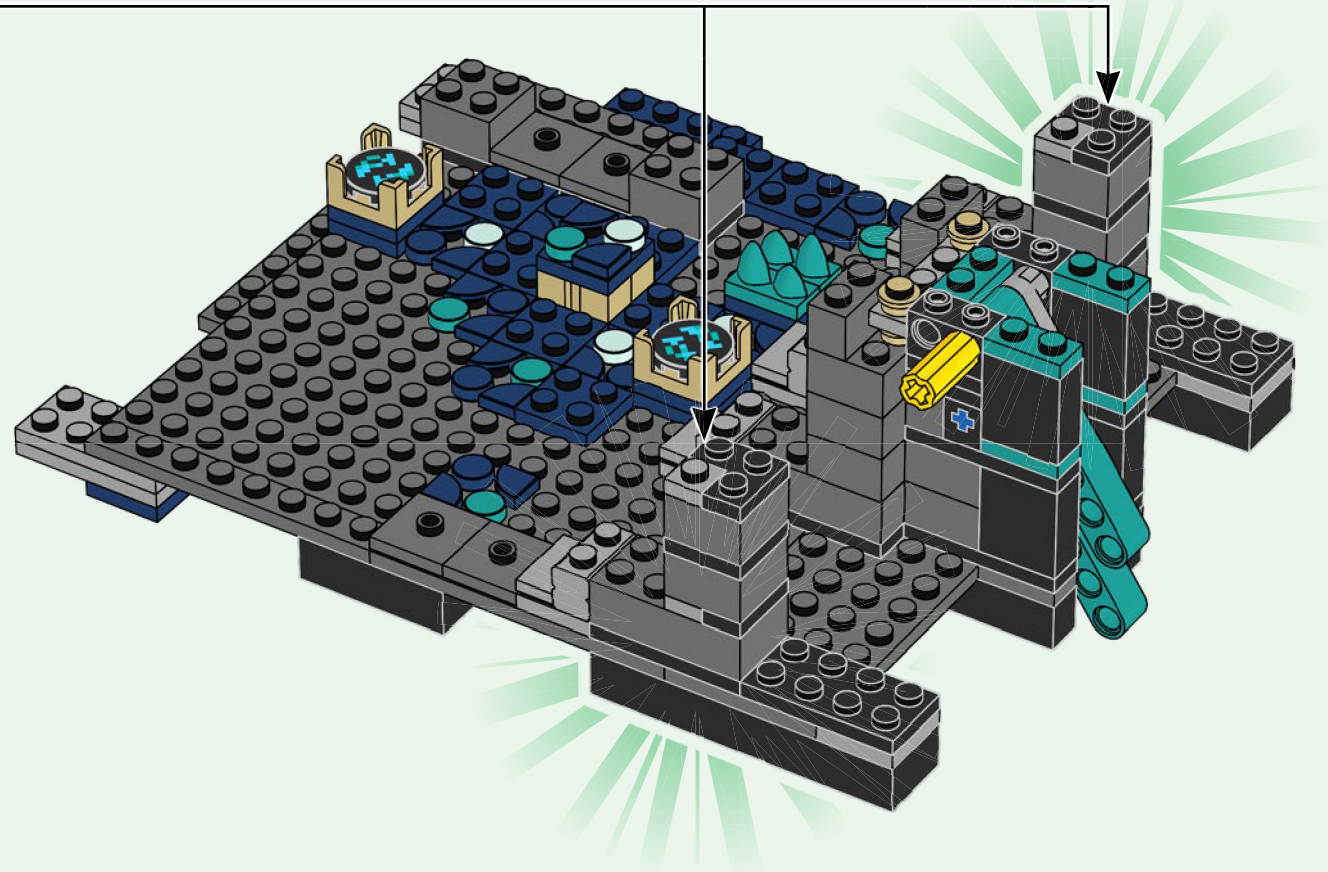



4x

46

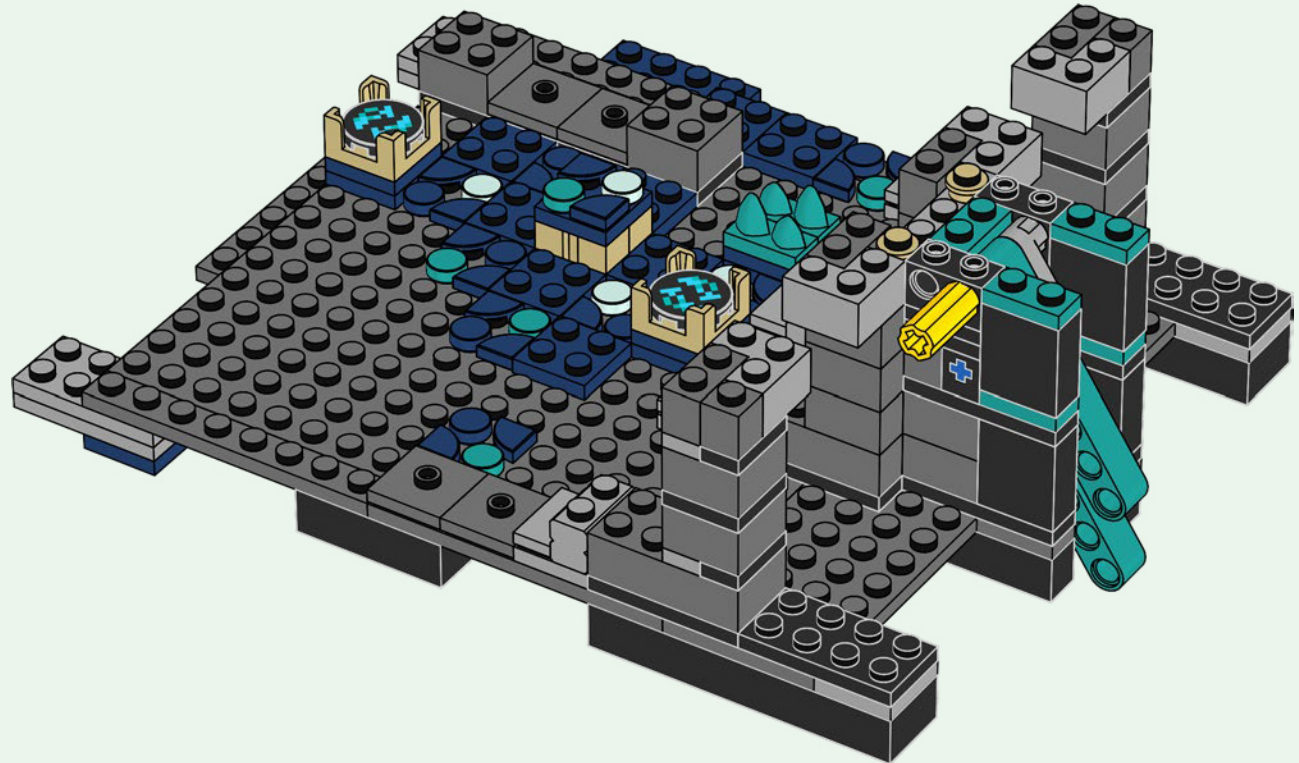



8x

47

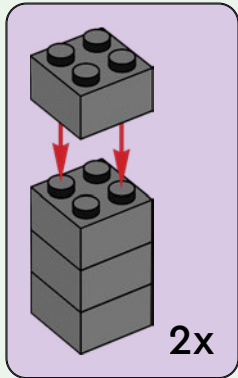
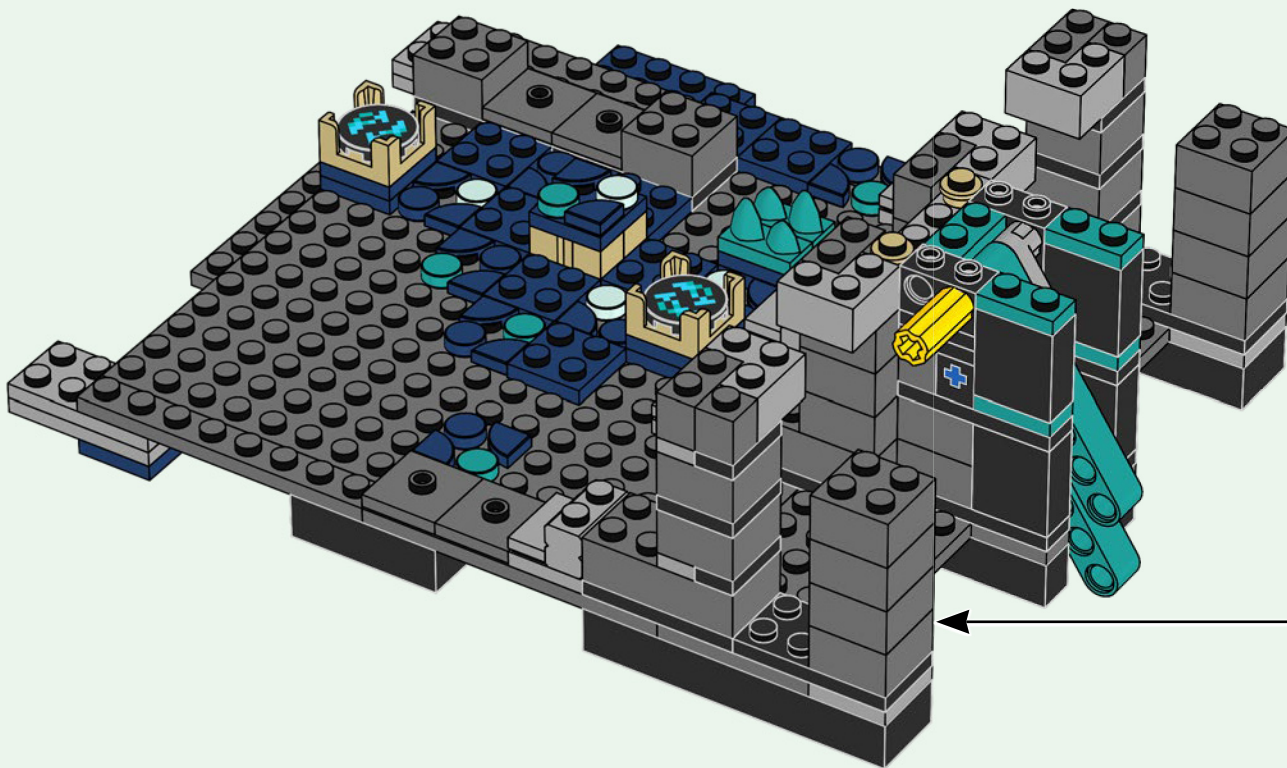

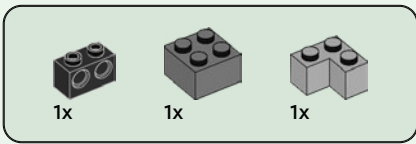

48

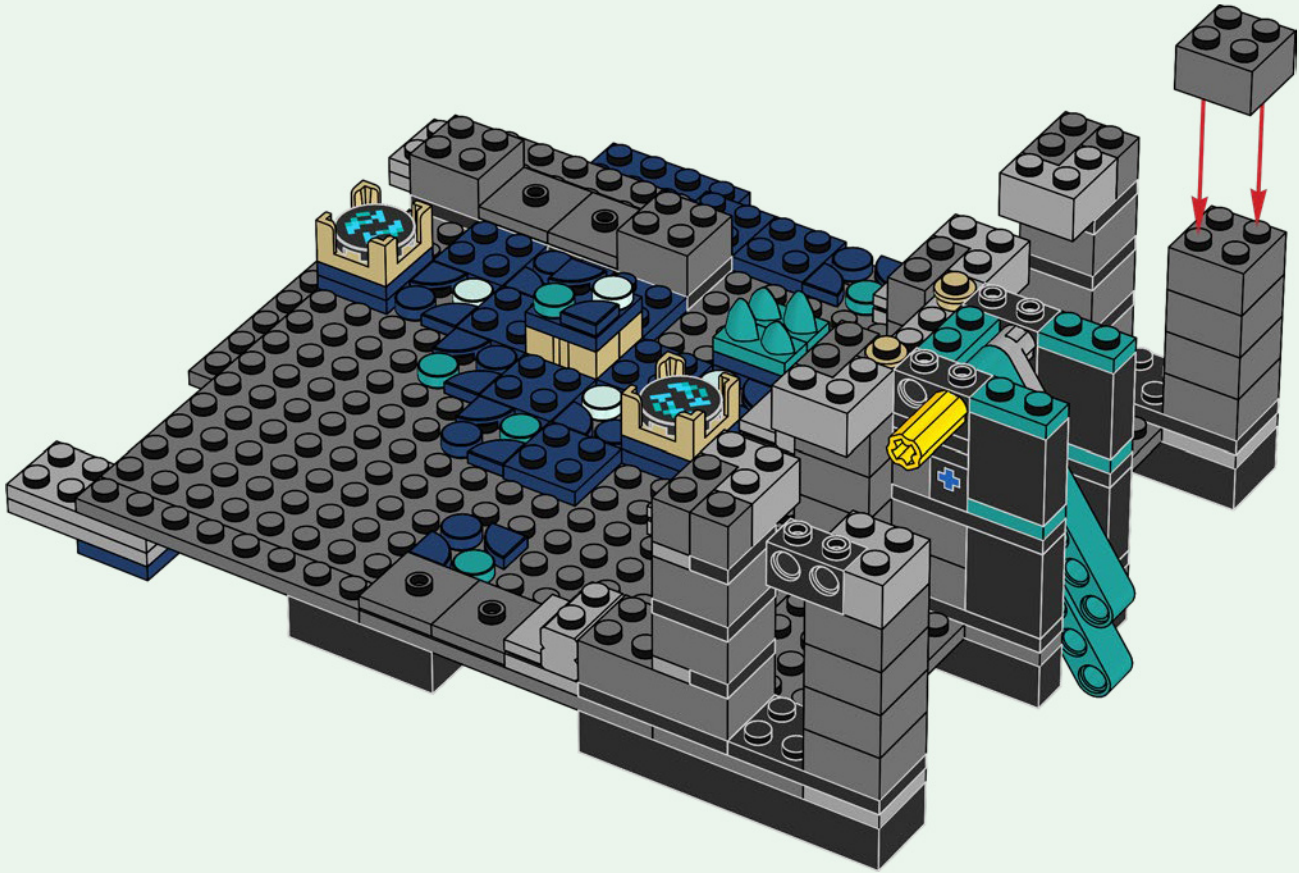

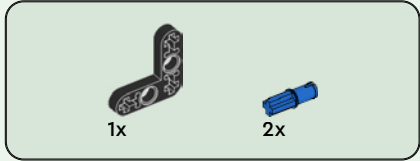
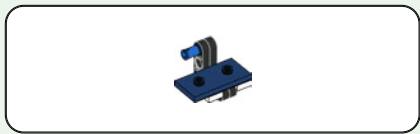

49

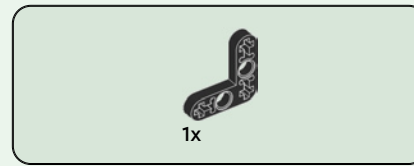
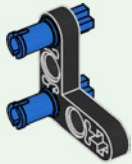

50

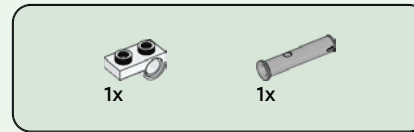
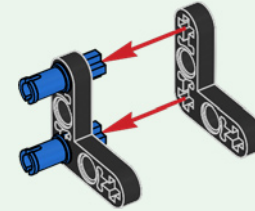

51

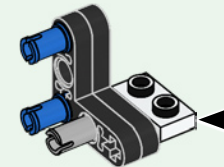
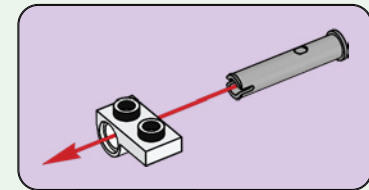



1x

52

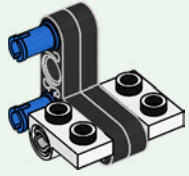

1x

53

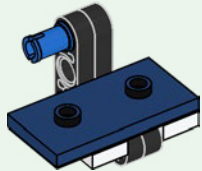

54

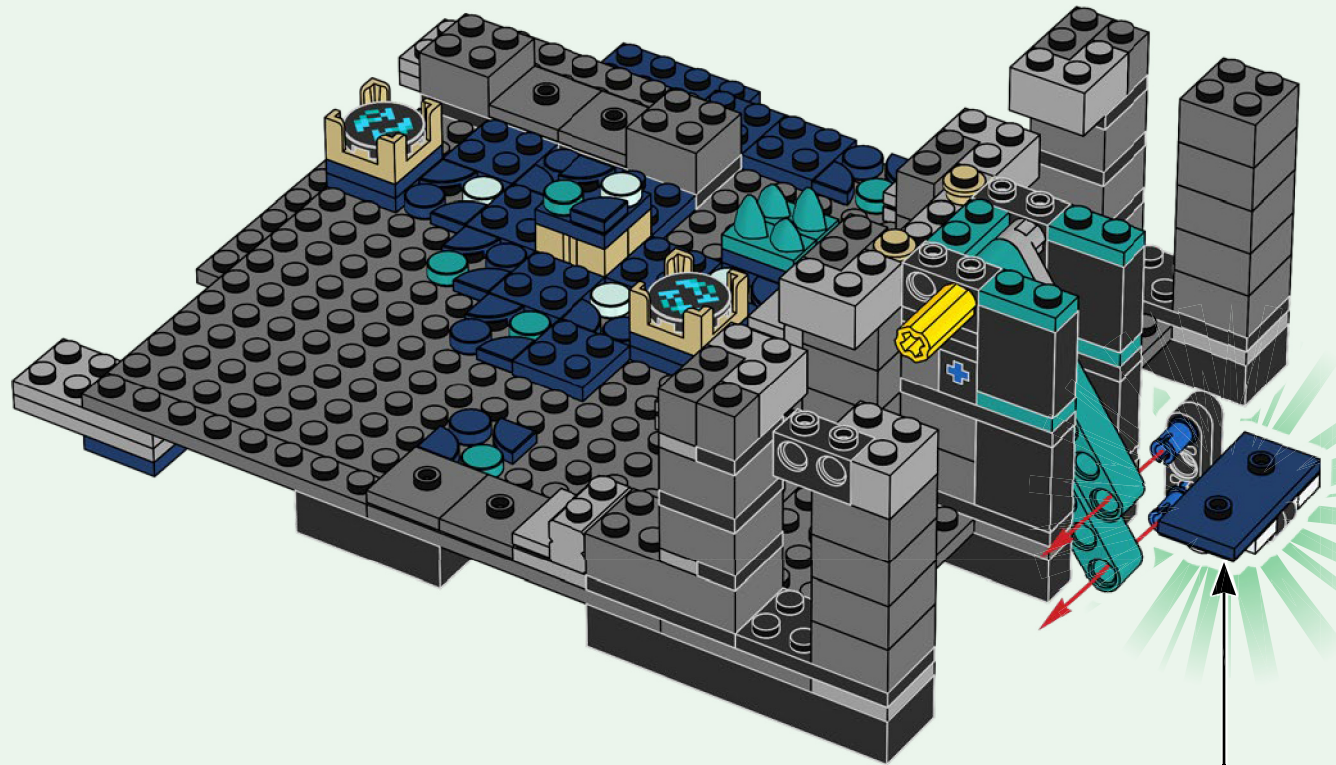

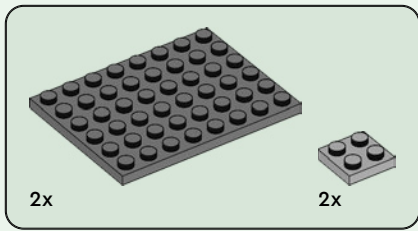

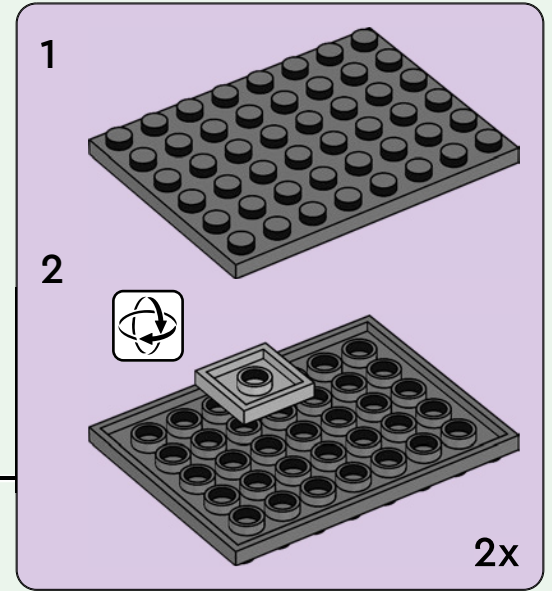
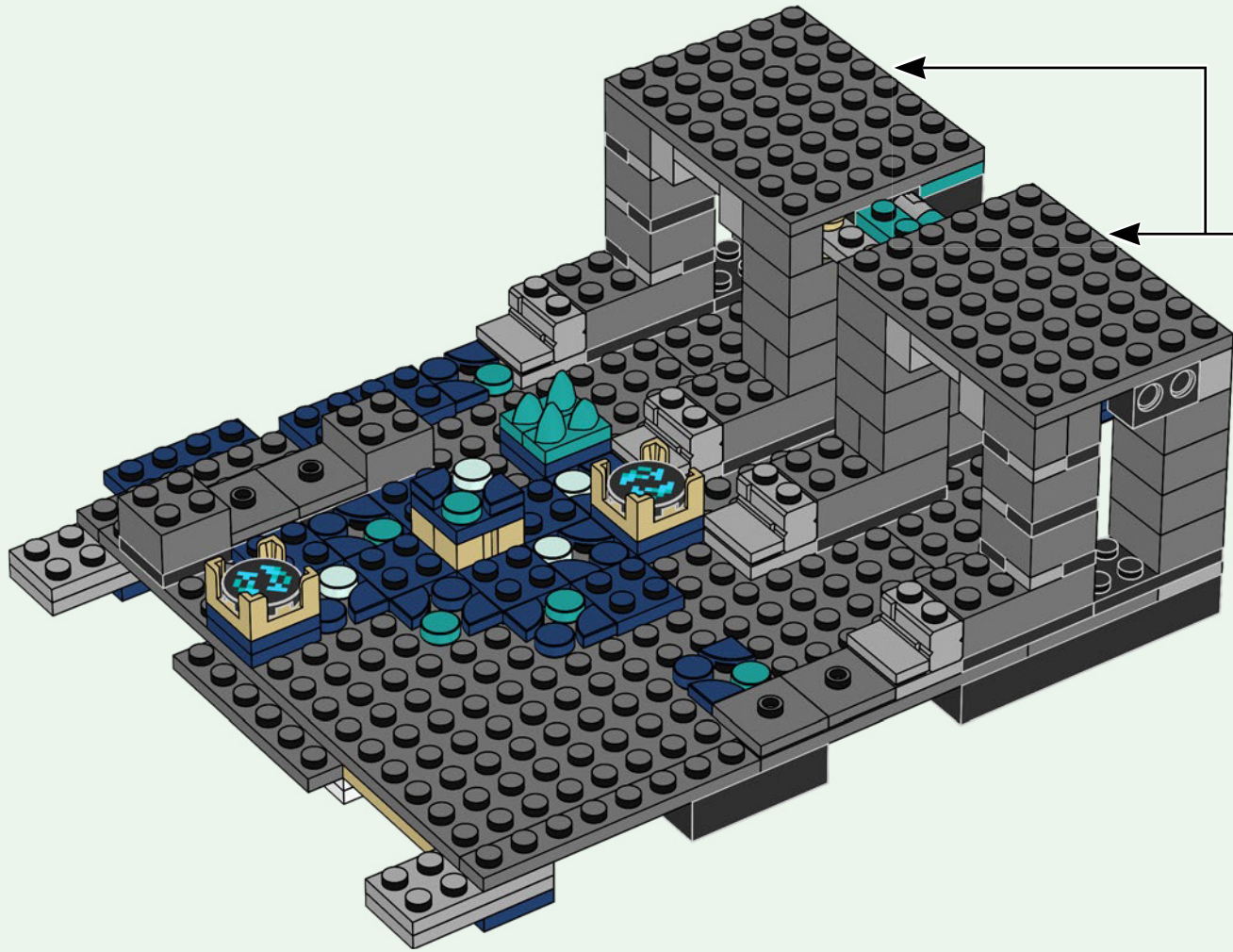

55

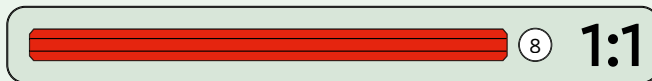
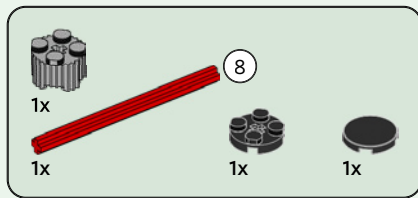

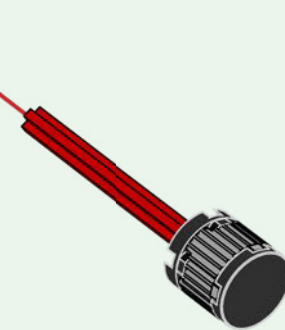
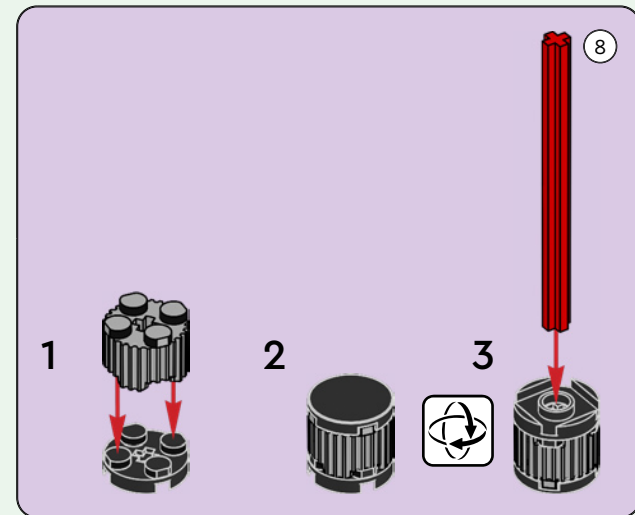
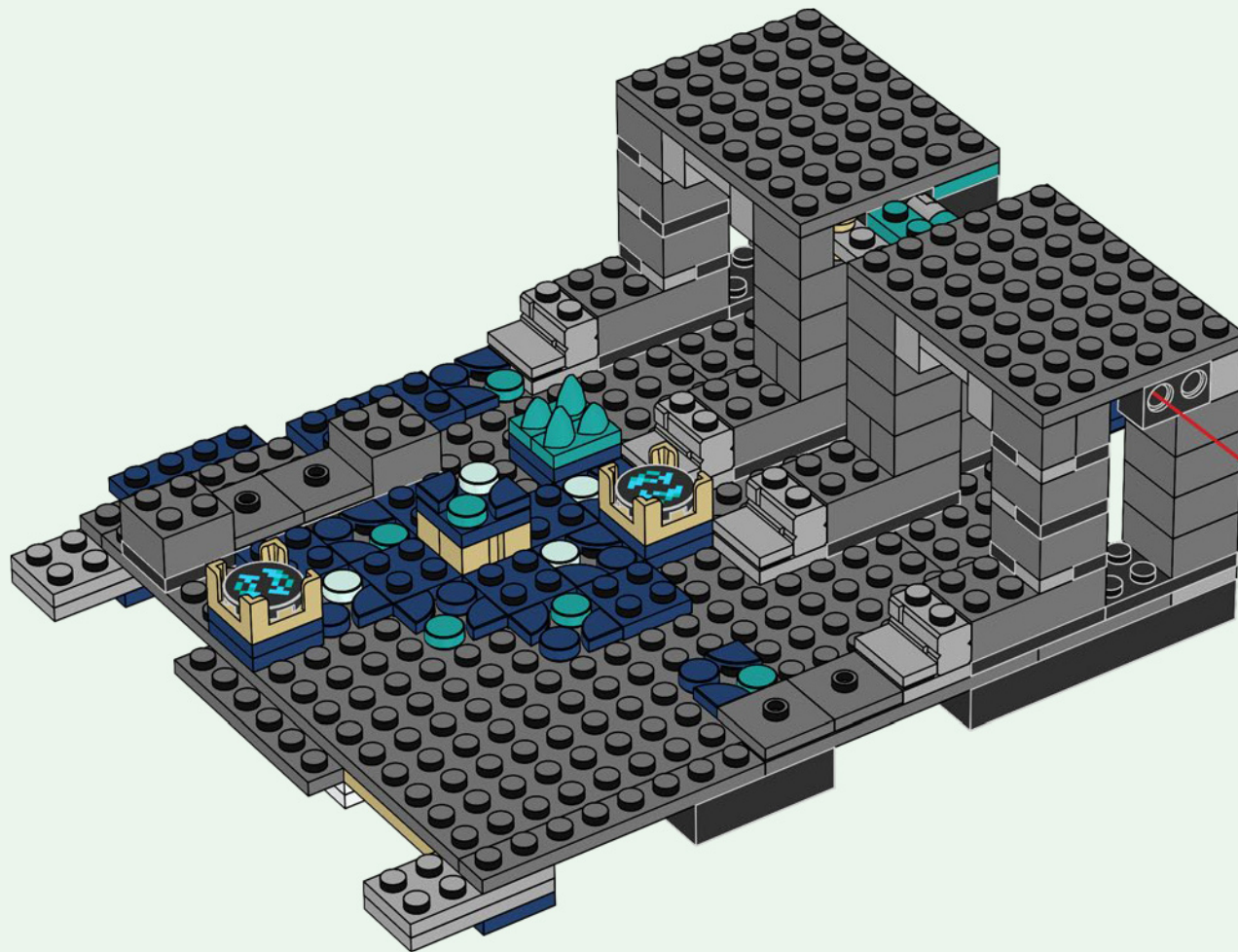

56



4x  4x 

57

 4x

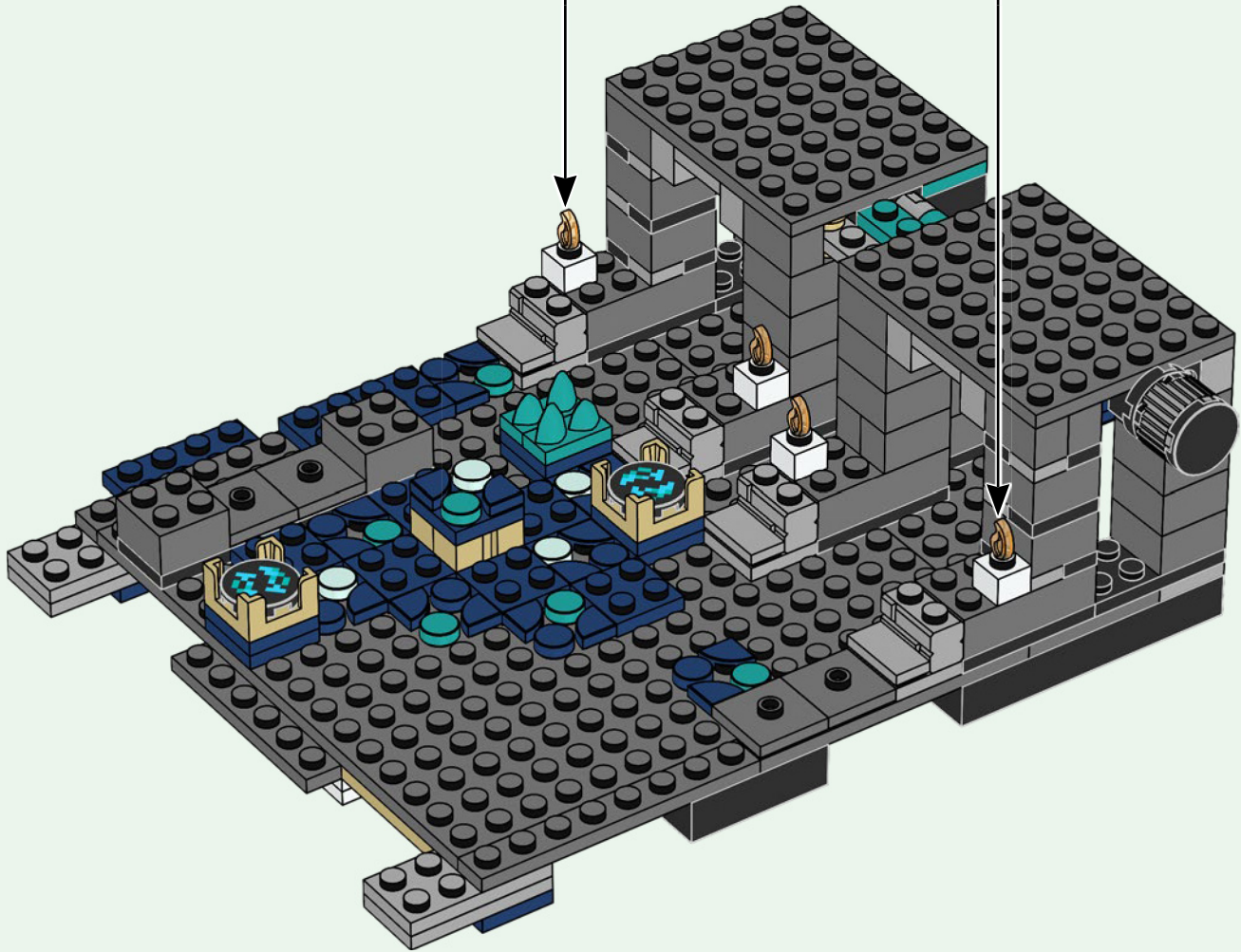

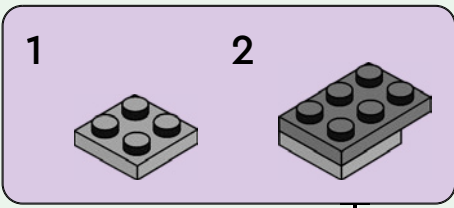
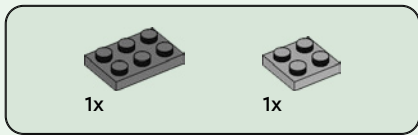

58

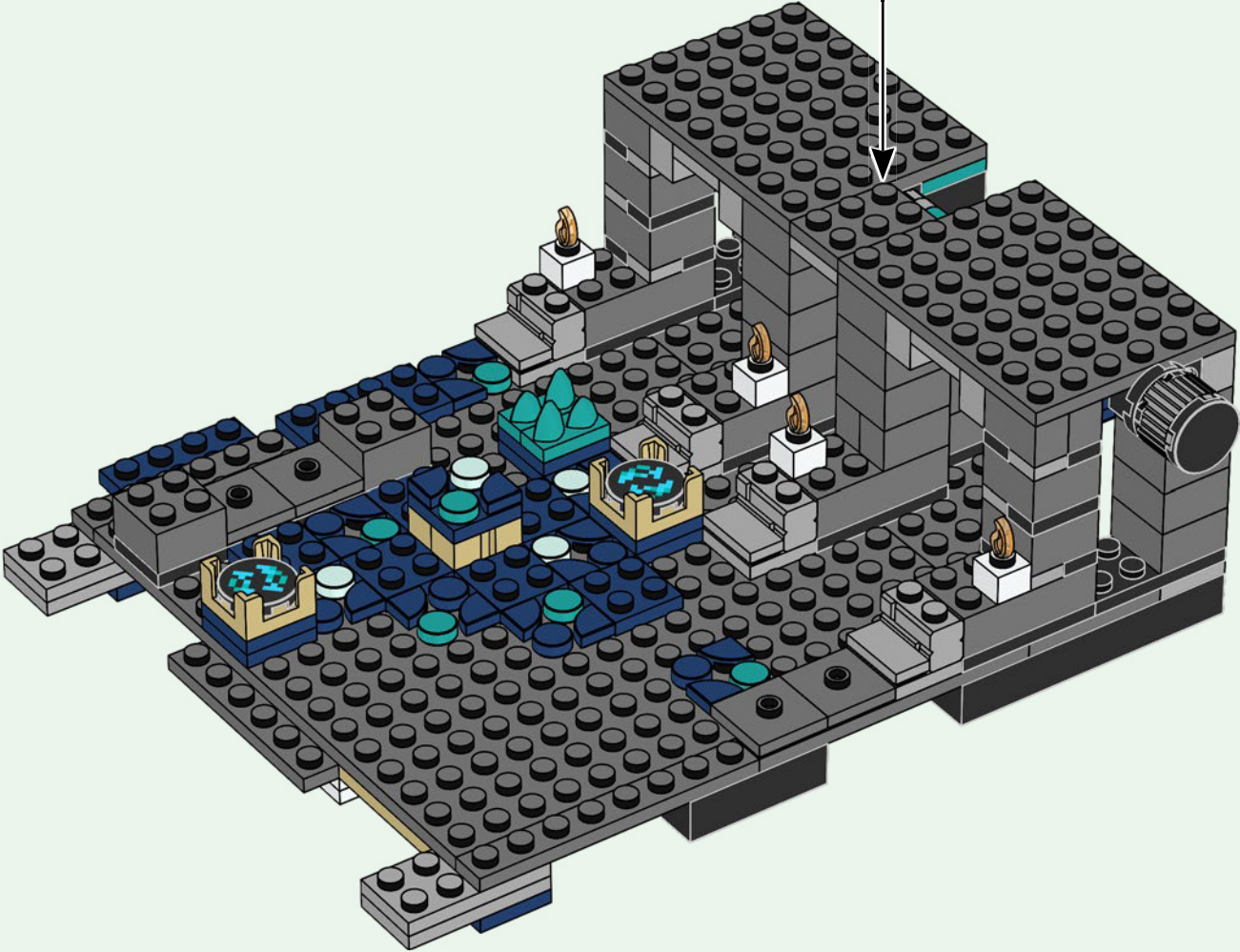

1x 4x 2x 2x

59

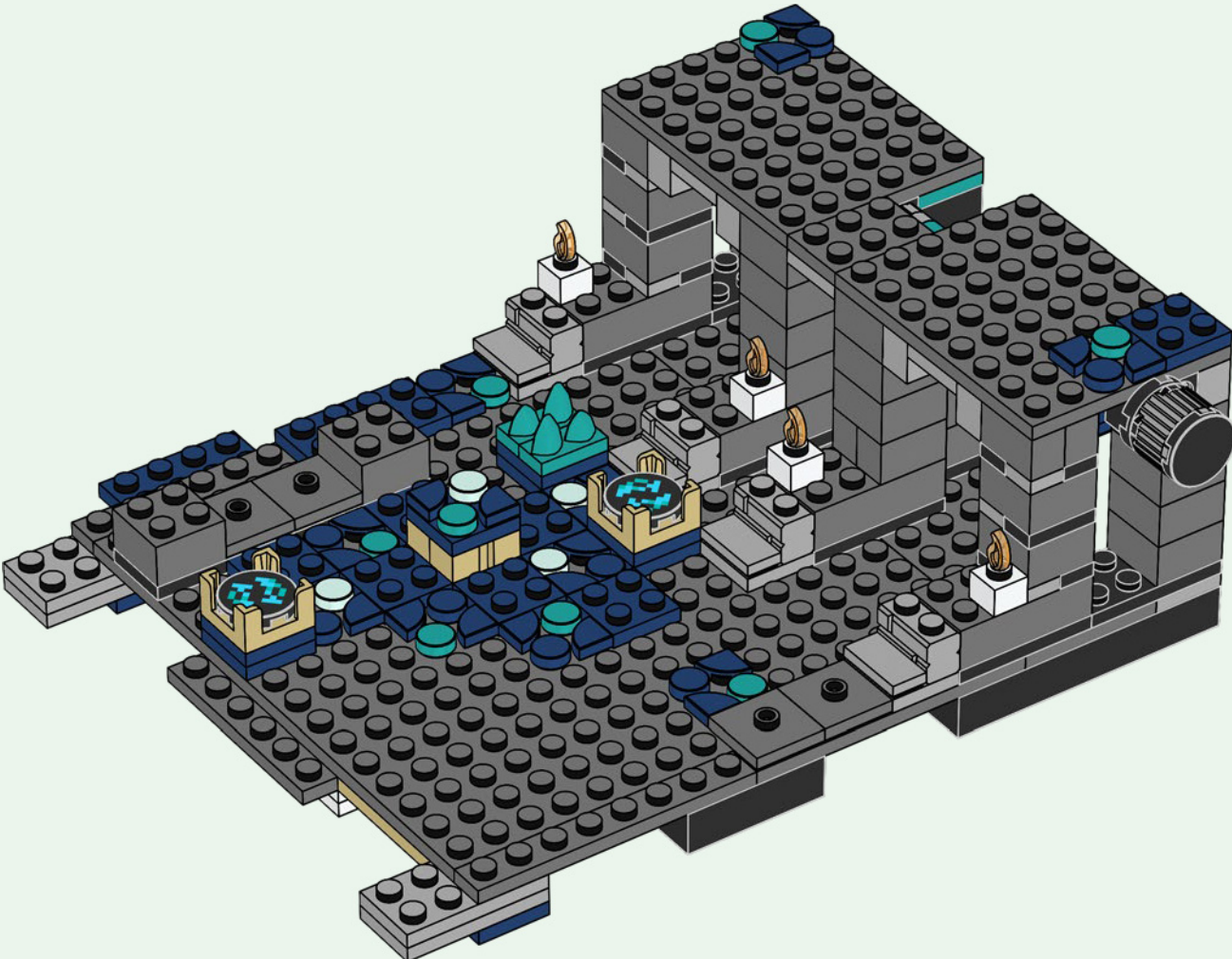

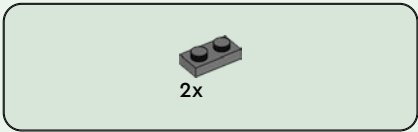

60

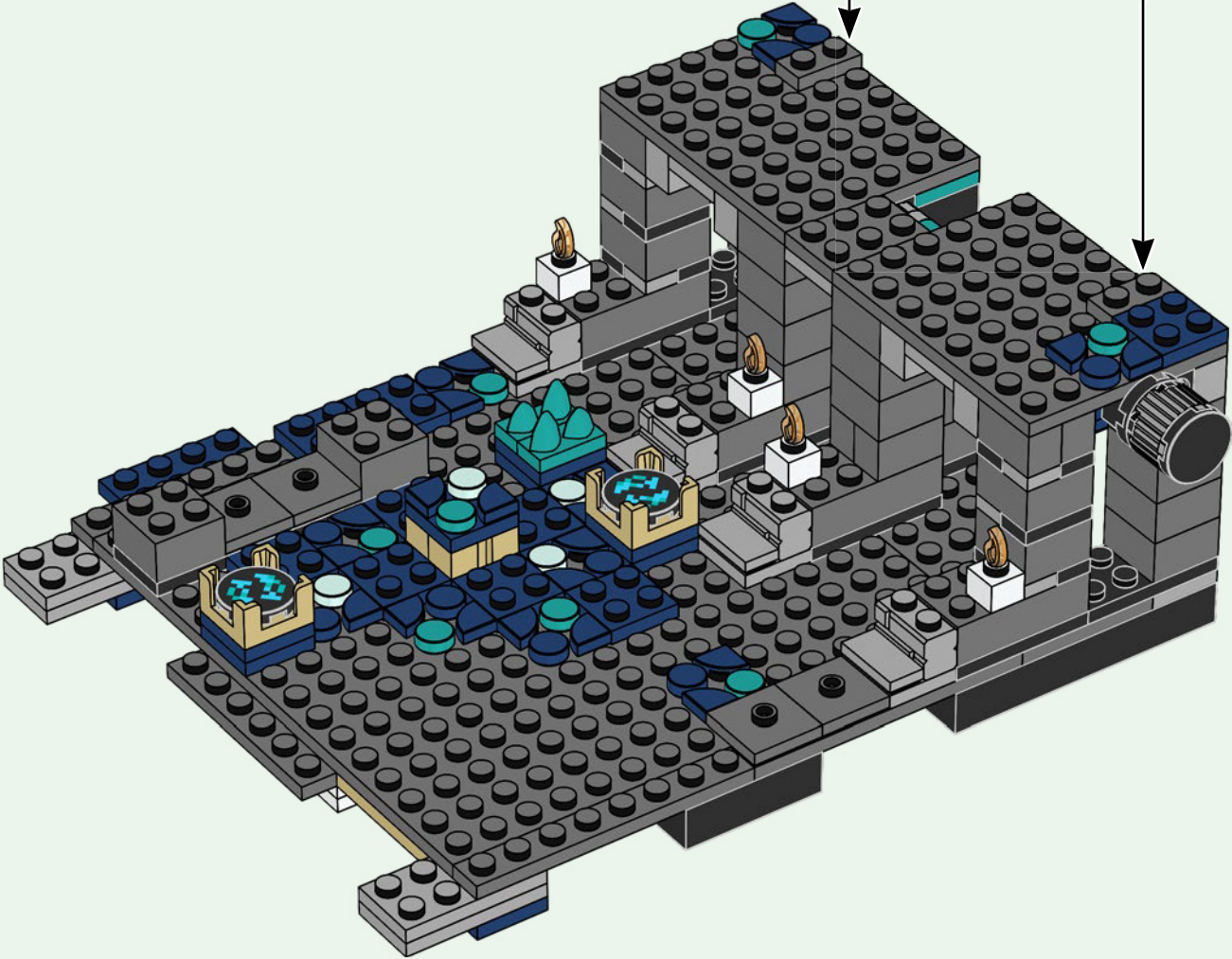
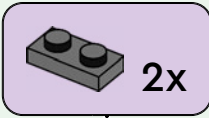

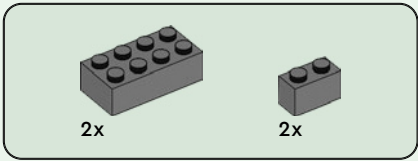

61

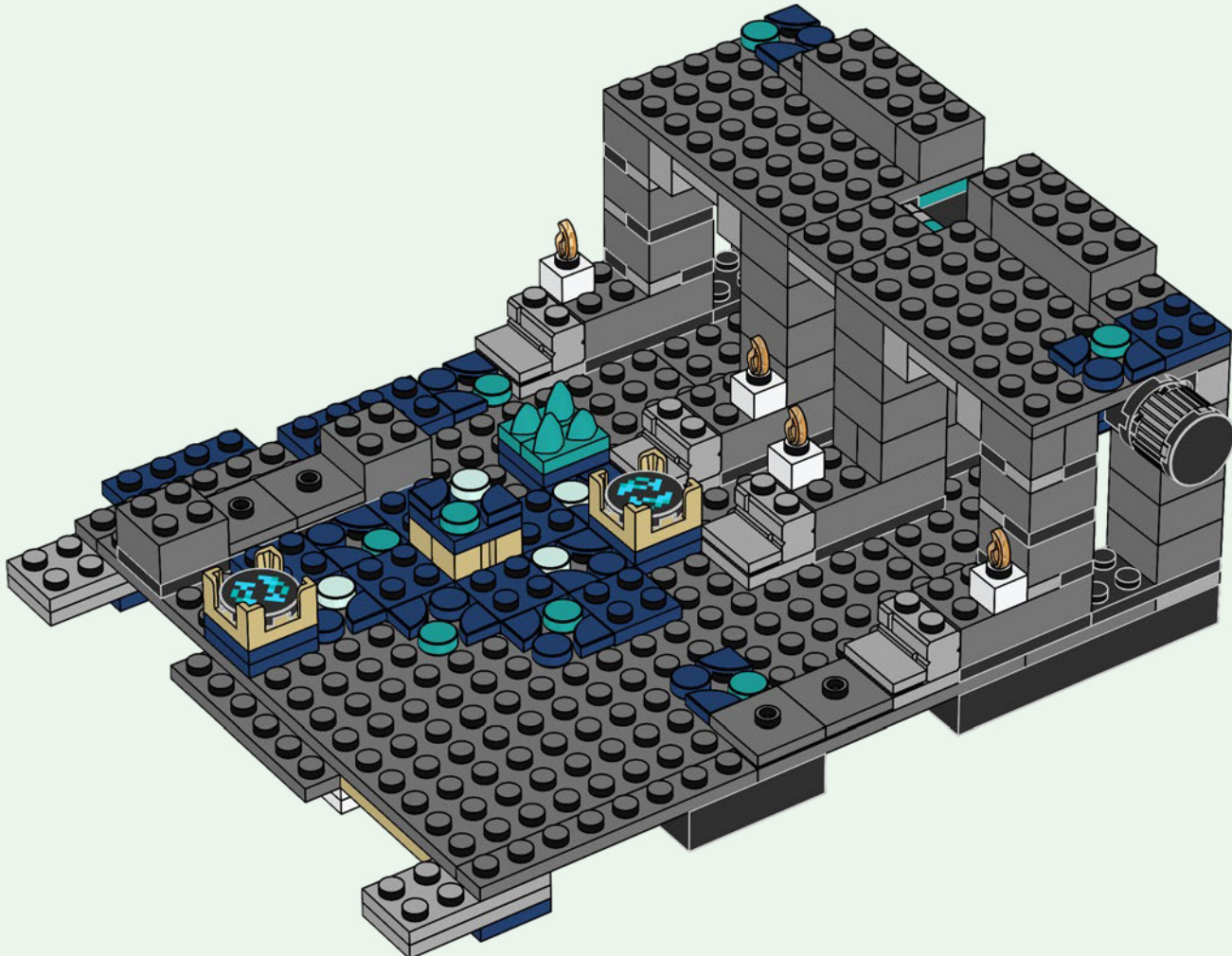

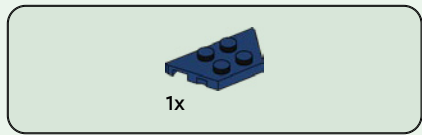

3

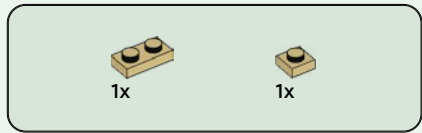
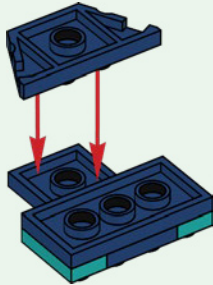

4

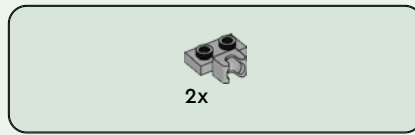
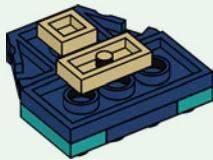

5

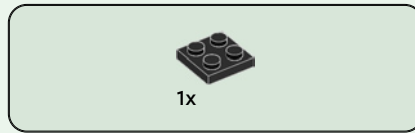
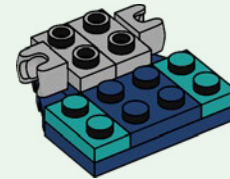

6

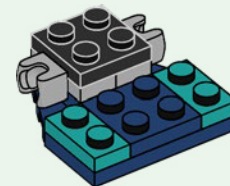

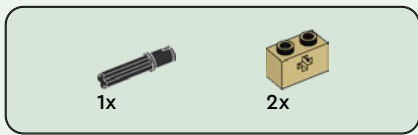

7

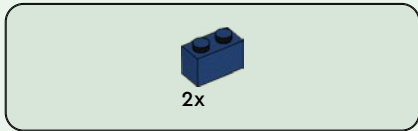
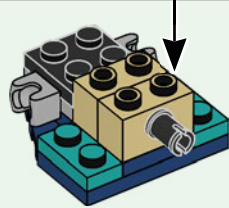
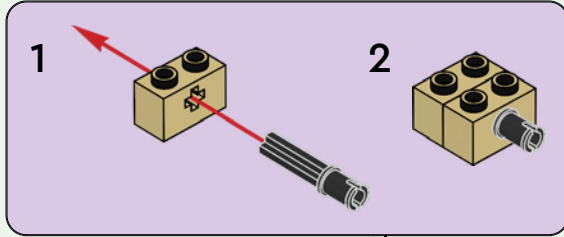

8

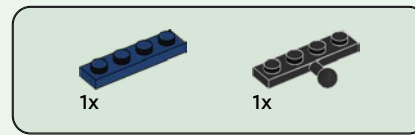

9

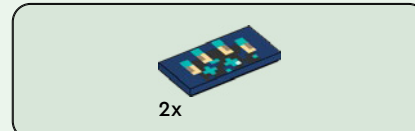

10

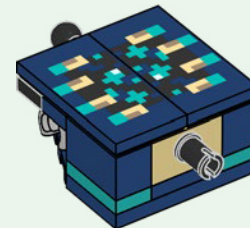

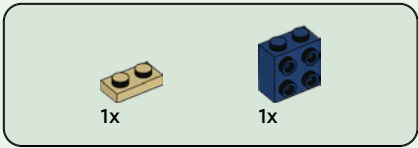

11

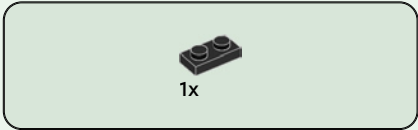
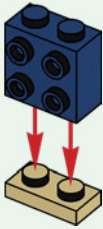

12

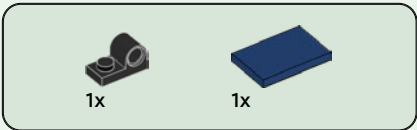
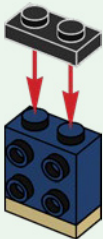

13

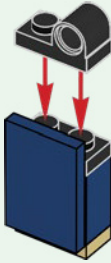

14

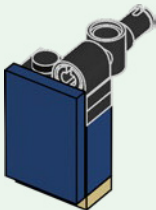

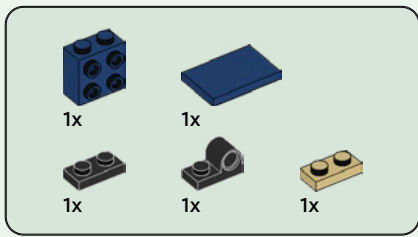

15

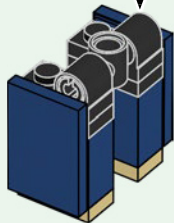
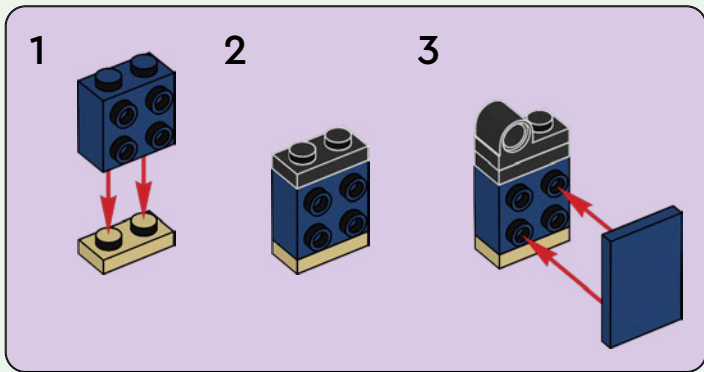

16

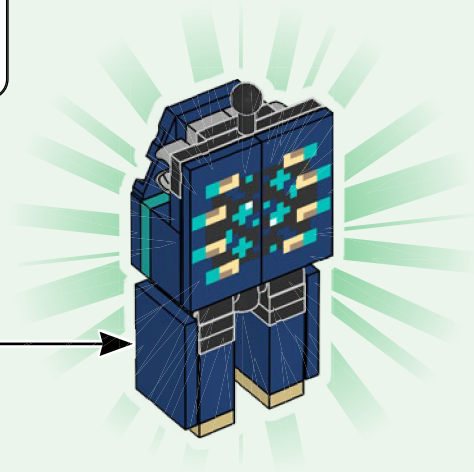
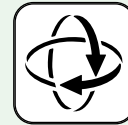



2x



1x



1x

17

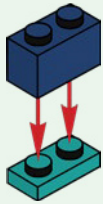

1x

18



1x



1x

19

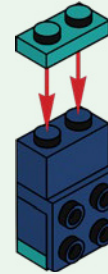

1x

20



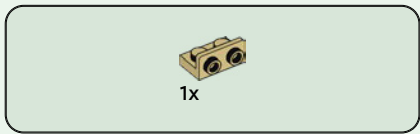

21

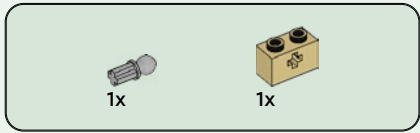
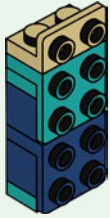

22

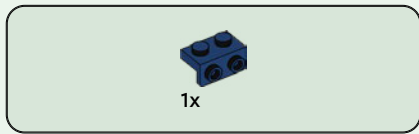
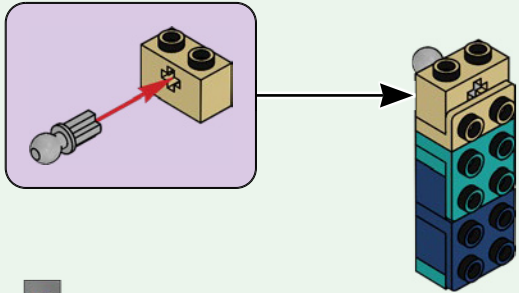

23

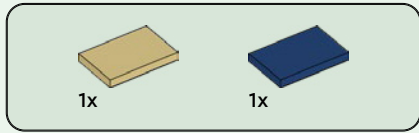
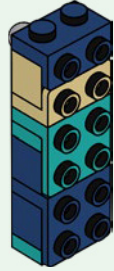

24

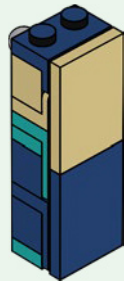

2x



25

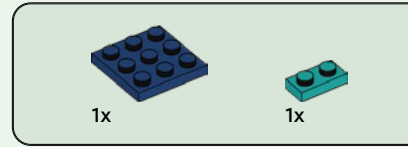
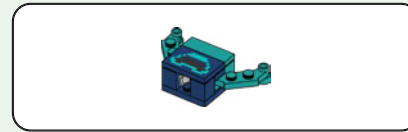
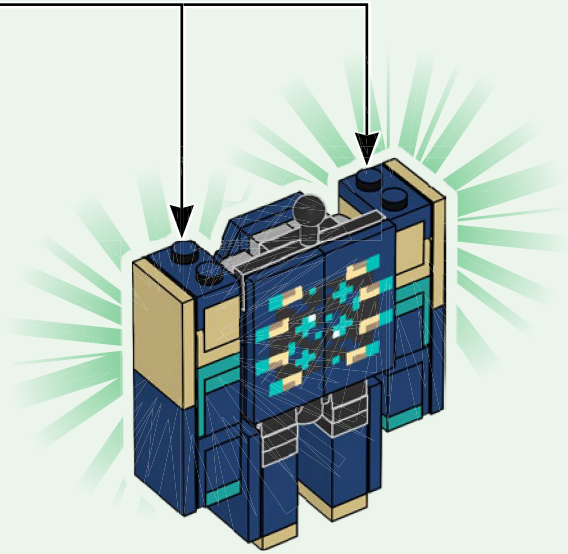

26

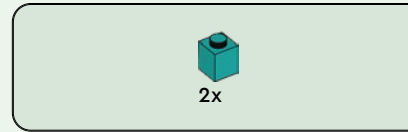
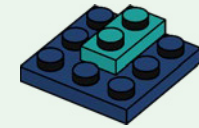

27

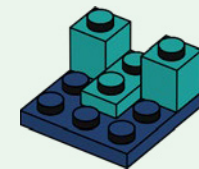

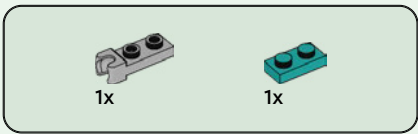

28

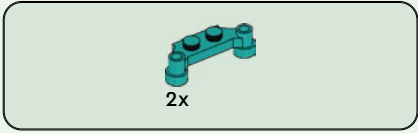
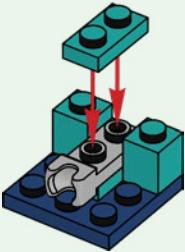

29

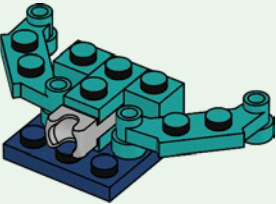

30

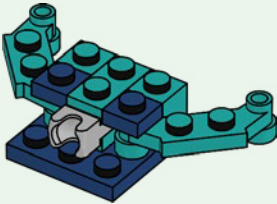

31

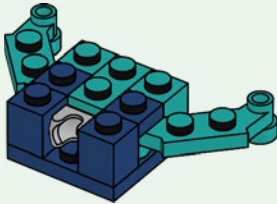

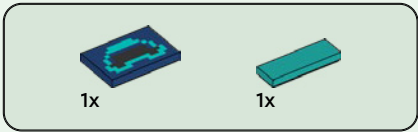

32

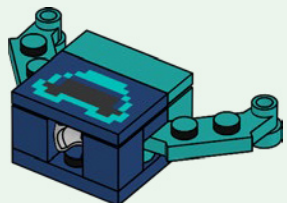

33

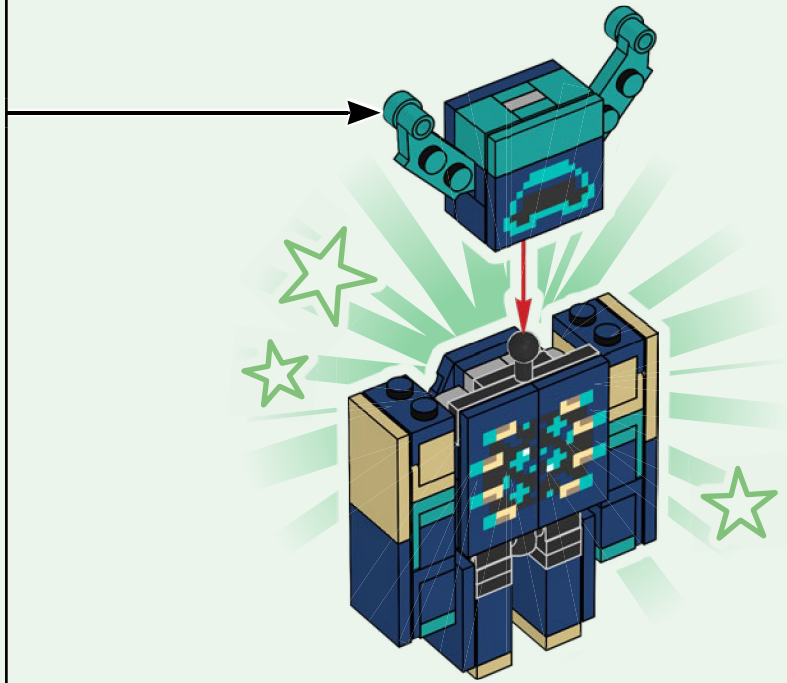



2x

62

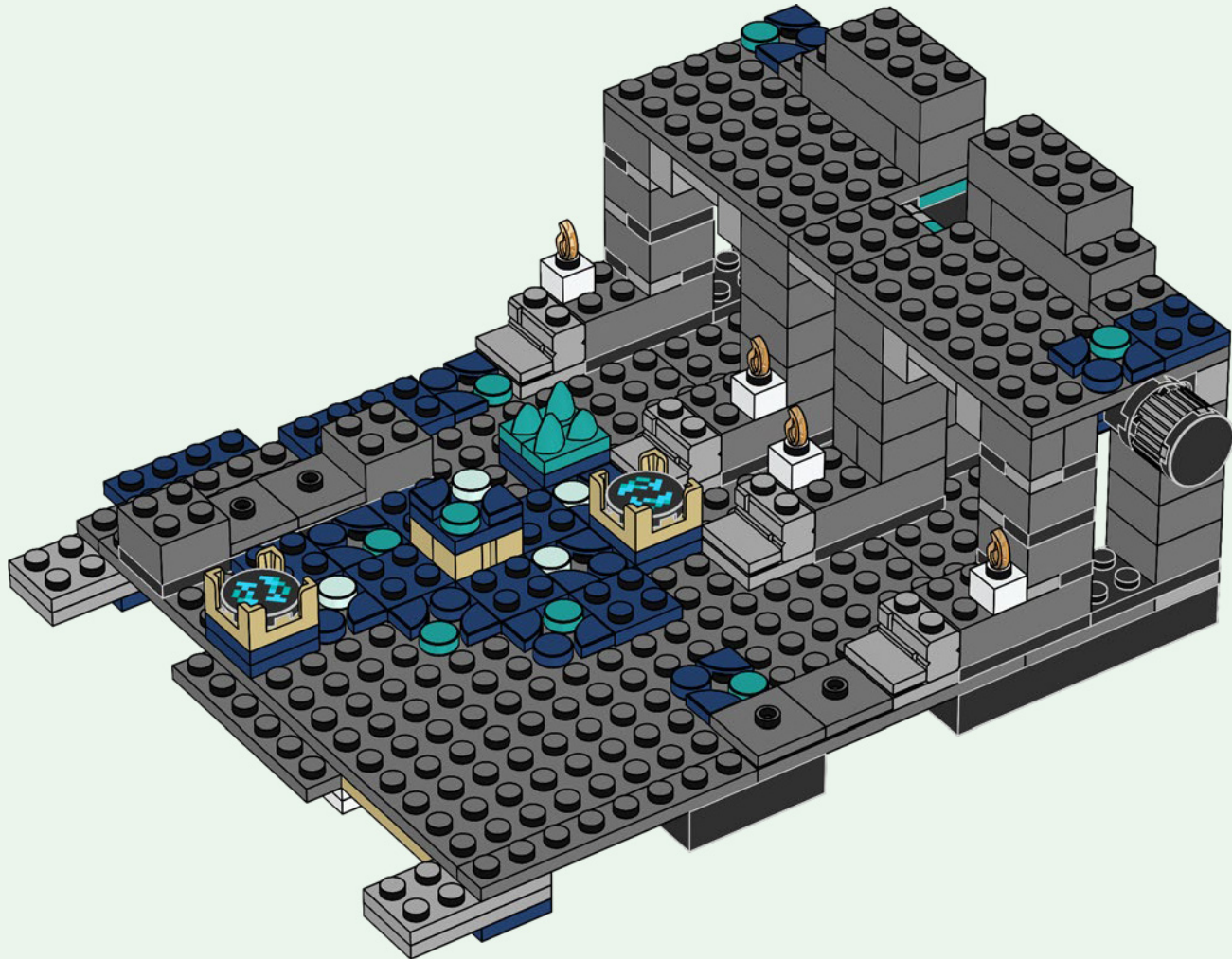



2x



2x

63

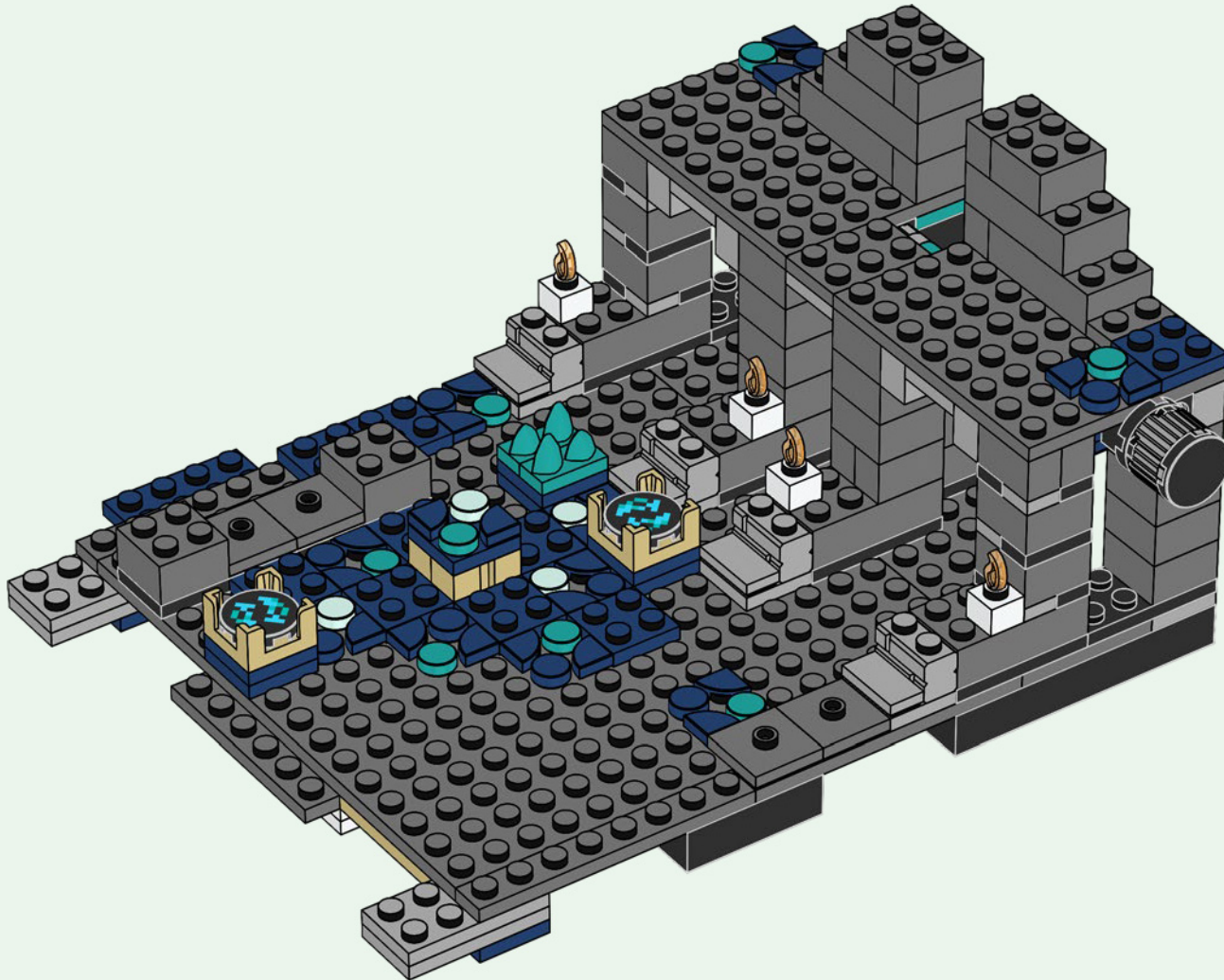

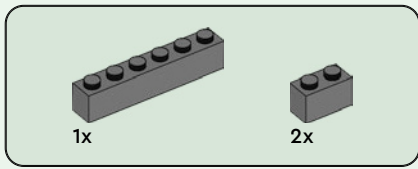

64

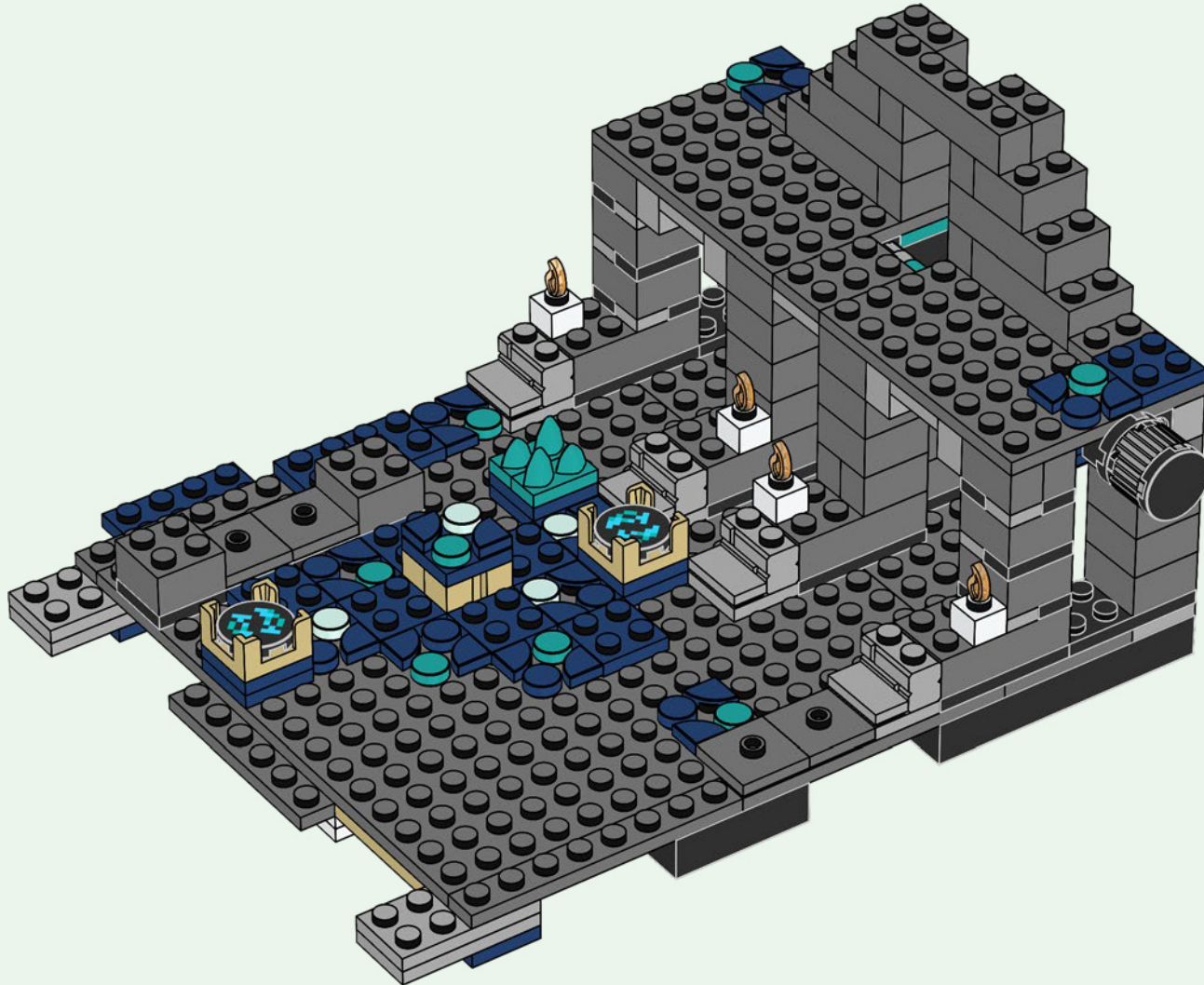



3x

65

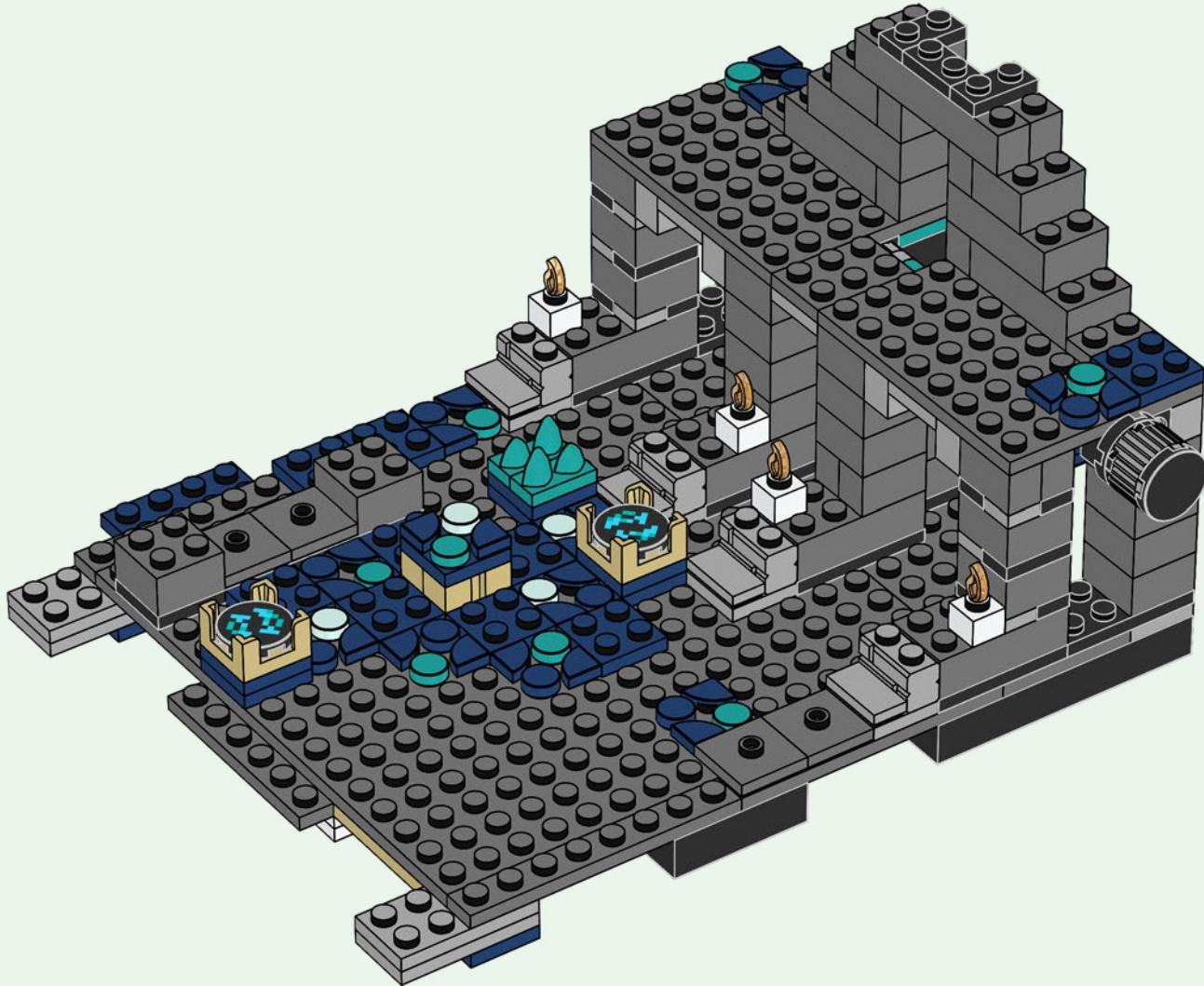

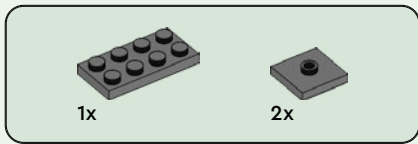

66

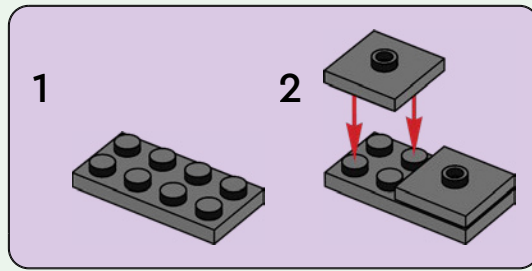



3x

67

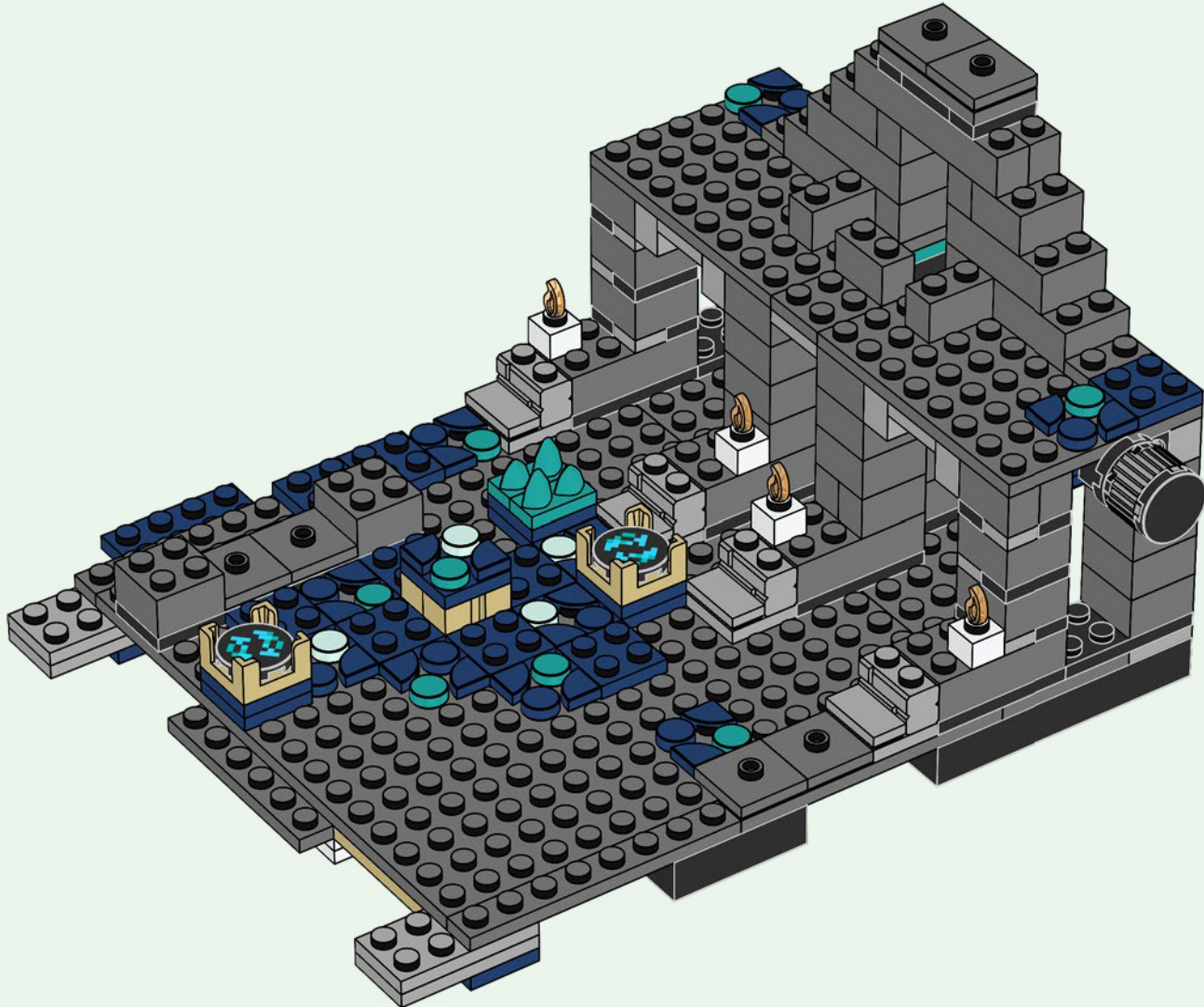

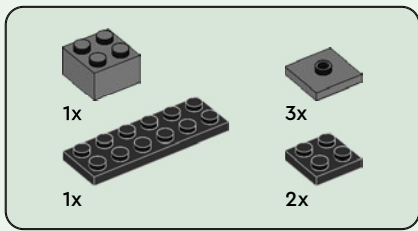

68

1

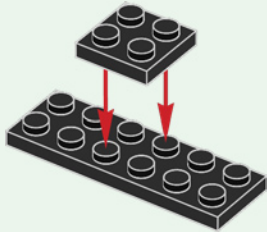

2



3

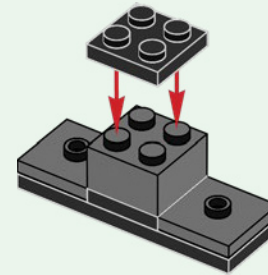

4

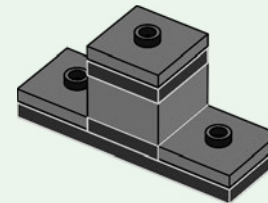

69

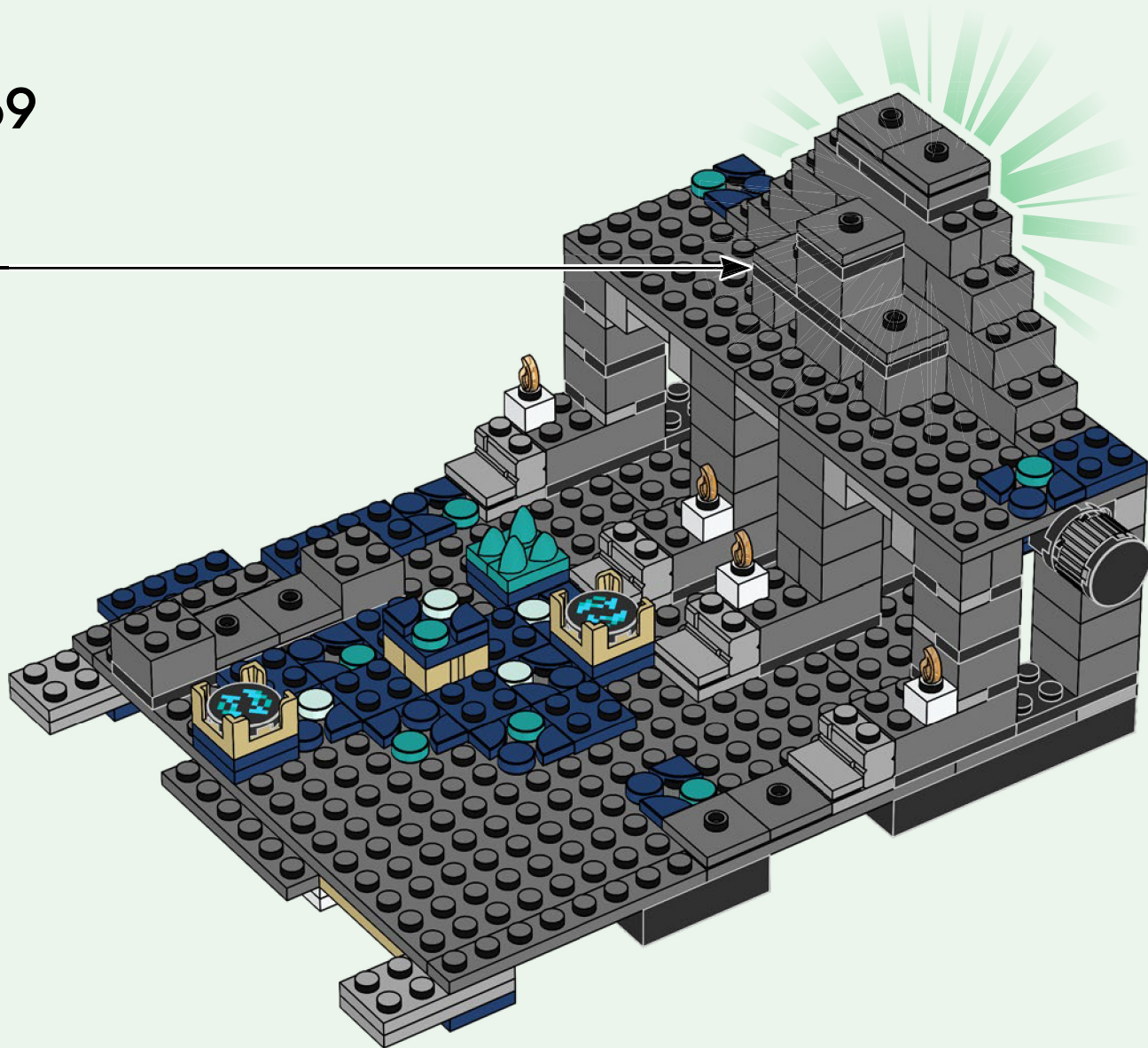





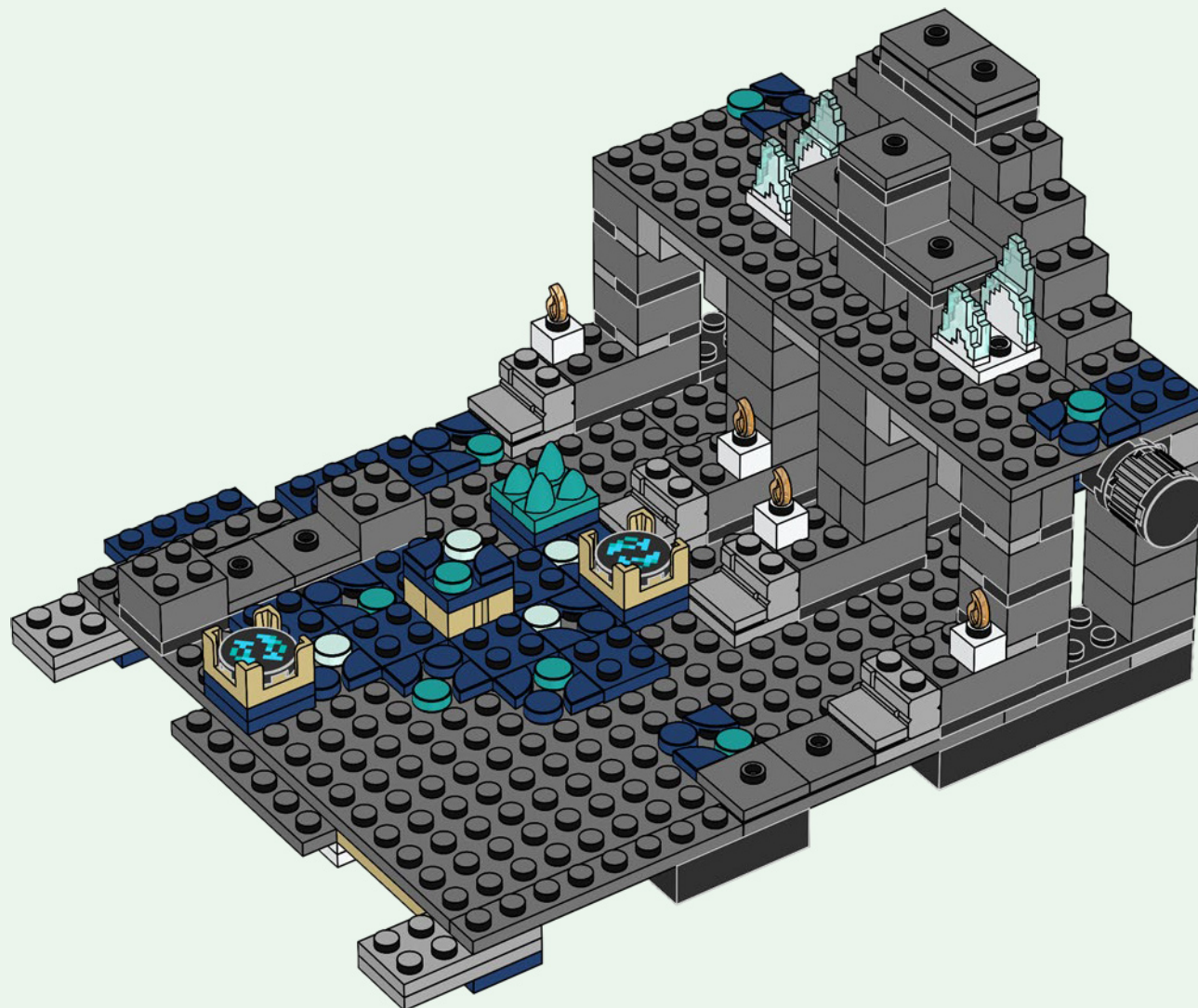

2x

70



4x  4x 

71

  4x

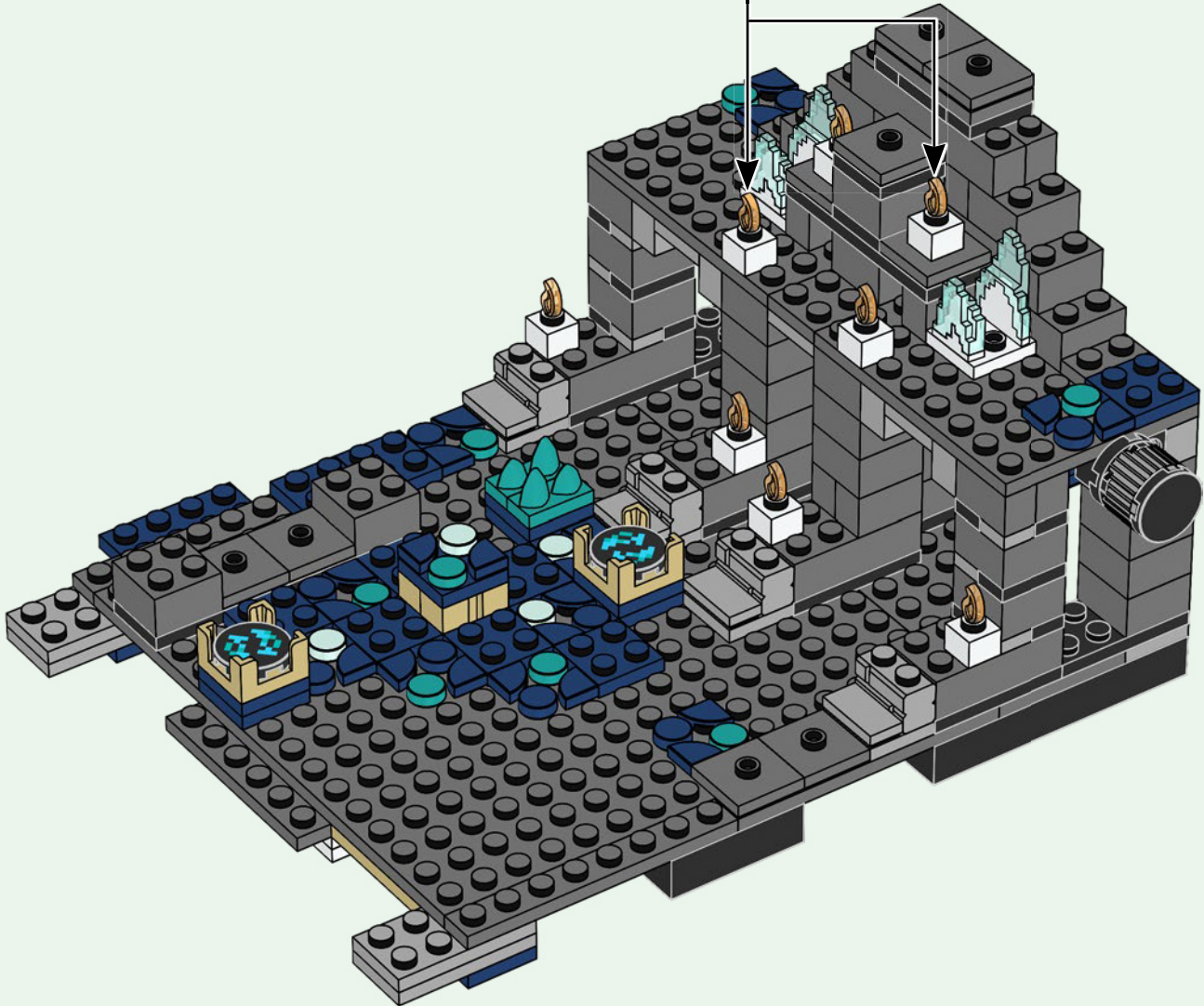

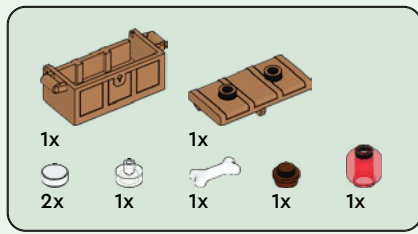

72

1

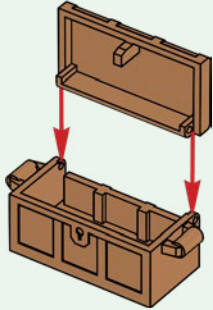

2

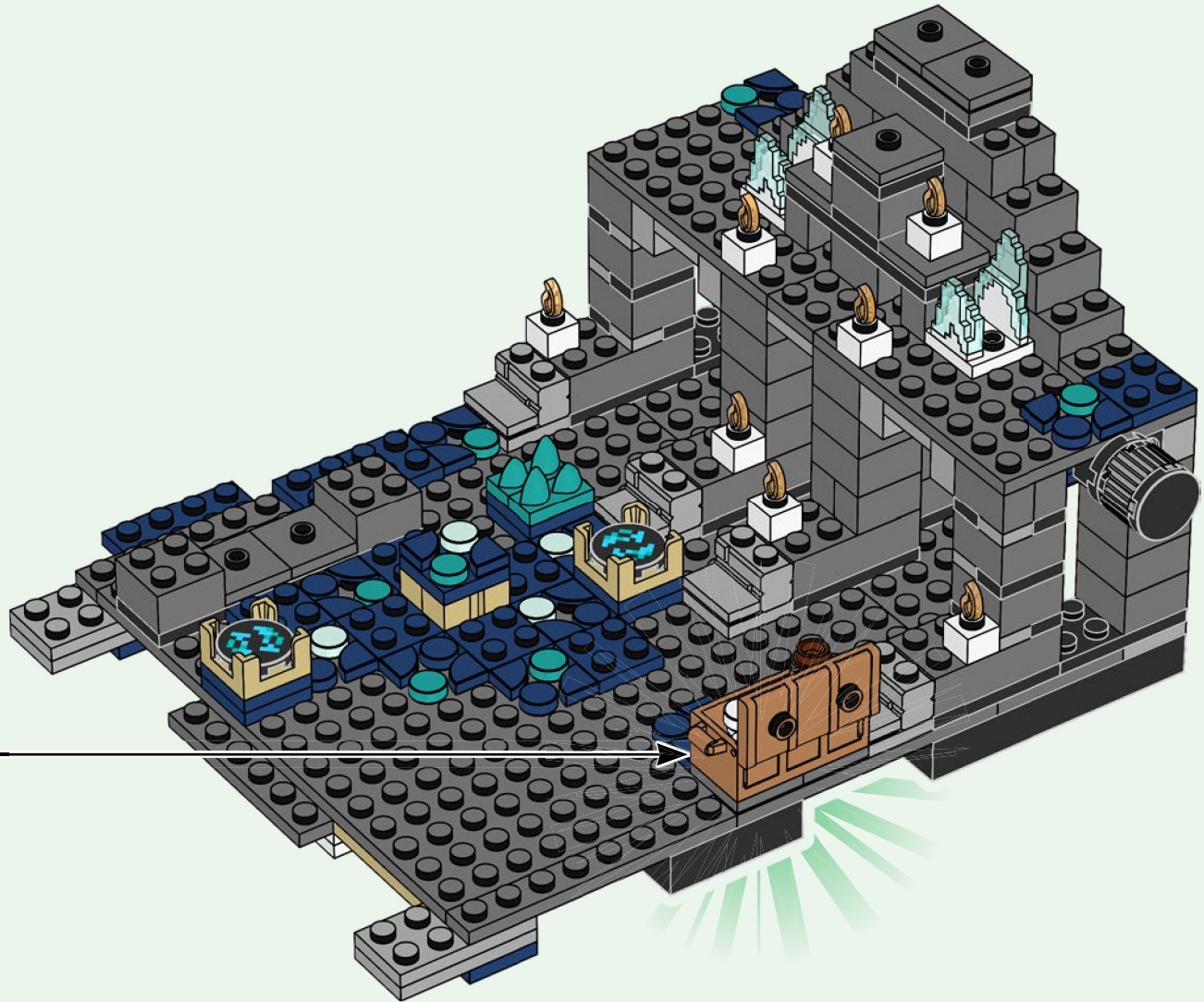
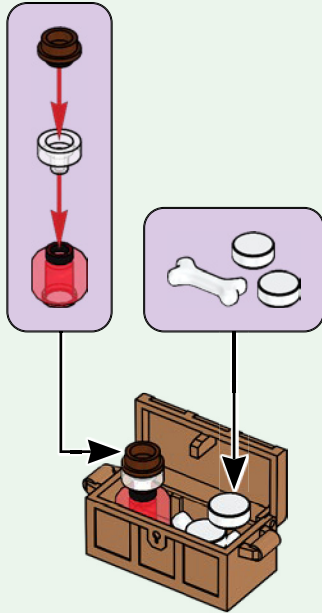

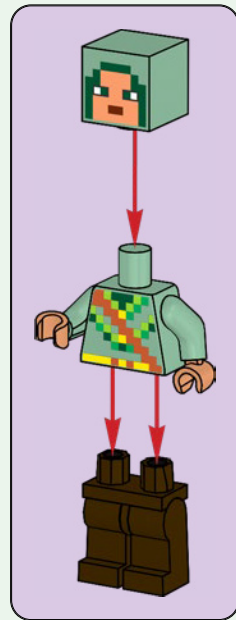

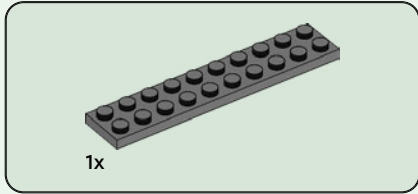
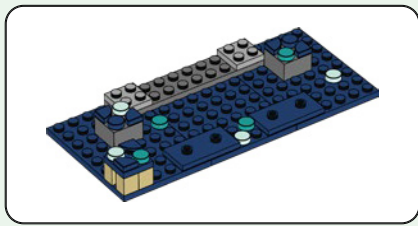

73

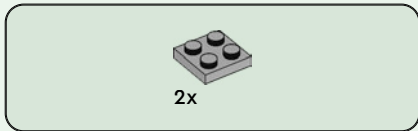
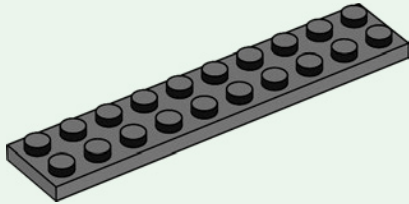

74

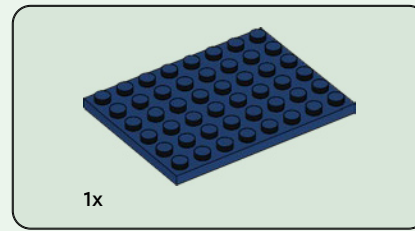
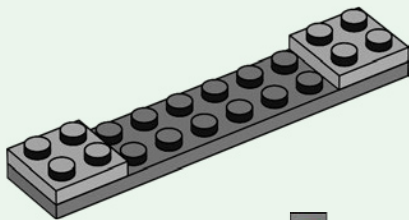

75

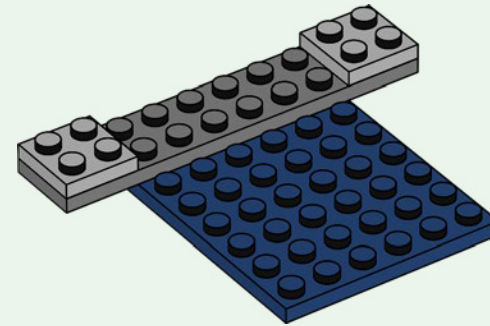

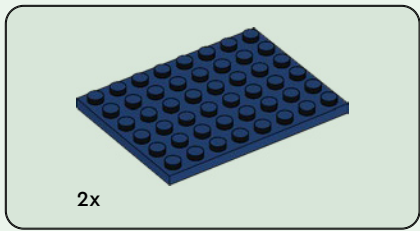

76

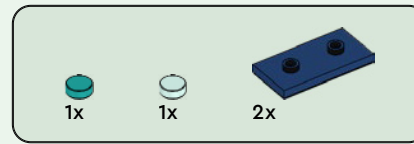
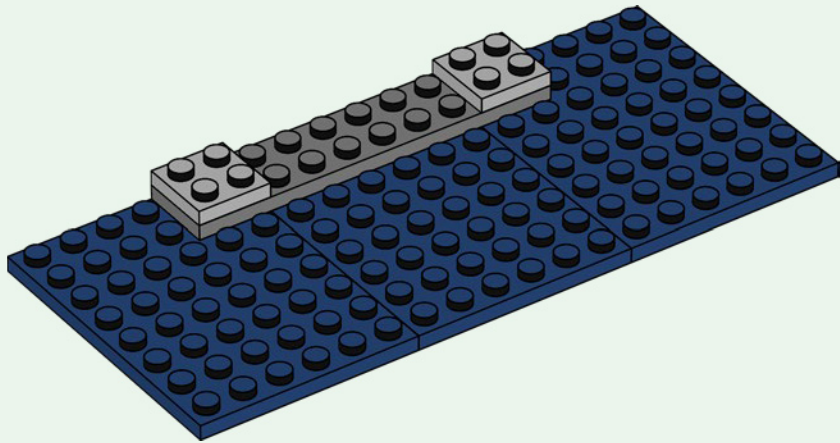

77

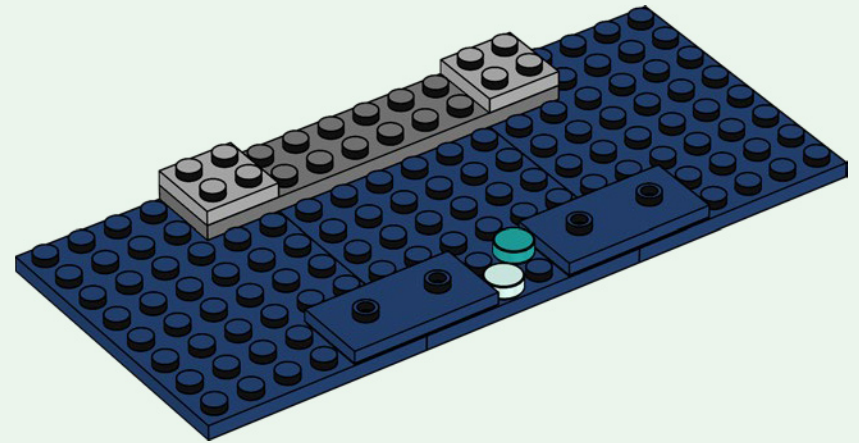

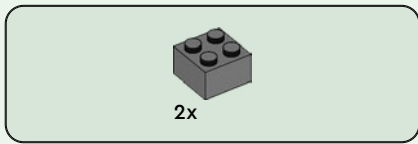

78

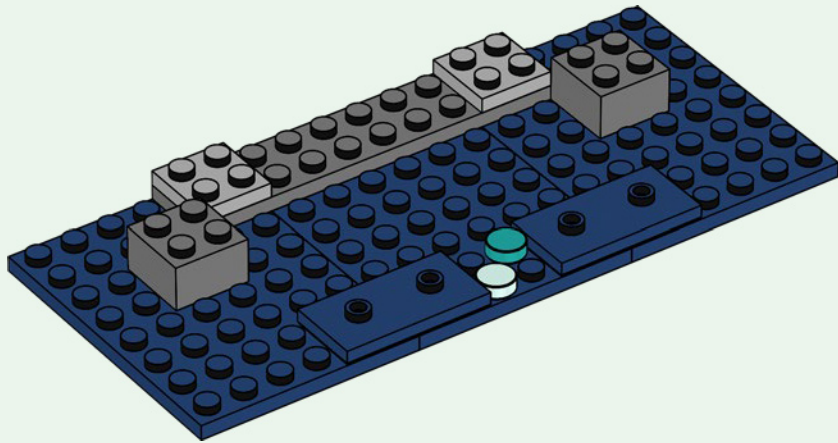

79

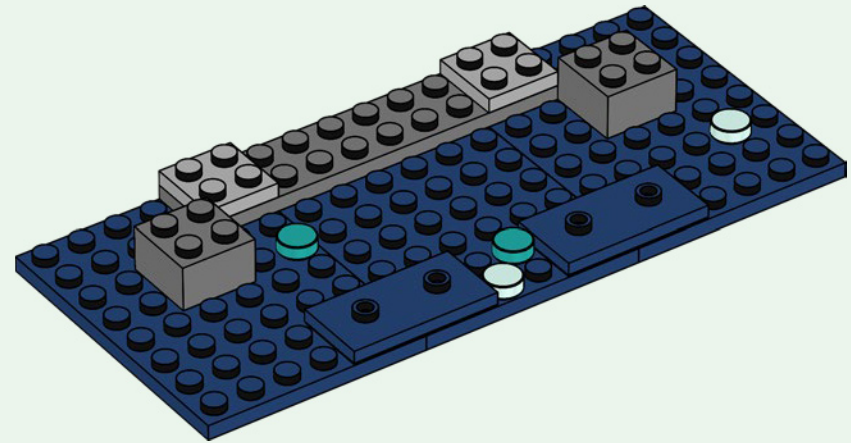

82

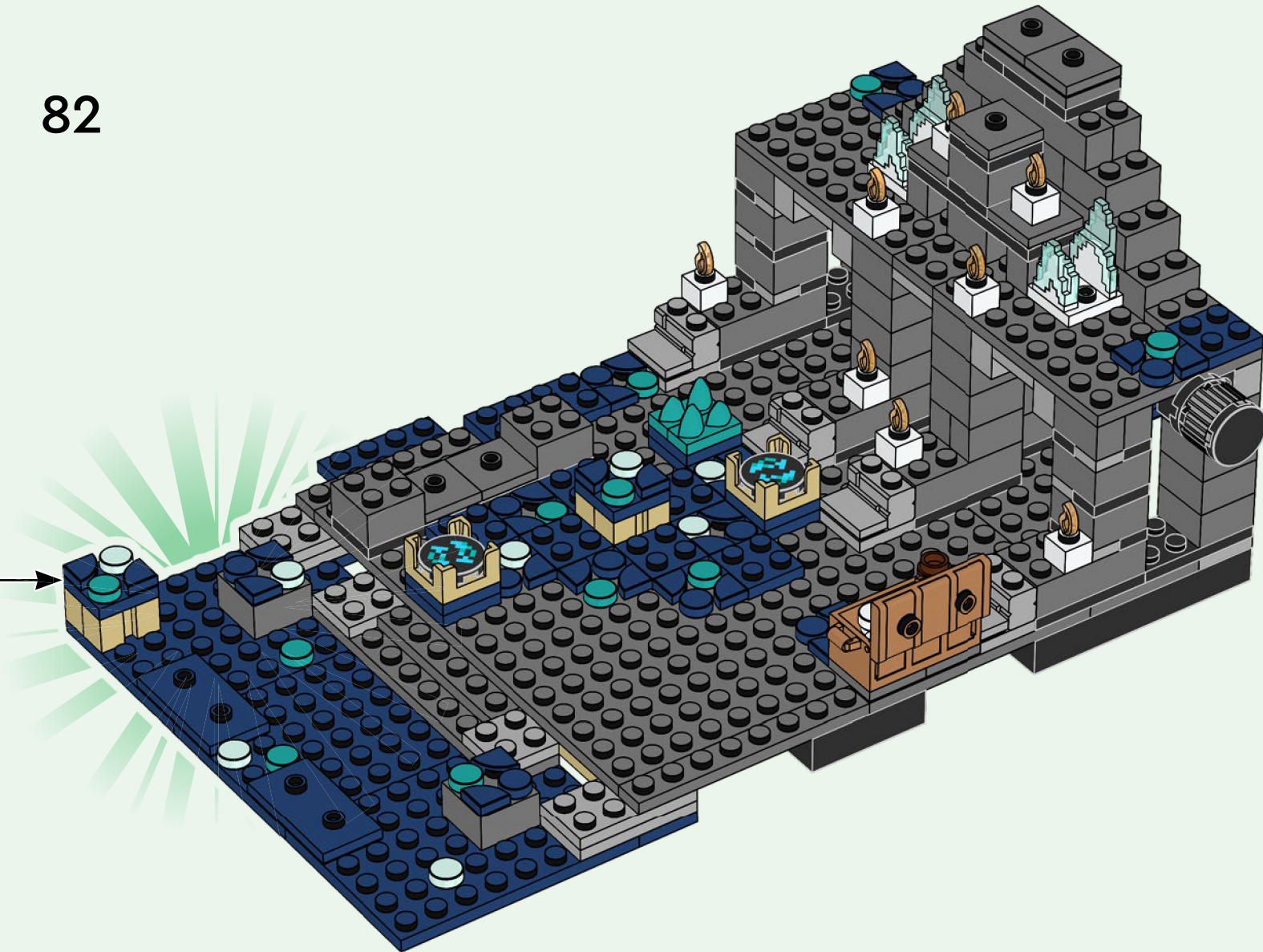

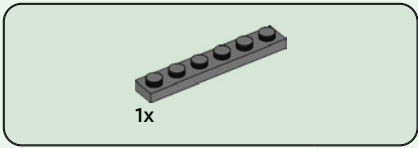

83

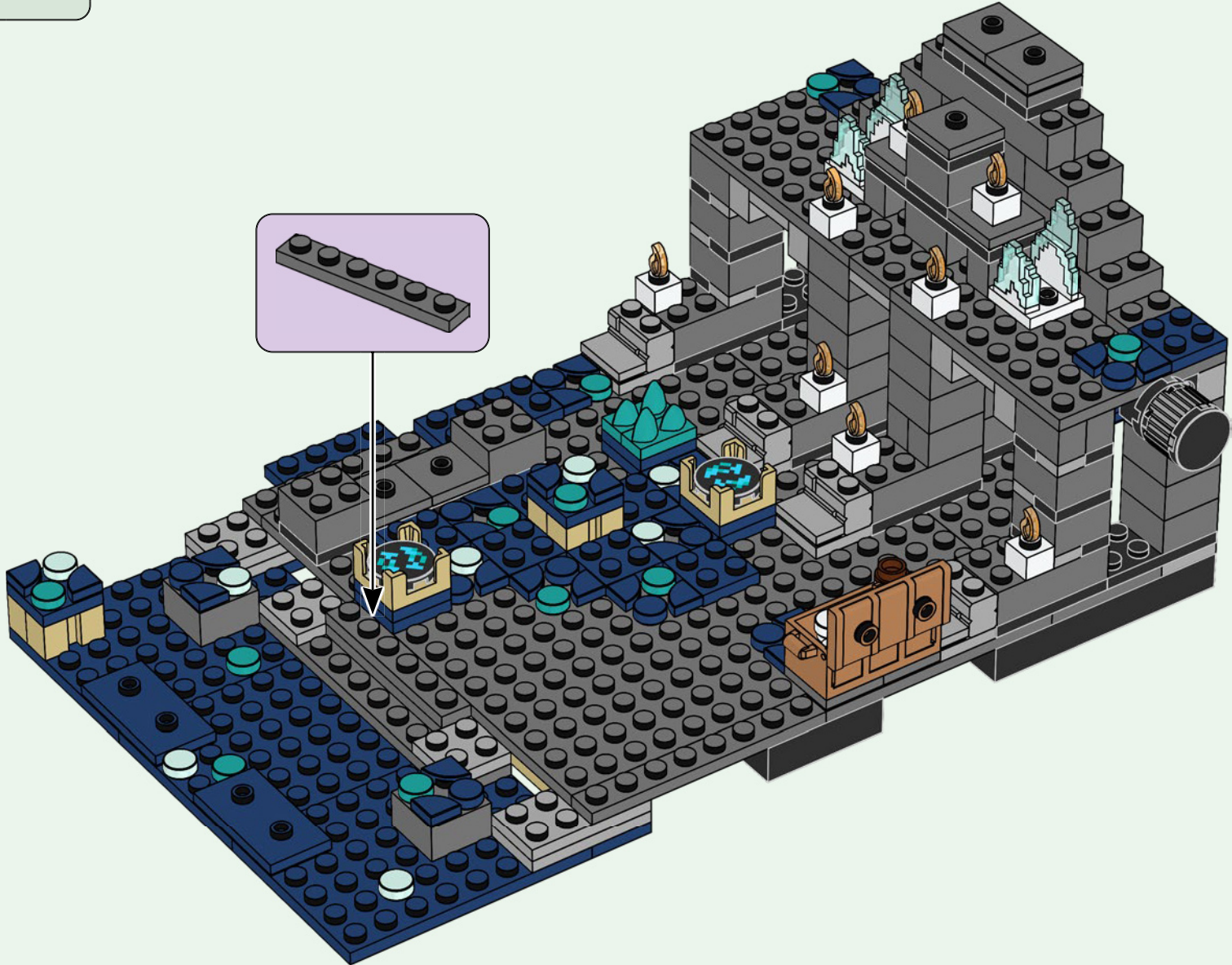

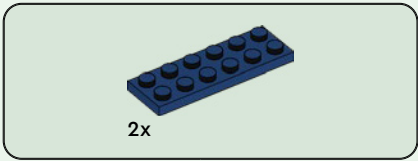

84



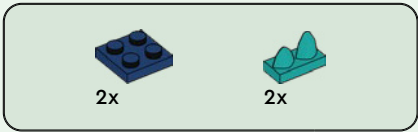

85

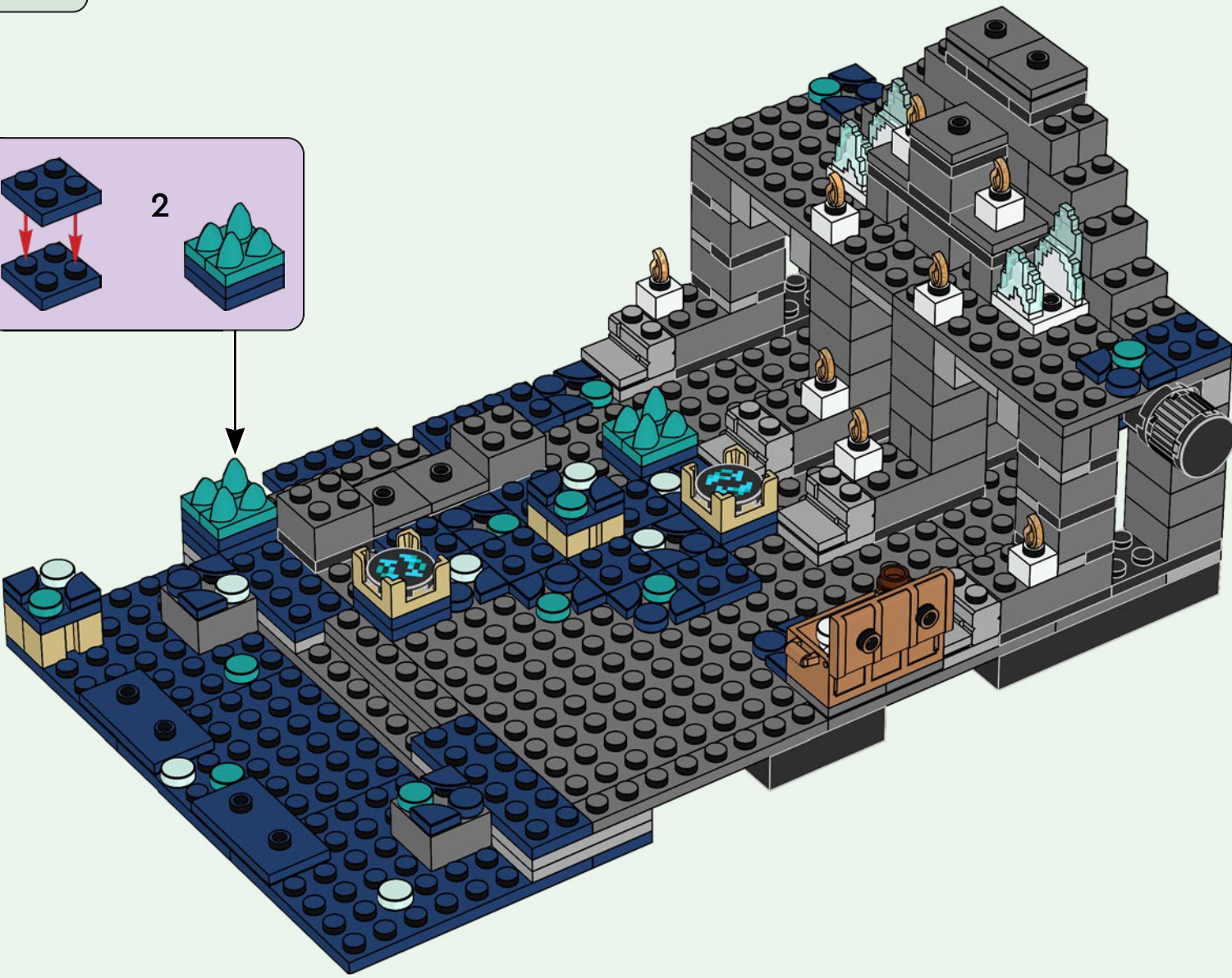
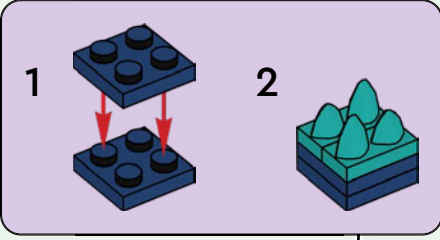

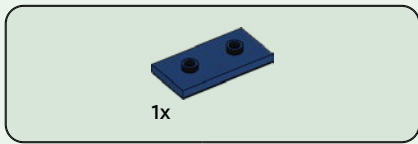

86



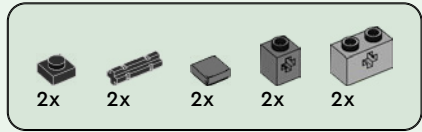
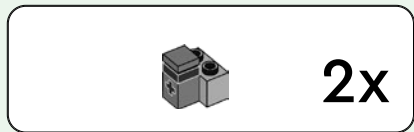

87

1

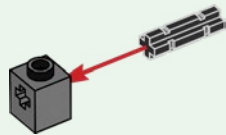

2



3

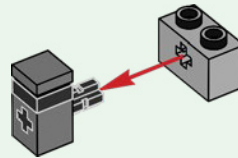

4



2x





2x

88

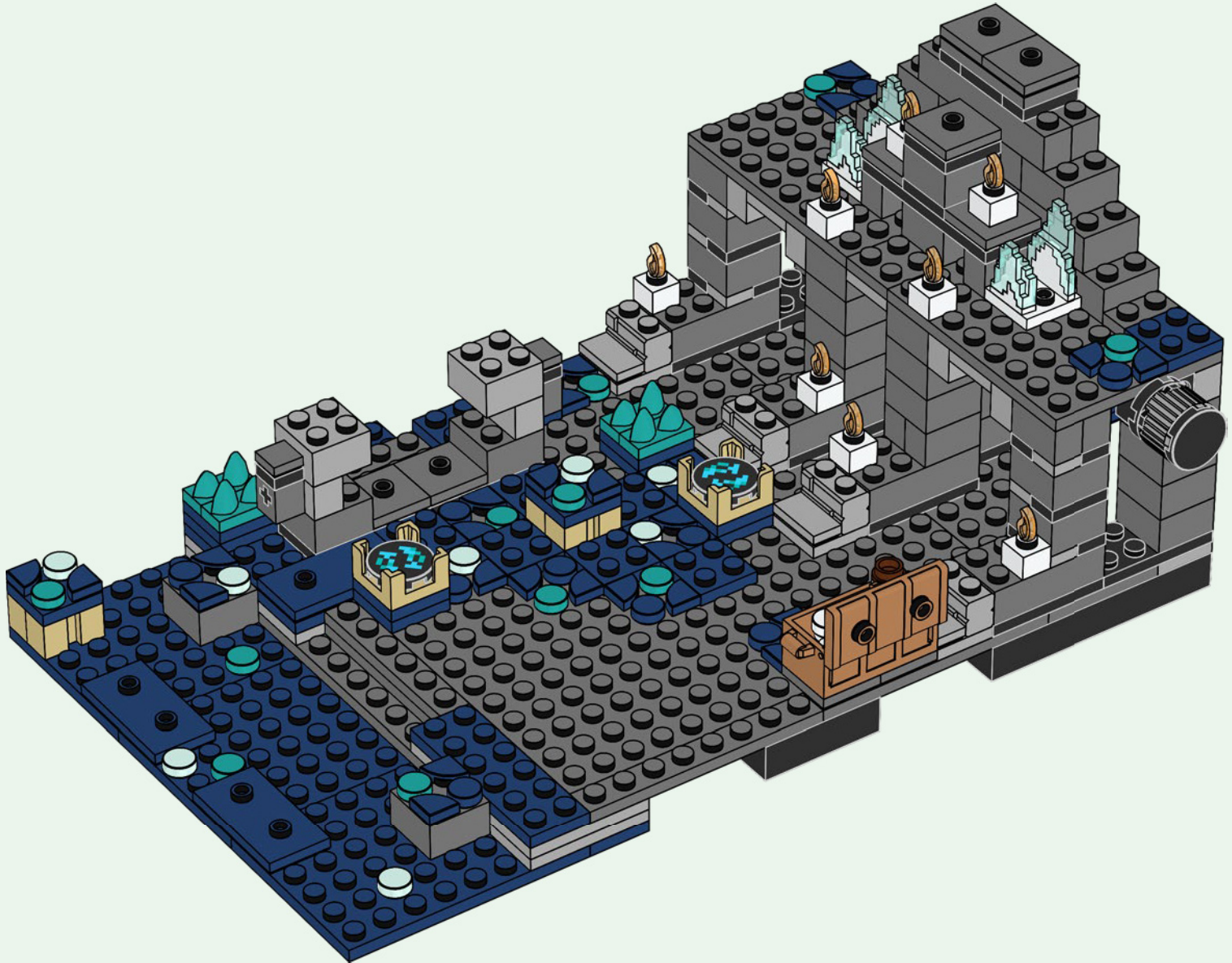

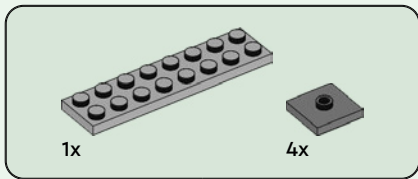

89

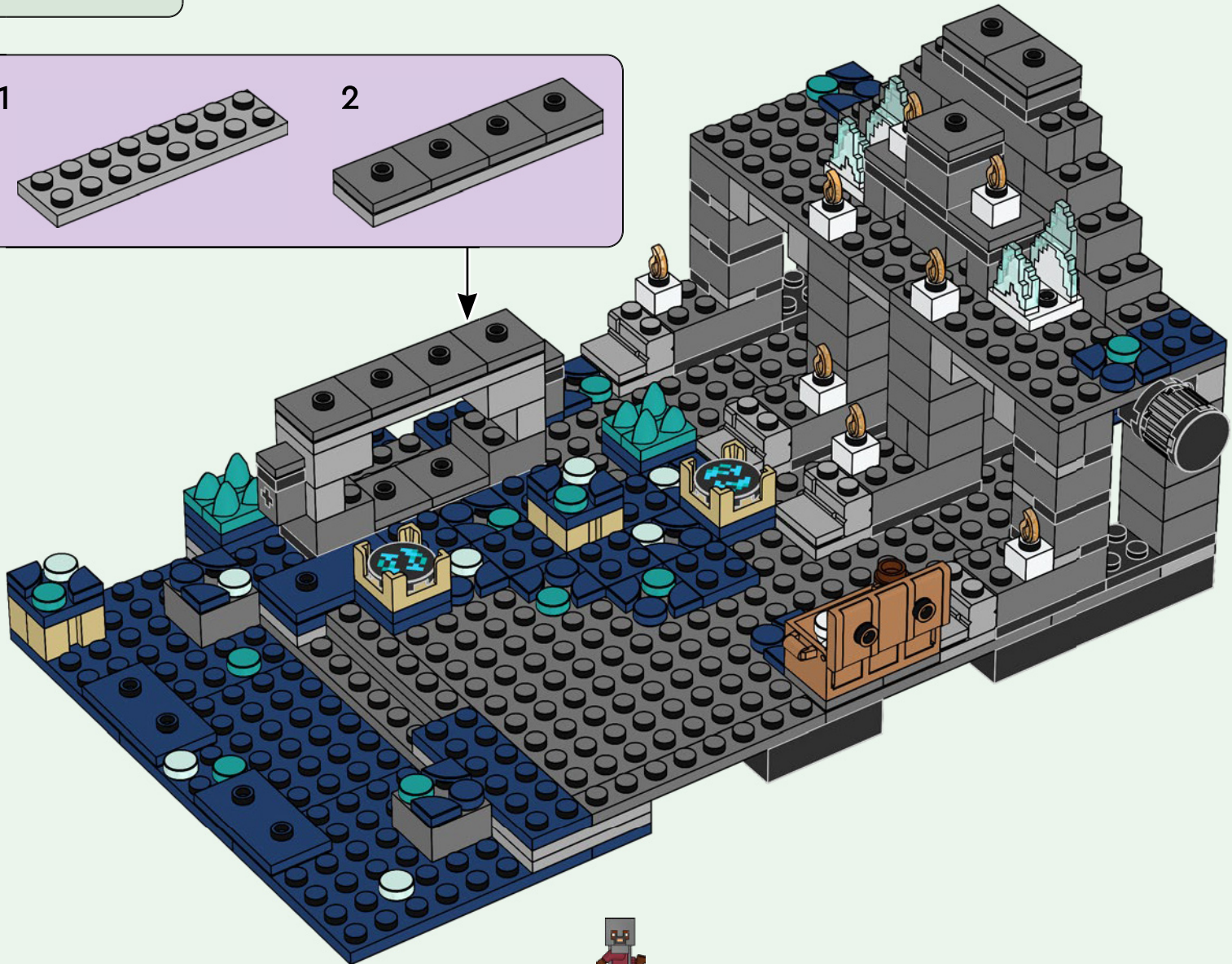
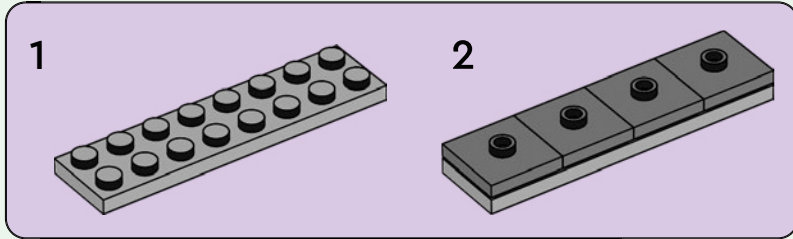

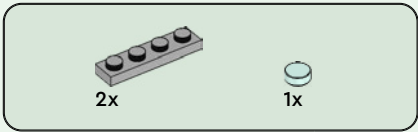

90



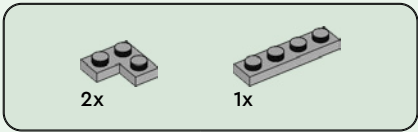

91



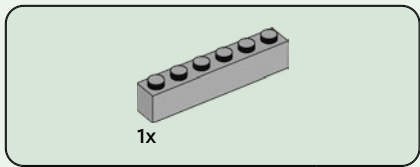

92

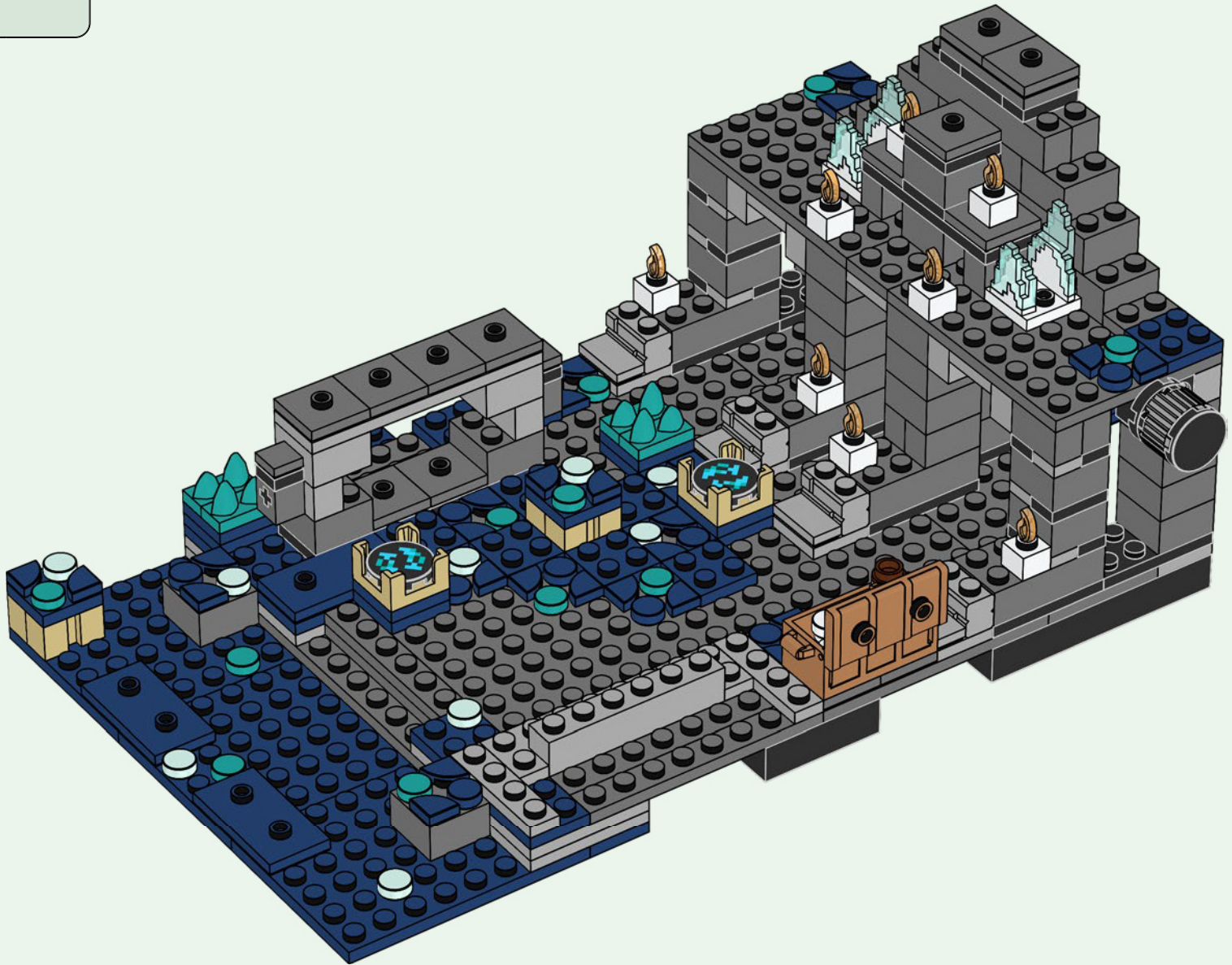

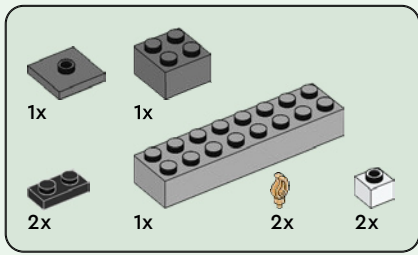

93

1

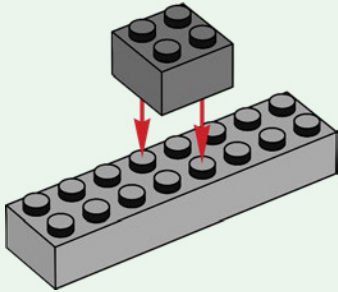

2

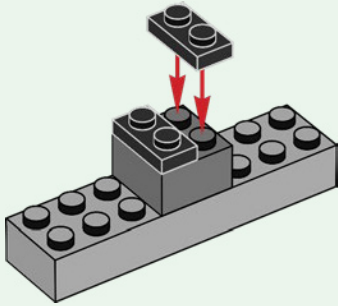

3

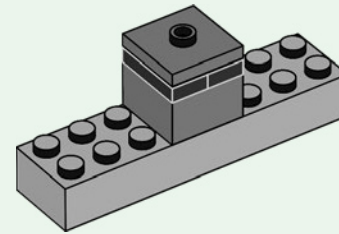

4

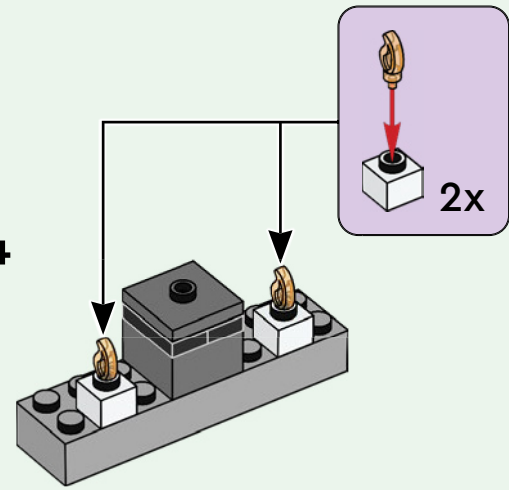



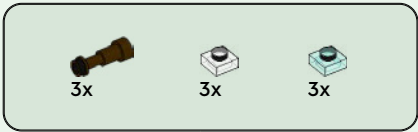

94

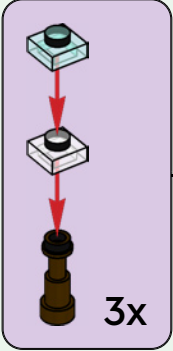

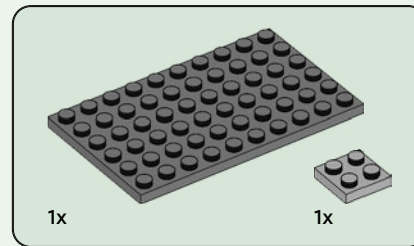
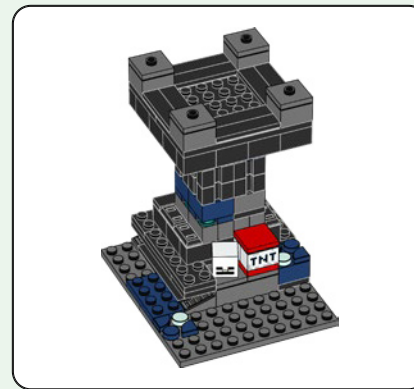

95

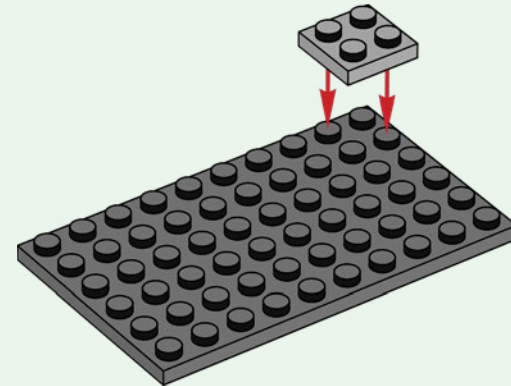

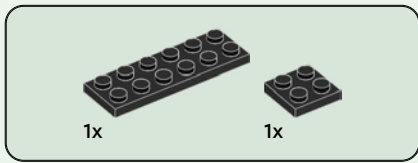

96

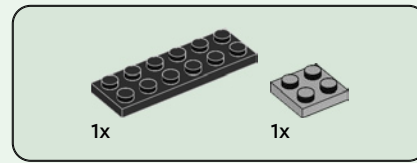
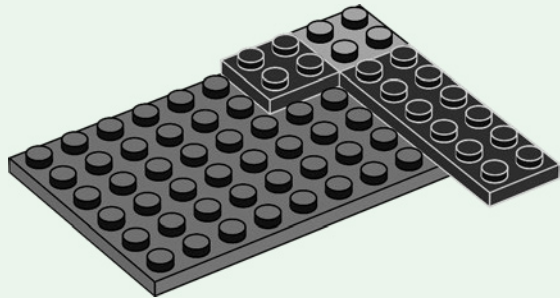

97

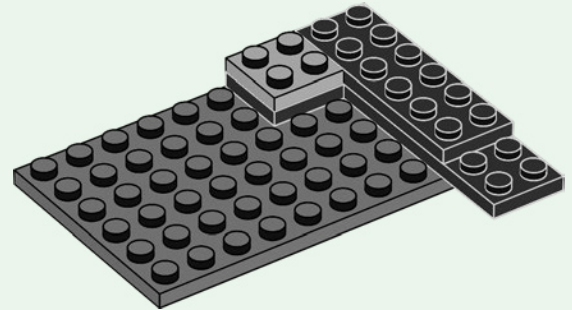



98

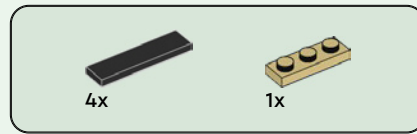
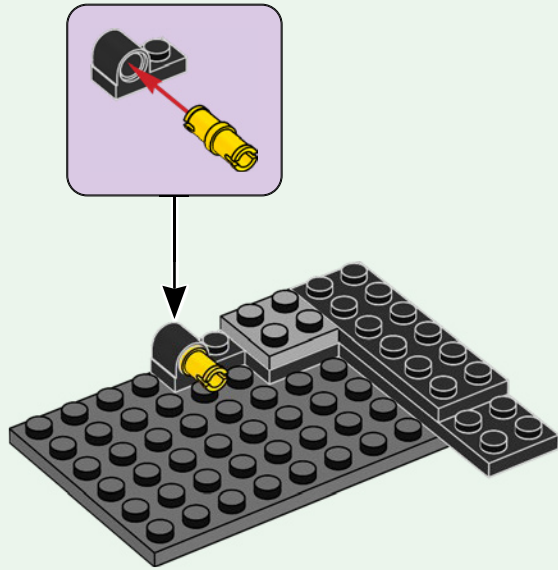

99

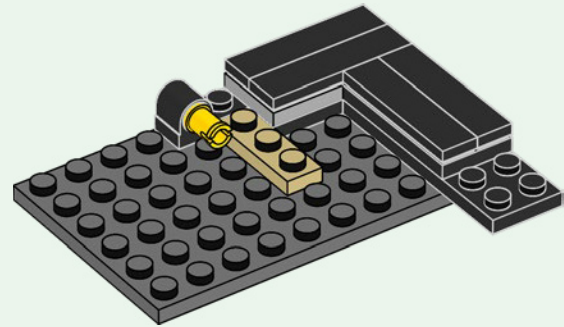

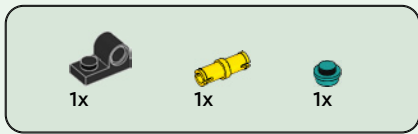

100

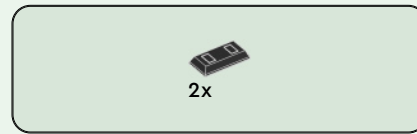
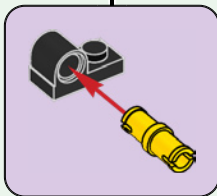
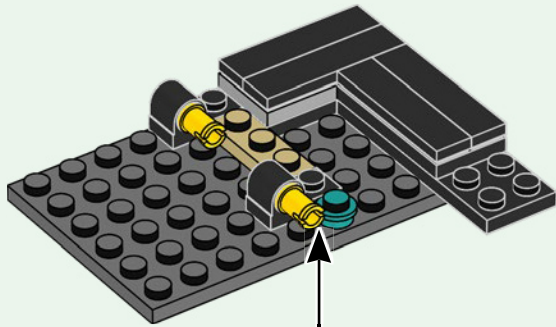

101

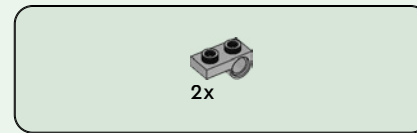
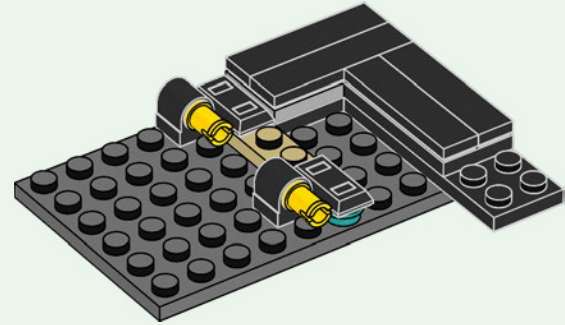

102

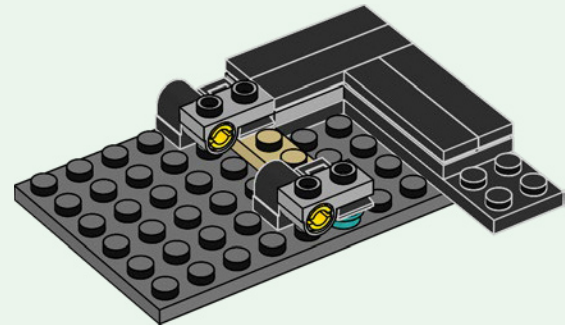

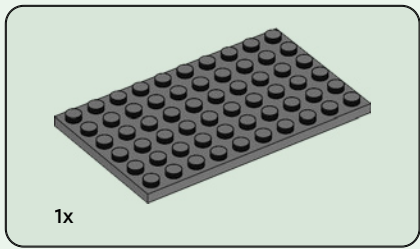

1x

103

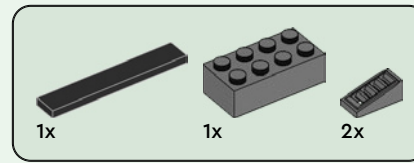
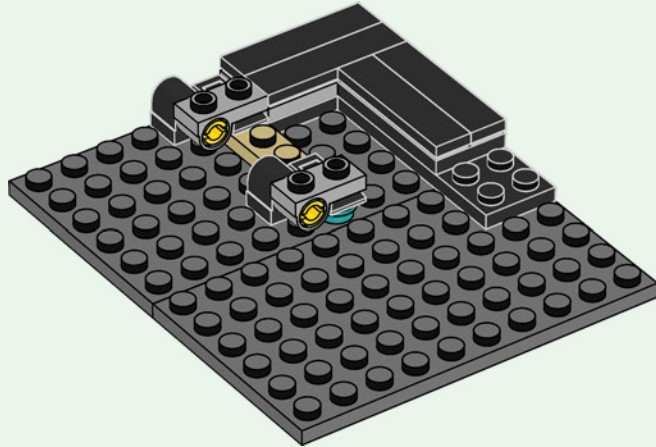

104

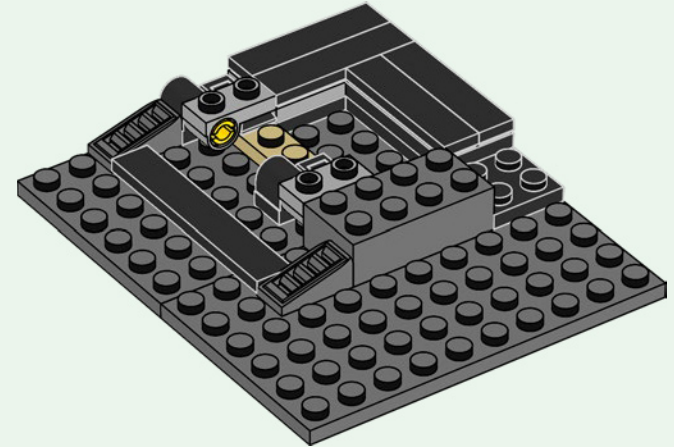

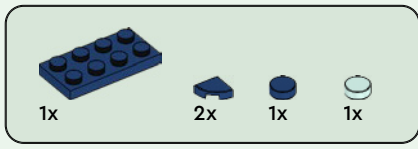

105

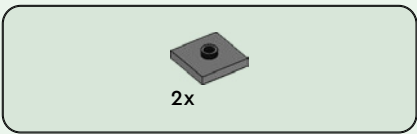
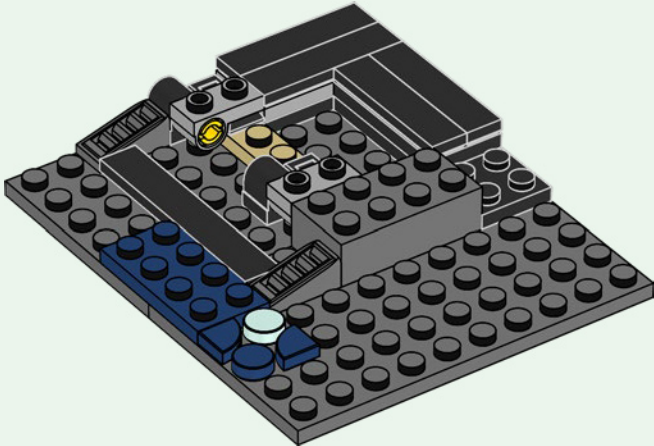

106

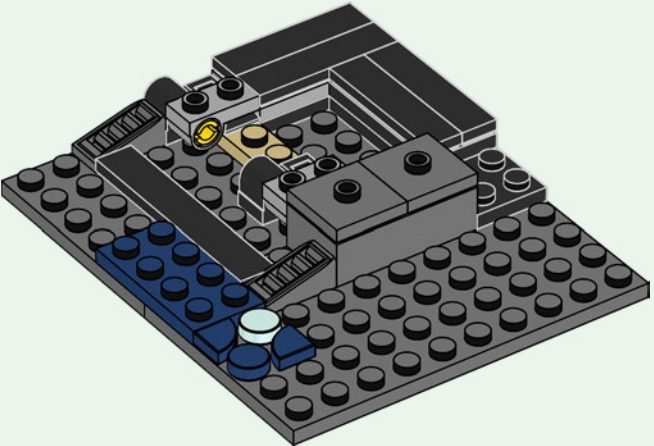

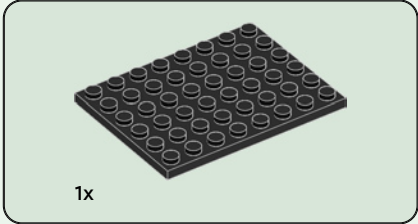
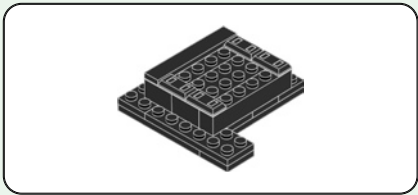

107

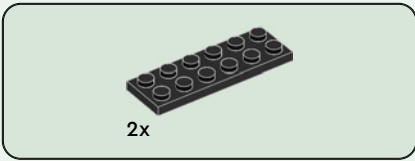
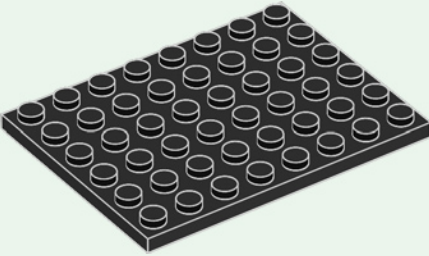

108

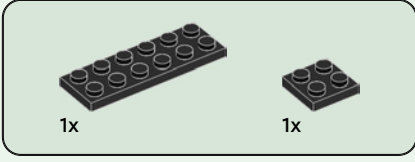
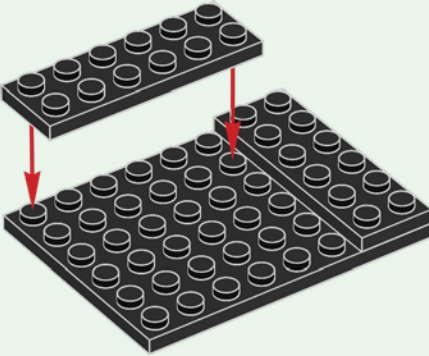

109

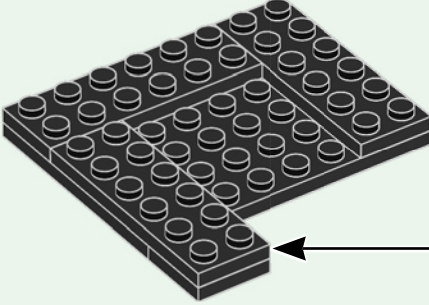
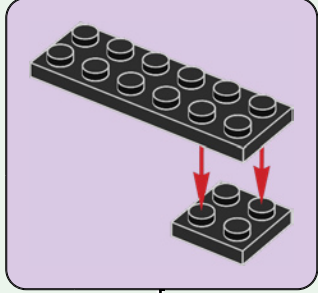

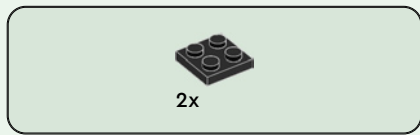

110

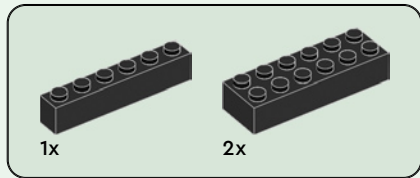
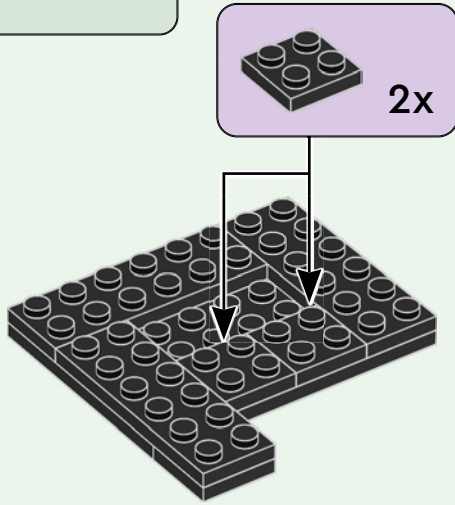

111

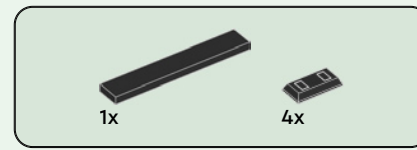
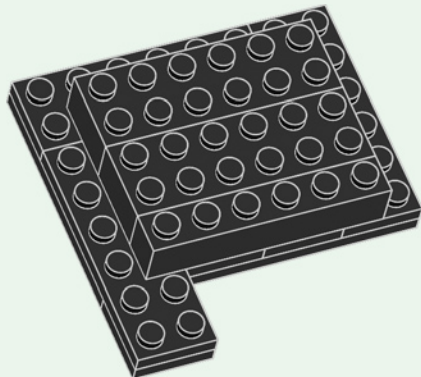

112

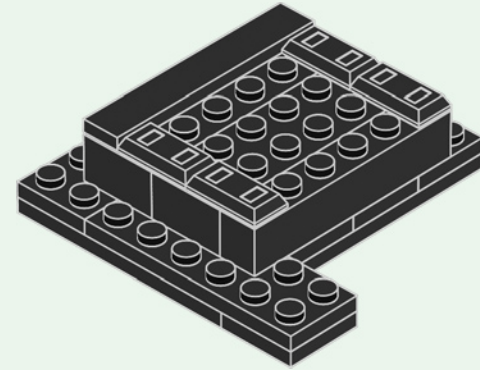

113

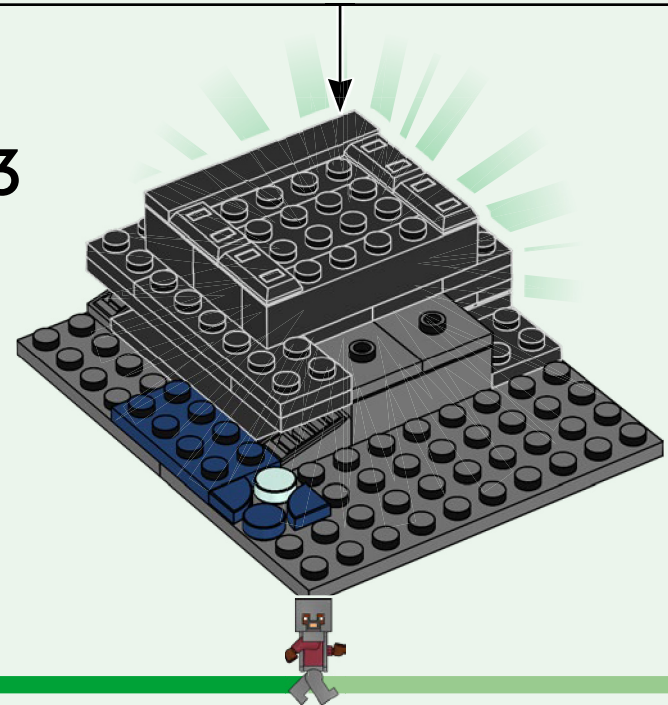

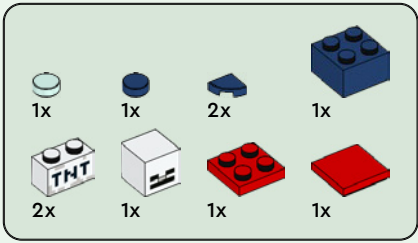

114

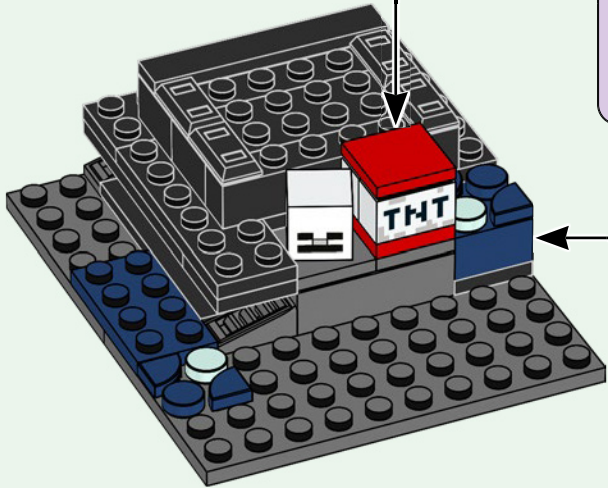
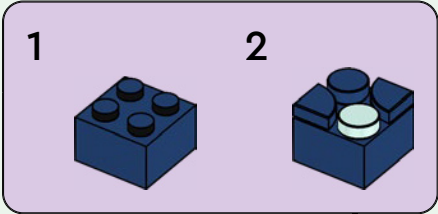
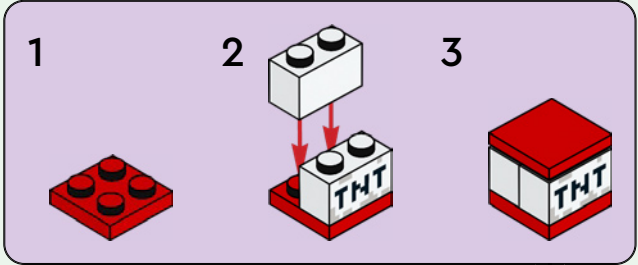

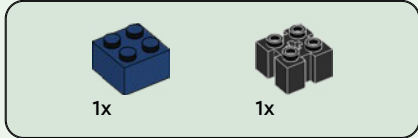
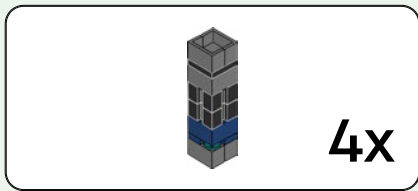

115

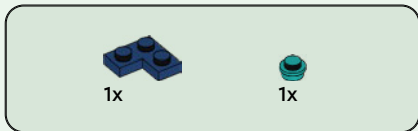
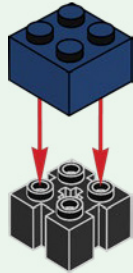

116

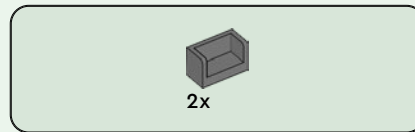
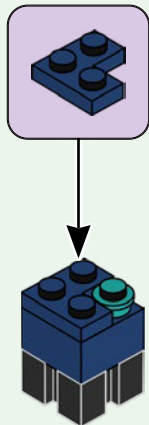

117

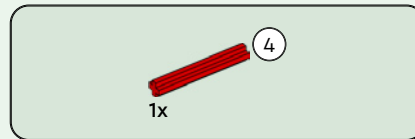
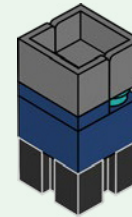

118

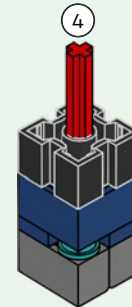

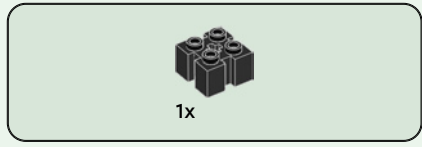

119

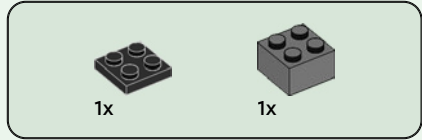
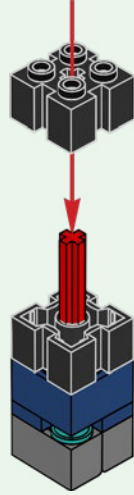

120

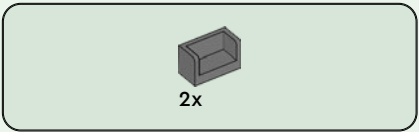
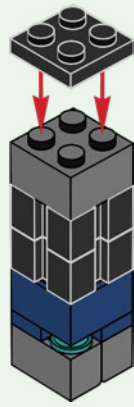

121

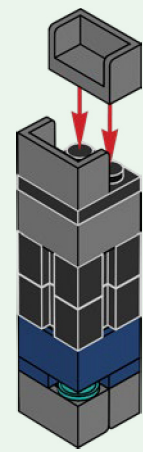

4x

122

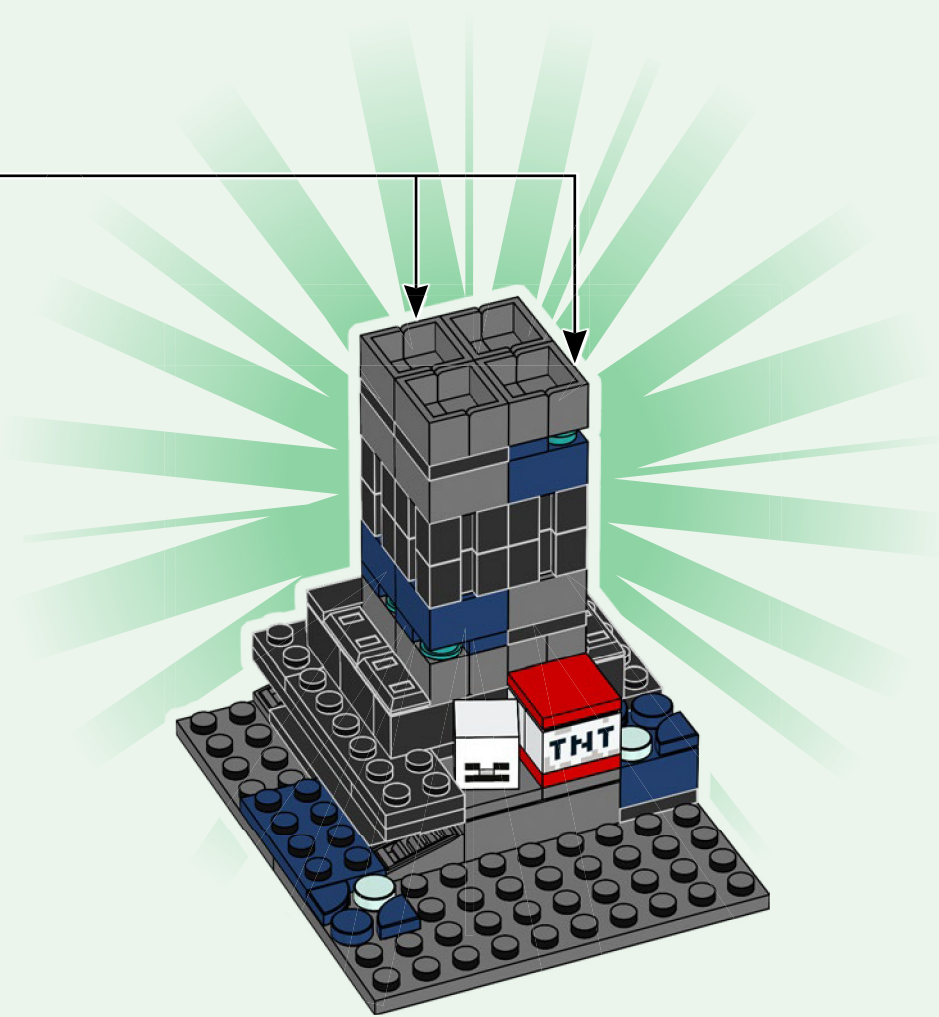

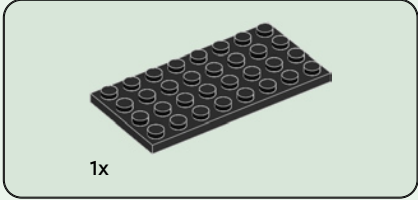
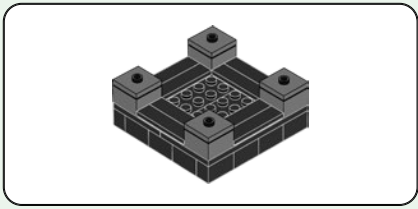

123

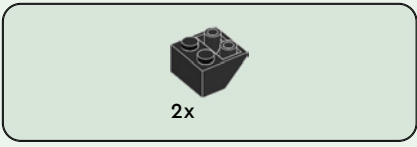
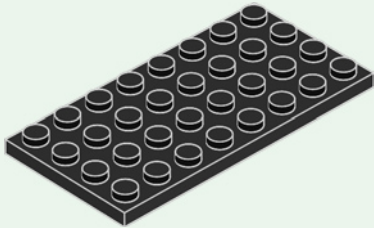

124

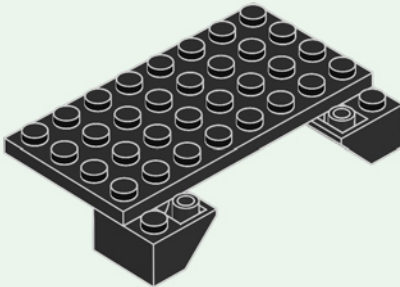

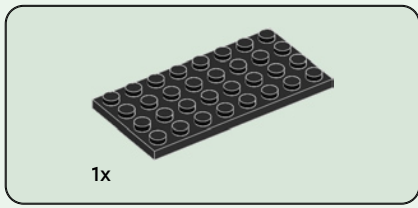

125

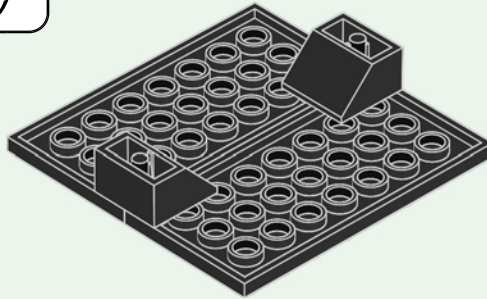



4x

126

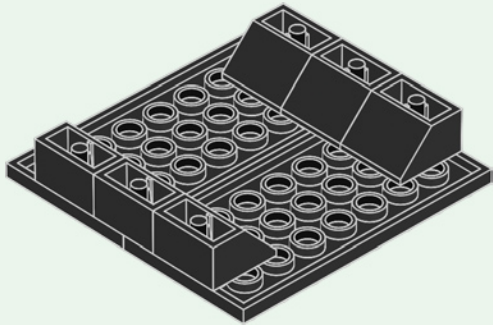

4x

127

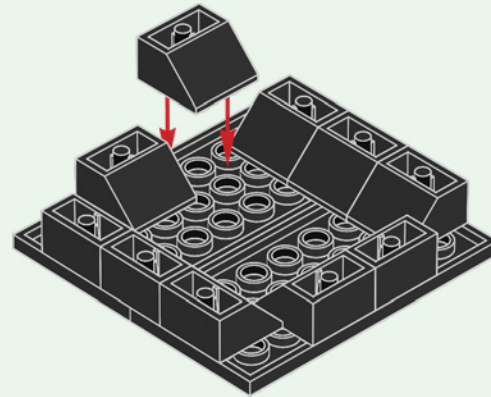

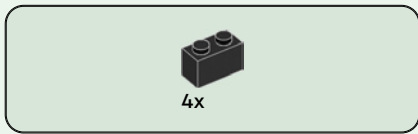

128

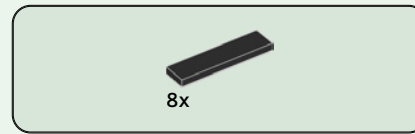
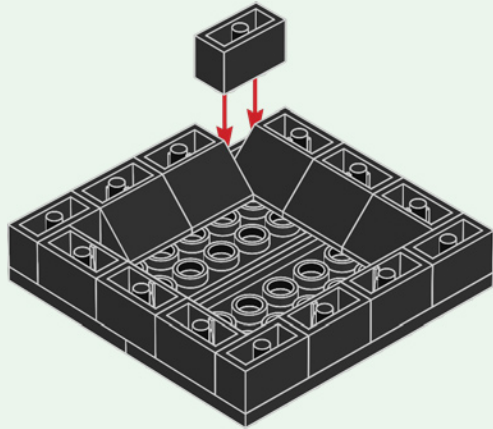

129

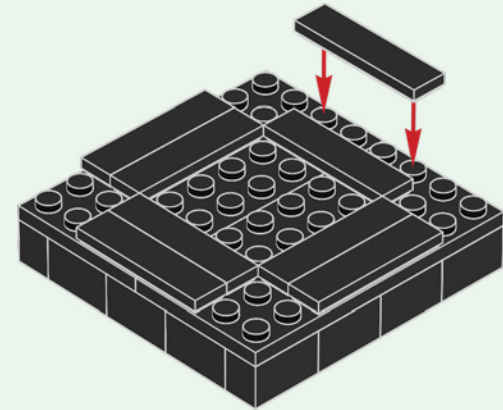
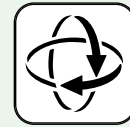

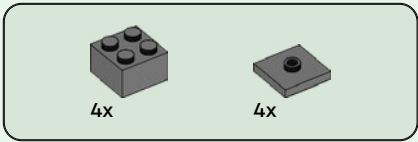

130

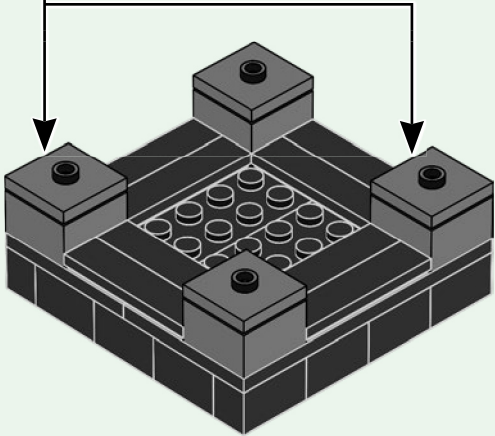
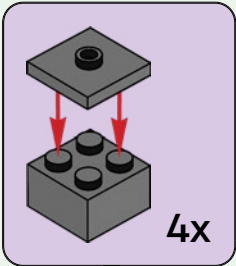

131

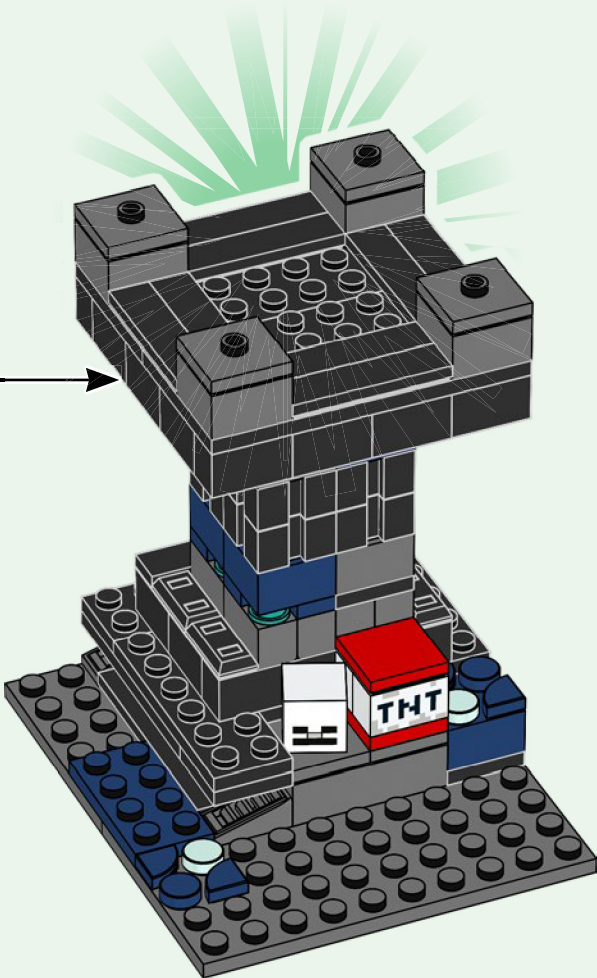

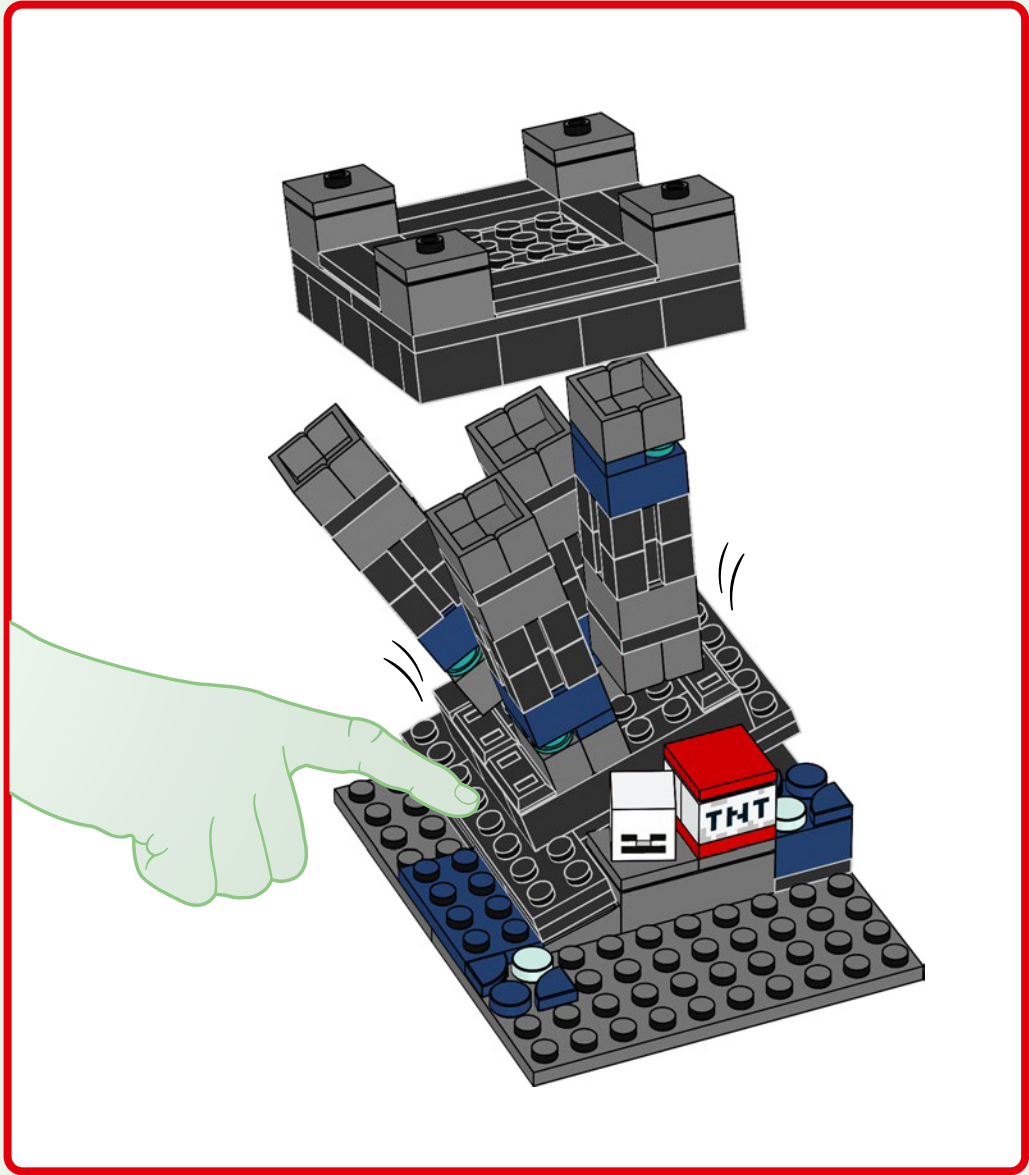

132



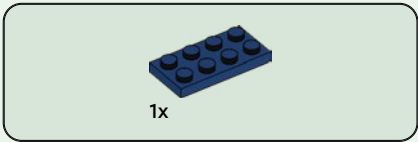

133

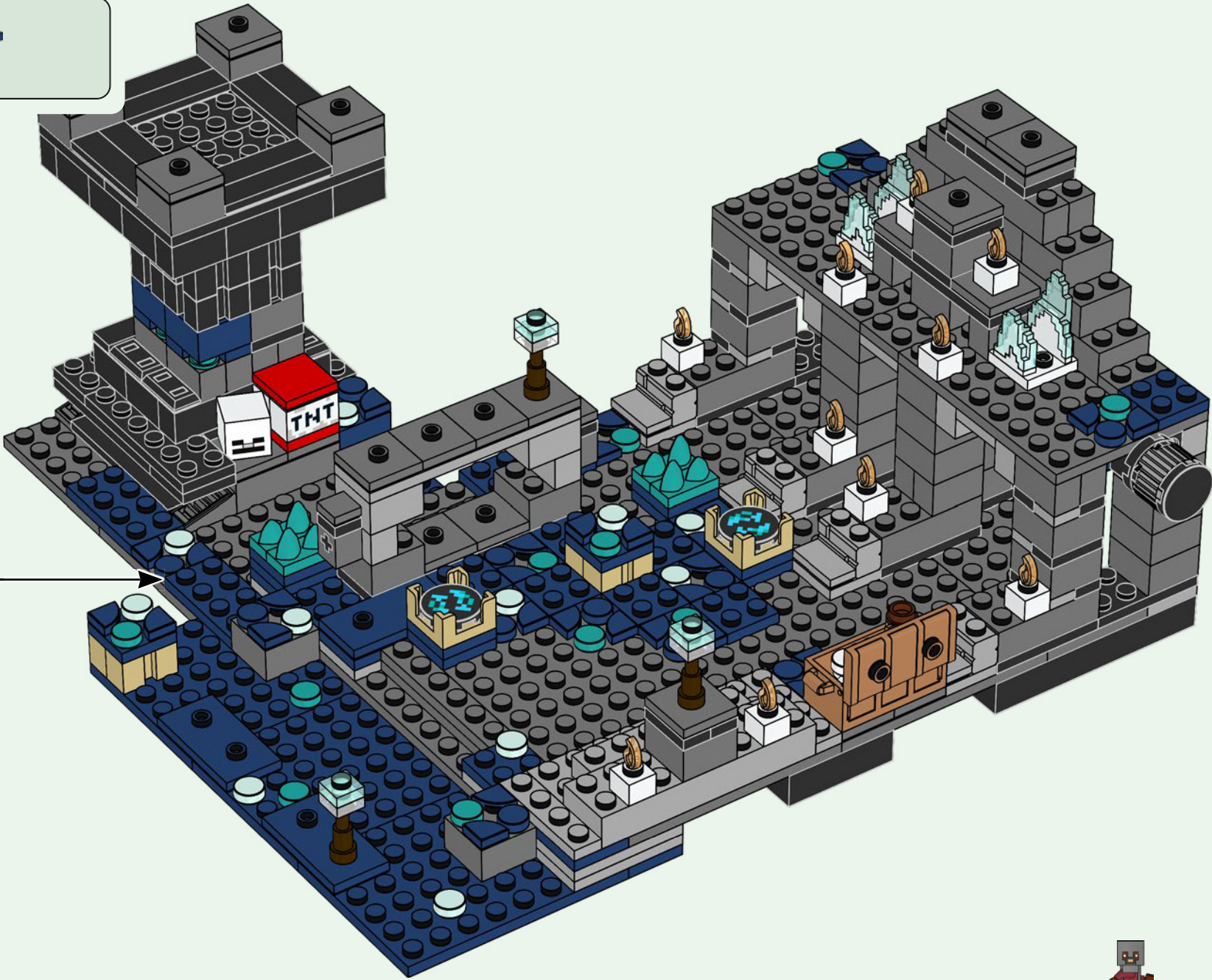
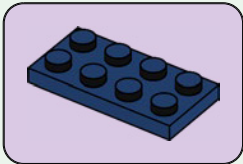

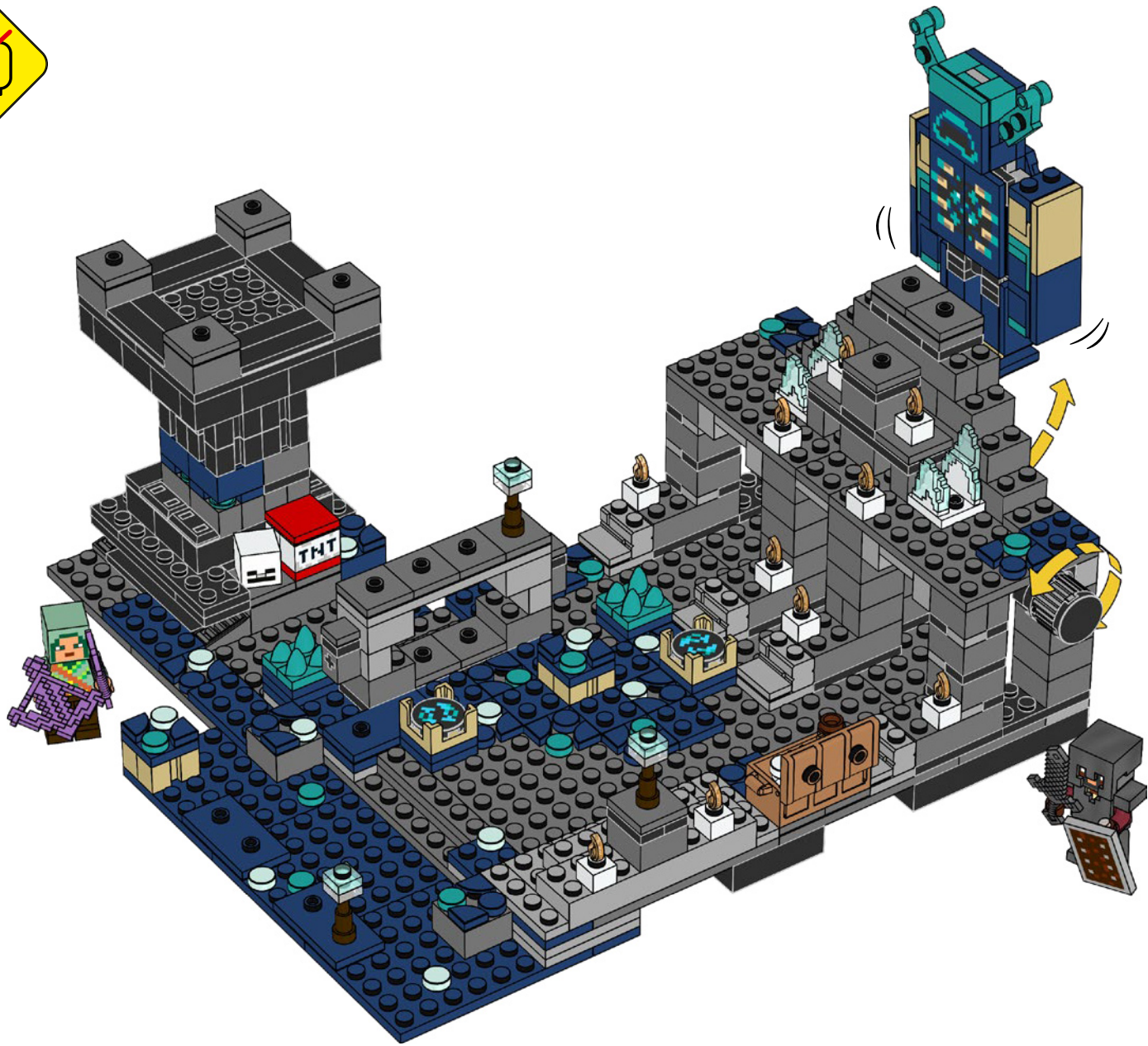





MINECRAFT

21243



21244



21241



21245





MINECRAFT

21242



21246



4x
4161734
 1x
4159553
 4x
6103001
 4x
6219794
 3x
4113917
 2x
6313611
 2x
6429962
 1x
4121921
 2x
6175367
 1x
4113233
 1x
6366229
 2x
302426
 1x
6344819
 1x
403226
 1x
6070695
 2x
6422992
 2x
4109810
 4x
300426
 4x
6114987
 6x
6156991
 7x
302326
 4x
4618852
 3x
3200026
 2x
6271810
 10x
6425507
 11x
302226
 10x
242026
 8x
6430547
 1x
6089119

12x
243126
 4x
371026
 1x
4516020
 2x
300126
 10x
302026
 2x
663626
 1x
300926
 6x
379526
 2x
4181144
 2x
300826
 2x
6037390
 2x
303526
 1x
303626

5x
6325978
 12x
6311437
 2x
6213776
 4x
6430544
 12x
6213777
 1x
6217659
 2x
6429966
 1x
6213787
 2x
6331855
 2x
6323477
 1x
4216581
 1x
4529672
 3x
4538950
 1x
6159763

14x
6284584
 32x
619890
 2x
4255413
 2x
4184108
 6x
4249891
 2x
6429965
 2x
6350417
 2x
6224778
 5x
4296785
 21x
6037890
 4x
4528482
 1x
4613335
 4x
6186974
 1x
6432165
 1x
4502089

1x
6135597
 4x
4667595
 4x
6357956
 2x
6422993
 1x
6027625
 2x
6097420
 3x
6146302
 10x
6357747
 1x
6343856
 1x
6350508
 1x
6197015
 1x
6350506

6x 4211399
2x 4211375
1x 4650645
4x 4211414
4x 6000066
2x 6206249
2x 6188633
2x 6043656
1x 6331859
13x 4211397
2x 4211353
5x 4211349
2x 4211387
1x 6338962

1x 6043639
1x 6432167
4x 4211445
4x 4211395
1x 4211393
1x 6037399
1x 4211406
1x 6394960
1x 6102984
1x 306821
1x 302221
4x 6129995
1x 6130004
1x 6240515

4

8

2x 6284572
1x 6186867
1x 6359231
3x 6252041
10x 6383985
1x 4600294
1x 6162386
2x 6232029
2x 6097028
2x 6394965
2x 300101
2x 366601
11x 6322818
1x 6430546
1x 6429963

2x 4210848
3x 4211098
2x 6362259
1x 6422989
2x 4540386
17x 4211088
4x 4211063
16x 6275131
20x 6126083
33x 4211060
1x 4211043
3x 4211103
9x 4211085
1x 4211065
1x 4211056

1x 4211100
1x 4211002
4x 4210998
1x 4210678
2x 4211061
2x 4210794
2x 4211114
1x 6004927

2x 6331822
1x 4519010
1x 6276023
3x 6252043
3x 4206482
1x 6422990
1x 6431431
1x 6354150



 [LEGO.com/service](https://www.LEGO.com/service)

YOU COULD **WIN**



Scan this QR code or go to **LEGO.COM/PRODUCTFEEDBACK** and give us your short feedback about this LEGO® set for a chance to win a cool LEGO prize.

Terms and Conditions apply*

DE: Du könntest GEWINNEN. Es gelten die Teilnahmebedingungen* **FR: Tu pourrais GAGNER.** Des conditions s'appliquent* **IT: Potresti VINCERE tu.** Termini e condizioni sono applicabili* **ES: Puedes GANAR.** Aplican términos y condiciones* **PT: Poderá GANHAR.** Aplicam-se termos e condições* **JA: プレゼント付き! 利用規約が適用されます*** **ZH: 轻松获奖. 条款和条件适用*** **KO: 상품의 주인이 되어보세요. 소정의 약관이 적용됩니다*** **RU: Вы можете ВЫИГРАТЬ.** Действуют положения и условия* **PL: Szansa na WYGRANĄ.** Obowiązują warunki korzystania* **CS: Máte šanci VYHRÁT.** Platí všeobecné smluvní podmínky* **SK: Máte šancu VYHRAŤ.** Platia všeobecné zmluvné podmienky* **HU: TE IS NYERHETSZ.** Felhasználási feltételek érvényesek* **RO: Ai putea CÂȘTIGA.** Se aplică termenii și condițiile* **BG: Можете да СПЕЧЕЛИТЕ.** Има определени правила и условия* **LV: Tu vari LAIMĒT.** Ir spēkā noteikumi un nosacījumi.* **ET: Sul on võimalus VÕITA.** Kehtivad tingimused* **LT: Jūs galite LAIMĖTI.** Taikomos sąlygos*

*[LEGO.com/productfeedback-terms](https://www.lego.com/productfeedback-terms)

LEGO and the LEGO logo are trademarks of the/sont des marques de commerce du/son marcas registradas de LEGO Group. ©2023 The LEGO Group.



© 2023 Mojang AB. All Rights Reserved. Minecraft, the Minecraft logo, the Mojang Studios logo and the Creeper logo are trademarks of the Microsoft group of companies.