





WE'RE MAKING OUR PACKAGING MORE SUSTAINABLE

We're transitioning from single-use plastic to paper-based packaging. As we progress, you may find a mix of paper and plastic in our boxes.

NOUS RENDONS NOS EMBALLAGES PLUS DURABLES

Nous passons des emballages en plastique à usage unique aux emballages à base de papier. Durant la transition, vous pourriez trouver un mélange de papier et de plastique dans nos boîtes.

QUEREMOS HACER MÁS SUSTENTABLES NUESTROS MATERIALES DE EMBALAJE

Estamos cambiando las bolsas de plástico desechables por bolsas con base de papel. Conforme avanzamos en este propósito, puedes encontrar una mezcla de papel y de plástico en nuestras cajas.

LEGO.com/sustainable-packaging

LEGO® VIP

- 1.** SIGN UP
INSCRIVEZ-VOUS
REGÍSTRATE

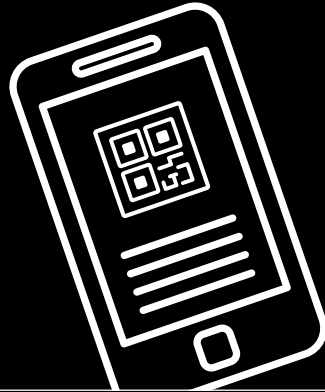

- 2.** EARN POINTS
FOR PURCHASES
GAGNEZ DES POINTS
POUR VOS ACHATS
GANA PUNTOS POR
TUS COMPRAS

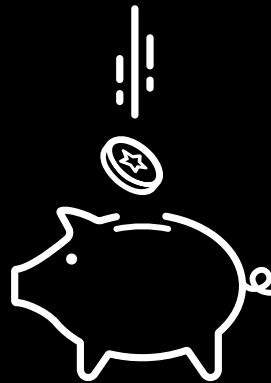

- 3.** REDEEM POINTS FOR REWARDS, EXPERIENCES,
DISCOUNTS & MORE
ÉCHANGEZ DES POINTS CONTRE DES RÉCOMPENSES,
DES EXPÉRIENCES, DES RÉDUCTIONS ET PLUS ENCORE
CANJEA PUNTOS POR RECOMPENSAS, EXPERIENCIAS,
DESCUENTOS Y MUCHO MÁS

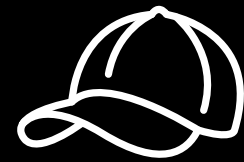
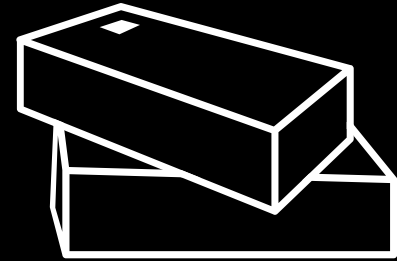
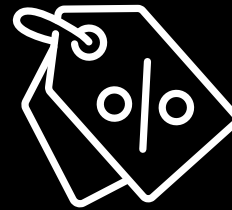

21st century pop icons

Since its birth in the 1990s, modern K-pop has conquered the global music scene with compellingly happy tunes, blazing splashes of color and upbeat dance moves. Transcending language and cultural barriers, each new generation of passionate young Korean artists and bands have carved a niche of their own in music history.

Then in 2013, seven South Korean stars aligned in an extraordinary constellation that would definitively reshape the landscape of K-pop in the pop music scene. With multi-genre-inclusive hits that continue to break world records, BTS are this generation's unequivocal pop icons. Members RM, Jin, SUGA, j-hope, Jimin, V and Jung Kook have reached unprecedented levels of popularity worldwide as 21st century pop icons. Not only for their unique music style and tongue-in-cheek attitudes but also for acting responsibly as positive influencers and activists for equality and inclusivity, and ambassadors for self-love and joy, on and off stage.



BTS – On and Beyond the Scene

With millions of records sold, stadium concerts, countless nominations, prestigious awards and recognitions, and tens of millions of social media followers, BTS have had a tremendous impact on fans worldwide, especially among young generations. BTS, an acronym for *Bangtan Sonyeondan*, later became an acronym for 'Beyond the Scene,' as band members wanted to use their voices to reach far beyond the music scene. In 2017, they entered a partnership with UNICEF to work towards ending violence and neglect while promoting the younger generation's self-esteem and well-being through the LOVE MYSELF and #ENDviolence campaigns. The band was invited to deliver their "Speak Yourself" speech at the 2018 UN General Assembly, with a message empowering young people to trust their worth and talent, and let their voices be heard.



Des icônes de la pop du 21^e siècle

Depuis sa naissance dans les années 1990, la K-pop moderne a conquis la scène musicale mondiale avec des mélodies joyeuses et irrésistibles, des couleurs vives et des mouvements de danse entraînants. Transcendant les barrières linguistiques et culturelles, chaque nouvelle génération de jeunes artistes et groupes coréens passionnés s'est taillée une place dans l'histoire de la musique.

Puis en 2013, sept étoiles sud-coréennes se sont alignées dans une constellation extraordinaire qui allait profondément remodeler le paysage de la K-pop sur la scène de la musique pop. Avec des tubes multigenres qui continuent de battre des records mondiaux, BTS est sans conteste l'icône de la pop de cette génération. Les membres RM, Jin, SUGA, j-hope, Jimin, V et Jung Kook ont atteint des niveaux de popularité sans précédent dans le monde entier en tant qu'icônes de la pop du 21^e siècle, non seulement pour leur style de musique unique et leurs attitudes pince-sans-rire, mais aussi pour leur comportement responsable en tant qu'influenceurs positifs et militants pour l'égalité et l'inclusion, et en tant qu'ambassadeurs de l'amour de soi et de la joie, sur scène comme en dehors.

BTS – Sur scène et au-delà de la scène

Avec des millions de disques vendus, des concerts dans des stades, d'innombrables nominations, des récompenses et des reconnaissances prestigieuses, et des dizaines de millions d'adeptes sur les médias sociaux, BTS a eu un impact considérable sur les amateurs du monde entier, en particulier parmi les jeunes générations. BTS, acronyme de *Bangtan Sonyeondan*, est devenu par la suite l'acronyme de « Beyond the Scene » (« Au-delà de la scène »), car les membres du groupe souhaitaient utiliser leurs voix pour aller bien au-delà de la scène musicale. En 2017, ils ont conclu un partenariat avec l'UNICEF pour œuvrer à la fin de la violence et de la négligence tout en favorisant l'estime de soi et le bien-être de la jeune génération grâce aux campagnes LOVE MYSELF et #ENDviolence. Le groupe a été invité à prononcer son discours « Speak Yourself » à l'Assemblée générale des Nations unies de 2018, où il a livré un message donnant aux jeunes les moyens de faire confiance à leur valeur et à leur talent, et de faire entendre leur voix.

Íconos del pop del siglo XXI

Desde su nacimiento en la década de 1990, el k-pop moderno ha conquistado la escena musical a nivel global con canciones irresistiblemente alegres, espectaculares explosiones de color y animados pasos de baile. Trascendiendo barreras culturales y de idioma, cada nueva generación de apasionados artistas y bandas coreanos se ha labrado un nicho en la historia de la música.

Este proceso tuvo un hito importante en 2013, año en el que siete estrellas surcoreanas se alinearon en una extraordinaria constelación que vendría a repositonar irreversiblemente el k-pop en la escena de la música pop. Con éxitos en una amplia variedad de géneros que siguen rompiendo récords mundiales, BTS es un consagrado símbolo de la música pop de esta generación. Sus integrantes, RM, Jin, SUGA, j-hope, Jimin, V y Jung Kook, han alcanzado niveles inusitados de popularidad mundial como íconos del pop del siglo XXI. Esto se debe no solo a su singular estilo musical y actitud determinada, sino también a su actuación responsable como influencers y activistas por la igualdad y la inclusión, así como al rol que asumen como embajadores del amor propio y la alegría dentro y fuera de los escenarios.

BTS en el escenario y más allá

Con millones de grabaciones vendidas, conciertos en estadios, innumerables nominaciones y prestigiosos galardones y reconocimientos, así como decenas de millones de seguidores en redes sociales, BTS ha dejado una profunda huella en sus fans de todo el mundo y, especialmente, en las generaciones más jóvenes. El acrónimo BTS, originalmente procedente de *Bangtan Sonyeondan*, posteriormente se convirtió en una referencia a la expresión en inglés *beyond the scene* (más allá de los escenarios) a consecuencia de la intención de los integrantes de la banda de usar sus voces para llegar más allá de la escena musical. En 2017, iniciaron una colaboración con UNICEF para trabajar con miras a poner fin a la violencia y la desatención, promoviendo al mismo tiempo la autoestima y el bienestar de las generaciones más jóvenes mediante las campañas LOVE MYSELF y #ENDviolence. En 2018, la banda recibió una invitación para pronunciar su discurso *Speak Yourself* ante la Asamblea General de la ONU; su mensaje se centró en animar a la juventud a confiar en sus talentos y méritos, y hacer oír sus voces.



How to build a record-breaking hit

Released in 2020 under BIGHIT MUSIC (under HYBE LABELS), an industry-leading music label, a new hit shone through the world at a time when most of us could definitely use a little funk and soul. (Or a lot, actually.) Without the opportunity to tour or engage with their beloved and devoted fans in person, the band turned to their superstrength to get through the pandemic; they continued to sing, dance and redefine their art on their own terms. 'Dynamite' offered a welcome challenge to keep growing. Seen as a joyful reminder to allow space for light and fun in times of darkness, the song delivered on BTS' mission to bring people together and spread happiness. It lights a fire under our own playfulness and embraces the fact that life really is dynamite!

Build. Play. Dance!

'Dynamite' debuted at no. 1 on the Billboard Hot 100, Global Top 50 on Spotify and reached no. 1 on the charts in more than 100 countries and regions on iTunes. At the time of its release, views of the music video also exploded on YouTube, reaching 100 million views in less than a day. This set is a tribute to one of the most extraordinary music phenomena of our time. It is for everyone who shares the band members' love of feel-good, funky disco overload. Get ready to soak up the warm, sunny colors and energized atmosphere in the vibrant scenes, sing along (loudly!) and build, play and dance your way through your set.



Comment construire un succès qui bat des records

Sorti en 2020 sous BIGHIT MUSIC (sous HYBE LABELS), un grand label de l'industrie de la musique, un nouveau tube a resplendi dans le monde entier à un moment où la plupart d'entre nous avaient bien besoin d'un peu de funk et de soul. (Ou de beaucoup, en fait.) N'ayant pas la possibilité de partir en tournée ou de rencontrer en personne ses admirateurs adorés et dévoués, le groupe a puisé dans ses forces pour surmonter la pandémie; il a continué à chanter, à danser et à redéfinir son art à sa manière. « Dynamite » a lancé le défi encourageant de continuer à évoluer. Considérée comme un rappel joyeux de la nécessité de laisser la place à la lumière et au bonheur dans les moments sombres, la chanson a rempli la mission de BTS, soit de rassembler les gens et de répandre le bonheur. Elle allume la flamme de notre esprit ludique et nous fait comprendre que la vie, c'est vraiment de la dynamite !

Construisez. Jouez. Dansez !

« Dynamite » a débuté à la première place du Billboard Hot 100, du Top 50 mondial sur Spotify et a atteint la tête des palmarès dans plus de 100 pays et régions sur iTunes. Au moment de sa sortie, le vidéoclip a également explosé sur YouTube, atteignant 100 millions de vues en moins d'une journée. Cet ensemble rend hommage à l'un des phénomènes musicaux les plus extraordinaires de notre époque. Il s'adresse à tous ceux qui partagent l'amour des membres du groupe pour le bien-être et la démesure disco funky. Préparez-vous à vous imprégner des couleurs chaudes et ensoleillées et de l'atmosphère énergique des scènes éclatantes, à chanter (fort !) et à construire, jouer et danser jusqu'à ce que votre ensemble soit terminé.

BEAT

Cómo construir un éxito y batir récords

Lanzado en 2020 bajo el sello de BIGHIT MUSIC (filial de HYBE LABELS), una firma líder en la industria de la música, un nuevo éxito iluminó el mundo en un momento en el que todos necesitábamos un poco de ánimo en nuestras vidas. (O, siendo honestos, más que un poco). Sin la oportunidad de hacer giras ni interactuar con sus estimados y fervientes fans en persona, la banda afrontó la pandemia haciendo uso de su superpoder: seguir cantando y bailando, y redefiniendo su arte en sus propios términos. "Dynamite" fue bien recibido como un desafío para mantener el crecimiento de la agrupación. Considerada como un alegre recordatorio de dar un lugar a la luz y la diversión incluso en tiempos de oscuridad, la canción fue el medio del que BTS se sirvió para cumplir su misión de unir a las personas y compartirles su entusiasmo de vivir. Esto lo logró encendiendo la chispa de nuestra diversión interna y asumiendo el hecho de que, en realidad, ¡la vida es como la dinamita!

Construye. Juega. ¡Baila!

"Dynamite" debutó como n.º 1 en las listas Billboard Hot 100 y Global Top 50 de Spotify, y alcanzó los primeros puestos de iTunes en más de 100 países y regiones. En el momento de su lanzamiento, las visualizaciones del video musical en YouTube se dispararon, llegando a 100 millones en menos de un día. Este set es un homenaje a uno de los fenómenos musicales más extraordinarios de nuestros tiempos. También es para cualquiera que comparta el amor por vivir la vida con armonía y la sobrecarga de ritmo disco de los integrantes de la banda. Prepárate para sumergirte en la vivacidad de la atmósfera llena de color y energía de los escenarios bailando y cantando a todo pulmón mientras construyes y juegas con el set.

Meet the fan designer duo

Fan designers Josh Bretz and Jacob Twerski met online in a LEGO® fan community and worked together to combine their love of BTS and LEGO building.

Josh Bretz (LEGO® Ideas name JBBrickFanatic) is a US university student from Indiana. A lifelong LEGO fan, he loves playing and listening to music, outdoor fun and farm life.

"'Dynamite' was the first BTS song I heard and my introduction to the K-pop world. Their disco beats and catchy tunes really drew me in. I love their positivity and the happiness their music spreads! I teamed up with Jacob, who knows everything about BTS, and he helped me capture the essence of the 'Dynamite' music video in LEGO bricks. Once we shared the project on social media, the fan community of BTS helped our model video go viral almost overnight, and we gained 10,000 votes in a matter of days. It is so inspiring how dedicated BTS fans are. Their love and passion are so contagious, and I really hope they enjoy the set!"

Jacob Twerski (LEGO® Ideas name BangtanBricks) is from New York and studies psychology. He loves K-pop and music in general, building LEGO sets and writing science fiction stories and sagas.

"BTS mean everything to me. The first thing I do in the morning is listen to their music. I've written two college papers about them. Beyond the stunning visuals, elaborate choreography, out-of-this-world vocal work and lyrics, the members themselves are truly inspiring. It was such a fun process to work with Josh on this set. I would share my ideas and send him screenshots of important details and he brought the set to life. Music is a powerful force; it transcends language and 'Dynamite' perfectly displays BTS' ability to bring joy into the world. I'm glad to see more and more new fans join the BTS fan community every year."



Josh Bretz



Jacob Twerski



Rencontre avec le duo de concepteurs amateurs

Les concepteurs amateurs Josh Bretz et Jacob Twerski se sont rencontrés en ligne dans une communauté d'amateurs de LEGO® et ont travaillé ensemble pour combiner leur amour de BTS et de la construction LEGO.

Josh Bretz (pseudonyme LEGO® Ideas : JBrickFanatic) est un étudiant américain de l'Indiana. Passionné de LEGO depuis toujours, il aime le jeu, la musique, les activités de plein air et la vie à la ferme.

« "Dynamite" a été la première chanson de BTS que j'ai entendue et mon introduction au monde de la K-pop. Leurs rythmes disco et leurs airs entraînants m'ont vraiment captivé. J'aime leur positivité et le bonheur que leur musique répand ! J'ai fait équipe avec Jacob, qui s'y connaît quand il est question de BTS, et il m'a aidé à capturer l'essence du clip de "Dynamite" en briques LEGO. Une fois que nous avons partagé le projet sur les médias sociaux, la communauté des amateurs de BTS a aidé notre vidéo à devenir virale presque du jour au lendemain, et nous avons obtenu 10 000 votes en quelques jours. C'est tellement inspirant de voir le niveau de dévouement des amateurs de BTS. Leur amour et leur passion sont si contagieux, et j'espère vraiment qu'ils apprécieront l'ensemble ! »

Jacob Twerski (pseudonyme LEGO® Ideas : BangtanBricks) est originaire de New York et étudie la psychologie. Il aime la K-pop et la musique en général, construire des ensembles LEGO et écrire des histoires et des sagas de science-fiction.

« BTS représente tout pour moi. La première chose que je fais le matin est d'écouter leur musique. J'ai écrit deux articles universitaires à leur sujet. Au-delà des visuels époustouflants, des chorégraphies élaborées, du travail vocal et des paroles hors du commun, les membres eux-mêmes sont une grande source d'inspiration. C'était très amusant de travailler avec Josh sur cet ensemble. Je lui faisais part de mes idées et lui envoyais des captures d'écran de détails importants, et il donnait vie à l'ensemble. La musique est une force puissante; elle transcende les langues, et "Dynamite" illustre parfaitement la capacité de BTS à apporter de la joie dans le monde. Je suis heureux de voir de plus en plus de nouveaux membres rejoindre la communauté des amateurs de BTS chaque année. »



Conoce al dúo de fans diseñadores

Los fans diseñadores Josh Bretz y Jacob Twerski se conocieron por Internet en una comunidad de fans de LEGO® e hicieron equipo combinando su amor por BTS y la construcción con LEGO.

Josh Bretz (conocido en LEGO® Ideas como JBrickFanatic) es un estudiante universitario residente en Indiana (EE. UU.). Fan de LEGO de toda la vida, tiene también una gran pasión por tocar y escuchar música, y le gusta la vida de la granja y al aire libre.

« "Dynamite" fue la primera canción de BTS que escuché y mi primera incursión en el mundo del k-pop. Sus ritmos disco y canciones pegajosas me cautivaron de inmediato. ¡Me encanta su positividad y la felicidad que transmite su música! Hice equipo con Jacob, quien conoce a la perfección a BTS y me ayudó a capturar la esencia del video musical de "Dynamite" con bricks LEGO. Una vez que compartimos el proyecto en redes sociales, la comunidad de fans de BTS contribuyó para que el video de nuestro modelo se hiciera viral casi de la noche a la mañana, y en cuestión de días alcanzamos los 10.000 votos. Es muy inspirador lo dedicados que son los fans de BTS. Y también lo son el amor y la pasión que transmiten. ¡De verdad espero que disfruten el set! »

Jacob Twerski (conocido en LEGO® Ideas como BangtanBricks) vive en Nueva York y estudia Psicología. Le encantan el k-pop y la música en general, construir sets LEGO y escribir historias y sagas de ciencia ficción.

« BTS significa todo para mí. Lo primero que hago por la mañana es escuchar su música. He escrito dos artículos escolares acerca de ellos. Más allá de los impresionantes efectos visuales, la elaborada coreografía, el extraordinario trabajo vocal y las letras de sus canciones, los integrantes de la banda son verdaderamente inspiradores. Fue muy divertido trabajar con Josh en este set. Mi aportación consistió en enviarle mis ideas y capturas de pantalla de los detalles importantes, y fue él quien dio vida al set. La música es una fuerza muy poderosa que trasciende la barrera del idioma, y "Dynamite" refleja a la perfección la capacidad de BTS para dar alegría al mundo. Me alegra mucho ver que la comunidad de fans de BTS crece con nuevos miembros cada año. »

Meet the LEGO® Designers

"Re-creating a music video is something totally different for LEGO® Ideas. I love that we get to try these different things with the support of LEGO fans! I'm also a BTS fan, and I was excited to pack the model with details and accessories to make it a great display model, but also one that younger fans can play with! Dance choreography is so important for BTS, so it was great to be able to incorporate a stage where band members can actually dance with the special function. We must have watched the video hundreds of times for reference, and we still love it, because the song is an absolute bop!"

—James May, LEGO Ideas Model Designer

"As a BTS fan myself, I had so much fun turning this great concept into a buildable LEGO Ideas set! I liked how Josh and Jacob's model already captured the look and layout of the location in the music video, with very iconic scenes like the donut shop and record store. Our focus was to bring both the model and LEGO minifigures to life with lots of details and references from the video, a dynamic stage function and, of course, Diego's stickers and decorated minifigures."

—Gemma Anderson, LEGO Ideas Model Designer

"I rewatched the 'Dynamite' music video over and over (I even learned the dance!) to get as many details as possible from their outfits and expressions that represent the band members' unique personalities. I love their music. I don't speak Korean, but I appreciate the love and energy they exude and how it makes me feel even without understanding the words. To me, music is a universal language and BTS have proved that by captivating fans all over the world. The LEGO Group rarely portrays real people as minifigures, especially celebrities with such a huge and vocal fanbase! I'm proud we could help create this homage to them."

—Diego Sancho, LEGO Ideas Graphic Designer



FUNK

DING DONG

Rencontre avec les concepteurs LEGO®

« Recréer un vidéoclip est quelque chose de totalement différent pour LEGO® Ideas. J'aime que nous puissions essayer ces différentes idées avec le soutien des amateurs de LEGO ! Je suis également un amateur de BTS, et j'étais ravi de remplir le modèle de détails et d'accessoires pour en faire un modèle d'exposition génial, mais aussi un modèle avec lequel les jeunes amateurs peuvent jouer ! Les chorégraphies de danse sont si importantes pour BTS; c'est pourquoi il était formidable de pouvoir intégrer une scène où les membres du groupe peuvent réellement danser avec la fonction spéciale. Nous avons dû regarder la vidéo des centaines de fois à titre de référence, et nous l'aimons toujours, parce que la chanson est un pur bijou ! »

– James May, concepteur de modèles LEGO Ideas

« Étant amatrice de BTS moi-même, j'ai eu beaucoup de plaisir à transformer ce magnifique concept en un ensemble LEGO Ideas à construire ! J'ai aimé la façon dont le modèle de Josh et Jacob reflétait déjà l'aspect et la disposition du lieu dans le vidéoclip, avec des scènes très emblématiques comme la beignerie et le magasin de disques. Notre objectif était de donner vie à la fois au modèle et aux figurines LEGO avec de nombreux détails et références de la vidéo, une fonction scénique dynamique et, bien sûr, les autocollants et les figurines décorées de Diego. »

– Gemma Anderson, conceptrice de modèles LEGO Ideas

« J'ai regardé le vidéoclip de "Dynamite" plusieurs fois (j'ai même appris la danse !) pour saisir autant de détails que possible dans leurs tenues et leurs expressions, qui représentent les personnalités uniques des membres du groupe. J'adore leur musique. Je ne parle pas coréen, mais j'apprécie l'amour et l'énergie qu'ils dégagent et ce qu'ils me font ressentir, même sans comprendre les mots. Pour moi, la musique est un langage universel, et BTS l'a prouvé en charmant les amateurs du monde entier. Le groupe LEGO représente rarement de vraies personnes sous forme de figurines, surtout des célébrités qui ont une communauté d'admirateurs aussi imposante et active ! Je suis fier que nous ayons pu contribuer à la création de cet hommage à leur égard. »

– Diego Sancho, graphiste LEGO Ideas

Conoce a los diseñadores de LEGO®

"Recrear un video musical es una forma novedosa de hacer uso de las posibilidades que ofrece LEGO® Ideas. ¡Me encanta que tengamos la oportunidad de probar algo tan original con el apoyo de los fans de LEGO! También soy fan de BTS y me dio una gran emoción poder llenar el set de detalles y accesorios para convertirlo en un fantástico modelo de exhibición, ¡y también en algo con lo que los fans más jóvenes puedan jugar! La coreografía del baile es muy importante para BTS, por eso fue increíble poder incorporar un escenario con una función especial para que los integrantes de la banda bailaran de verdad. Debemos de haber visto el video cientos de veces para captar cada uno de los detalles y, a pesar de eso, ¡nos sigue encantando porque la canción es maravillosa!".

– James May, modelista de LEGO Ideas

"Me declaro fan de BTS, ¡y me divertí muchísimo convirtiendo este fantástico concepto en un set LEGO Ideas! Me gustó cómo el modelo de Josh y Jacob capturaba la apariencia y la distribución del lugar donde se grabó el video musical, así como escenas tan icónicas como las del establecimiento de donas y la tienda de música. Nos enfocamos en dar vida tanto al modelo como a las minifiguras LEGO con montones de detalles y referencias al video, un escenario que incorpora una función dinámica y, por supuesto, las calcomanías y minifiguras decoradas de Diego".

– Gemma Anderson, modelista de LEGO Ideas

"Vi el video musical de 'Dynamite' una y otra vez, e incluso aprendí las coreografías, para tomar nota de los atuendos y las expresiones que representan la personalidad de cada uno de los integrantes de la banda. Me encanta su música. No hablo coreano, pero puedo percibir la energía y el amor que irradia la banda sin necesidad de palabras. Para mí, la música es un lenguaje universal, y BTS lo ha demostrado cautivando a fans de todo el mundo. Es muy inusual que The LEGO Group retrate a personas de verdad en minifiguras, ¡y más aún a celebridades con una base de fans tan amplia y notoria! Me enorgullece haber podido contribuir a crear este homenaje para la banda".

– Diego Sancho, diseñador gráfico de LEGO Ideas

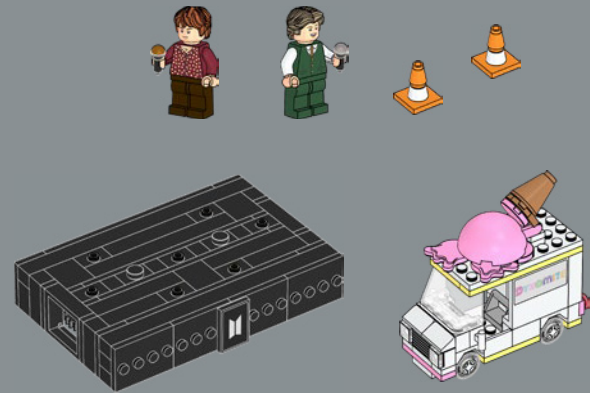
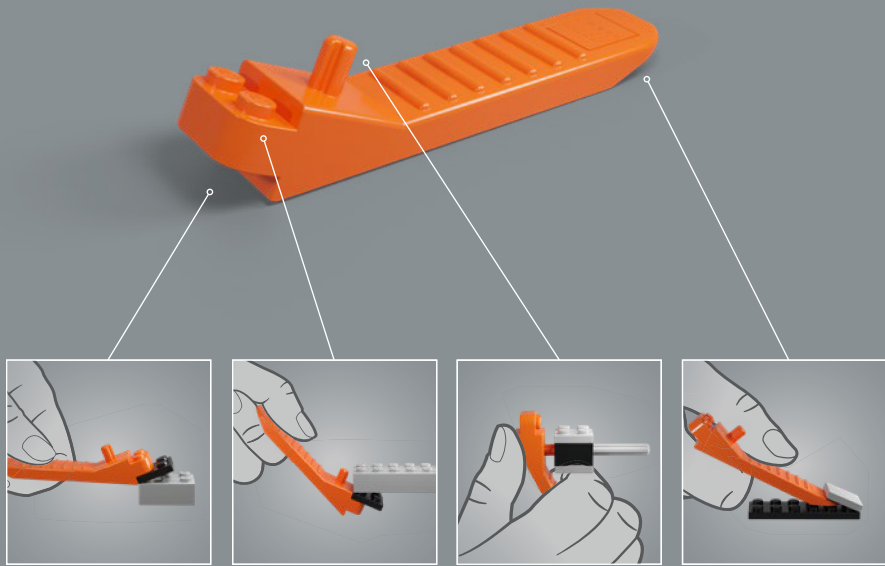

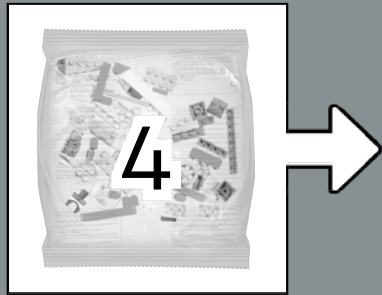
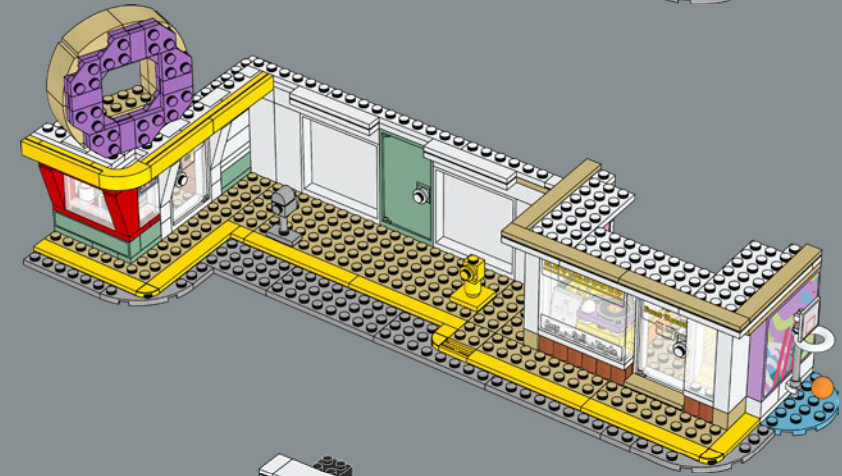
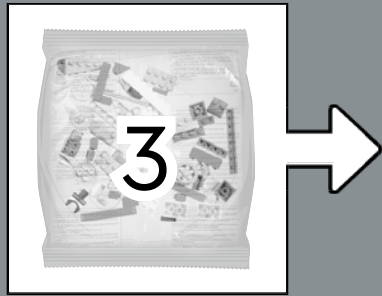
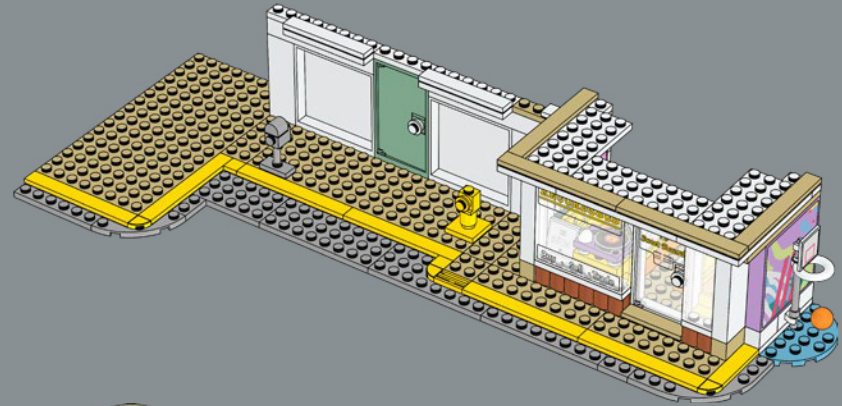
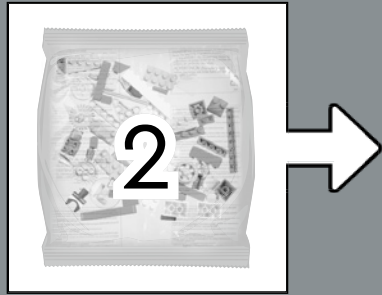



1

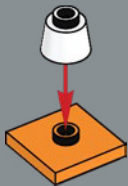

2



2x

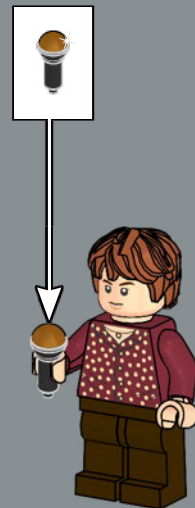
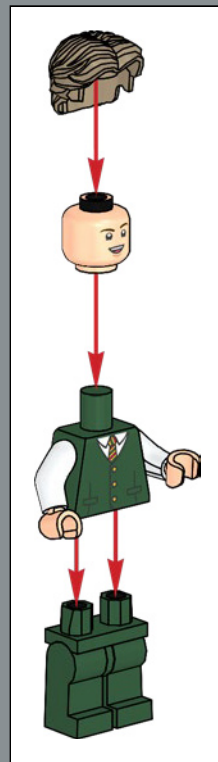

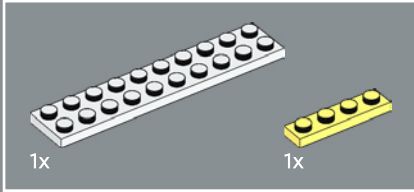

1

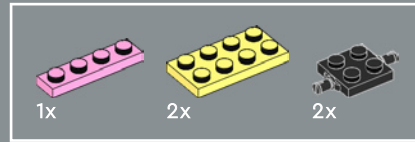
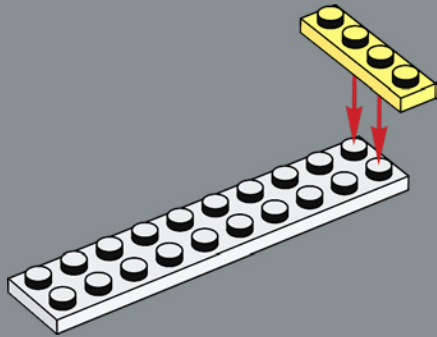

2

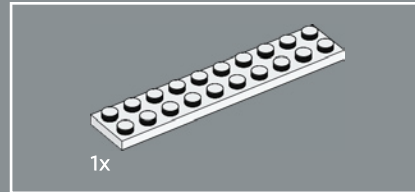
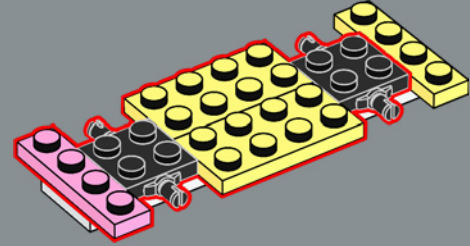

3

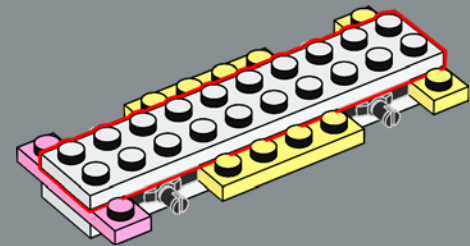

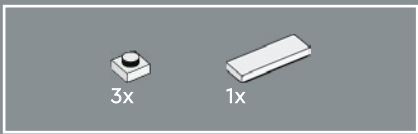

4

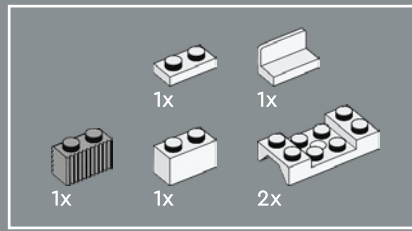
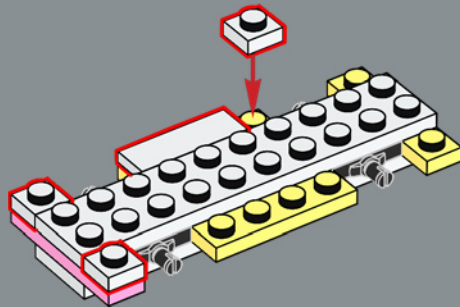

5

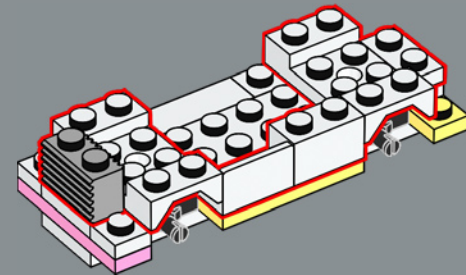

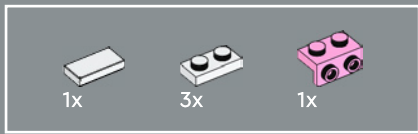

6

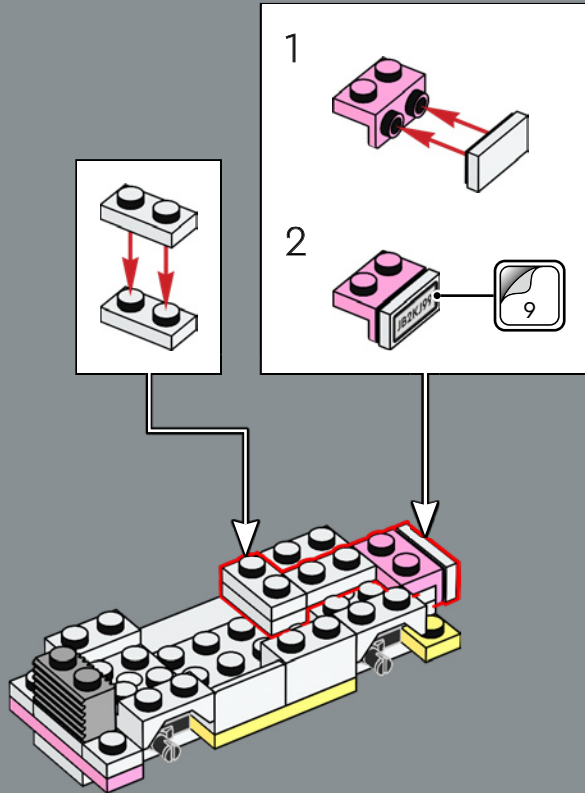

7

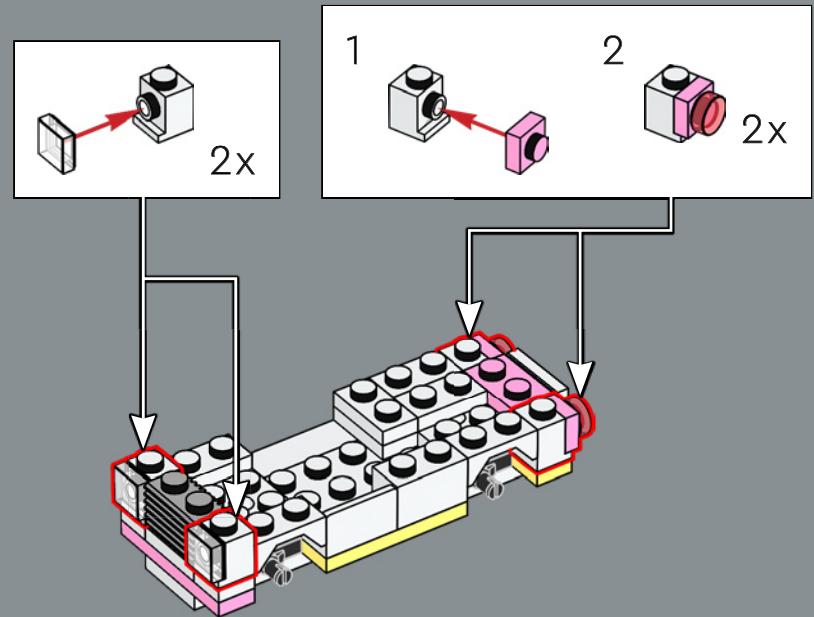

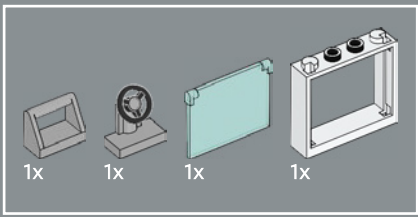

8

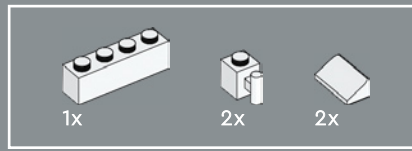
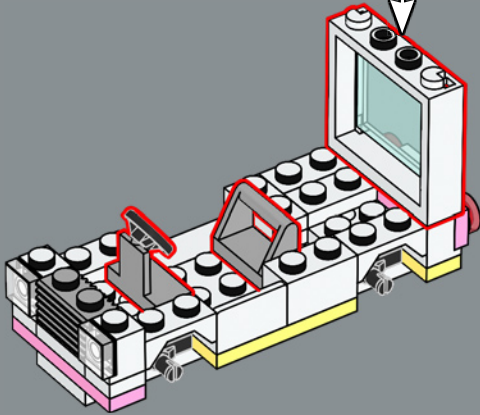
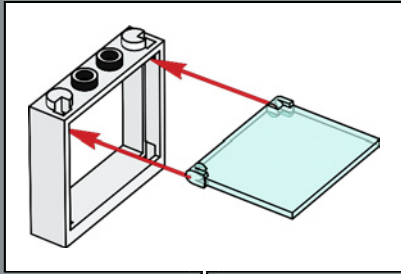

9

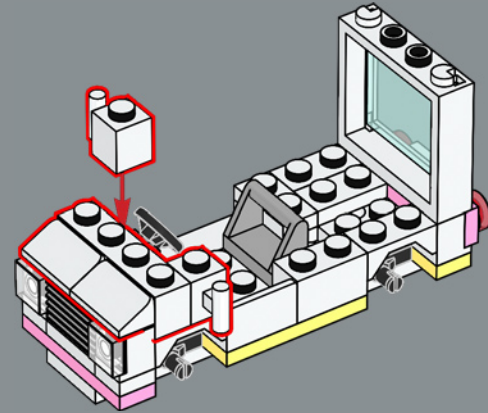

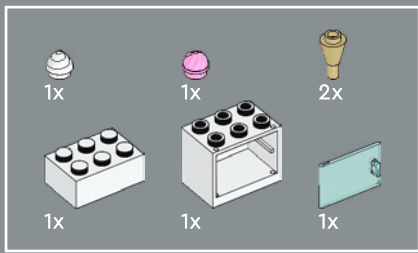

10

1

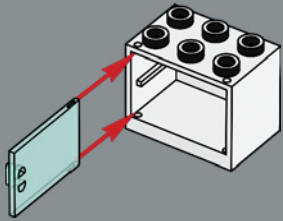

2

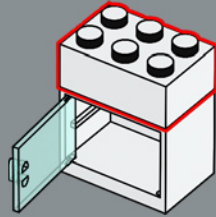

3

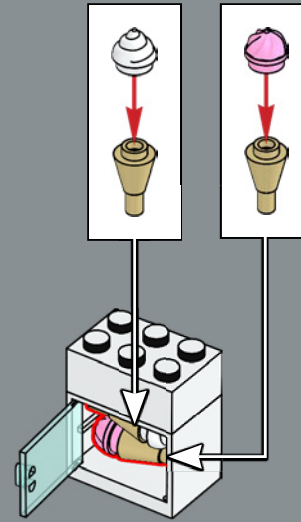

4

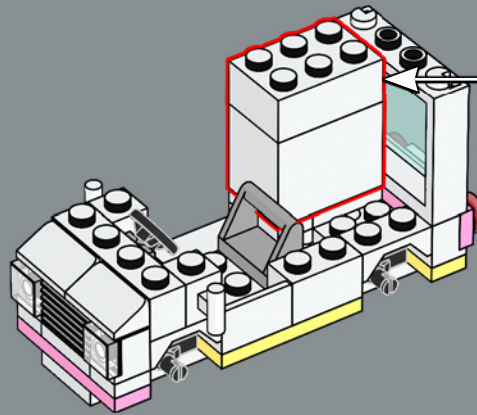
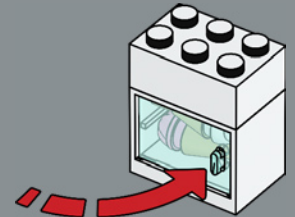

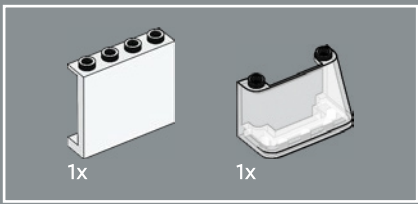

11

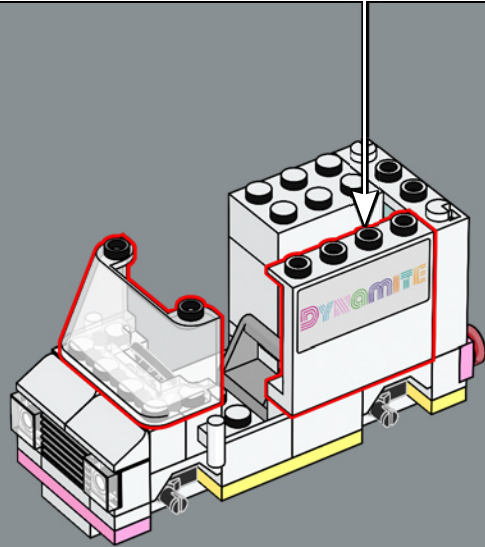
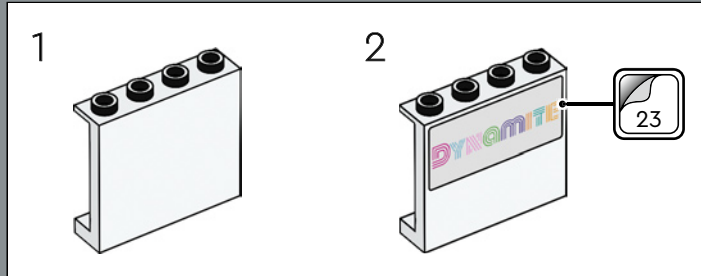

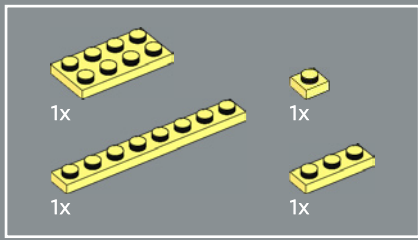

12

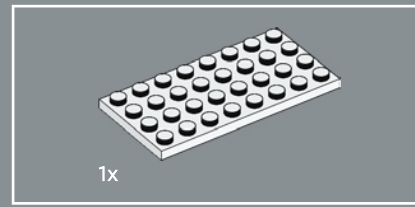
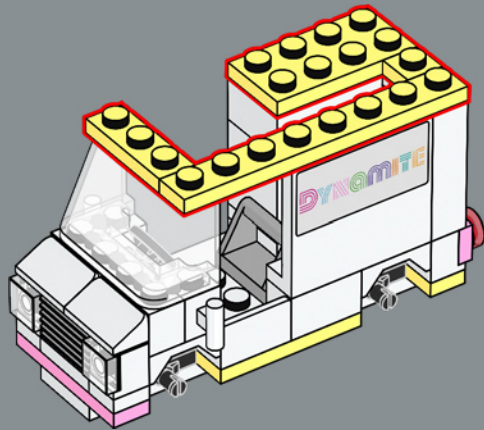

13

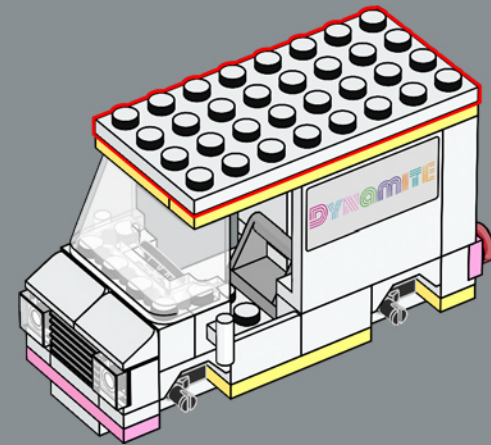



14

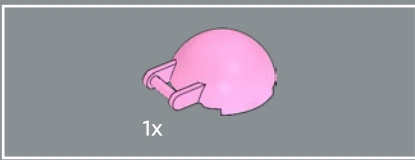
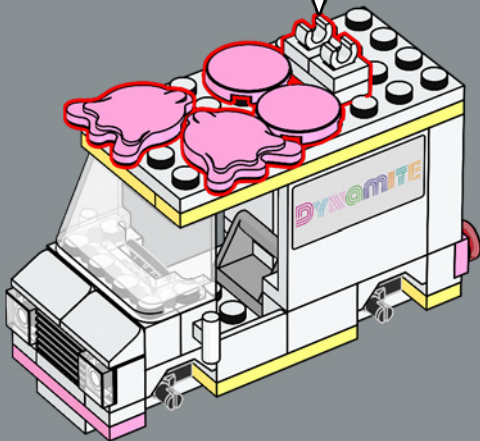
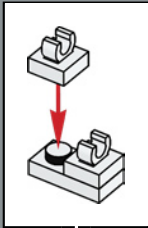

15

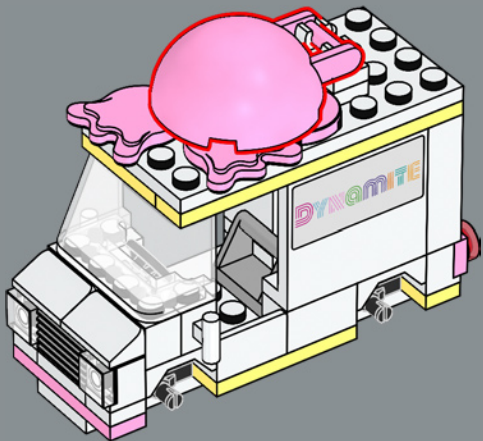

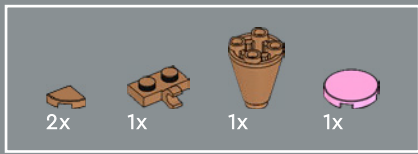

16

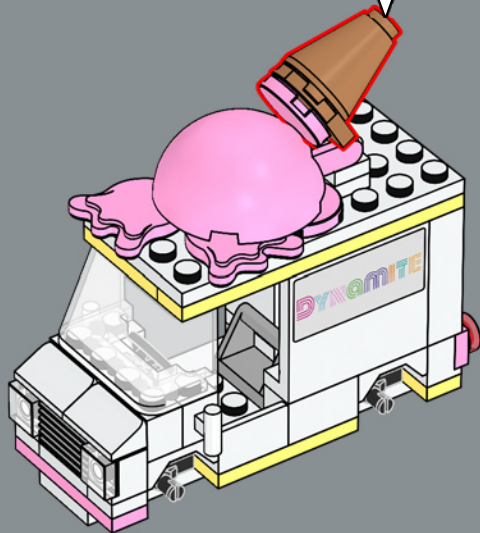
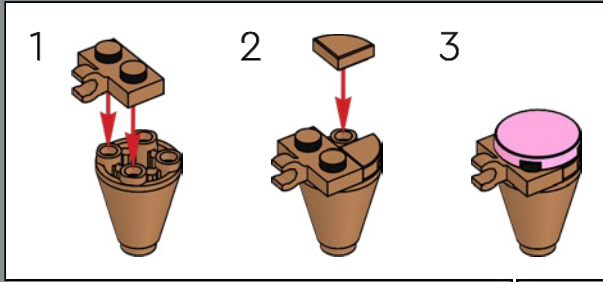

17

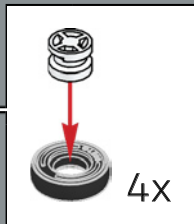

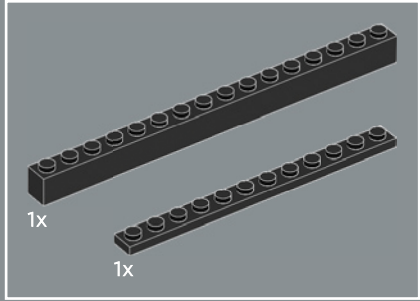
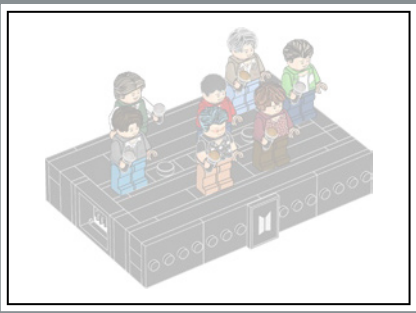

1

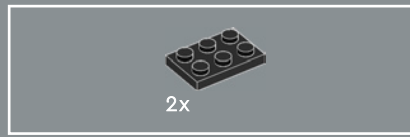
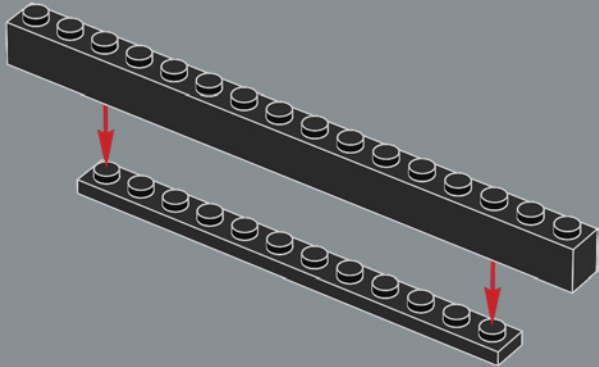

2

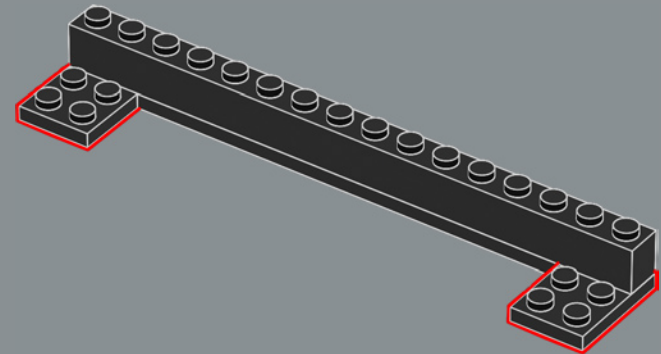

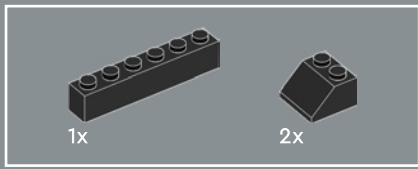

3

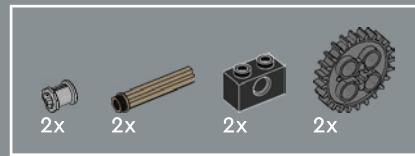
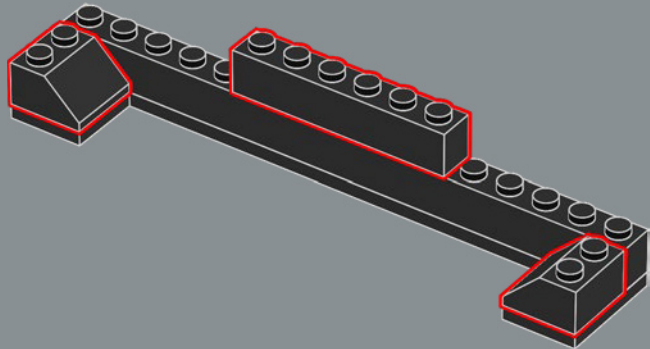

4

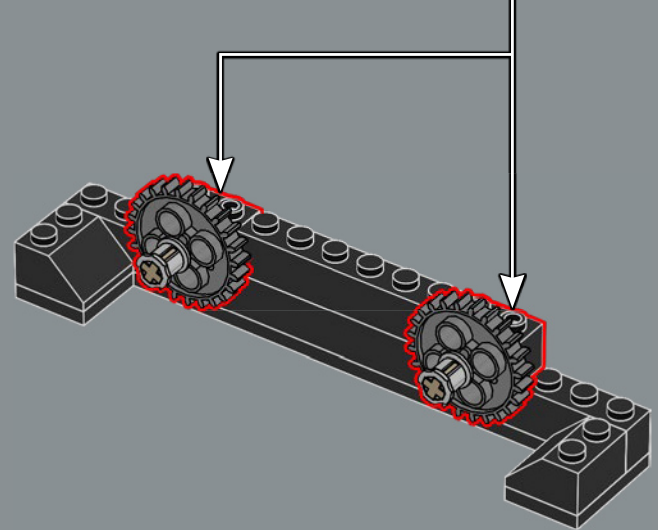
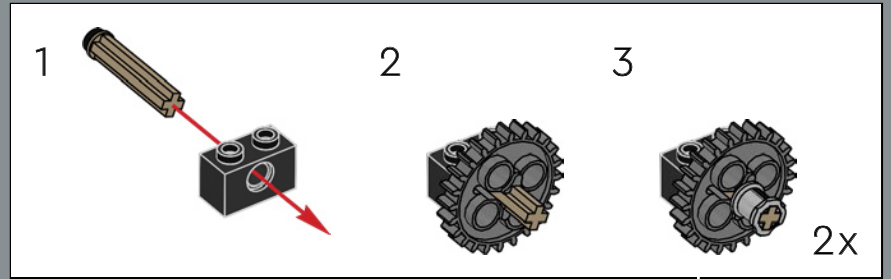

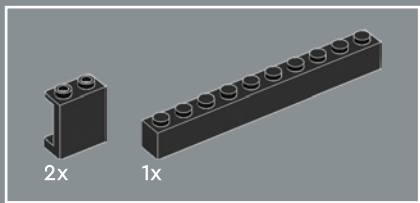

5

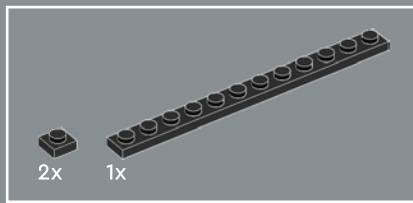
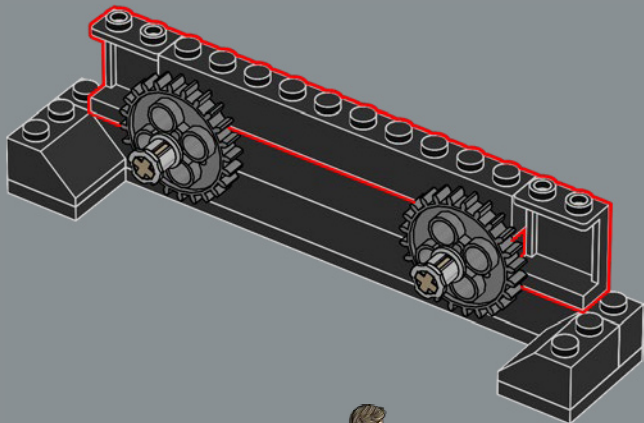

6

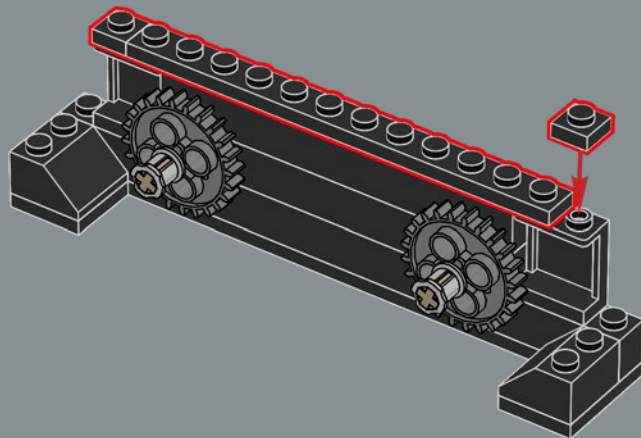

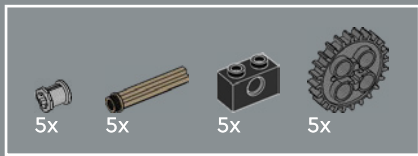

7

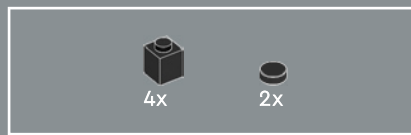
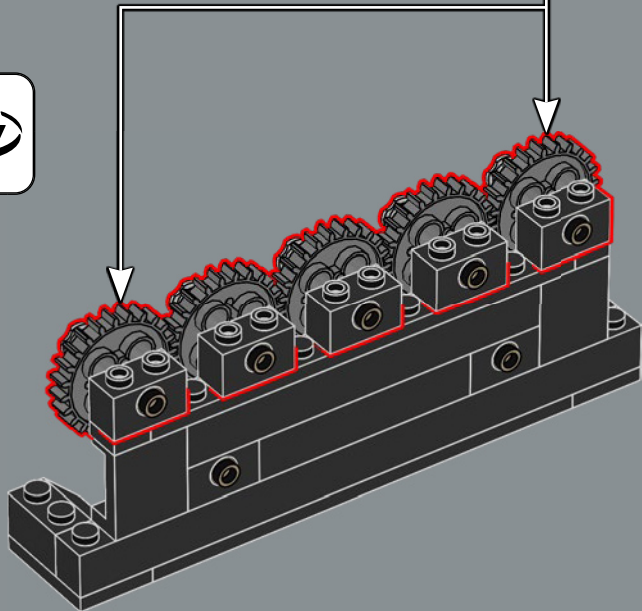
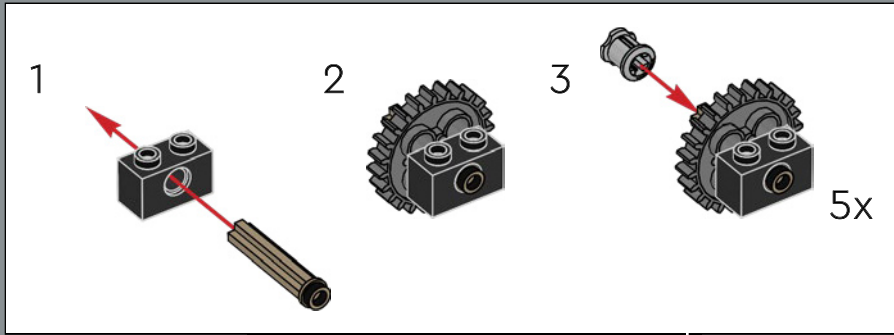

8

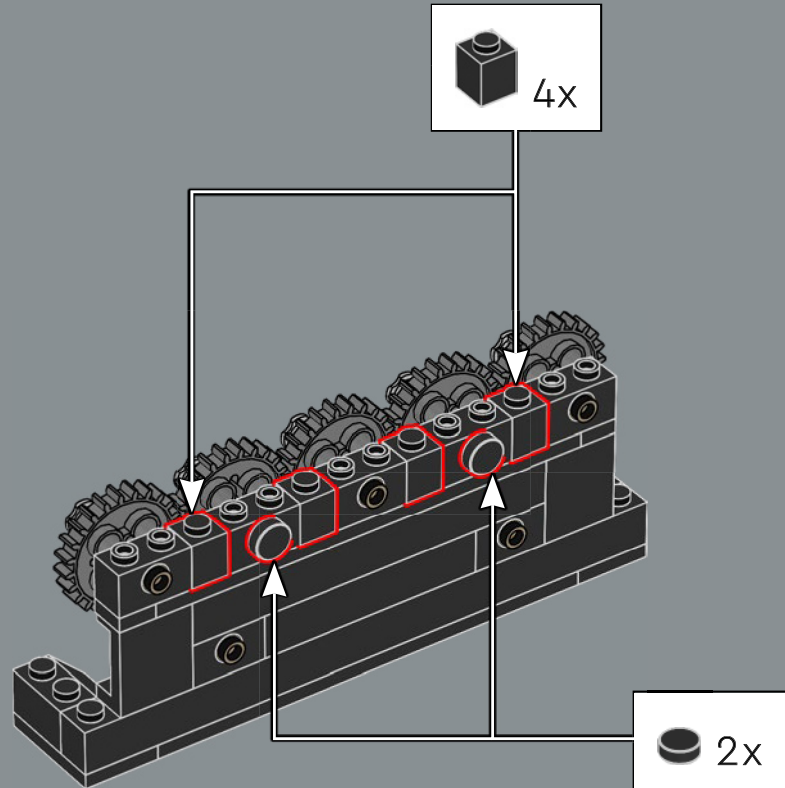

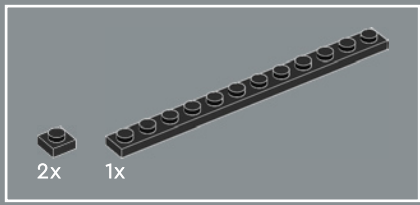

9

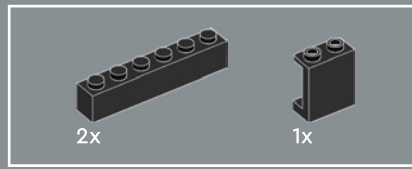
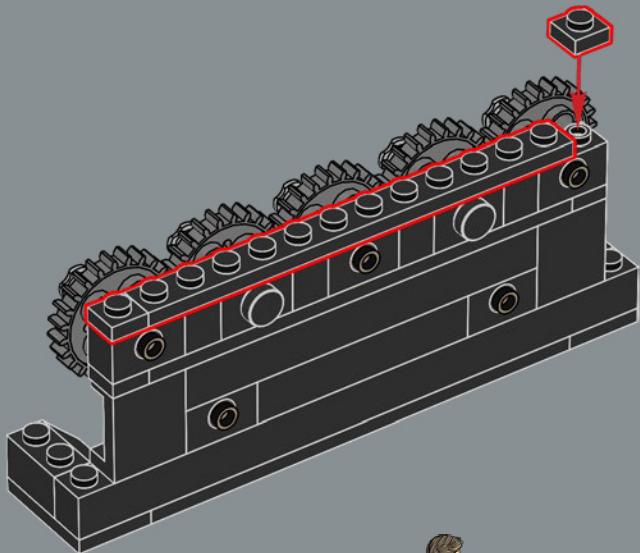

10

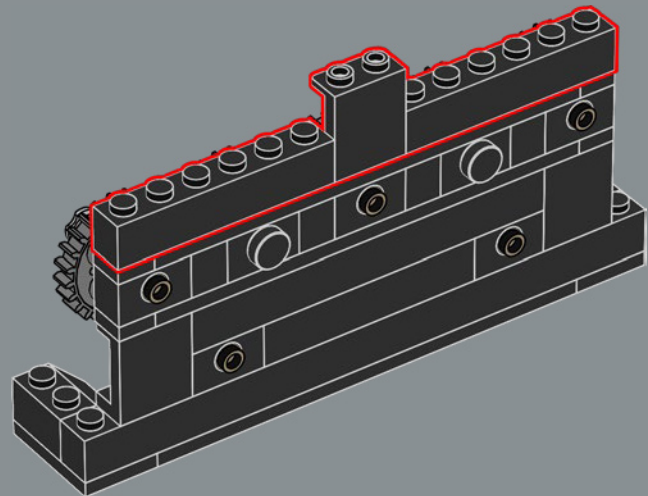

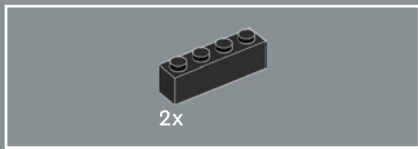

11

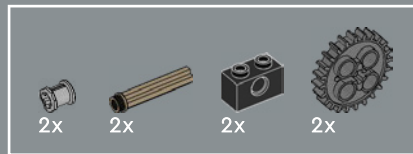
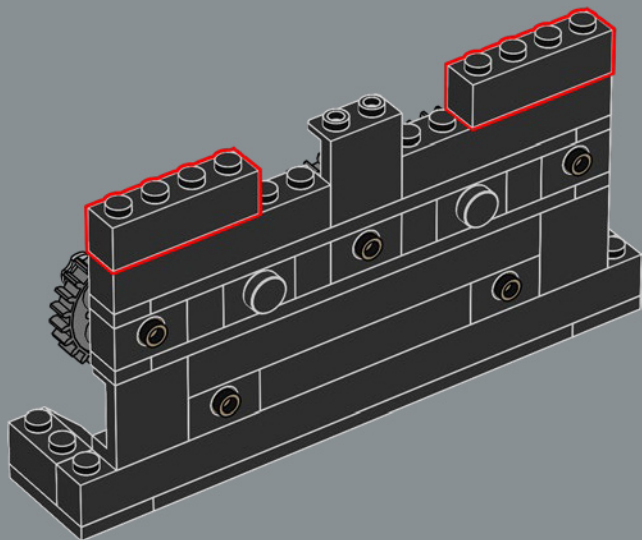

12

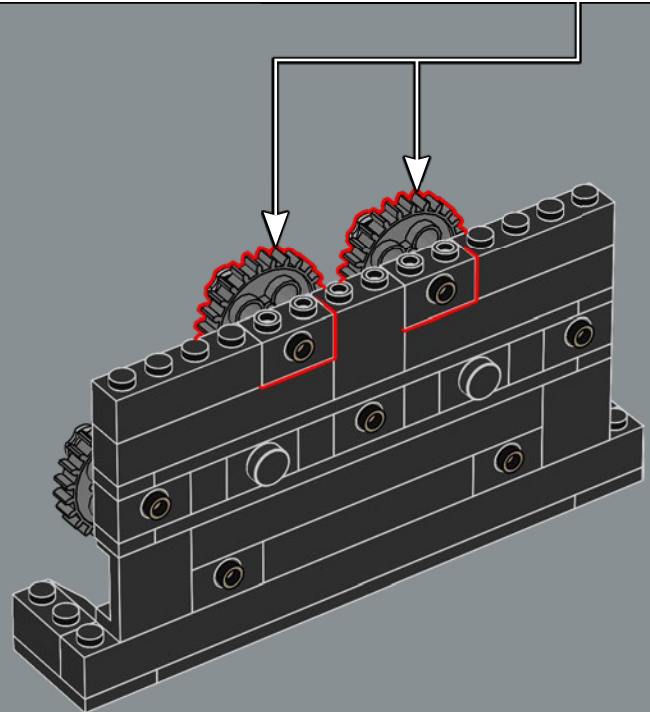
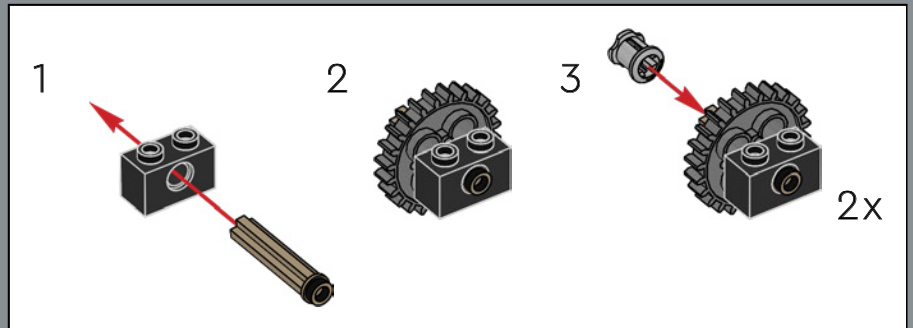

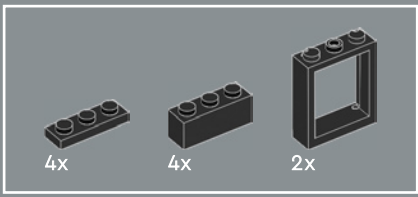

13

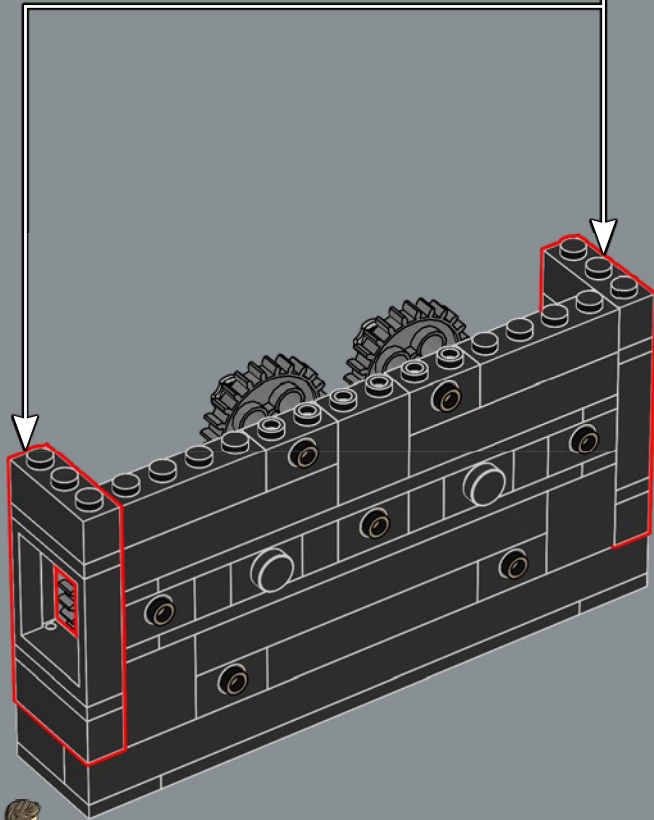
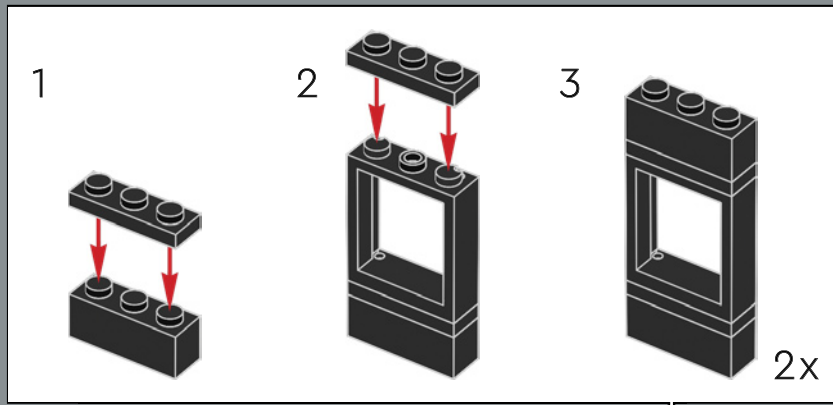

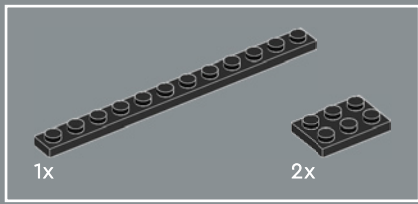

14

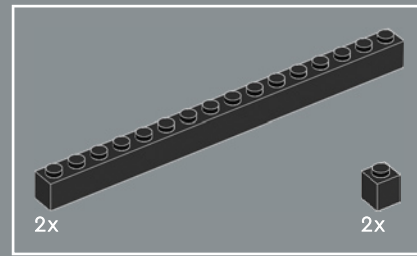
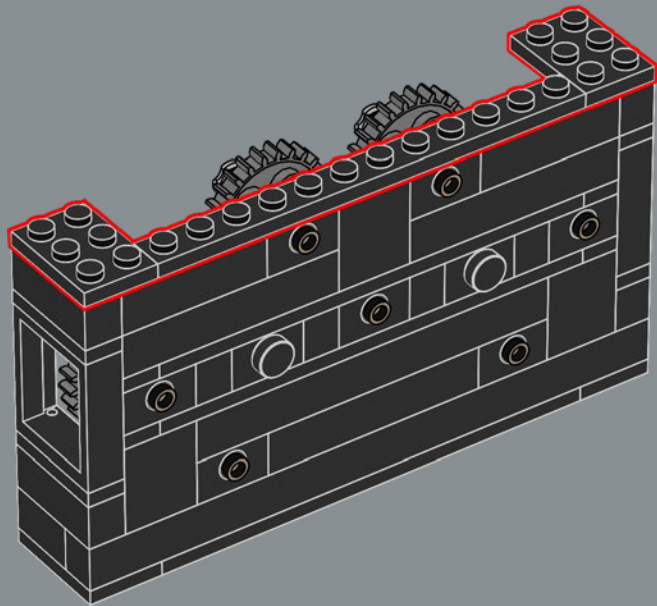

15

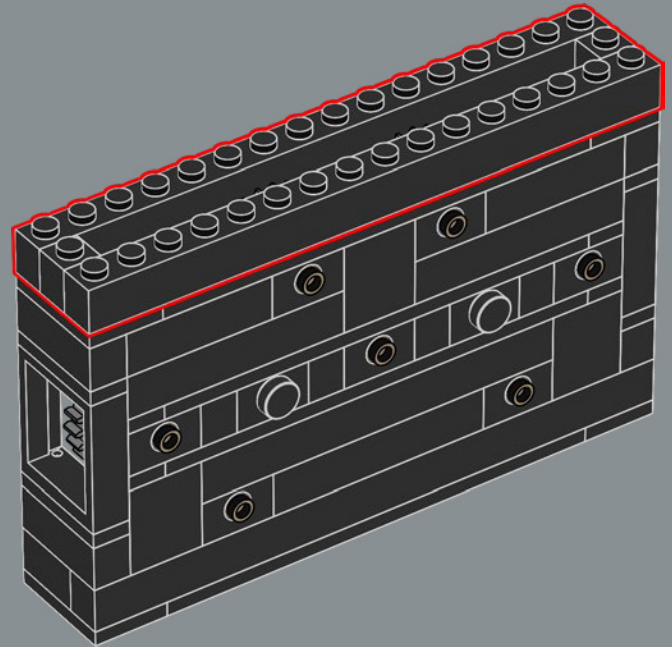

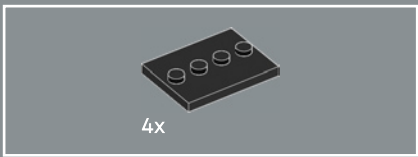

16

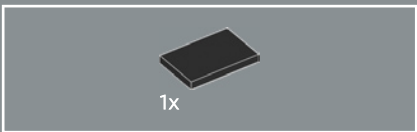
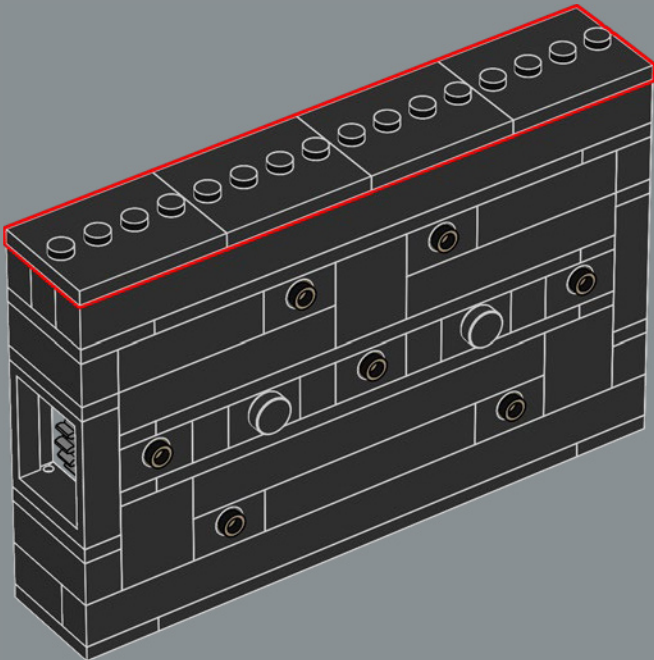

17

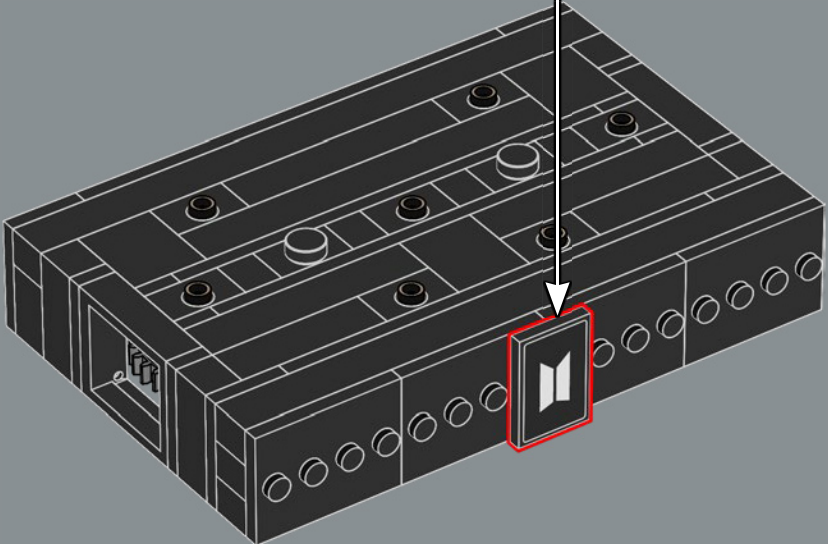
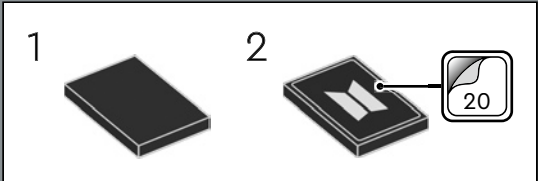

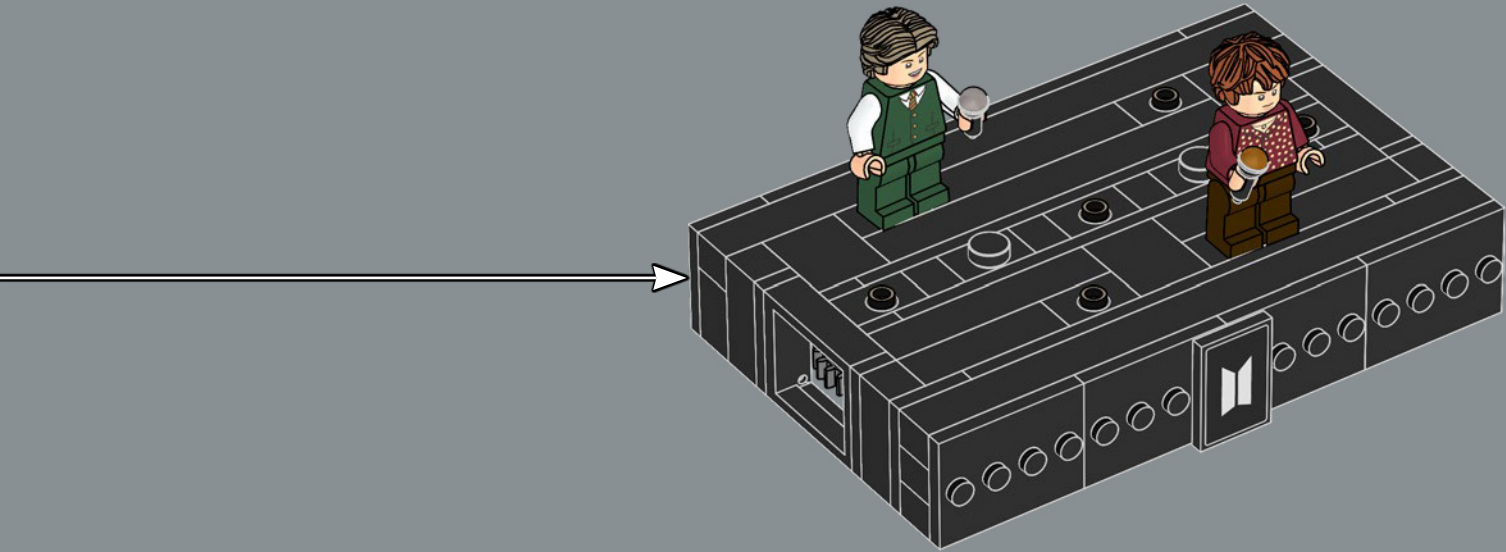

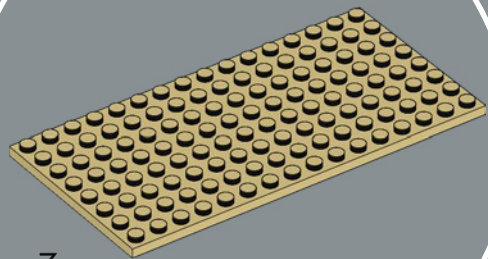
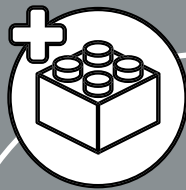

3x

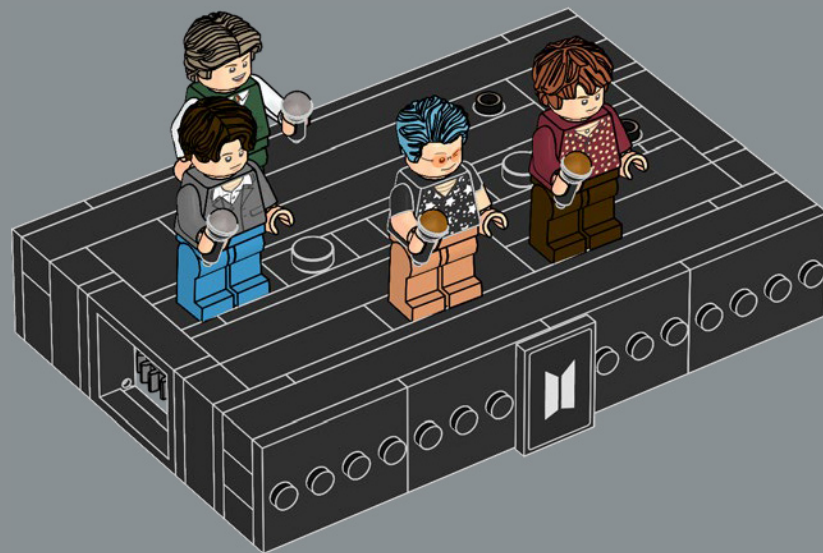
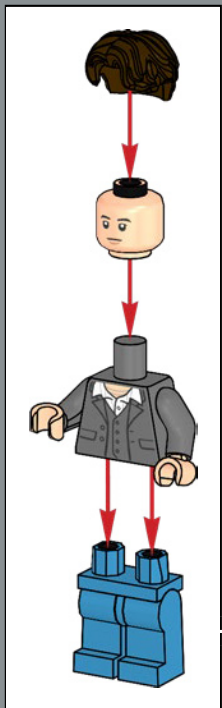

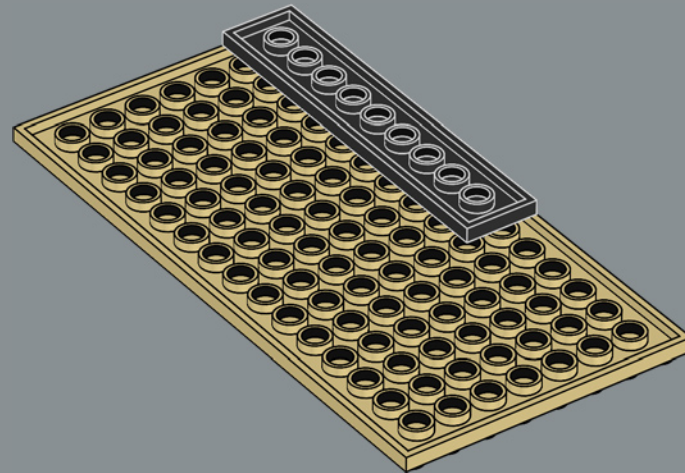
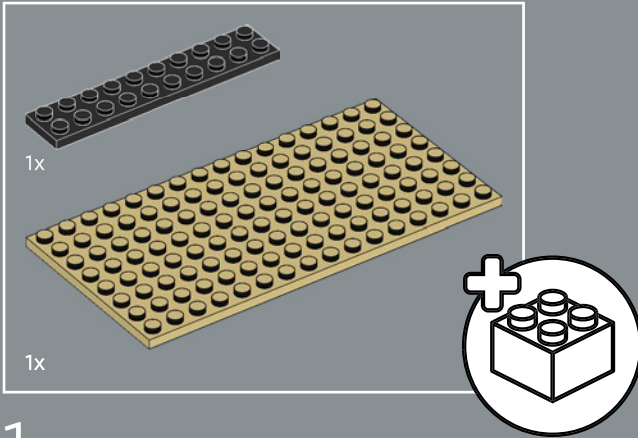
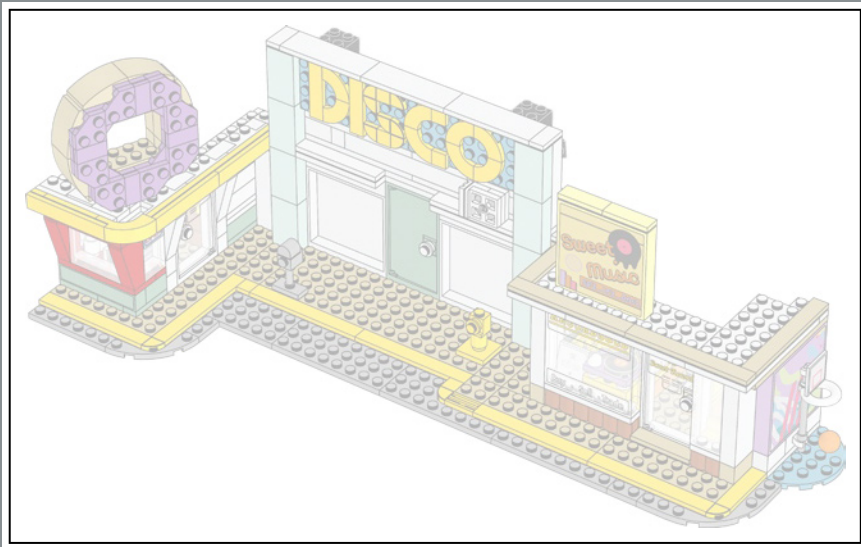

1

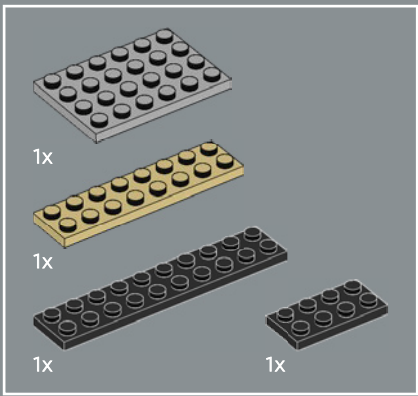

2

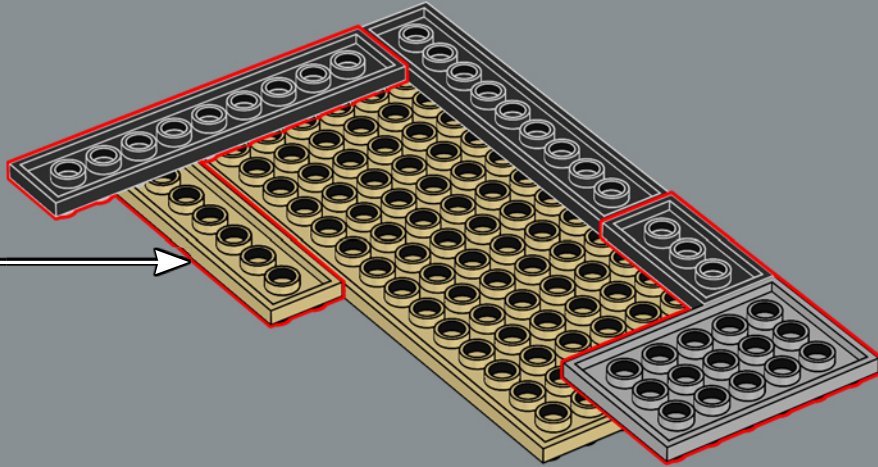
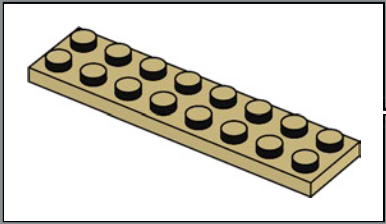

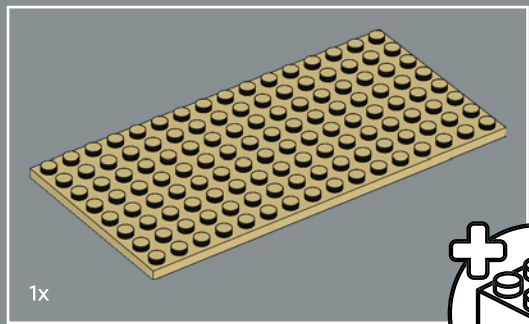

1x

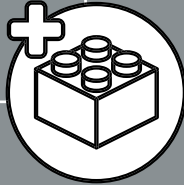

3

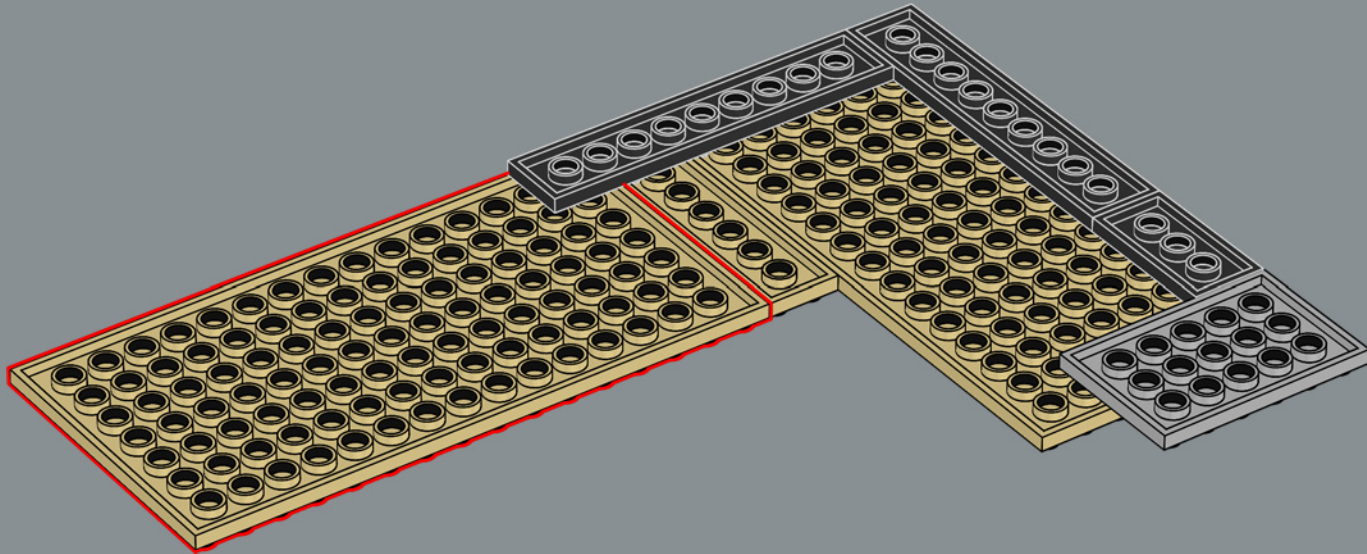

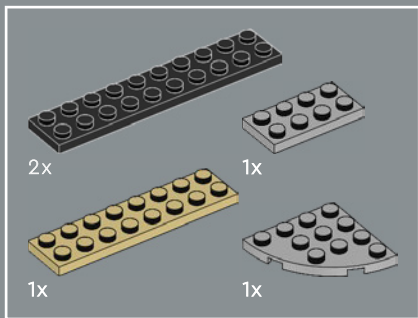

4

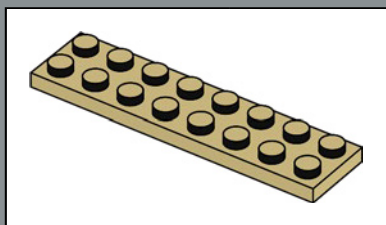
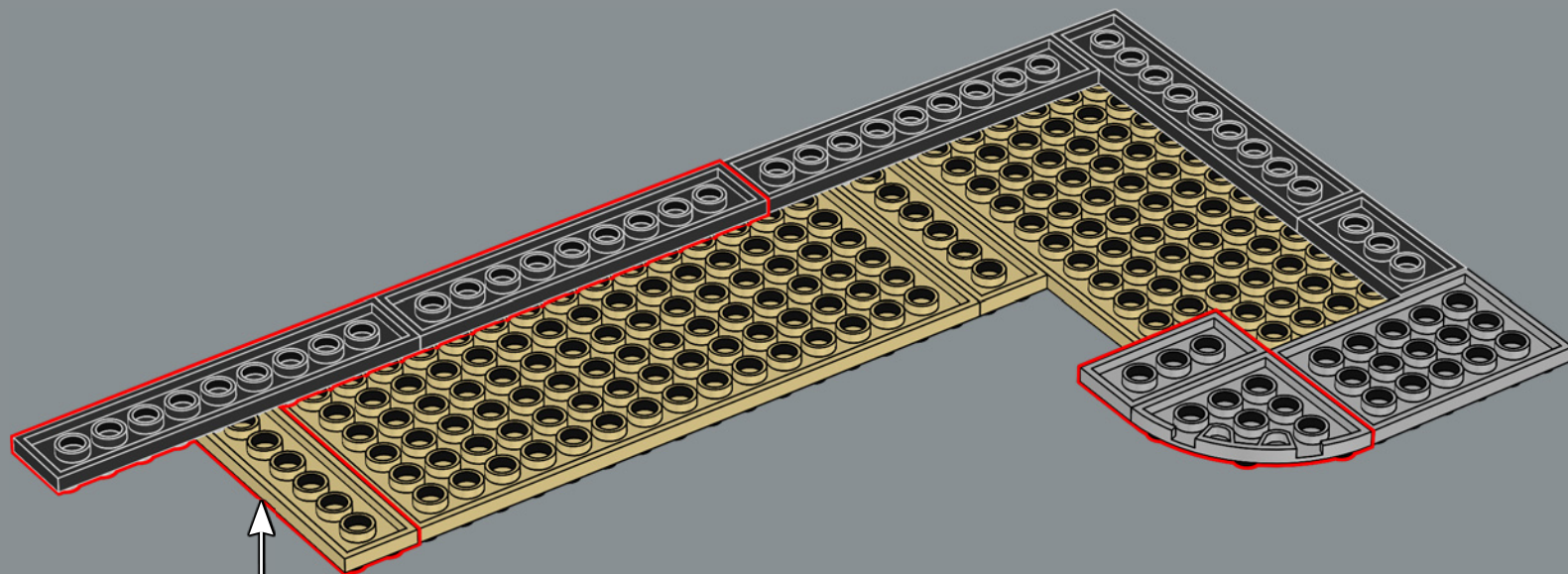

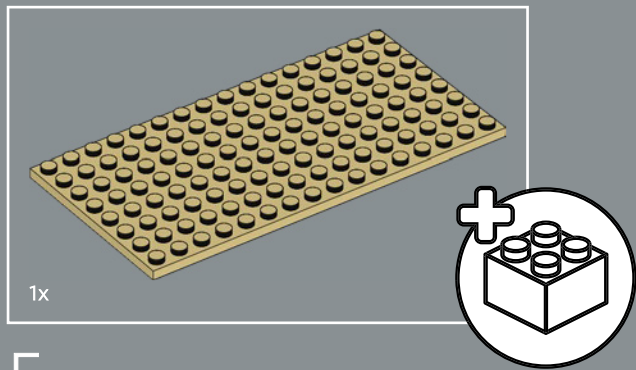

5

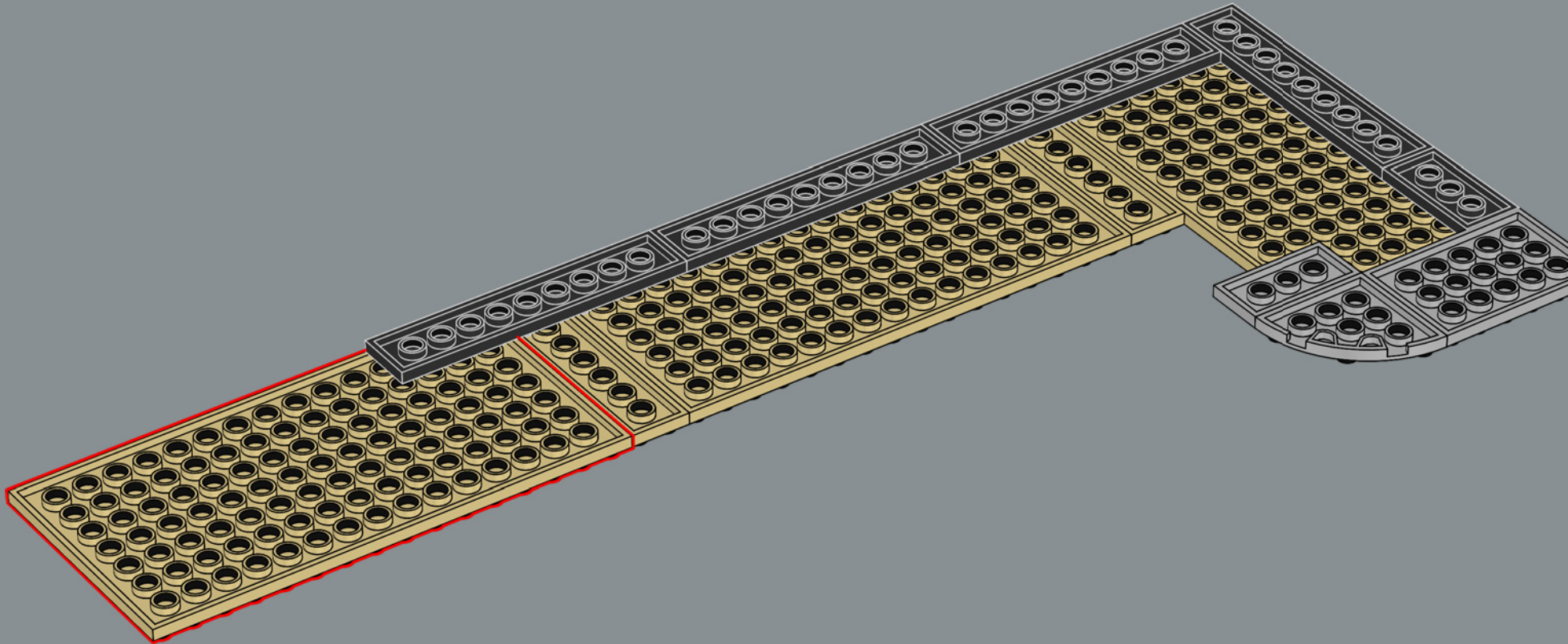

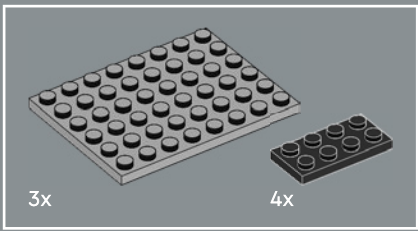

6

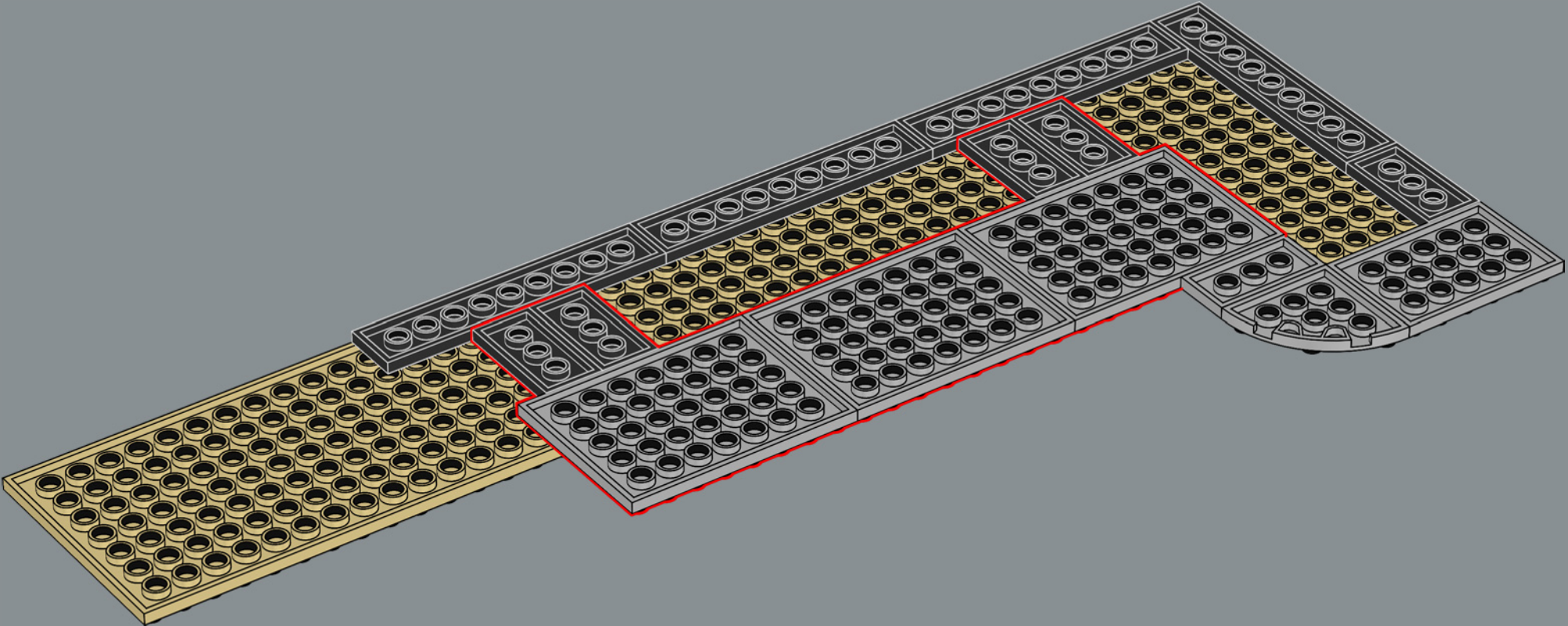

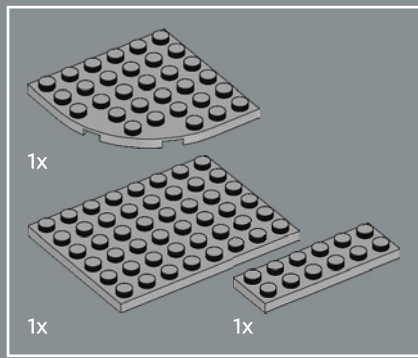

7

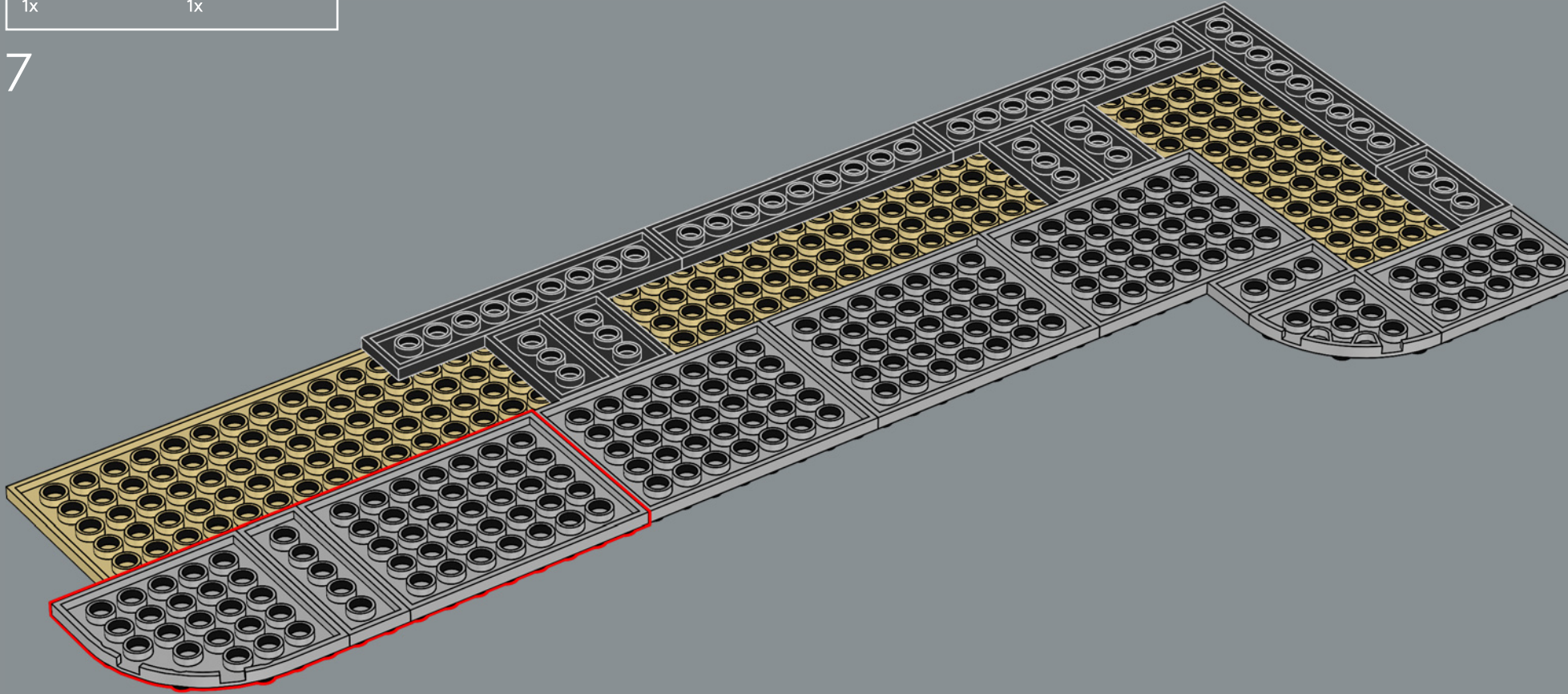

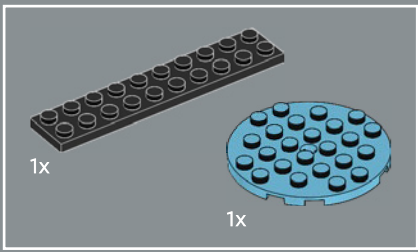

8

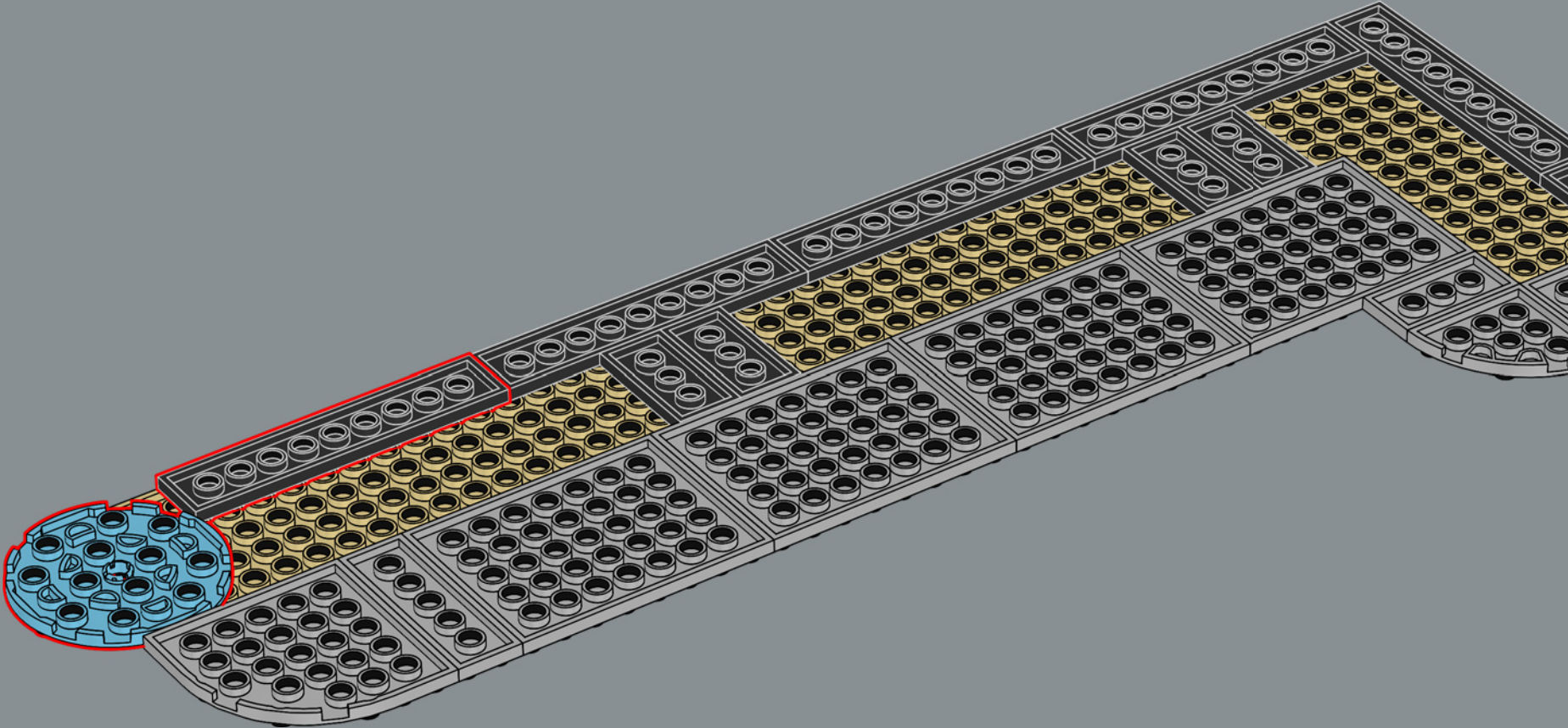

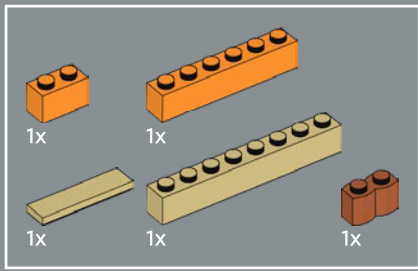

9

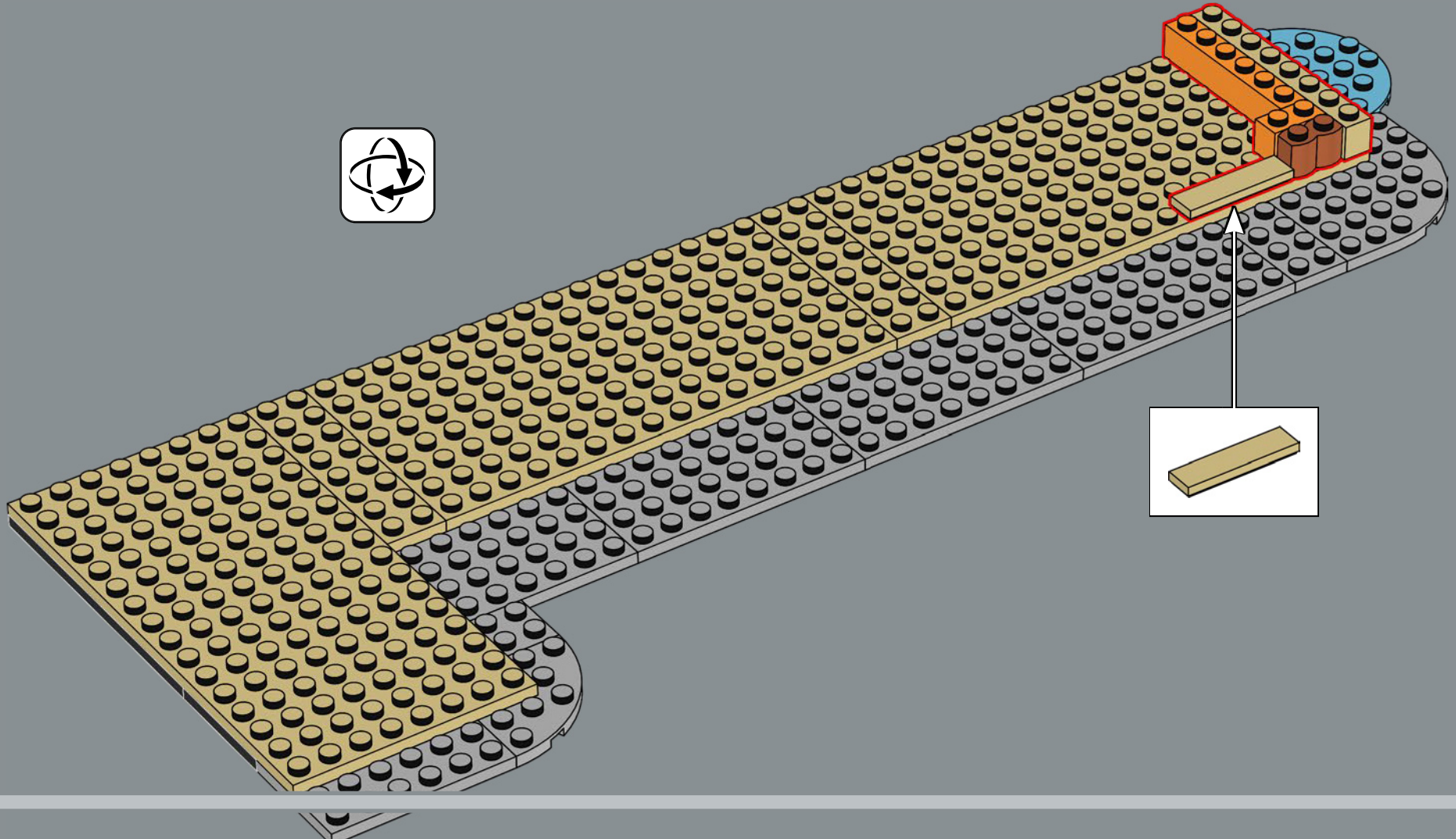

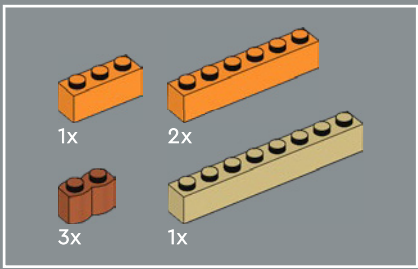

10

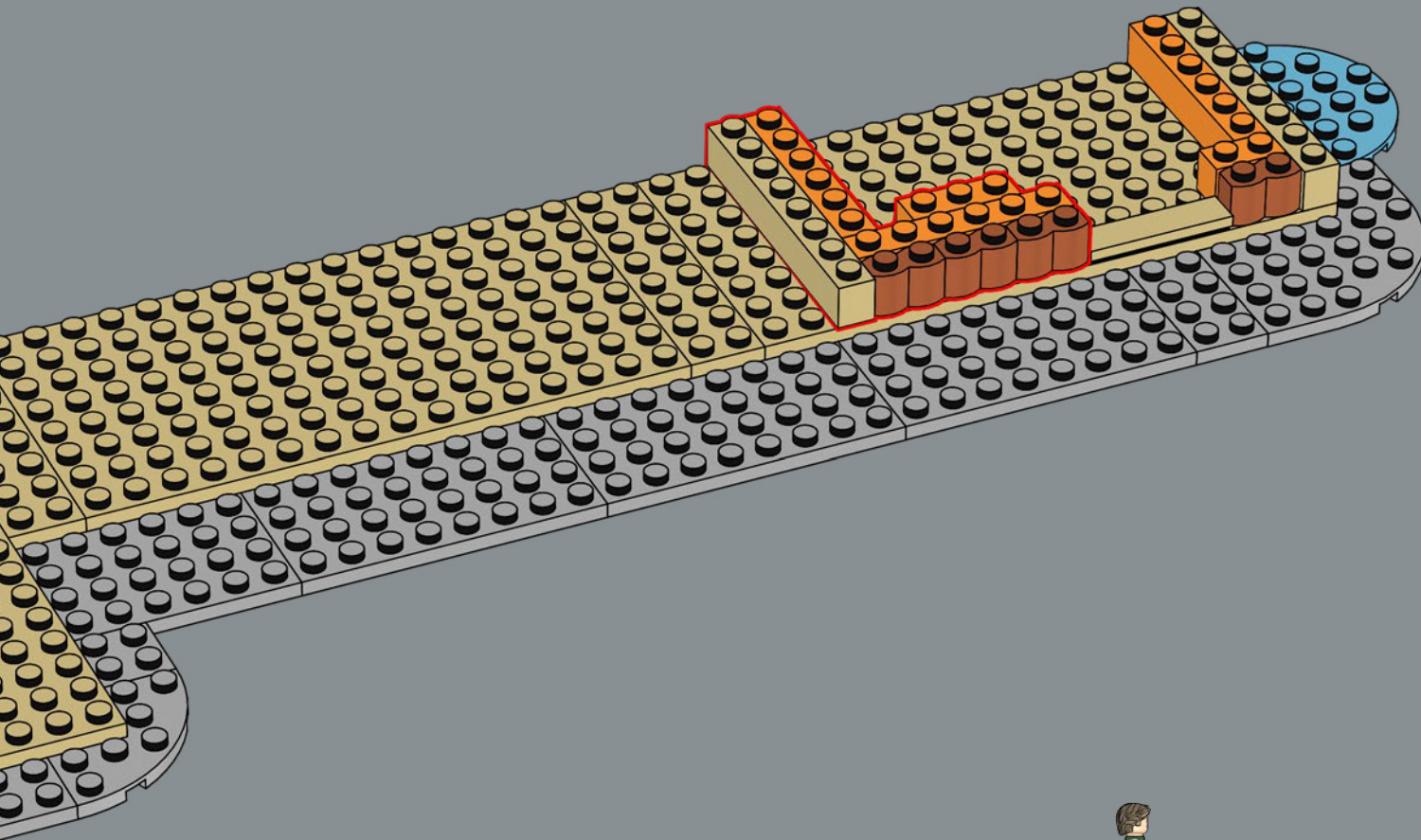

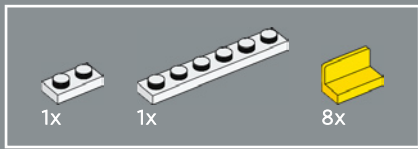

11

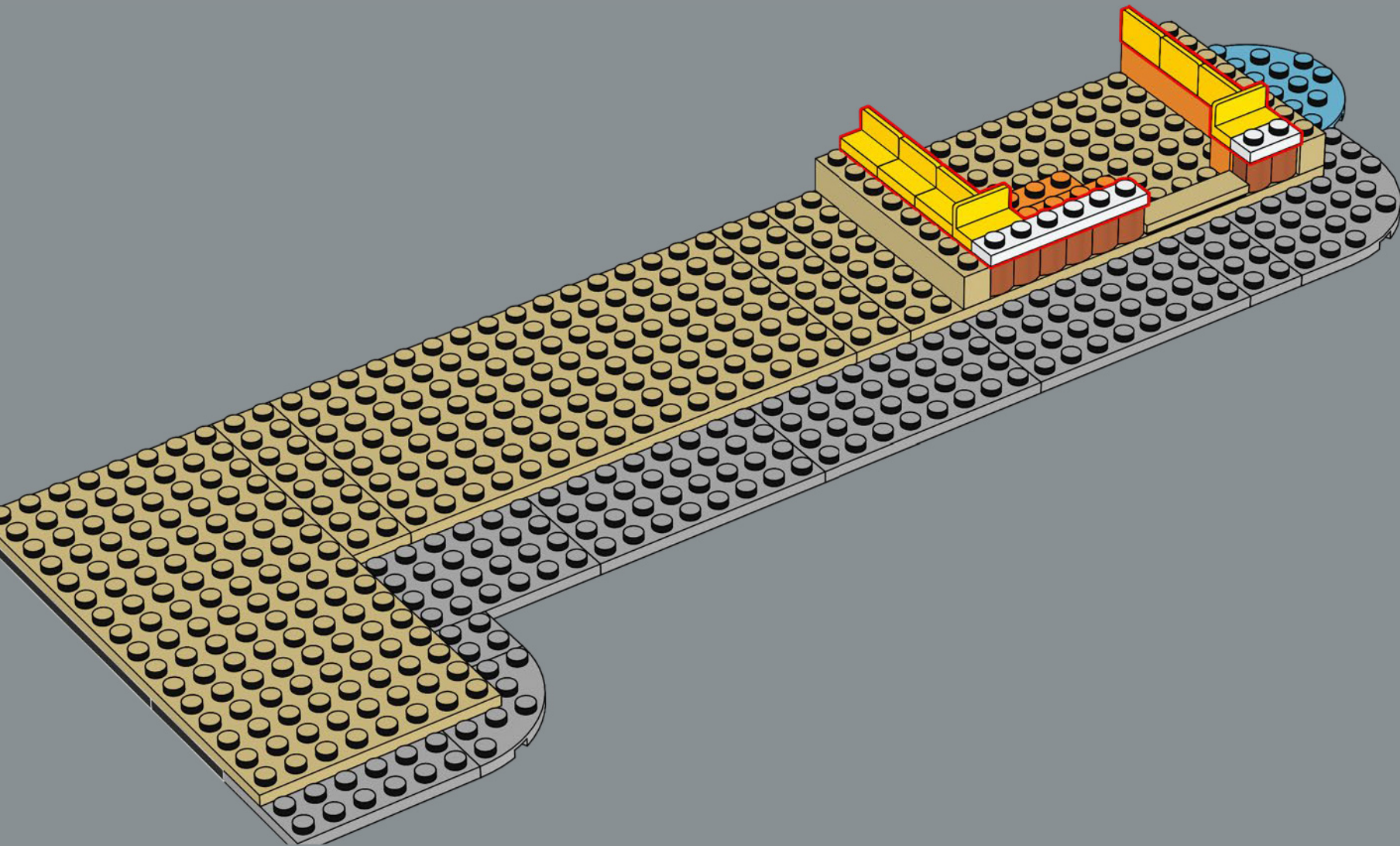

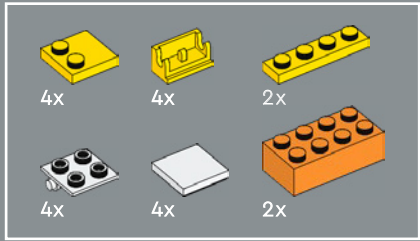
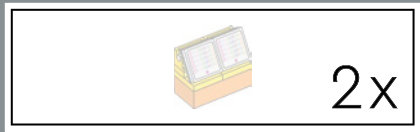

12

1

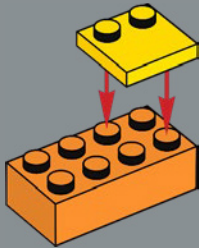

2

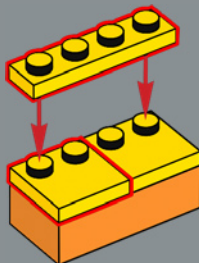

3

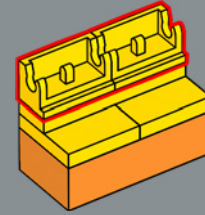

4

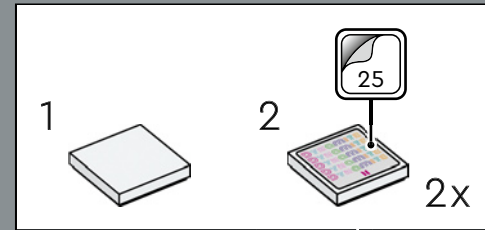
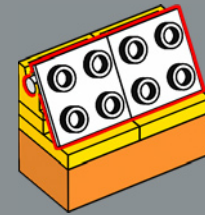

5

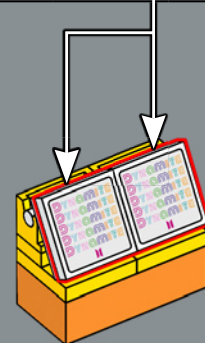

2x



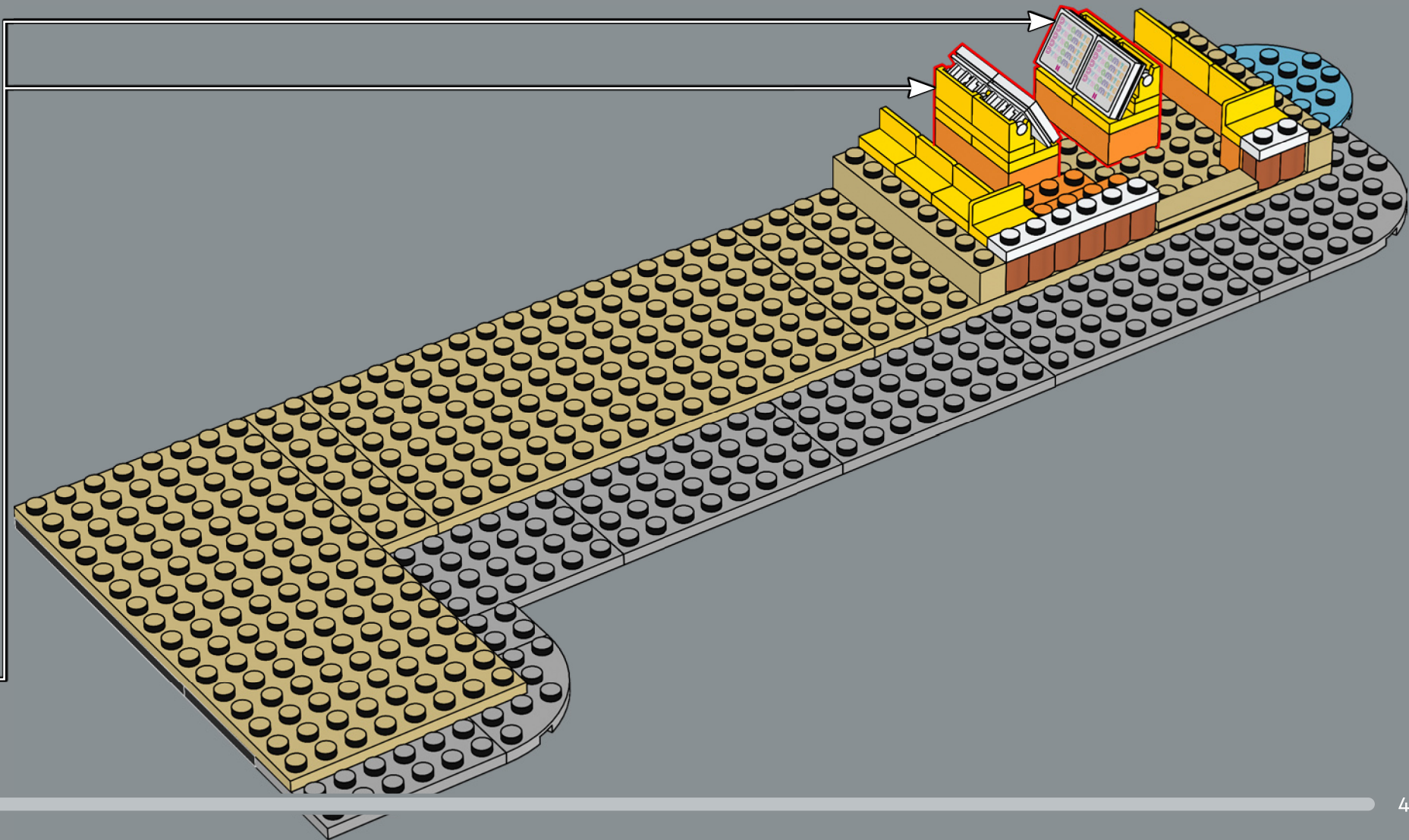

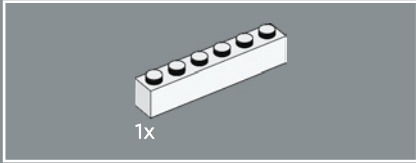

13

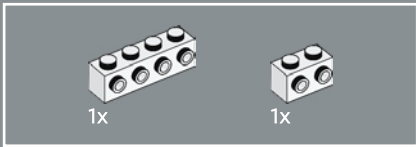
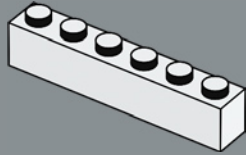

14

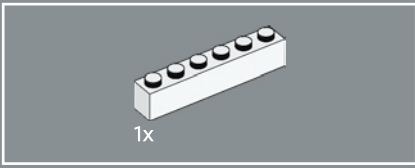
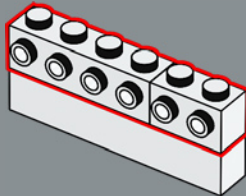

15

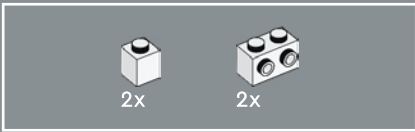
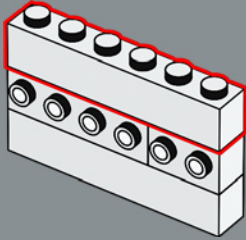

16

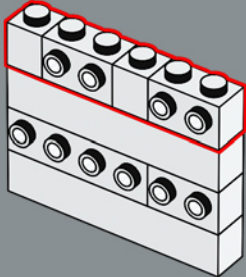

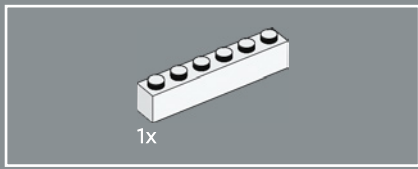

17

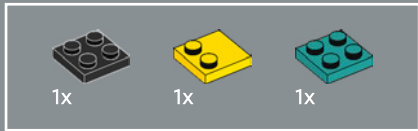
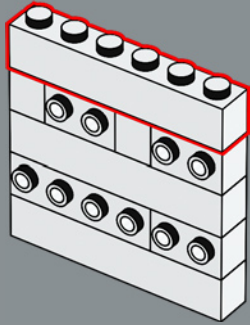

18

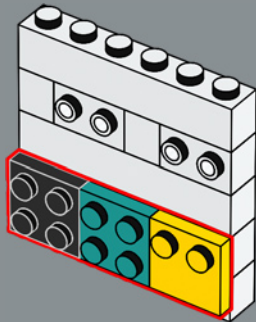

19

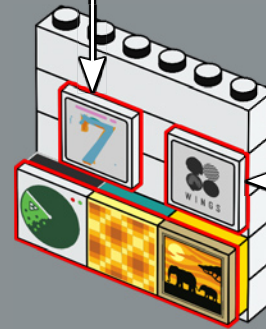
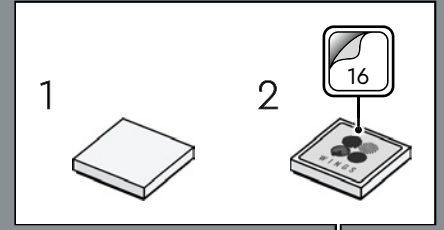
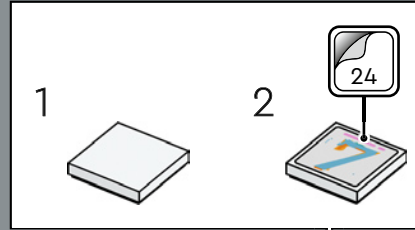

20

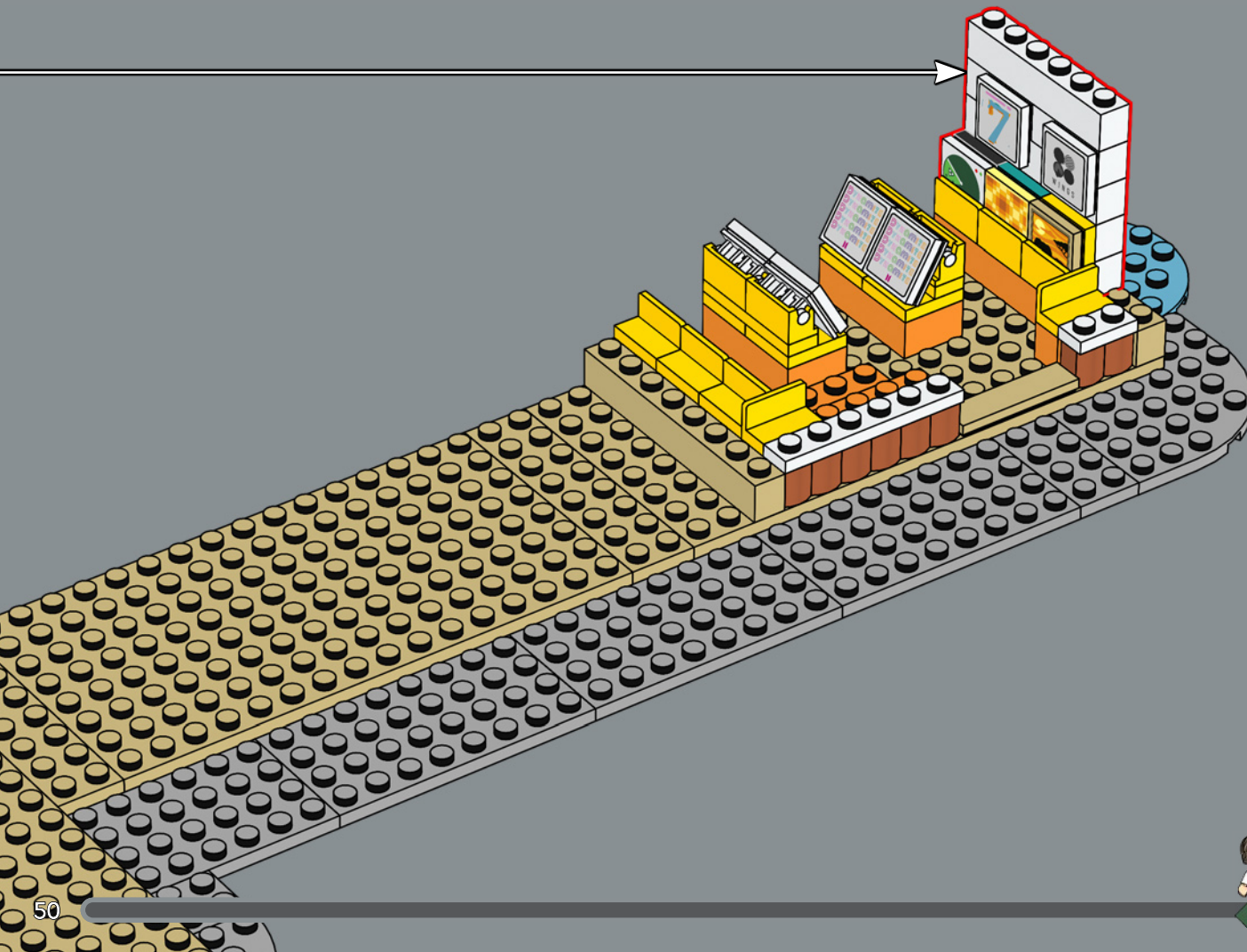

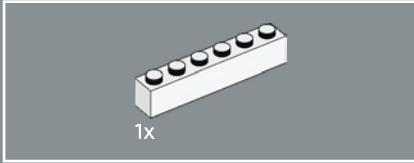

21

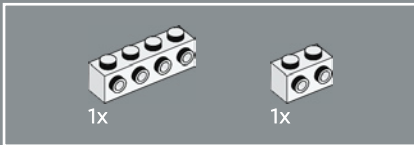
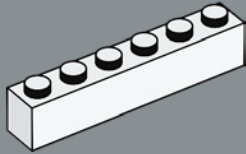

22

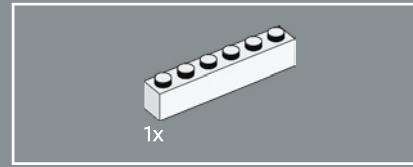
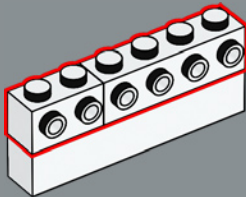

23

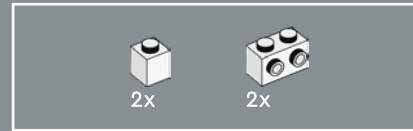
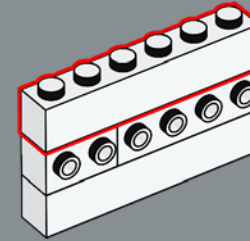

24

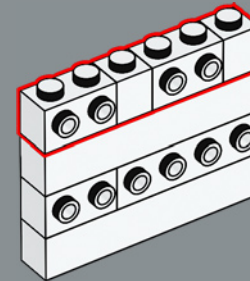

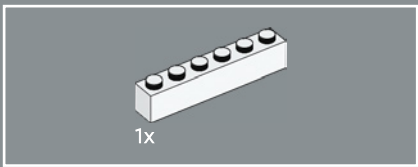

25

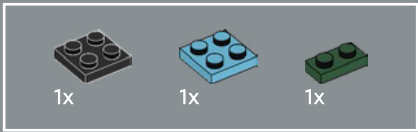
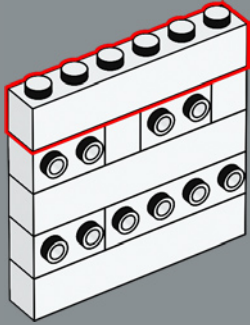

26

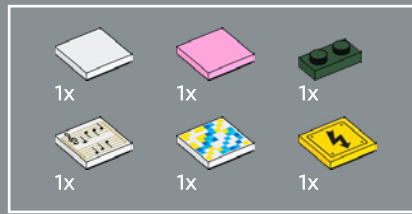
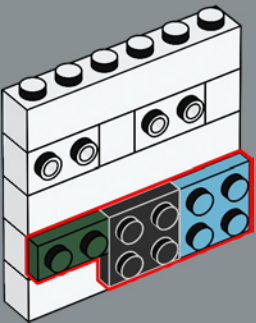

27

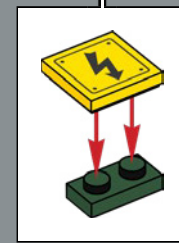
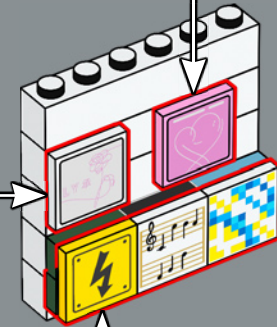
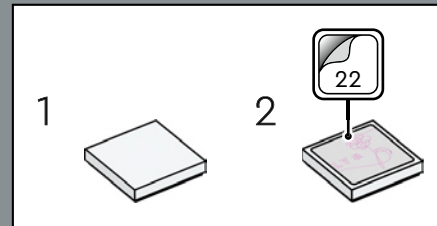
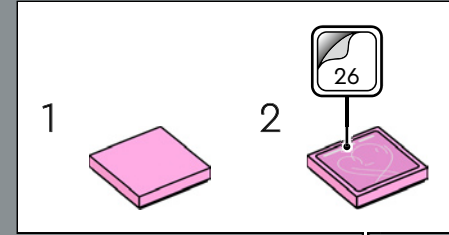

28

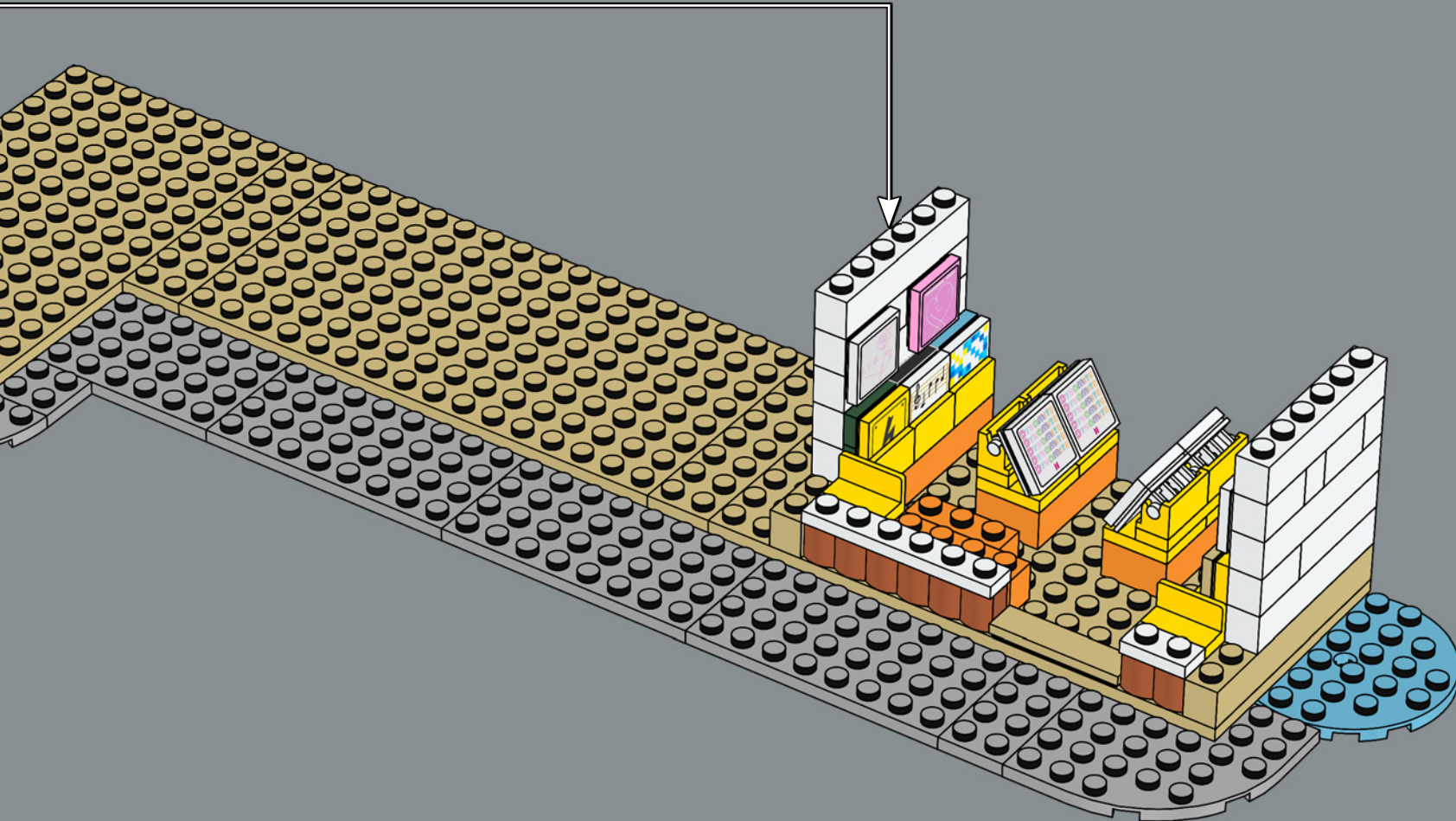

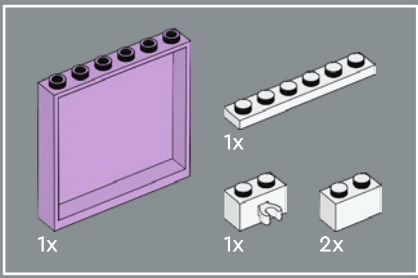

29

1

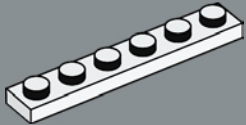

2

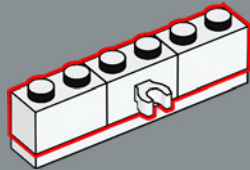

3

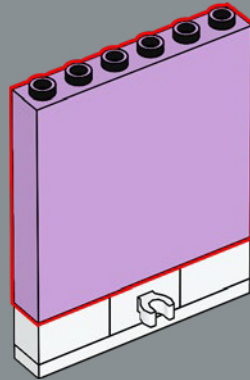

4



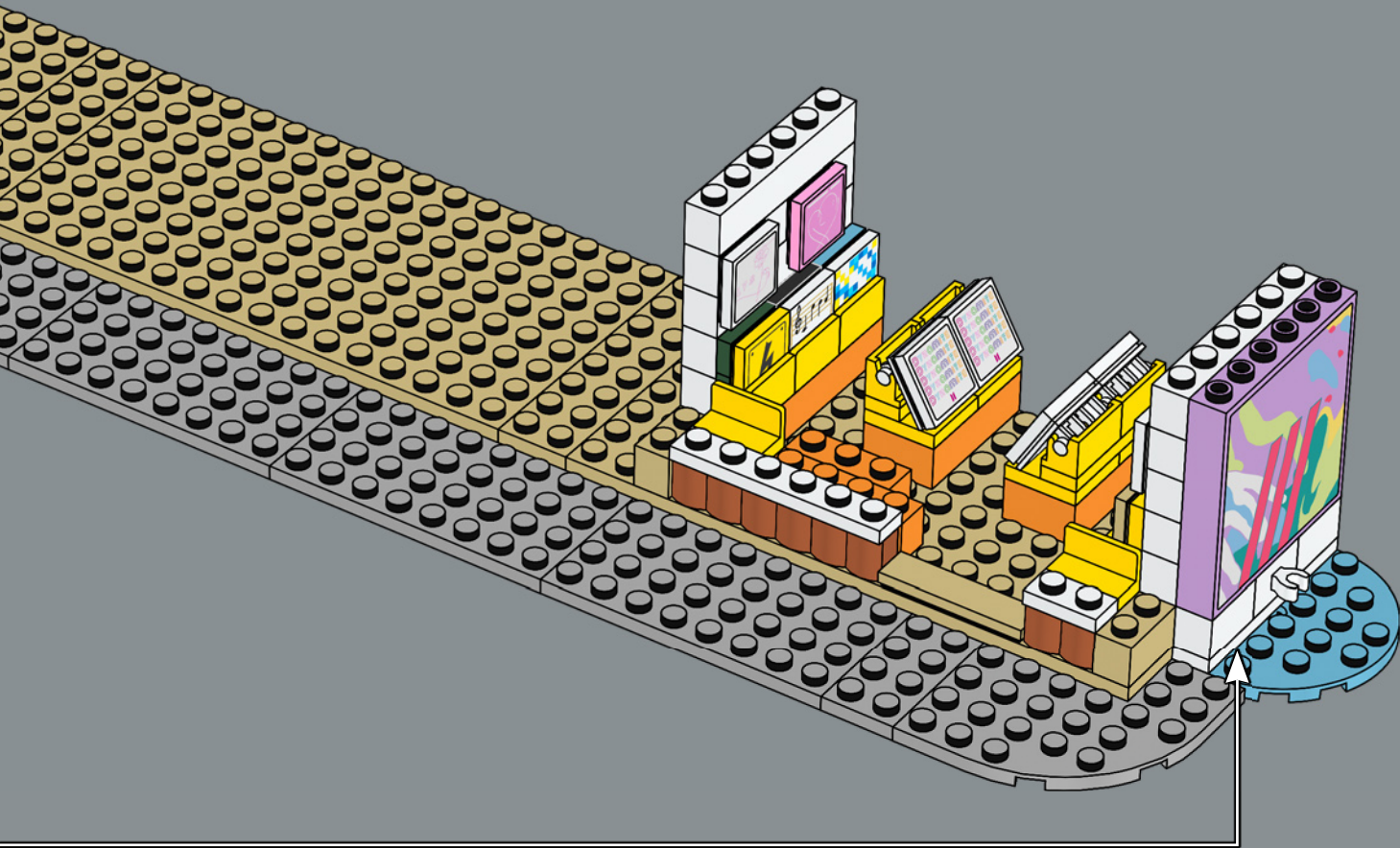

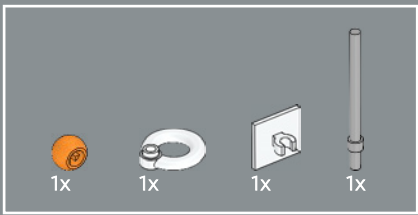

30

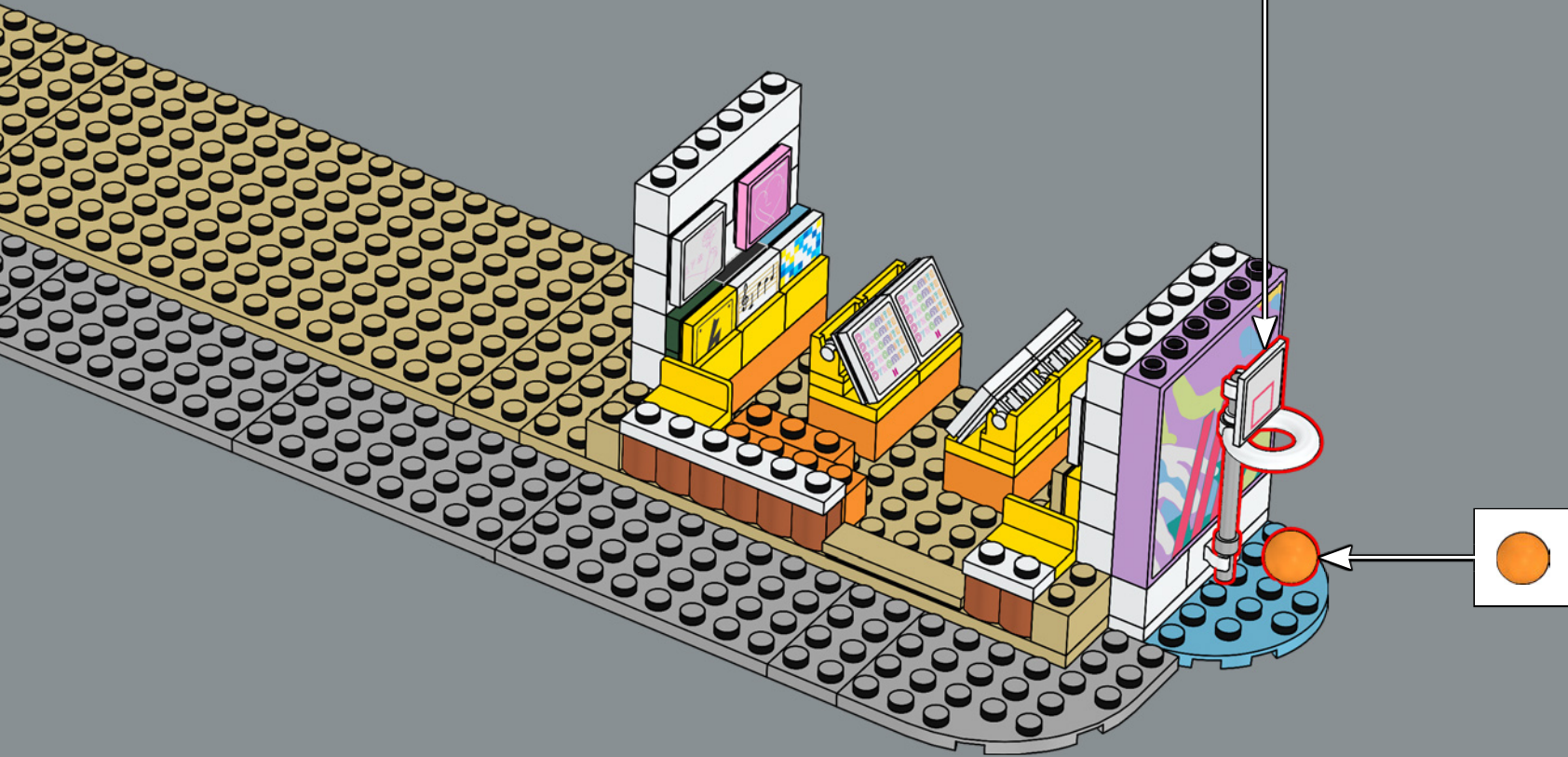
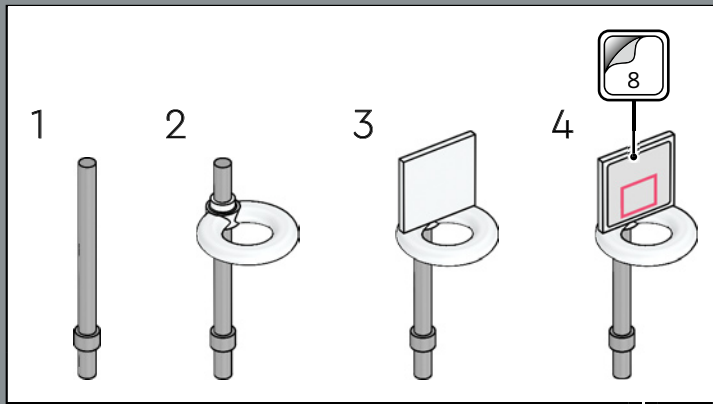

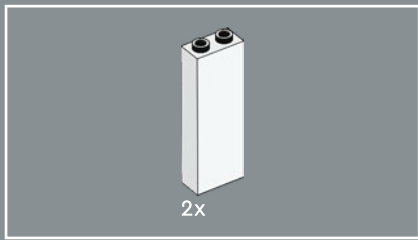

31

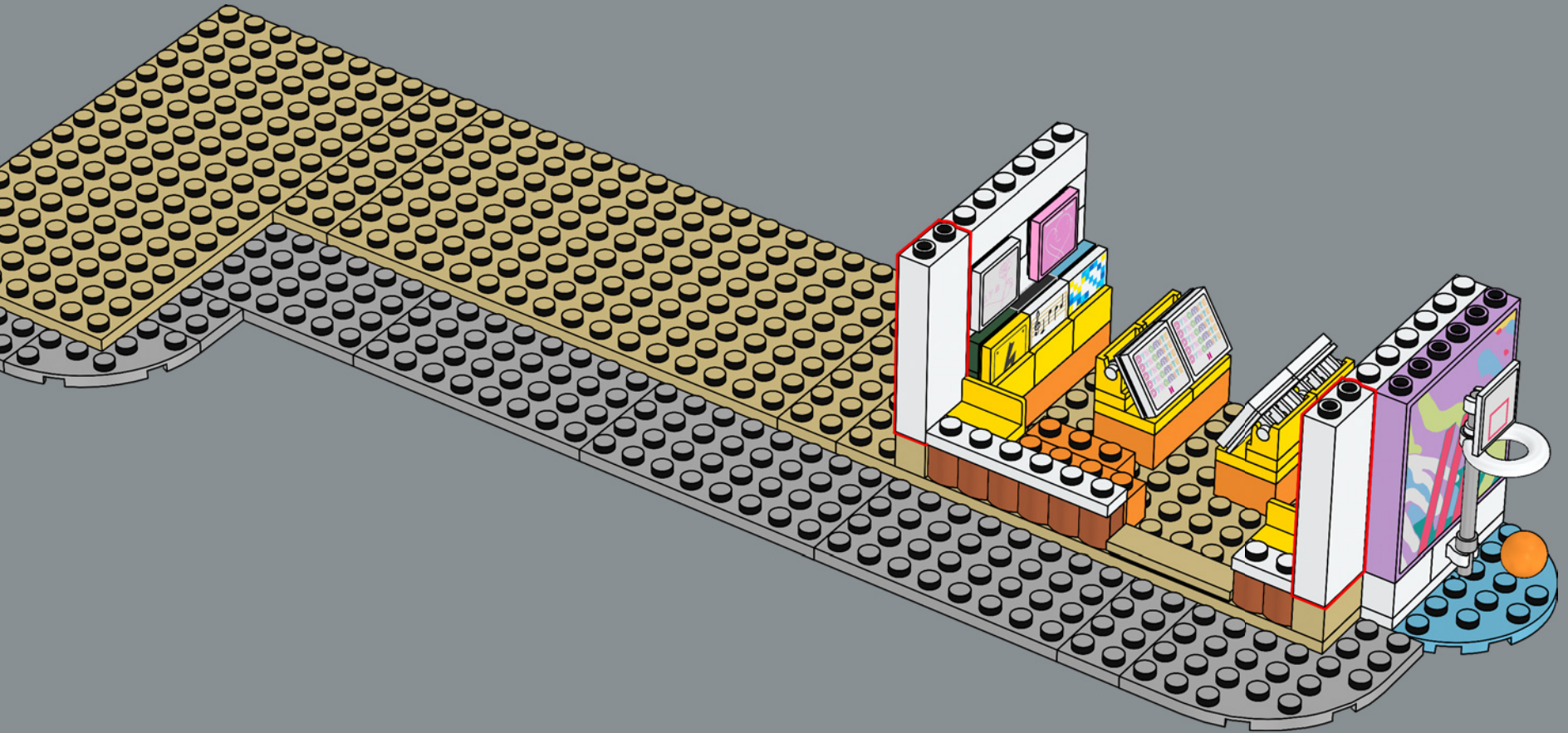

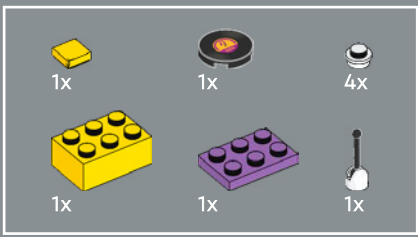

32

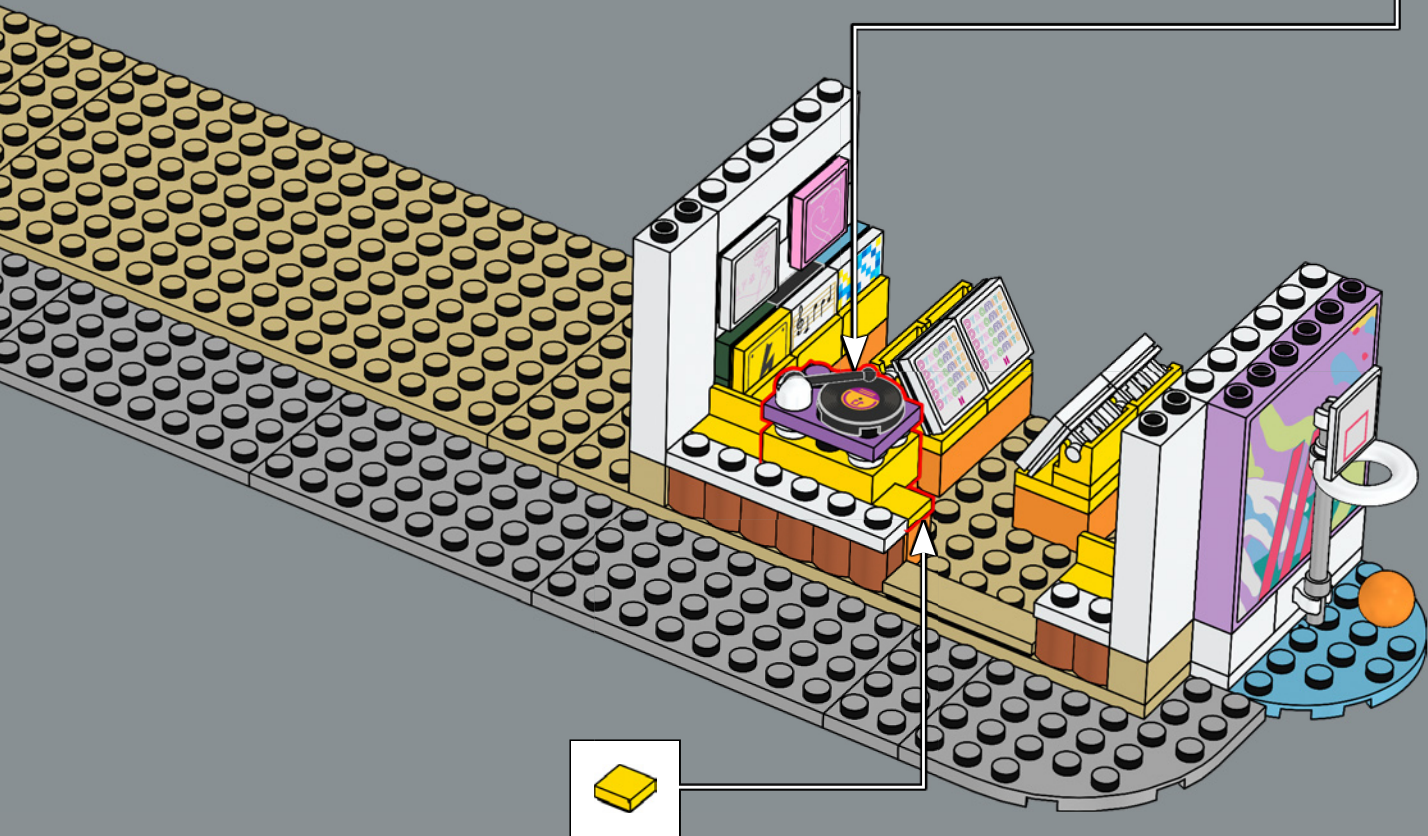
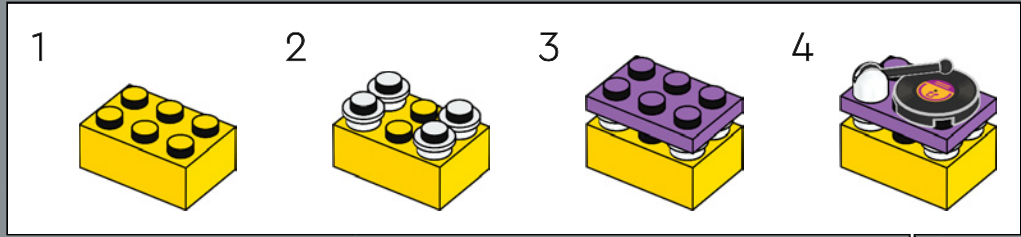

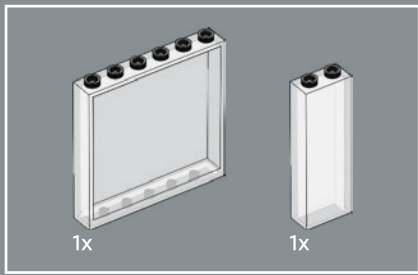

33

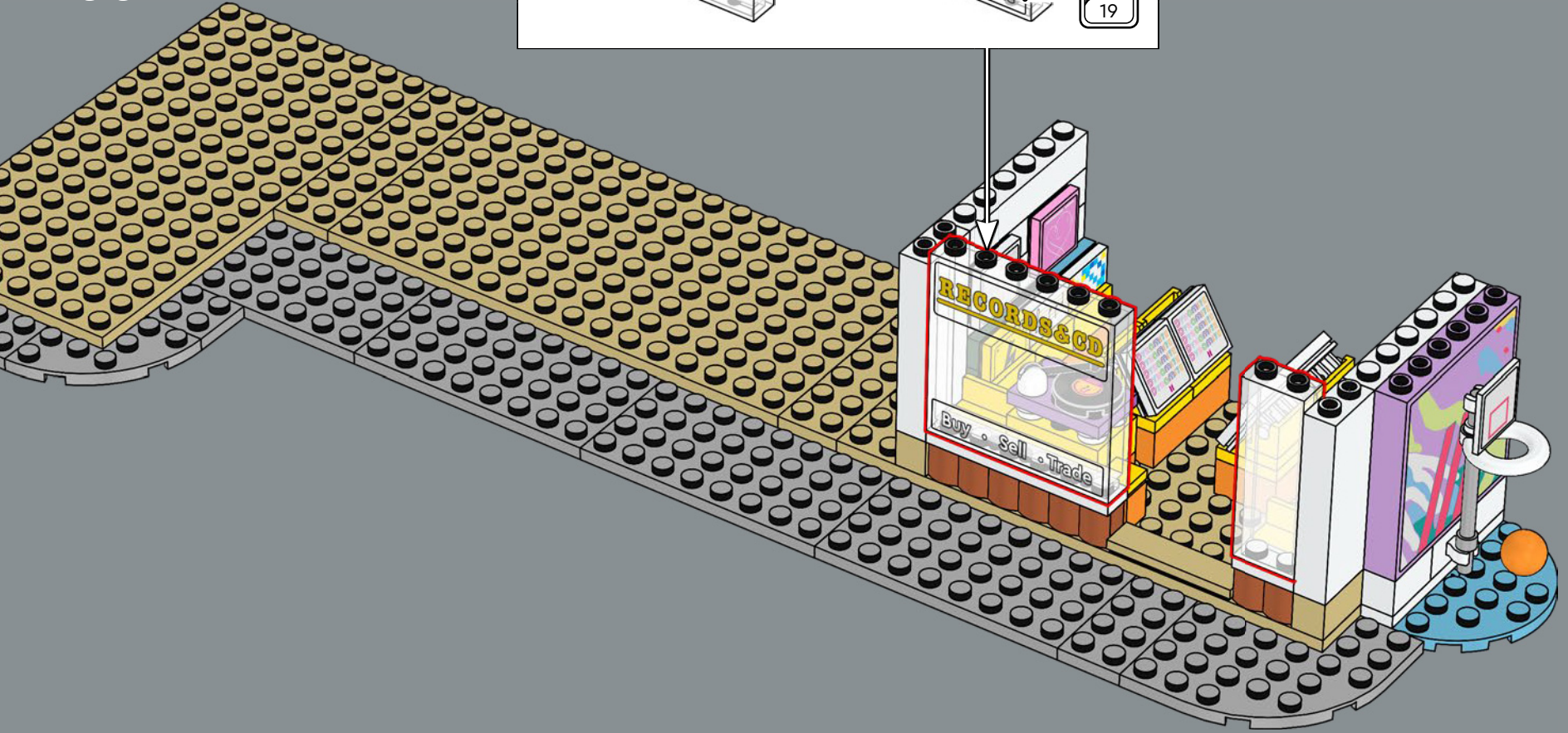
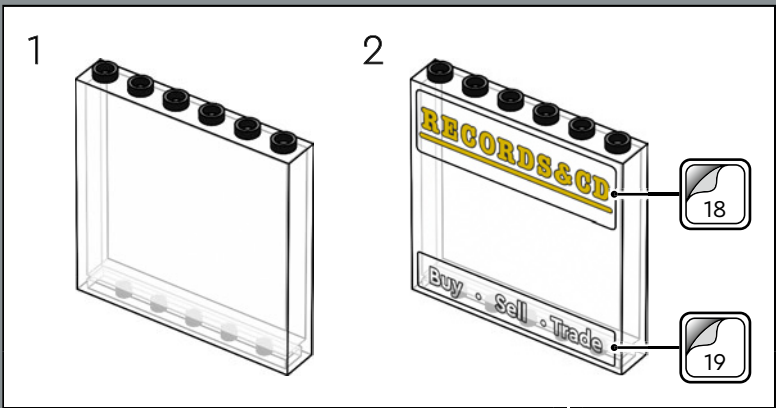

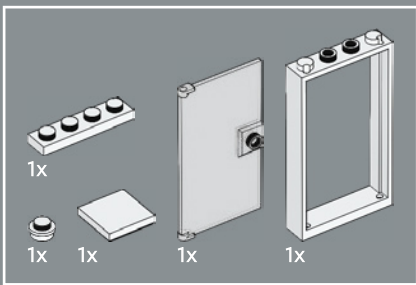

34

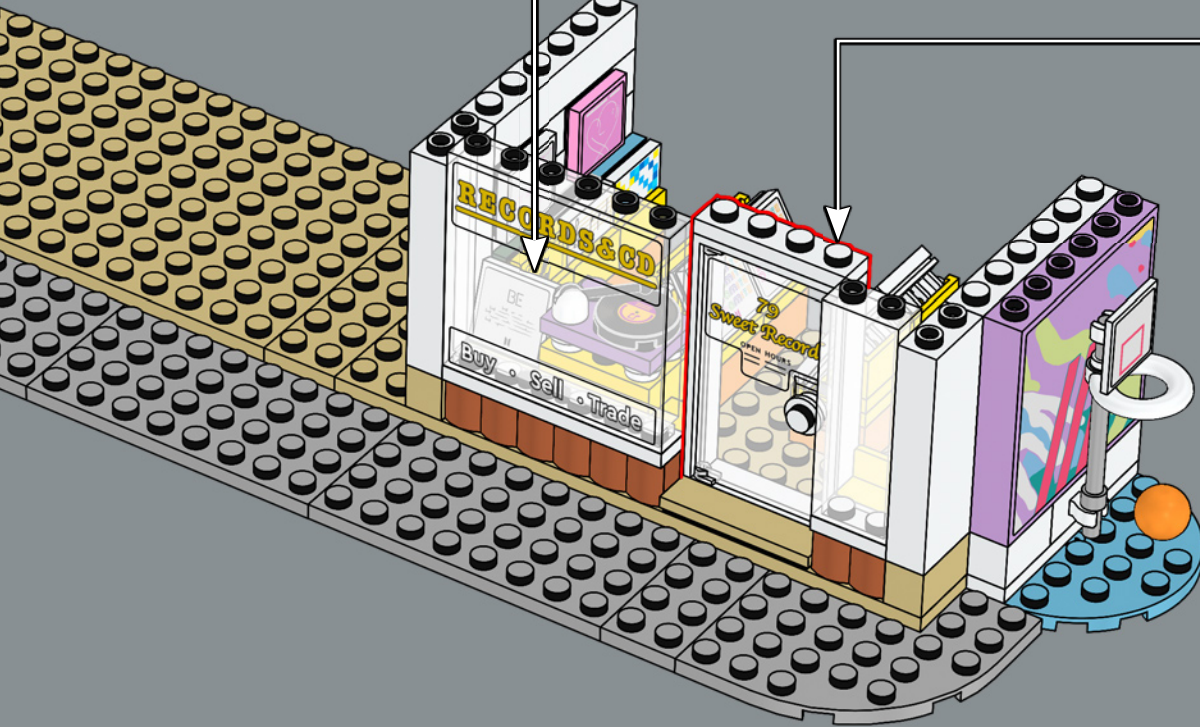
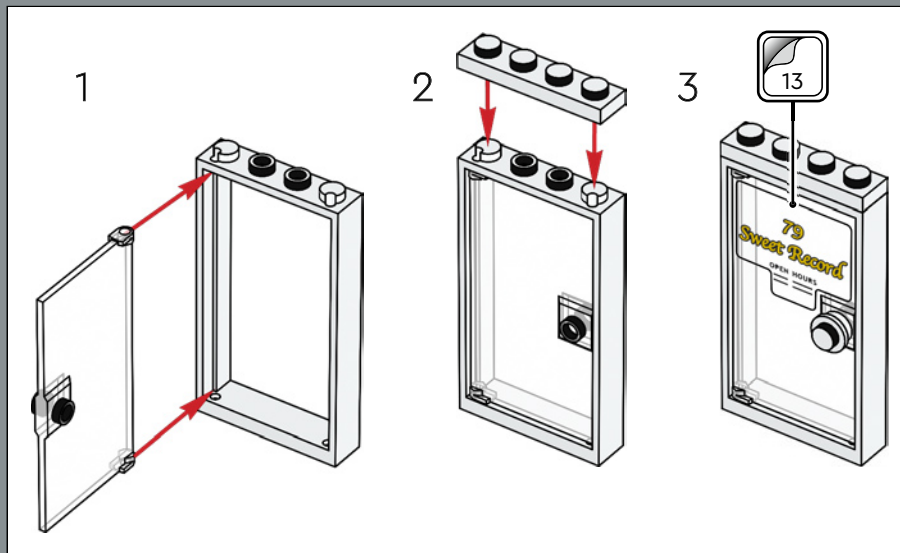
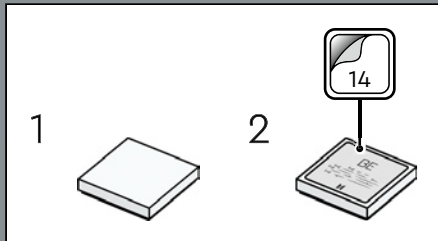

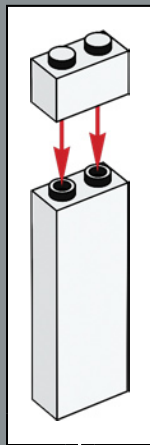
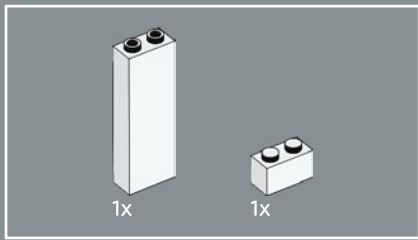

35

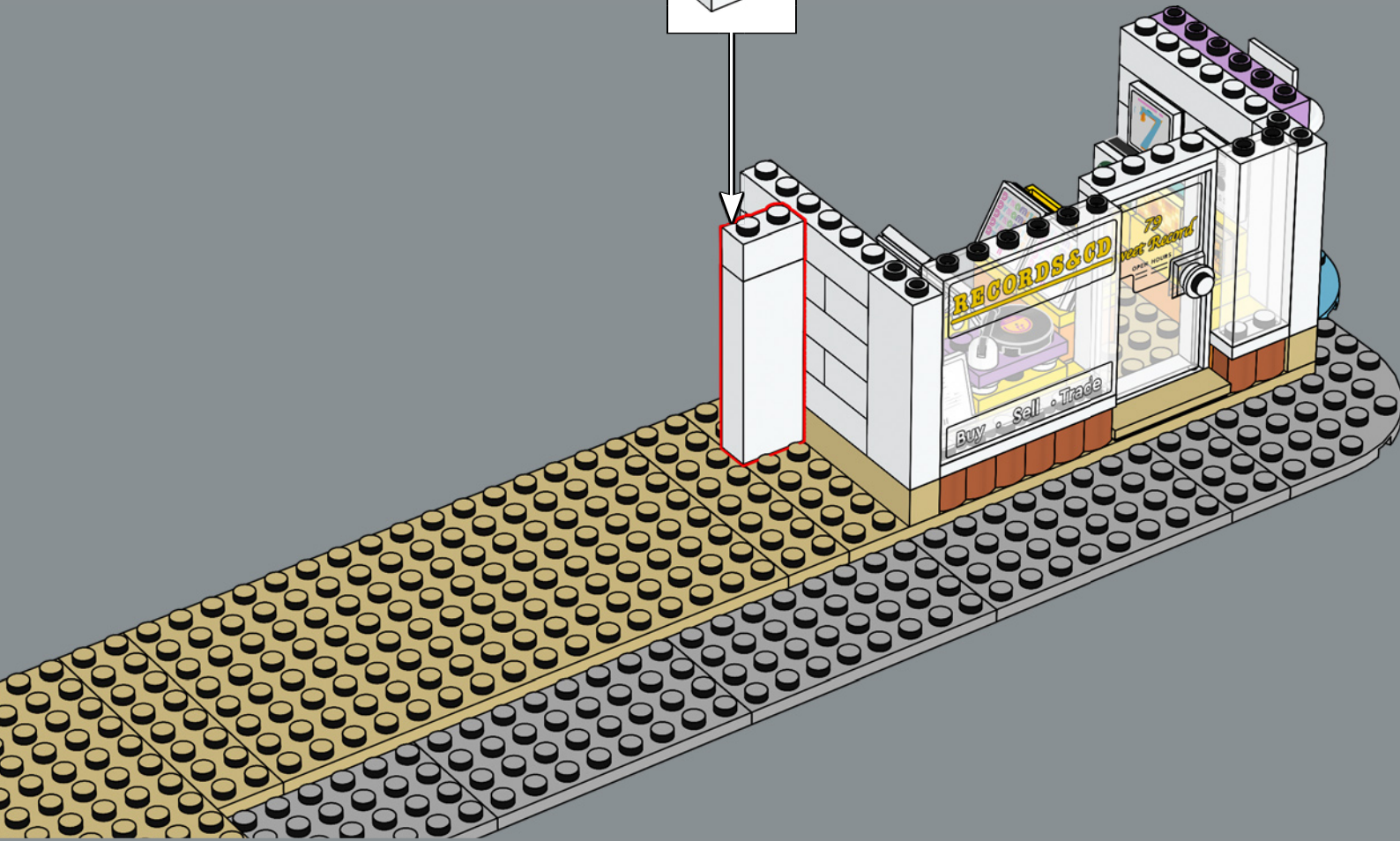

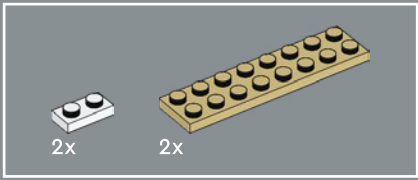

36

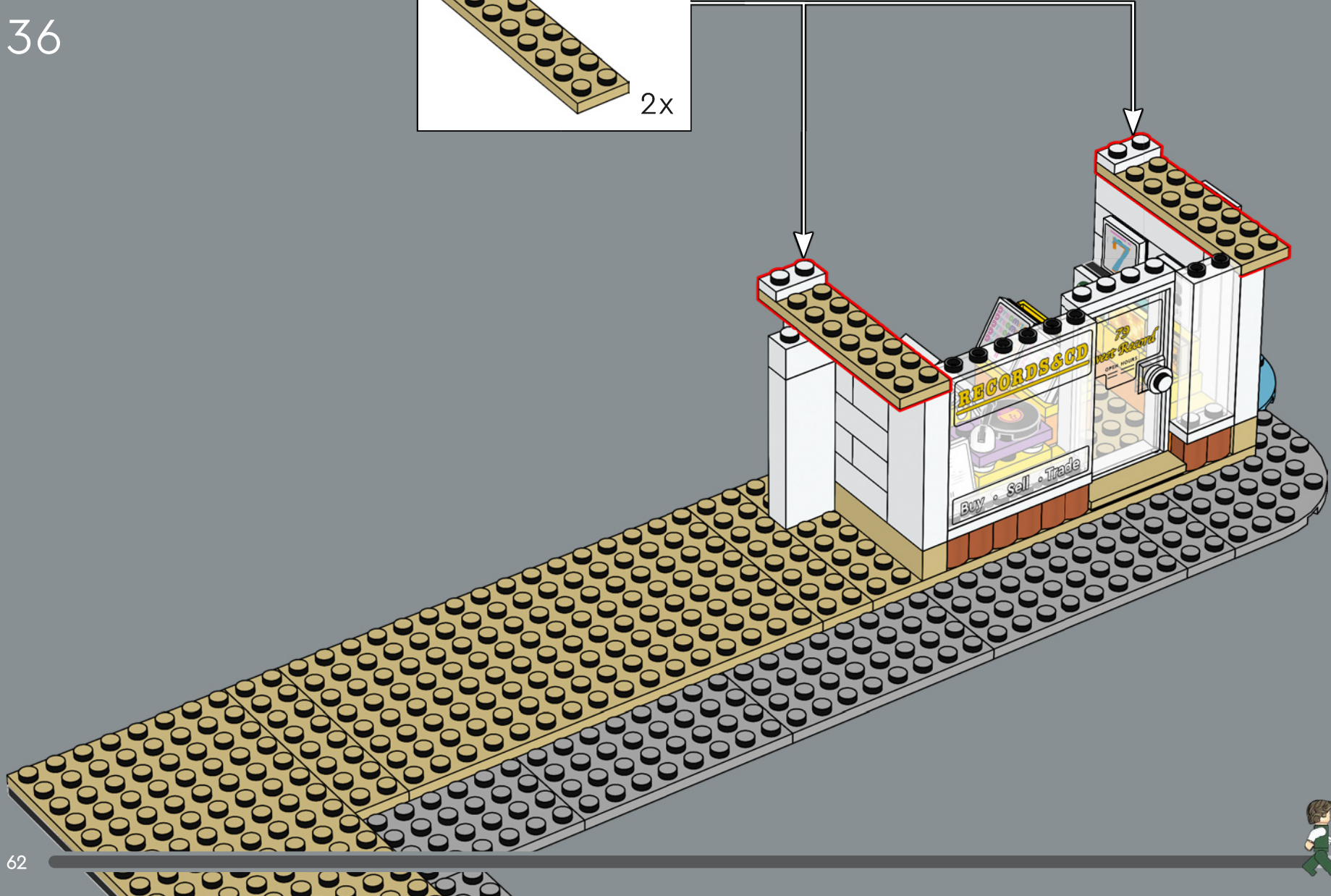
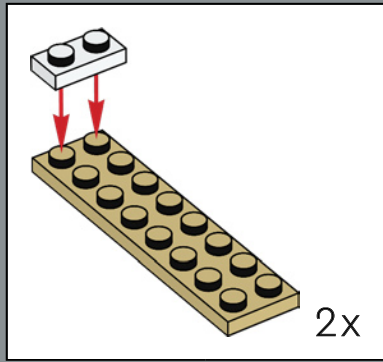

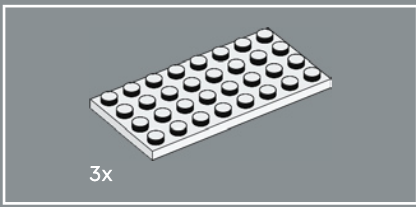

37

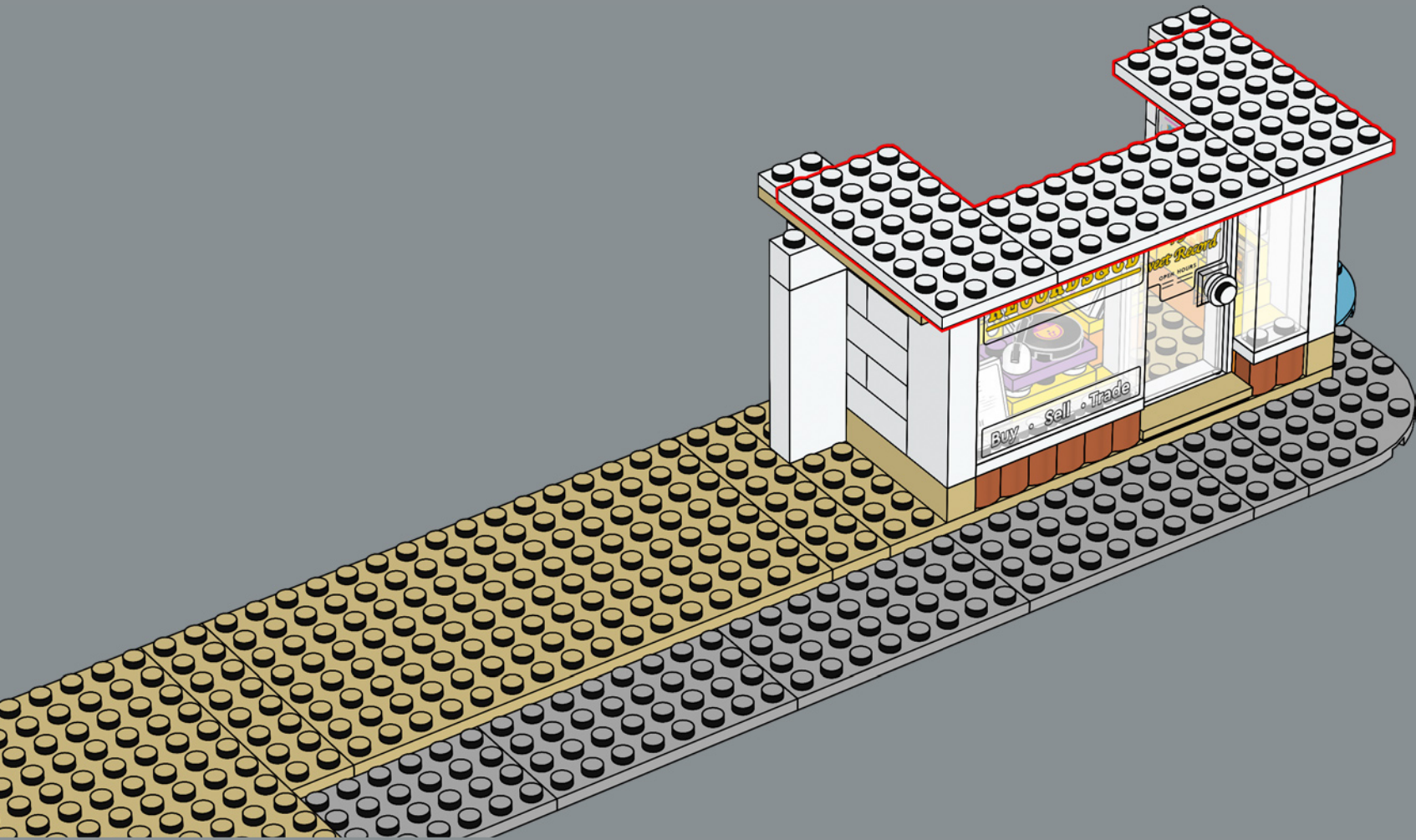

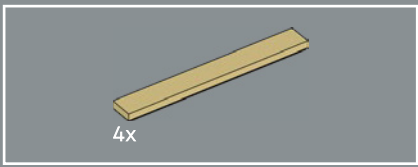

38

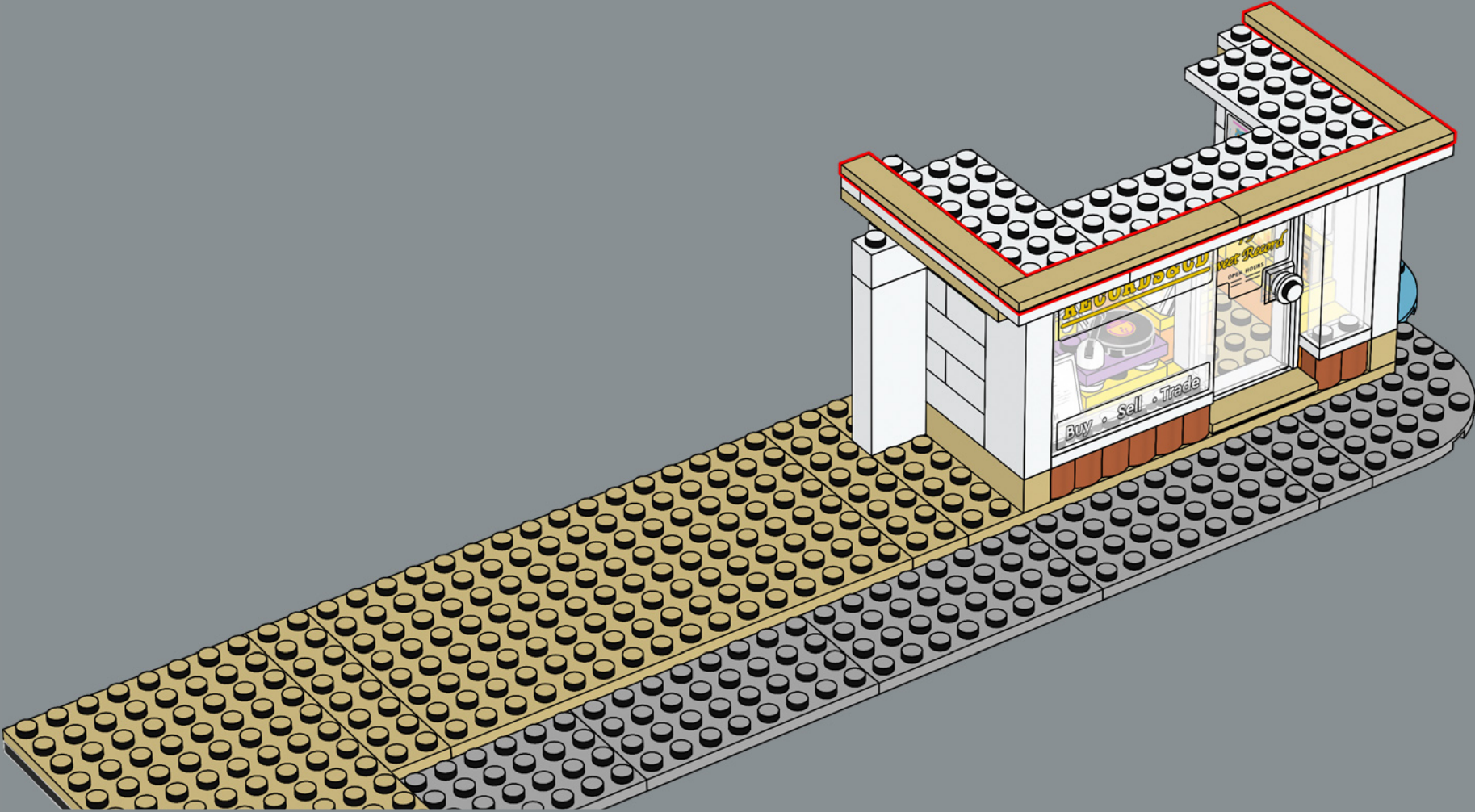

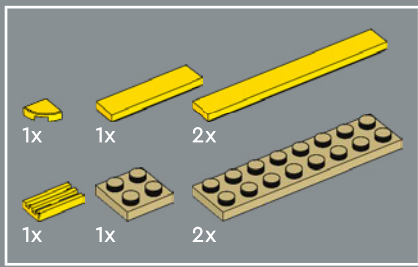

39

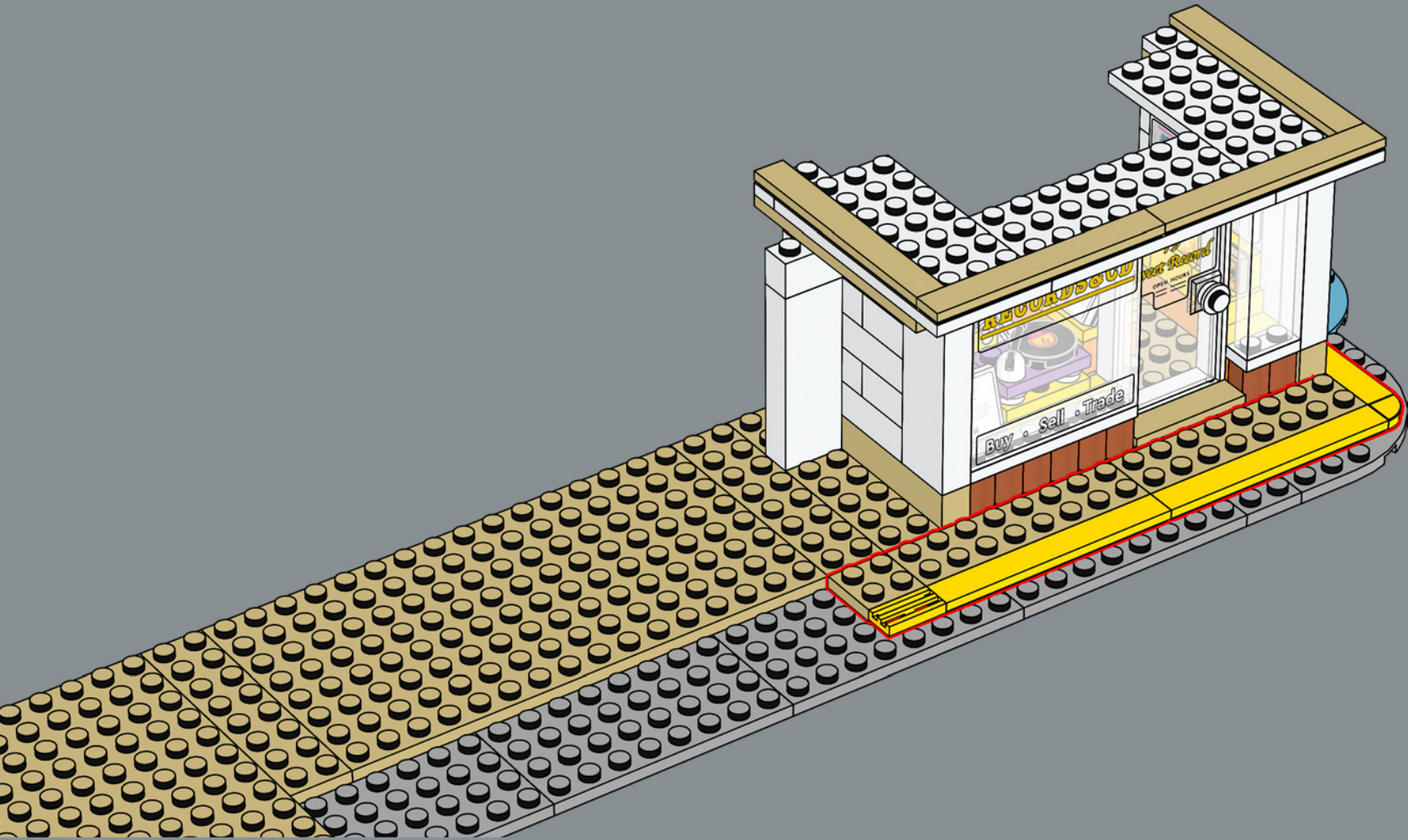

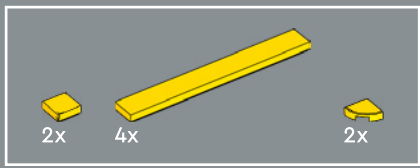

40

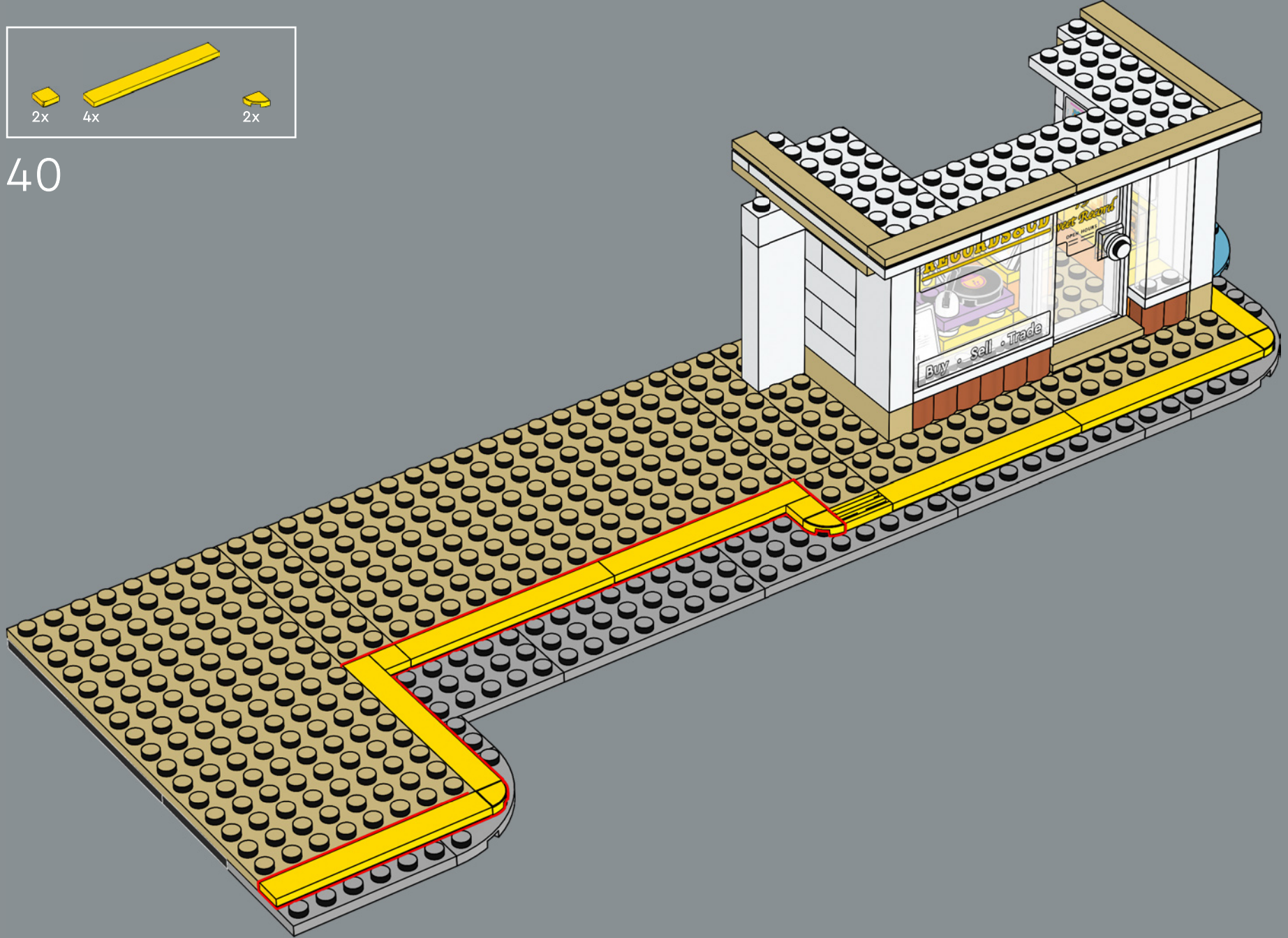

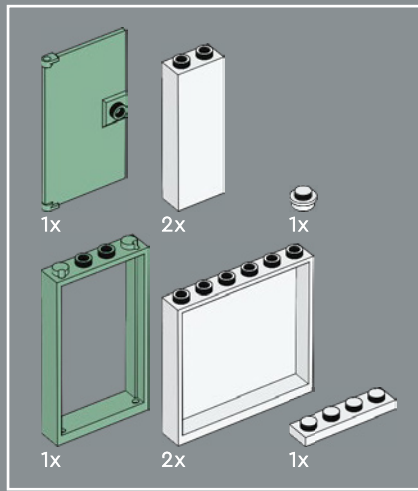

41

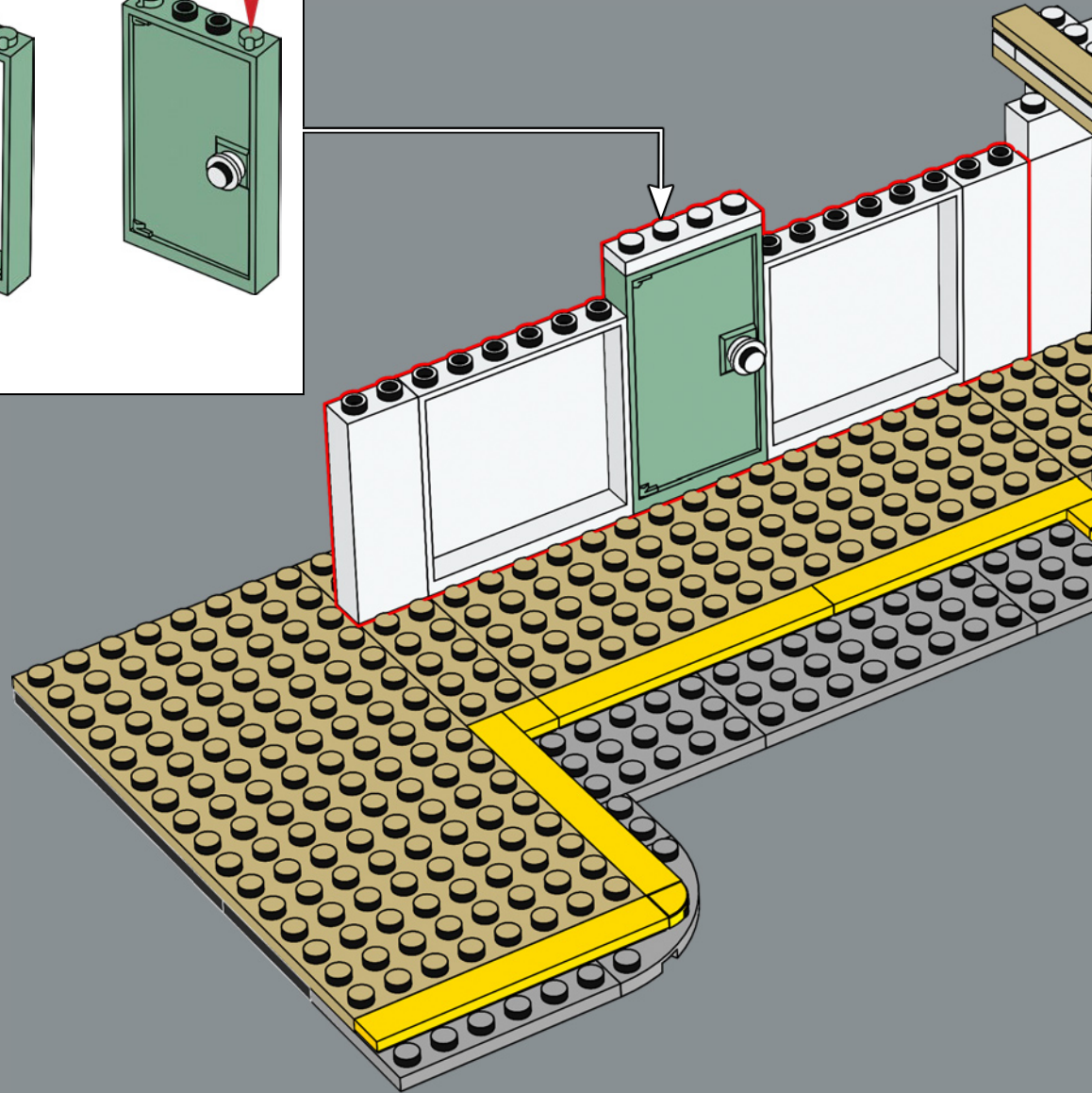
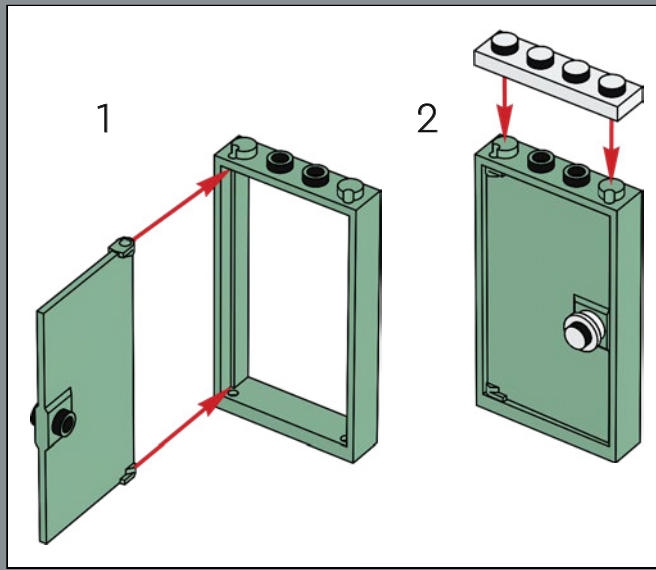

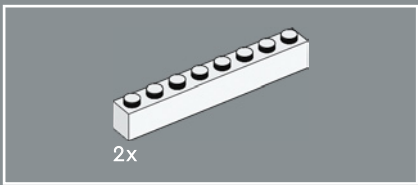

42

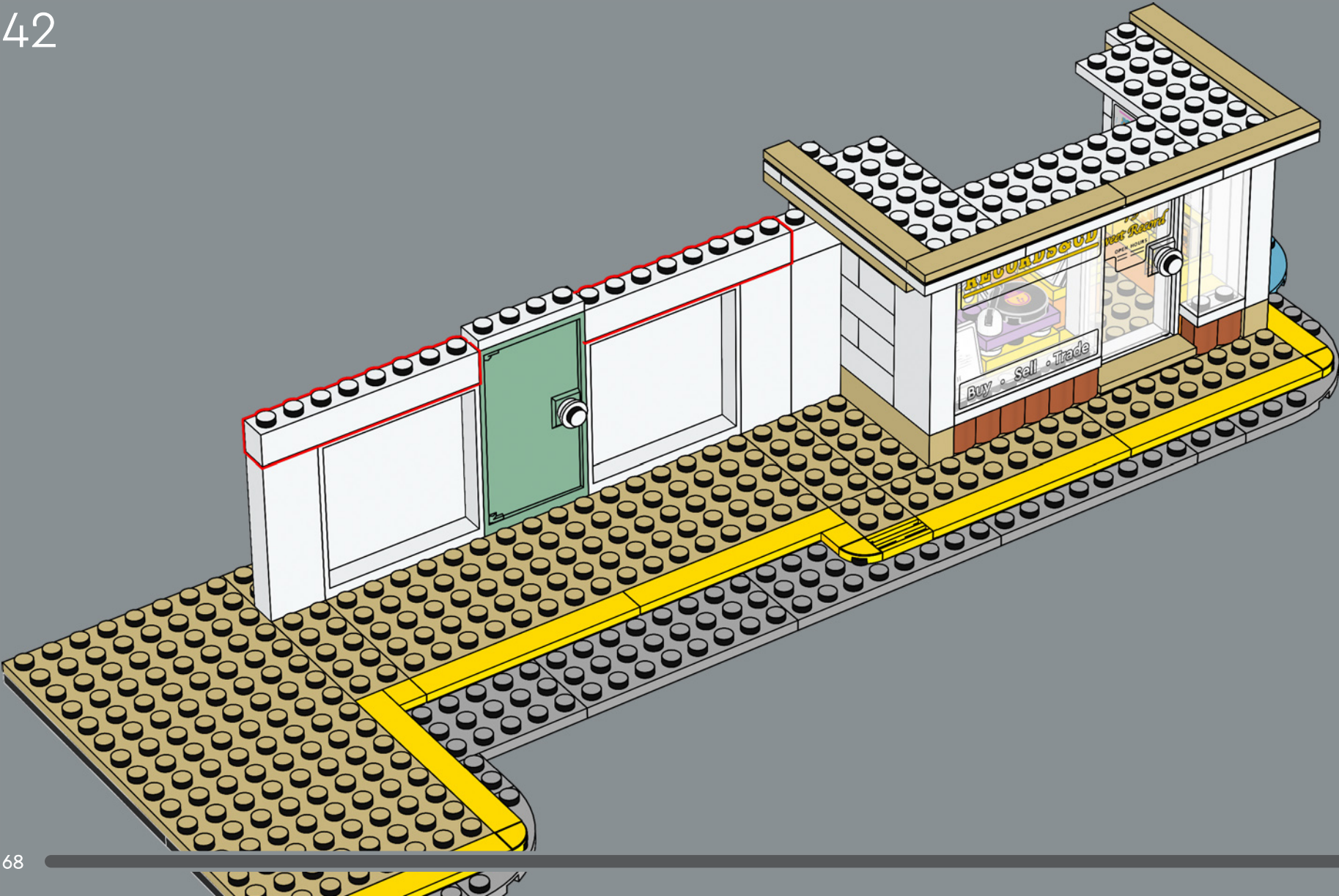

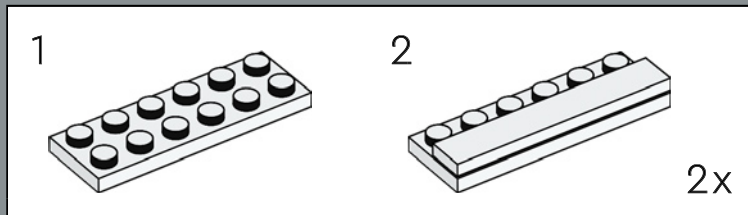
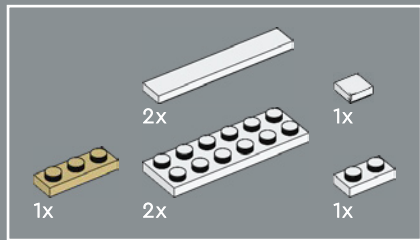

43

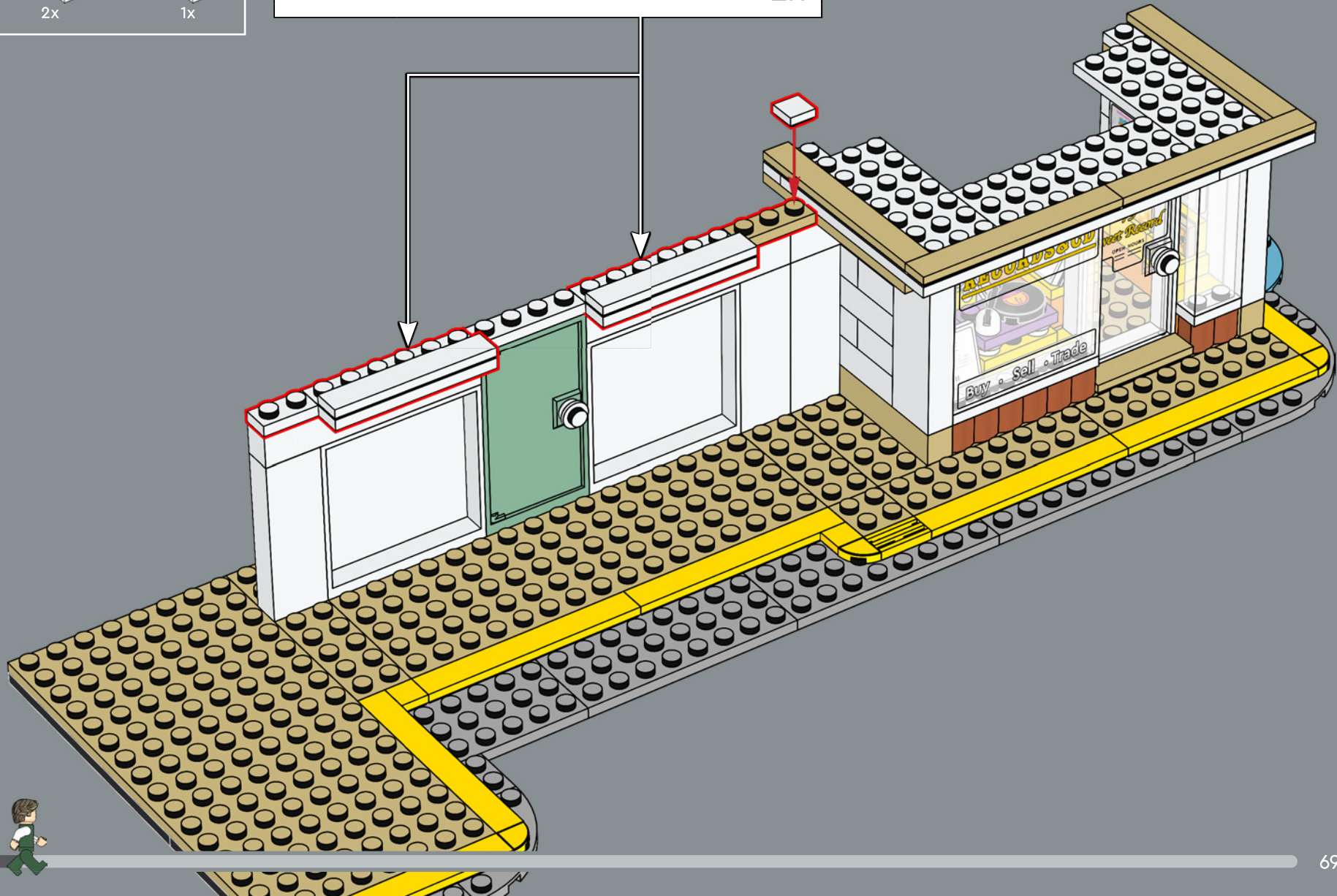

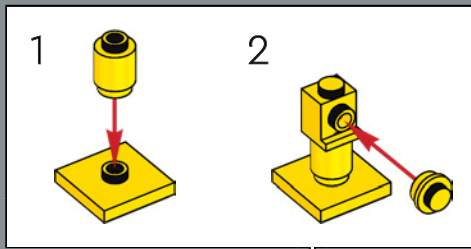
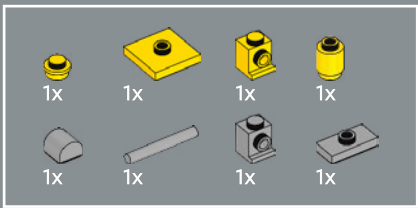

44

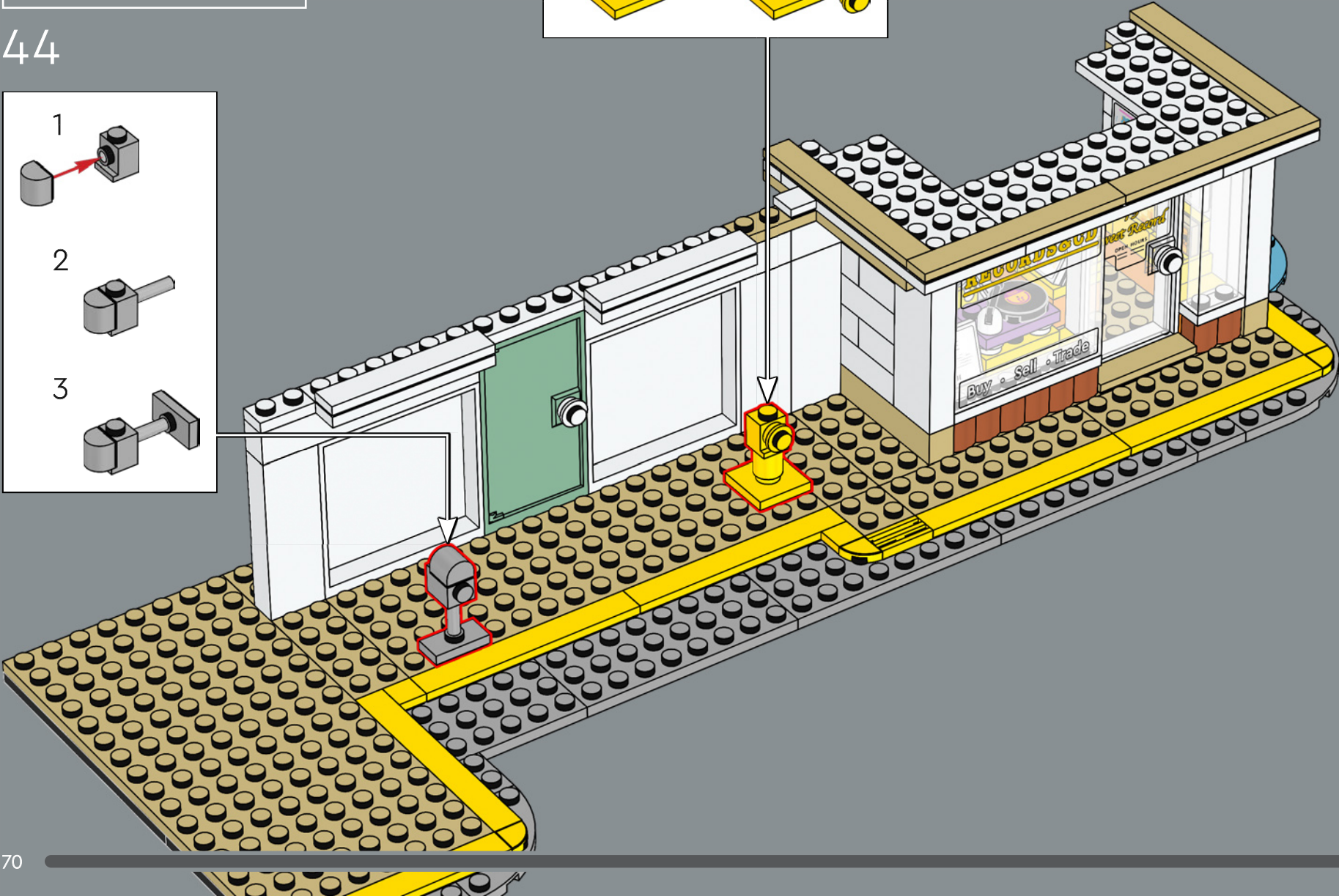
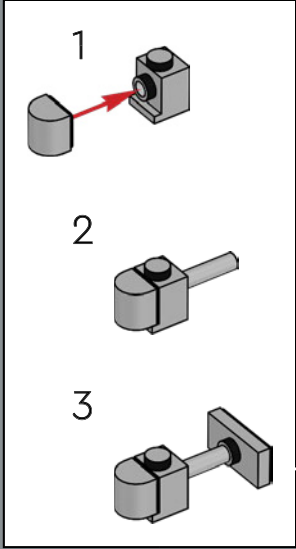

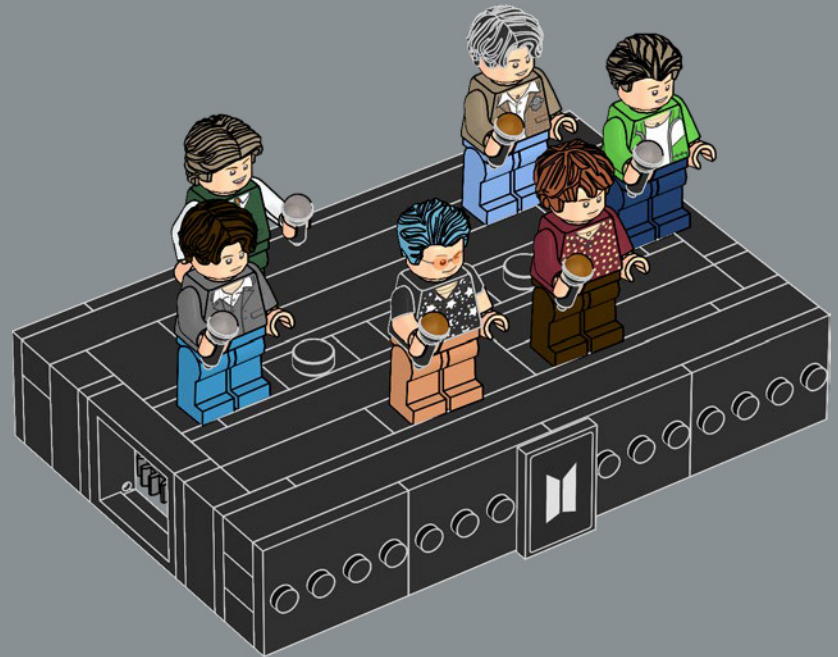
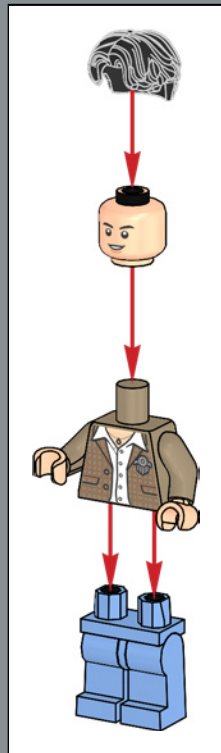

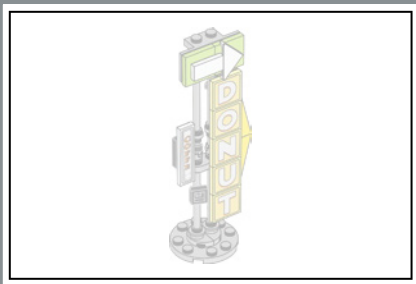

1

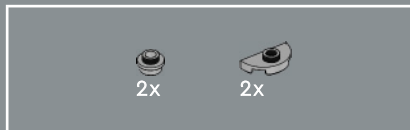

2

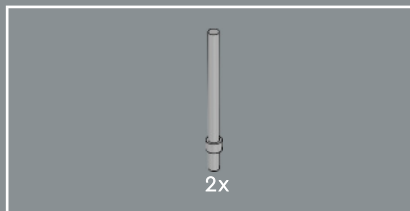
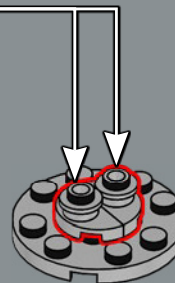
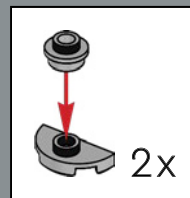

3

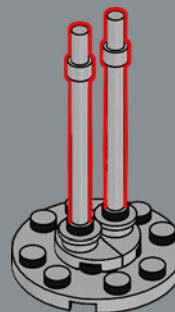



4

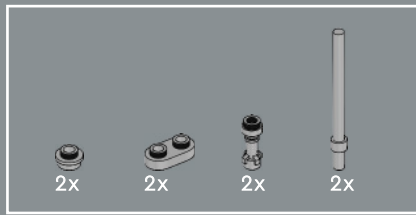
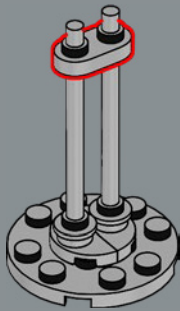

5

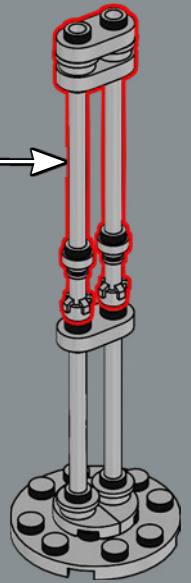
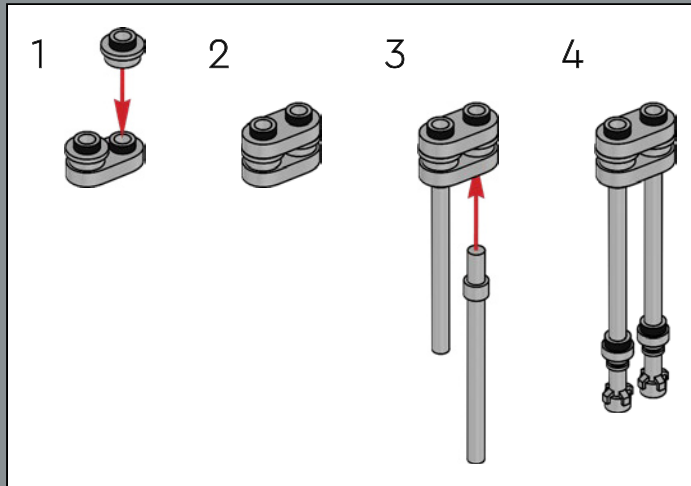

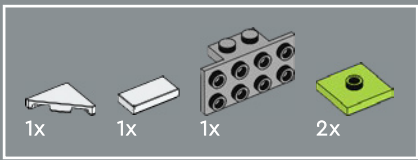

6

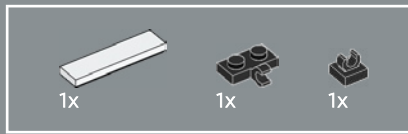
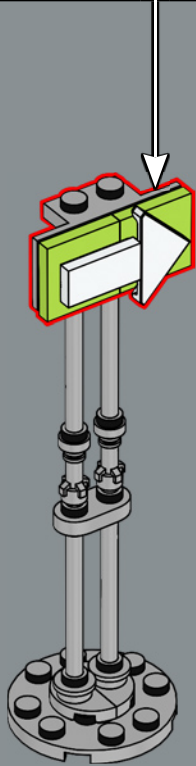
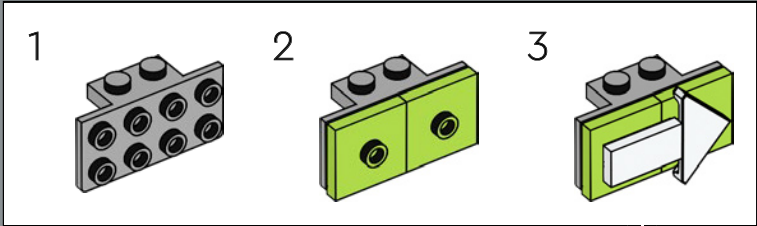

7

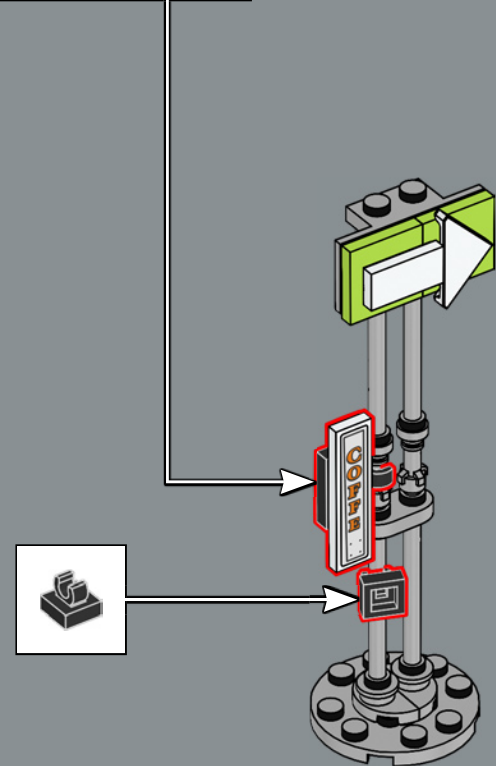
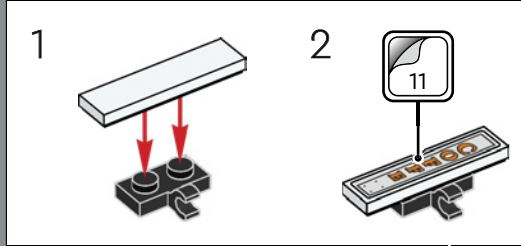

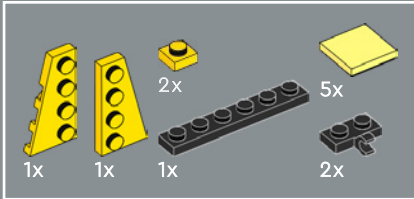
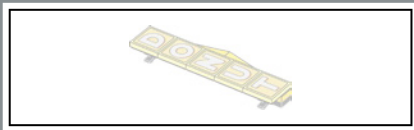

8

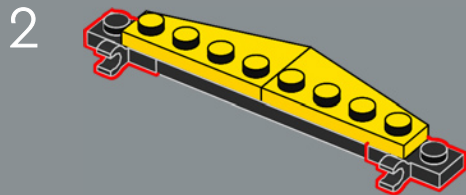
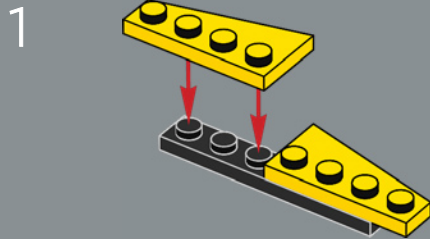

3

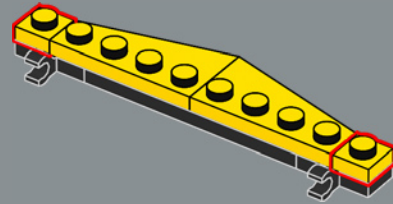

4

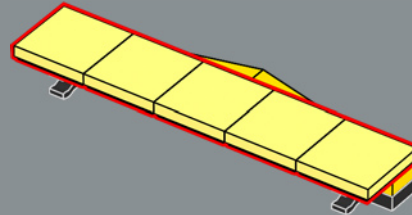

5

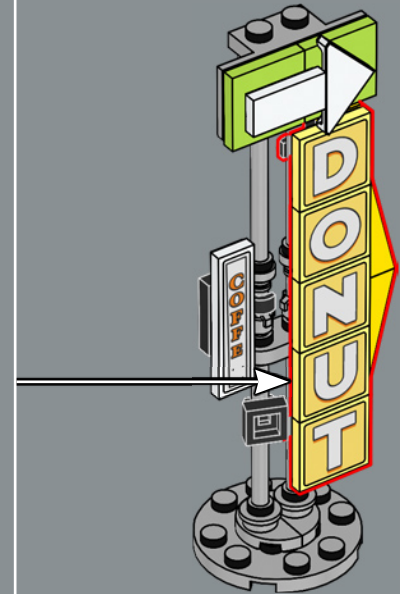
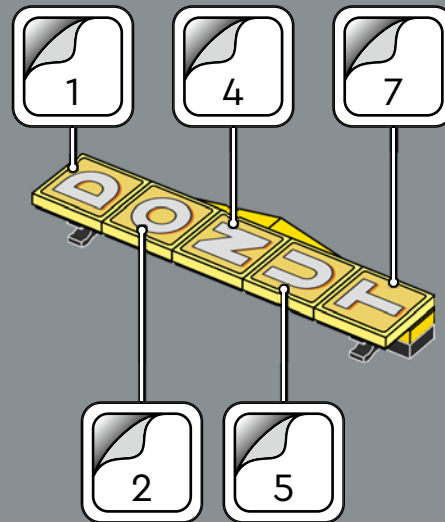



1x

45

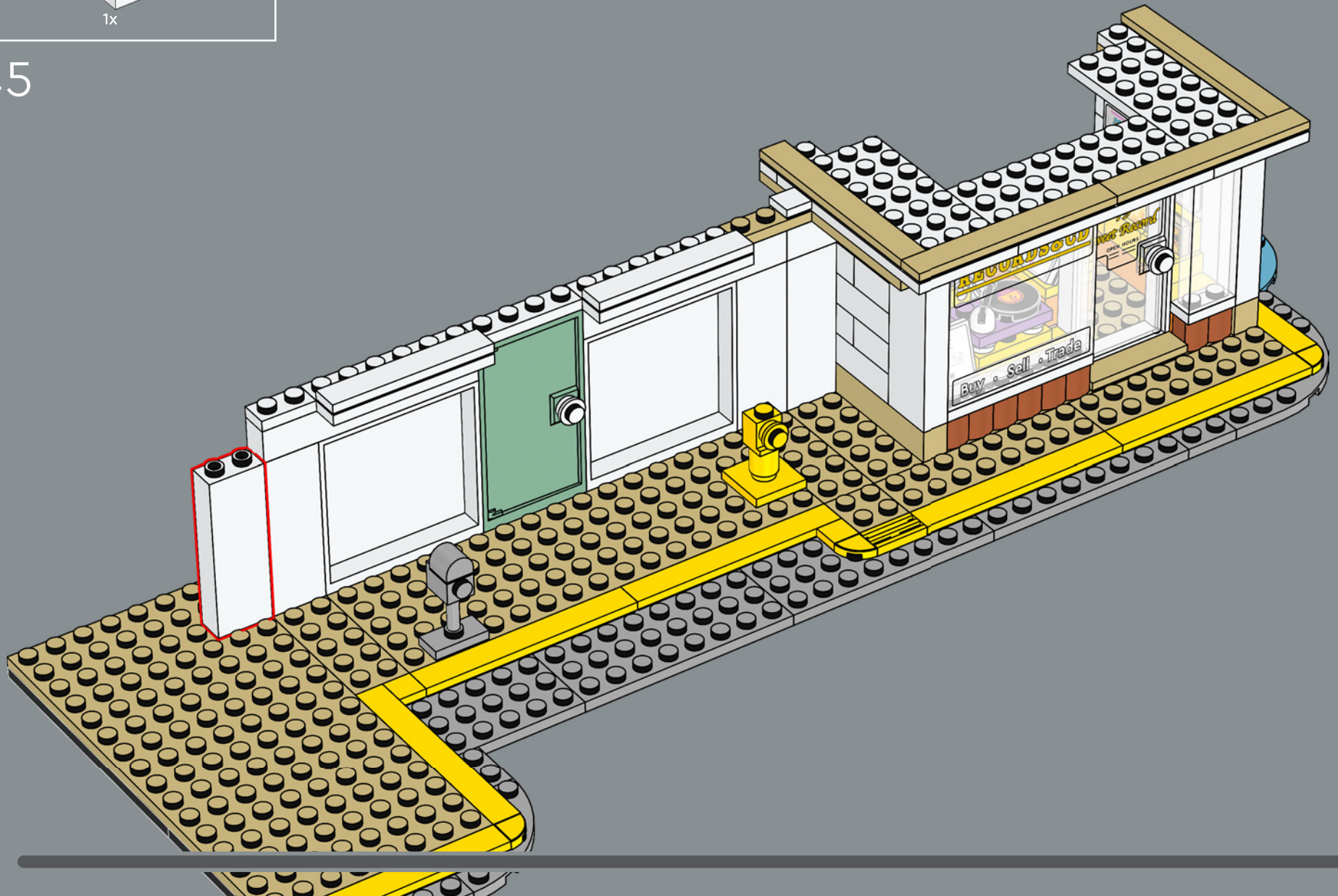

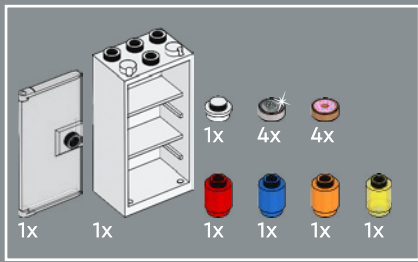

46

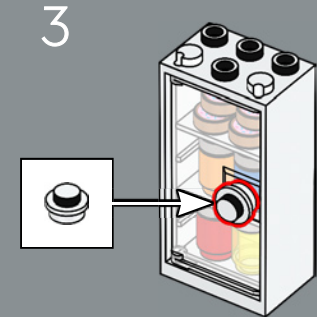
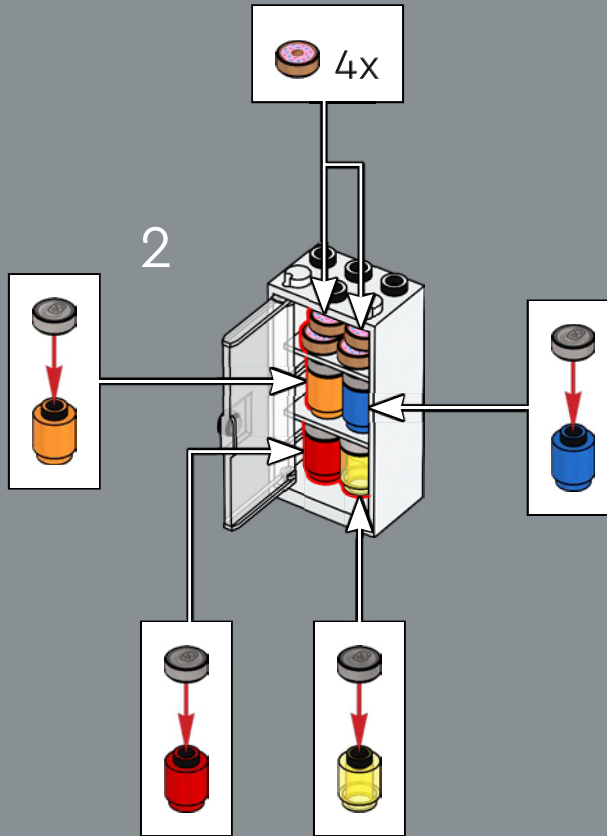
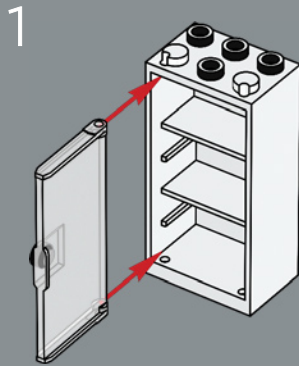

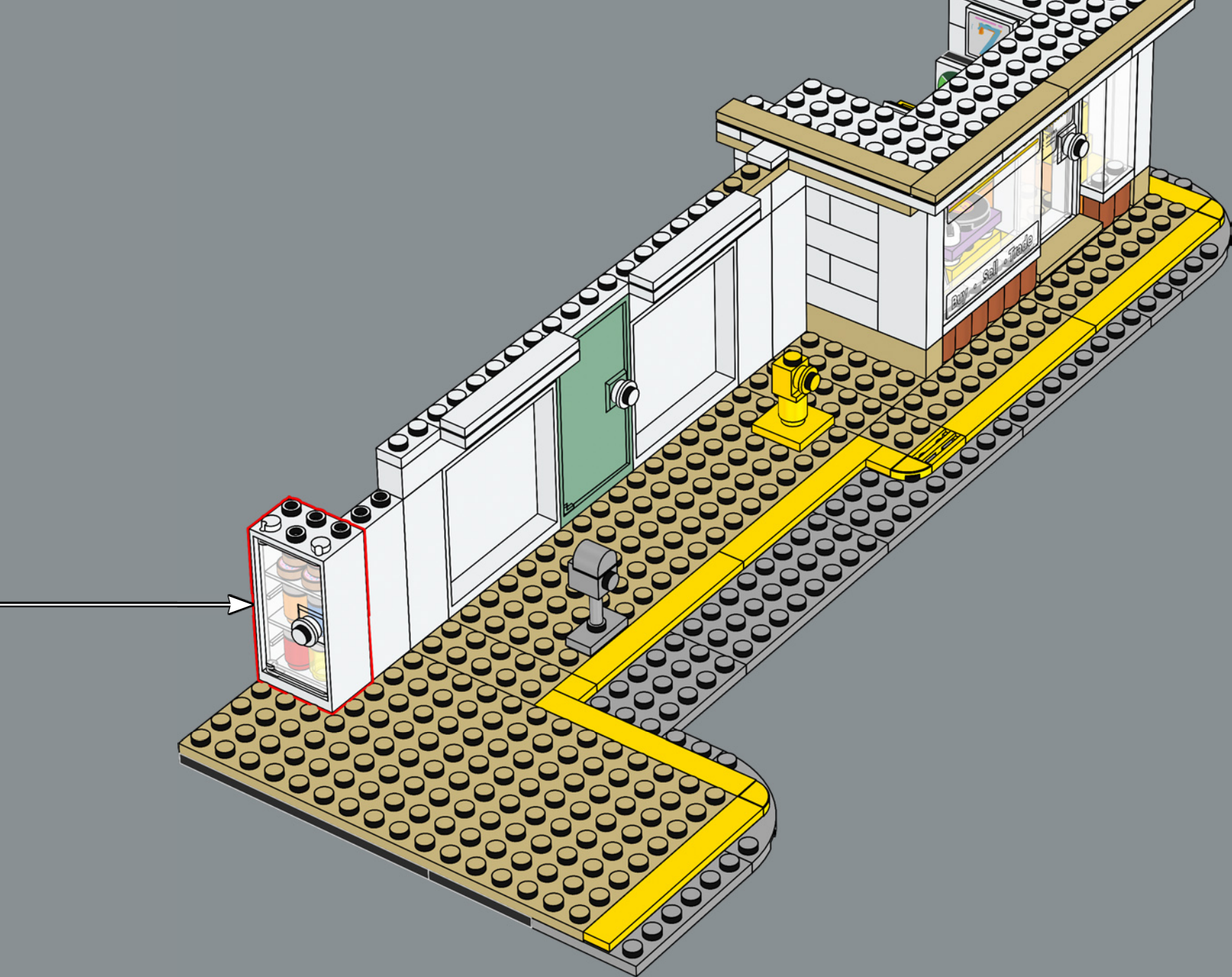

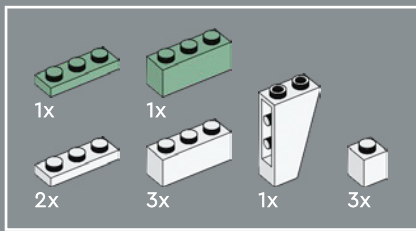

47

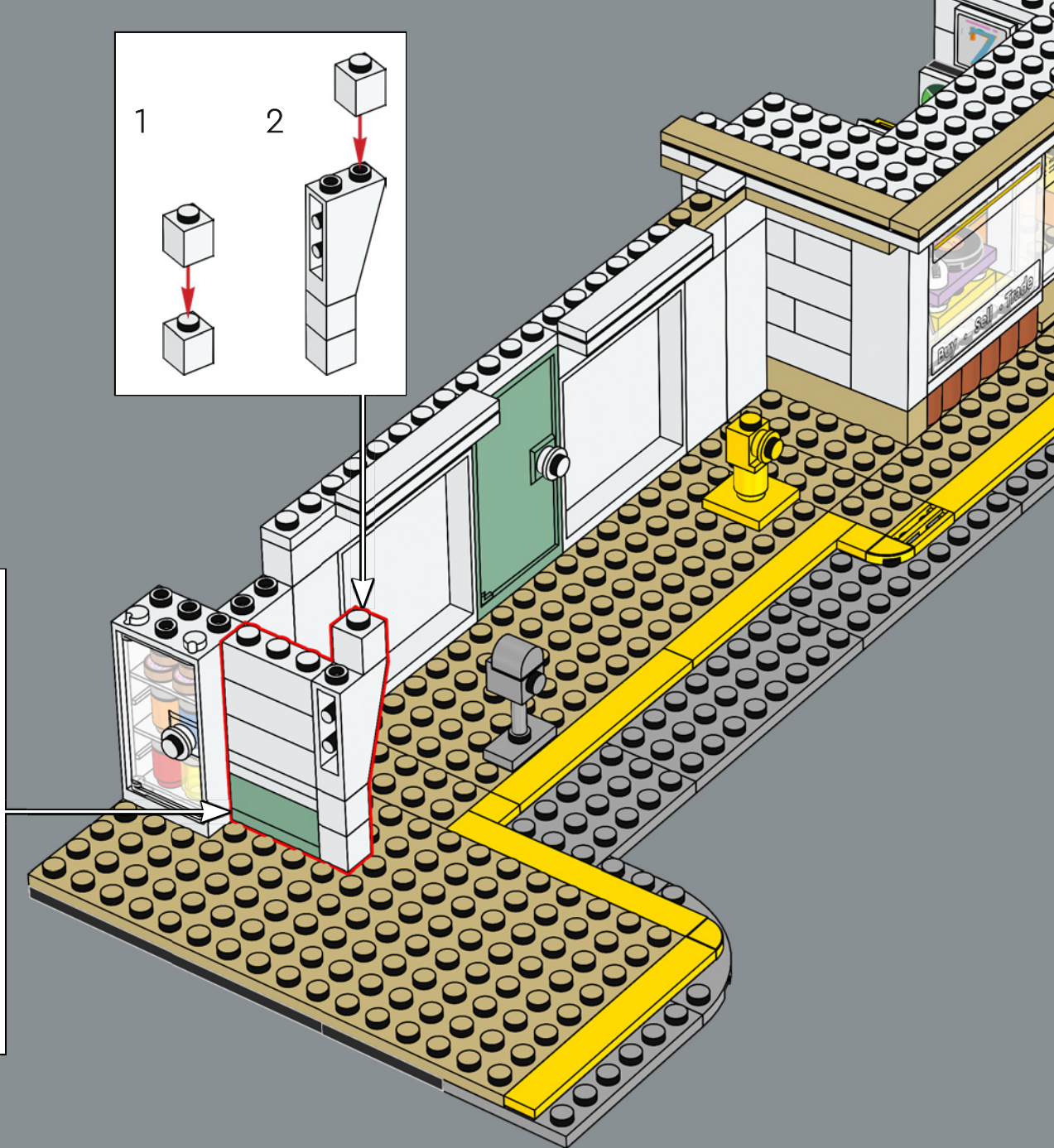
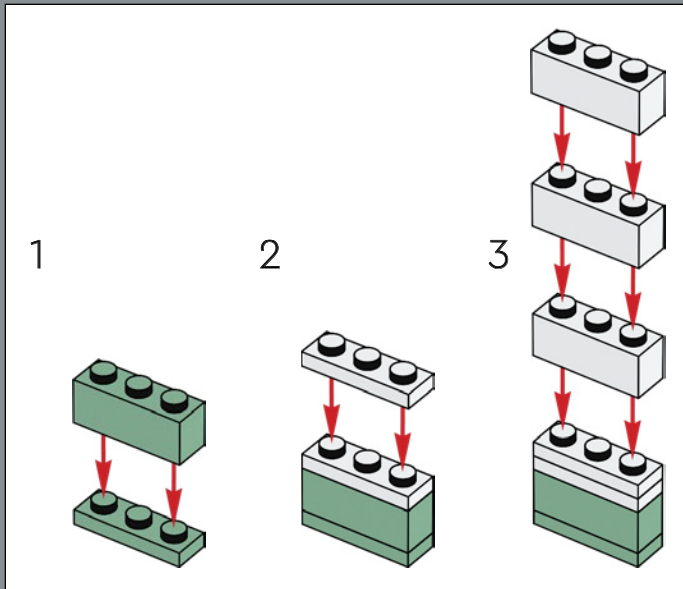
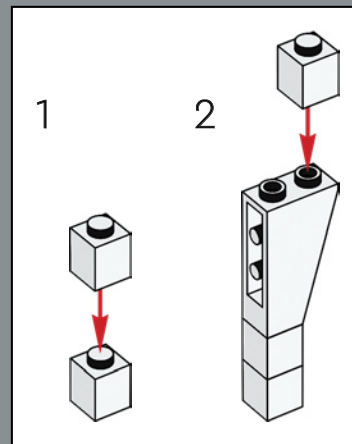

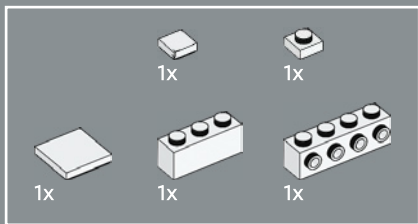

48

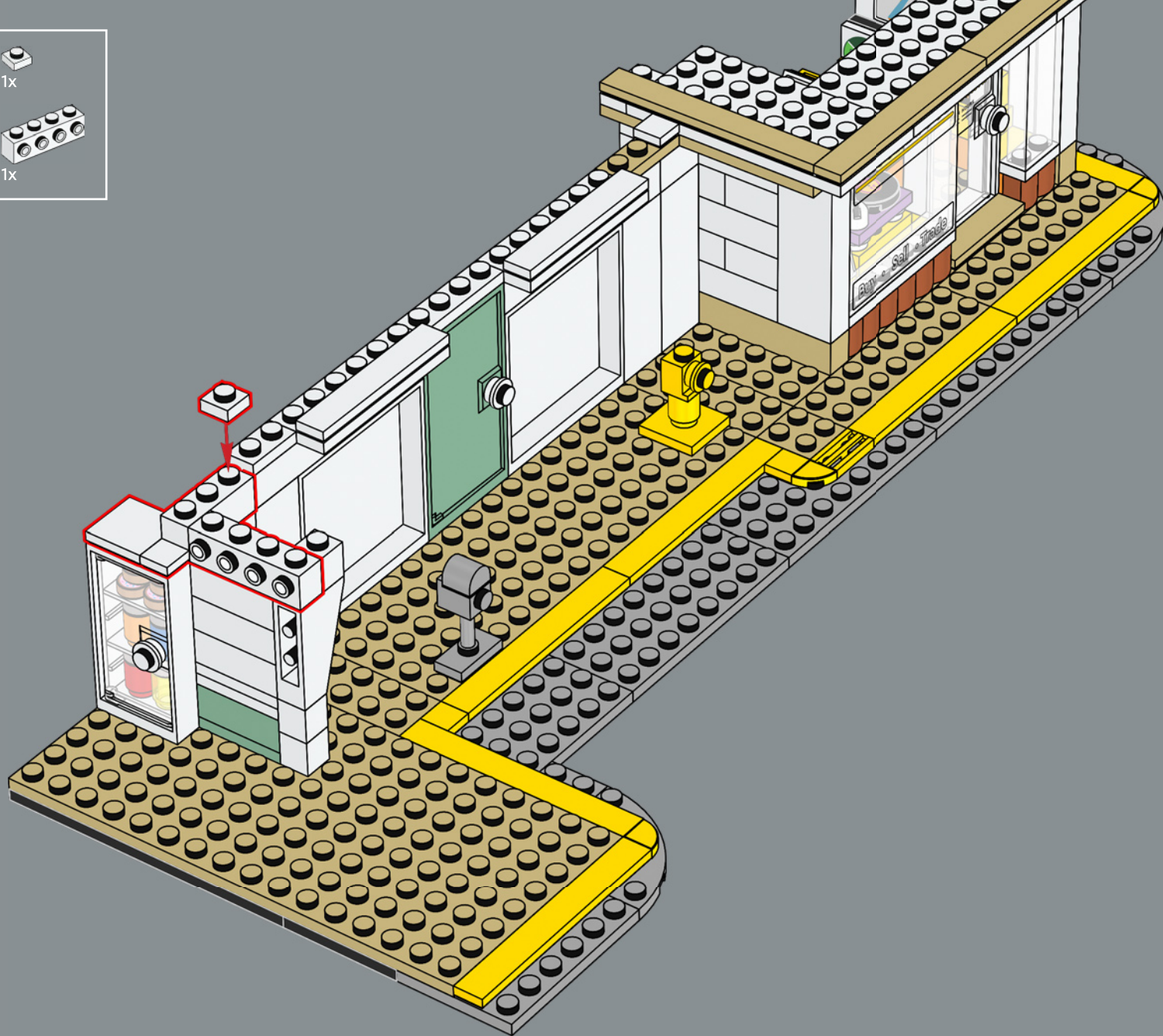

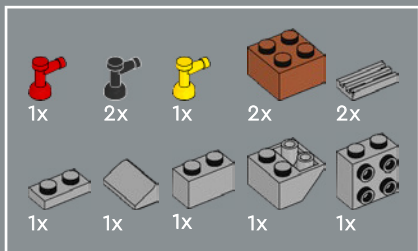

49

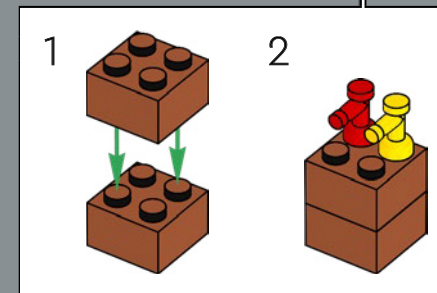
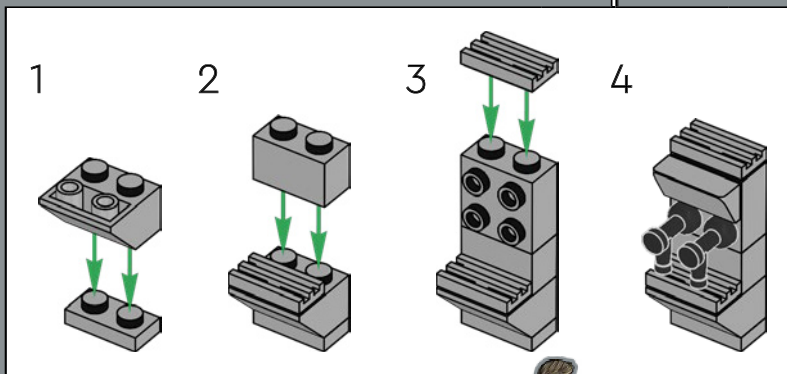
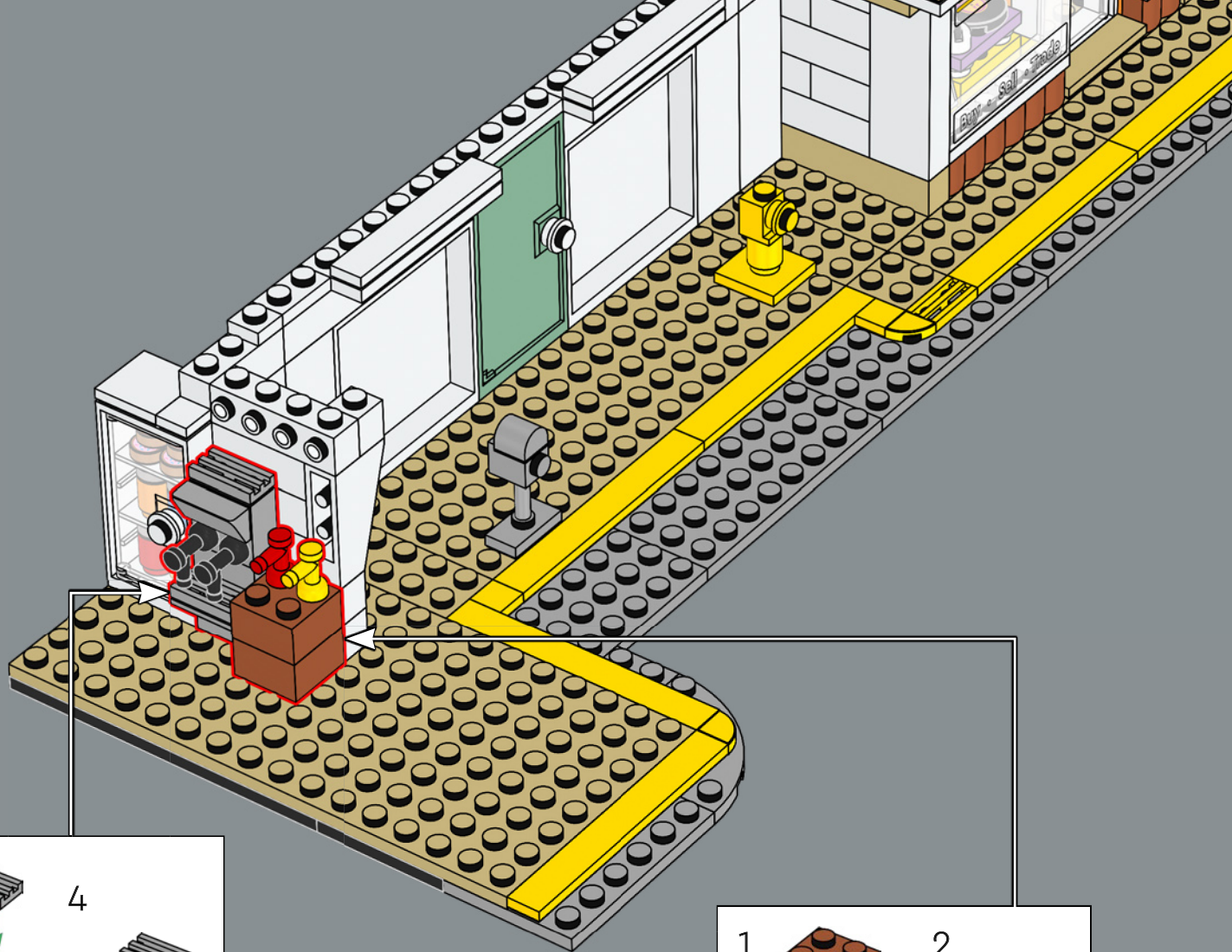

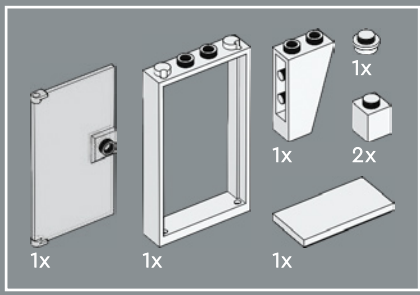

50

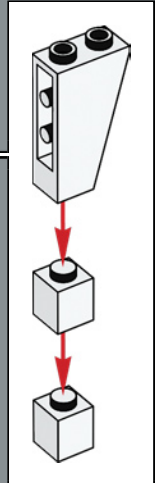
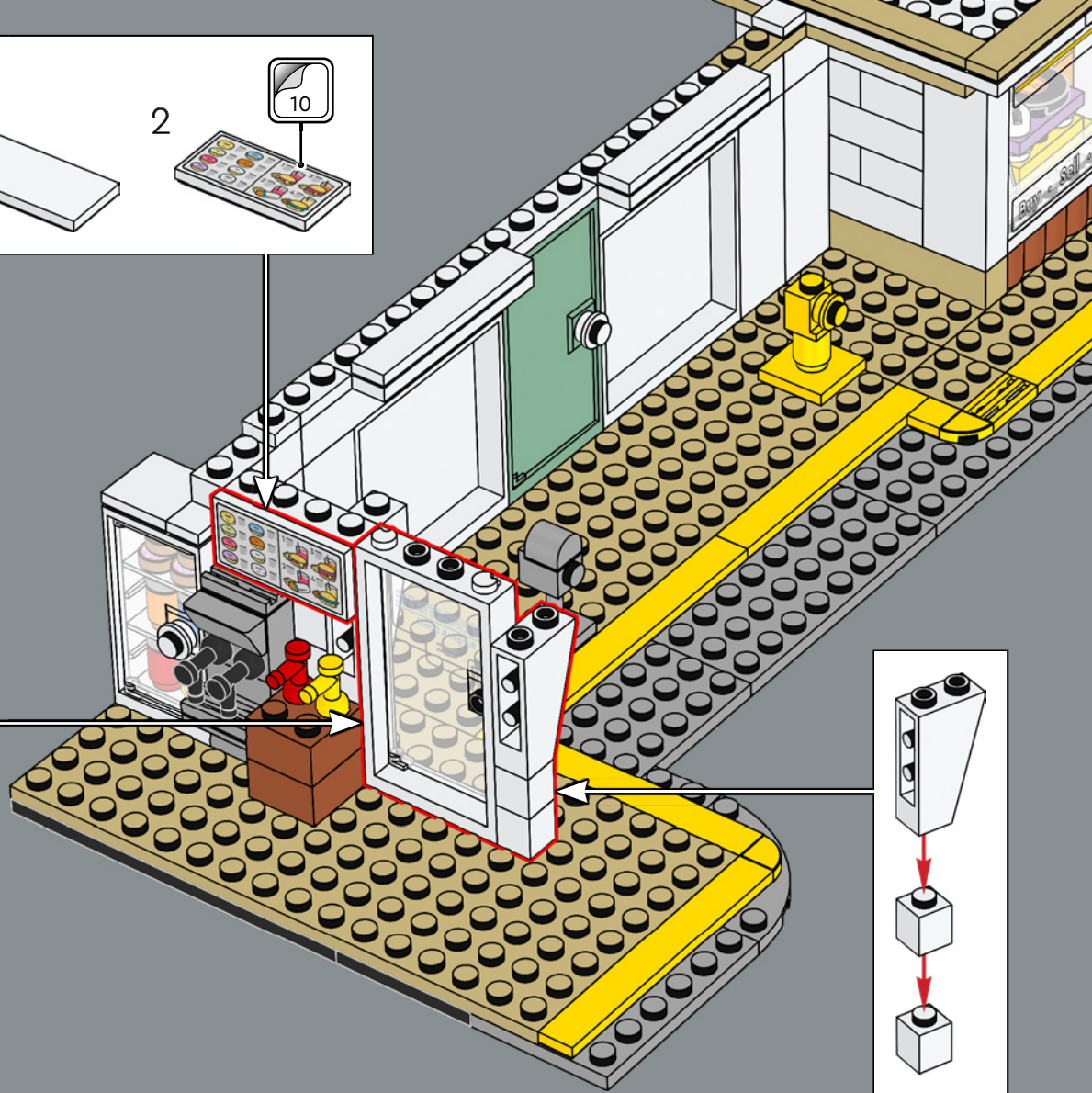
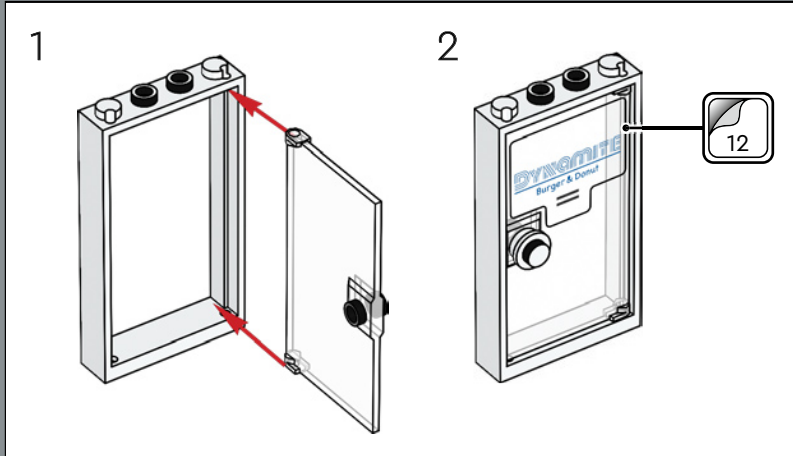
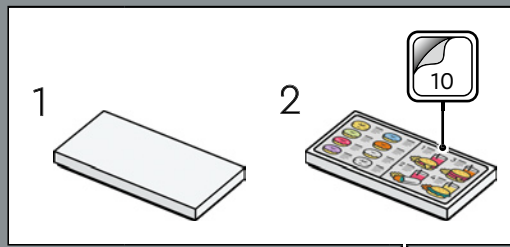

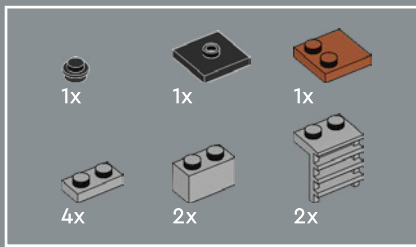

51

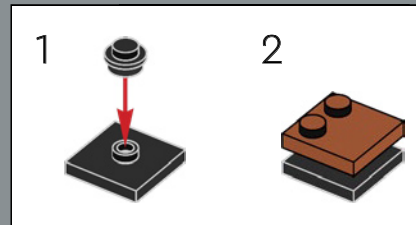
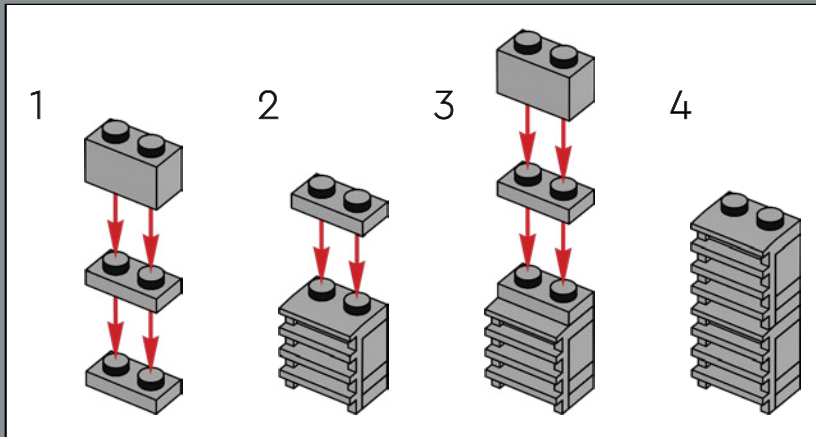

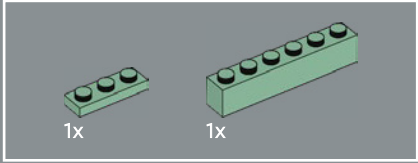

52

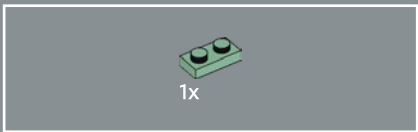
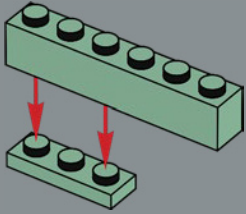

53

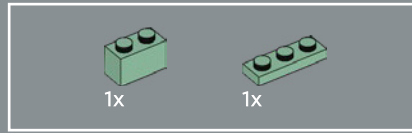
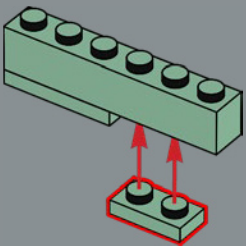

54

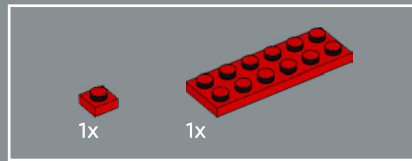
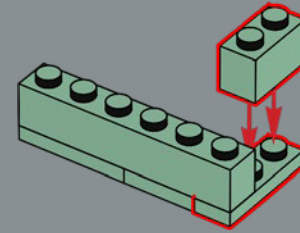

55

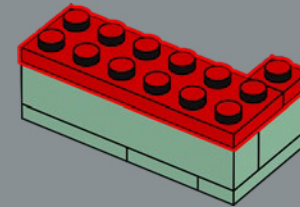



56

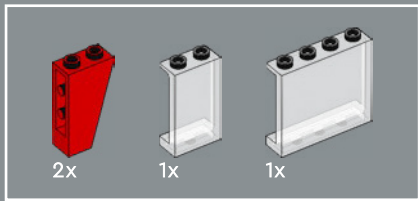
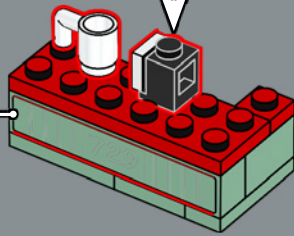
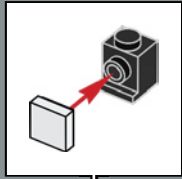

57

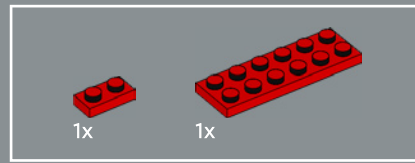
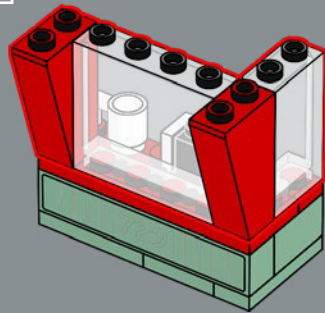

58

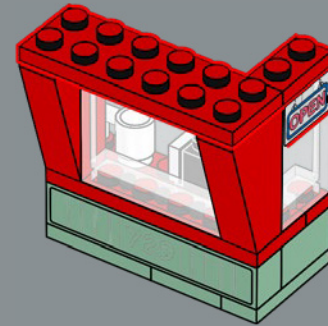

59

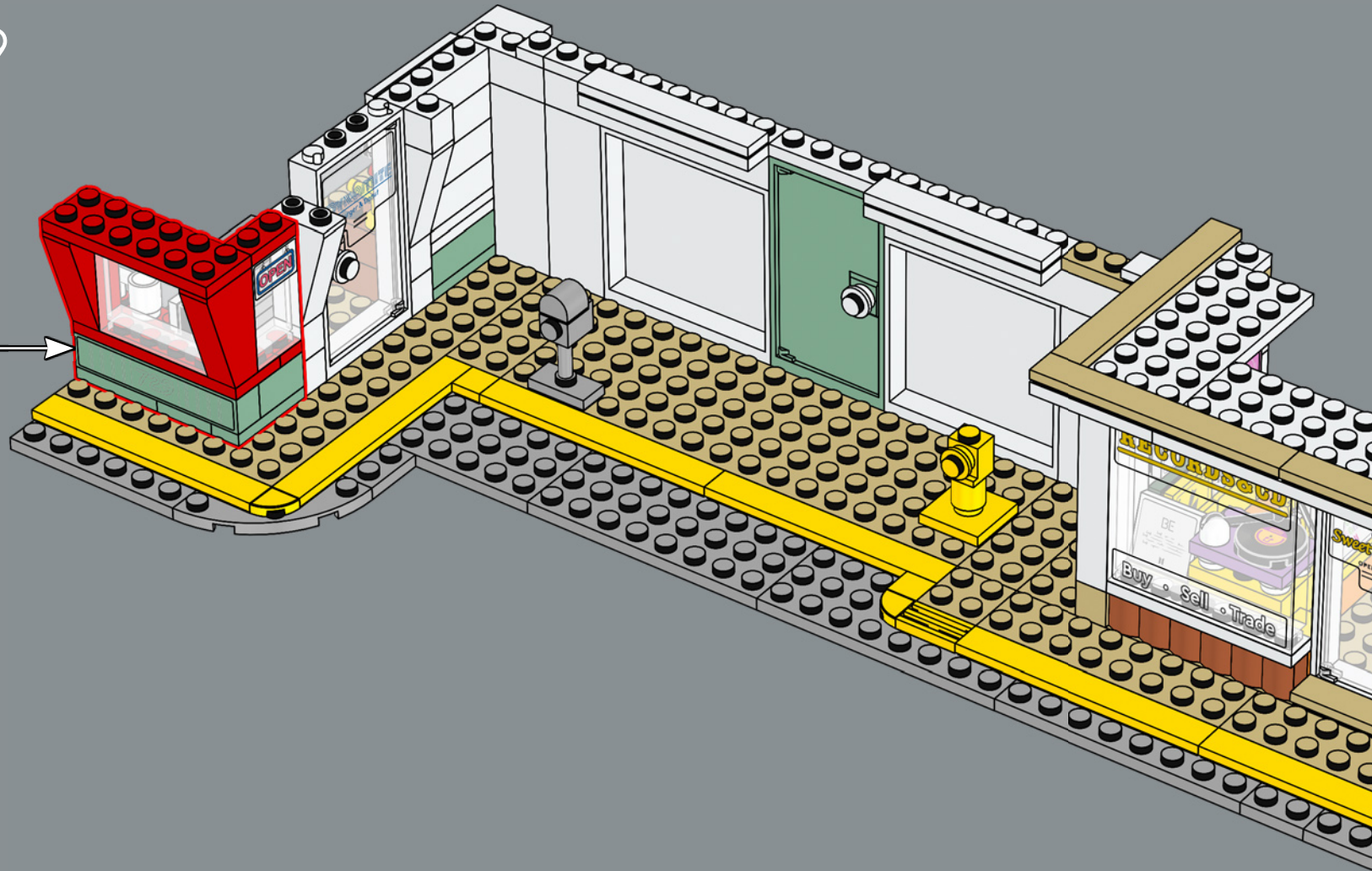

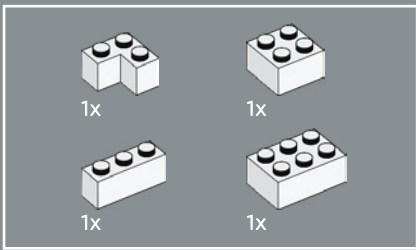

60

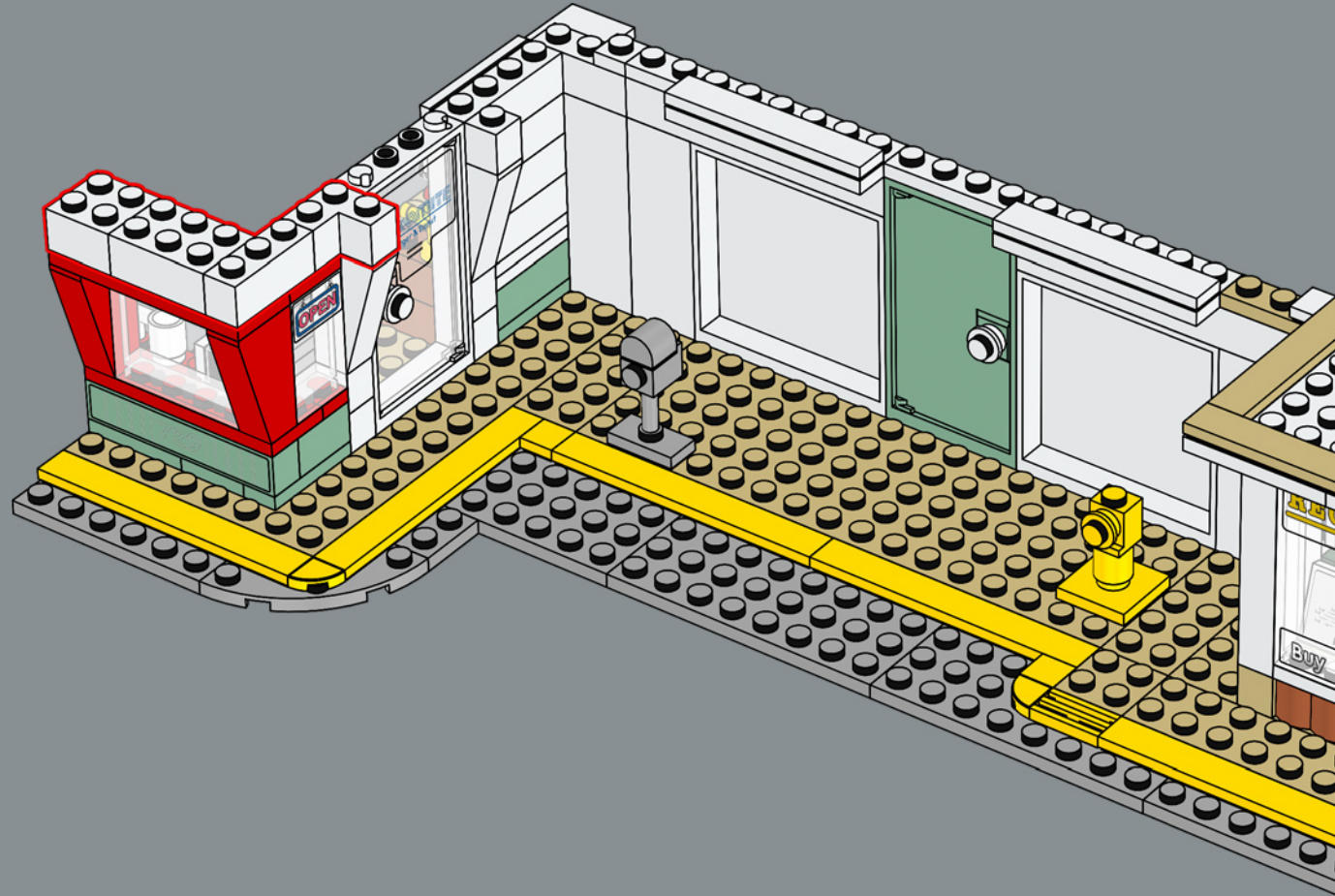

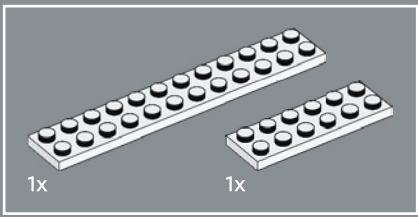

61

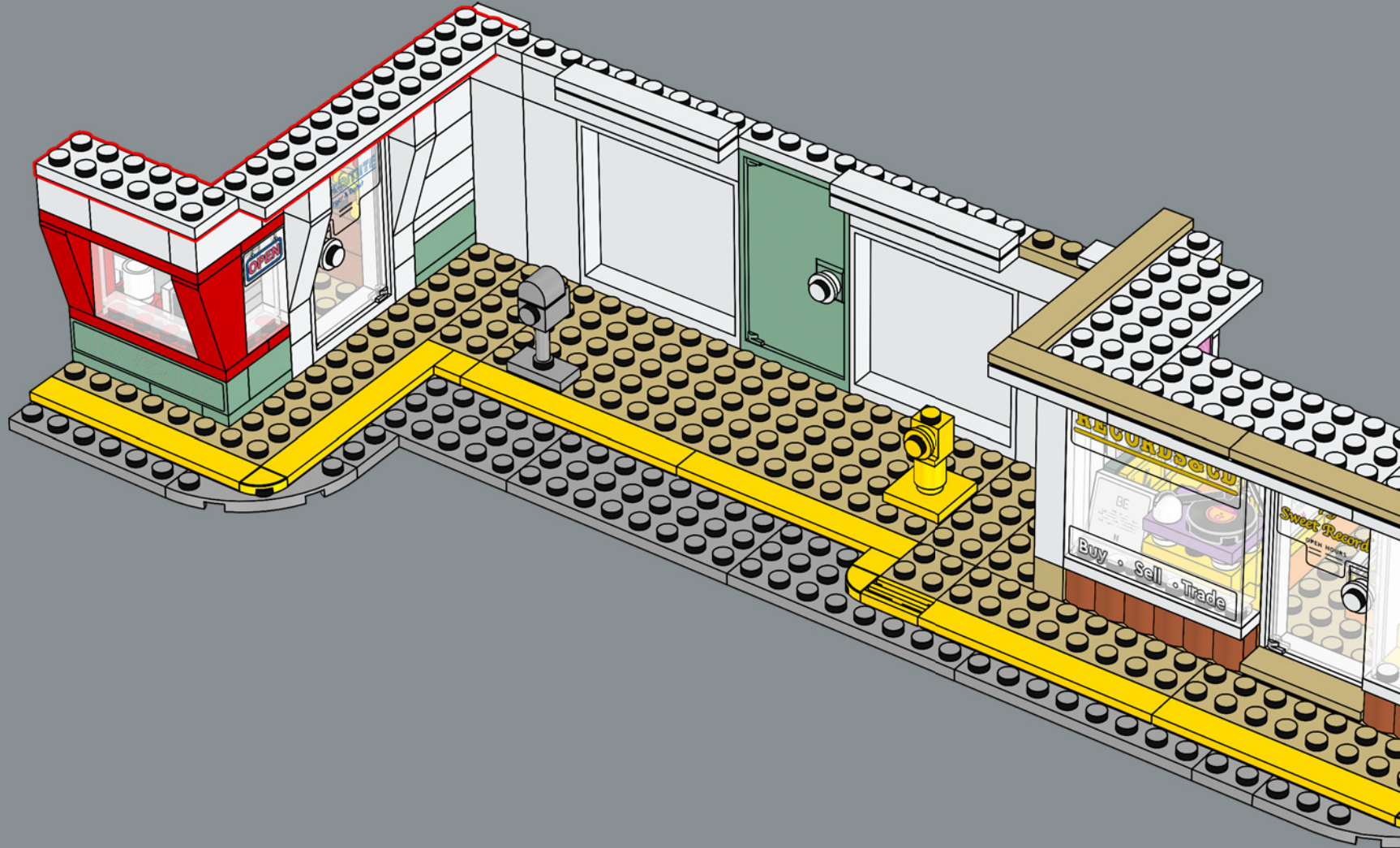

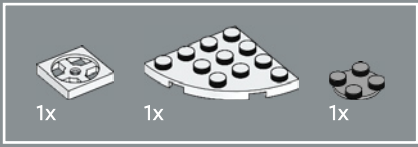

63

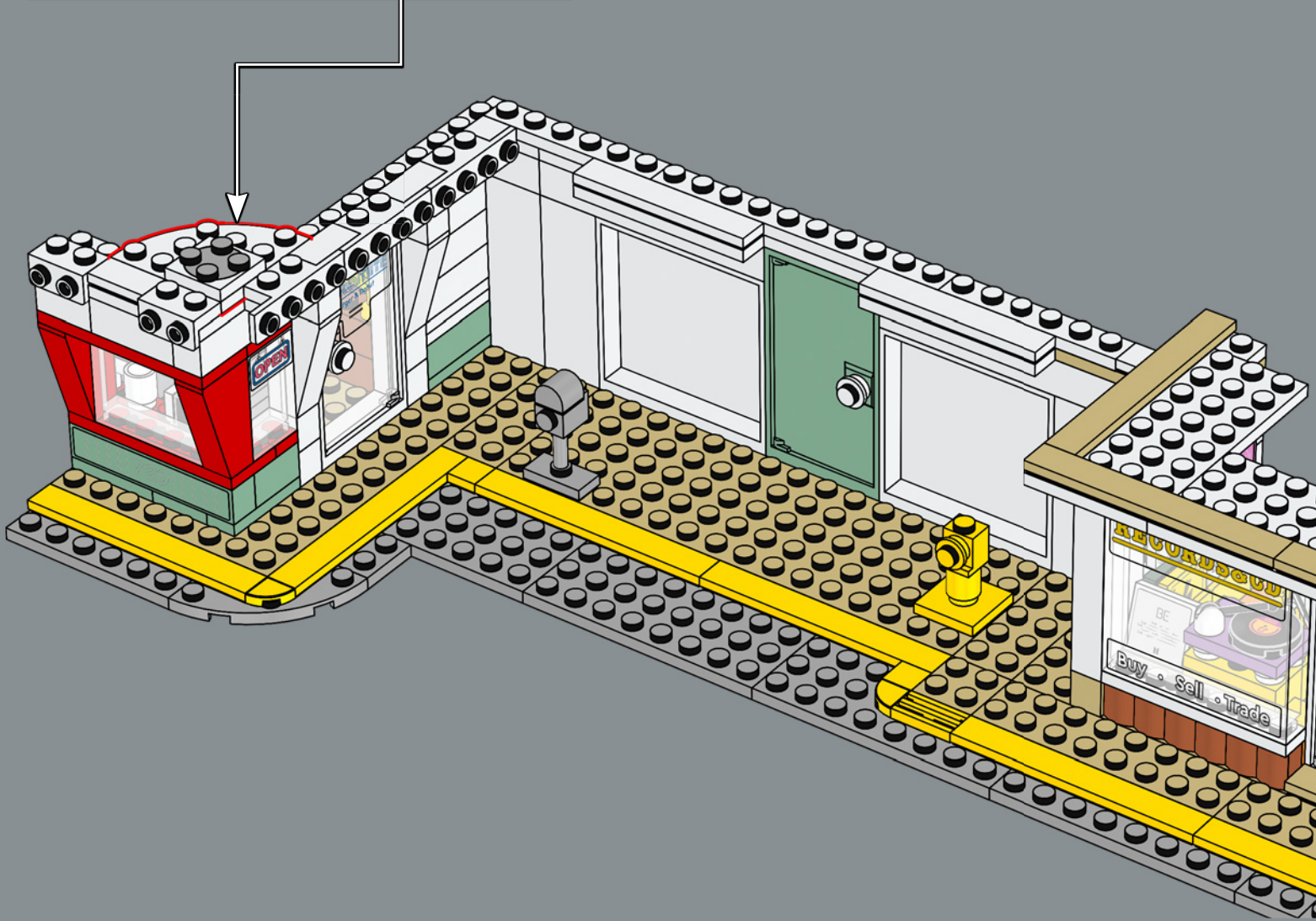
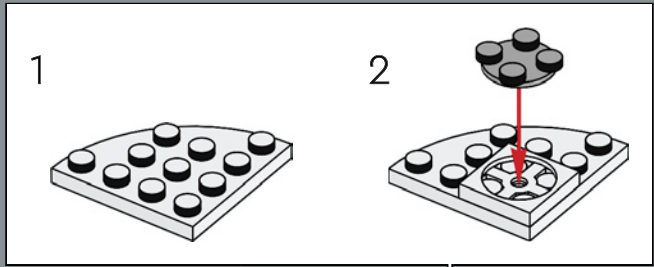

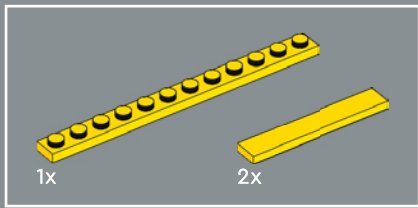

64

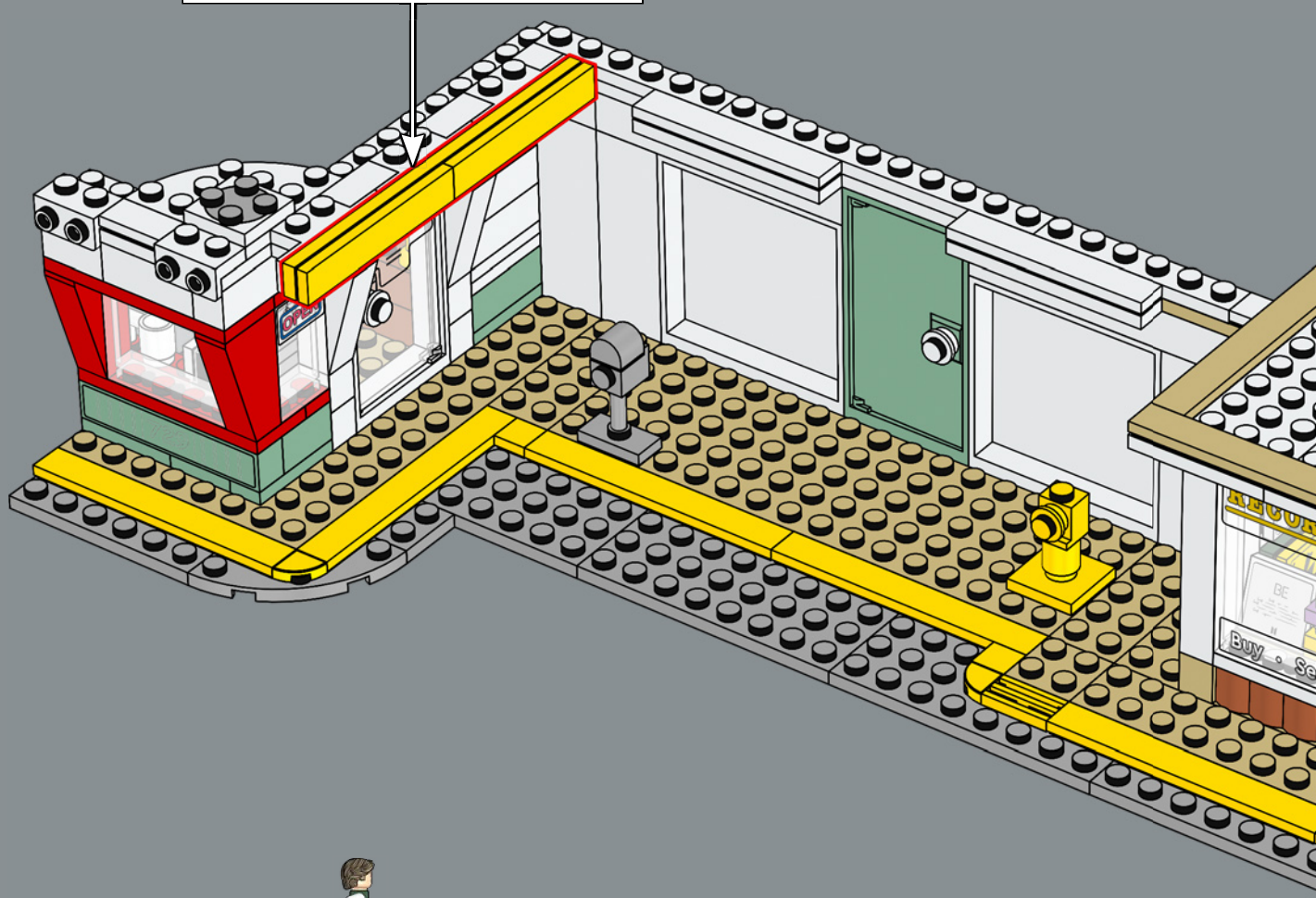
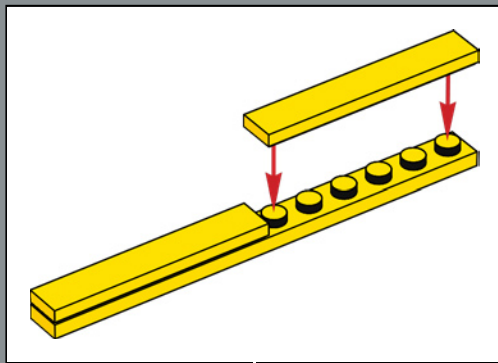

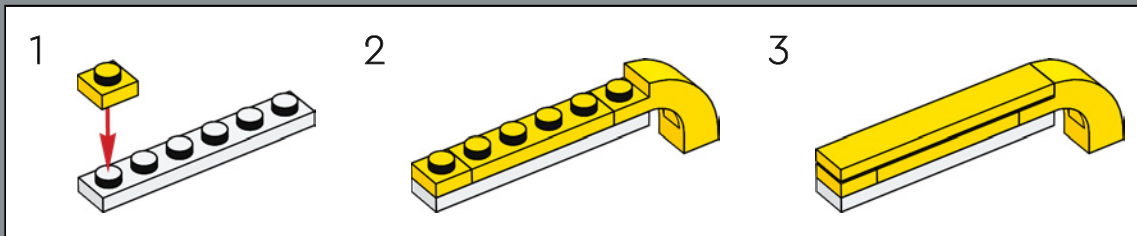
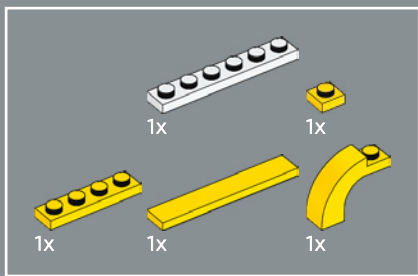

65

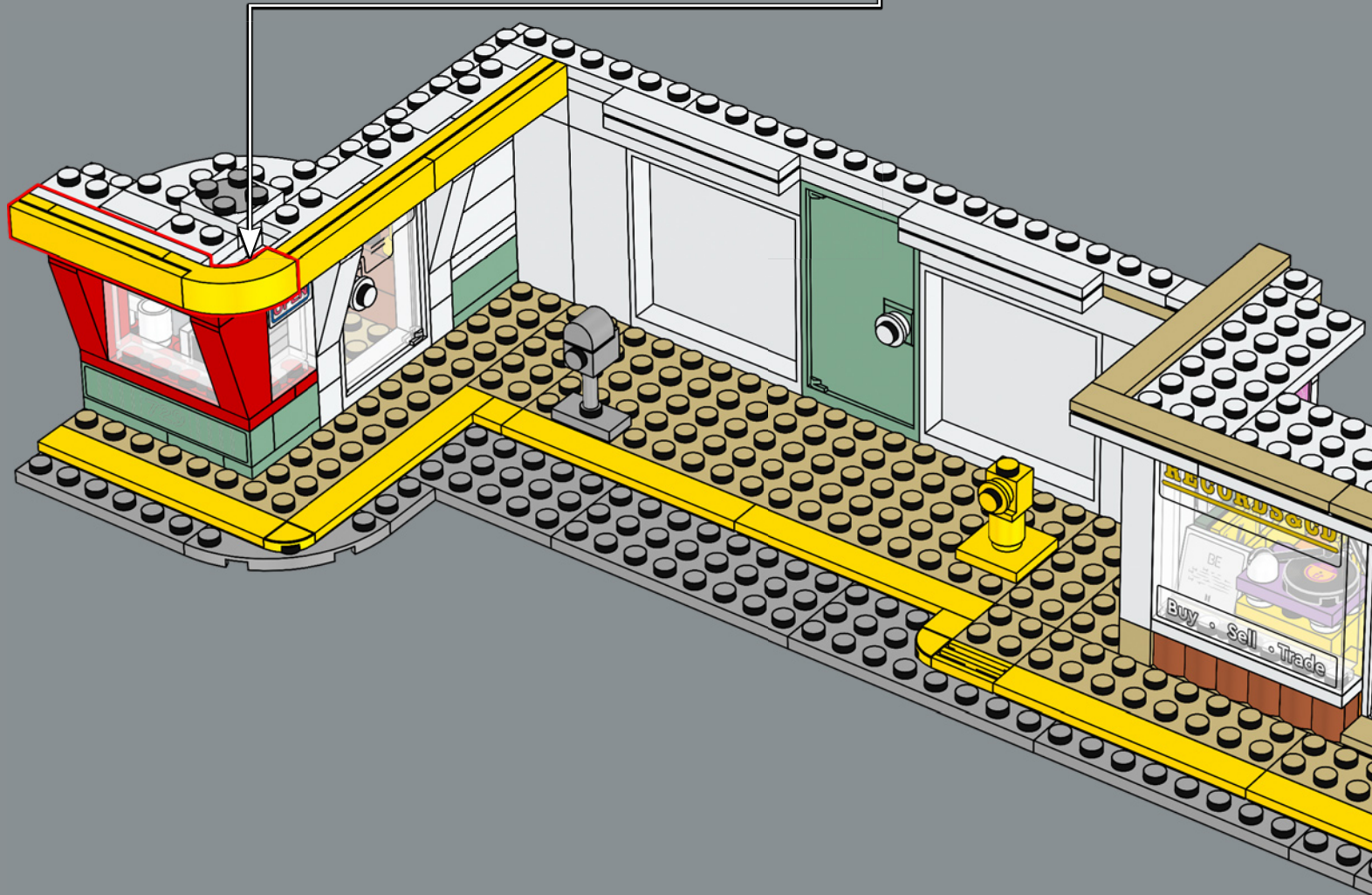

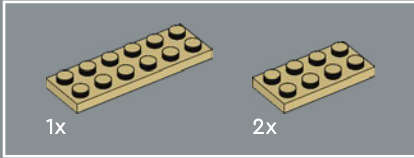
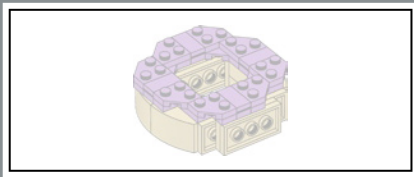

66

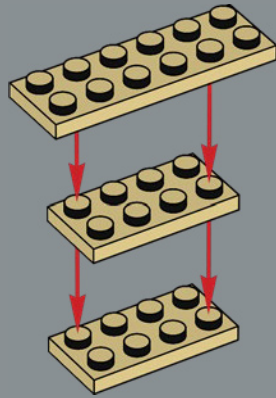

67

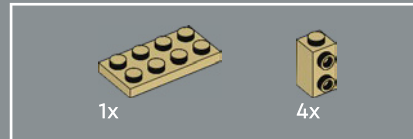
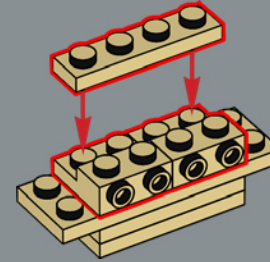

68

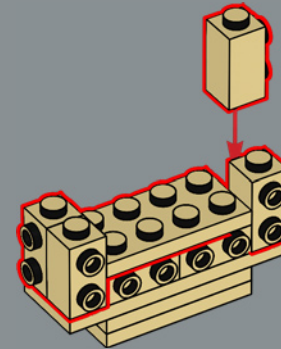



4x

69

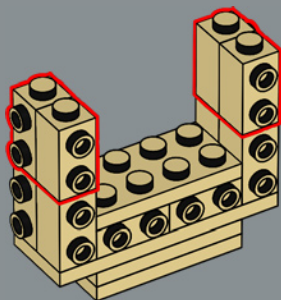

2x

70

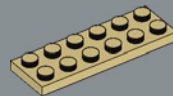
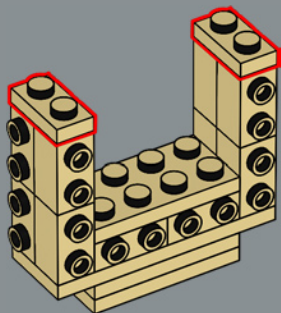

1x

71

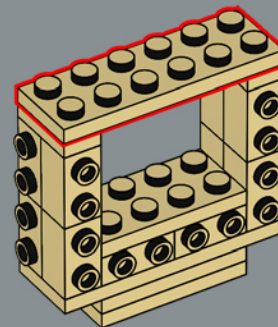

1x



3x

72

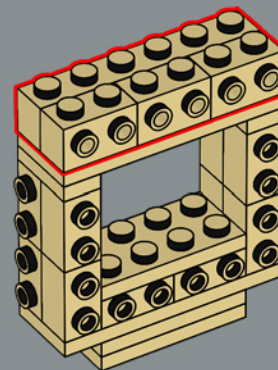

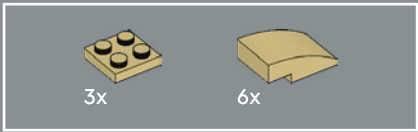

73

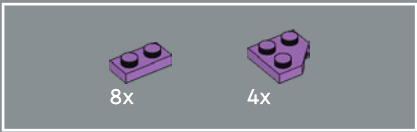
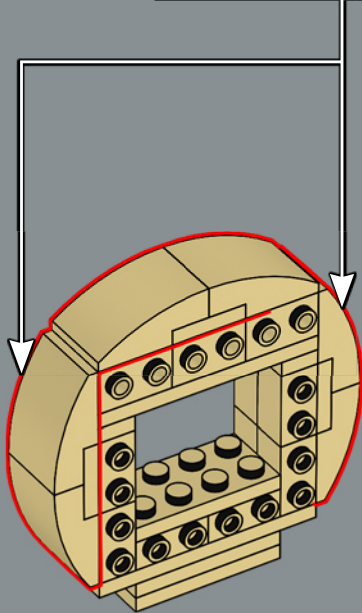
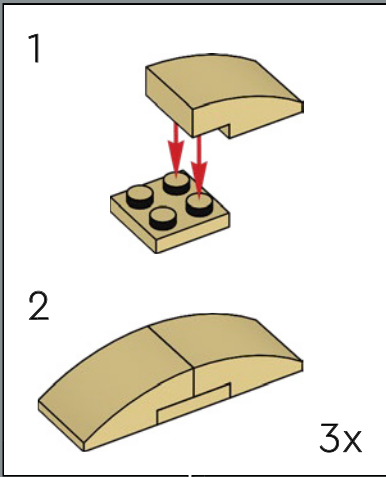

74

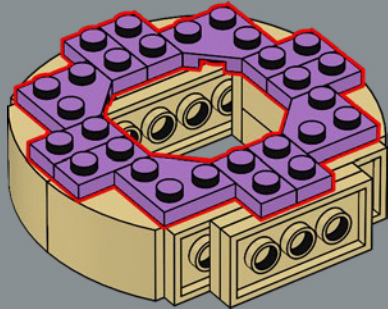

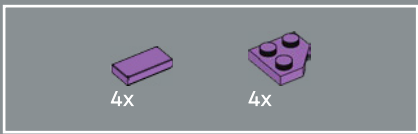

75

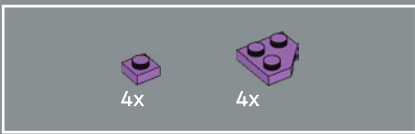
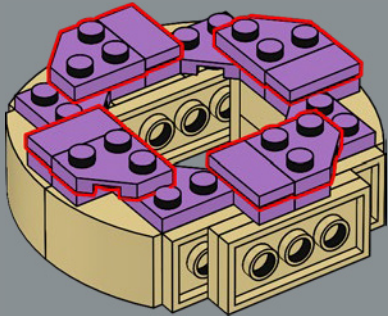

76

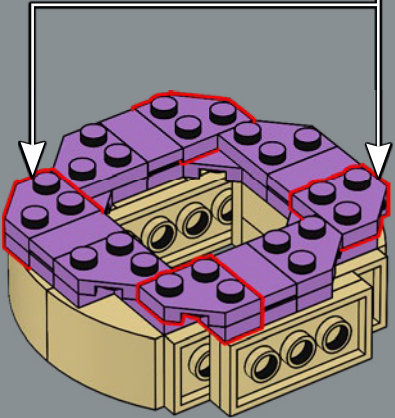
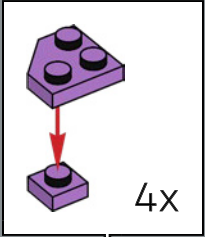

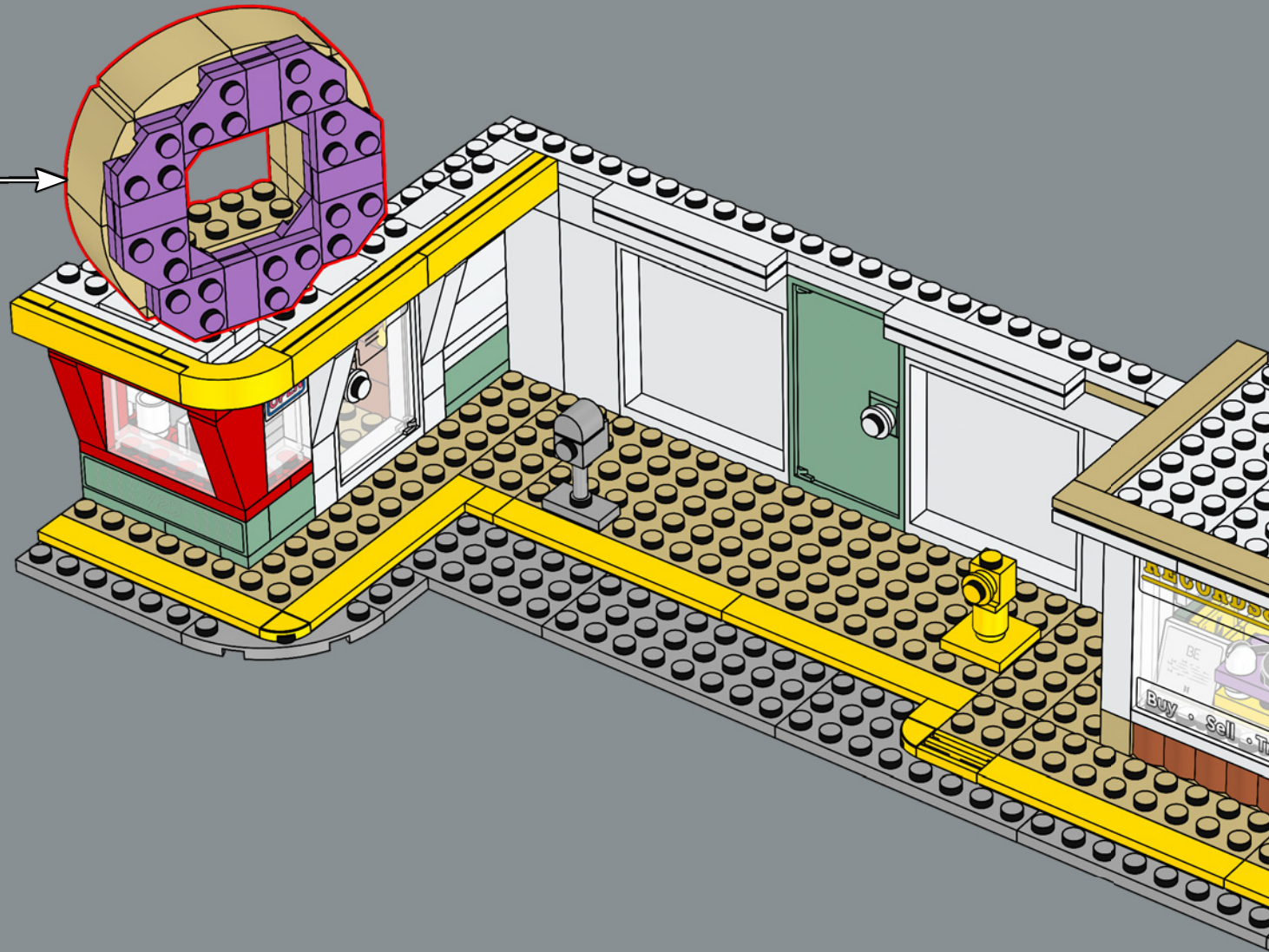

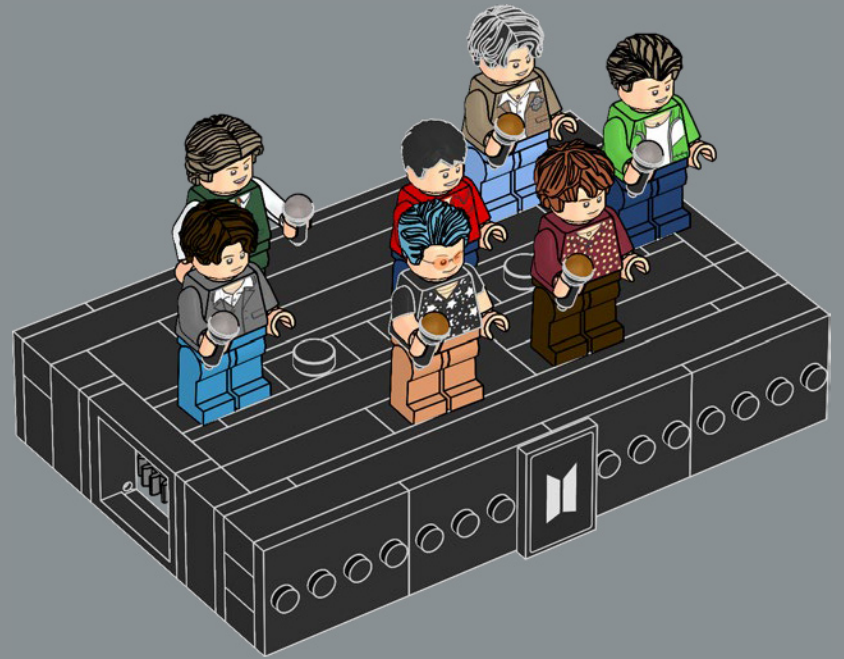
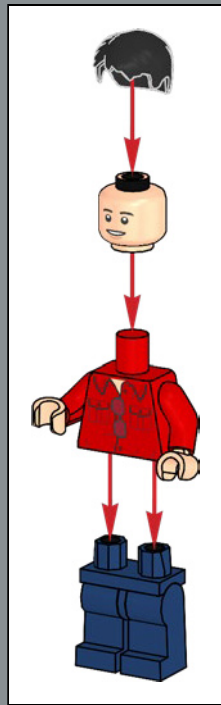

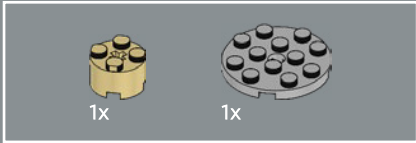
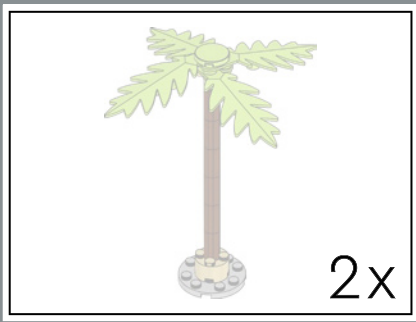

1

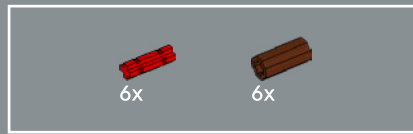
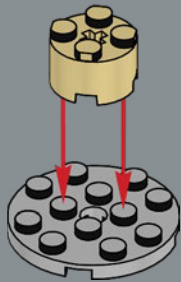

2

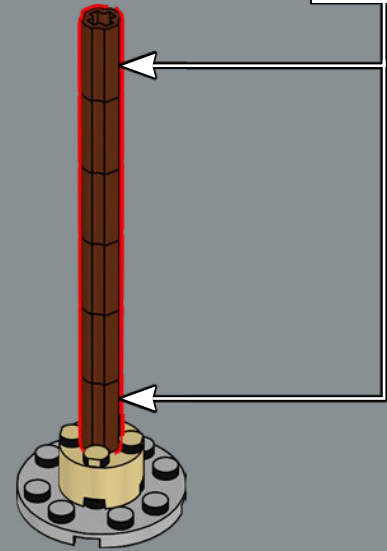
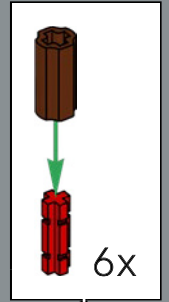

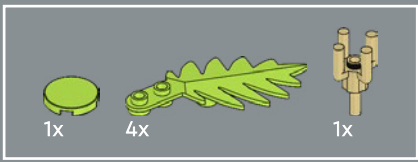

3

1

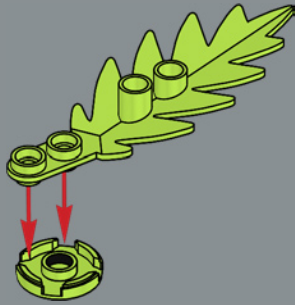

2

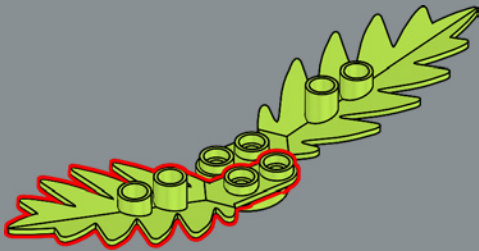

3

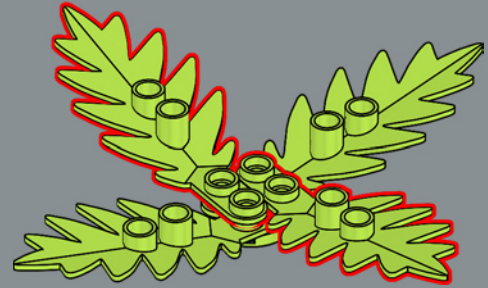

4

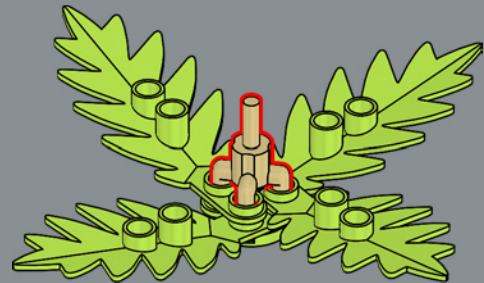



2x



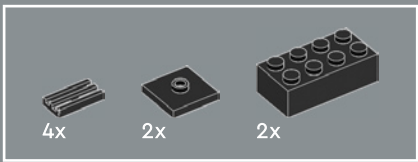

78

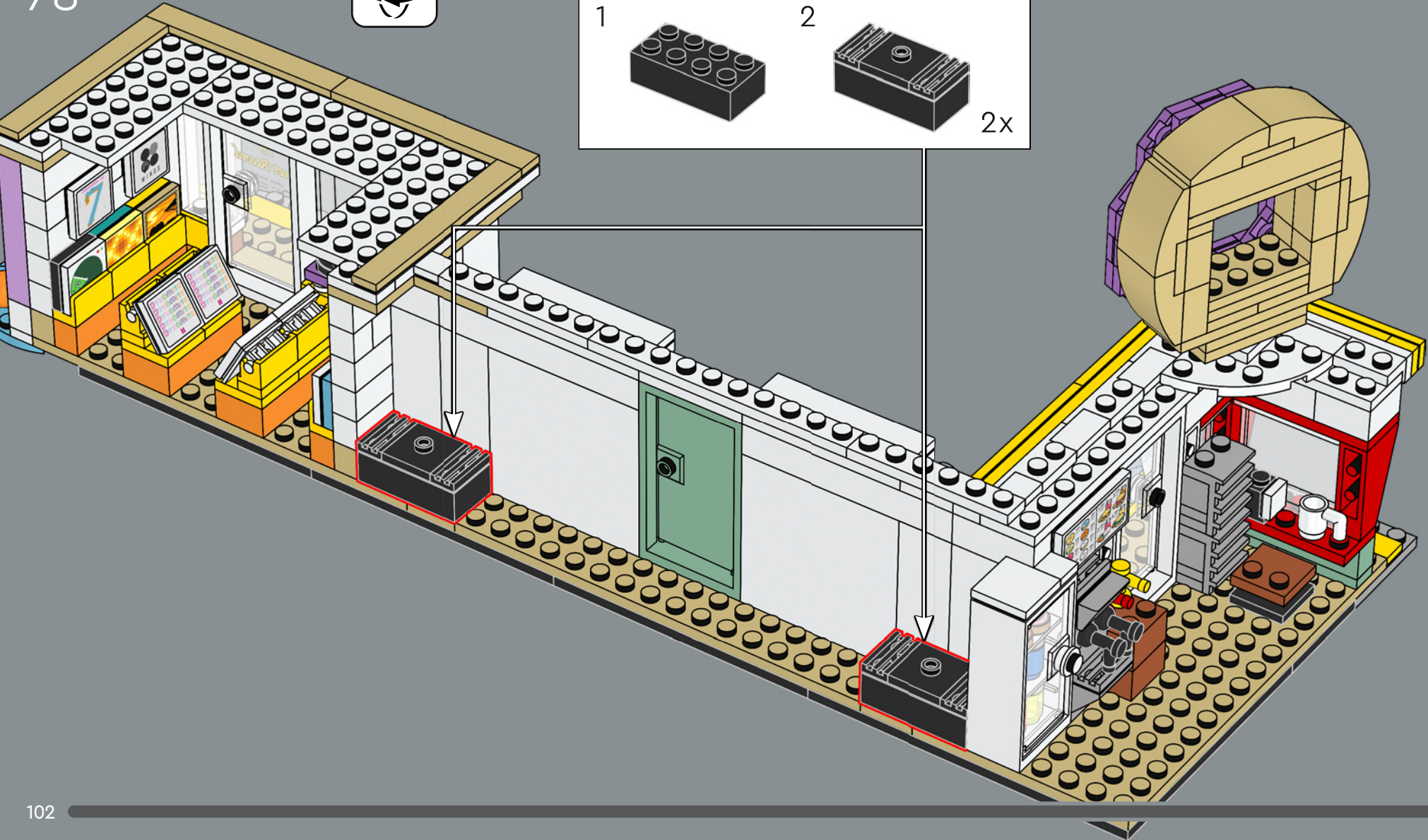
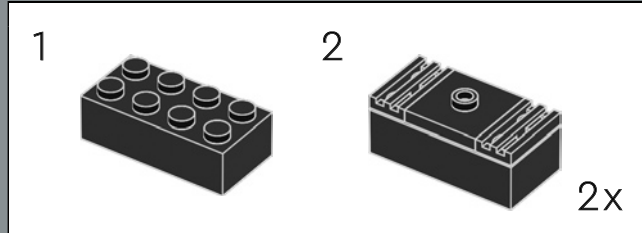

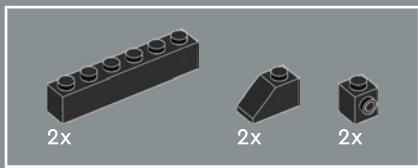

79

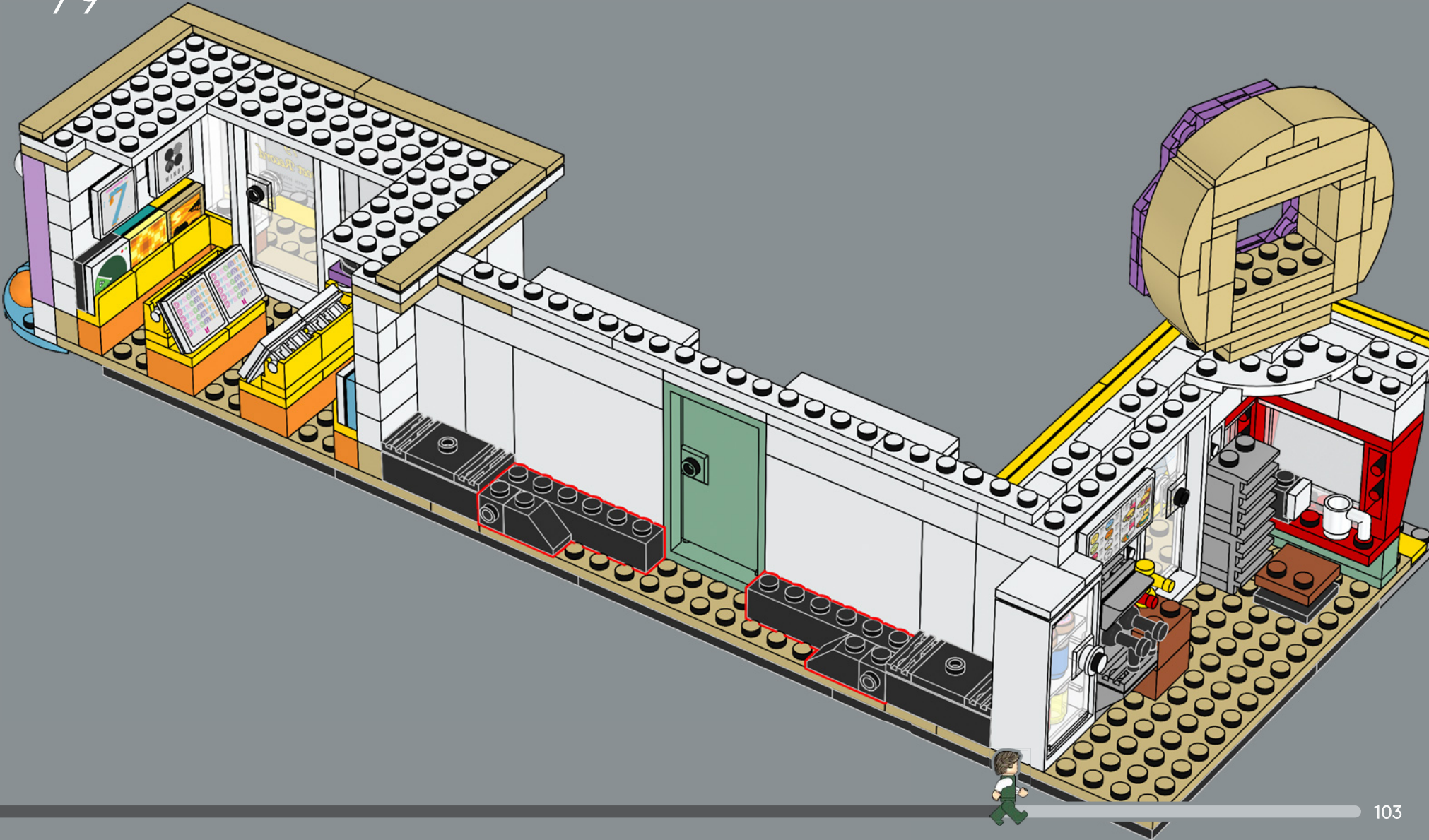

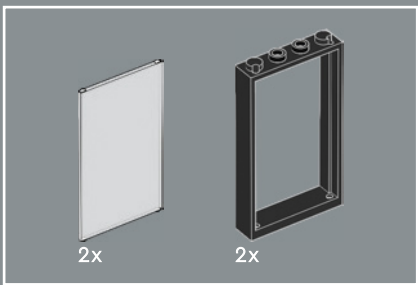

80

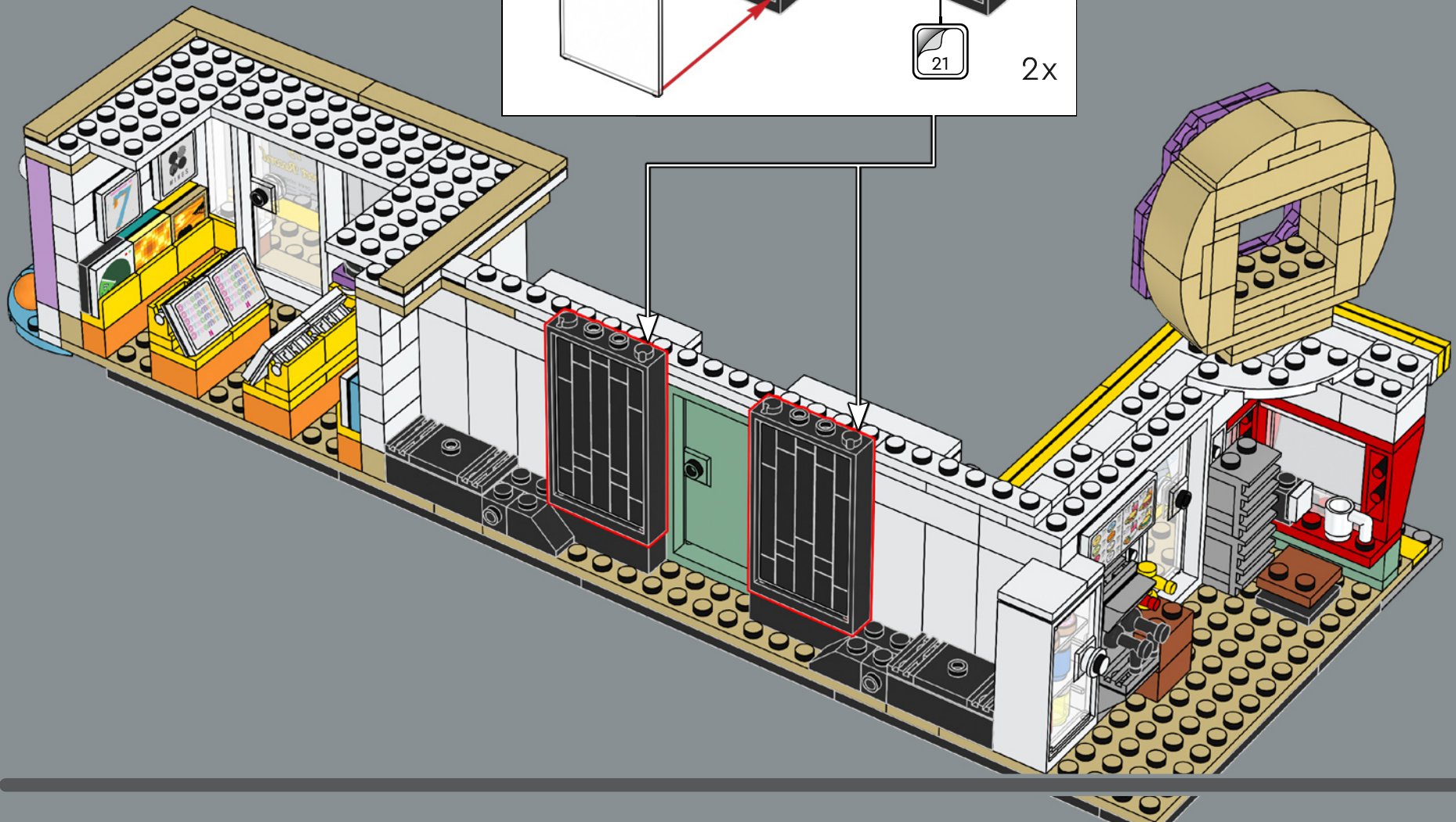
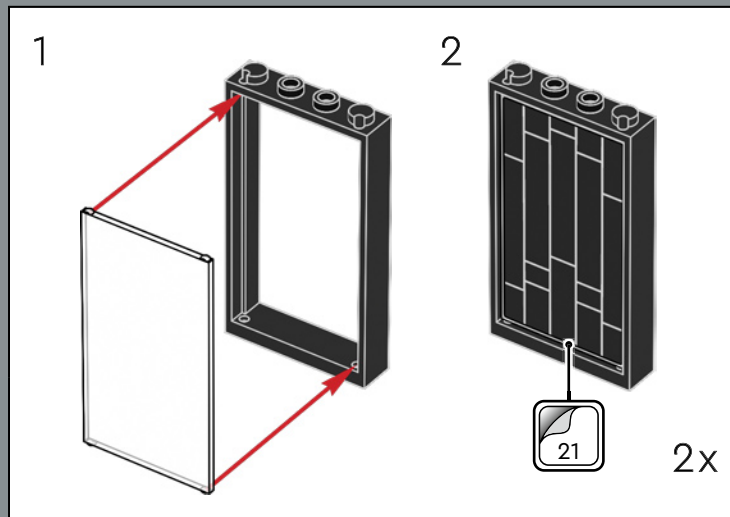

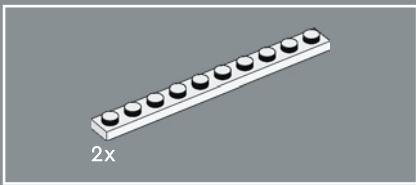

81

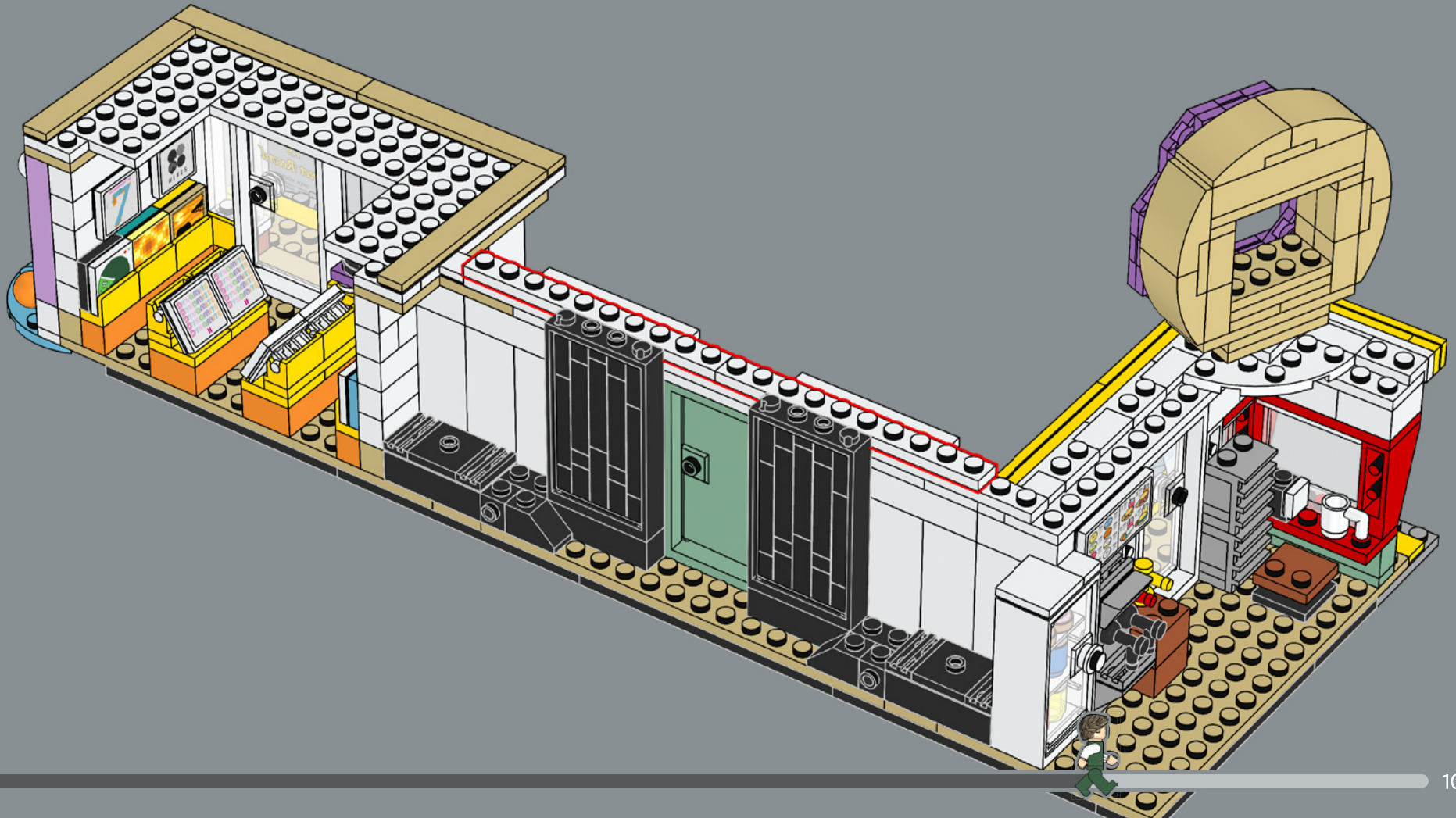

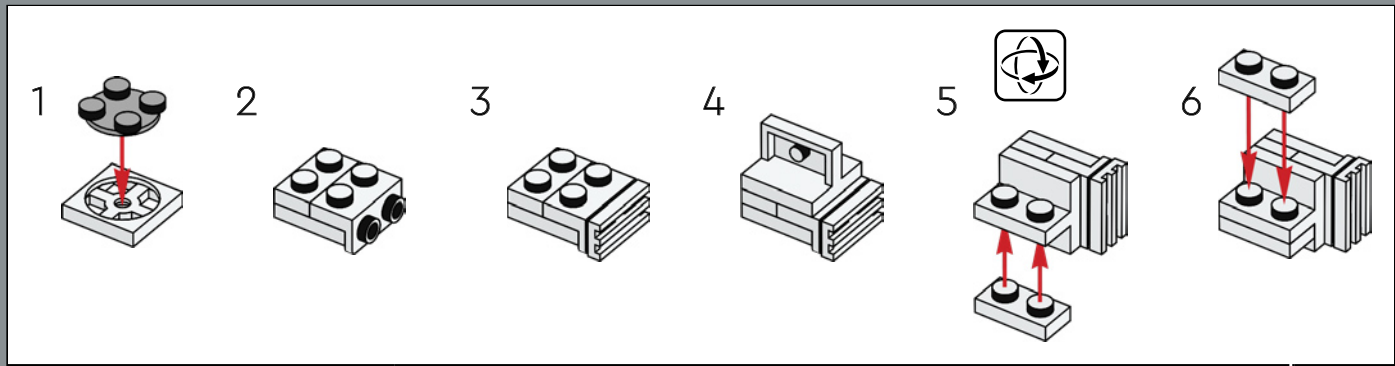
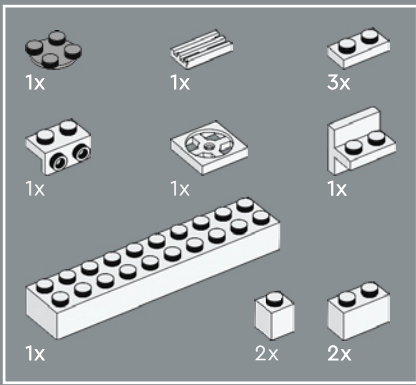

82

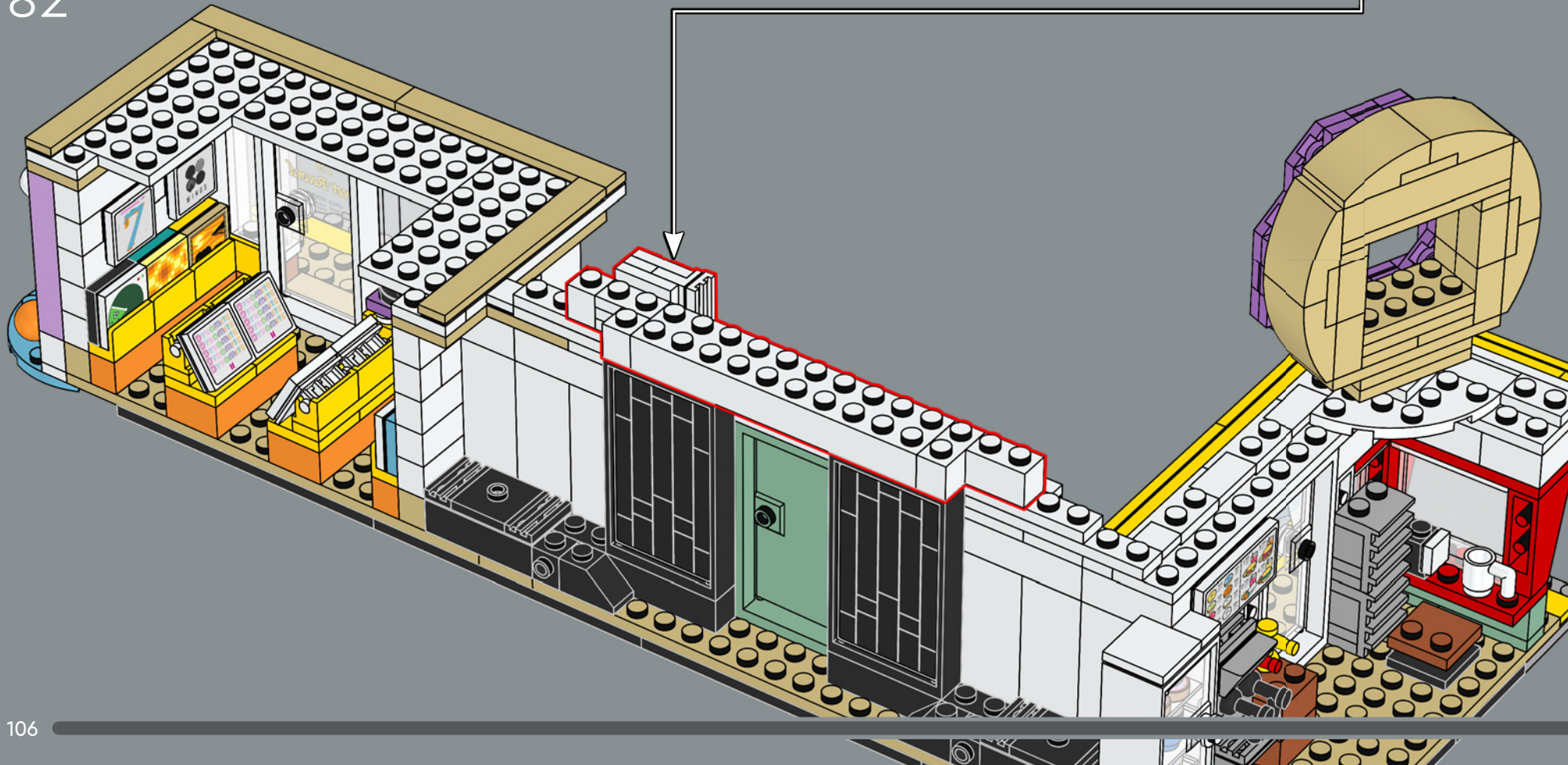

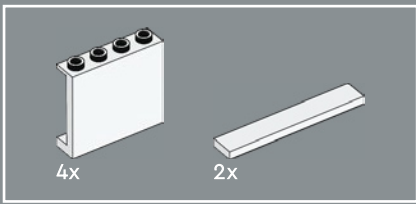

83

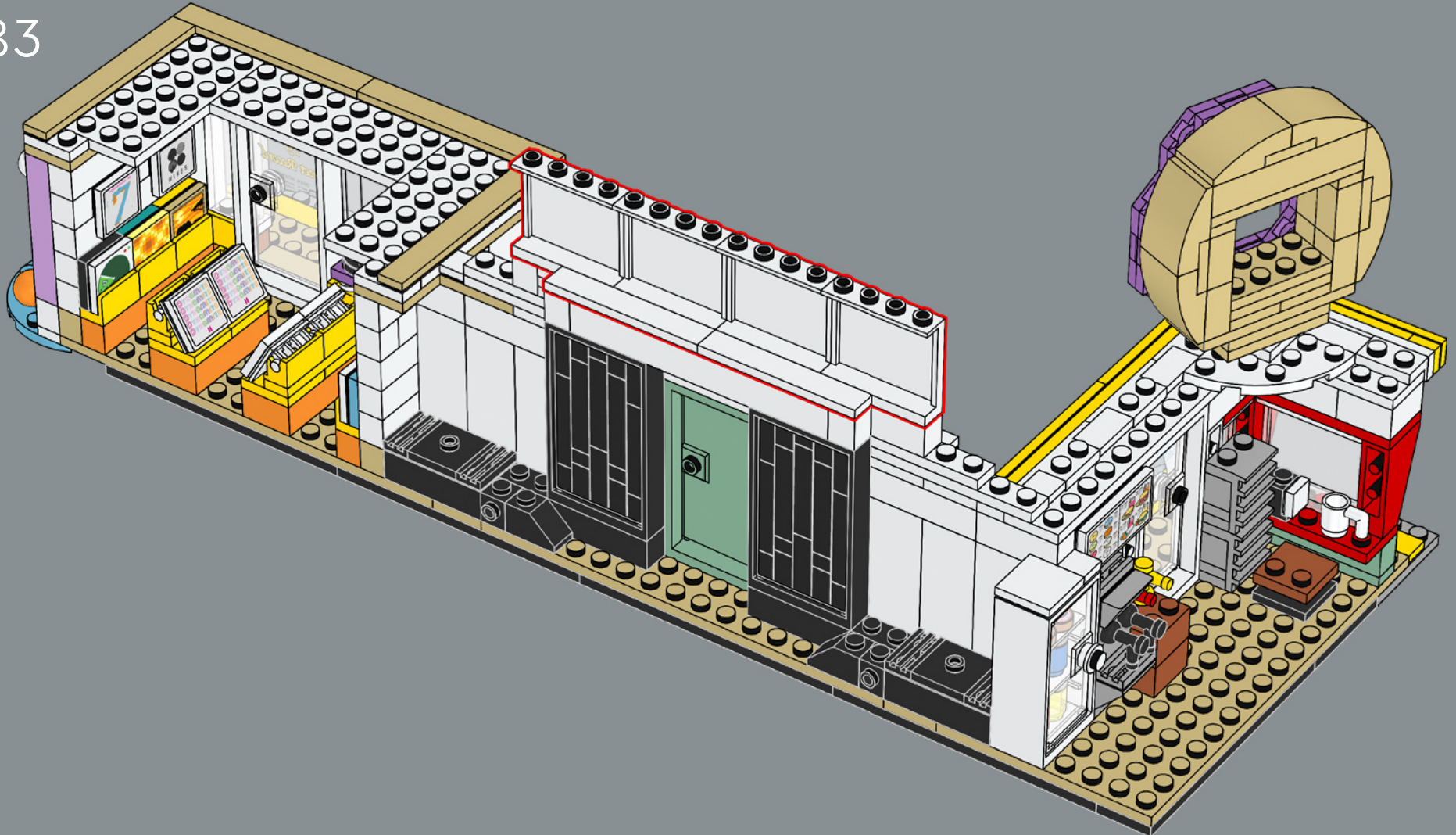

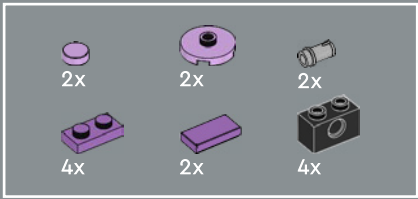

84

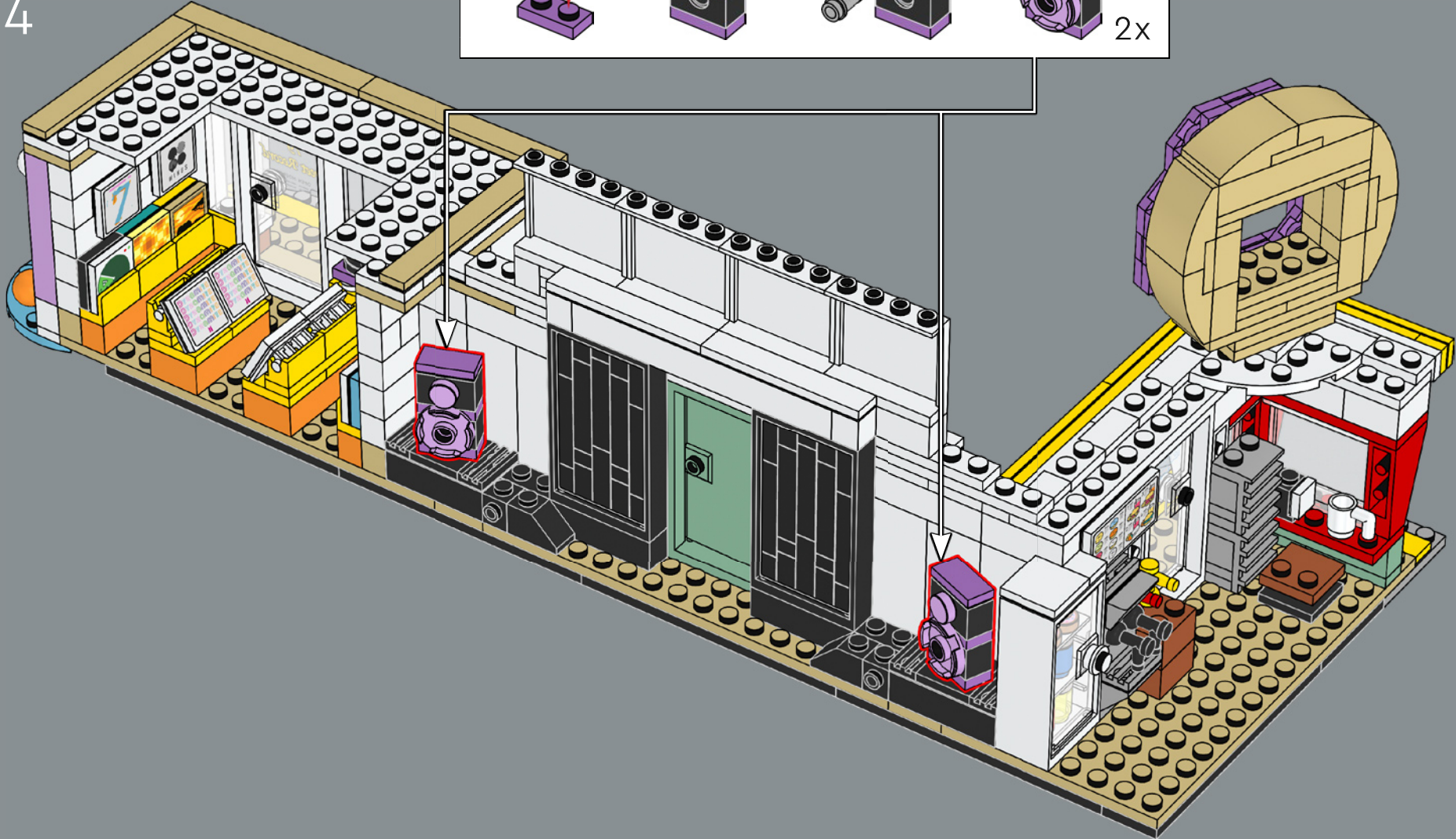
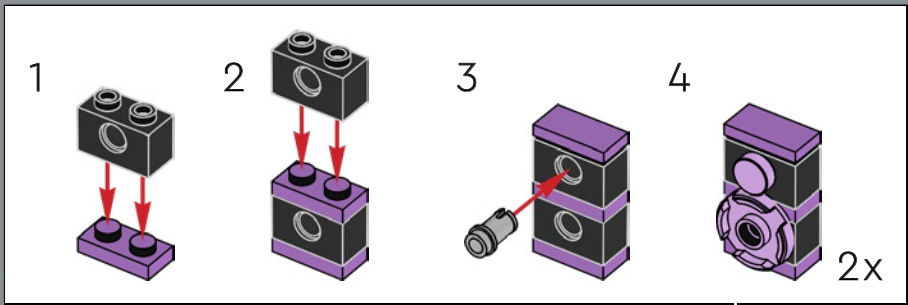

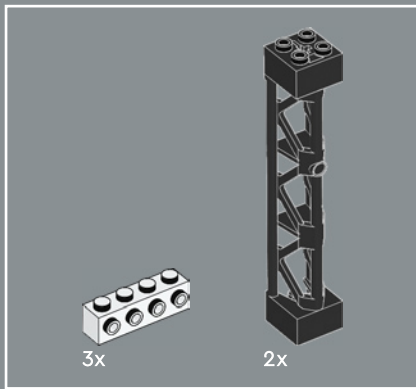

85

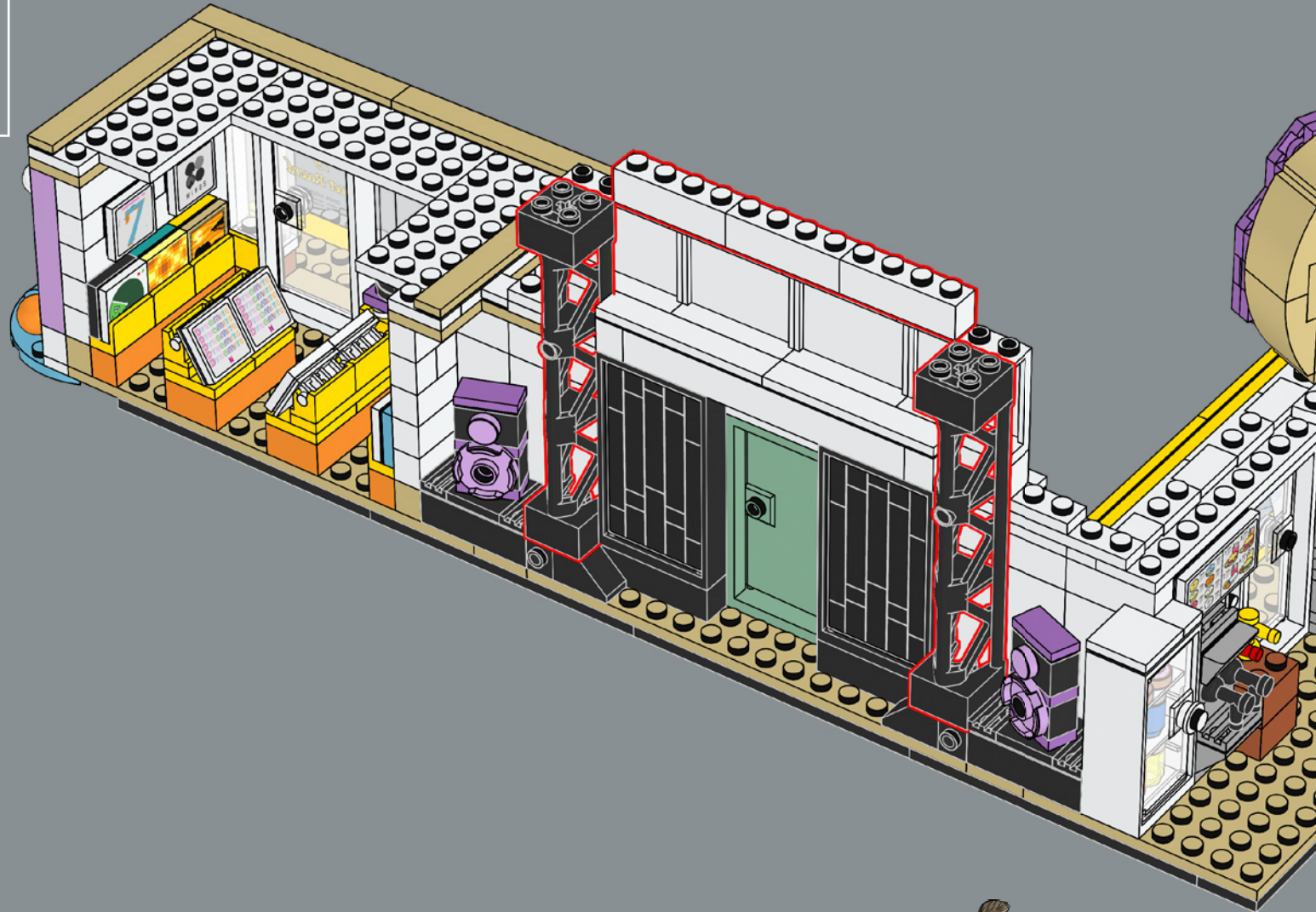

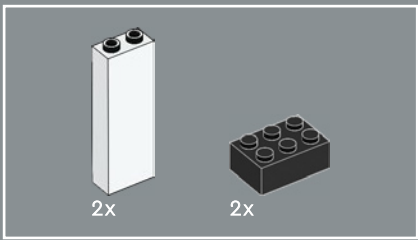

86

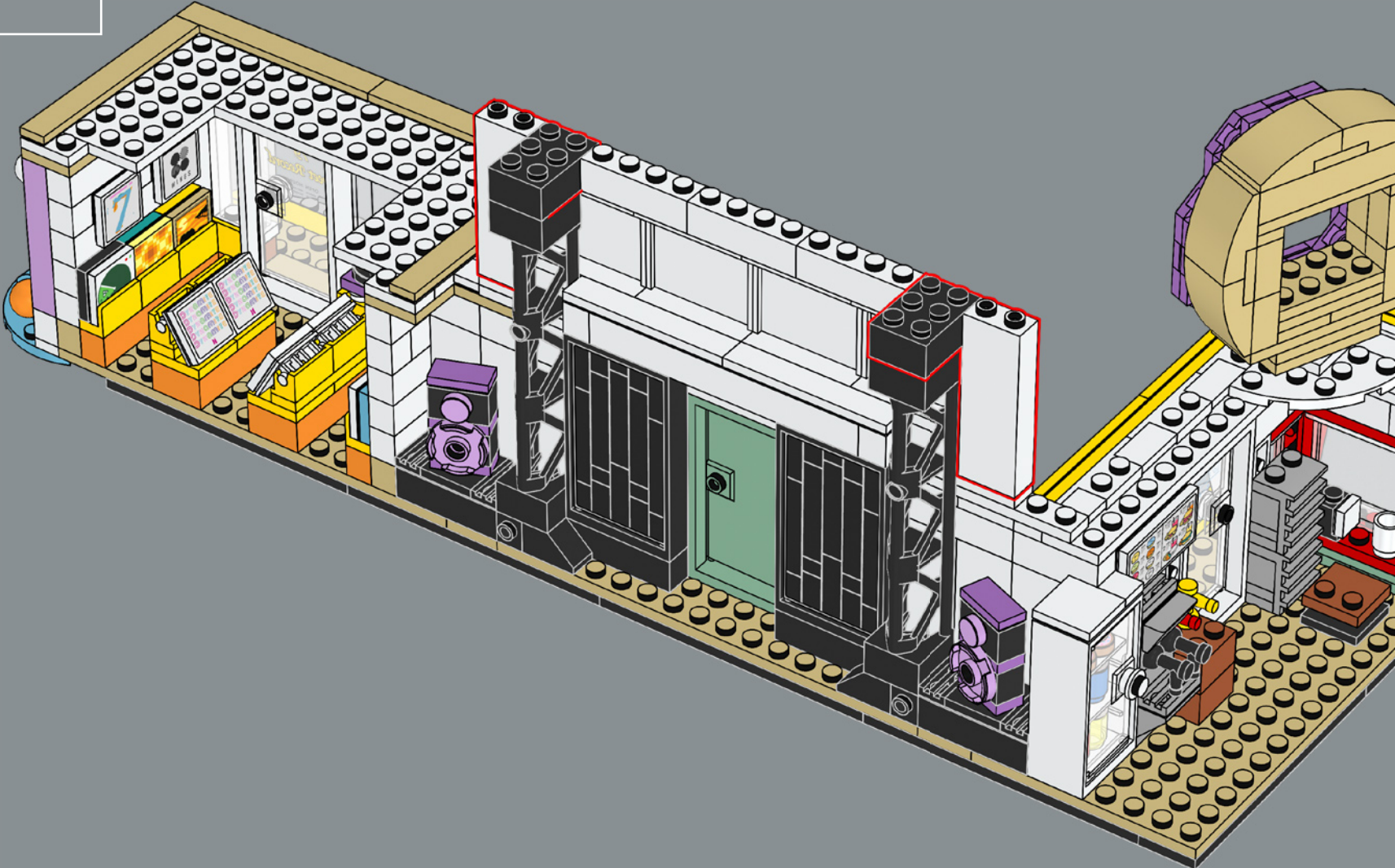



87

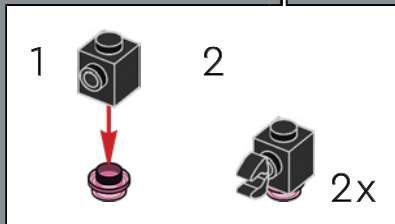
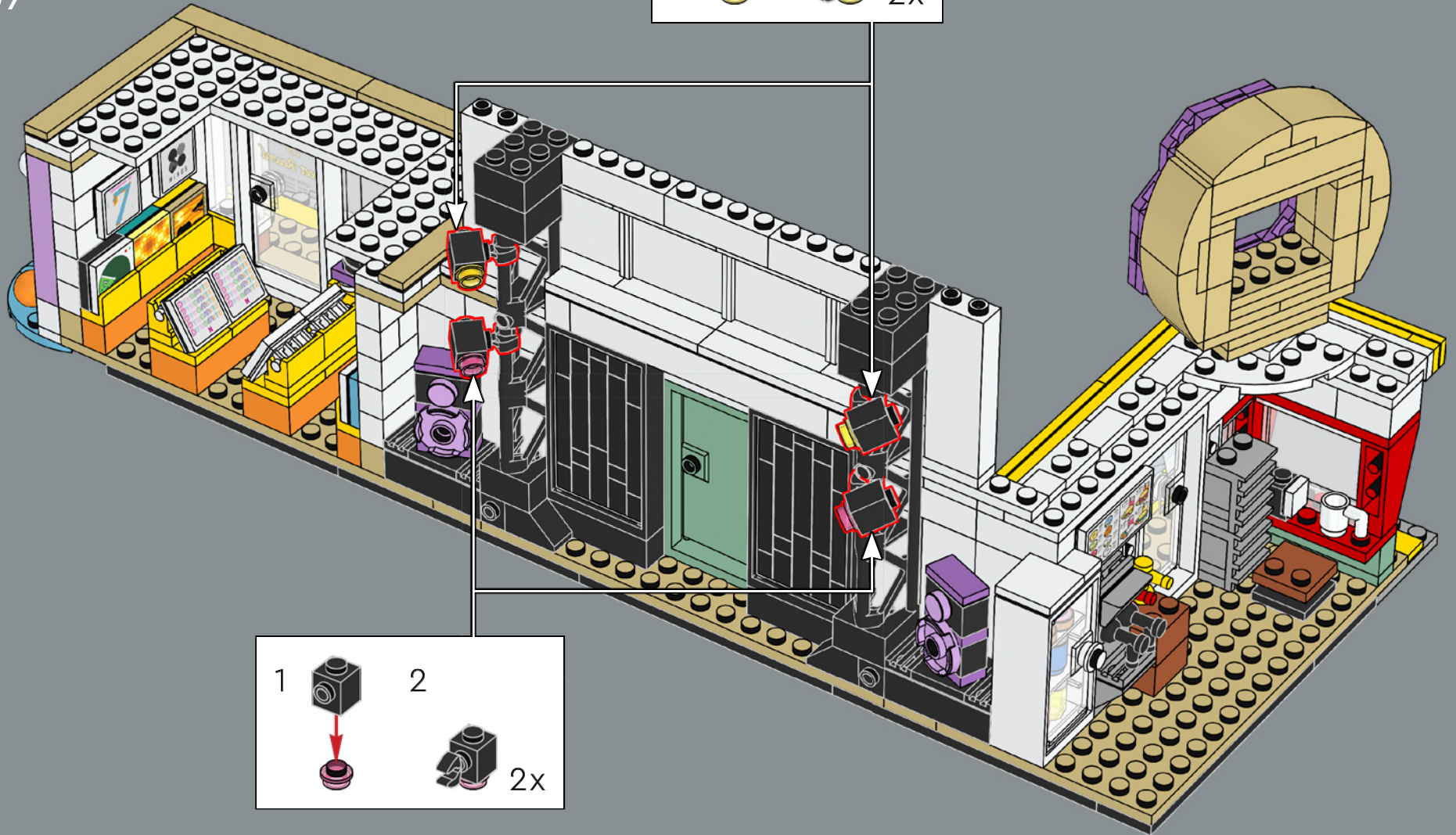
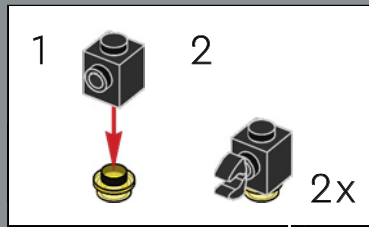



8x



88

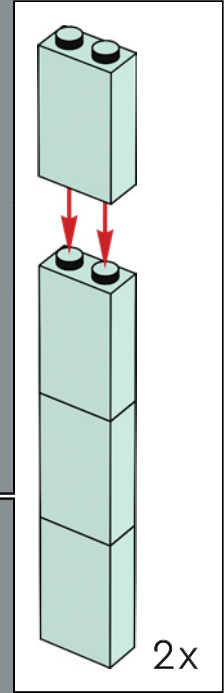

2x

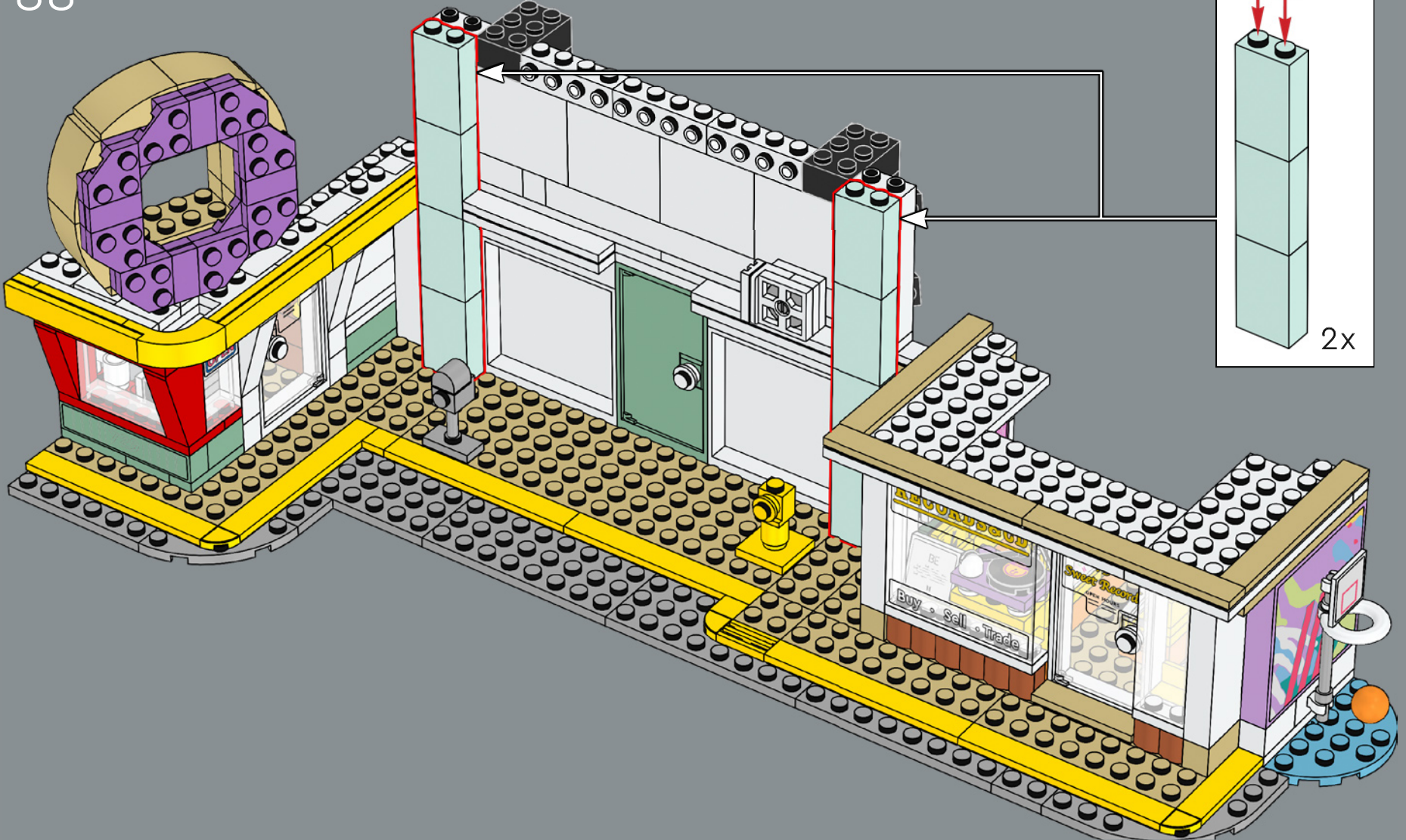

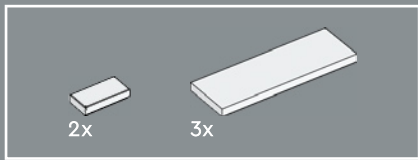

89

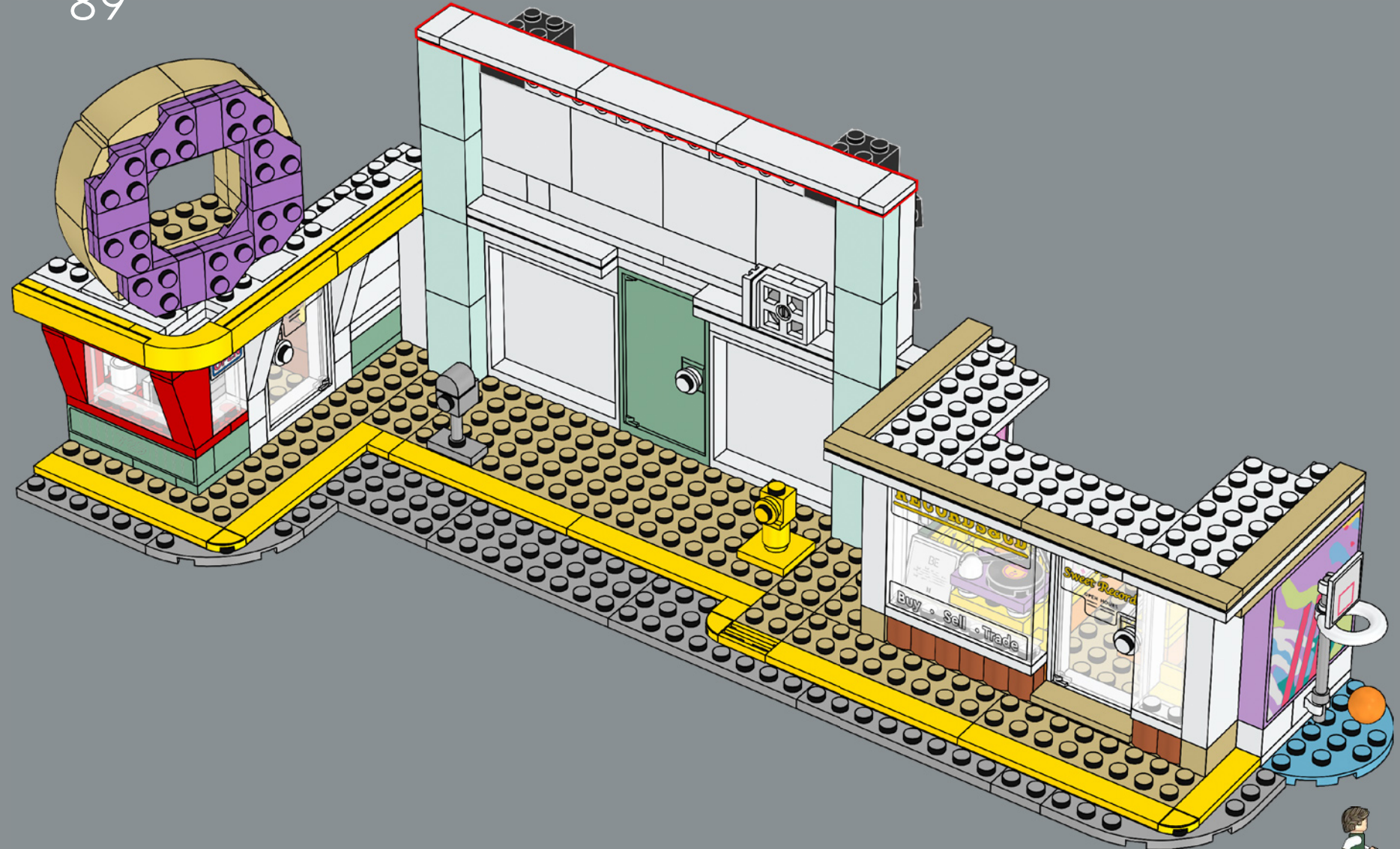

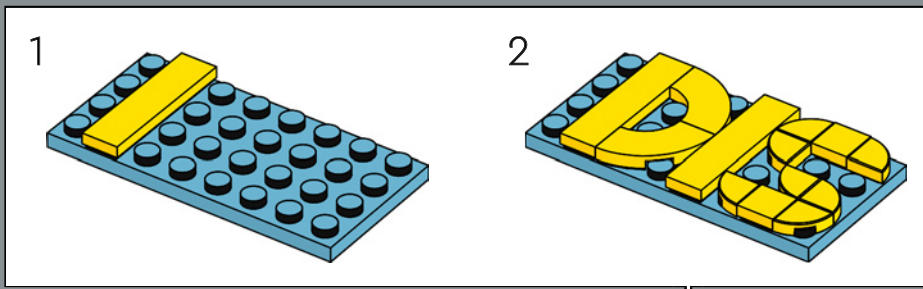
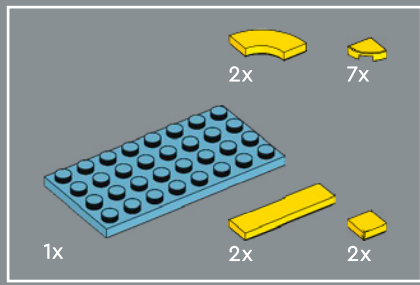

90

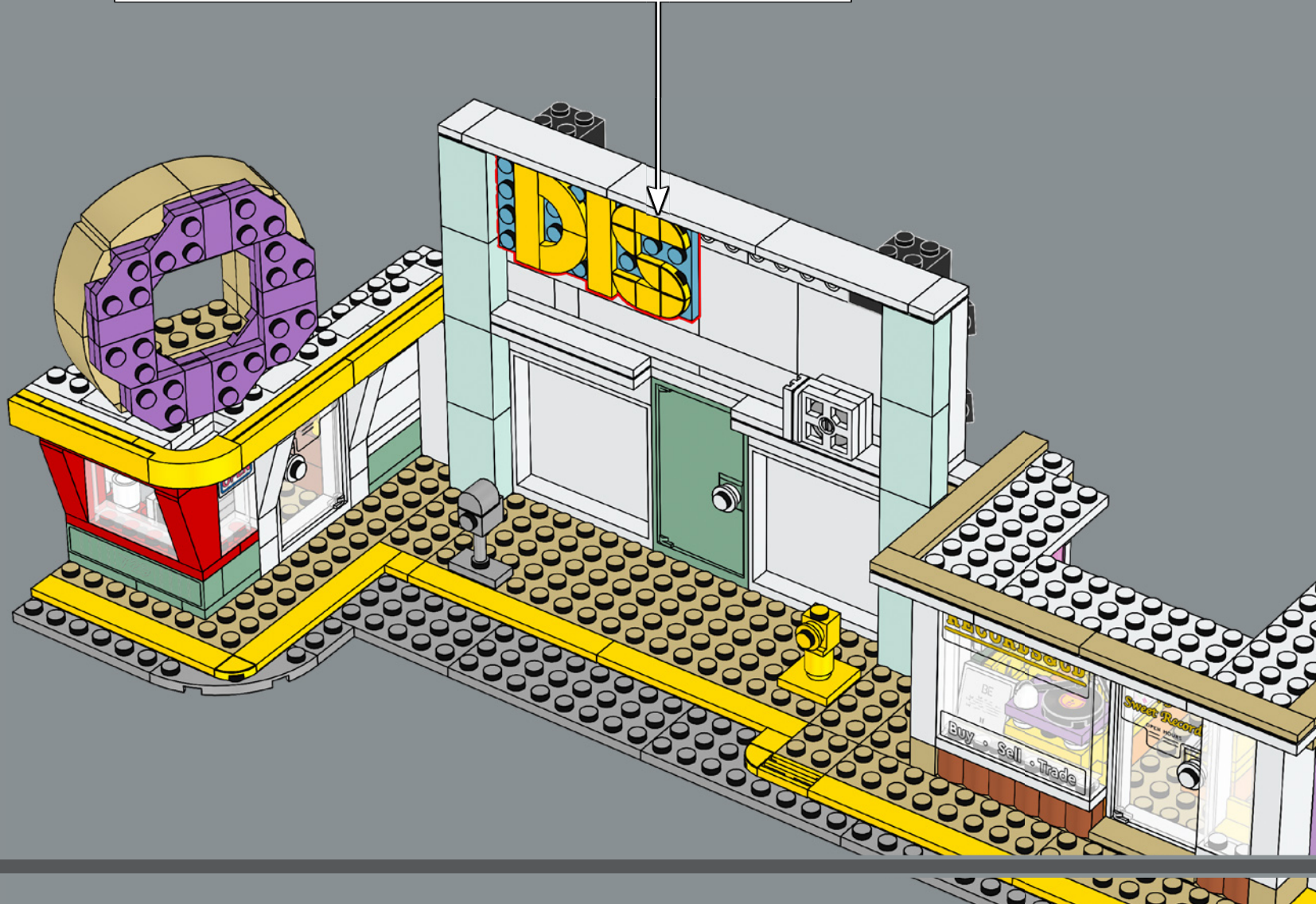

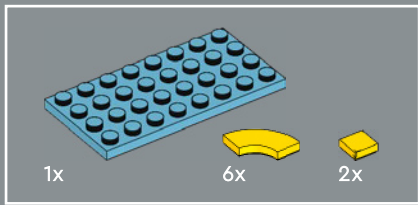

91

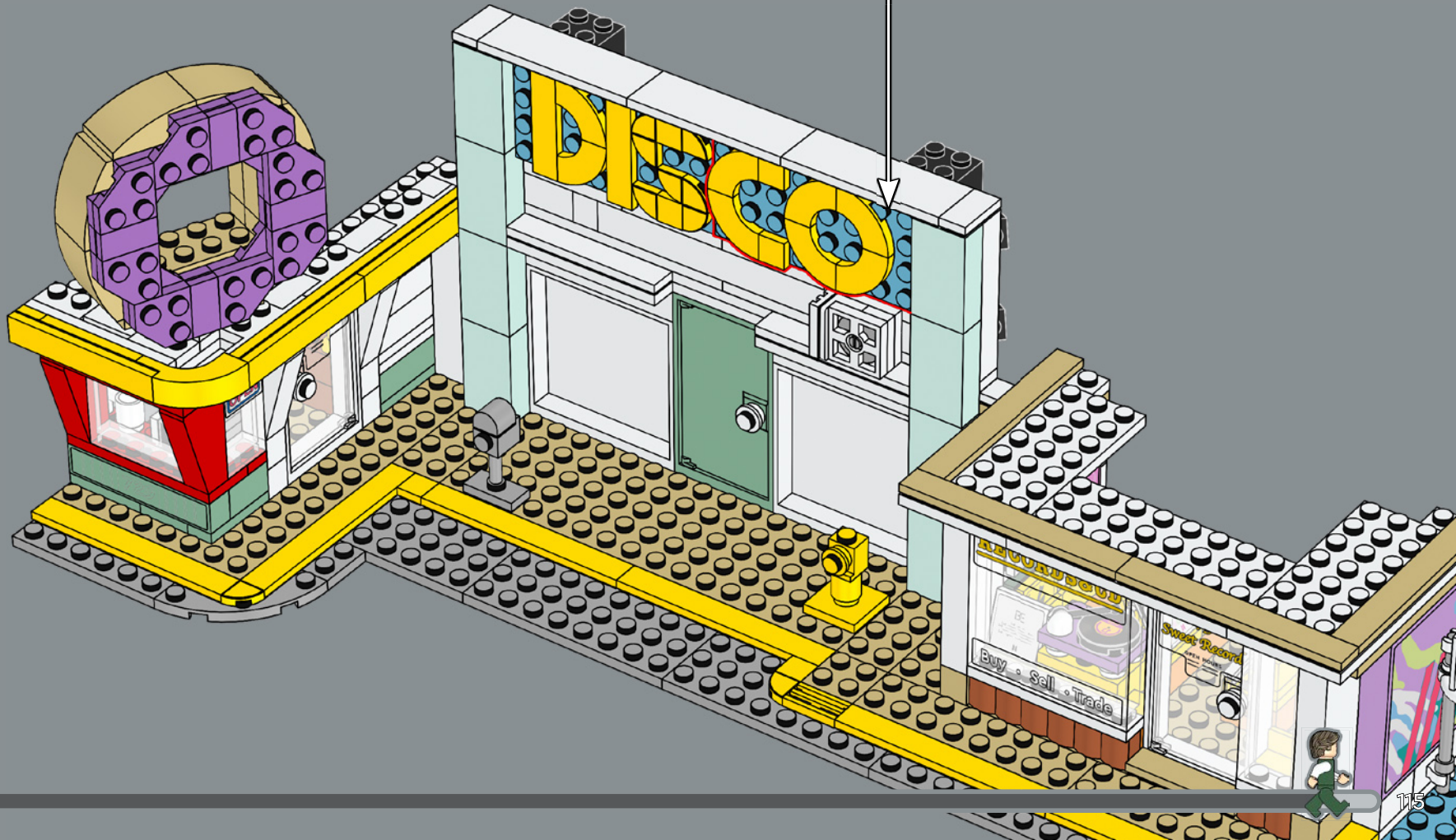
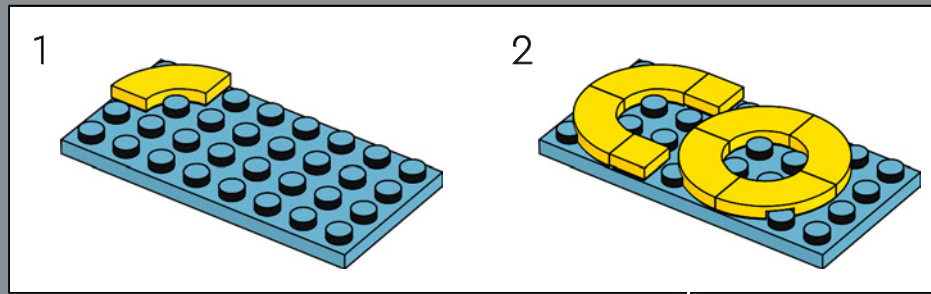

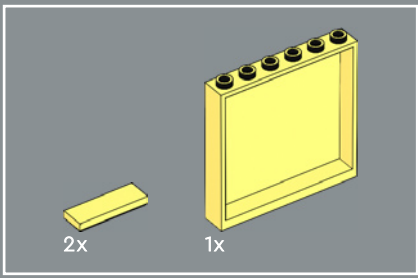

92

1

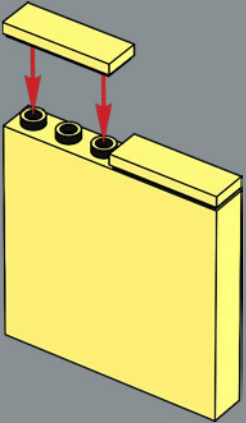

2







IDEAS

GATHER SUPPORT
OBTENEZ DE L'APPUI
OBTÉN APOYOS

SHARE YOUR IDEA
PARTAGEZ VOTRE IDÉE
COMPARTE TU IDEA

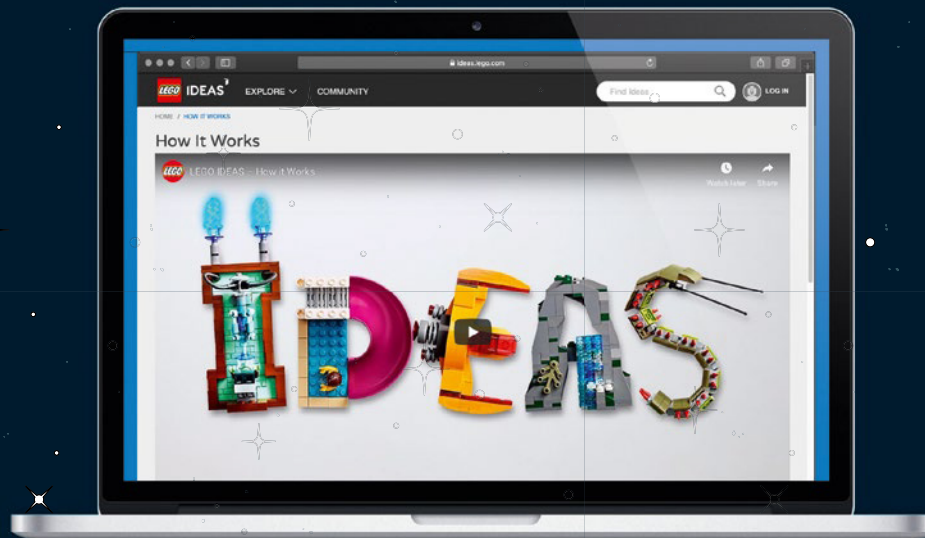

NEW LEGO® PRODUCT
NOUVEAU PRODUIT LEGO®
NUEVO PRODUCTO LEGO®

LEGO® REVIEW
EXAMEN LEGO®
REVISIÓN DE LEGO®

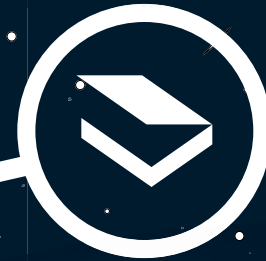

ideas.LEGO.com

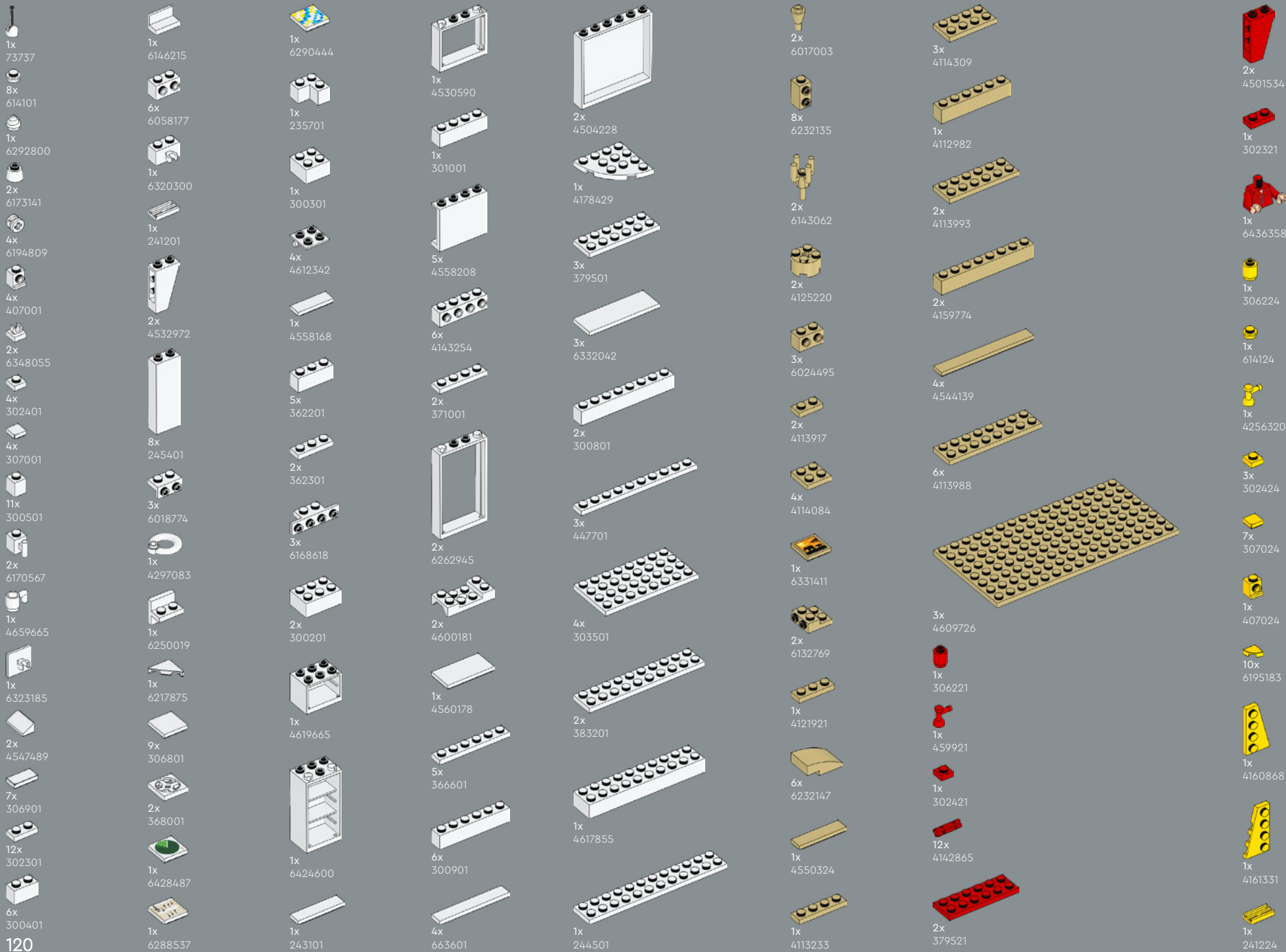



- 4x 6327722
- 4x 6168647
- 2x 4539481
- 1x 4226995
- 5x 6170418
- 9x 6275844
- 2x 4211483
- 1x 4211476
- 1x 6262085
- 3x 6248890
- 2x 6420741
- 1x 4568637
- 2x 4540203
- 1x 4211383
- 1x 4211357
- 1x 6066097
- 5x 4211398
- 2x 4211350
- 3x 4211388
- 1x 6123809
- 2x 6285243

- 4x 6322904

- 1x 6093527

- 1x 6435857

- 1x 6118827

- 3x 4515351

- 1x 4211395

- 1x 4579294

- 1x 4211452

- 1x 4211404

- 1x 6368430

- 4x 4211408

- 1x 6060795

- 2x 6031883

- 3x 6092768

- 1x 6353189

- 2x 6424476

- 1x 4615728

- 1x 6002148

- 1x 6424856

- 1x 6346547

- 1x 6342692

- 1x 6177081

- 9x 6133119

- 1x 6436391

- 1x 6058014

- 5x 6286832

- 1x 6335367

- 1x 6296492

- 2x 6195265

- 1x 6248756

- 3x 6296524

- 1x 6309939

- 1x 6248761

- 1x 6422515

- 1x 6422517

- 1x 6422519

- 1x 6422513

- 1x 6422509

- 1x 6422511

- 1x 6422521

- 1x 6436364

- 1x 4529672

- 2x 6322820

- 2x 6223598

- 1x 6249322

- 1x 6005307

- 1x 6436401

- 1x 4625032

- 1x 6029690

- 2x 6104130

- 4x 4619521

- 12x 4619512

- 6x 6152645

- 12x 6424858

- 1x 6344844

- 4x 6329593

- 2x 6248536

- 1x 6259706

- 1x 6313132



 [LEGO.com/service](https://www.LEGO.com/service)



YOU COULD WIN



YOU COULD WIN

Your feedback will help shape the future development of this product series.

Visit:

DU KÖNNTEST GEWINNEN

Dein Feedback trägt zur Weiterentwicklung dieser Produktreihe bei.

Geh auf:

VOUS POURRIEZ GAGNER

Vos commentaires nous aideront à concevoir les futurs produits de cette gamme.

Visitez :

POTRESTI VINCERE TU

La tua opinione ci aiuterà a migliorare la creazione futura di questa linea di prodotti.

Visita:

PUEDES GANAR

Tu opinión contribuirá al futuro de esta serie de productos.

Visita:

轻松获奖

您的反馈将有助于我们在今后改进本产品系列。

请访问:

[LEGO.com/productfeedback](https://www.lego.com/productfeedback)

You also have the chance to win a LEGO® set.

Terms and conditions apply.*

Außerdem hast du die Chance, ein LEGO® Set zu gewinnen.

Es gelten die Teilnahmebedingungen.*

Vous pourriez également gagner un ensemble LEGO®.

Des conditions s'appliquent.*

Hai anche la possibilità di vincere un set LEGO®.

Termini e condizioni sono applicabili.*

También tienes la oportunidad de ganar un set LEGO®.

Aplican términos y condiciones.*

您还有机会赢取乐高®套装。

条款和条件适用。*

*[LEGO.com/productfeedback-terms](https://www.lego.com/productfeedback-terms)

