

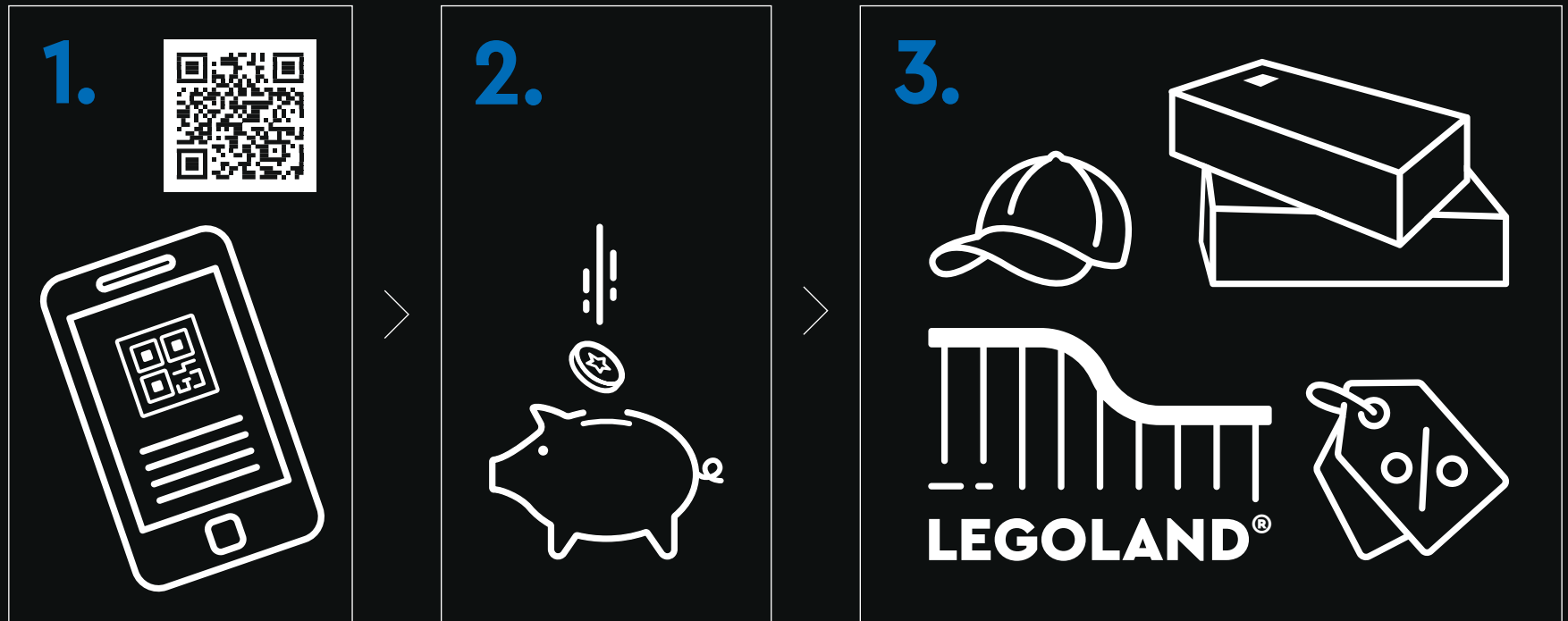



LEGO.com/sustainable-packaging

LEGO® VIP



1. Sign up **2.** Earn points for purchases **3.** Redeem points for rewards, experiences, discounts & more | **1.** Melde dich an **2.** Sammle Punkte bei jedem Kauf **3.** Löse die Punkte für Belohnungen, Erlebnisse, Rabatte und Ähnliches ein | **1.** Inscrivez-vous **2.** Gagnez des points lors de vos achats **3.** Échangez vos points contre des récompenses, des expériences, des remises et bien plus encore | **1.** Iscriviti **2.** Guadagna punti con i tuoi acquisti **3.** Riscatta punti per premi, esperienze, sconti e altro ancora | **1.** Regístrate **2.** Gana puntos por tus compras **3.** Canjea puntos por recompensas, experiencias, descuentos y mucho más | **1.** Registe-se **2.** Ganhe pontos em compras **3.** Troque os pontos para prémios, experiências, descontos e muito mais | **1.** 注册 **2.** 购物赚积分 **3.** 用积分兑换奖励、体验、折扣等 | **1.** Zarejestruj się **2.** Zdobywaj punkty za zakupy **3.** Wymieniaj punkty na rabaty, przygody i inne nagrody | **1.** Zaregistrujte se **2.** Sbírejte body za nákupy **3.** Vyměňujte body za odměny, zážitky, slevy a spoustu dalšího | **1.** Zaregistrujte se **2.** Získavajte body za nákupy **3.** Uplatnite si body a získajte odmeny, rôzne zážitky, zľavy a ešte viac | **1.** Regisztrálj **2.** Szerezz pontokat minden vásárlással **3.** Váltsd be pontjaidat jutalmakra, élményekre, kedvezményekre és egyebekre | **1.** Înscrite-te **2.** Câștigă puncte pentru achiziții **3.** Valorifică puncte pentru recompense, experiențe, reduceri și multe altele | **1.** Регистрируйте се **2.** Получайте точки за покупки **3.** Используйте точки за награды, услуги, отстъпки и т.н. | **1.** Reģistrējies **2.** Pelni punktus par pirkumiem **3.** Izmanto punktus, lai saņemtu balvas, izklaides iespējas, atlaides un daudz ko citu | **1.** Registreeru **2.** Teeni ostude eest punkte **3.** Lunasta punktide eest preemiad, elamused, allahindlused ja muu | **1.** Užsiregistruokite **2.** Pelnykite taškų už pirkinius **3.** Panaudokite taškus atlygiui, funkcijoms, nuolaidoms ir ne tik



W.



**CONOCE AL
FAN DISEÑADOR**

E

El director y guionista francés Thomas Lajon (apodado LEt.sGO en LEGO® Ideas) tuvo su primer set LEGO a los cuatro años y todavía le encanta construir. En la actualidad, comparte su pasión por LEGO (y los ladrillos) con las personas a las que más quiere.

“Siempre he sido un gran admirador de las locomotoras y, si pudiera viajar en el tiempo (y tuviera el dinero suficiente para comprar el billete), ¡me montaría en el Orient Express! Es casi como si fuera de otro mundo, por eso me encanta. Este suntuoso tren llevó pasajeros por Europa en vagones de lujo durante cerca de un siglo y sigue estando en el centro de numerosas historias y mitos. Y a mí, que vengo de la escritura de guiones y del cine, el Orient Express me invita a viajar y me hace imaginar los relatos de aventuras más fantásticos y misteriosos. Con sus magníficos vagones creados por grandes artesanos y diseñadores,

el Orient Express es el tren de los sueños. Tiene un aire de inaccesibilidad y alimenta nuestra fantasía. Pertenece a las historias, obras literarias, canciones y producciones cinematográficas más míticas.

Este modelo es mi primer proyecto LEGO Ideas, y me llevó horas, días y noches de preparación, diseño y paciencia. Construí mi modelo mirando cientos de fotos de la locomotora Pacific 231 K 8 y el interior y exterior de los vagones. La versión final del set es preciosa, y el equipo de diseñadores de LEGO ha hecho un sensacional trabajo dando vida a este sueño. Mi detalle favorito es el espejo convexo que refleja el interior del coche cama. Para mí, es la guinda del pastel. ¡Y también quiero enviar mi agradecimiento a cada uno de los 10.000 seguidores del proyecto en LEGO Ideas que hicieron realidad este momento de felicidad!”



Propuesta original de Thomas

TRAZADO DE LAS VÍAS HACIA UN NUEVO MUNDO



Durante la Revolución Industrial, los trenes y ferrocarriles se convirtieron en símbolos de progreso tecnológico y poder político. Aparecieron miles de kilómetros de nuevas vías y rutas entre regiones, que trascendieron fronteras y trajeron consigo una nueva vida. Este hecho facilitó el transporte de mercancías con más eficiencia que nunca, el surgimiento de puestos de trabajo que antes no existían, el crecimiento económico, y nuevas y exóticas oportunidades de viaje para millones

de personas por todo el mundo. No obstante, en las etapas incipientes del transporte de pasajeros, la coordinación y la eficiencia de los cruces fronterizos eran bastante limitadas. Con la propagación de tensiones políticas por toda Europa, el estatus neutral de Bélgica desempeñaría un valioso papel en la instalación de las vías para el progreso global, ya que fue esta nación la que estableció conexiones ferroviarias de importancia estratégica hacia y a través de grandes partes del continente y las colonias.

UN GRAN AVANCE DIPLOMÁTICO

- En 1876, el visionario ingeniero y empresario belga Georges Nagelmackers fundó la Compagnie Internationale des Wagons-Lits (CIWL, Compañía Internacional de Coches Cama). Había visto el potencial que tenía el mercado de los viajes de lujo destinados a las clases altas. Inspirándose en los vagones restaurante y los coches cama que entonces estaban ganando popularidad en los Estados Unidos, inauguró la primera cadena de trenes de lujo que acabaría extendiéndose por todo el mundo. Mediante extensas negociaciones diplomáticas y, sin duda, una perseverancia y un optimismo sin precedentes, Nagelmackers obtuvo los permisos y contratos necesarios con los Estados vecinos para que permitieran que sus trenes cruzaran Europa sin obstáculos desde París hasta Constantinopla. Su diseño y construcción establecieron nuevos paradigmas de perfección e innovación, y el mantenimiento de sus componentes, a cargo de hombres y mujeres de gran talento, se realizaba bajo los estándares más estrictos de calidad de la época en todas las regiones donde tenía presencia la empresa. Y, lo que es más importante, los nuevos trenes acercaron nuevos horizontes para vivir el romanticismo y la intriga, dieron vida a nuevos sueños y abrieron las puertas a nuevos mundos.



E

UNA PUERTA A LA AVENTURA



- La capital del Imperio otomano se había convertido en el nuevo destino y fuente de inspiración preferido por artistas y escritores europeos que buscaban una puerta de entrada al misterio y el encanto del Lejano Oriente. Como el primero de los ferrocarriles transcontinentales europeos, el Orient Express superó todas las expectativas y se convirtió en sinónimo de viajes y aventura. El propio tren era un anuncio ambulante de la nueva compañía de Nagelmackers, cuyas espectaculares campañas publicitarias incluían coloridos pósters, tarjetas postales y recuerdos coleccionables llenos de imágenes de monumentos y símbolos otomanos o de modelos con ropa de inspiración egipcia o árabe, todo enmarcado en tonalidades y composiciones típicas de los paisajes desérticos. En su revista oficial, *Wagons-Lits Magazine*, la compañía promocionaba sus servicios y rutas, publicaba artículos de entretenimiento y también presentaba fotografías de celebridades disfrutando de los lujos ofrecidos a bordo, desde exquisitos vagones restaurante y coches cama hasta mozos de equipaje y revisores impecablemente vestidos, lo que contribuyó a perpetuar la percepción de glamur, mito y exclusividad del Orient Express.

S

SI ESOS VAGONES HABLARAN...



Tras el exitoso viaje inaugural del Orient Express en octubre de 1883, la CIWL añadió continuamente nuevas rutas a sus servicios durante las décadas siguientes y hasta bien entrado el siglo XX. Como había previsto Nagelmackers, la gente se sentía atraída por la calidad, el lujo y la promesa de aventura. Pero el verdadero momento decisivo para el Orient Express tuvo lugar en 1934. La publicación

de la famosa novela de Agatha Christie *Asesinato en el Orient Express* puso el tren bajo los focos con su glamur, emoción y misterio, y lo propulsó a la escena mundial como fenómeno cultural del siglo XX. Había nacido una leyenda moderna. Incluso cuatro décadas después, la primera adaptación cinematográfica seguía cautivando la imaginación de nuevos públicos.

N

EL ORIENT EXPRESS EN TIEMPOS DE CAMBIO

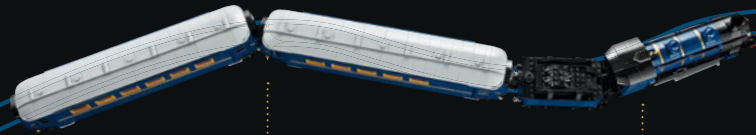

1867

Durante un viaje a los Estados Unidos, Georges Nagelmackers descubre los modernos vagones restaurante y coches cama, y ve su potencial para redefinir la forma de viajar.

1883

El 4 de octubre, el Orient Express emprende su viaje inaugural: un recorrido de ida y vuelta de París a Constantinopla con regreso el 16 de octubre. Se invita a dos docenas de pasajeros a este *viaje de prensa* a las orillas del mar Negro, donde la última parte del recorrido se completa en un barco de vapor.

1889

El Orient Express conecta París con Constantinopla a través de Budapest, Belgrado y Sofía en un viaje de 67 horas y 46 minutos.

1918

La leyenda dice que el Armisticio de 1918 se firmó a bordo del Orient Express. En realidad, se firmó en un vagón perteneciente a otro de los trenes de la compañía: el vagón restaurante n.º 2419, en el claro de Rethondes (en los límites del bosque de Compiègne [Francia]).

1919

Inauguración del tren Simplon-Orient Express de Londres y París a Constantinopla vía Italia. Una iniciativa de colaboración entre naciones aliadas, la ruta refleja la nueva situación geopolítica de Europa después de la Primera Guerra Mundial.



Viaja atrás en el tiempo y revive momentos icónicos de la historia del Orient Express.

1922

Hay que reparar o sustituir un gran número de vagones destruidos o confiscados durante la Primera Guerra Mundial. Cuando es posible, los componentes de acero se reemplazan por piezas hechas de madera de teca, y los vagones se modernizan con el distintivo color azul medianoche.

1929

Durante días, una tormenta de nieve atrapa al Orient Express en la ciudad turca de Cherkeskoy. Este suceso inspira el clásico de Agatha Christie *Asesinato en el Orient Express* (publicado en 1934).

1934

La publicación de la exitosa novela de Agatha Christie *Asesinato en el Orient Express*, protagonizada por el detective belga de ficción Hércules Poirot, dispara la fama del tren y lo convierte en icono cultural.

1946

Tras la interrupción del servicio en toda Europa durante la Segunda Guerra Mundial, se restablecen finalmente los viajes a Estambul.

1974

Se estrena en todo el mundo la primera película basada en *Asesinato en el Orient Express*, de Agatha Christie, que se convertiría en un clásico moderno.

1977

Ante la feroz competencia de los modernos viajes de lujo por aire, el Orient Express realiza su último viaje a Estambul el 20 de mayo.



CONOCE A LOS DISEÑADORES DE LEGO®

- “La propuesta original de Thomas era muy precisa y detallada: su pasión por la era del vapor es más que evidente. Hicimos todos los esfuerzos posibles para recrear la experiencia original de un viaje de lujo de primera clase en la versión final del modelo LEGO®. Partimos de que teníamos un vagón restaurante y un coche cama y, después de una exhaustiva investigación y consulta con expertos, logramos reproducir en formato LEGO detalles como los paneles de madera y los espejos de cristal tallado originales. Espero que los aficionados a los trenes LEGO descubran las múltiples piezas creadas o adaptadas especialmente para este set; algunas de mis favoritas son un elemento de viga totalmente nuevo hecho para las bielas de acoplamiento de la locomotora, bolígrafos utilizados como silbatos y un cubo reimaginado como parte de la chimenea. El modelo también es más grande que los trenes LEGO tradicionales, lo que se traduce en espacio adicional en el interior para albergar detalles y, por supuesto, ¡para jugar!”

—Ollie Gregory, modelista sénior de LEGO® Ideas

W



“¡Trabajar con el modelo de Thomas resultó ser una fantástica experiencia llena de nostalgia! Me gustaron mucho los paneles de madera, los cristales, el espejo convexo, el espejo con las aves y todos los detalles inspirados en el original. Queríamos que los adornos dieran vida al interior y le añadieran un poco del ADN de LEGO®. Todas las aves, flores y hojas son elementos LEGO, pero aun así fue bastante complicado encontrar el ajuste y la combinación de colores y detalles adecuados, y probamos muchos diseños y estampados, logotipos y fuentes de texto para lograrlo. Otra parte

que siempre es divertida, si bien también representa un desafío, es el diseño de nuevas minifiguras. El Orient Express es un icono de la cultura popular, así que tenemos un intrigante elenco de personajes que puedes utilizar para crear tus propias historias, incluidos una nueva camarera y una periodista, además de un revisor, un bombero, un conserje, un mozo de equipaje, una distinguida duquesa, un científico y más. ¡Espero que el set despierte la imaginación de todos!”.

*-Kjeld Walther Sørensen,
diseñador gráfico de LEGO® Ideas*

S

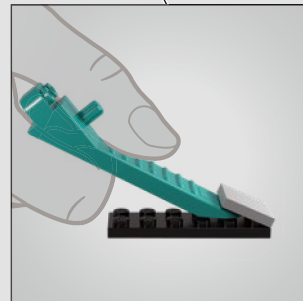
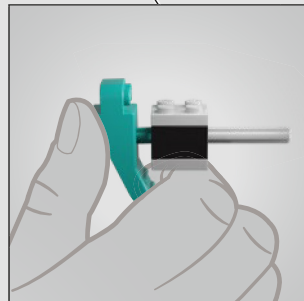
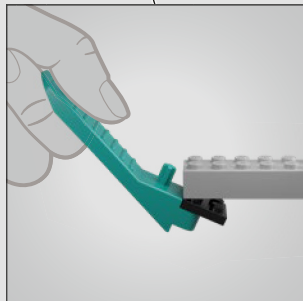
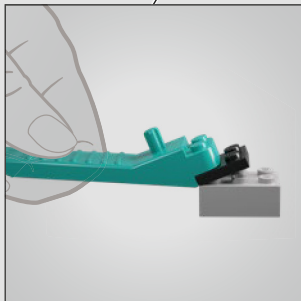
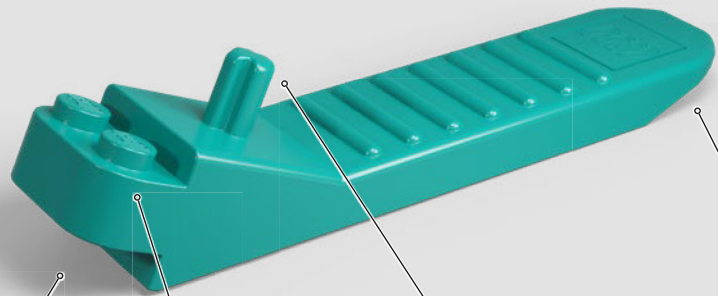

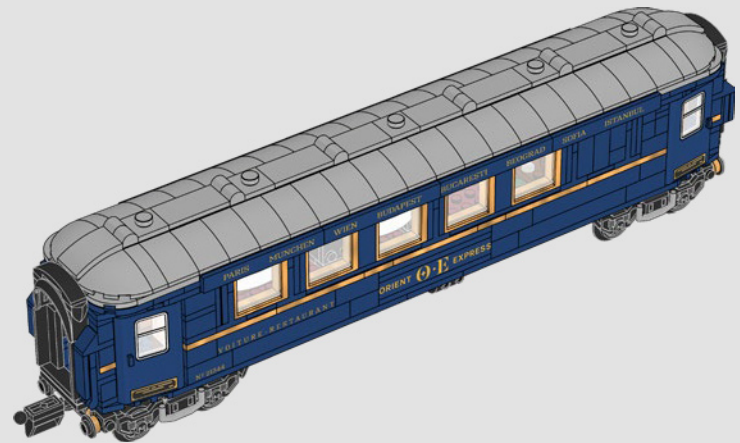
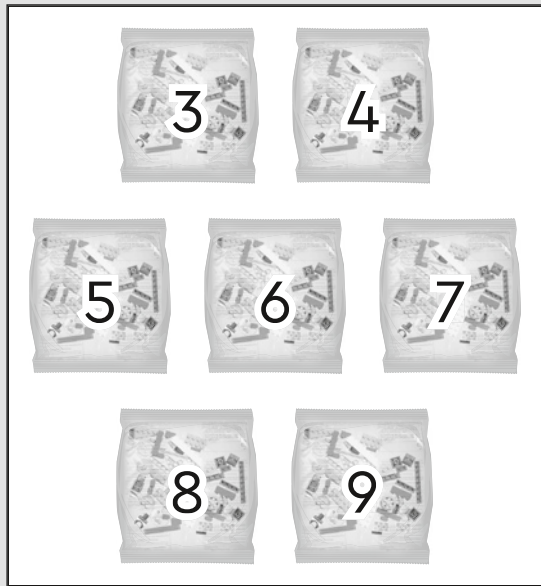
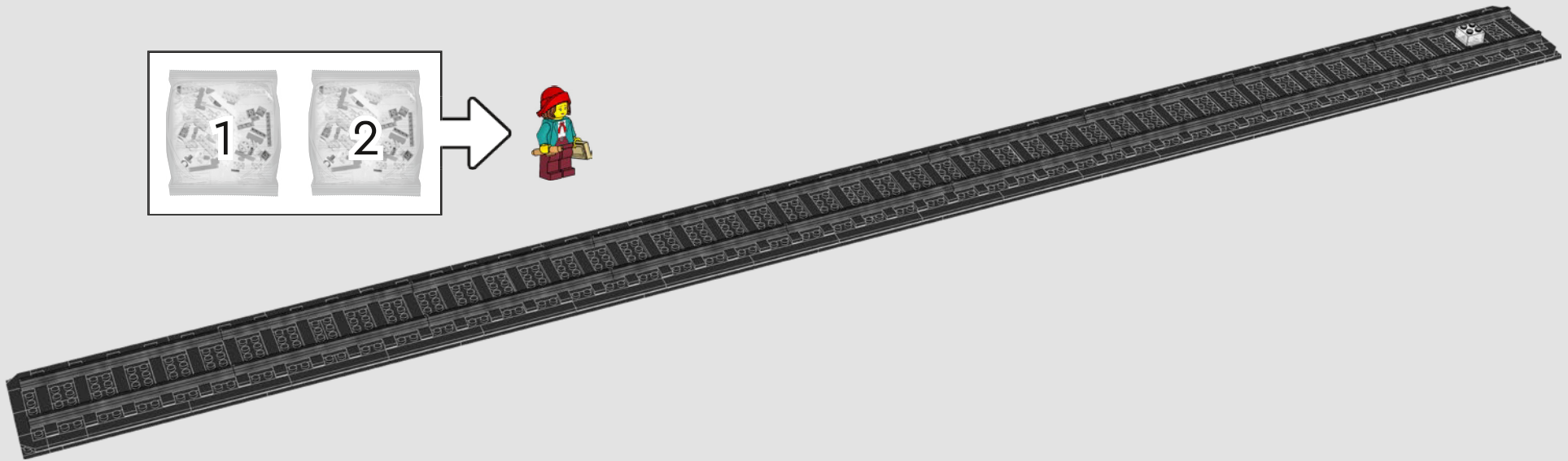
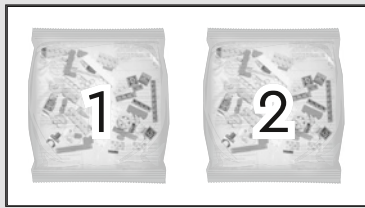

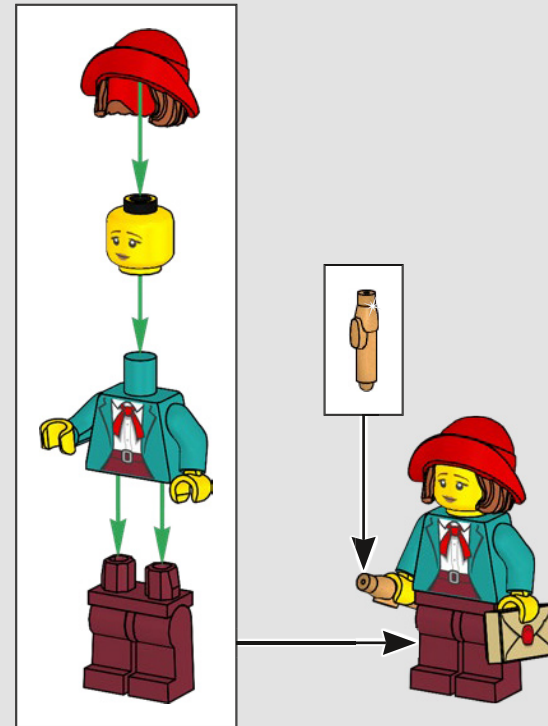
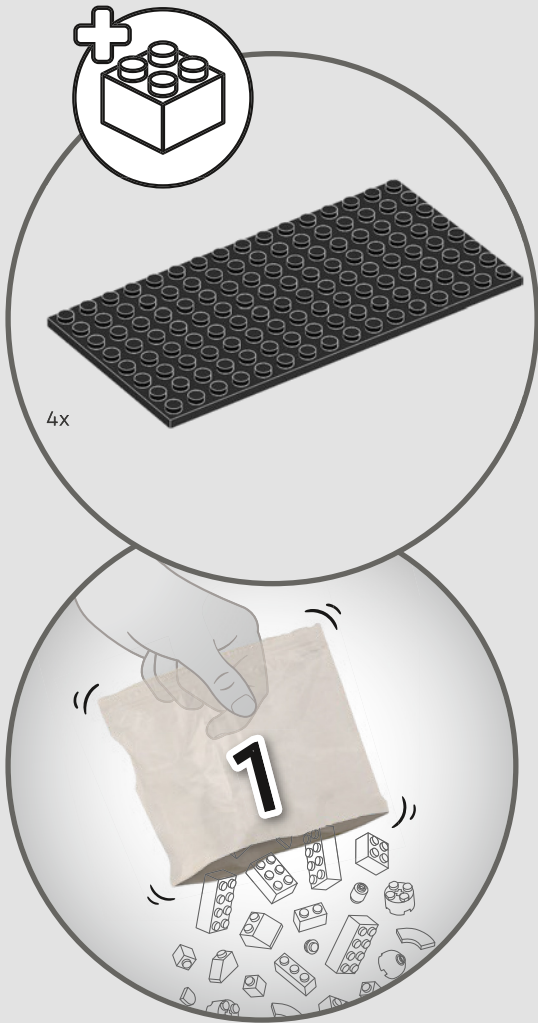

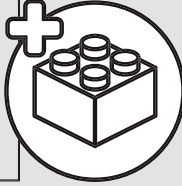
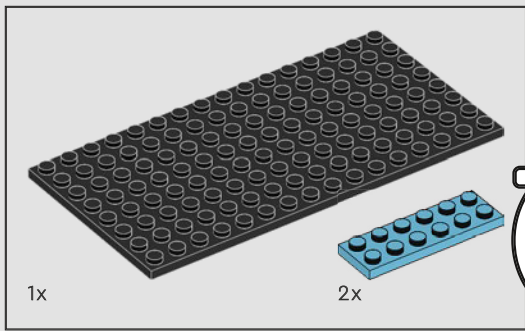

1

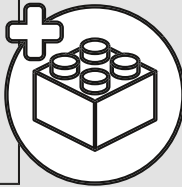
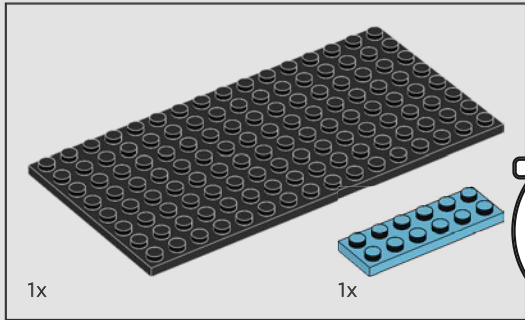
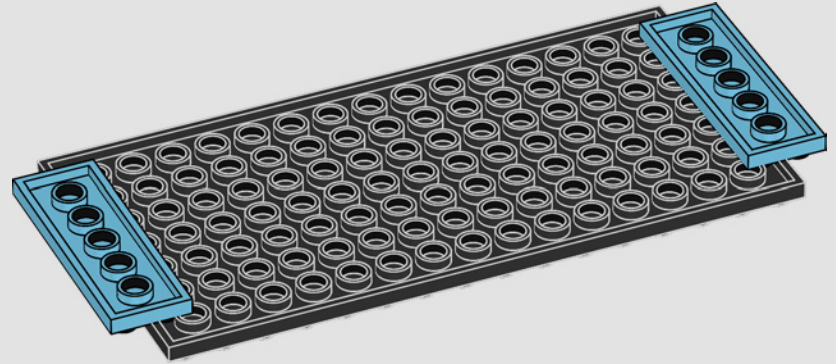

2

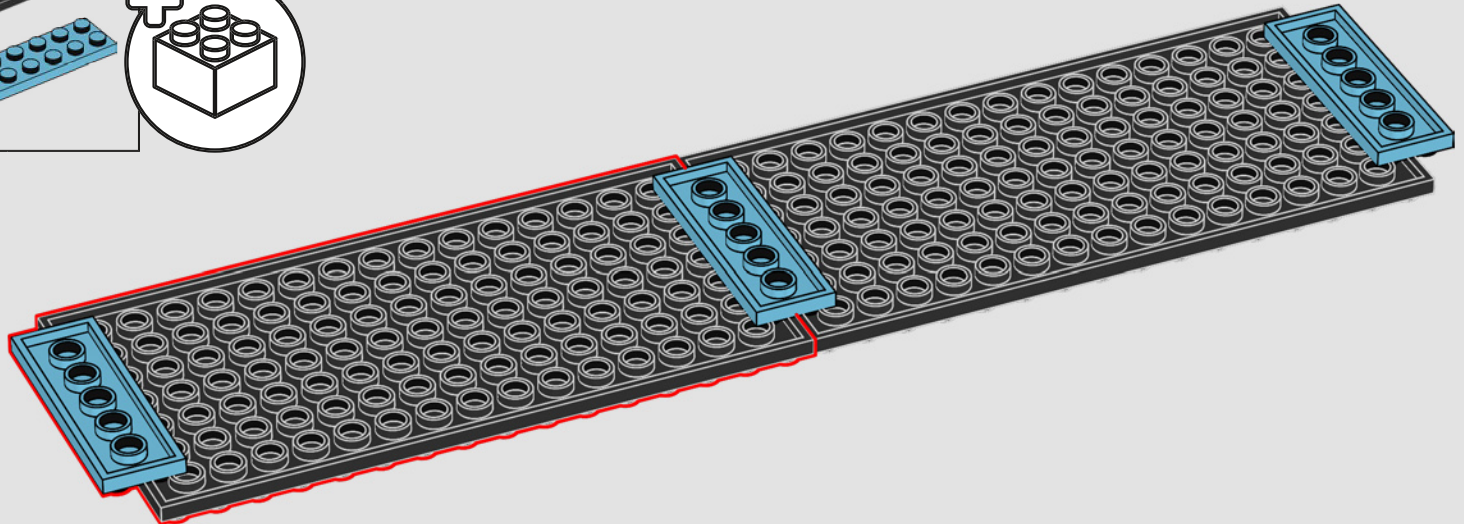

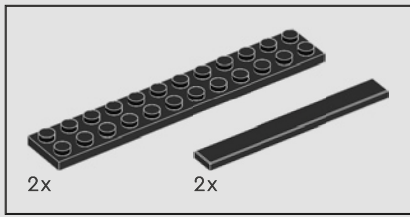

3

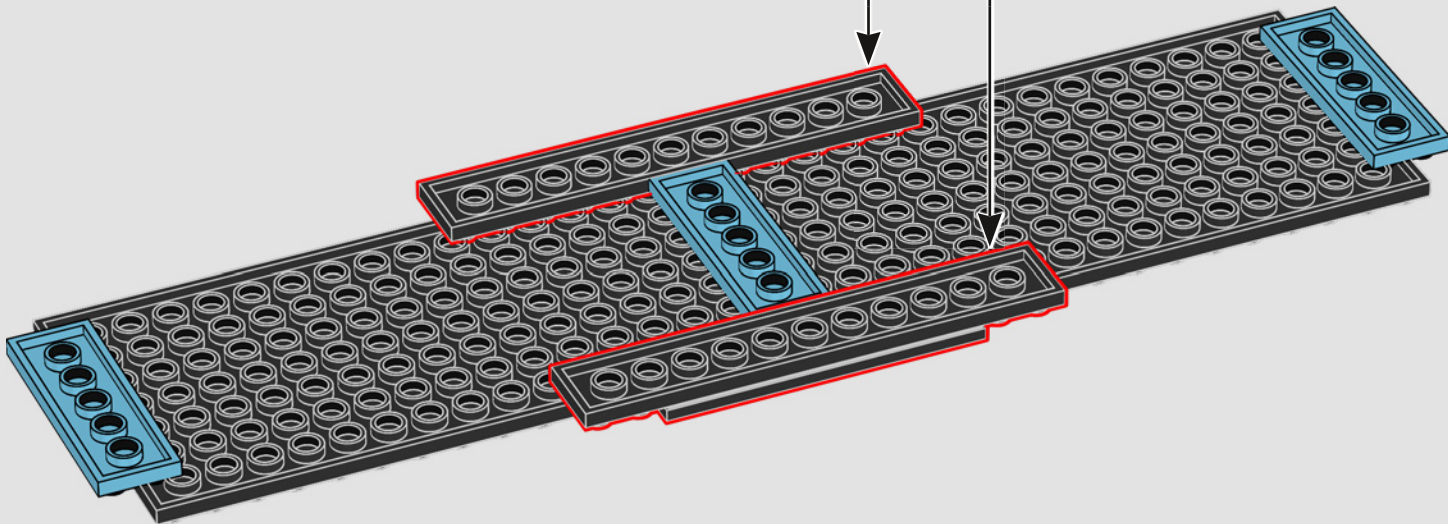
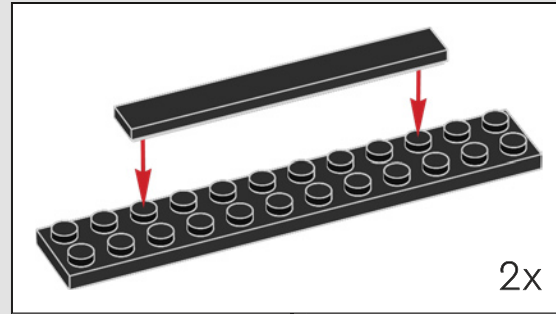

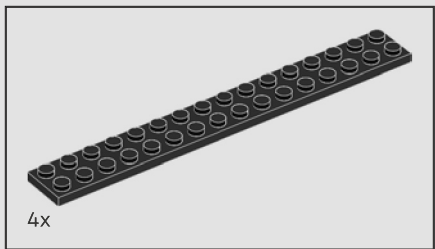

4

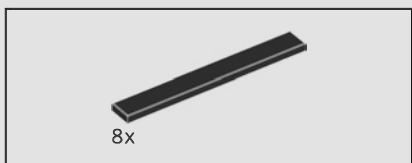
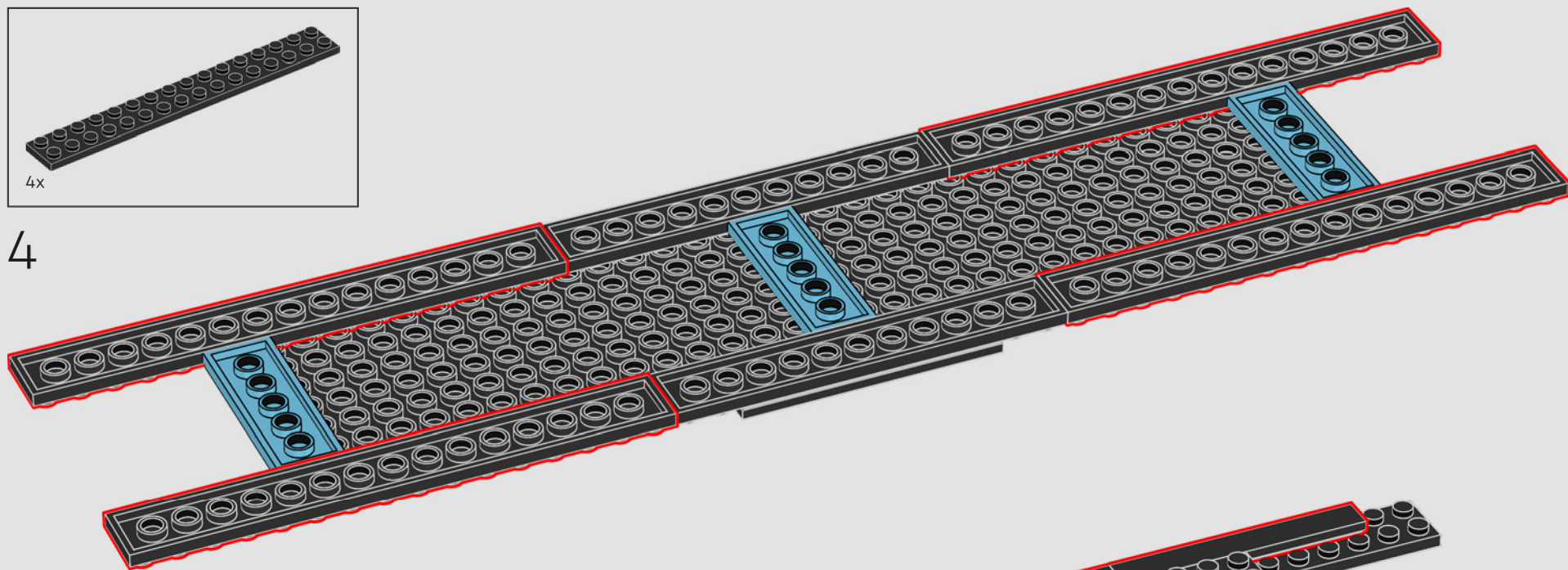

5

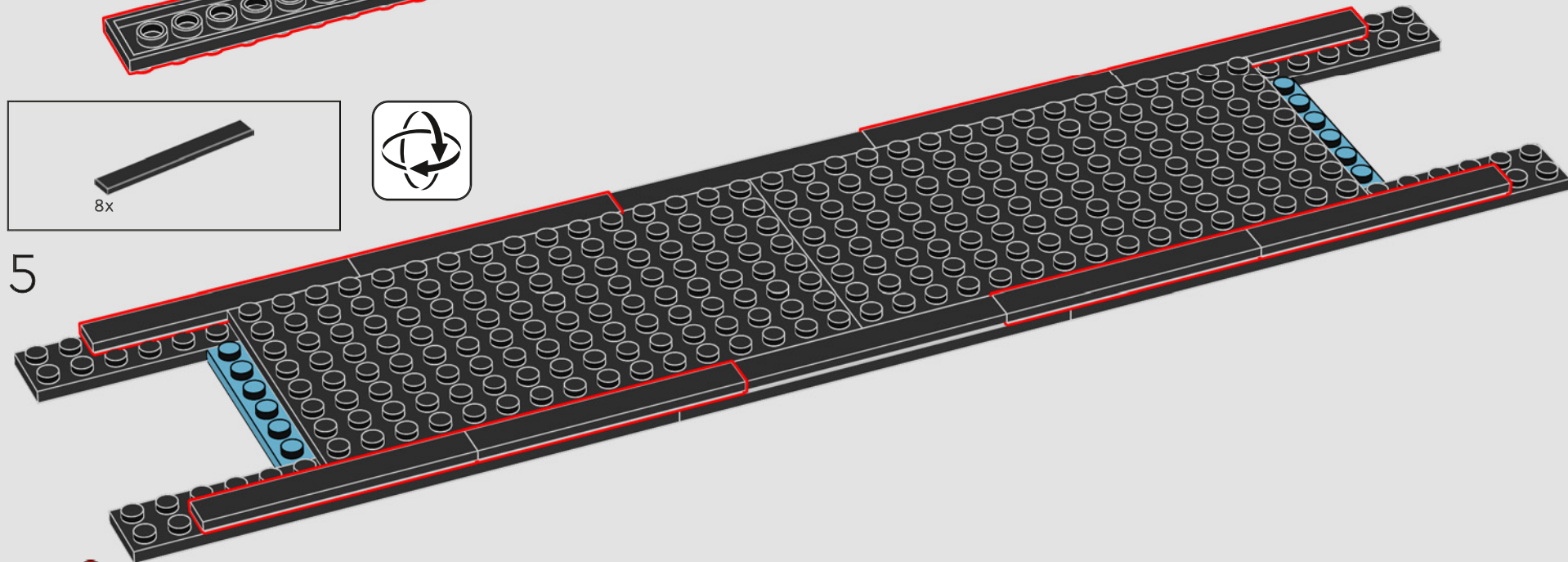

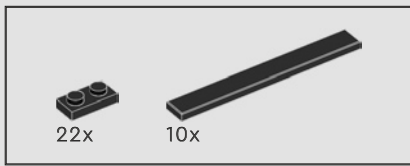

6

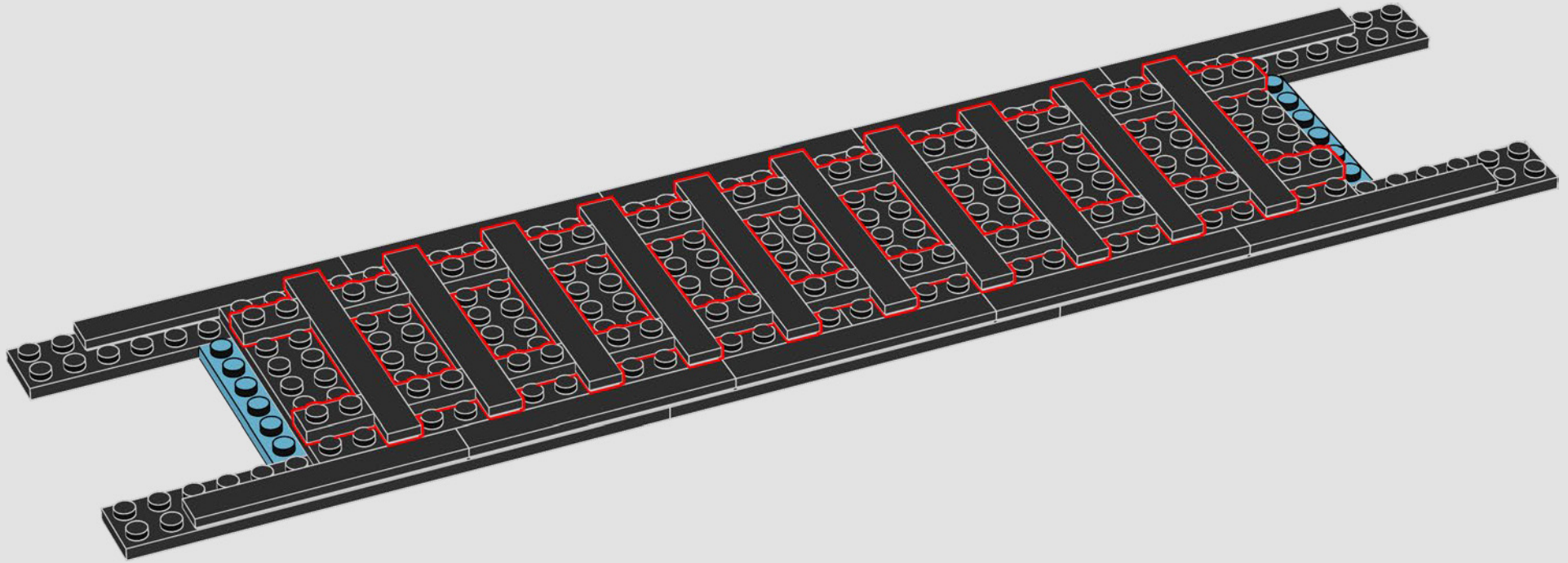

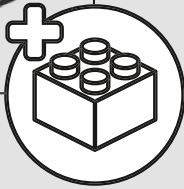
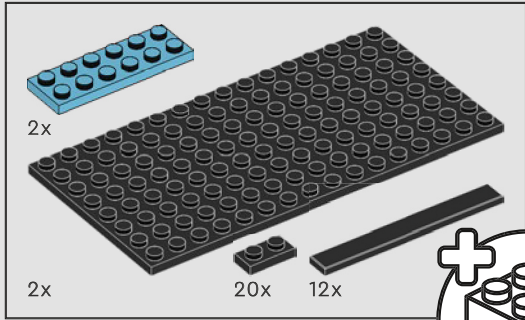
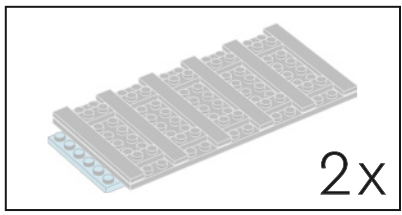

7

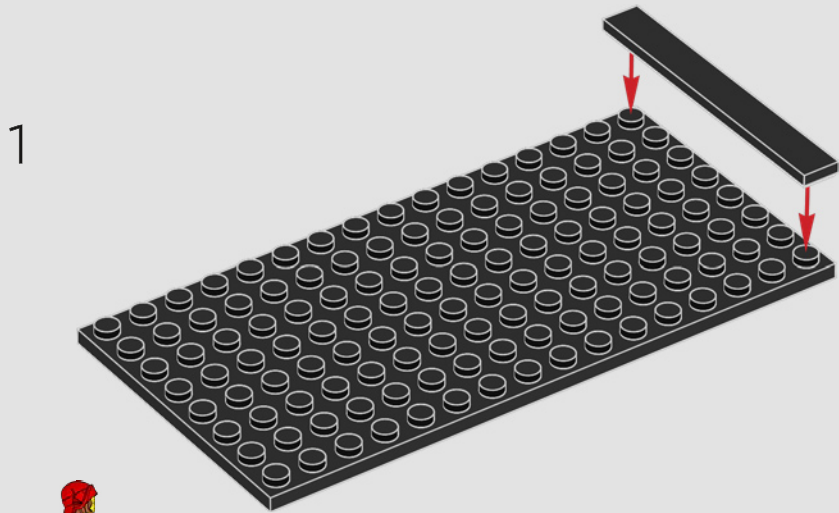

2

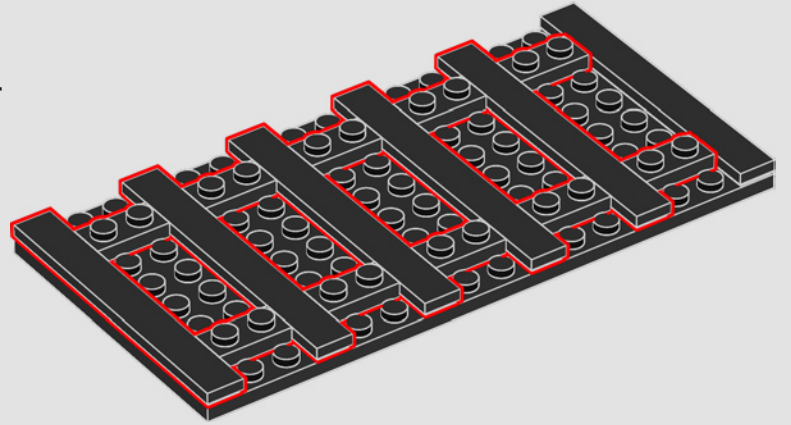

3

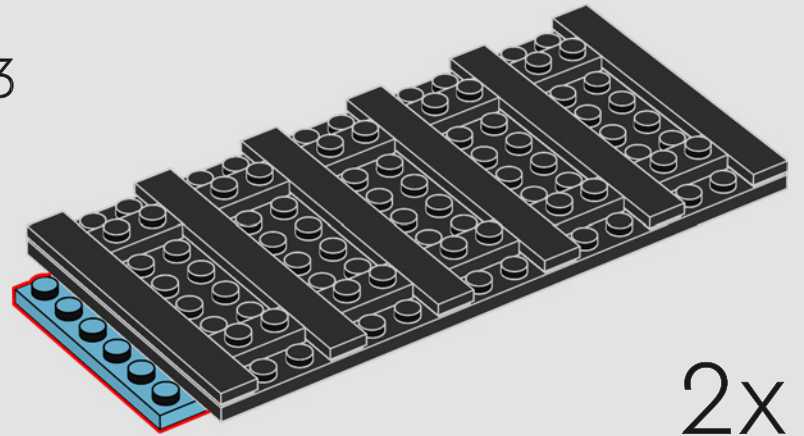

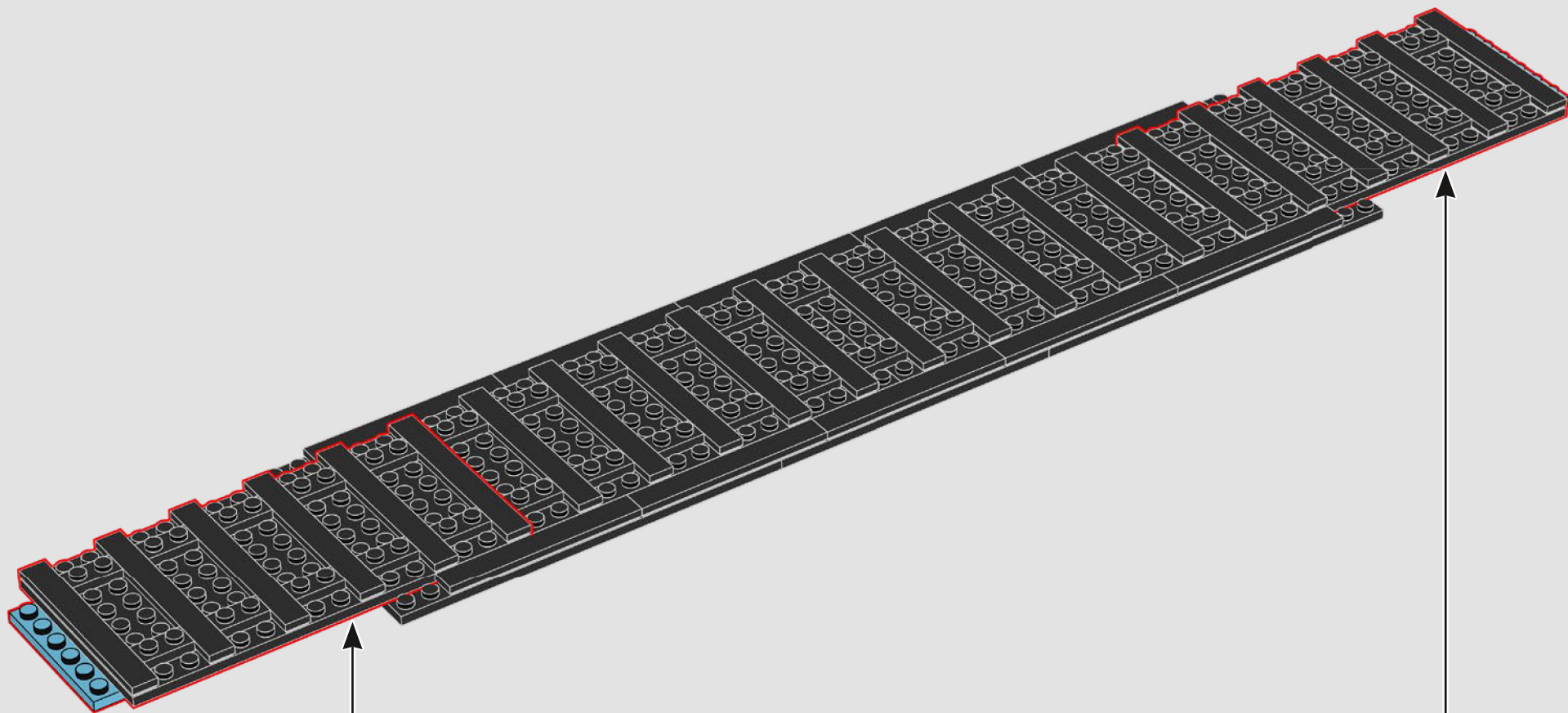

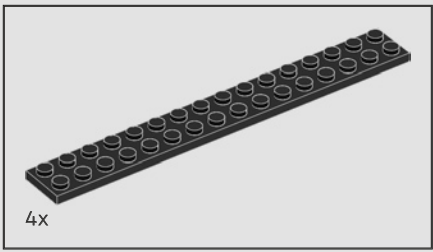

8

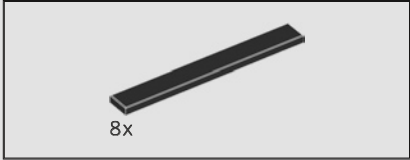
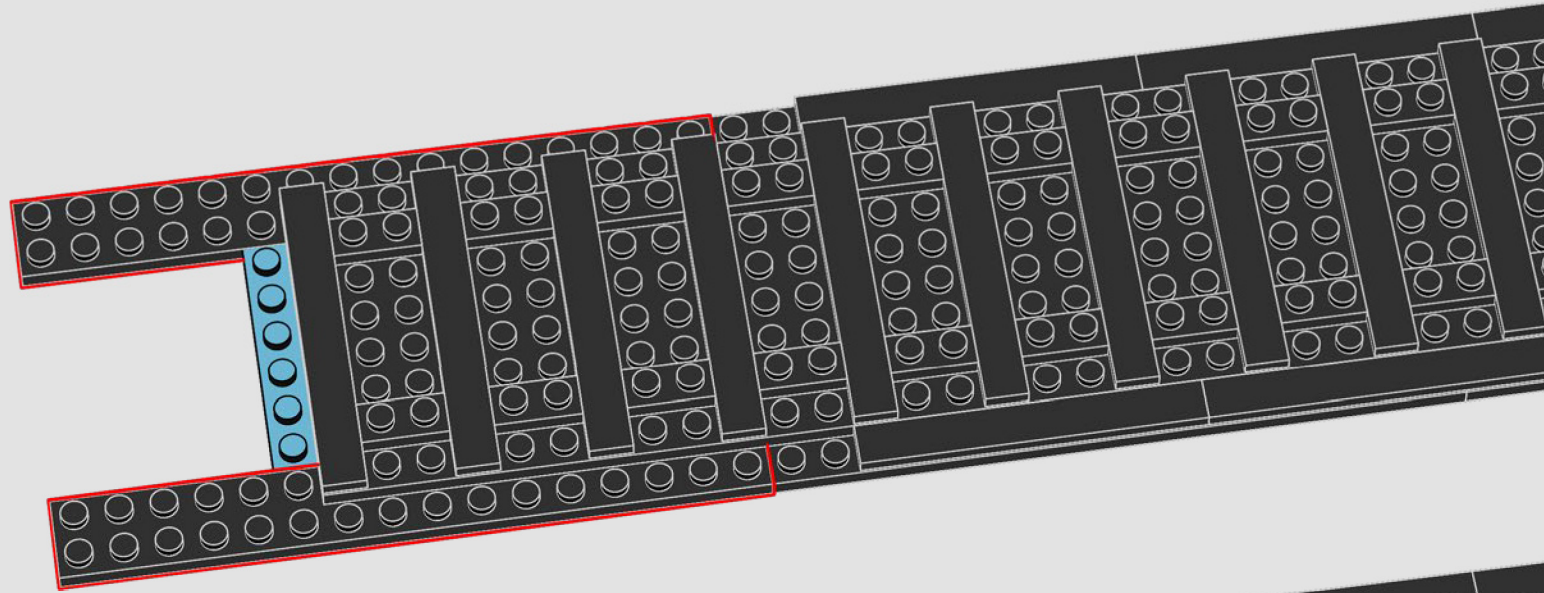

9

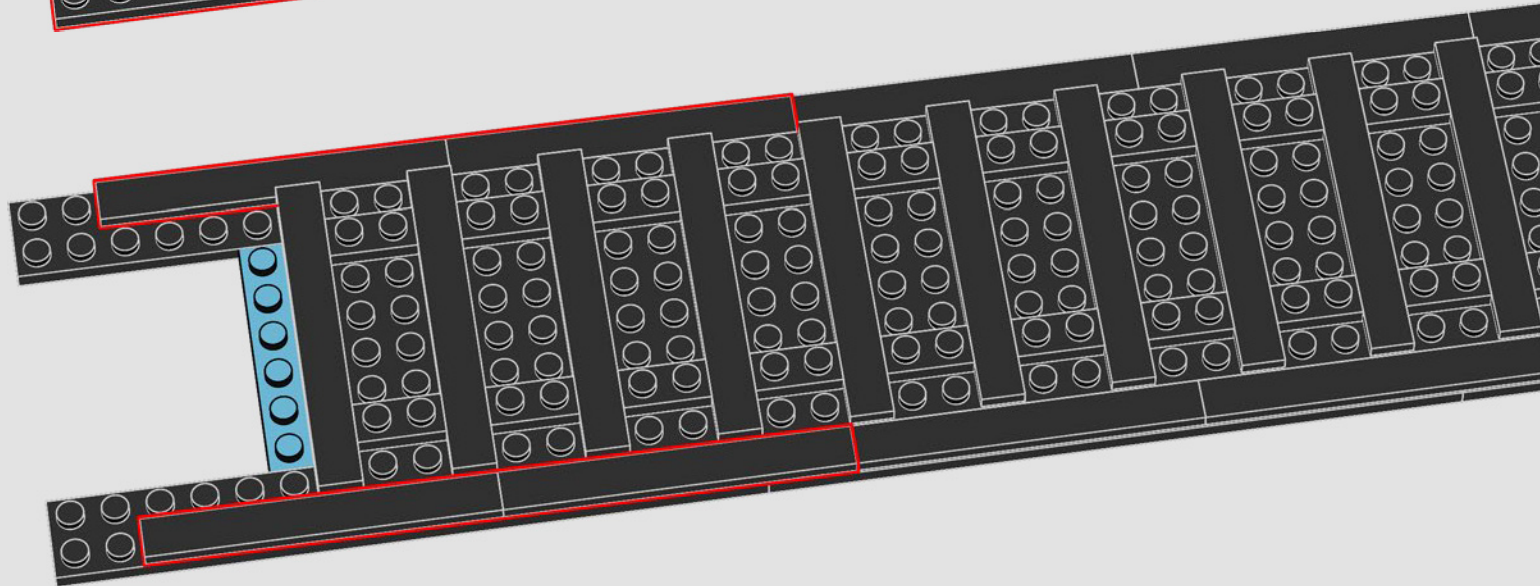

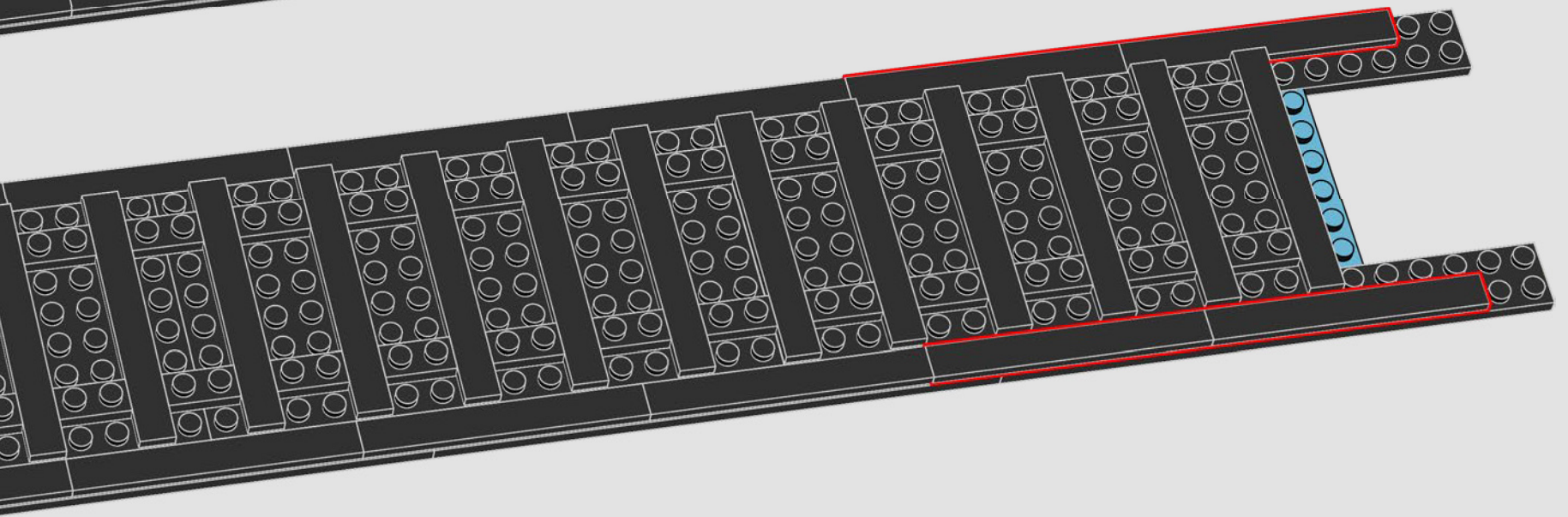
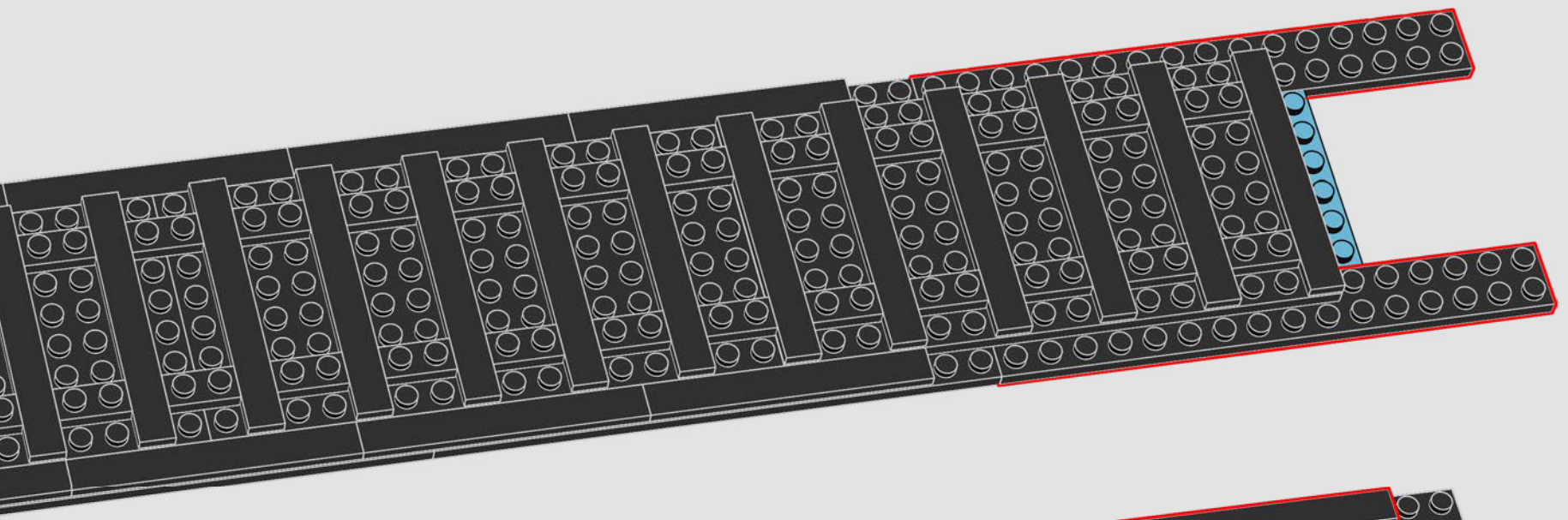

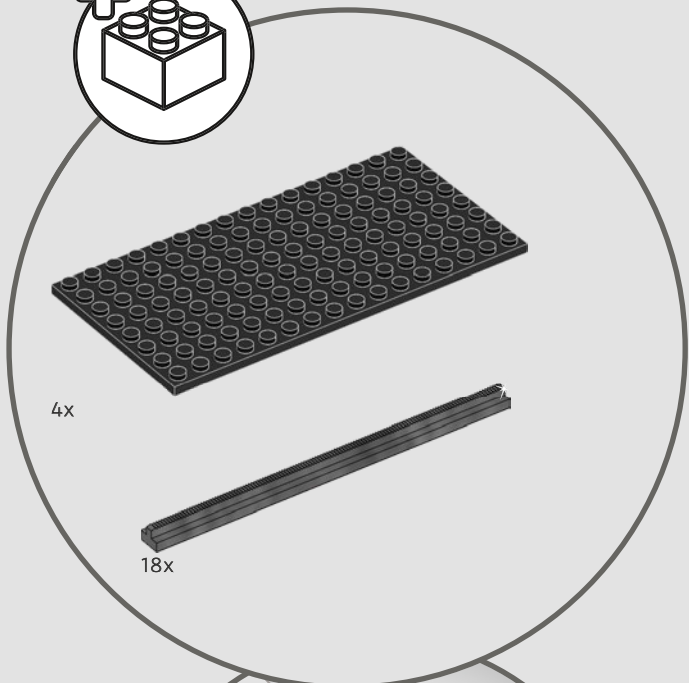
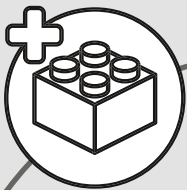

4x

18x



2

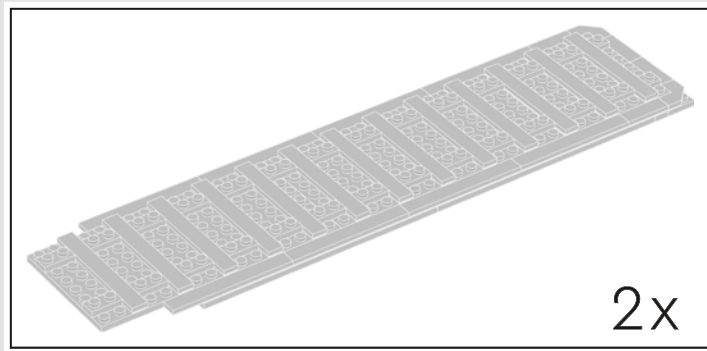

2x



1x

1x

10

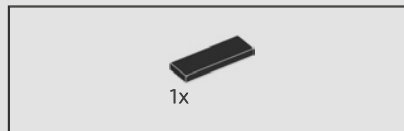
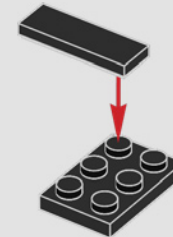

1x

11

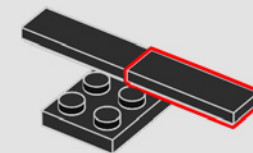

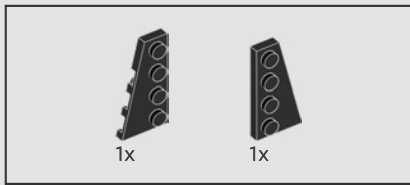

12

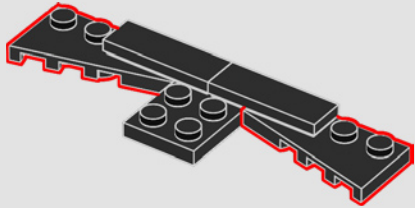

13

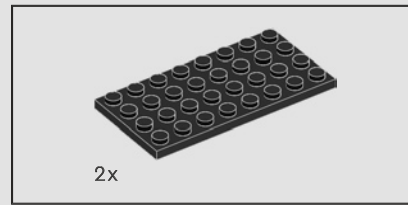
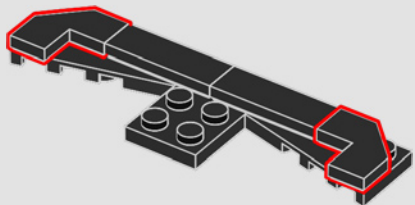

14

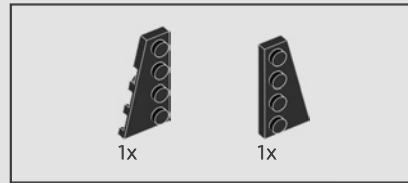
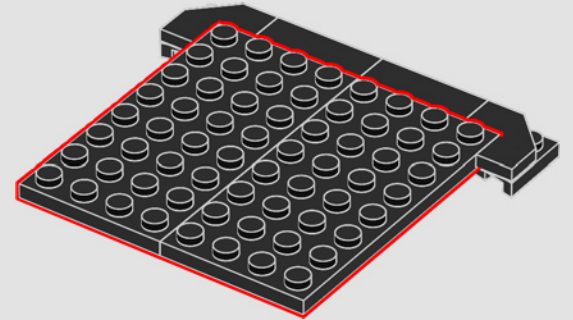

15

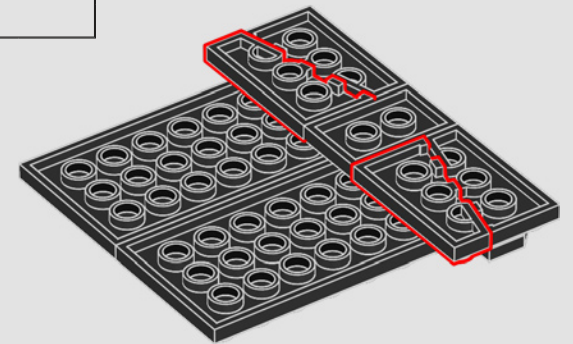

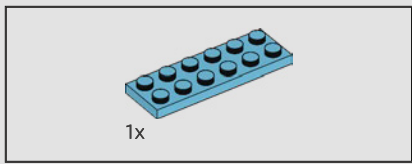

16

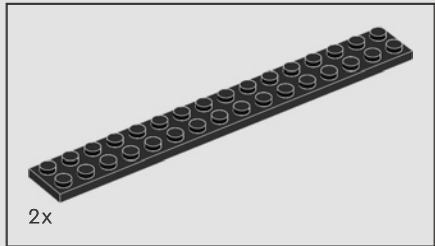
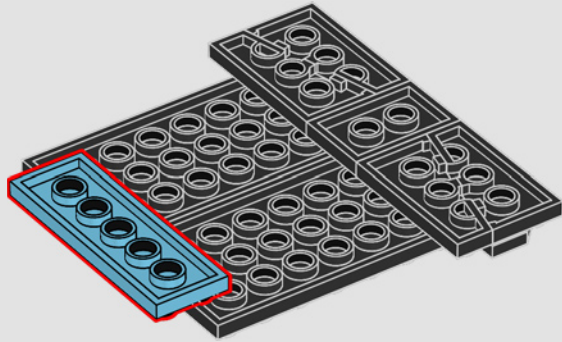

17

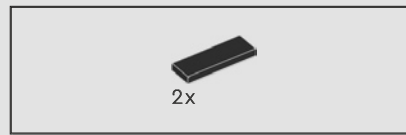
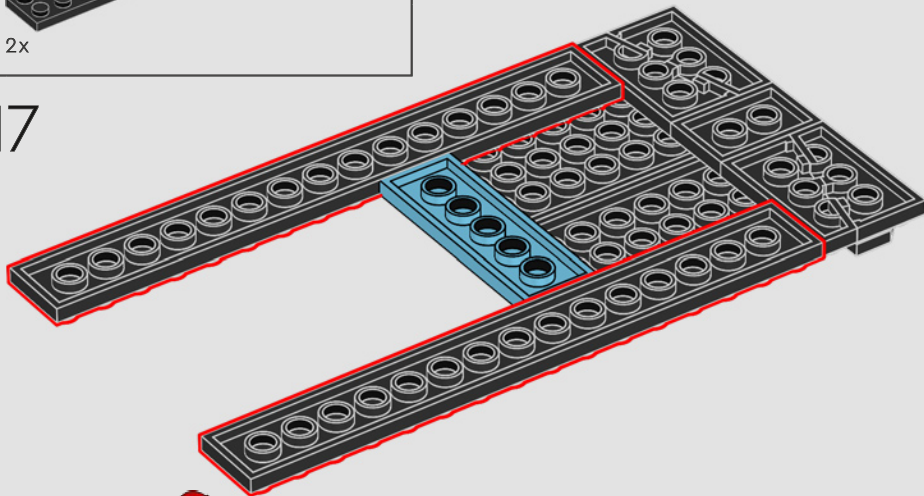

18

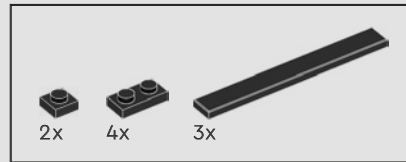
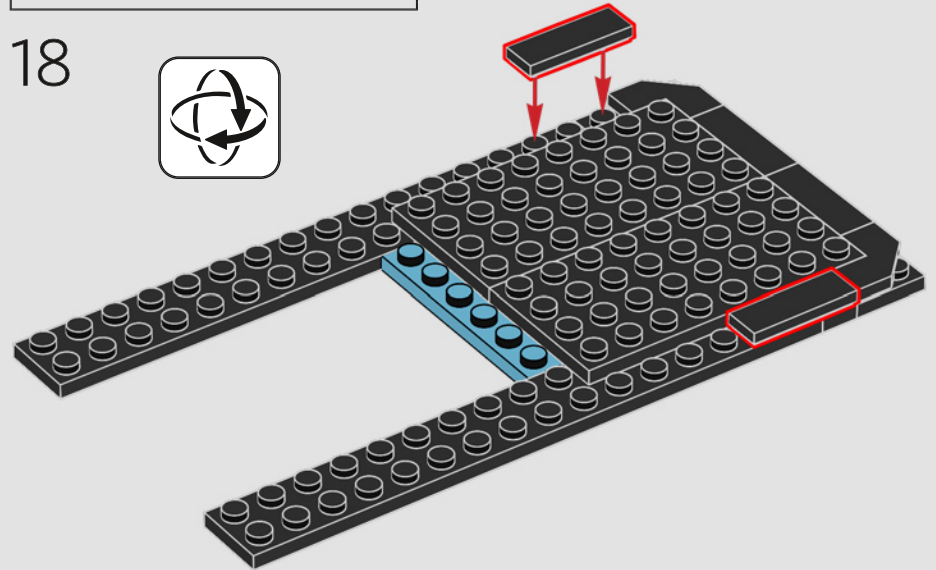

19

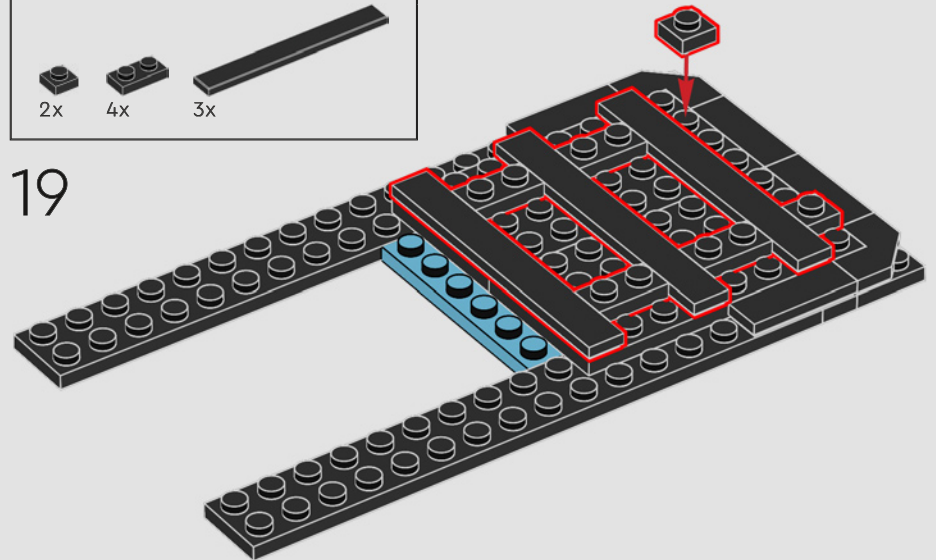

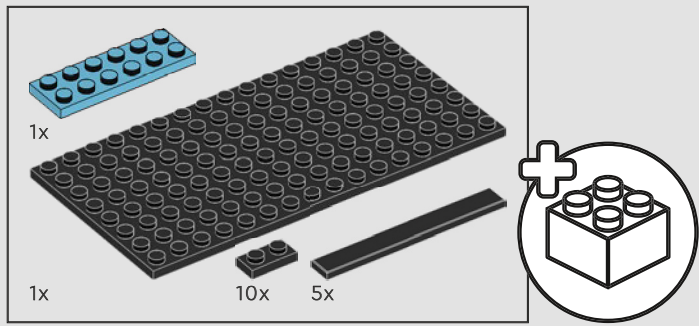

20

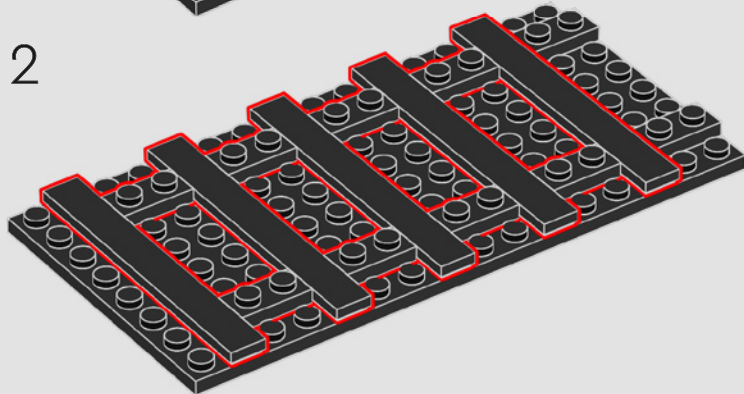
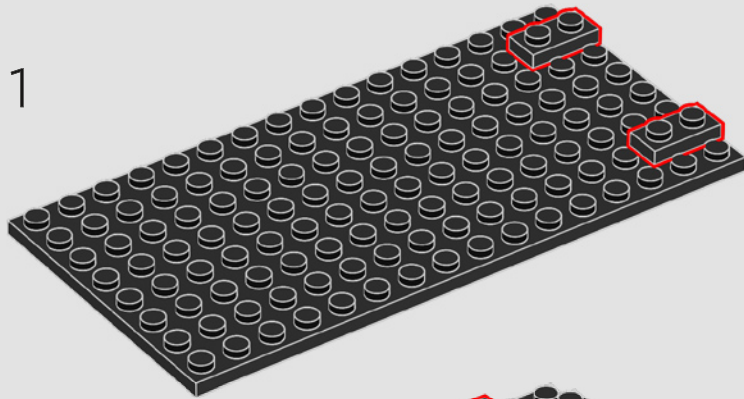

3

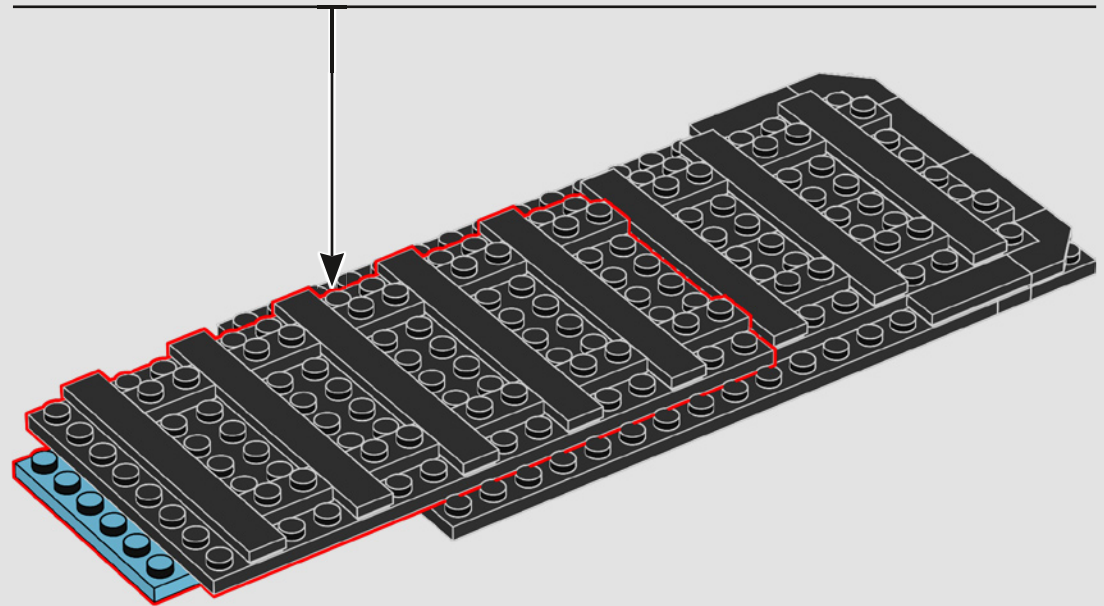
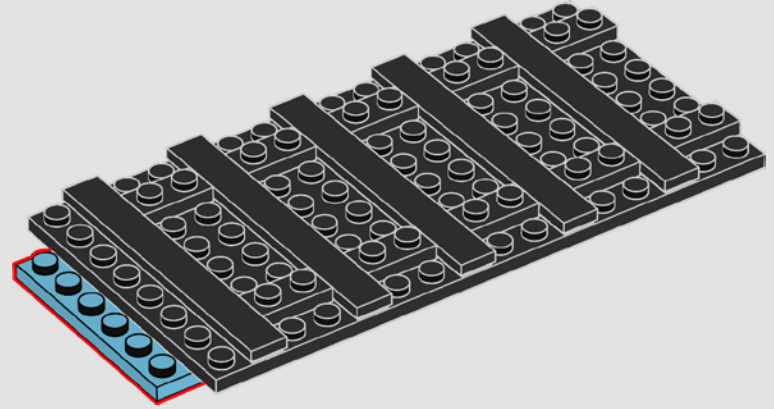

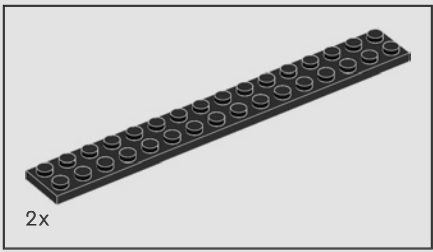

21

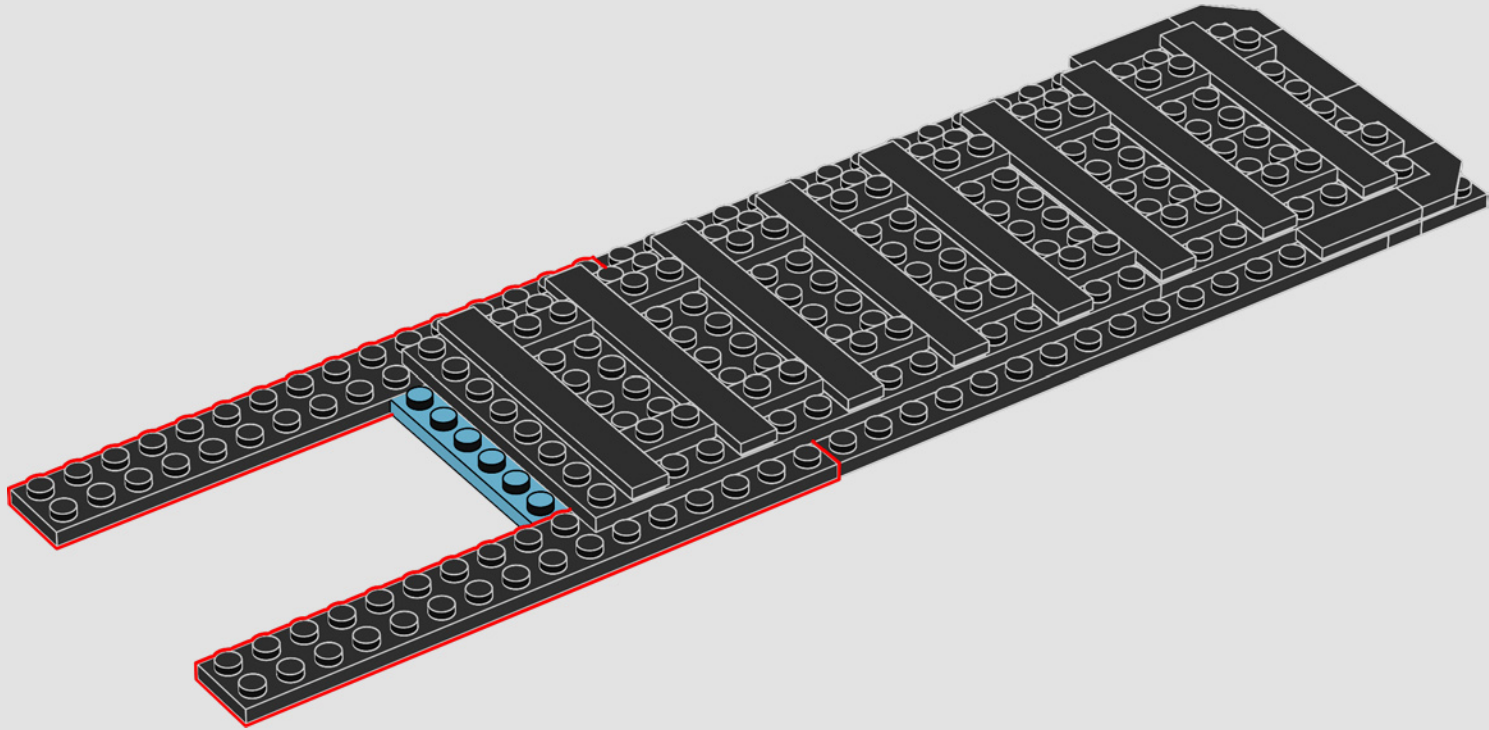

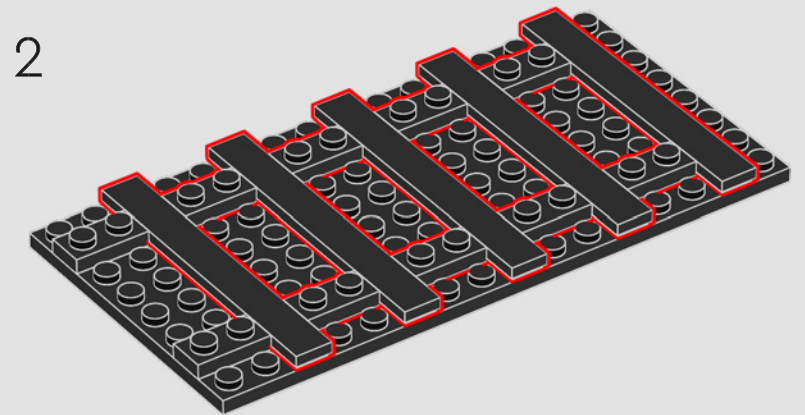
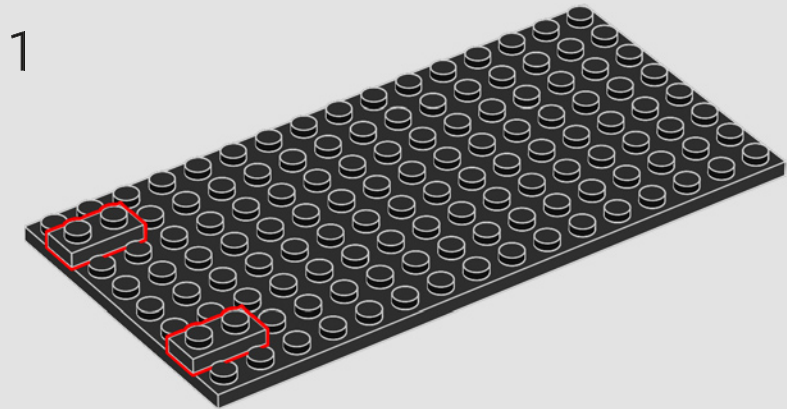
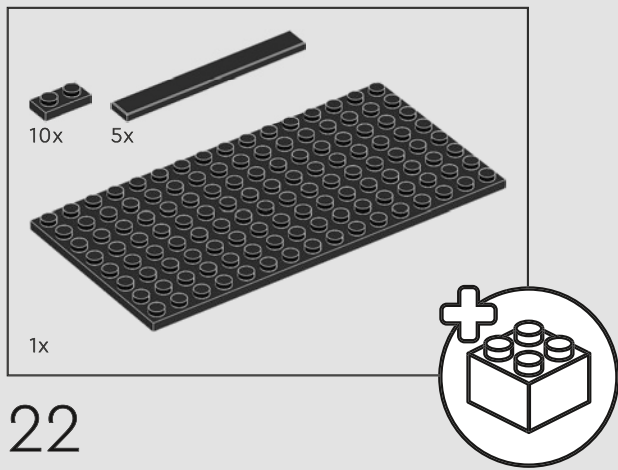

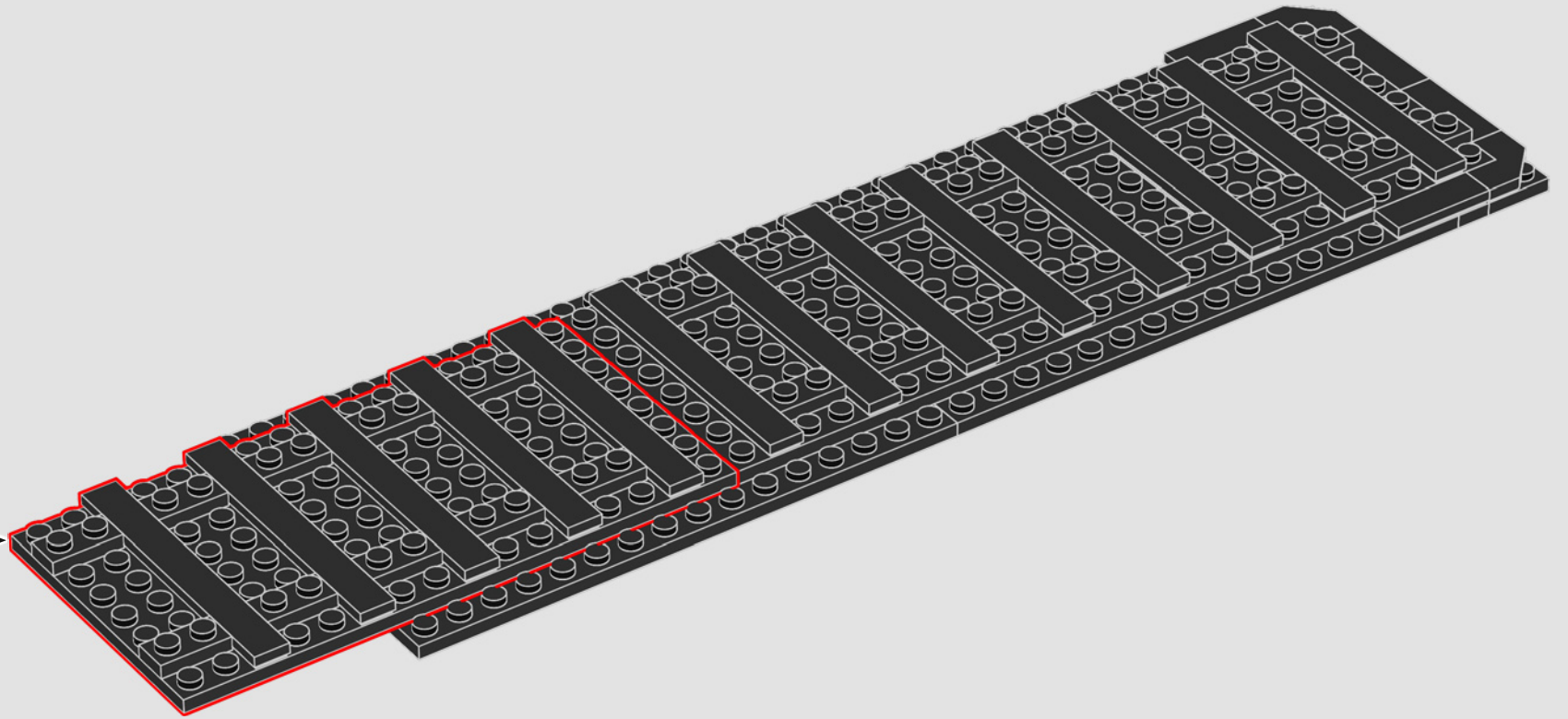



23

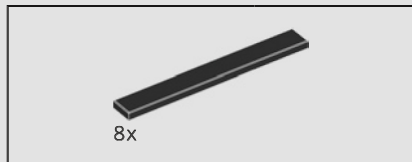
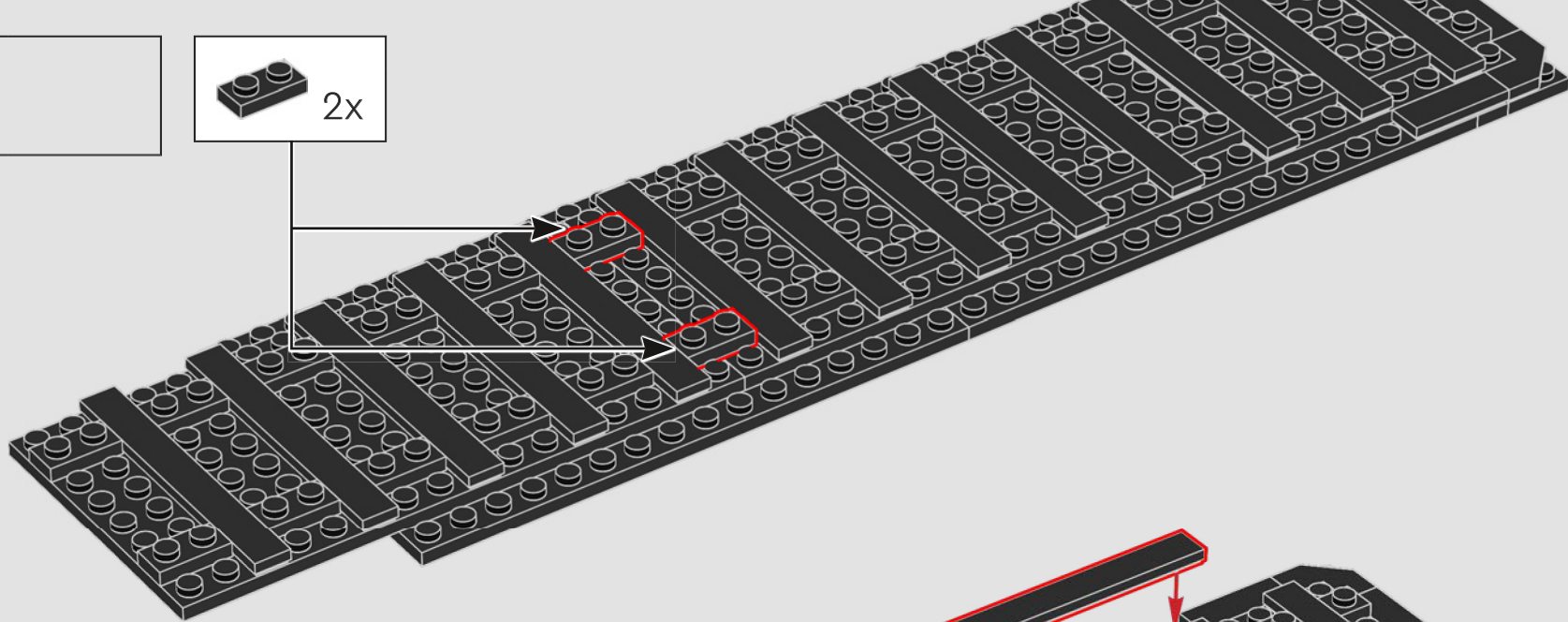

24

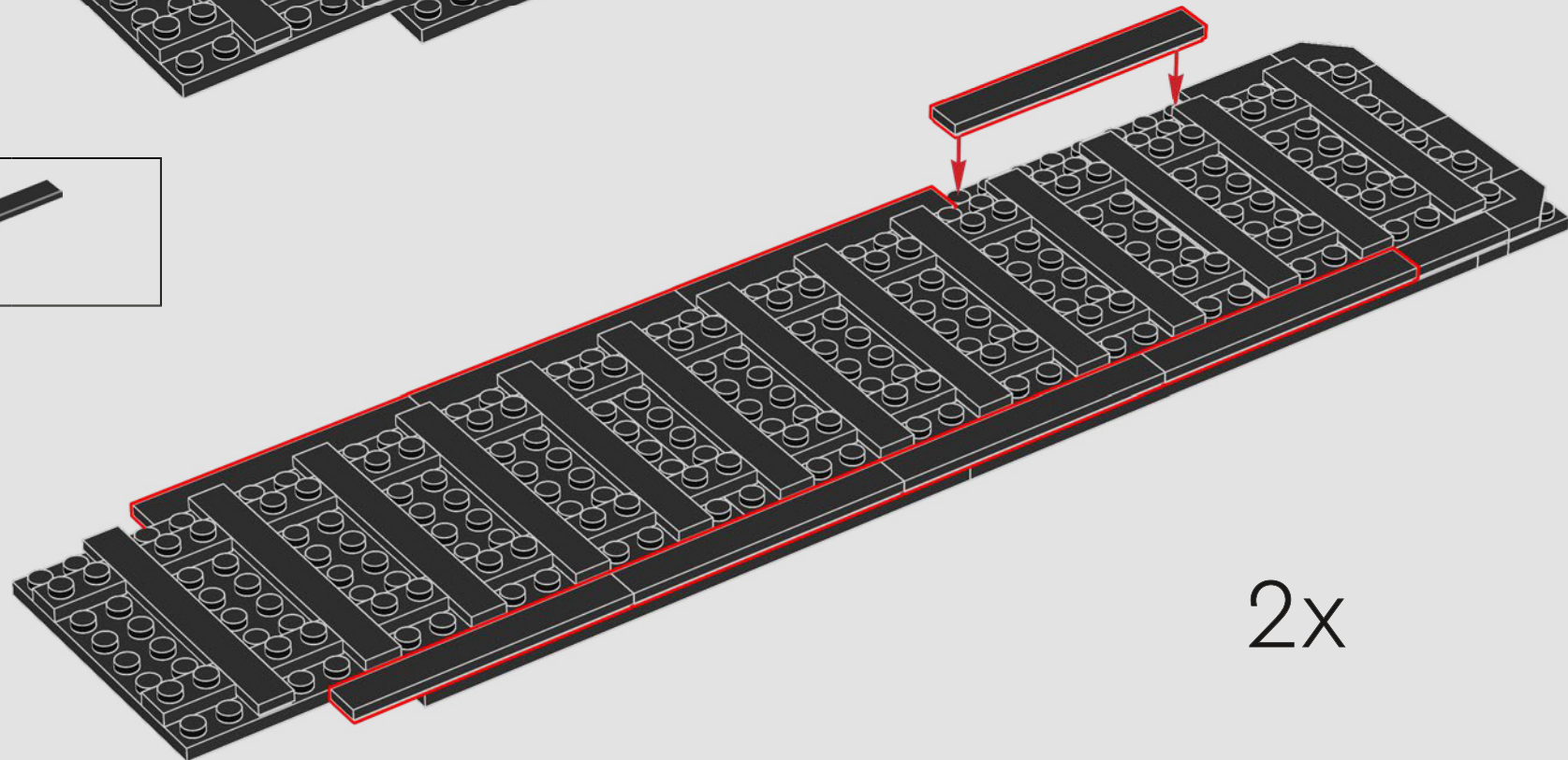

2x



2x

25

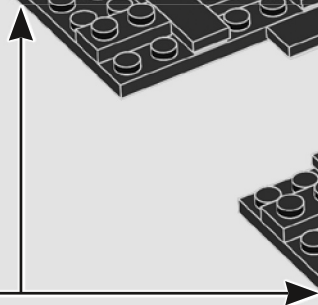
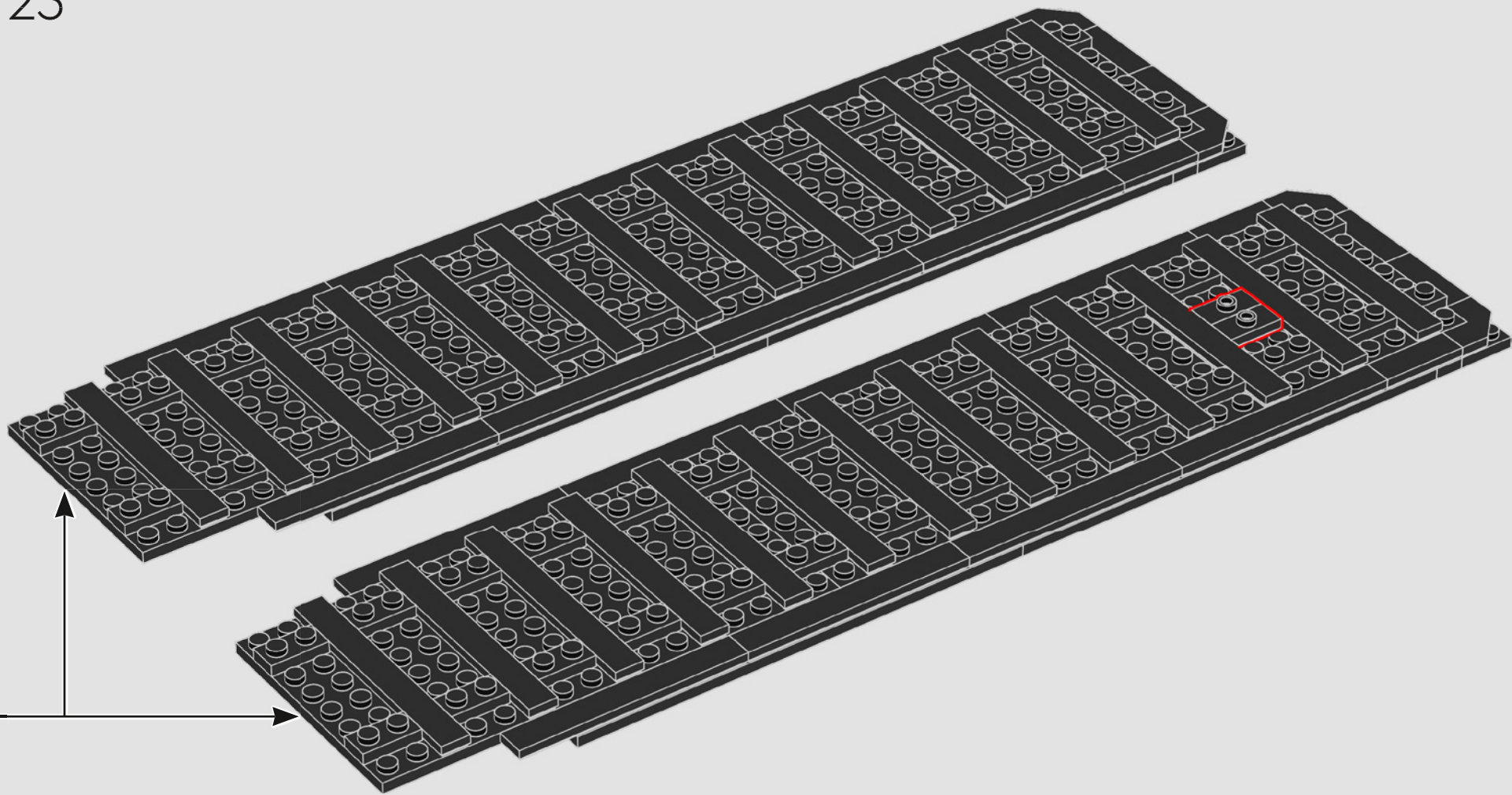

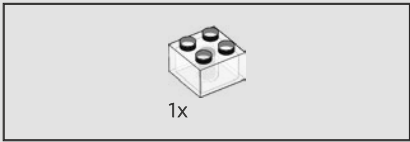

26

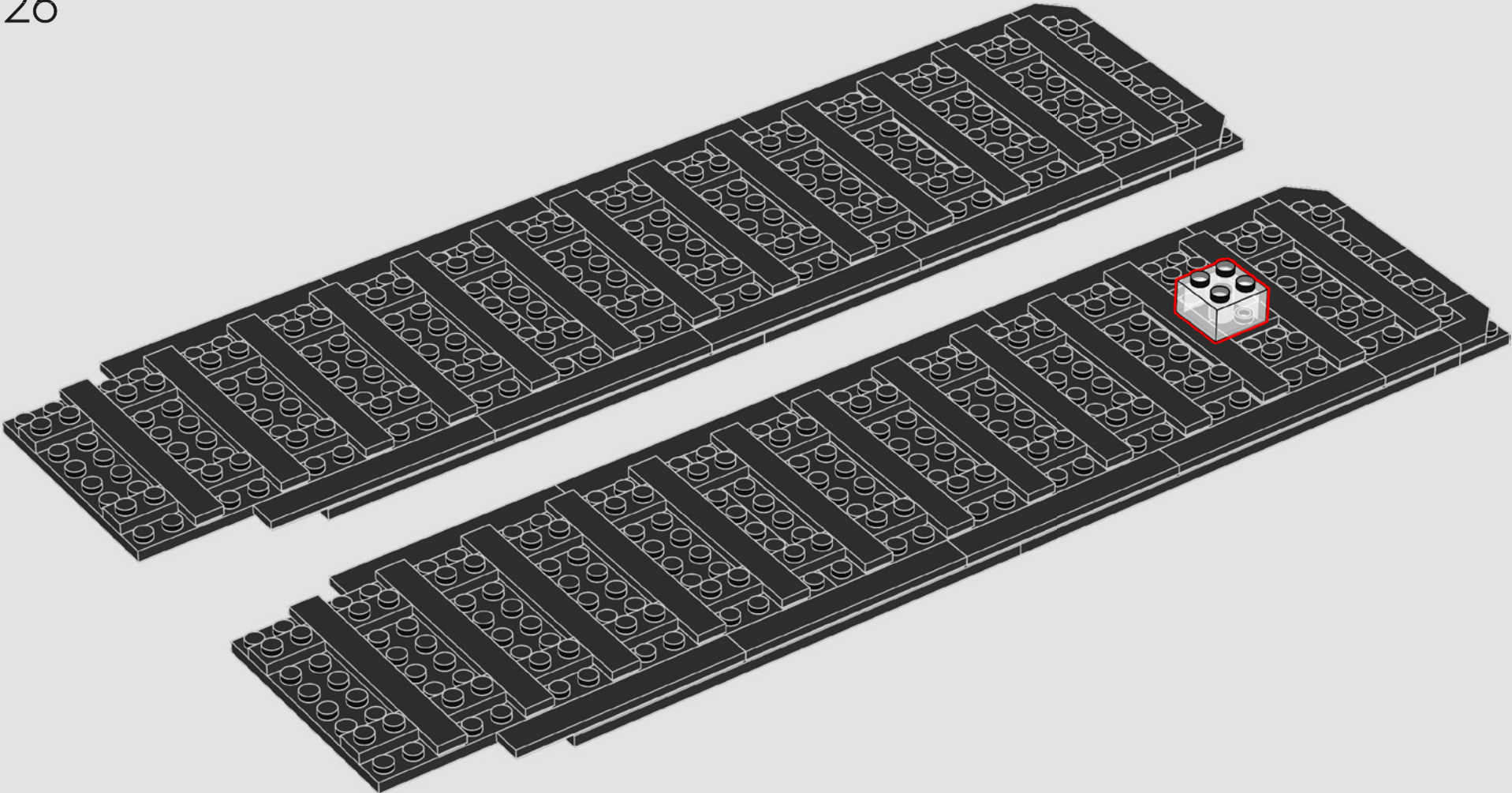

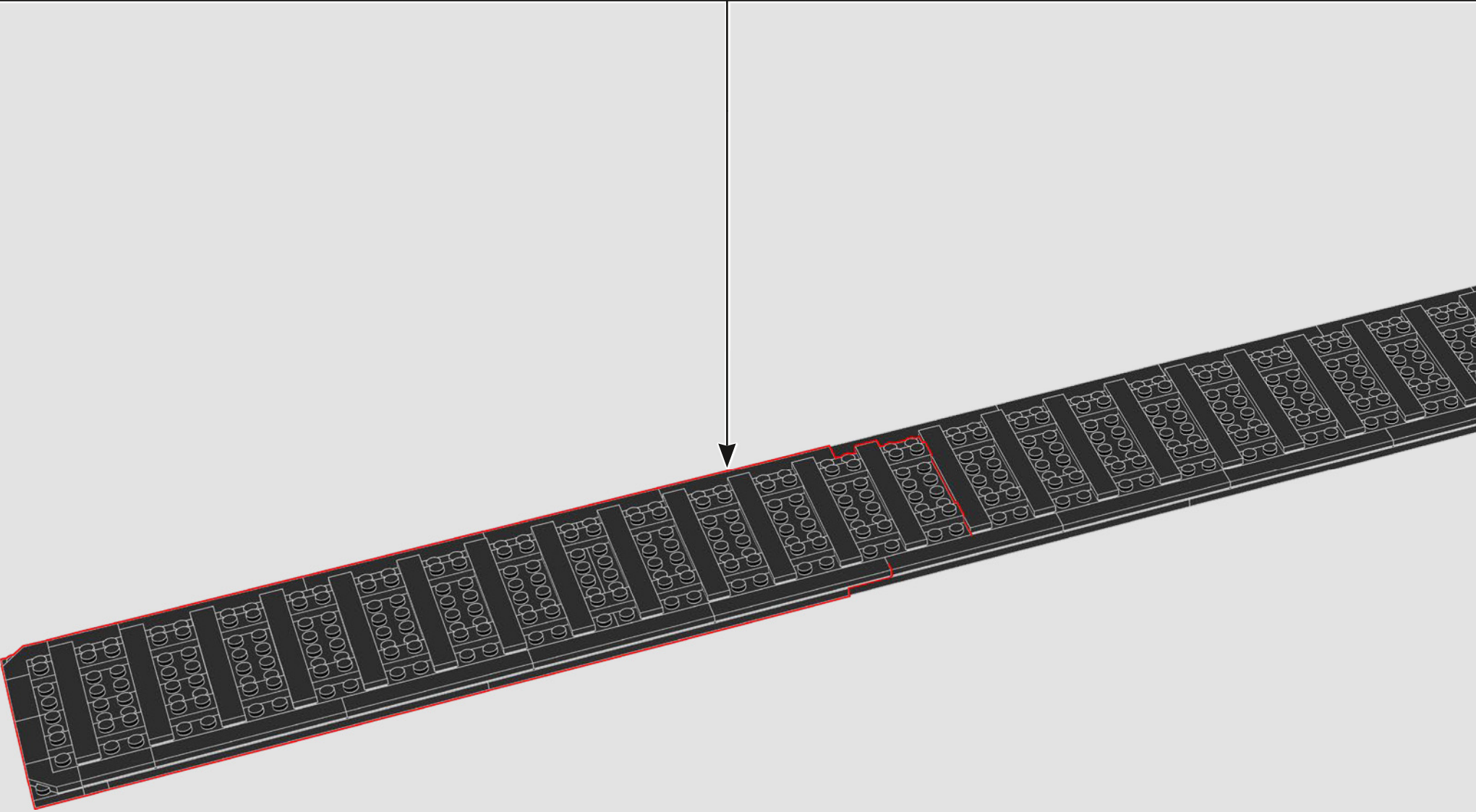

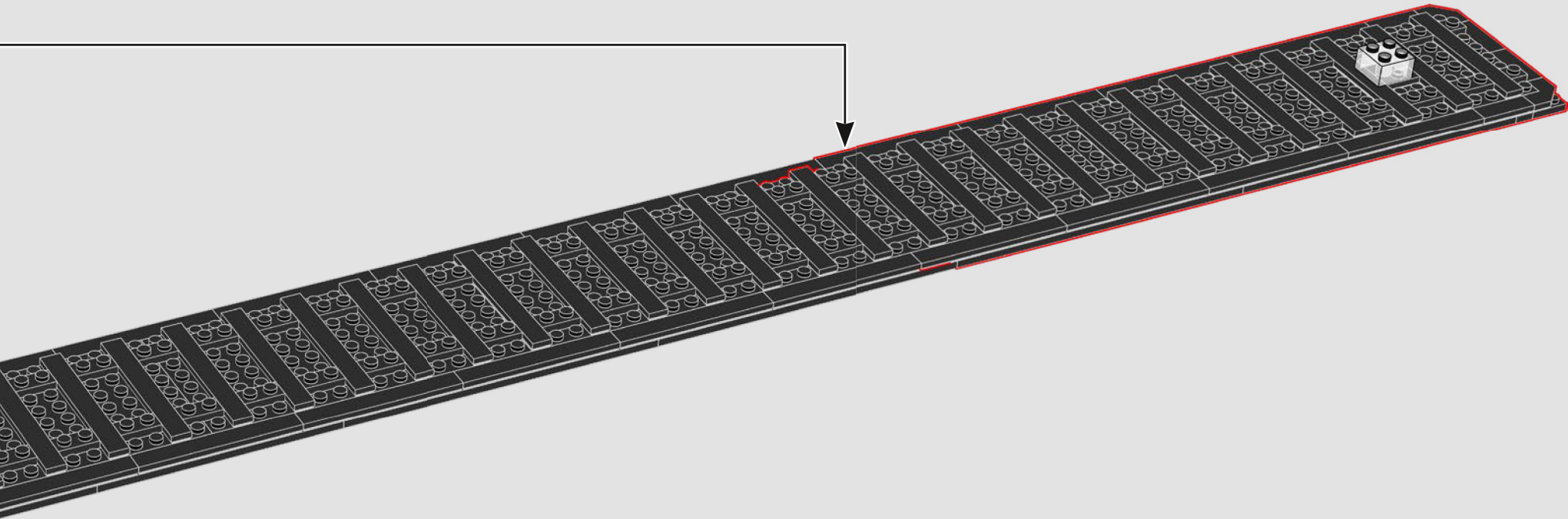

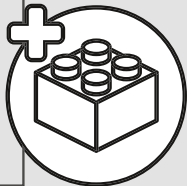
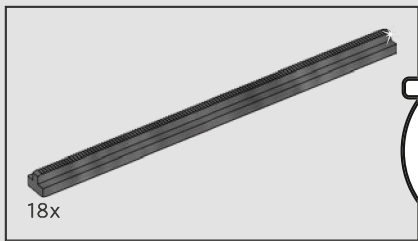

28

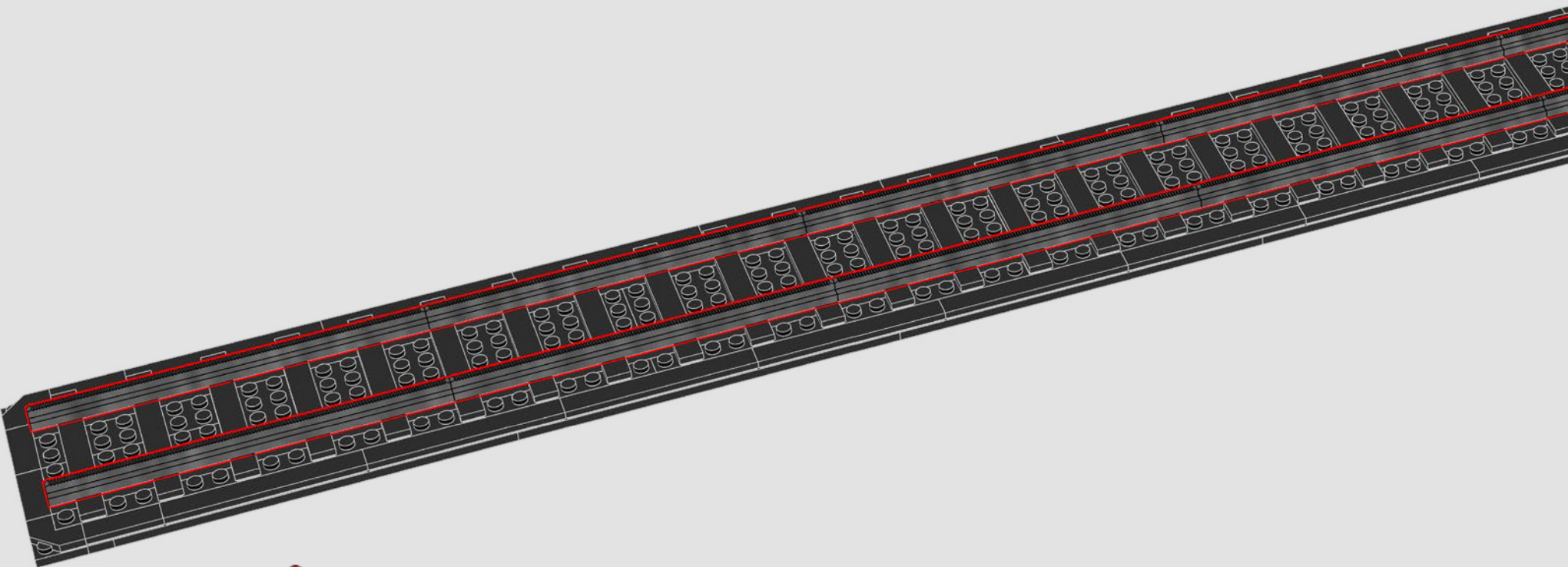

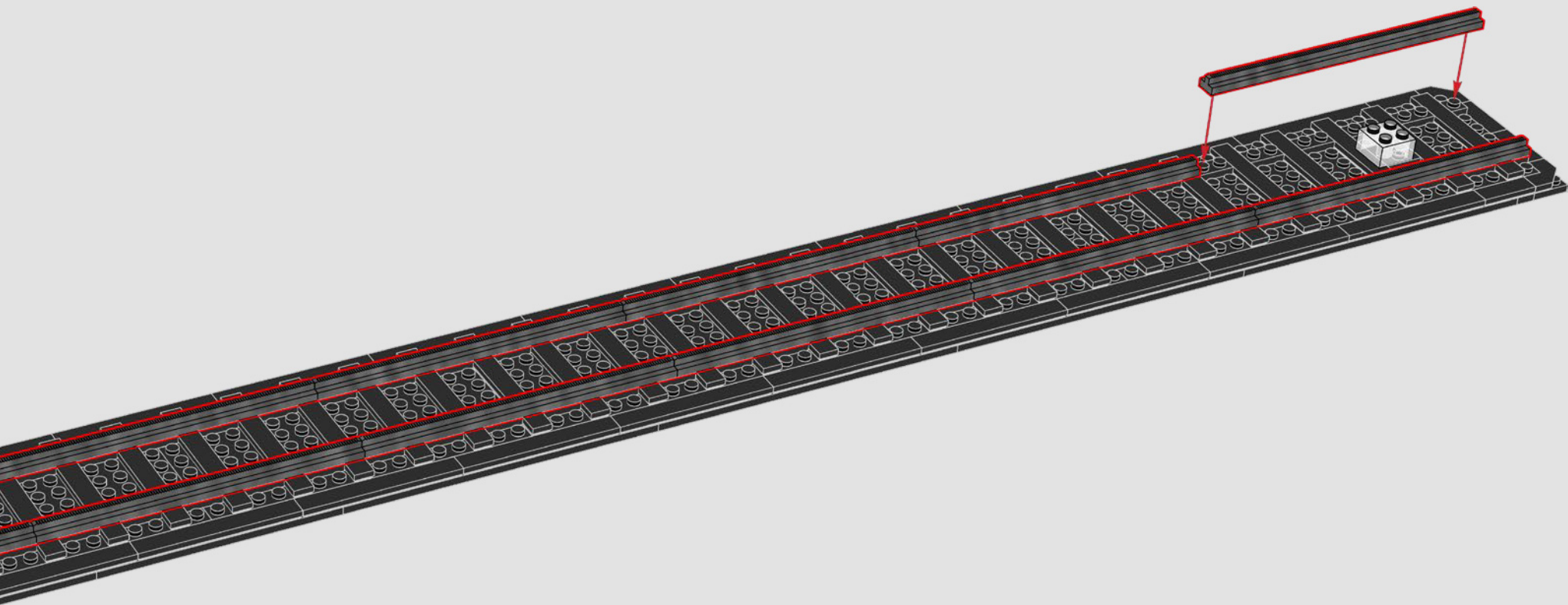

..... ●

Salida: PARÍS
"El viaje comenzó en la estación Gare de l'Est; los pasajeros esperaban ansiosos la llegada del tren".

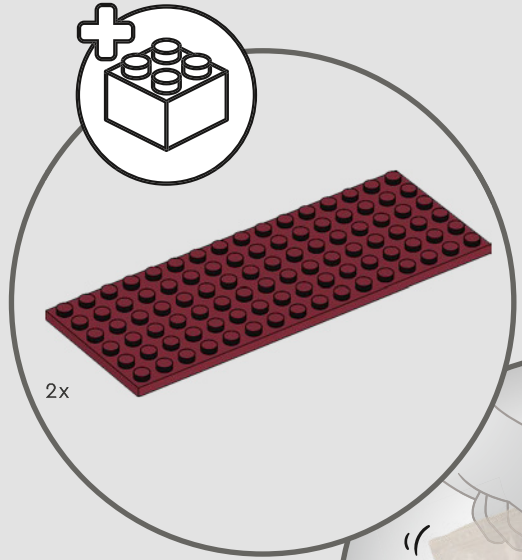
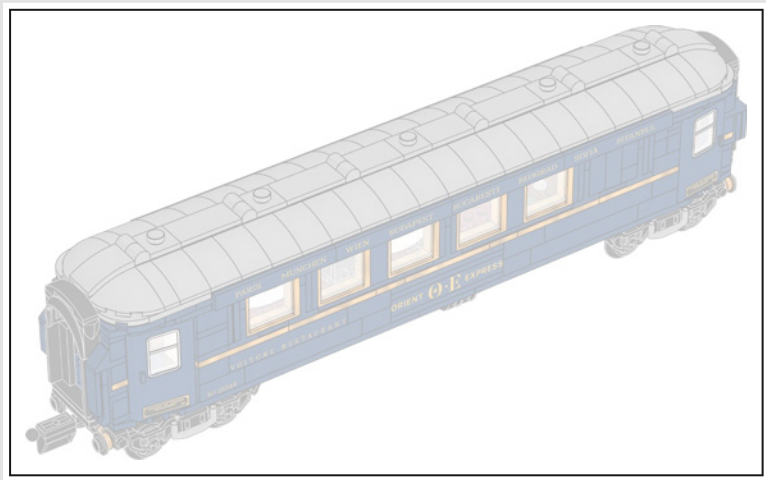

2x

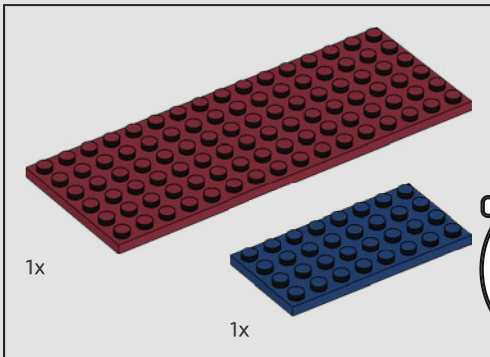
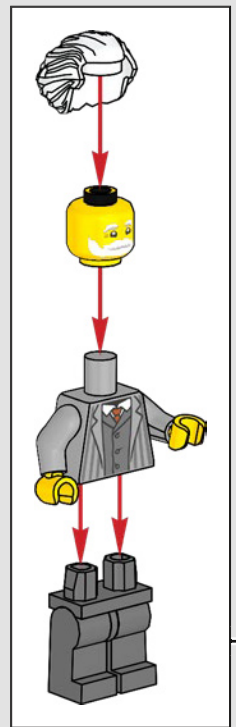

1x

1x

29

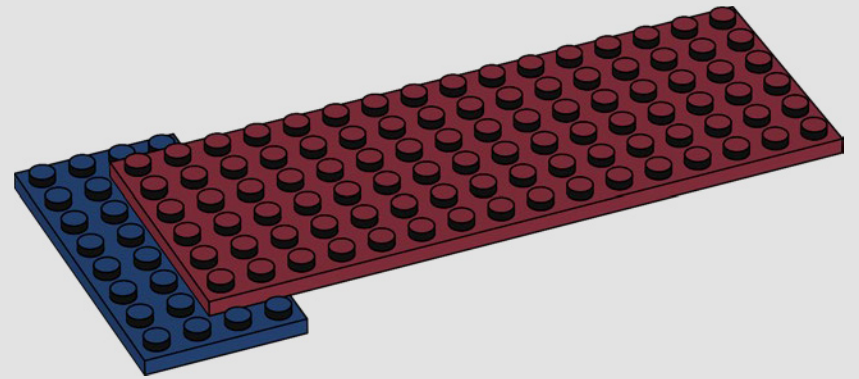

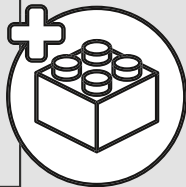
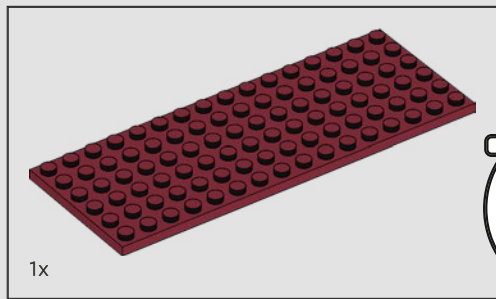

30

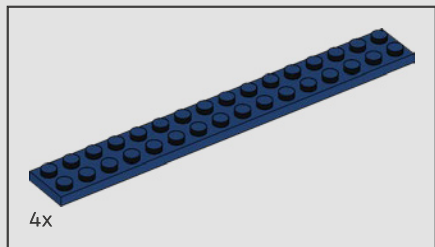
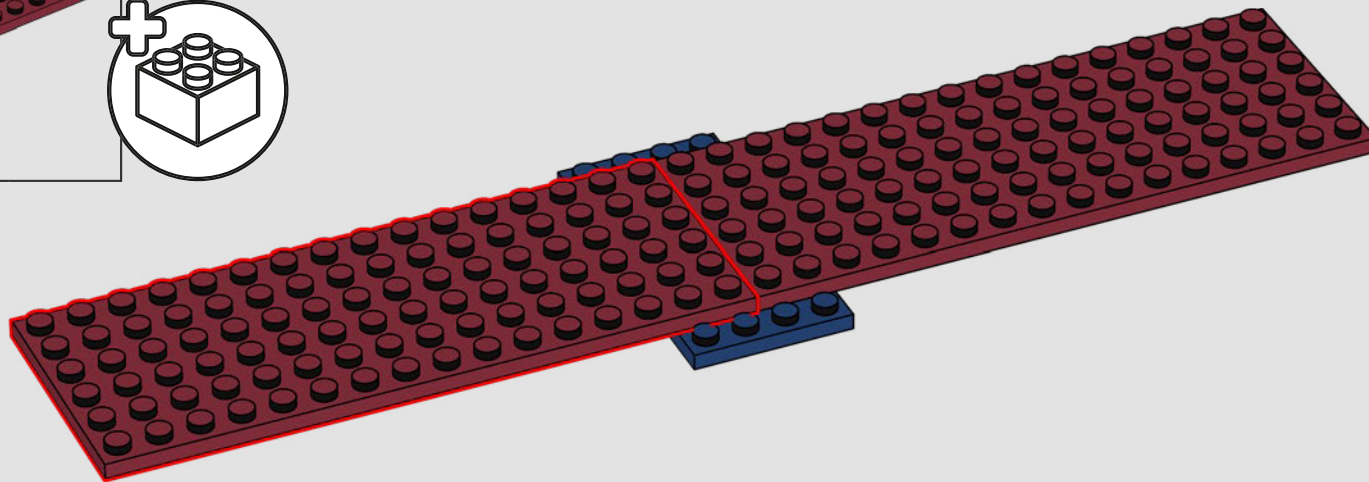

31

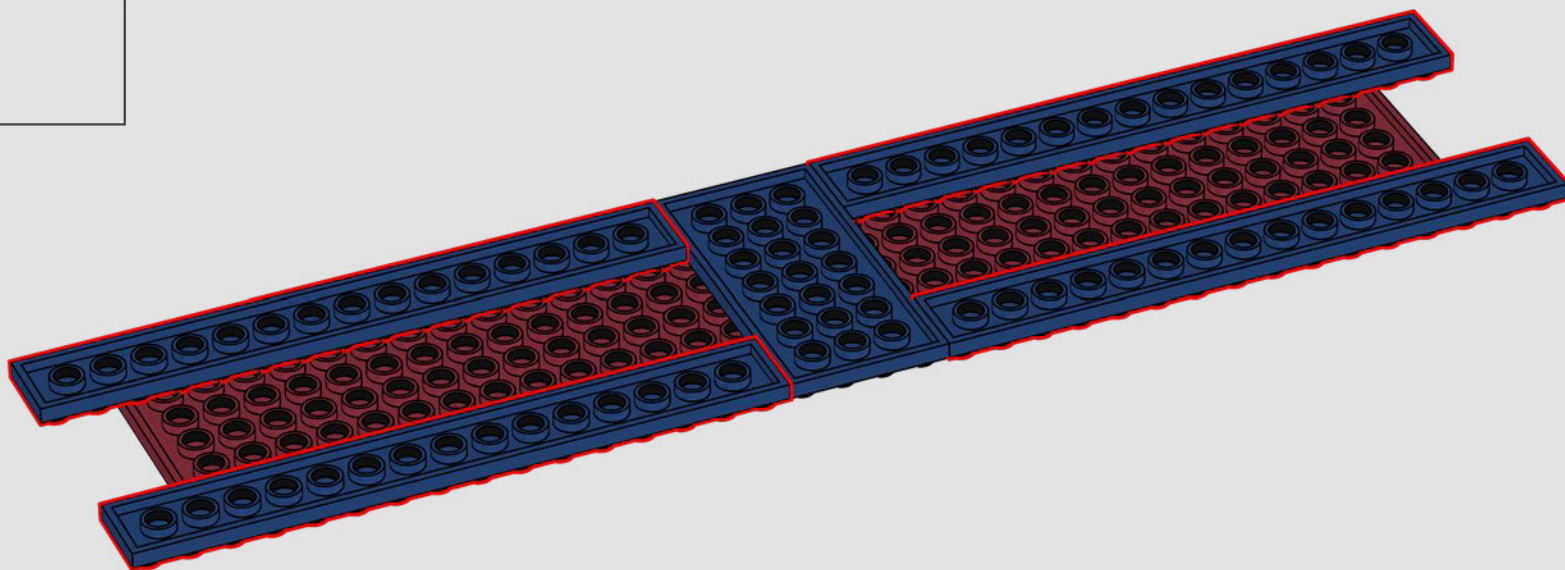

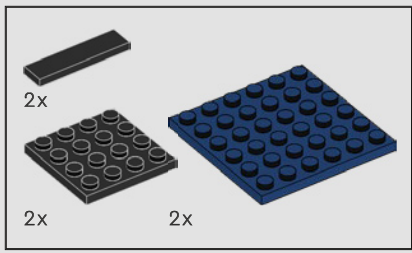

32

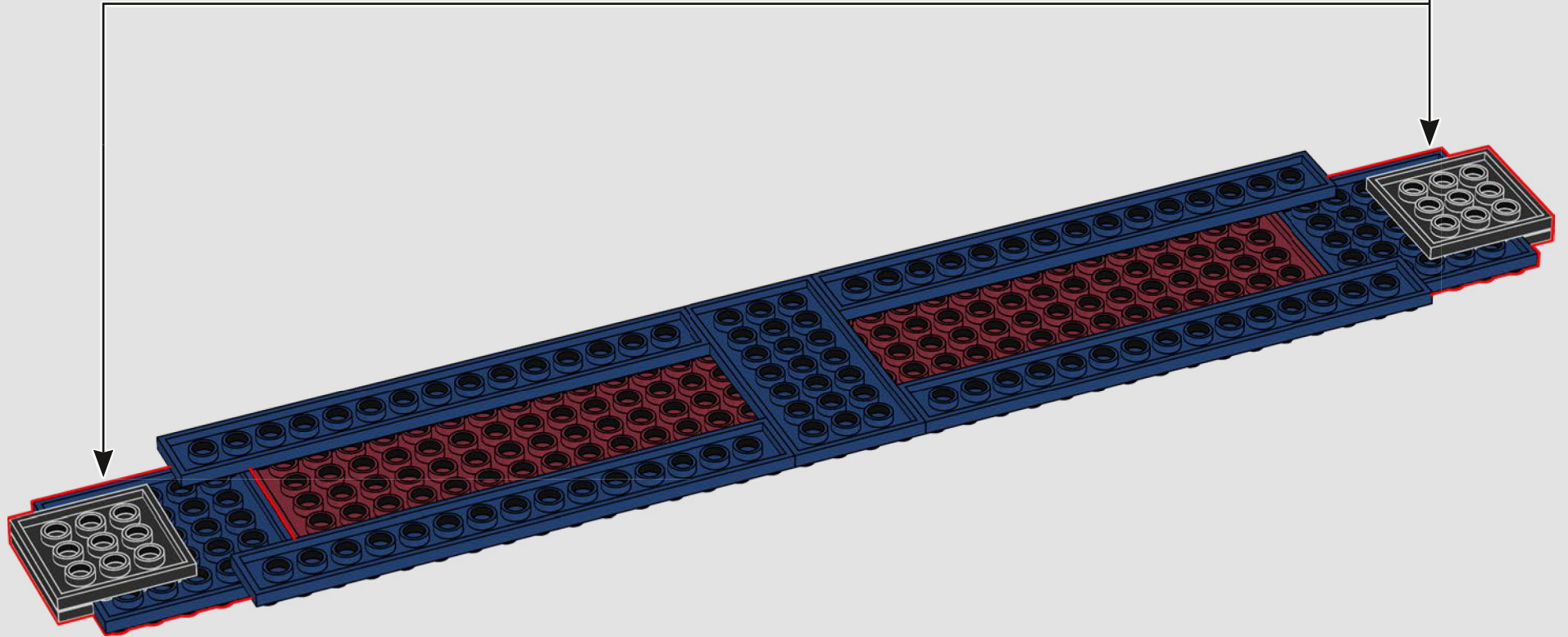
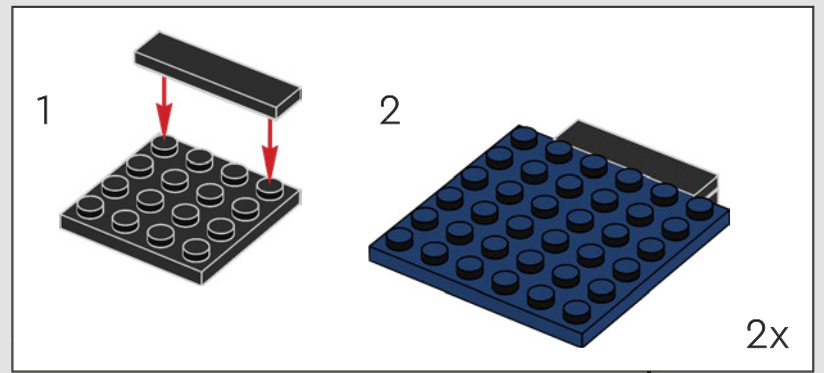

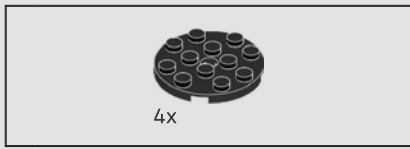

33

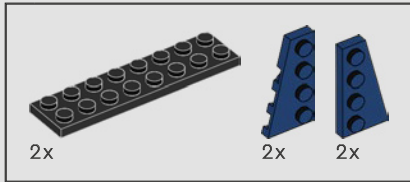
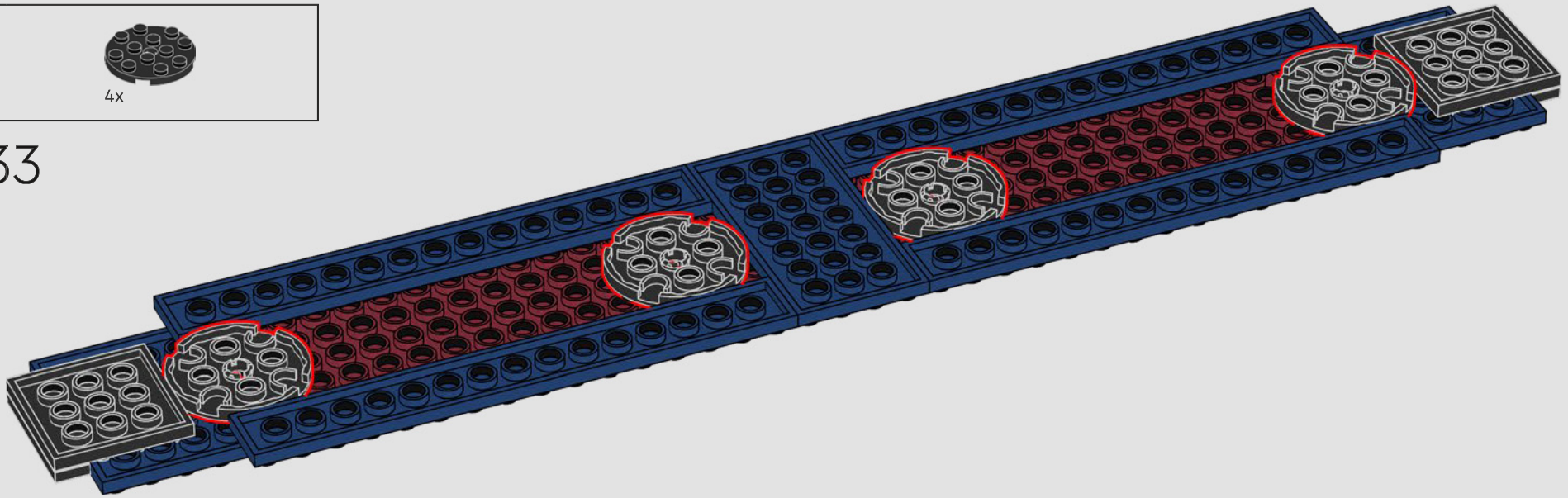

34

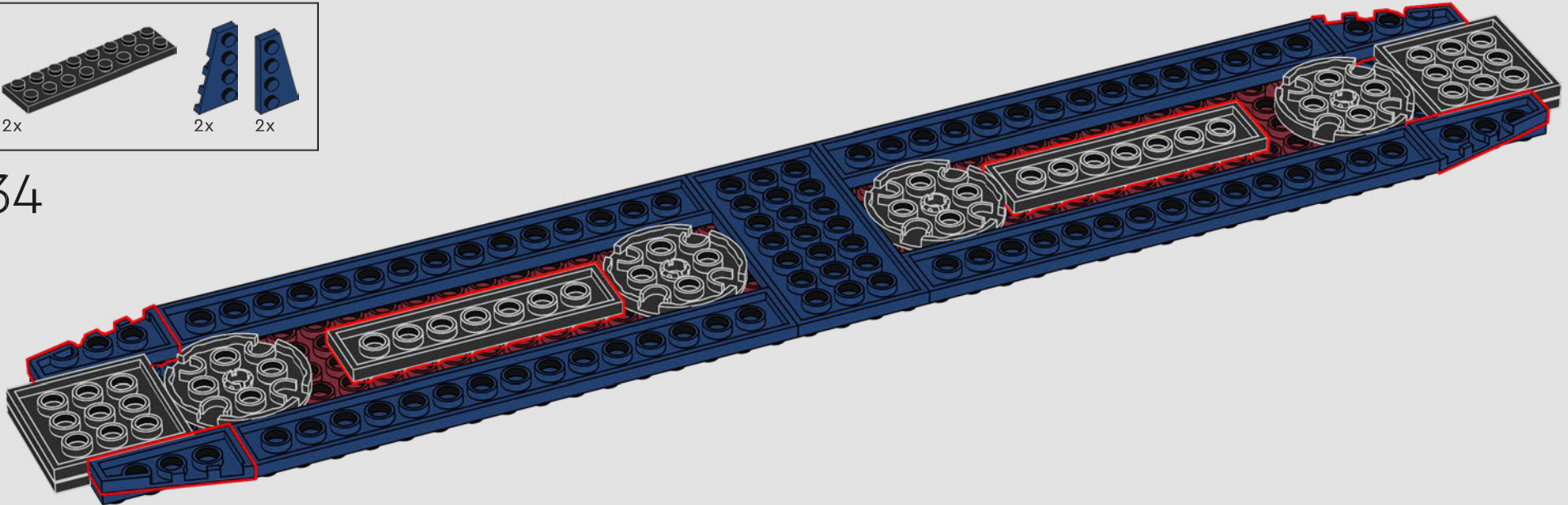



35

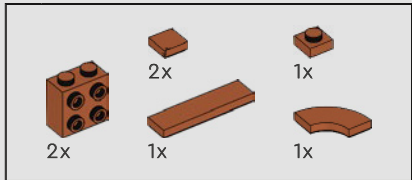
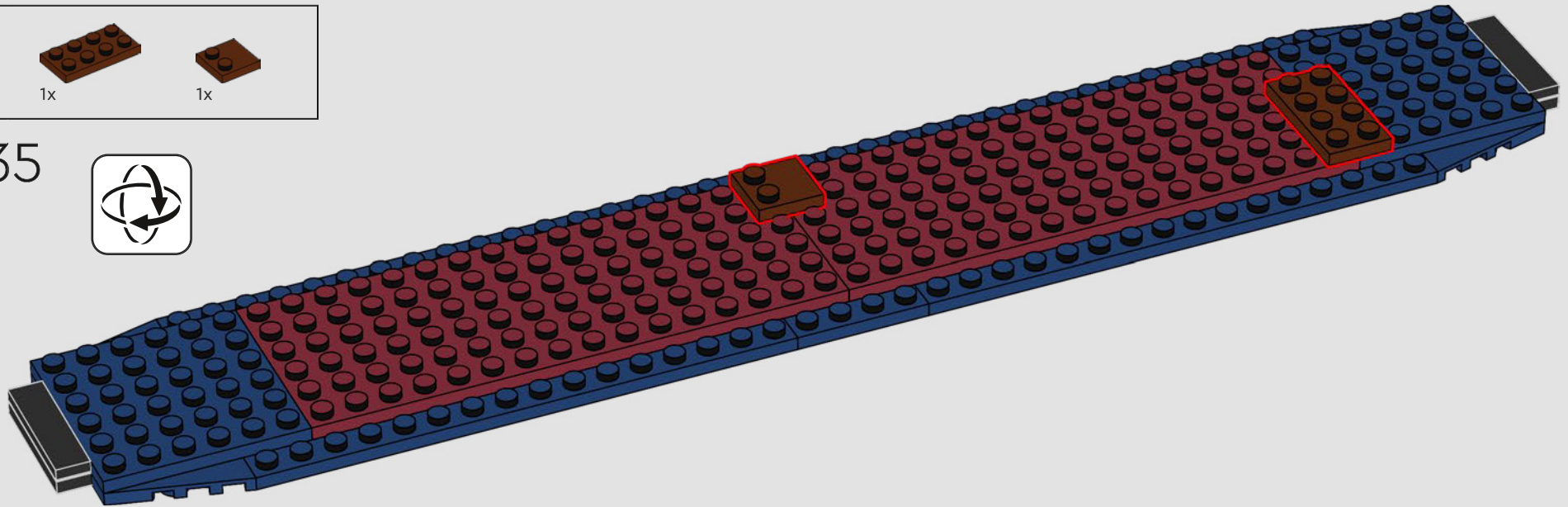

36

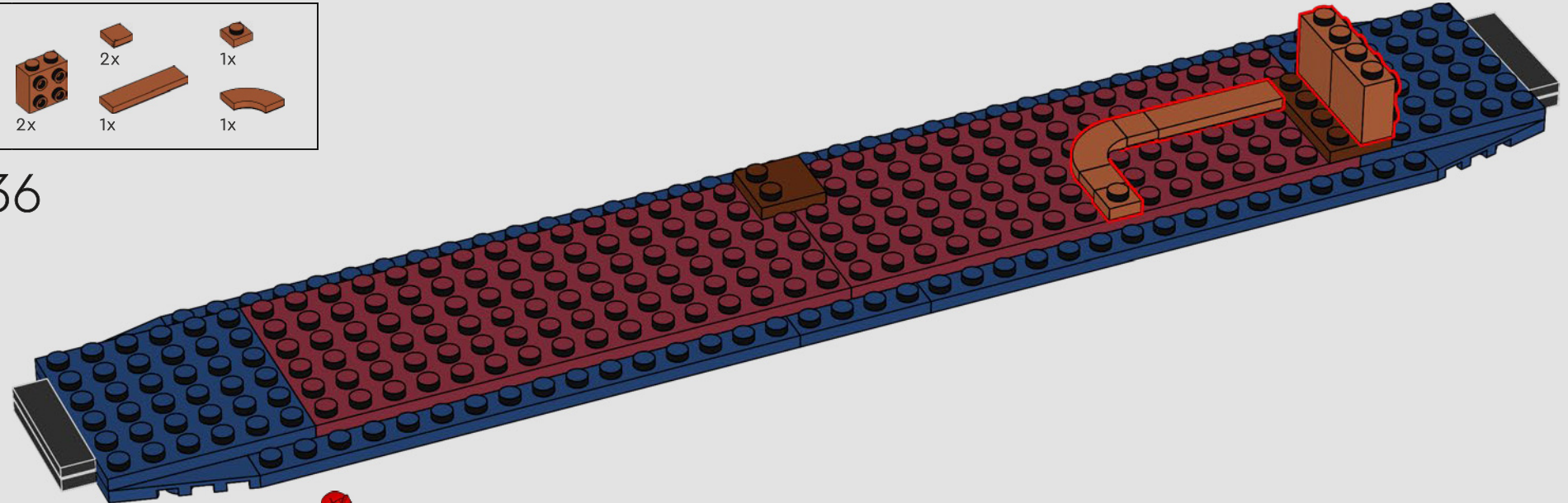

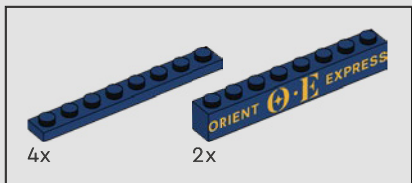

39

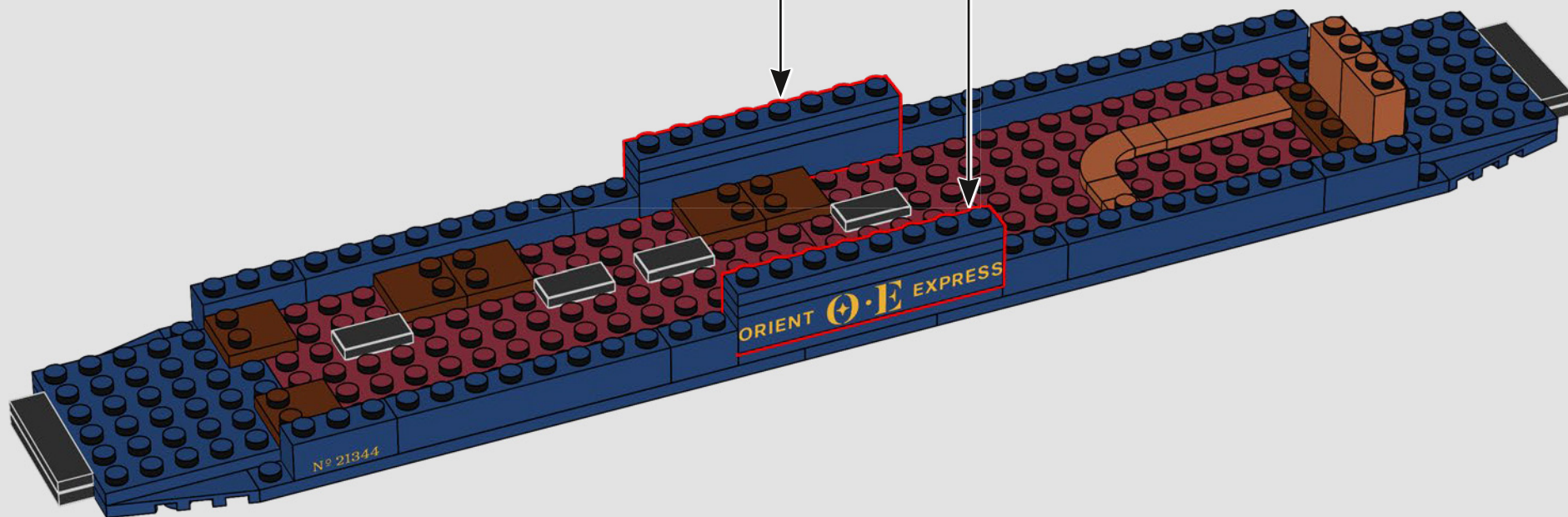
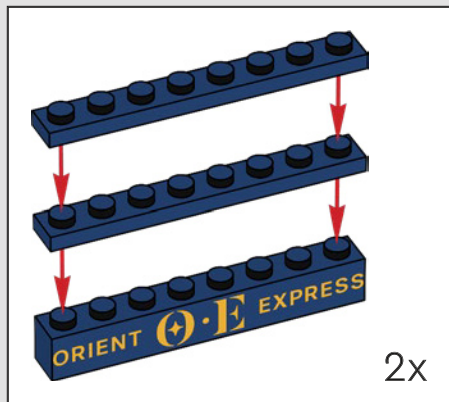

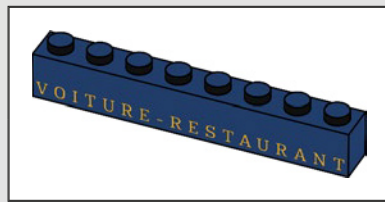
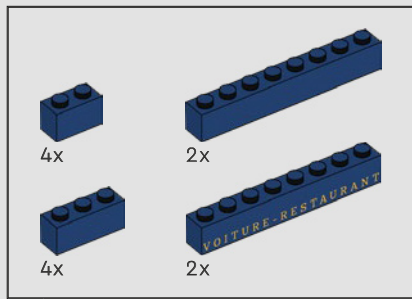

40

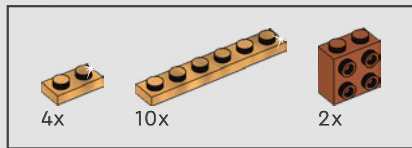
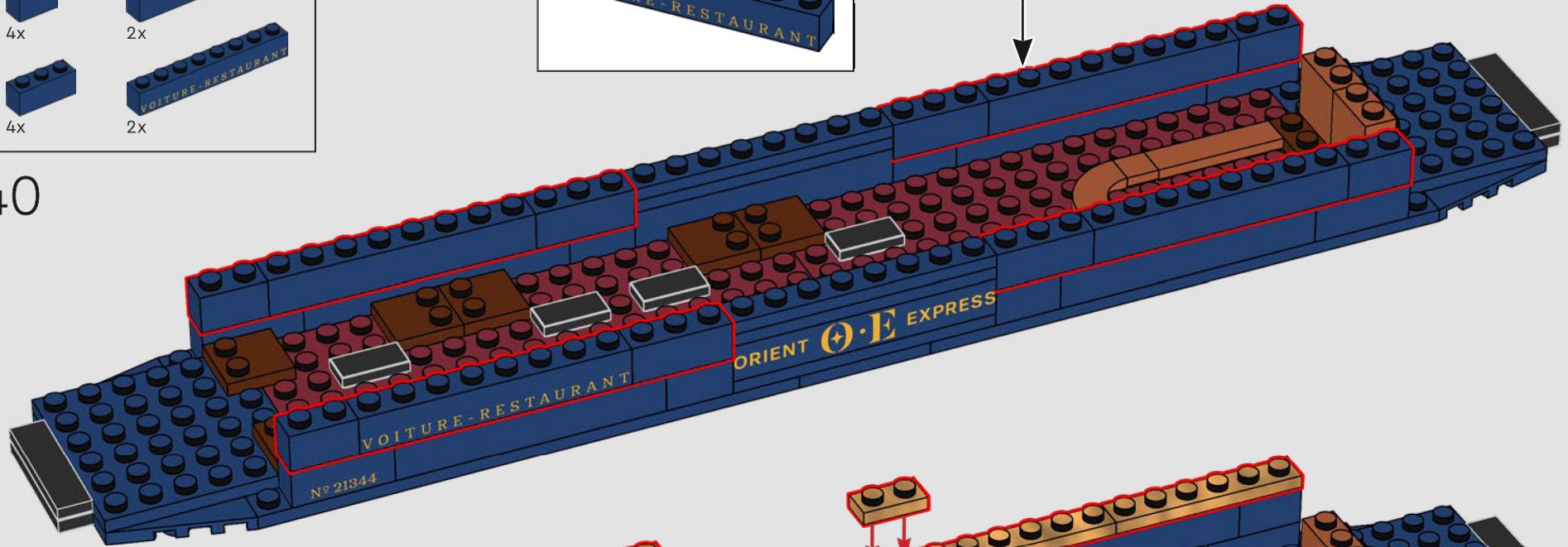

41

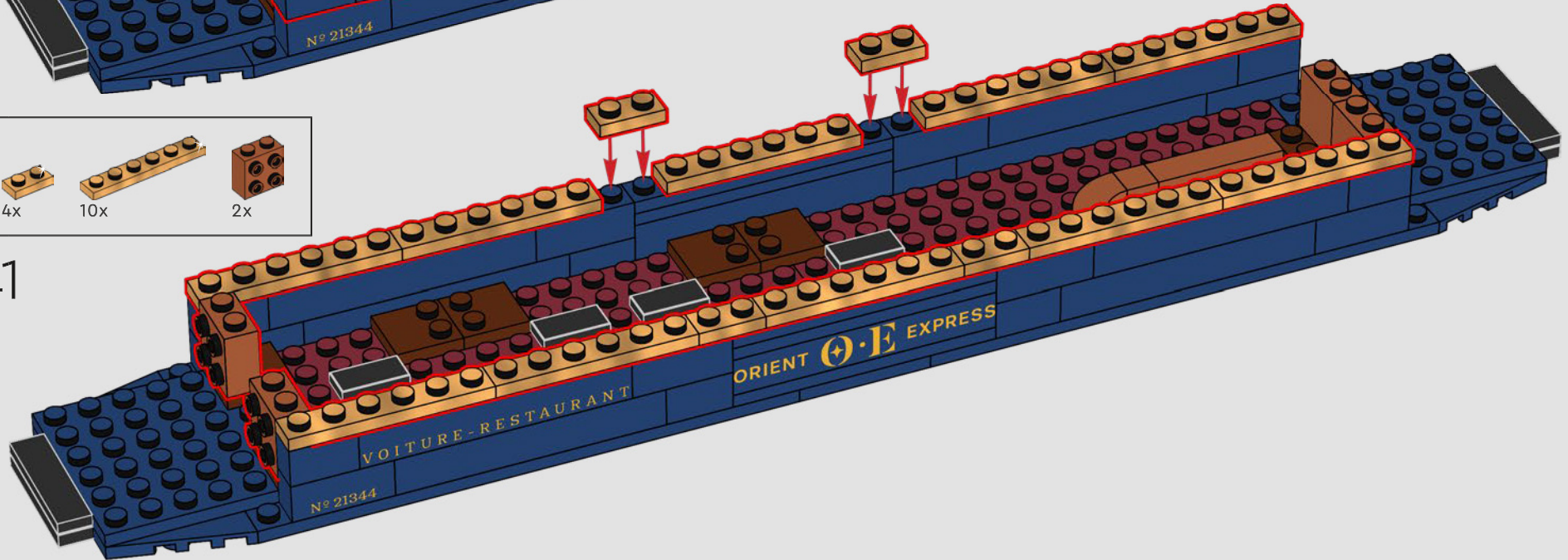

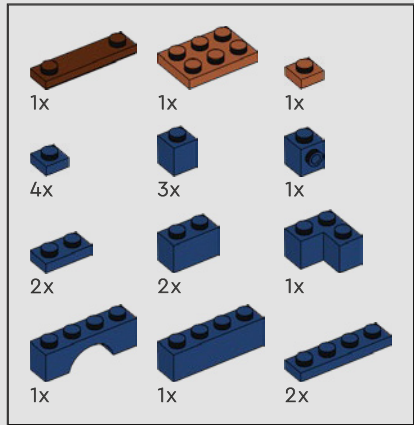

42

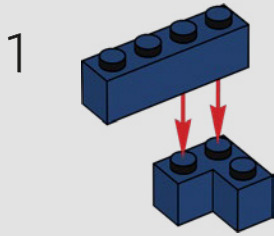

2

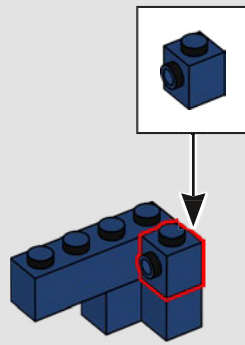

3

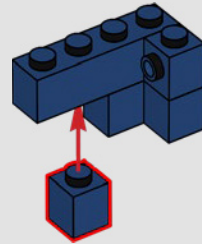

4

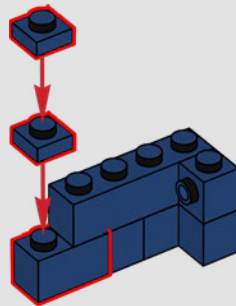

5

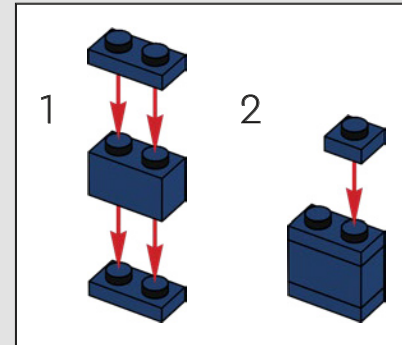
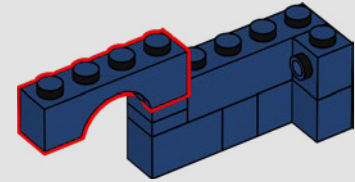

6

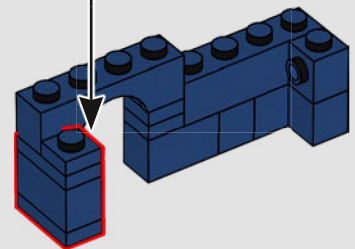

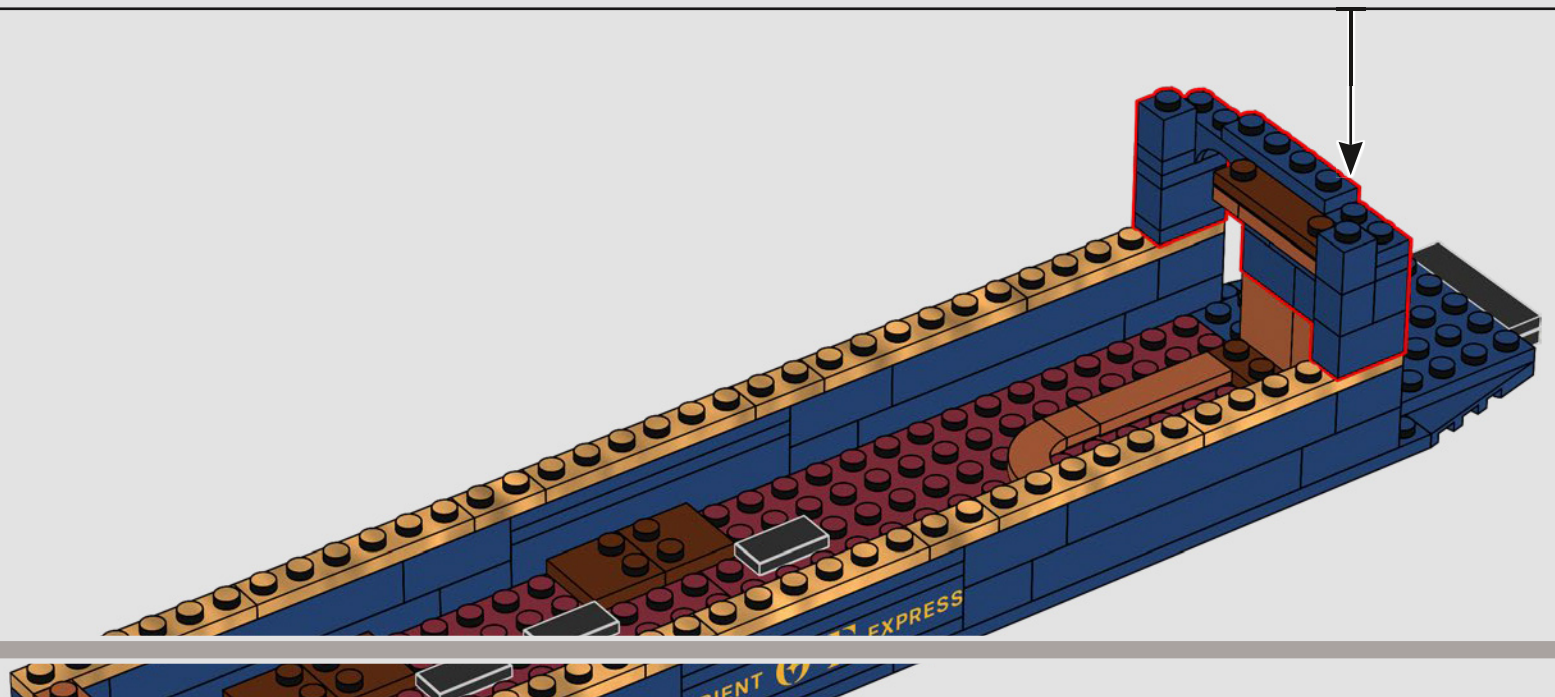
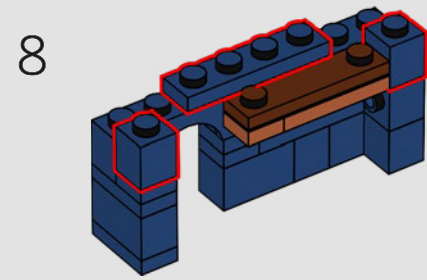
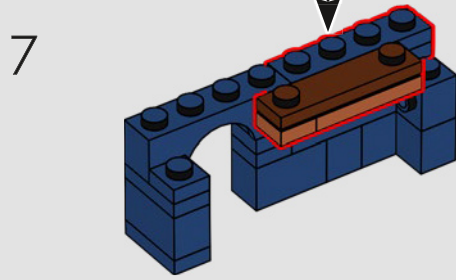
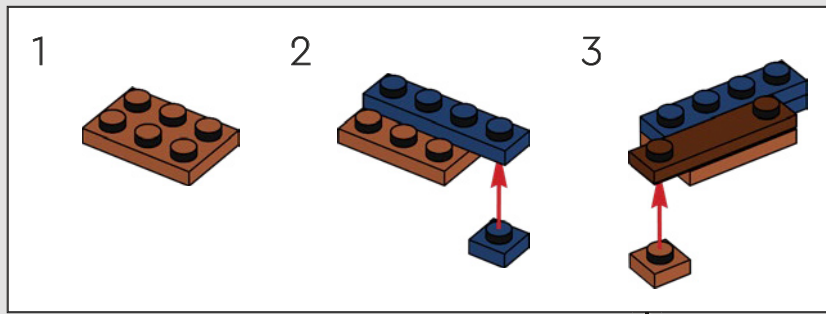

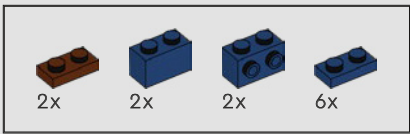

43

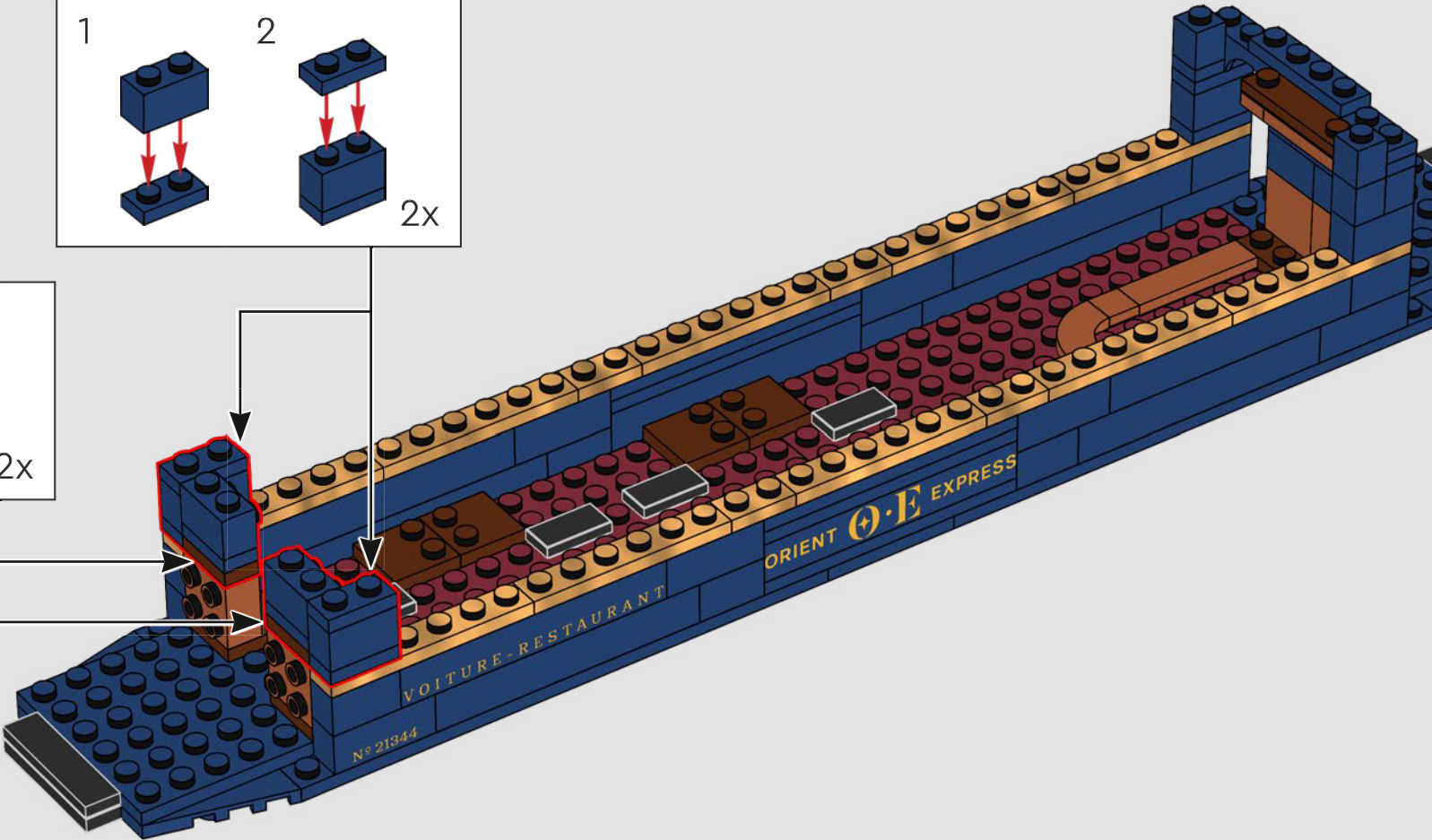
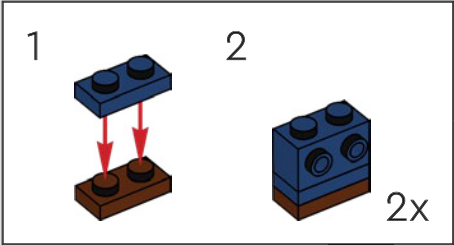
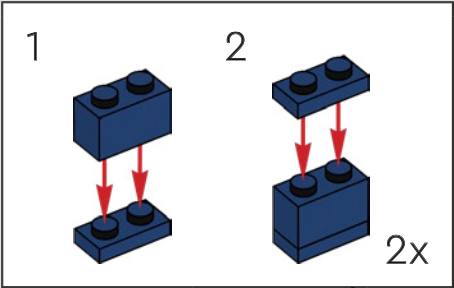

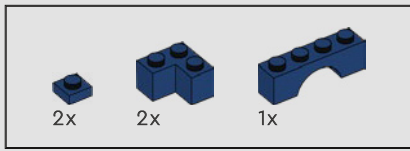

44

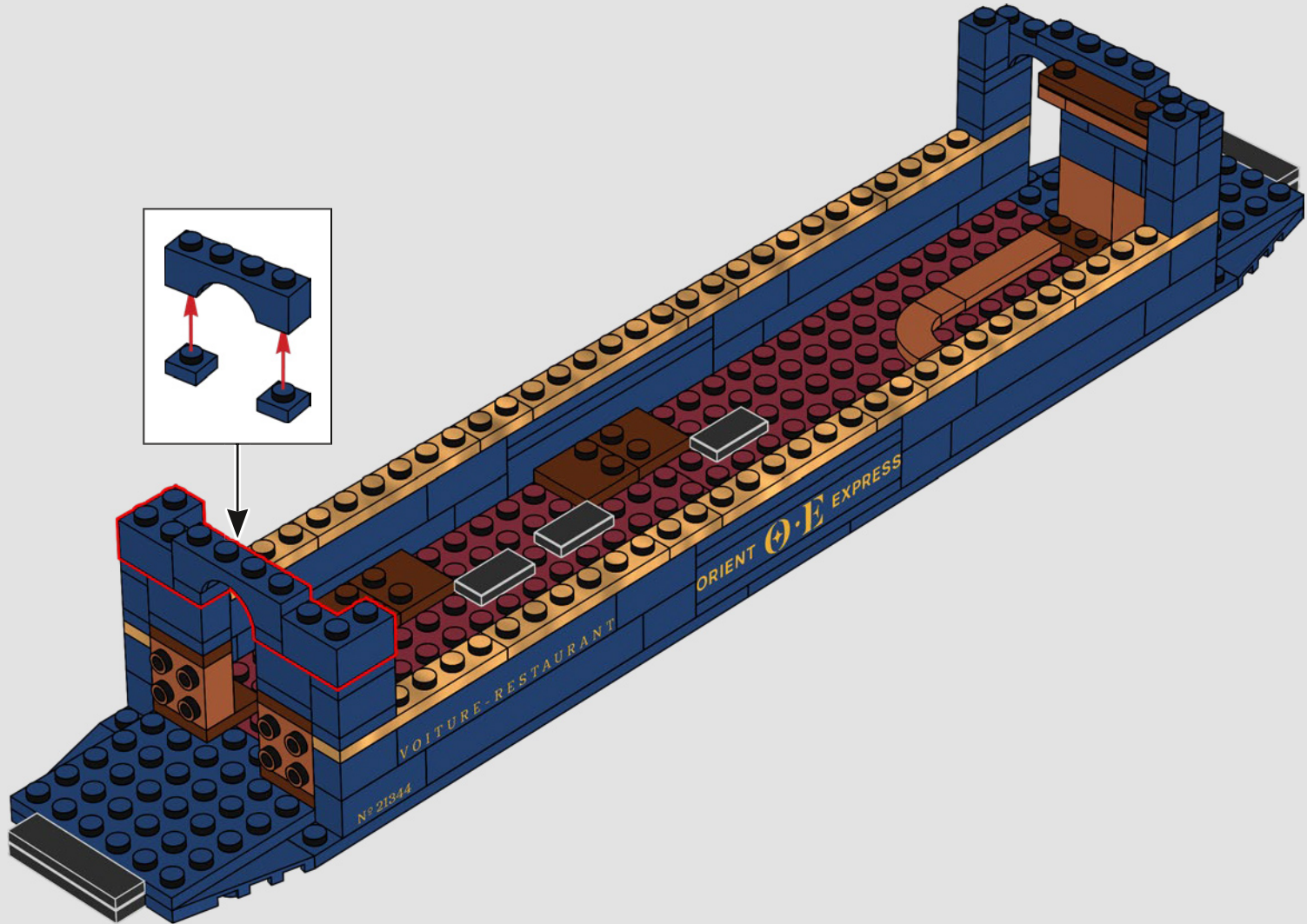

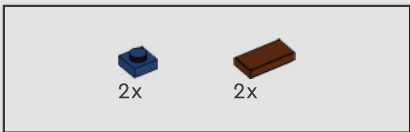

45

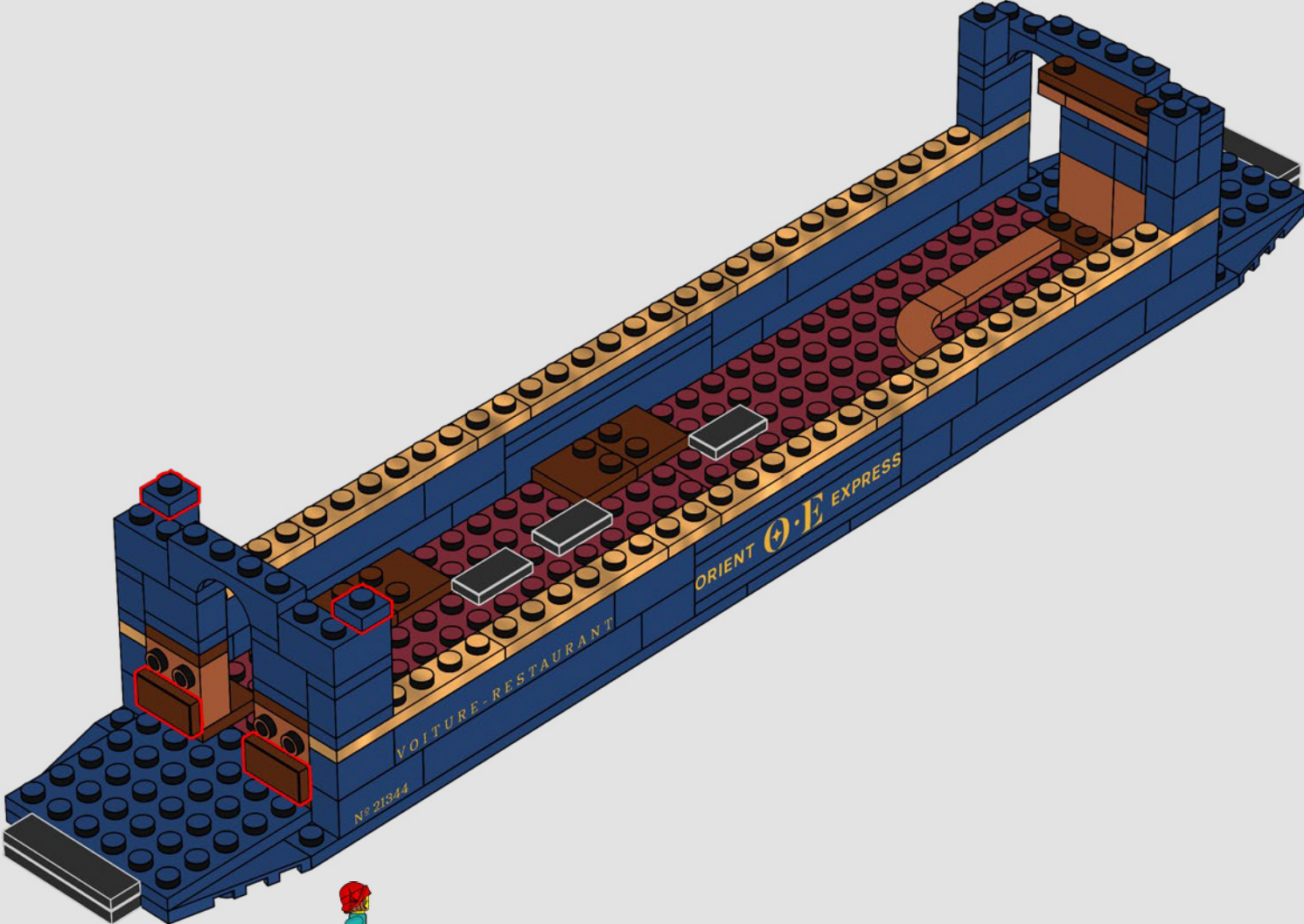

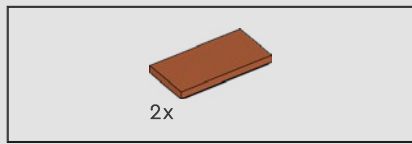

46

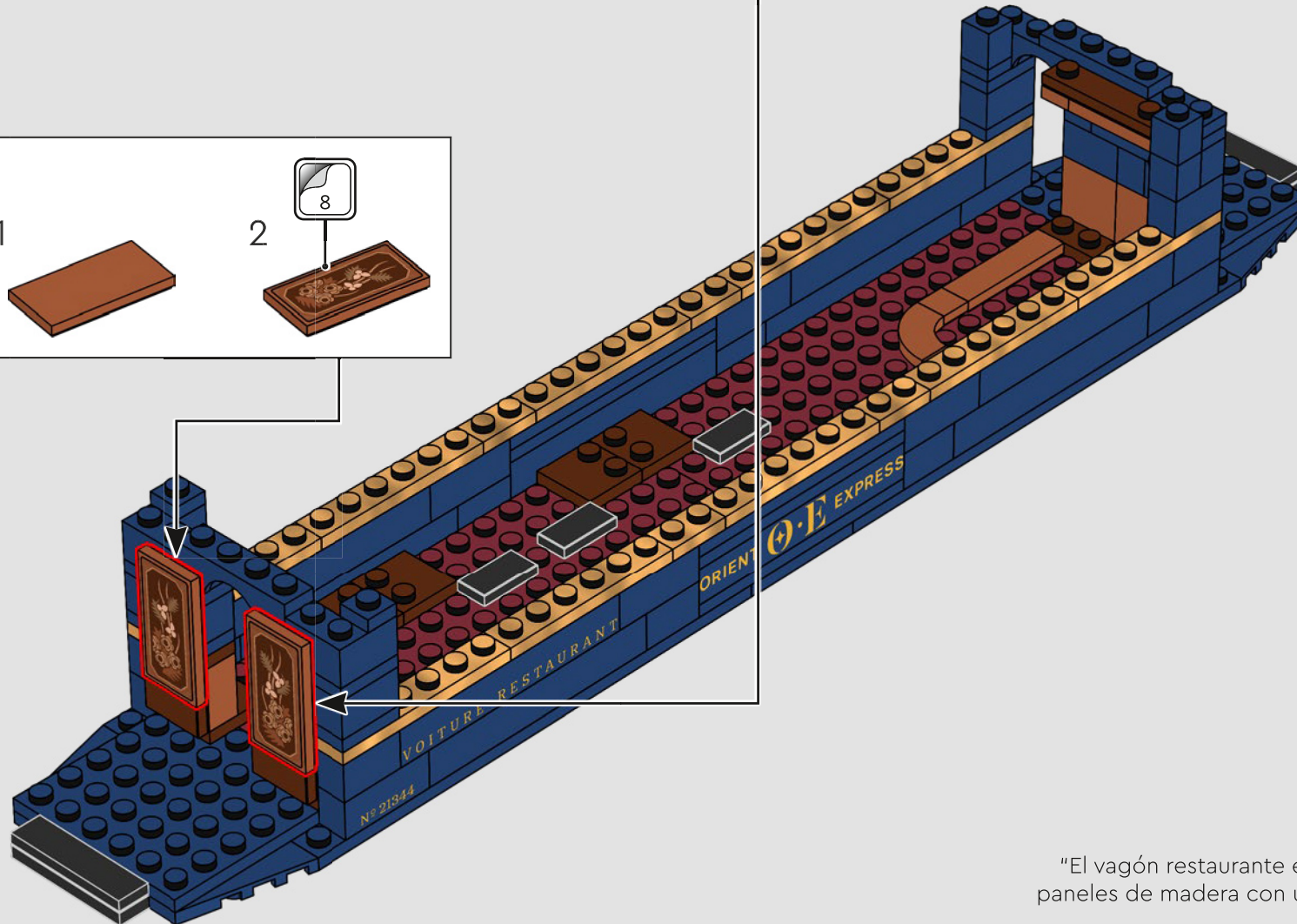
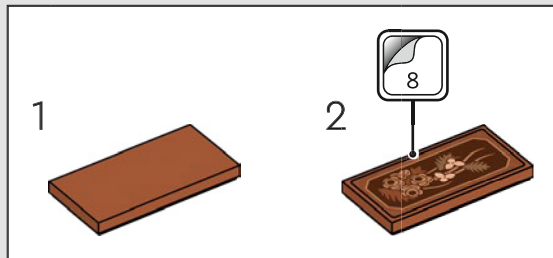
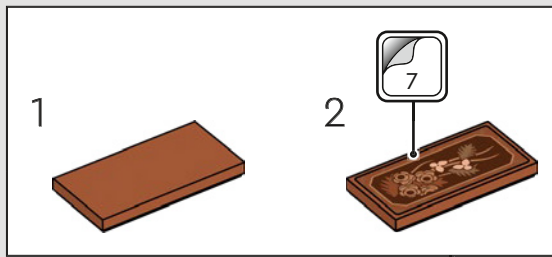

"El vagón restaurante está decorado con hermosos paneles de madera con un diseño de flores exóticas".

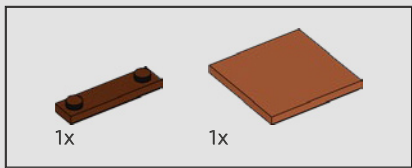

47

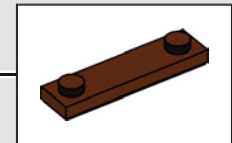
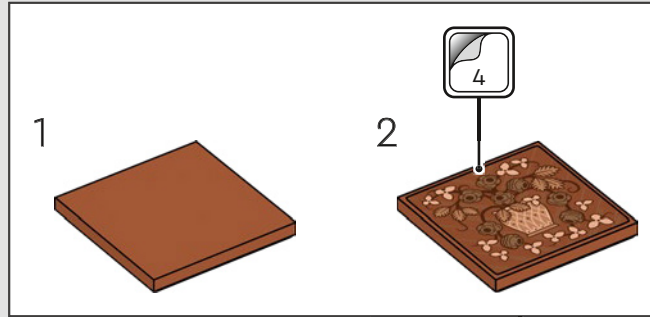
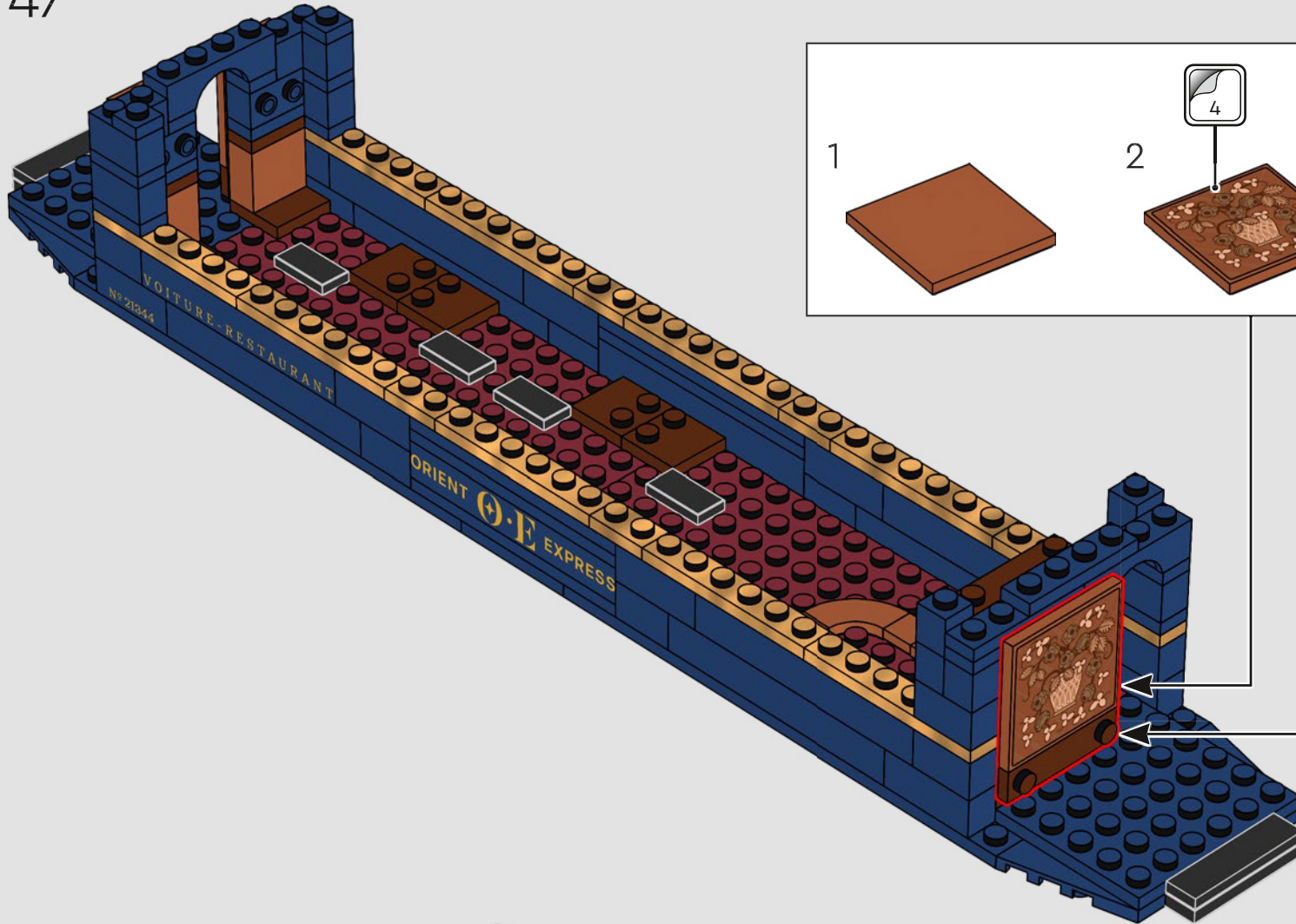

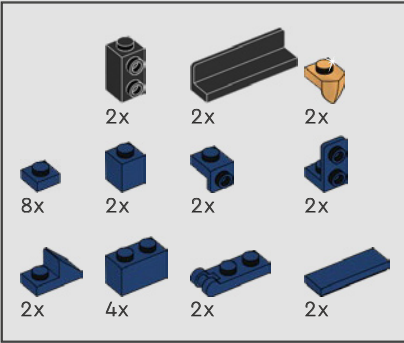
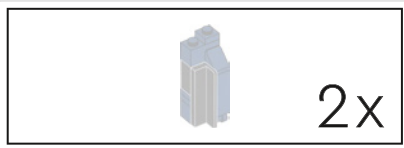

48

1

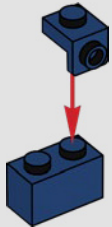

2

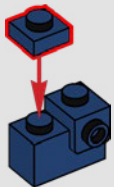

3

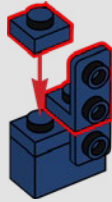

4

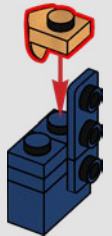

5

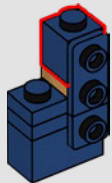

6

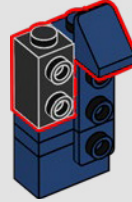

7

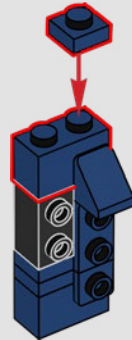

8

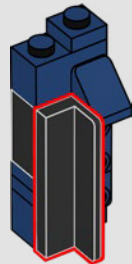

9

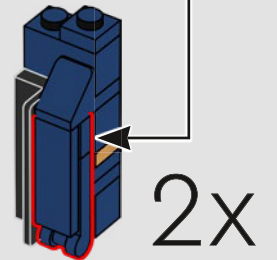

2x

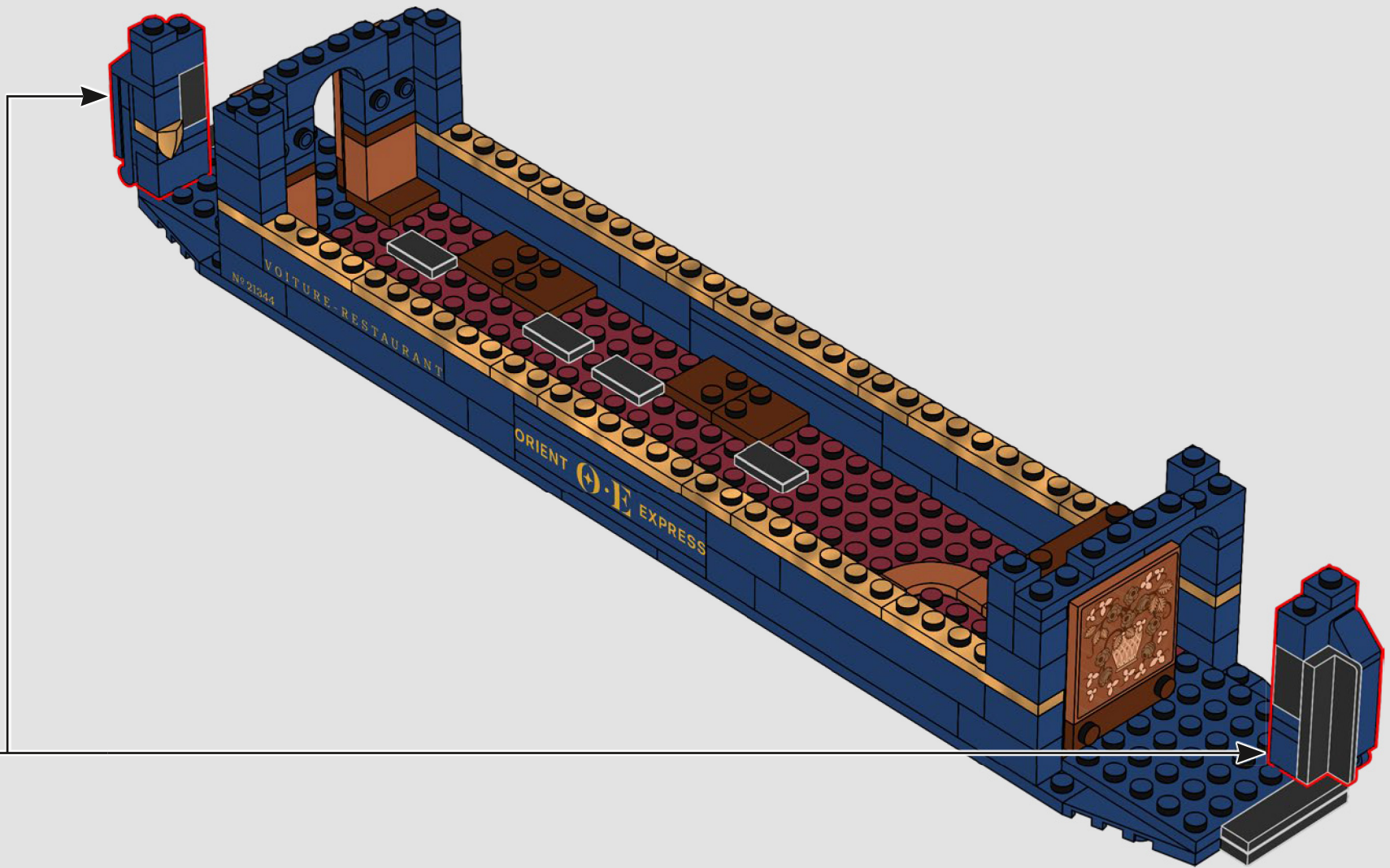

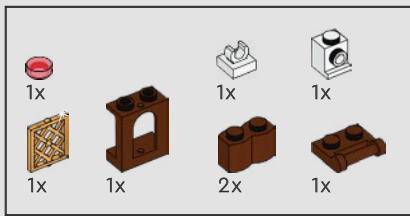

49

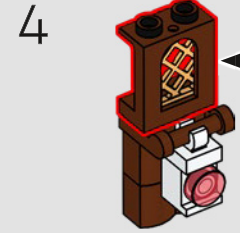
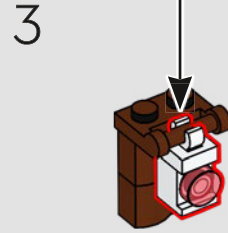
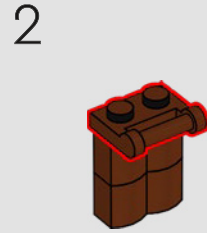
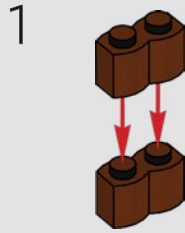
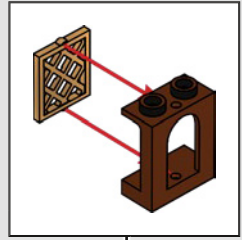
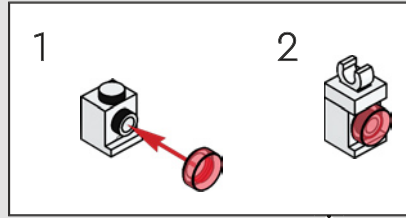



2x



2x



4x



2x



4x



2x



4x



2x



2x



2x



2x

50

1

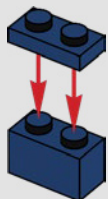

2

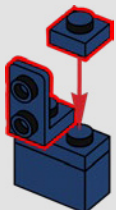

3



4

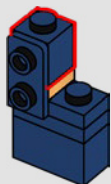

5

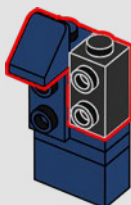

6

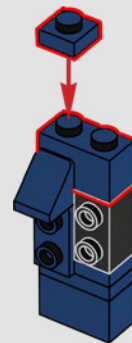

7

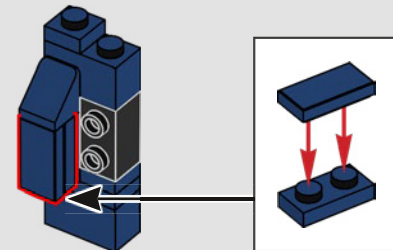

8

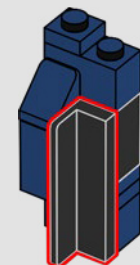

2x



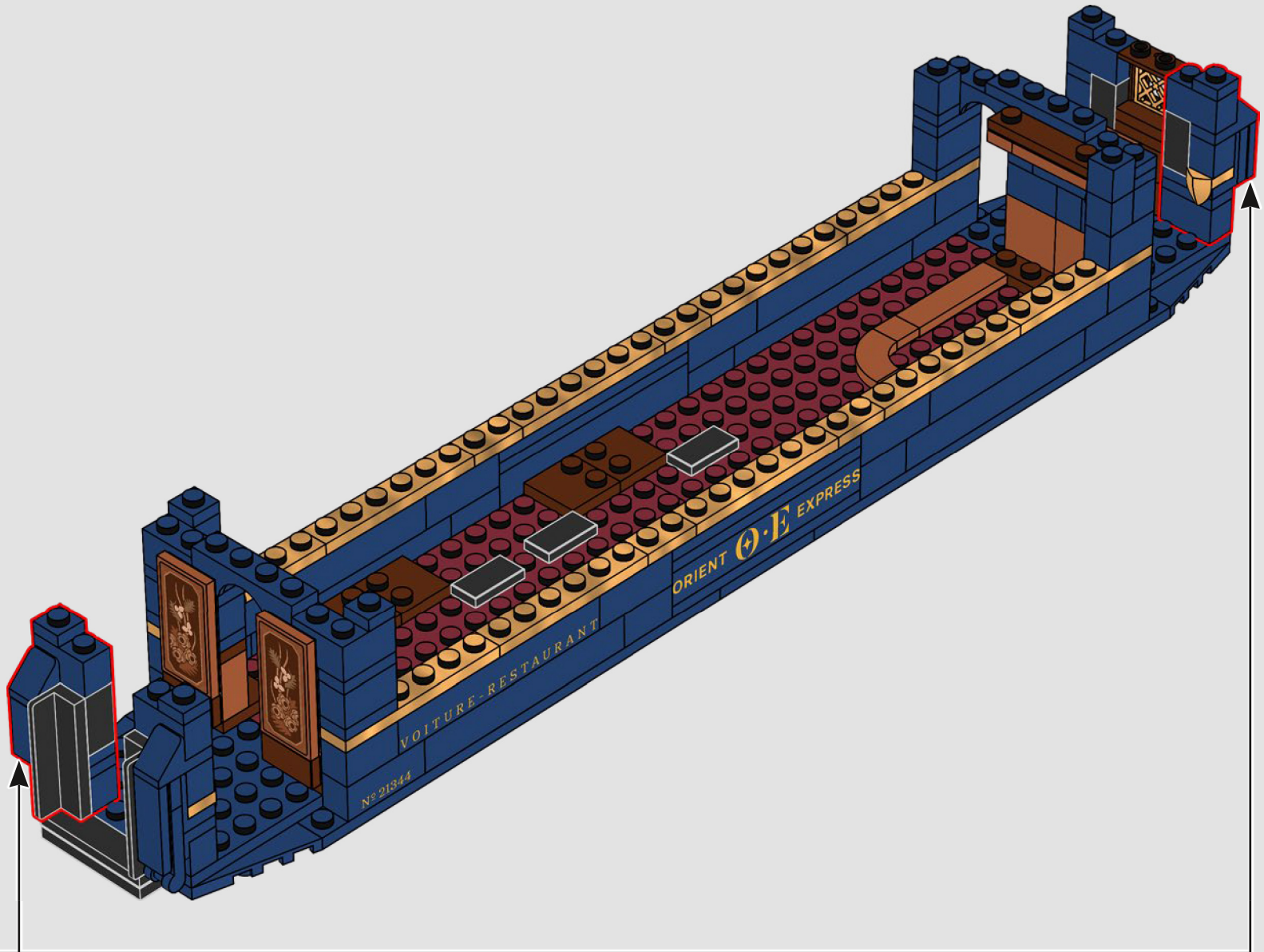

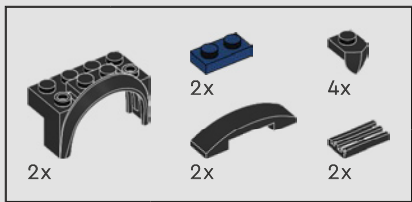

51

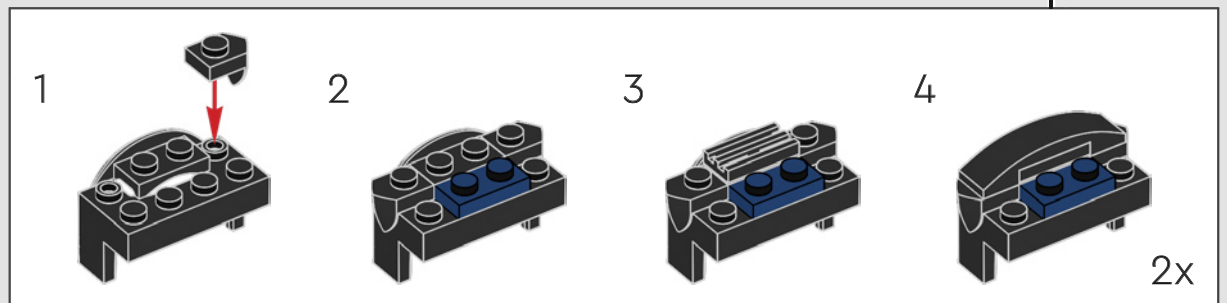
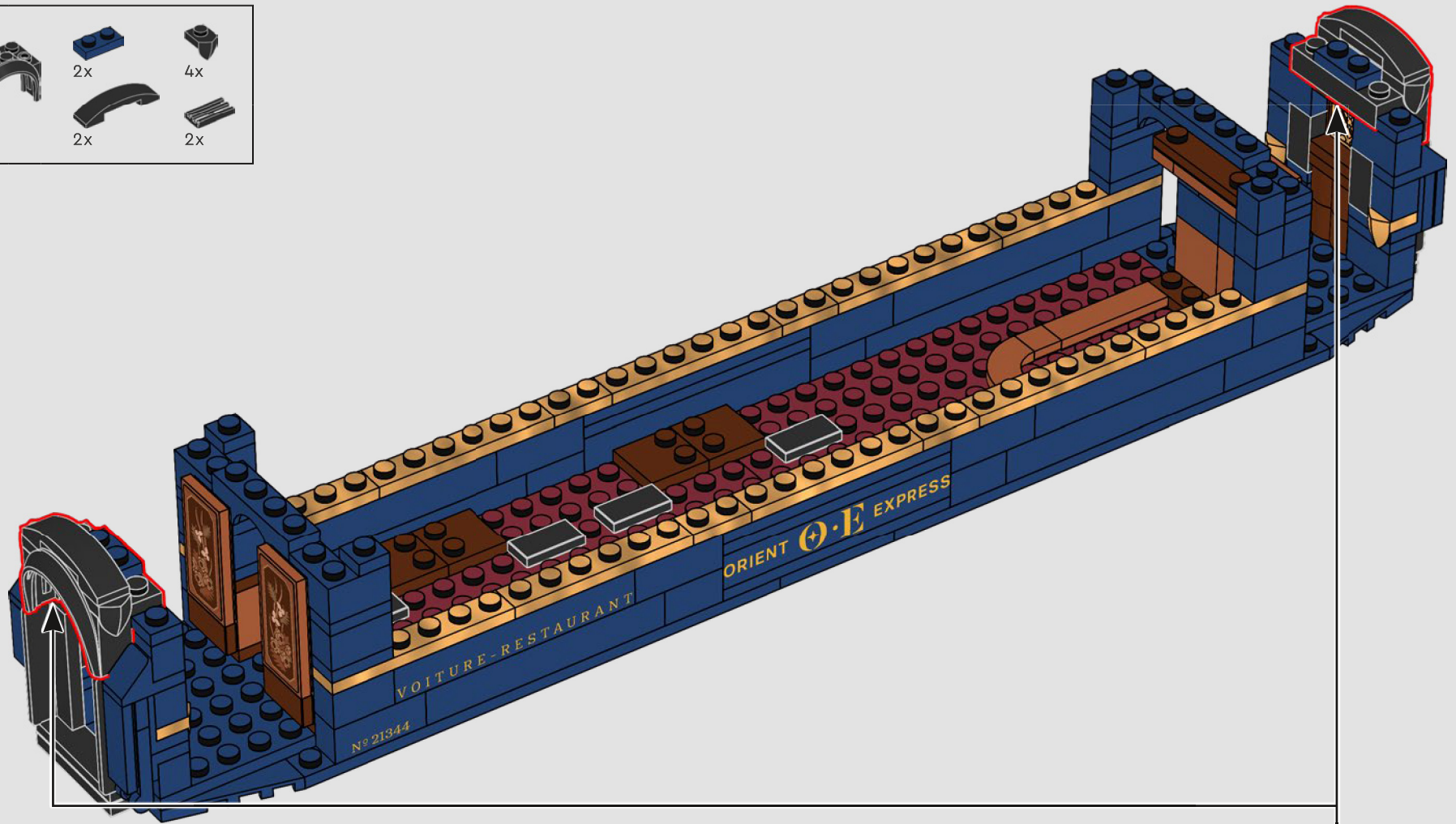

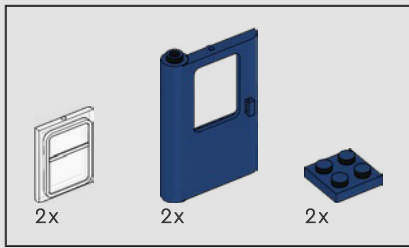

52

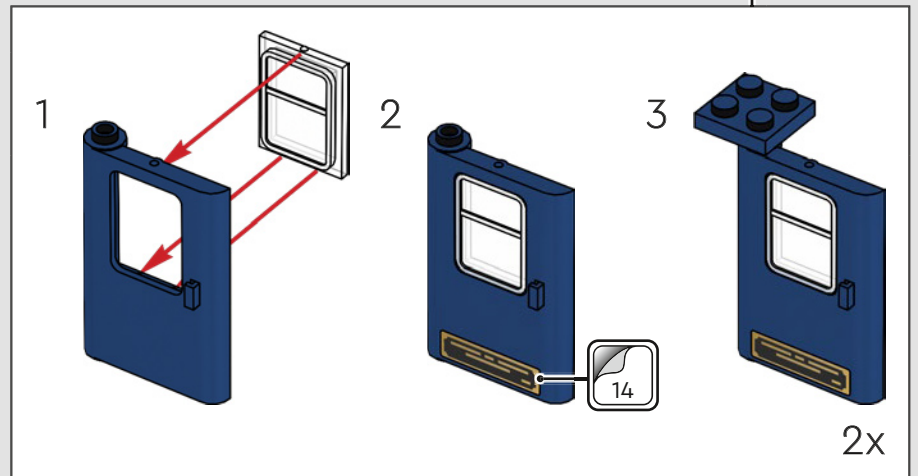
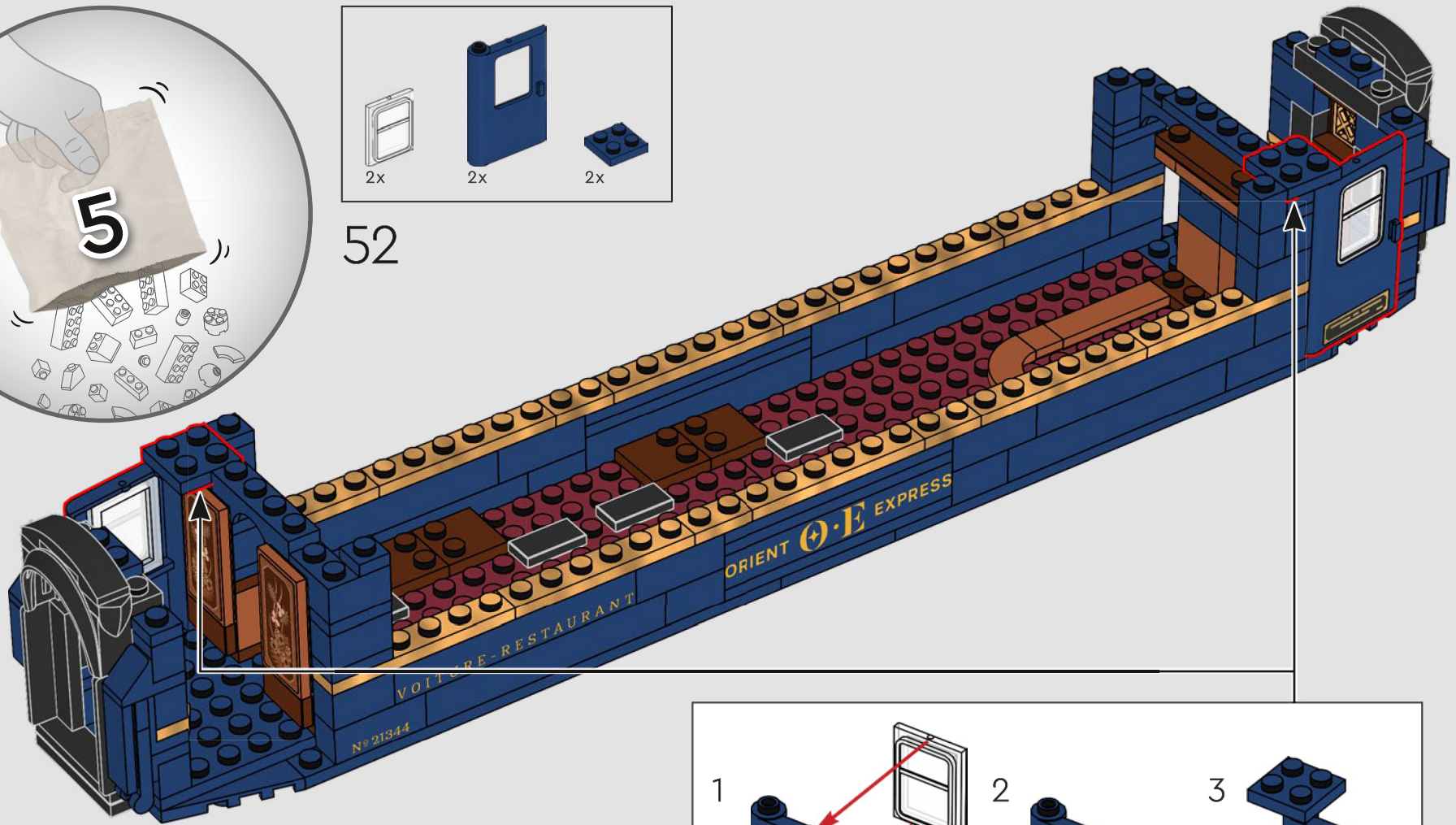

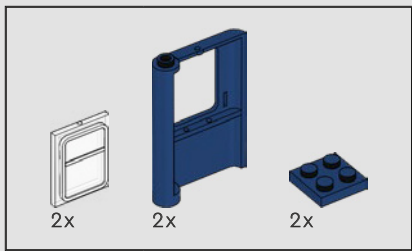

53

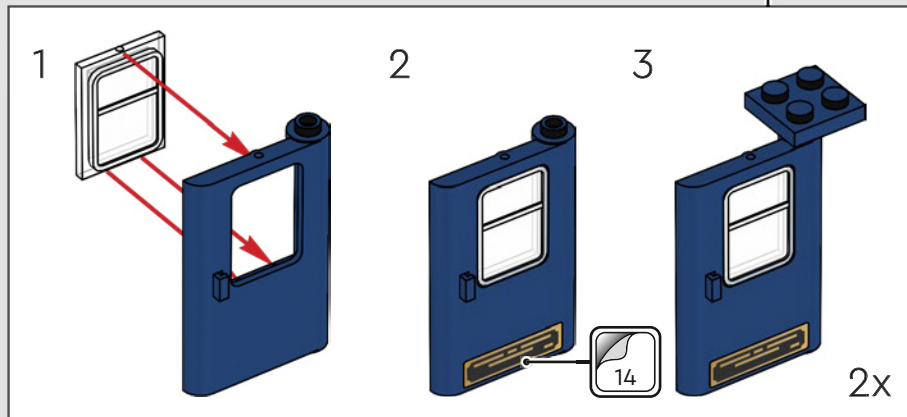
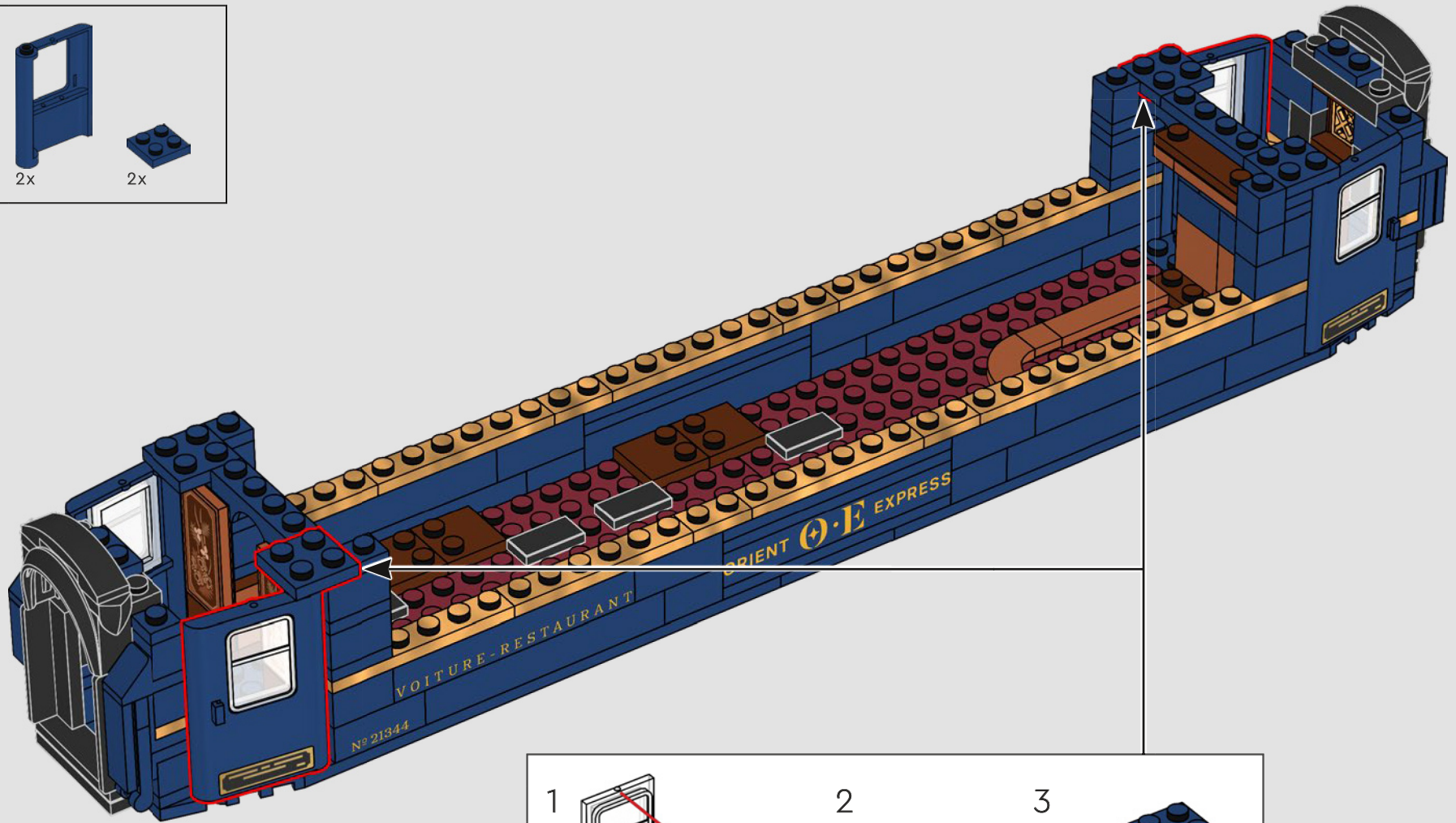

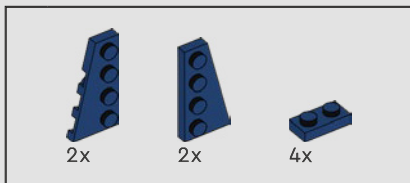

54

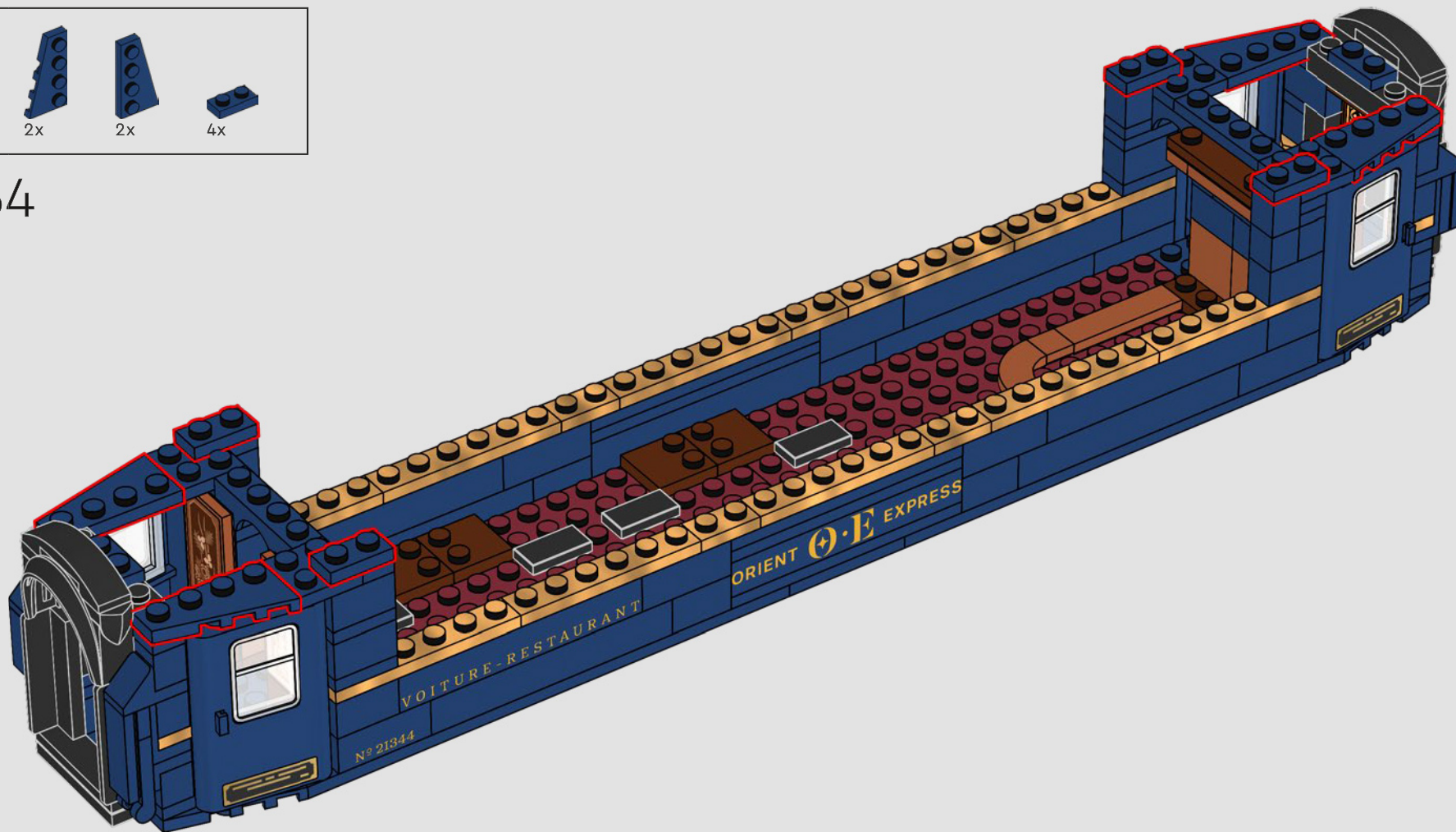

..... ●
"Cada puerta lleva una placa de latón que identifica a su fabricante como distintivo de calidad".

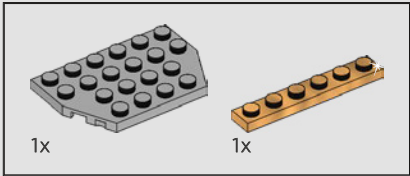
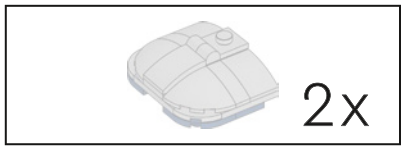

55

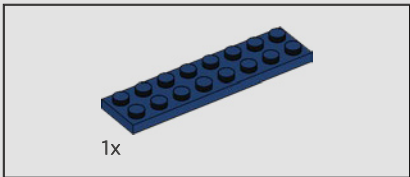
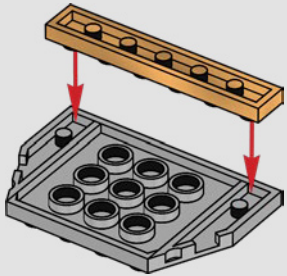

56

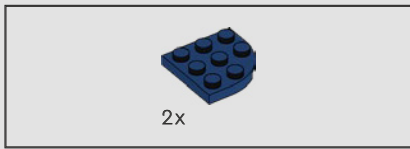
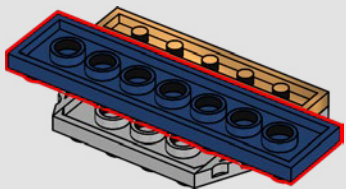

57

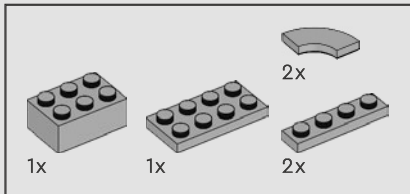
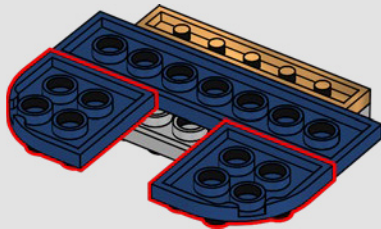

58

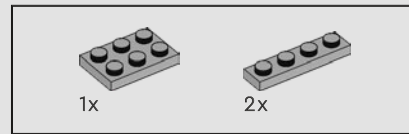
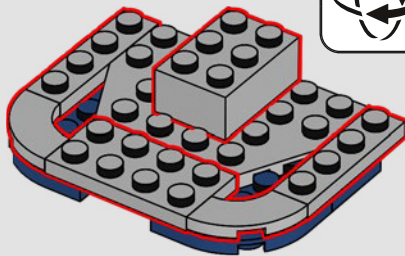

59

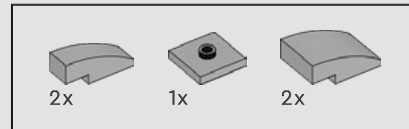
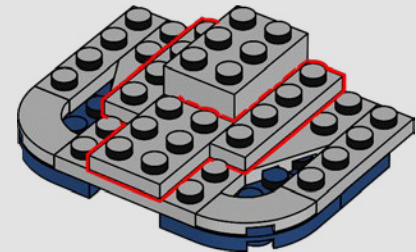

60

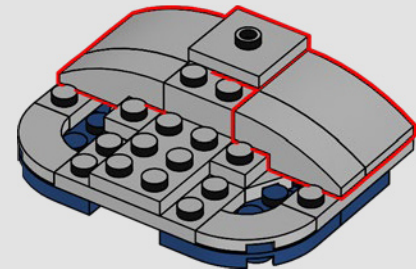

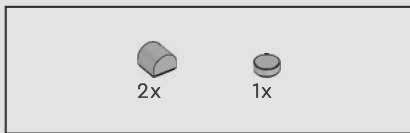

61

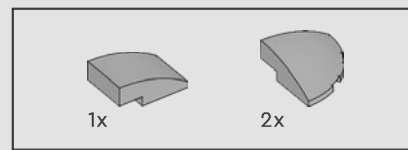
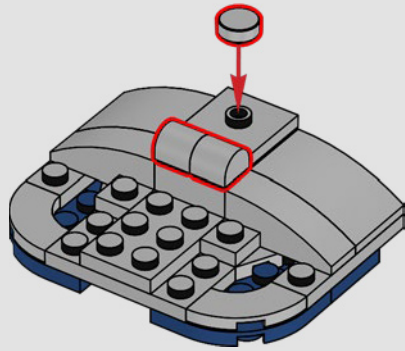

62

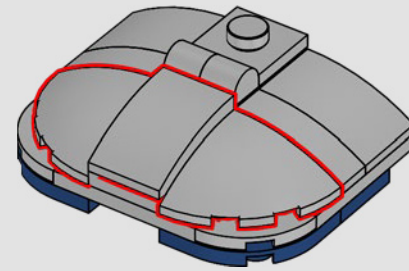

2x

63

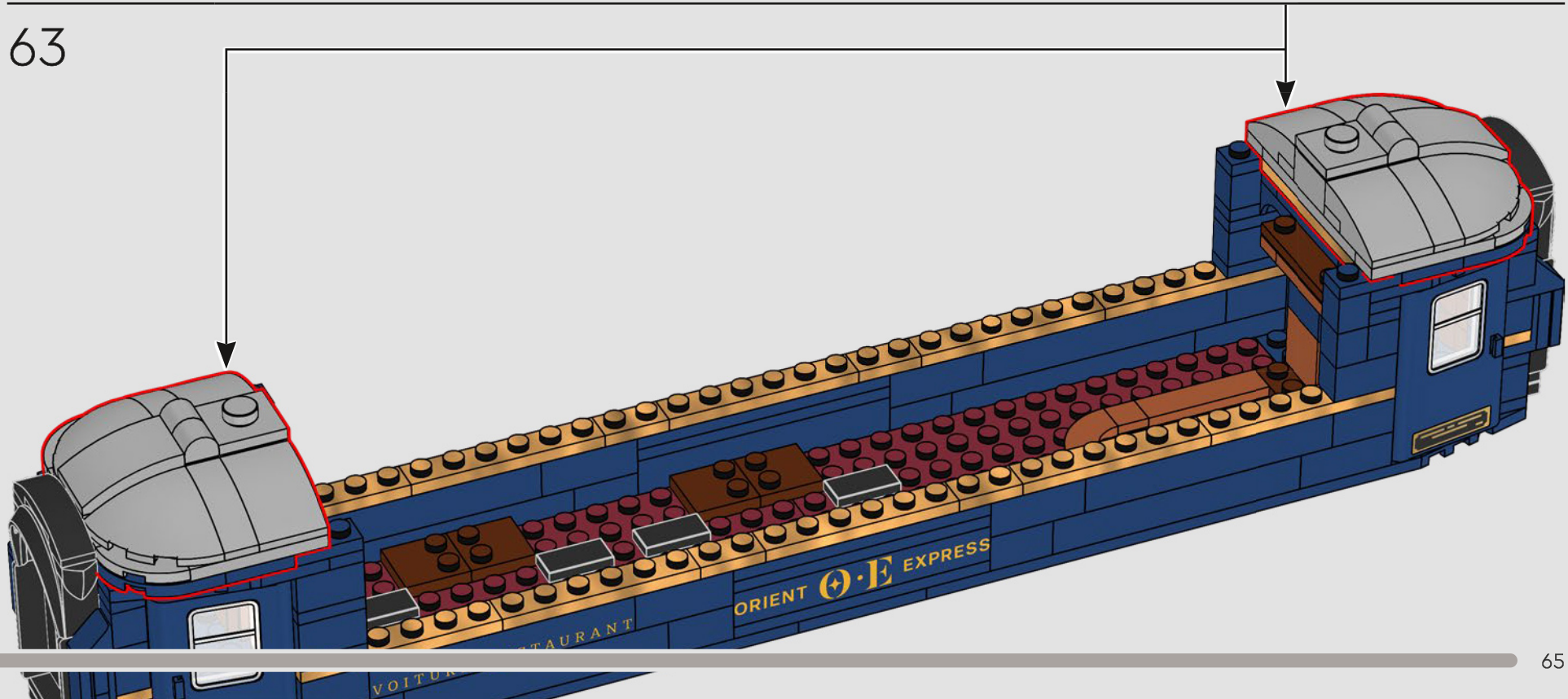

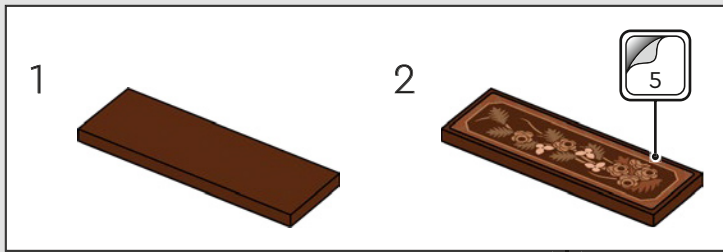
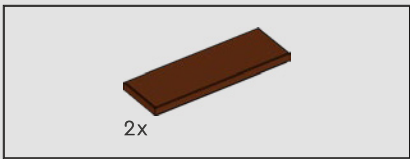

64

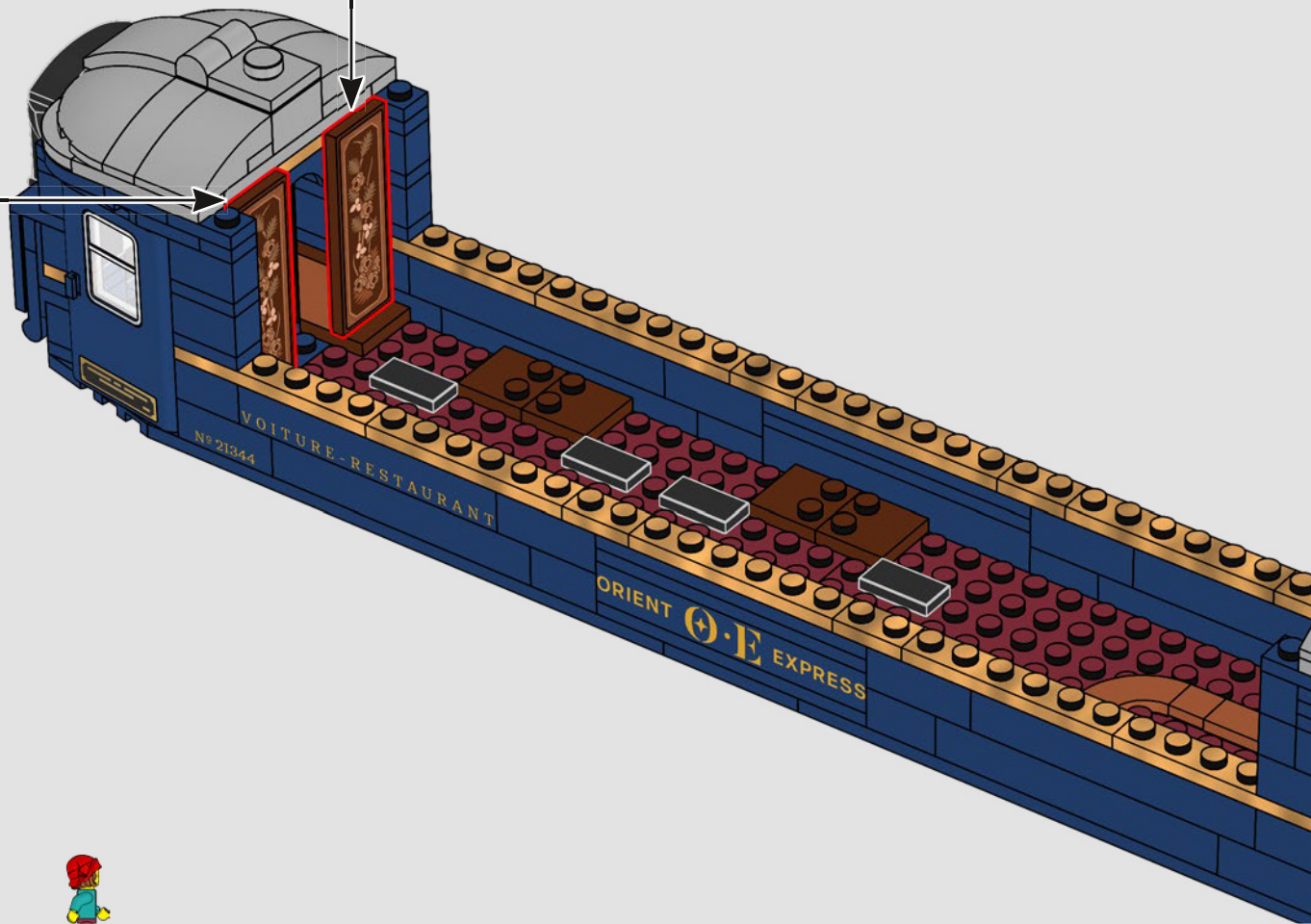
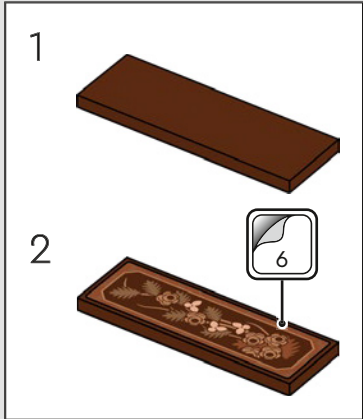

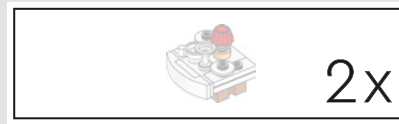
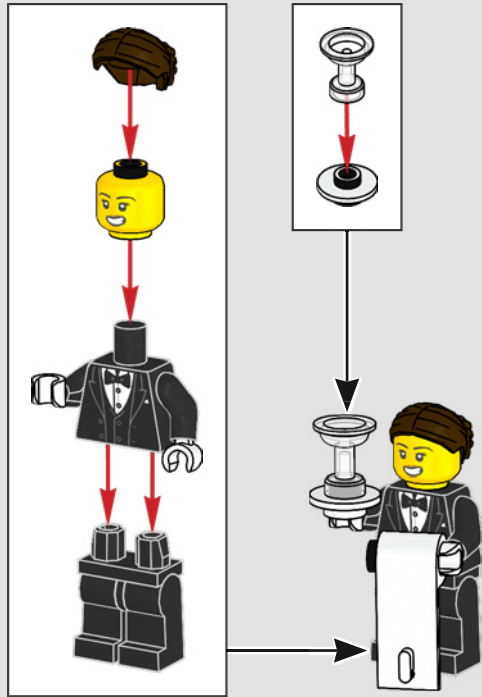

65

1

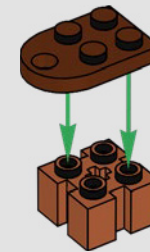

Próxima parada: MÚNICH
 "El servicio de a bordo cuenta con camareros y un vagón restaurante".

2



3

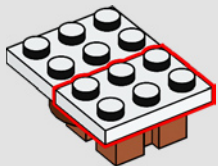

4

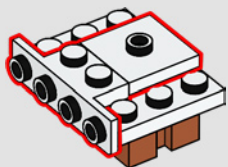

5

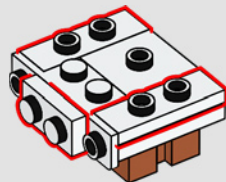

6

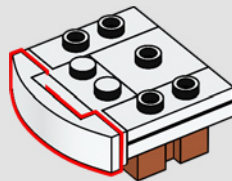

7

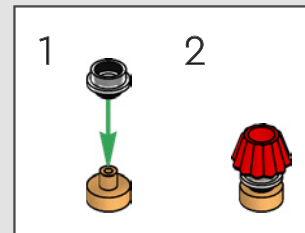
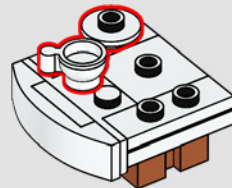

8



9

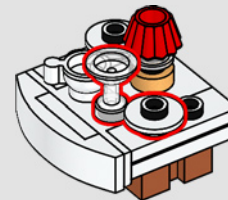

2x



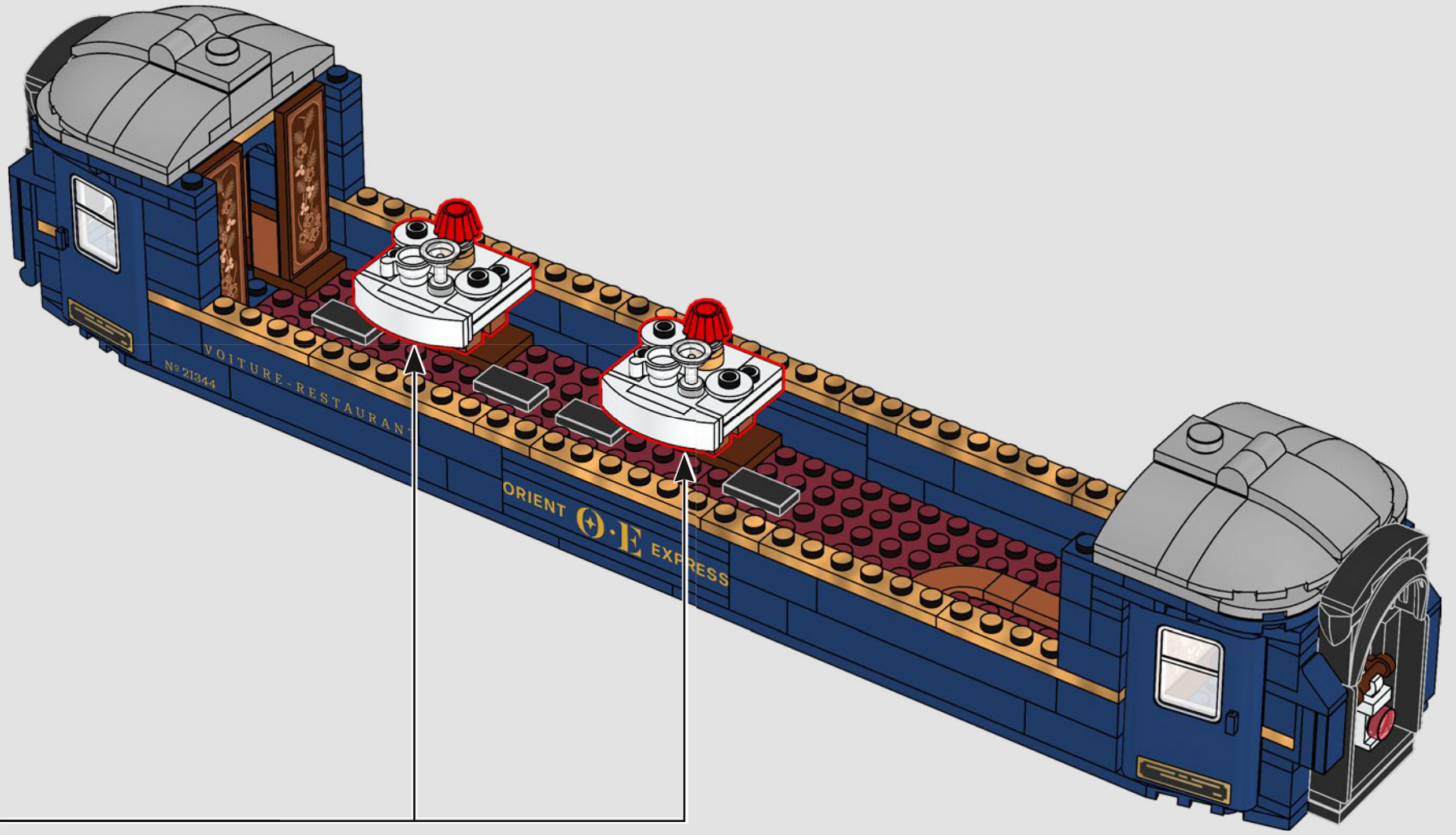

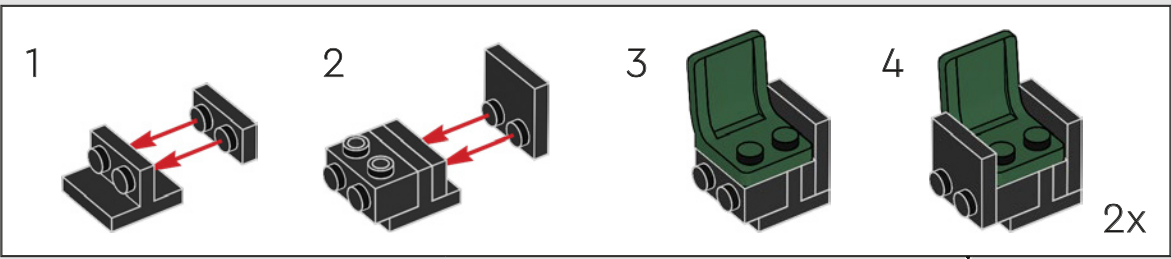
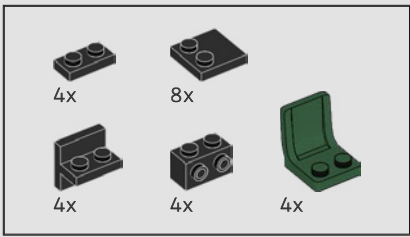

66

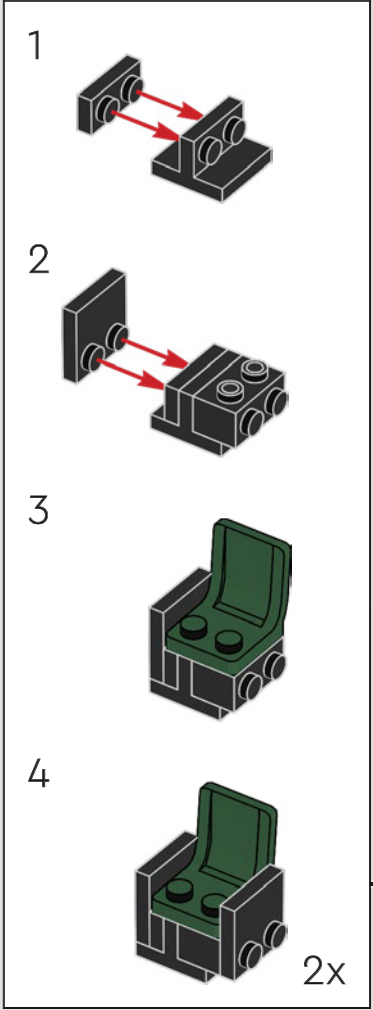

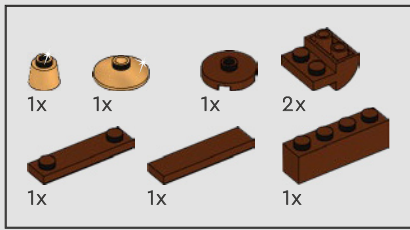

67

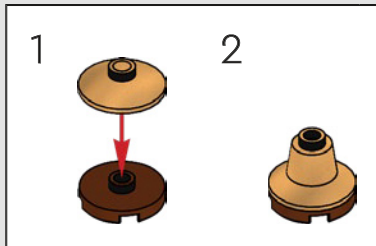
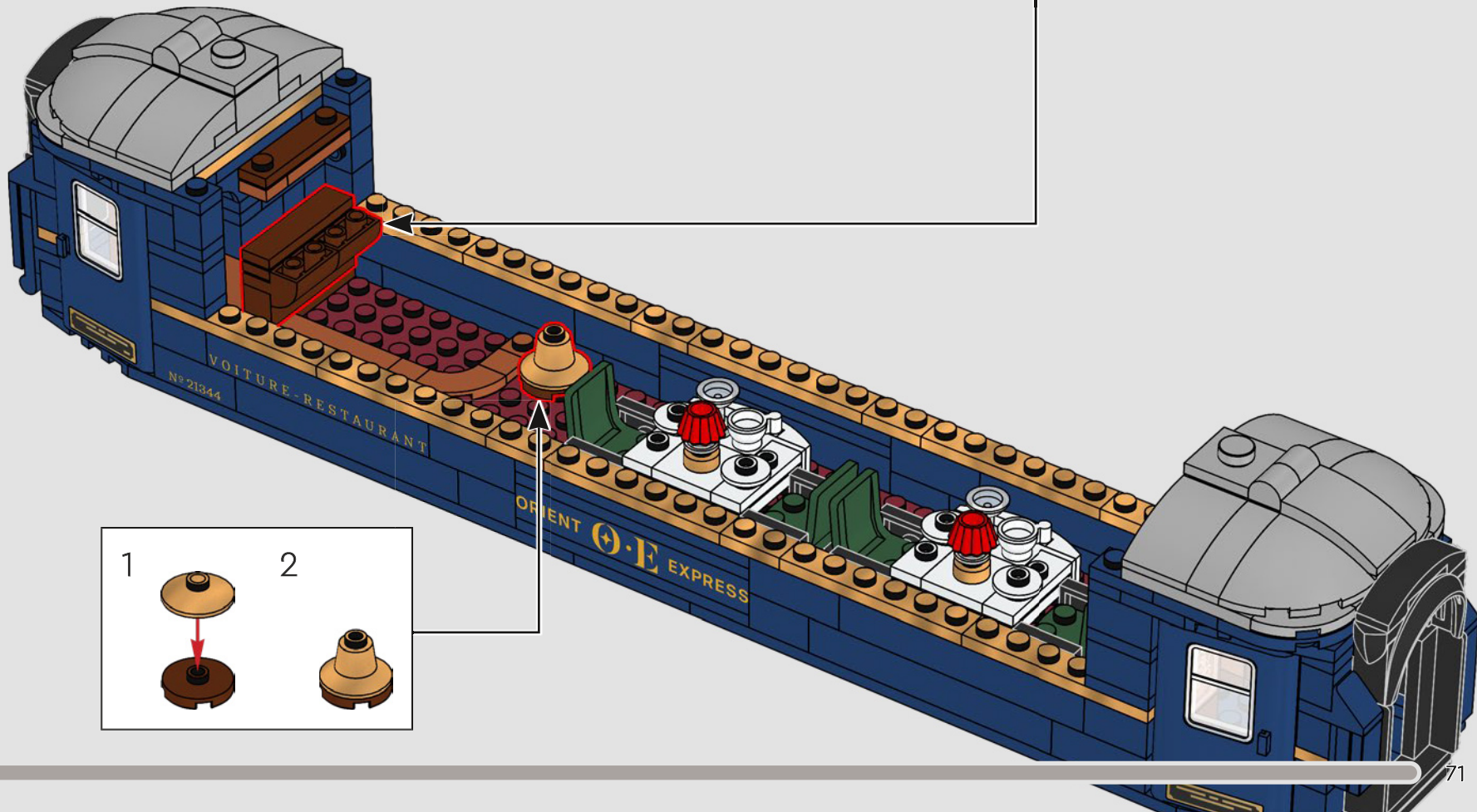
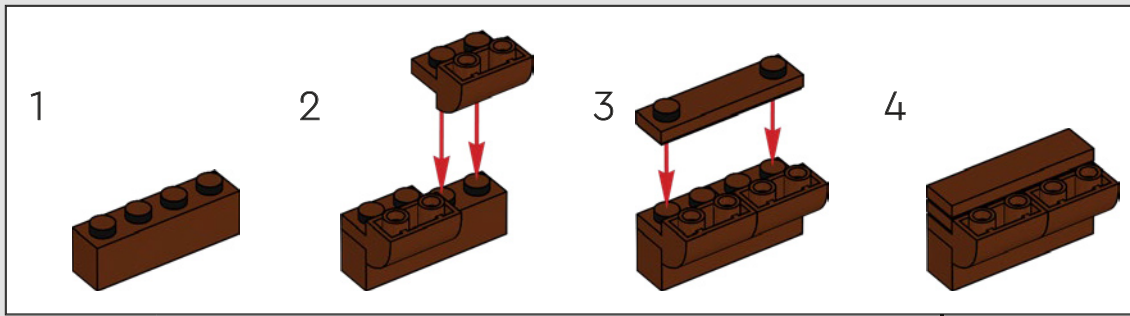

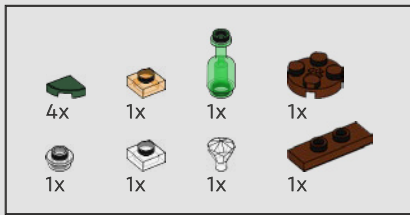

69

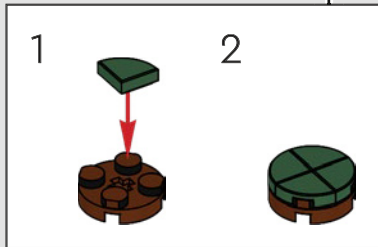
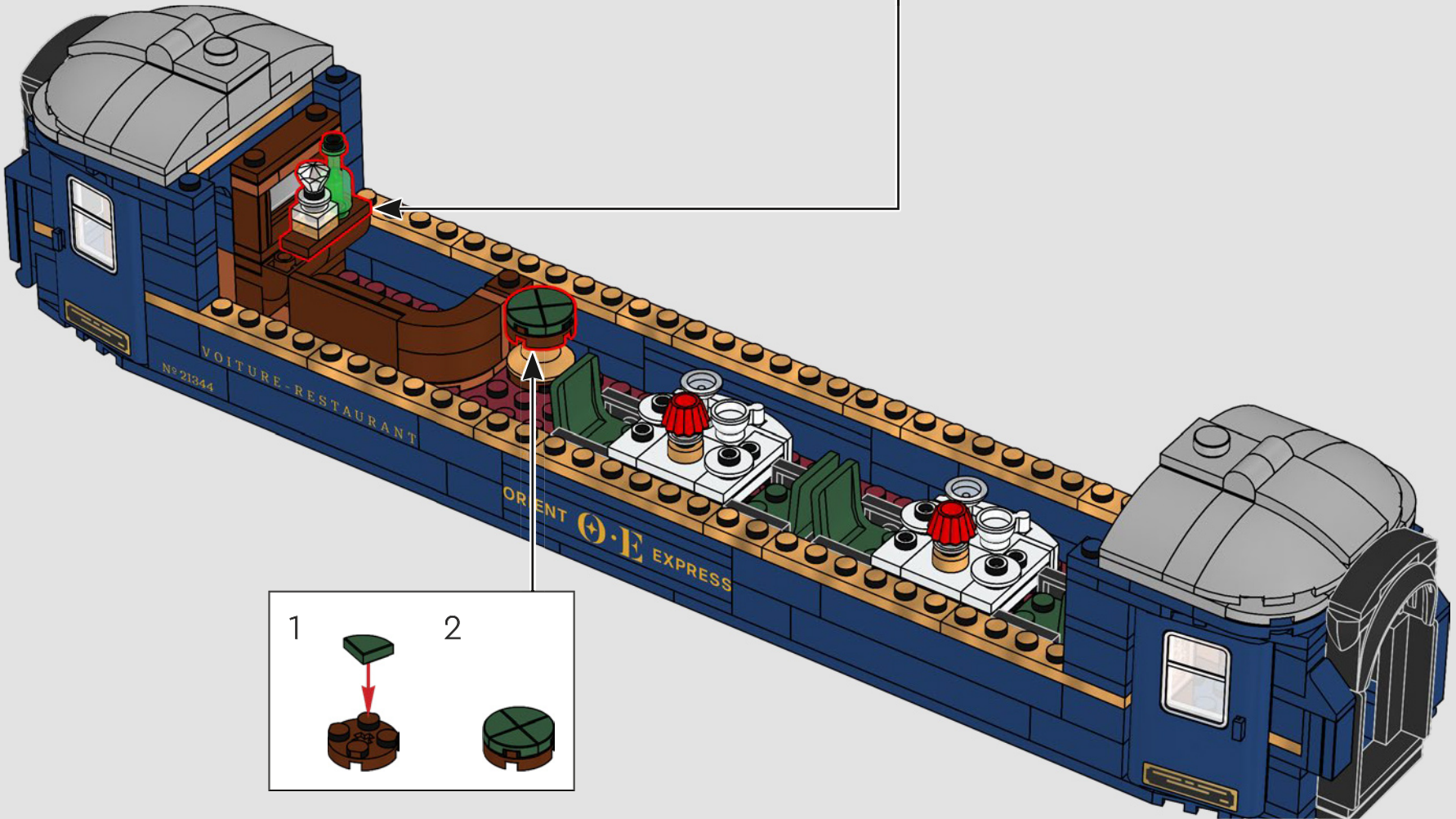
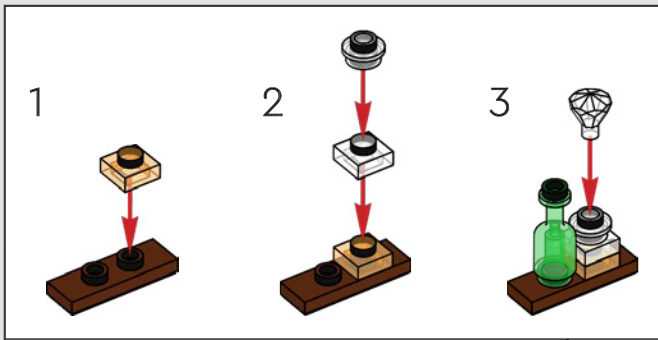

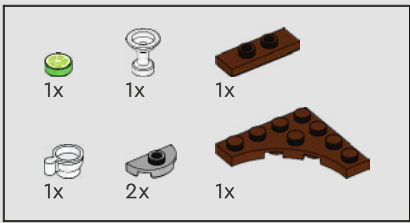

70

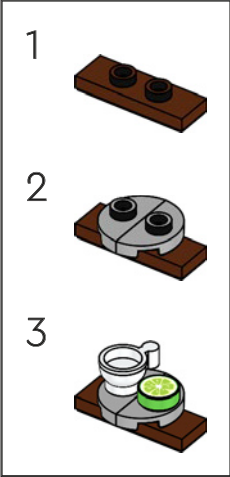
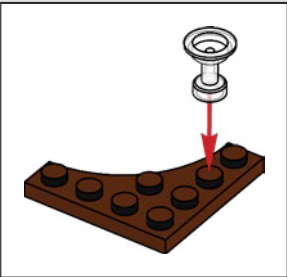

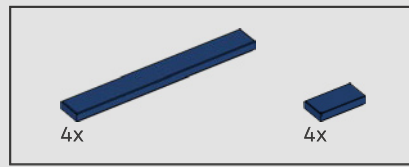

71



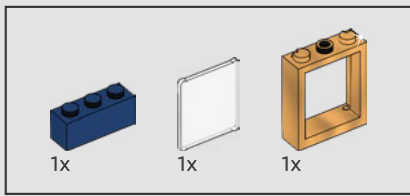

78

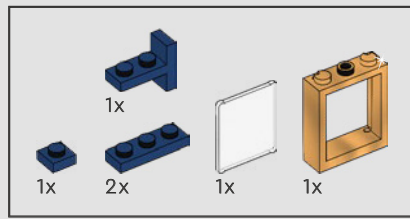
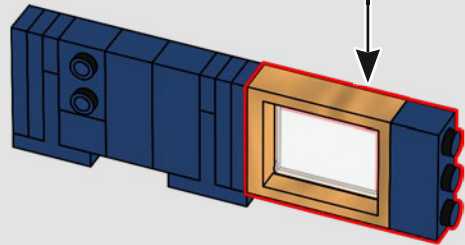
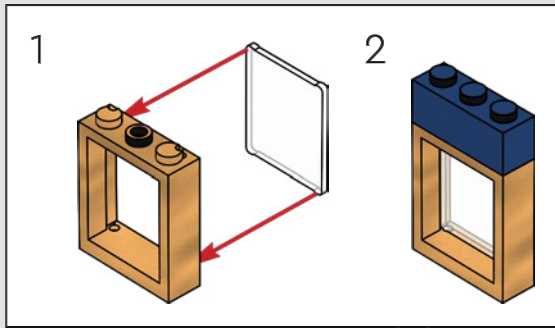

79

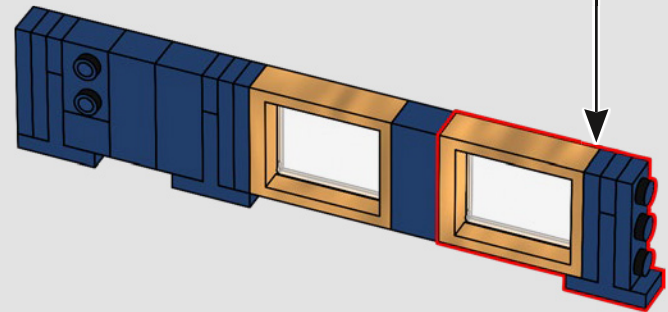
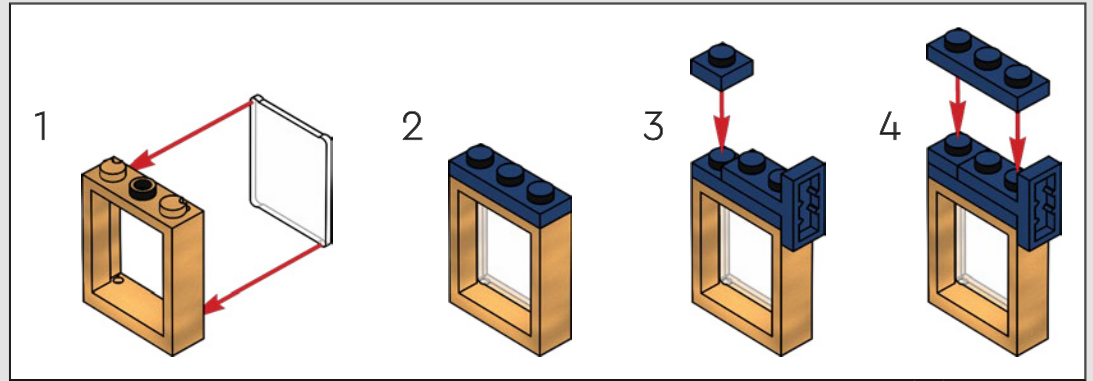

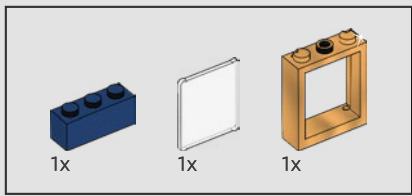

80

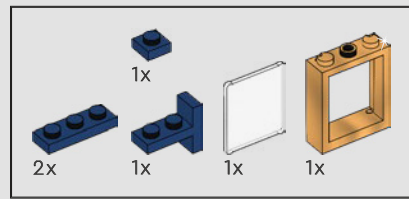
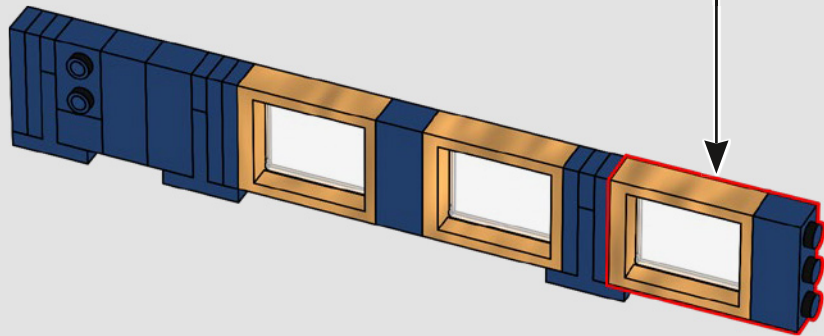
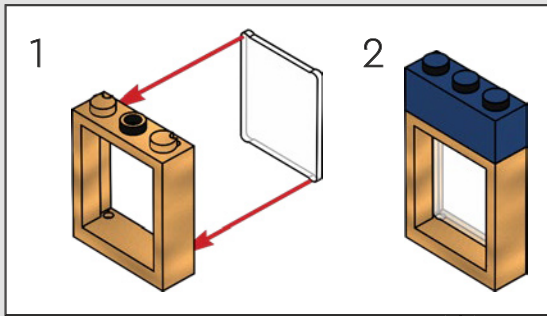

81

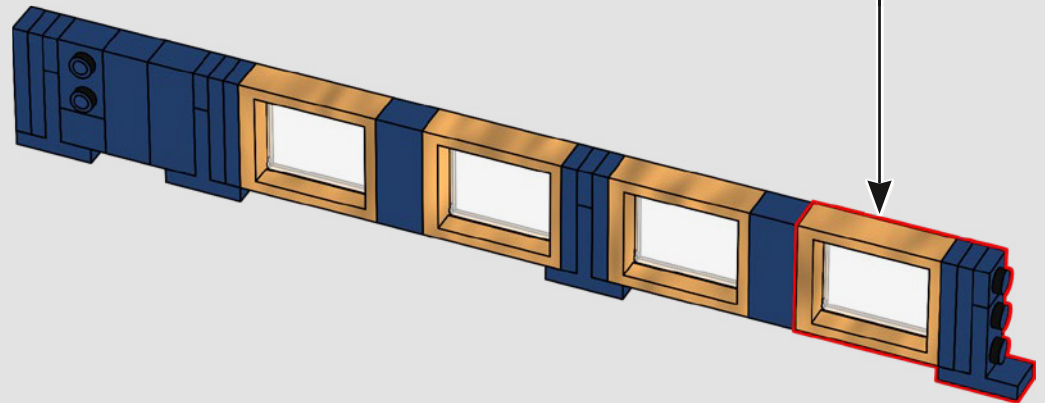
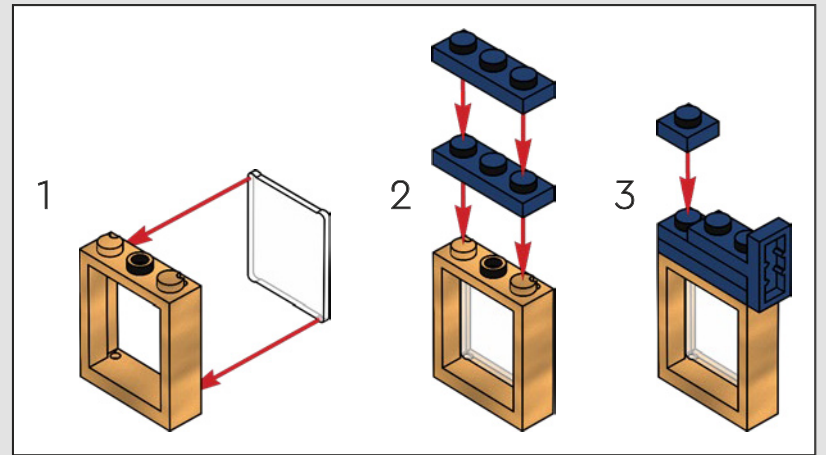

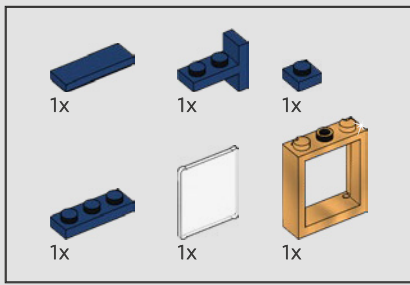

82

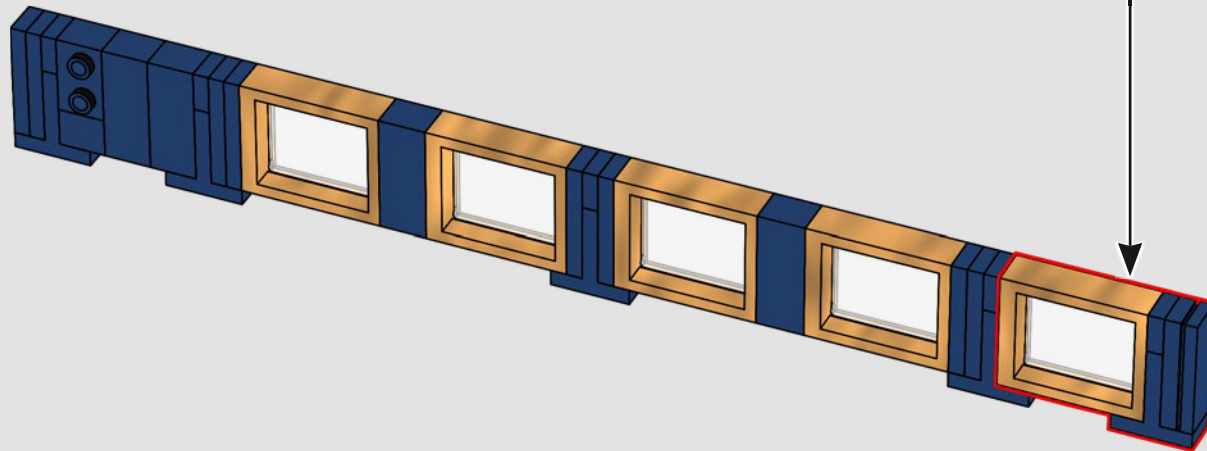
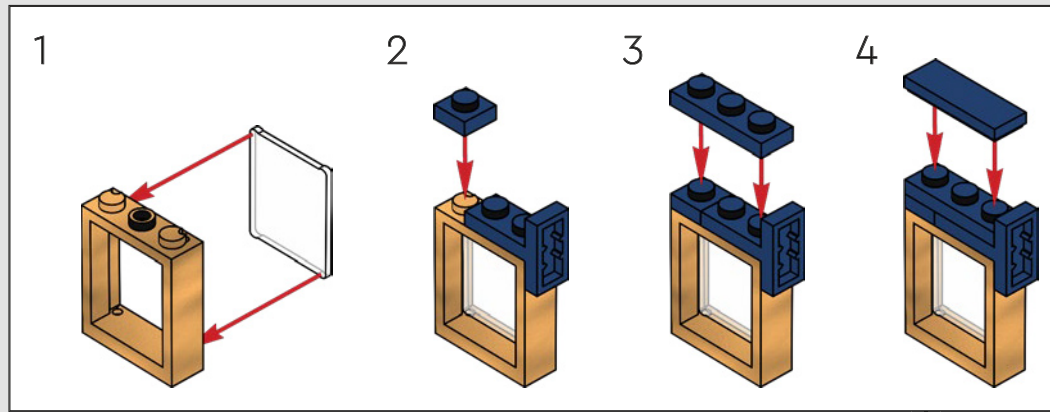

83

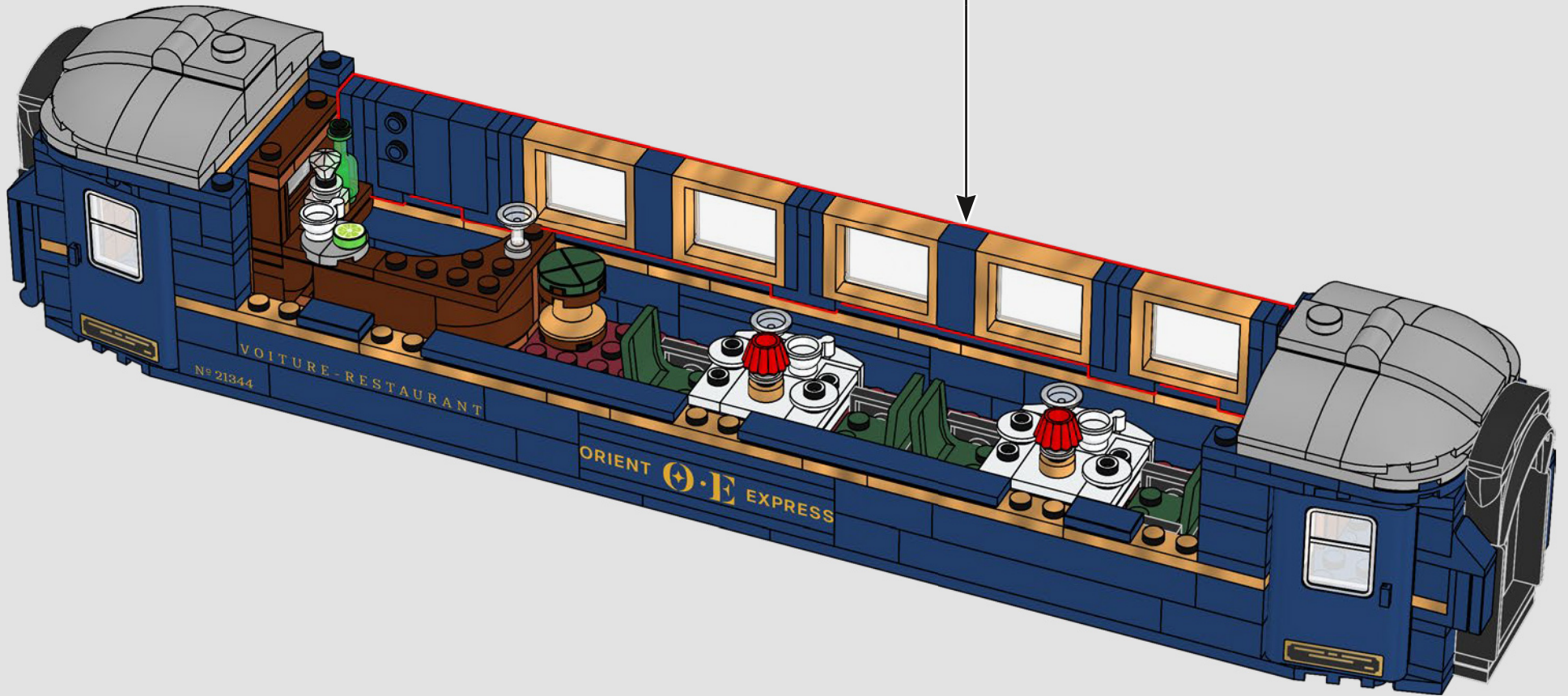

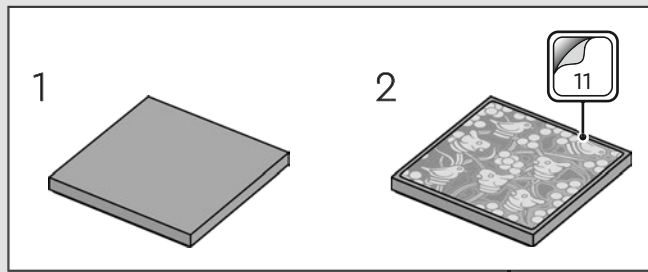
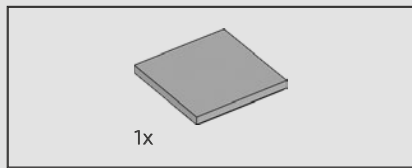

84

“El interior de este vagón está adornado con exquisitos espejos de cristal tallado”.

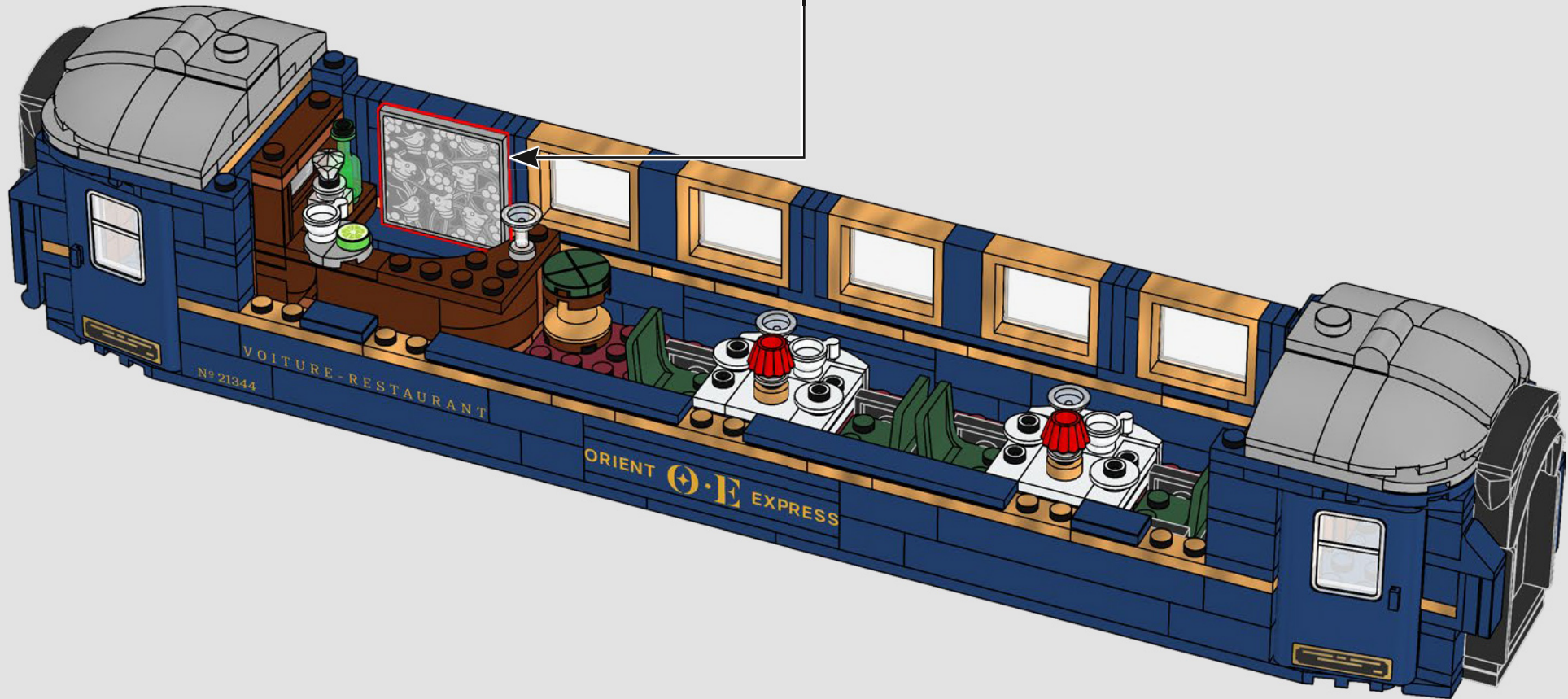

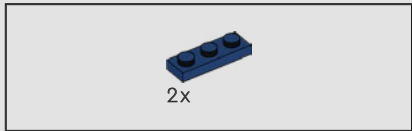
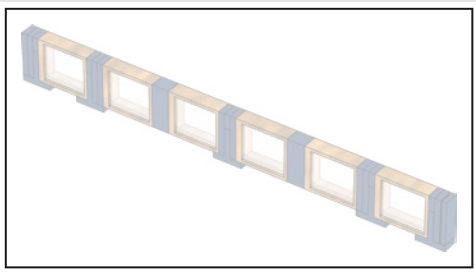

85

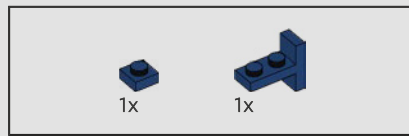
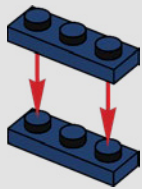

86

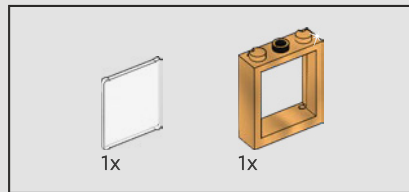
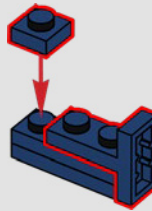

87

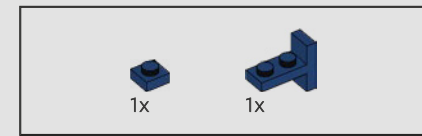
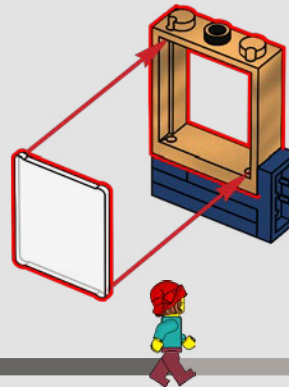

88

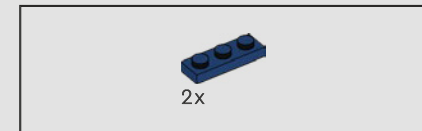
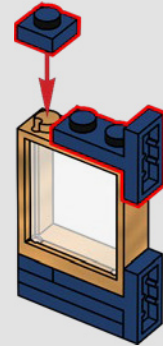

89

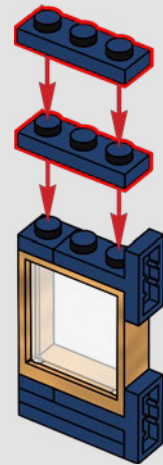

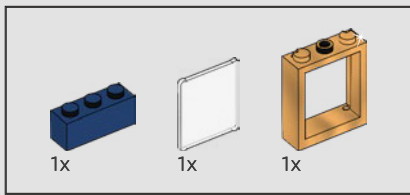

90

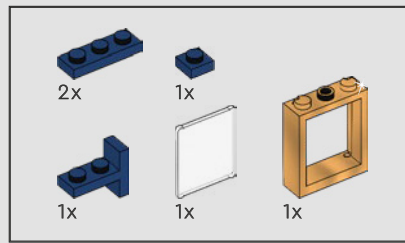
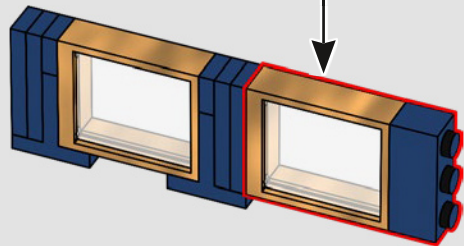
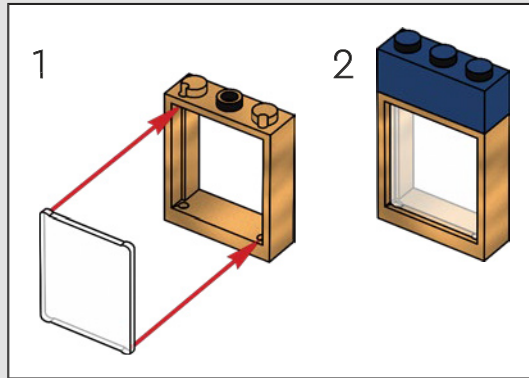

91

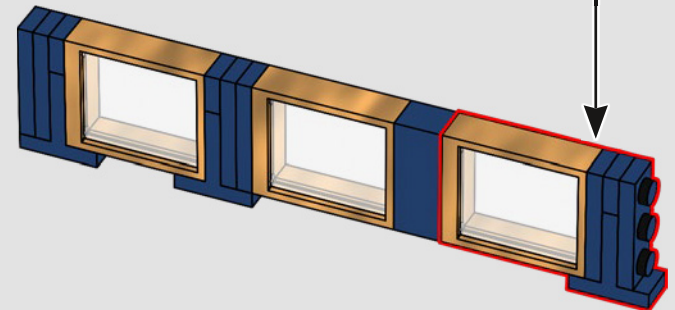
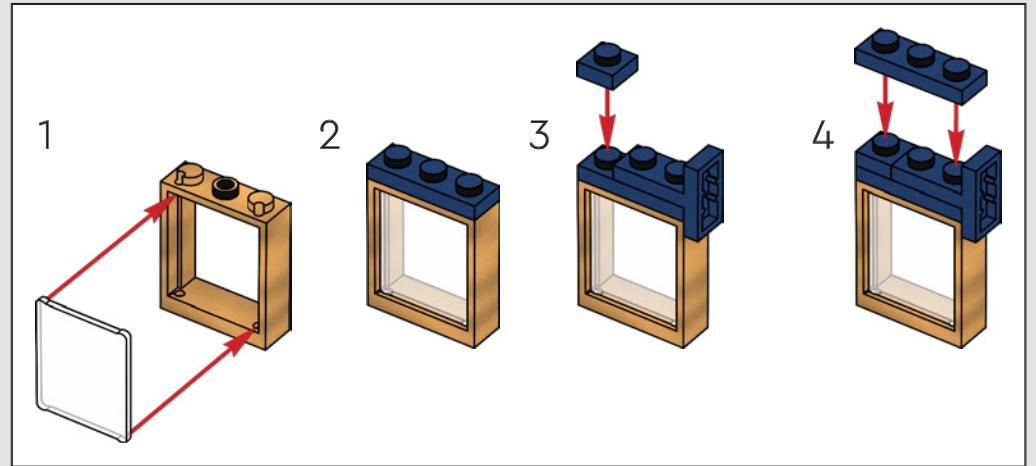

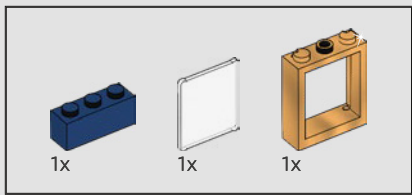

92

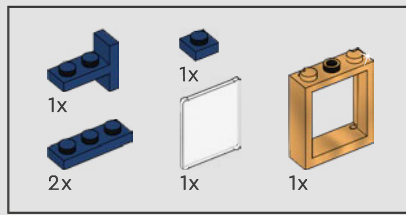
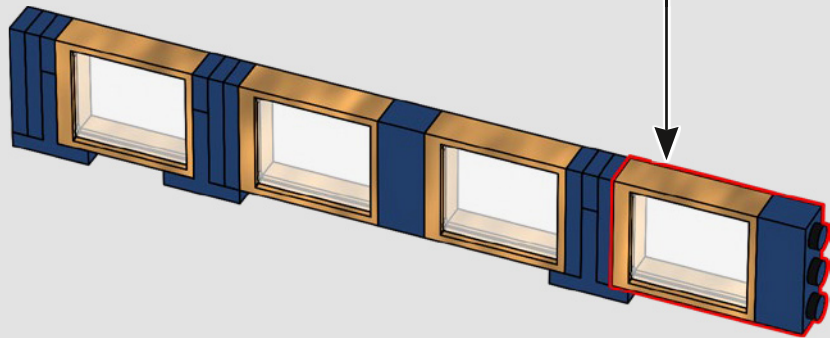
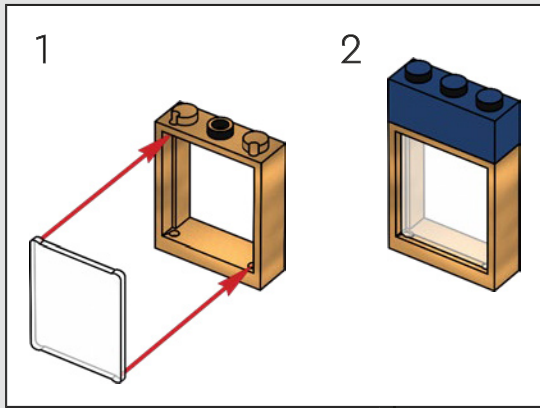

93

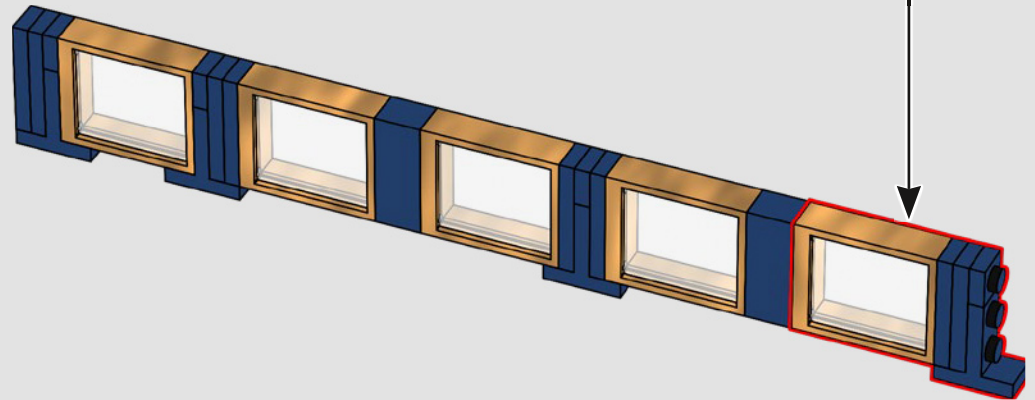
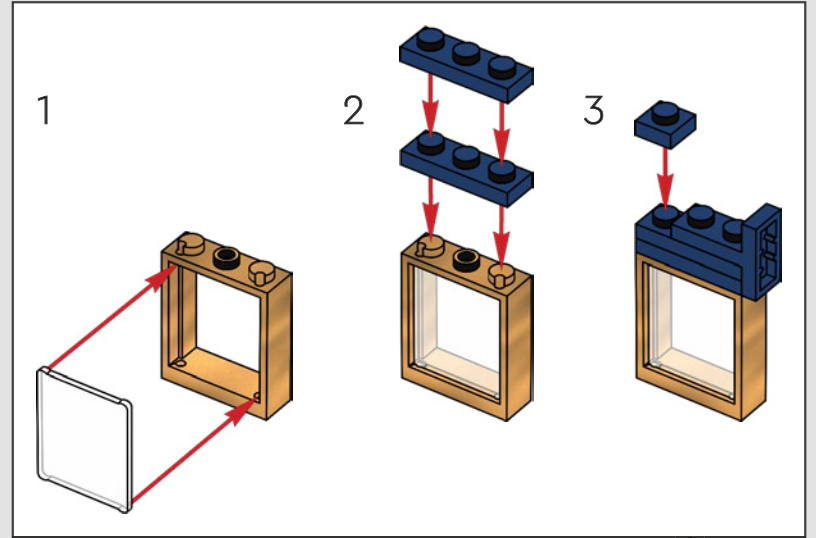

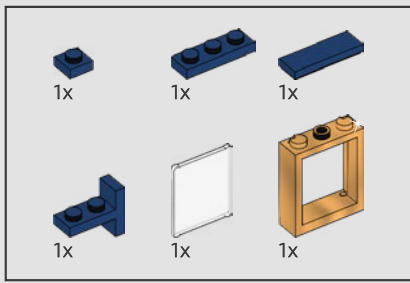

94

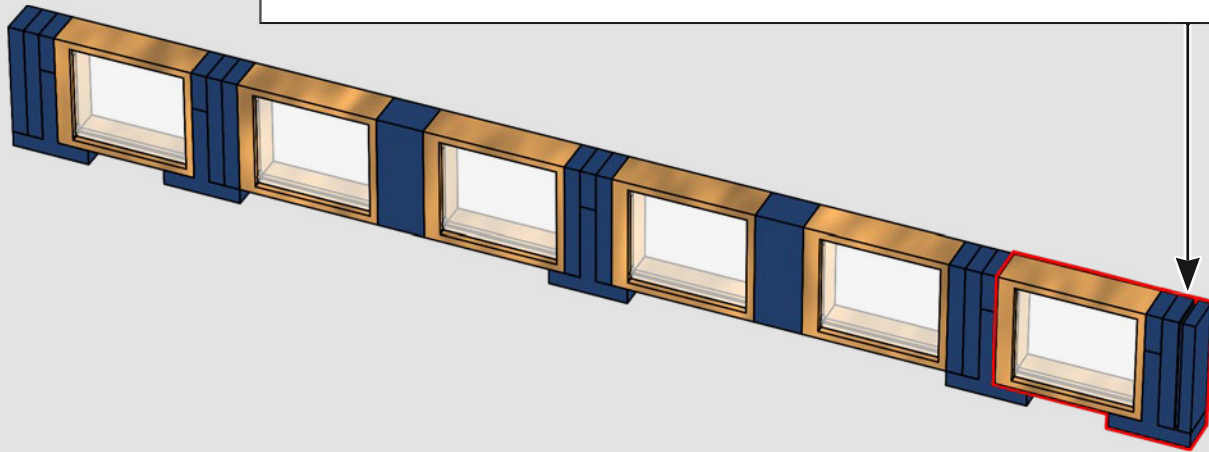
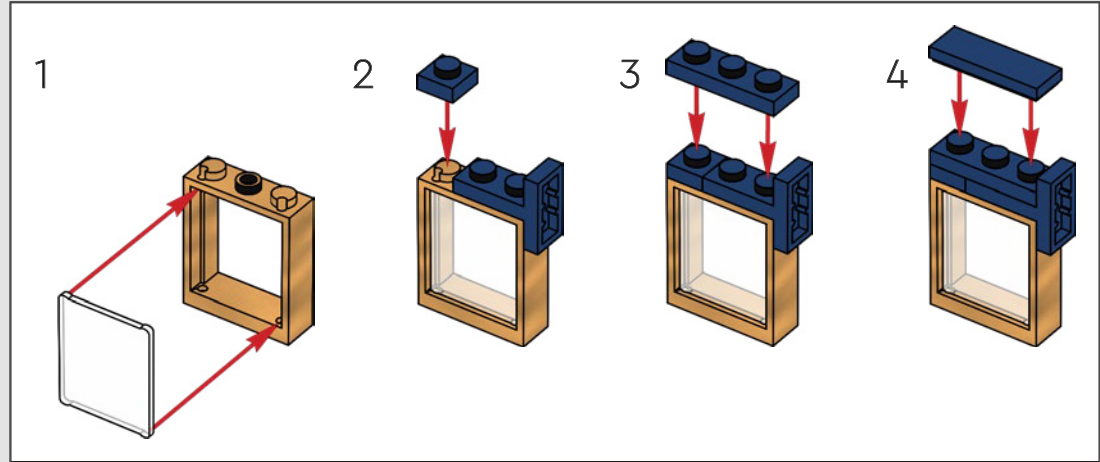



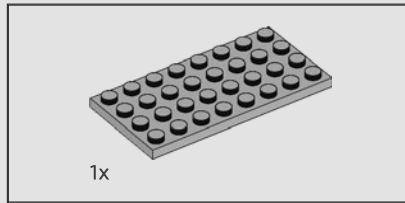
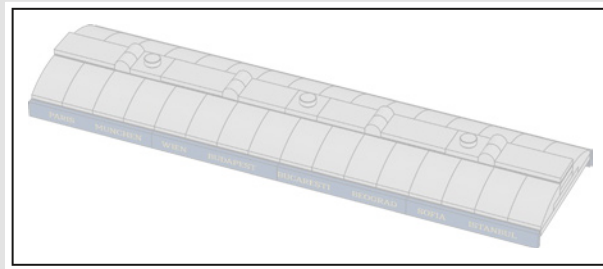

96

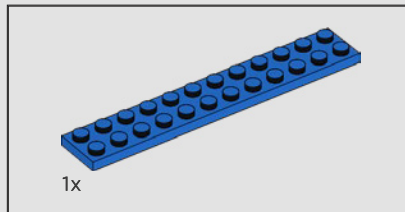
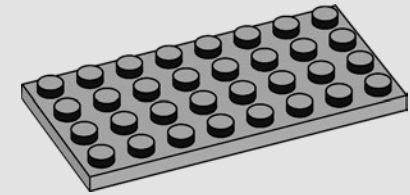

97

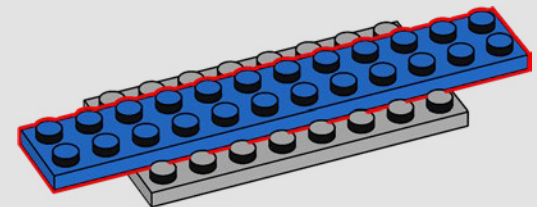

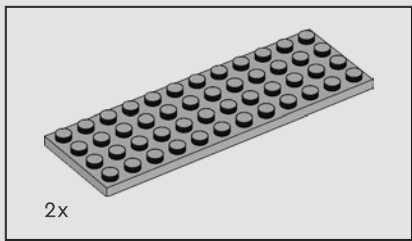

98

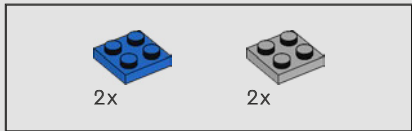
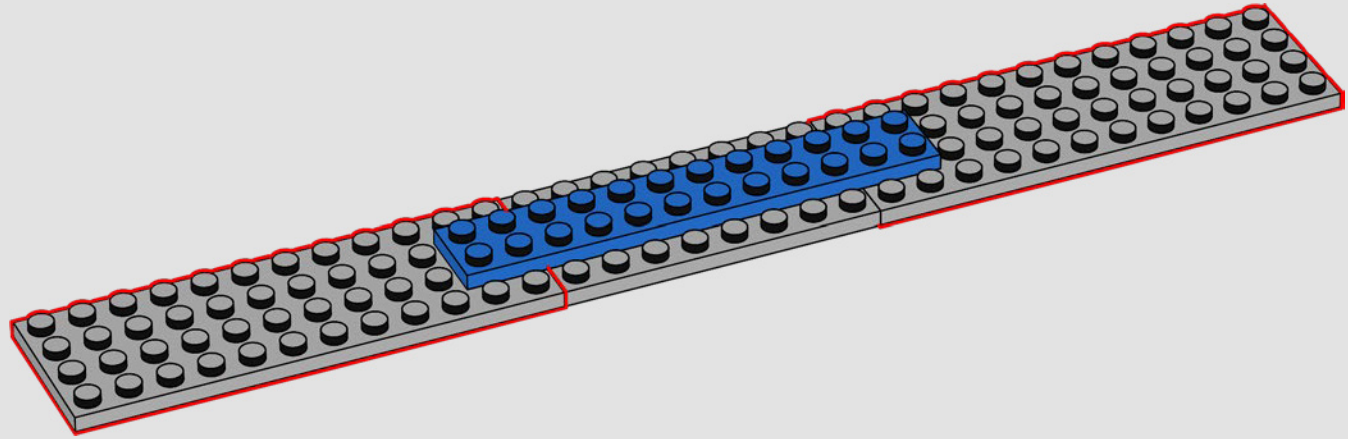

99

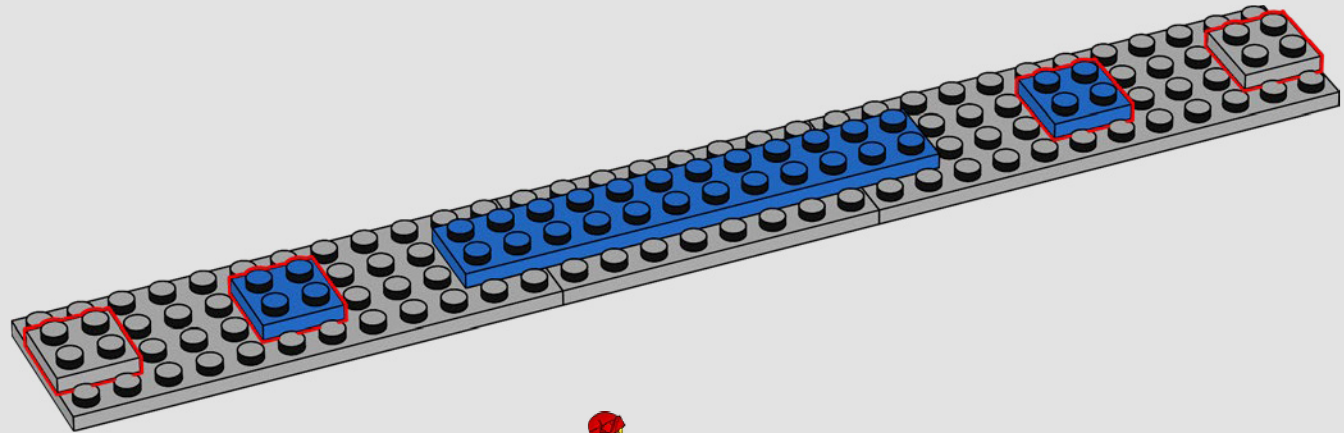

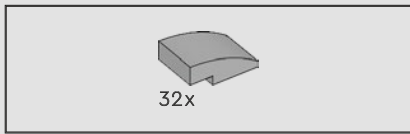

100

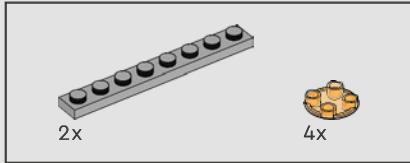
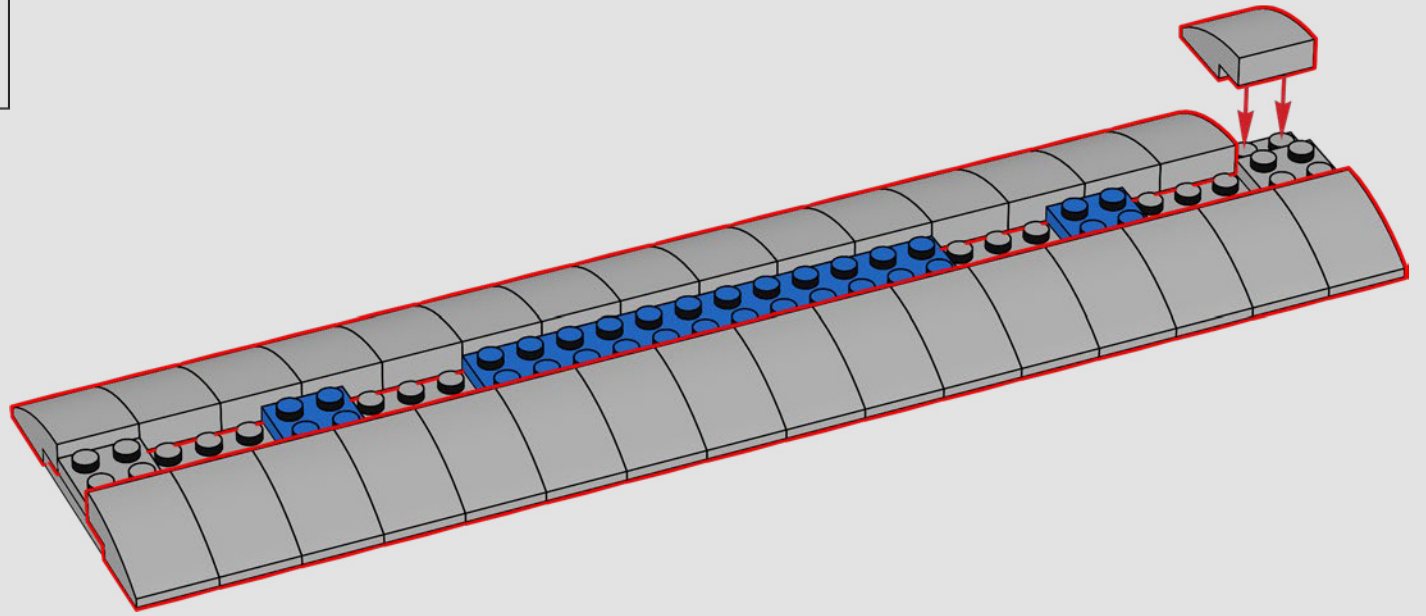

101

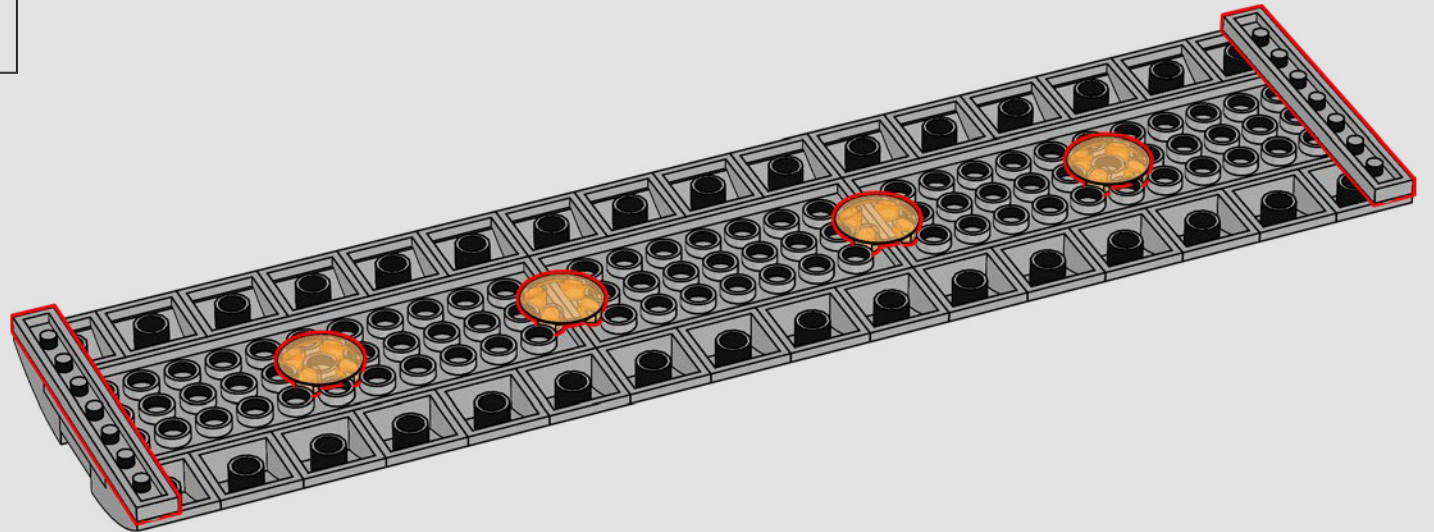

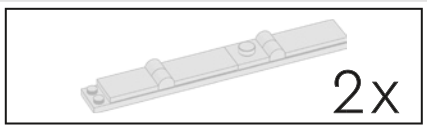

2x

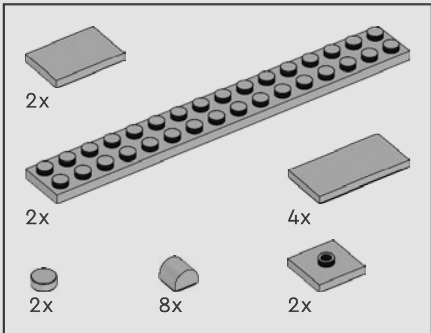

102

1

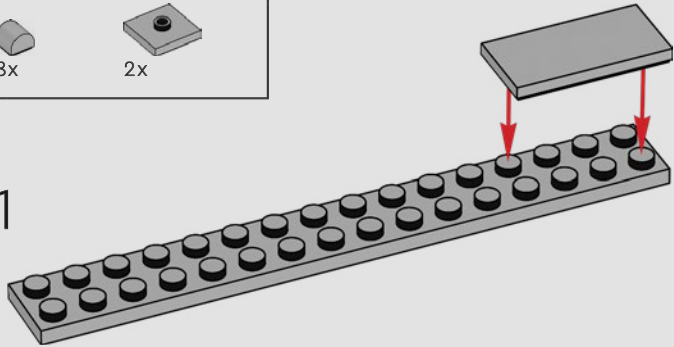

2

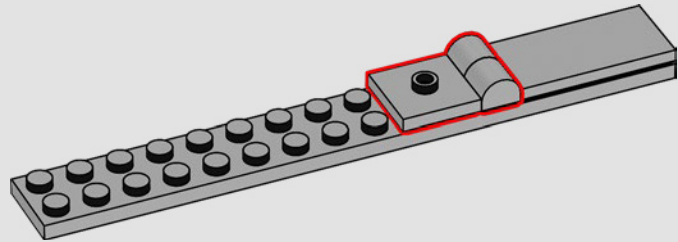

3

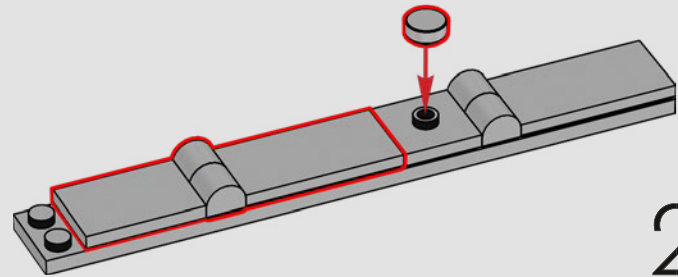

2x

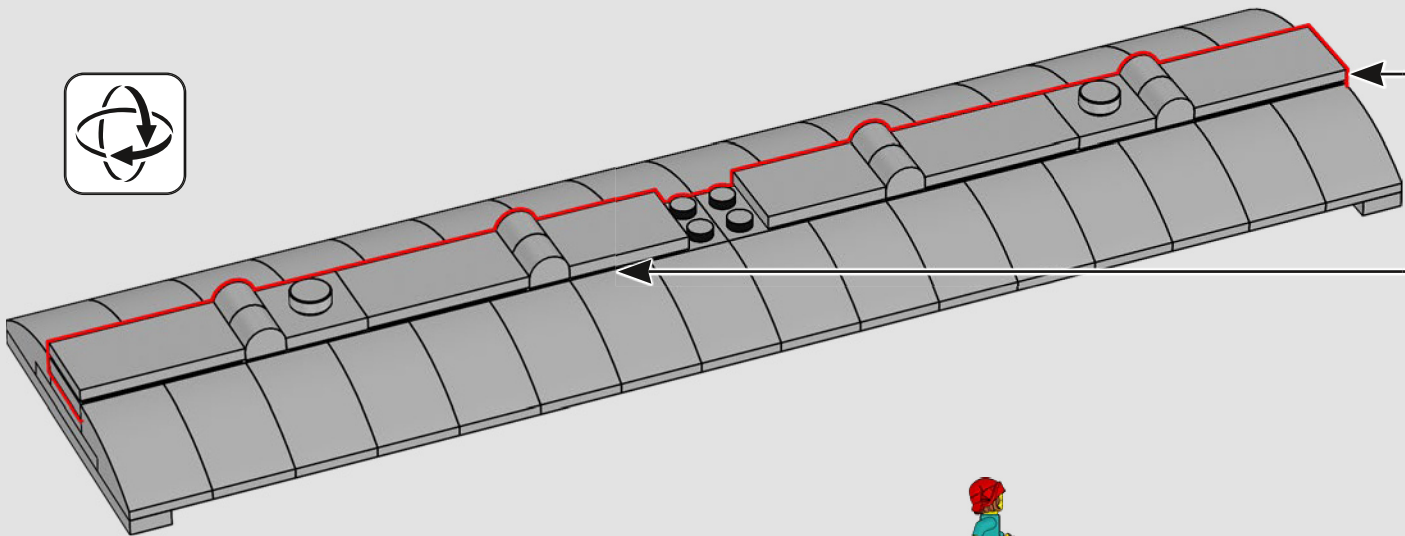

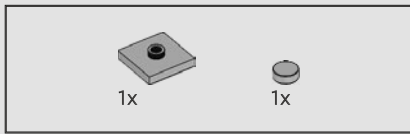

103

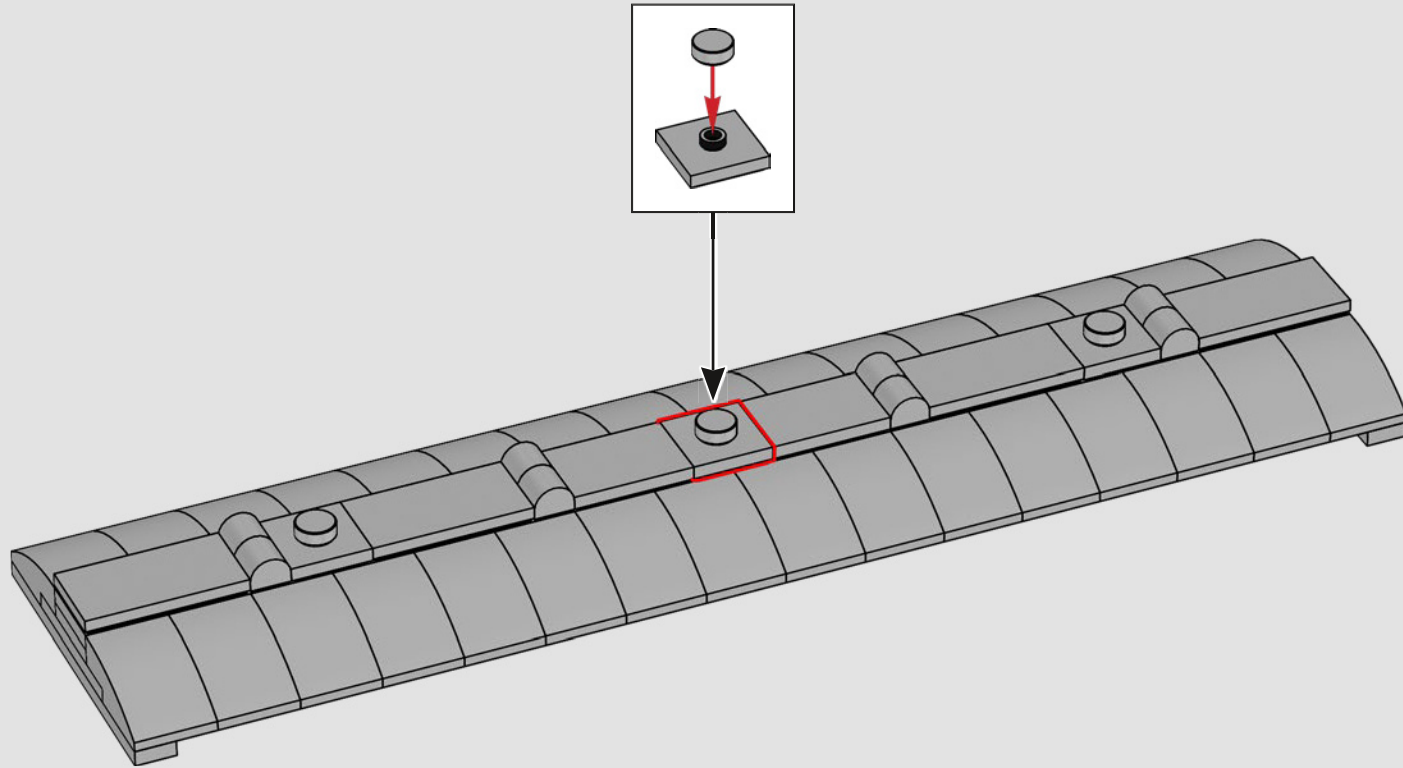

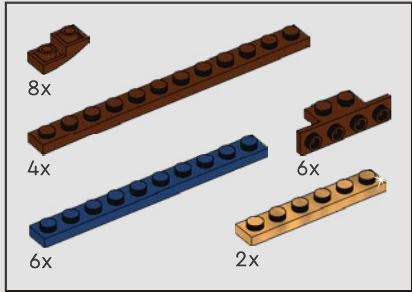
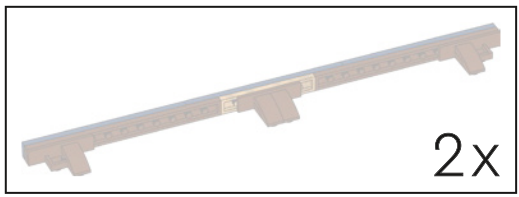

104

1

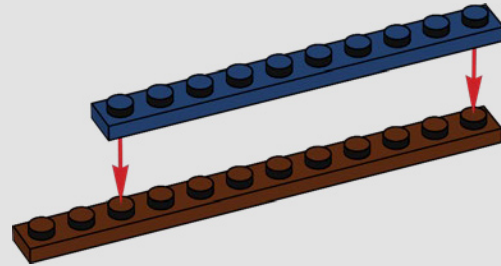

2

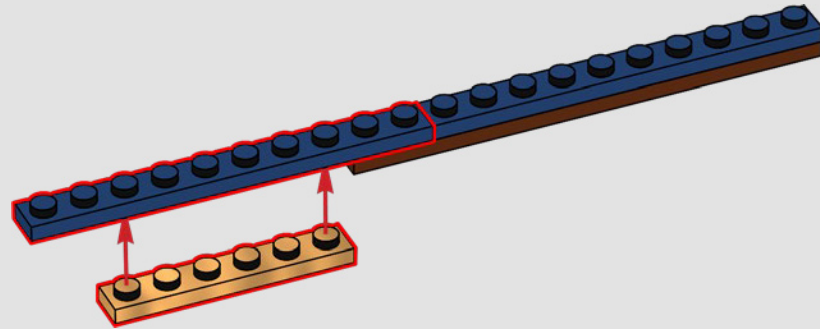

3

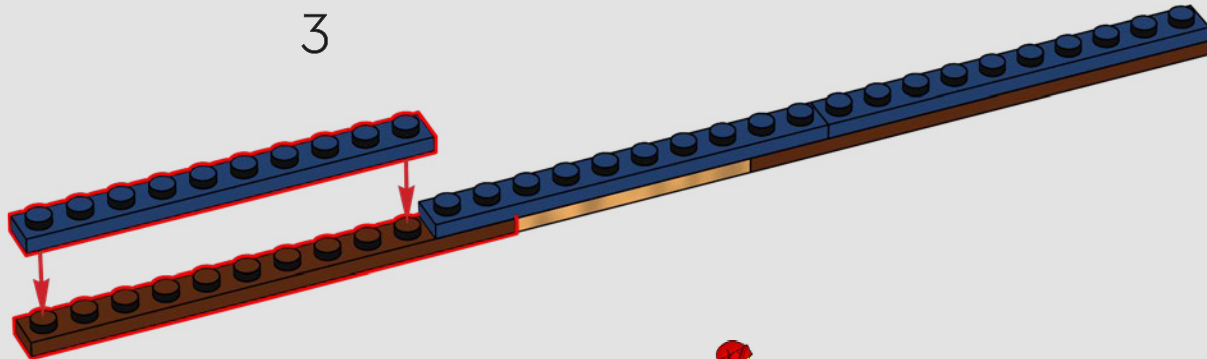

4

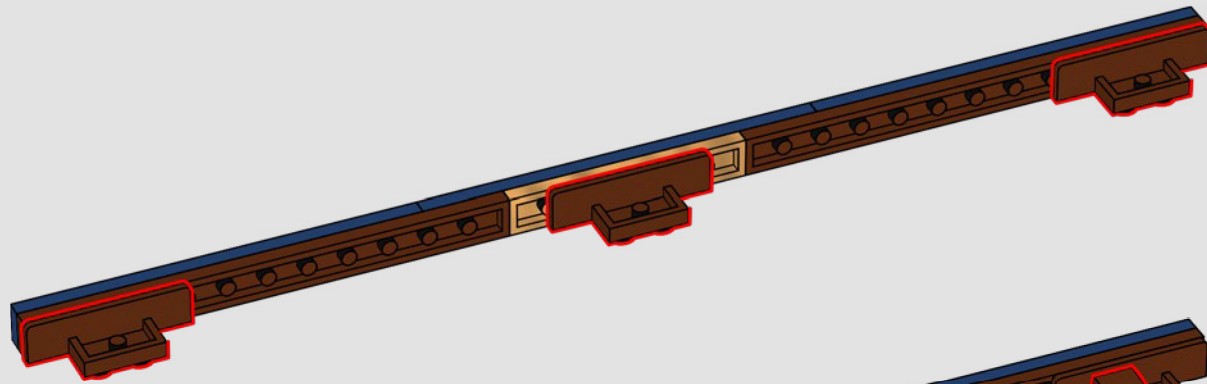

5

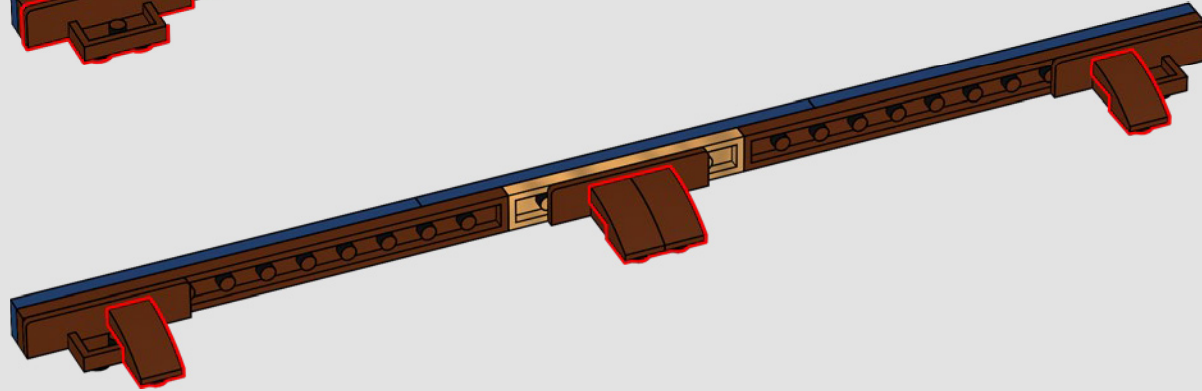

2x

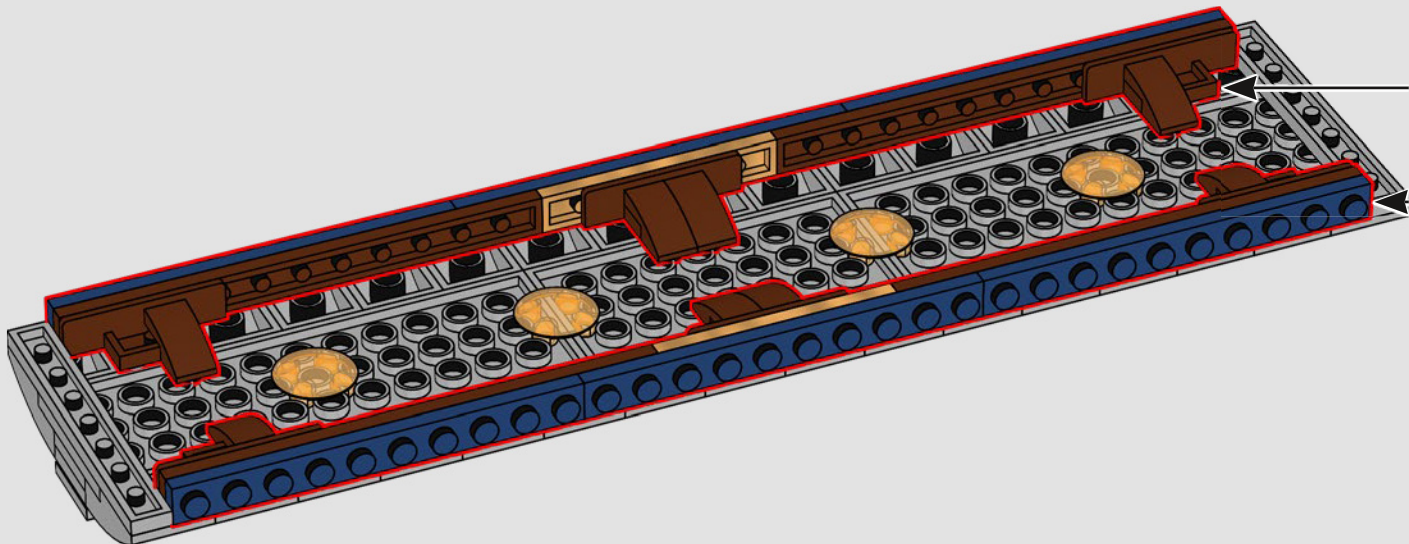

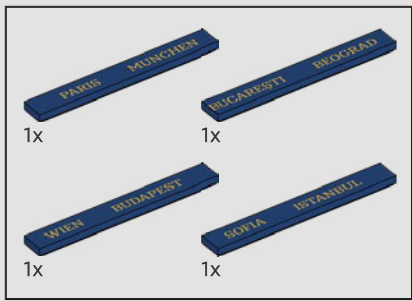

105

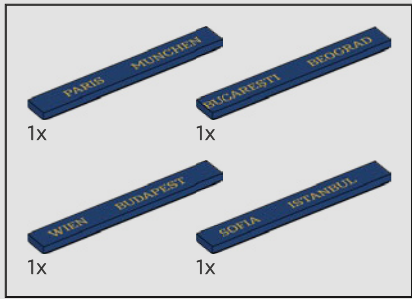
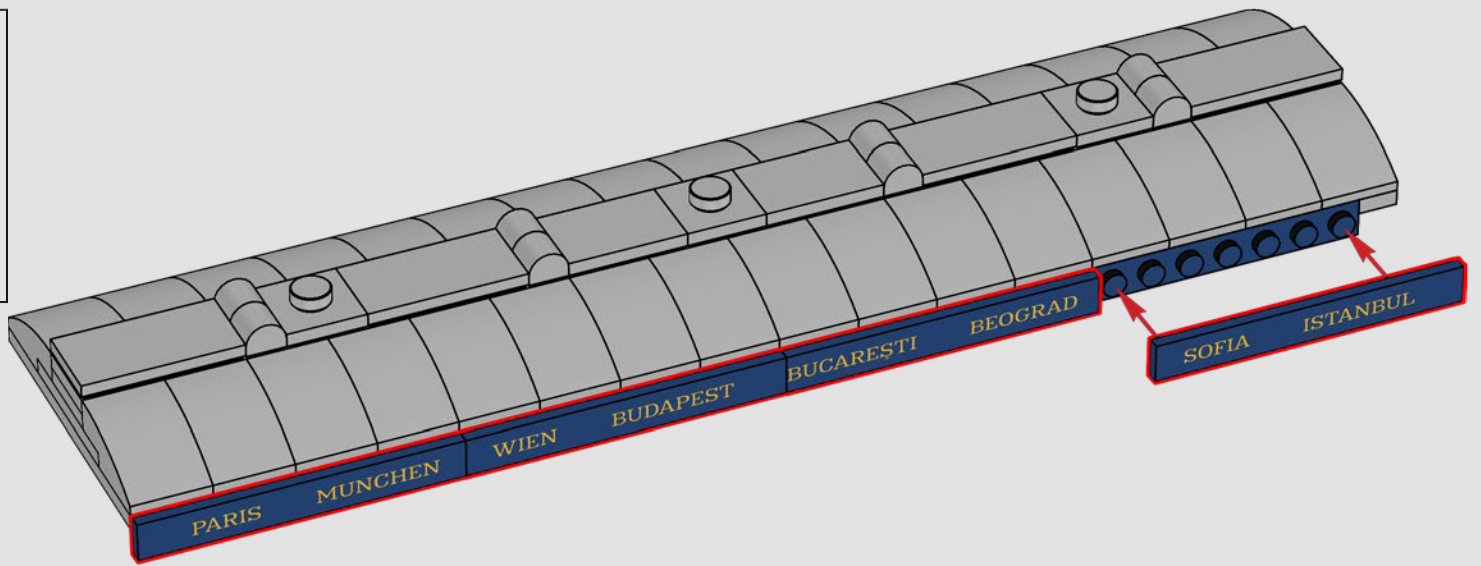

106

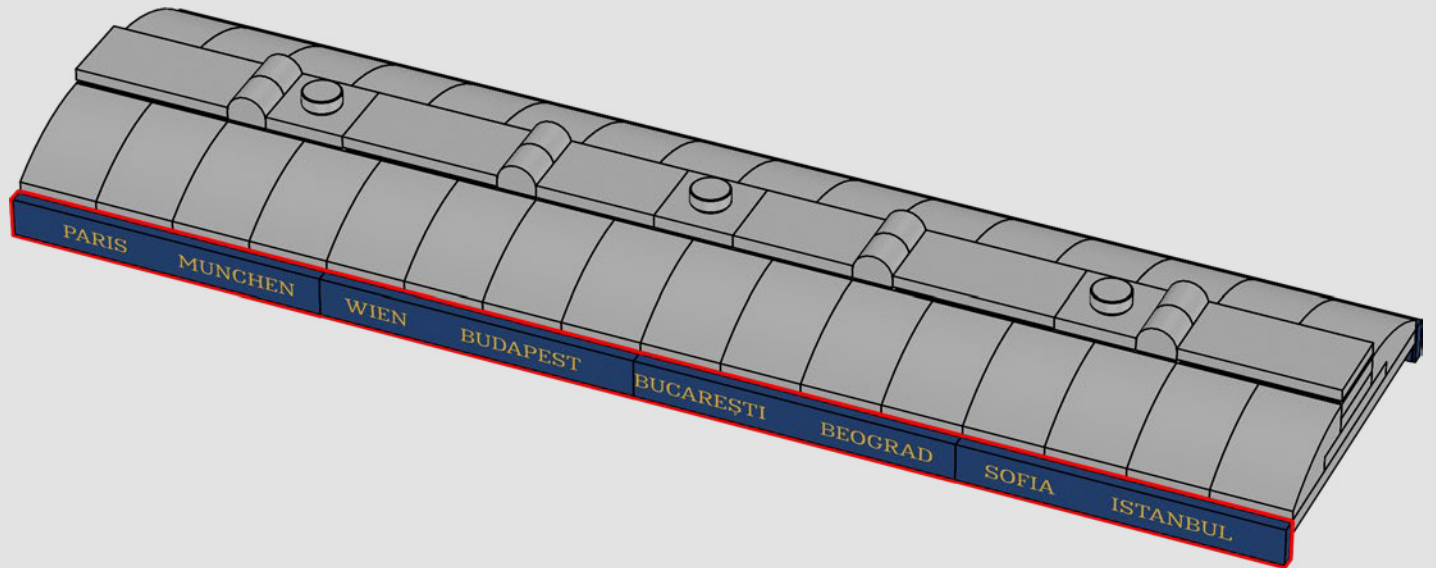

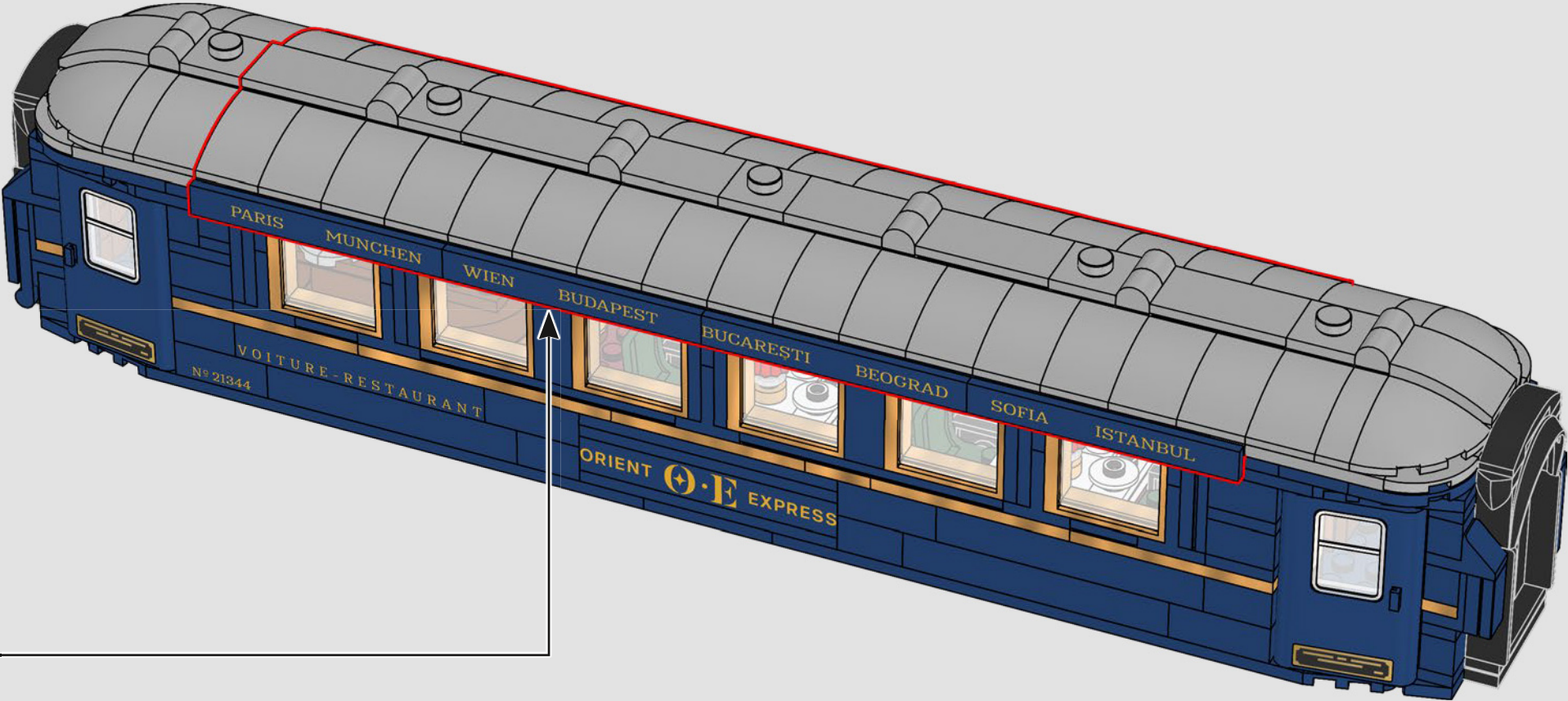

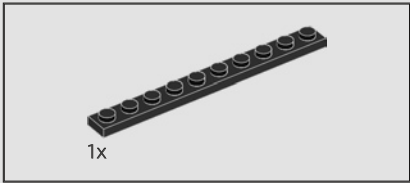
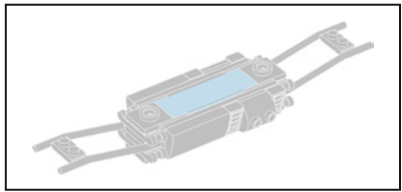

108

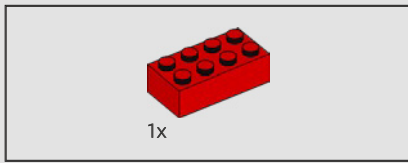
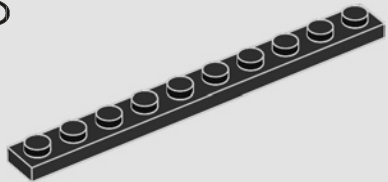

109

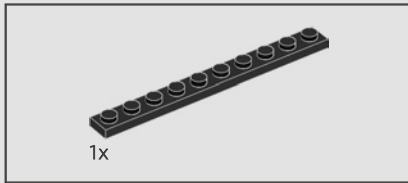
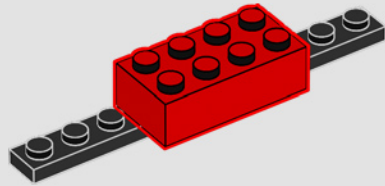

110

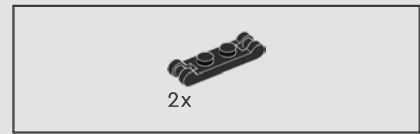
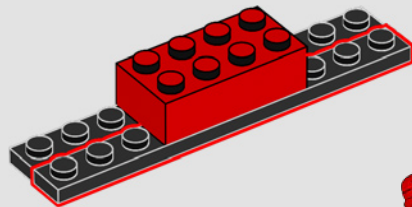

111

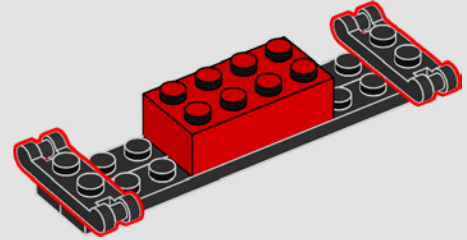

112

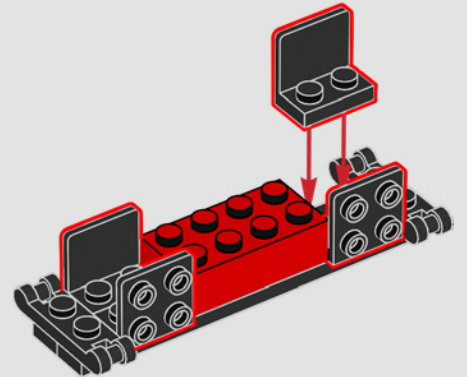

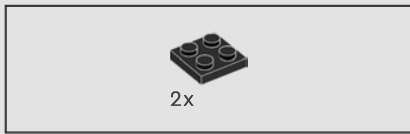

113

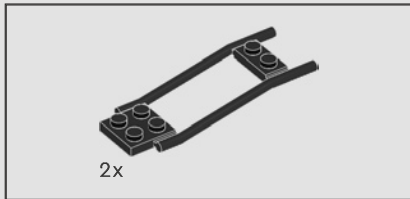
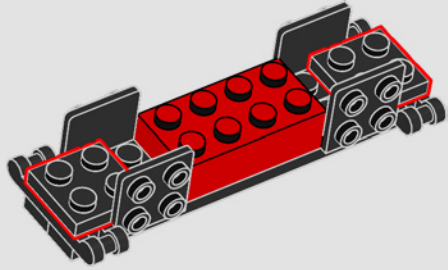

114

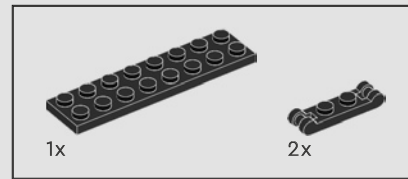
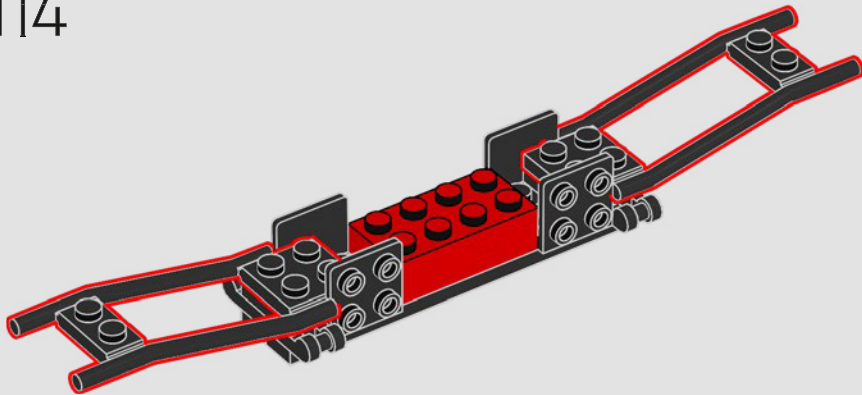

115

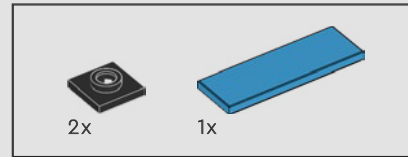
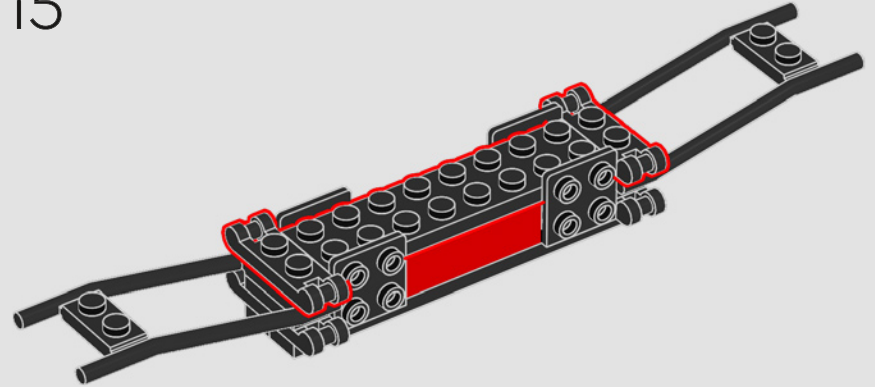

116

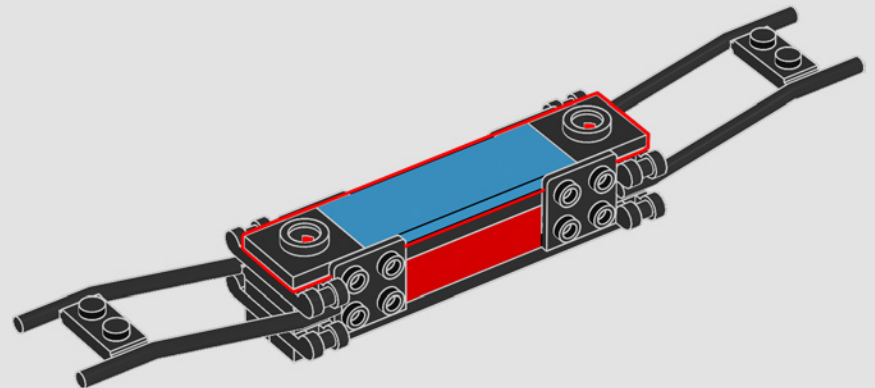

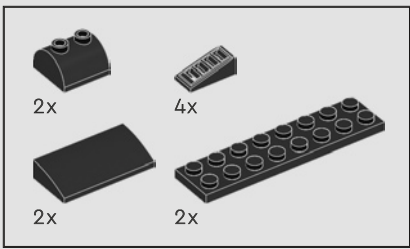

117

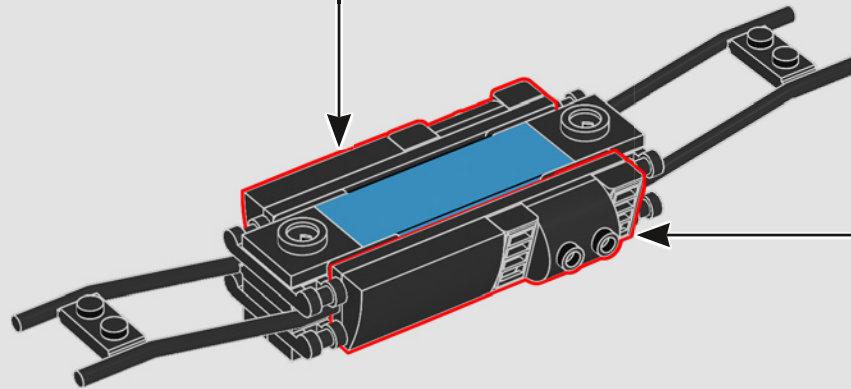
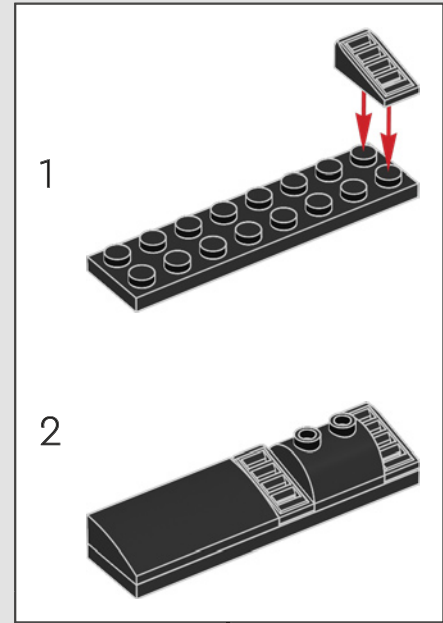
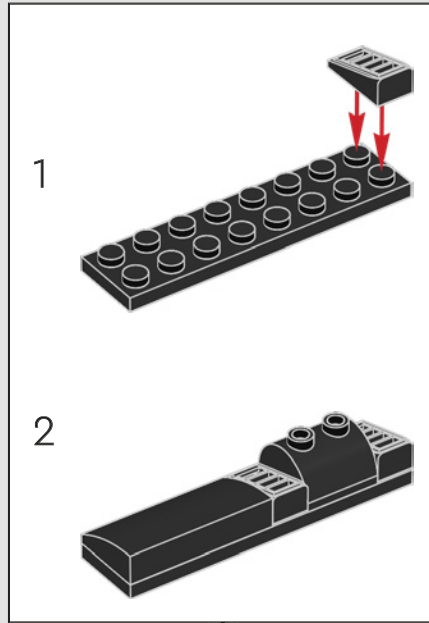

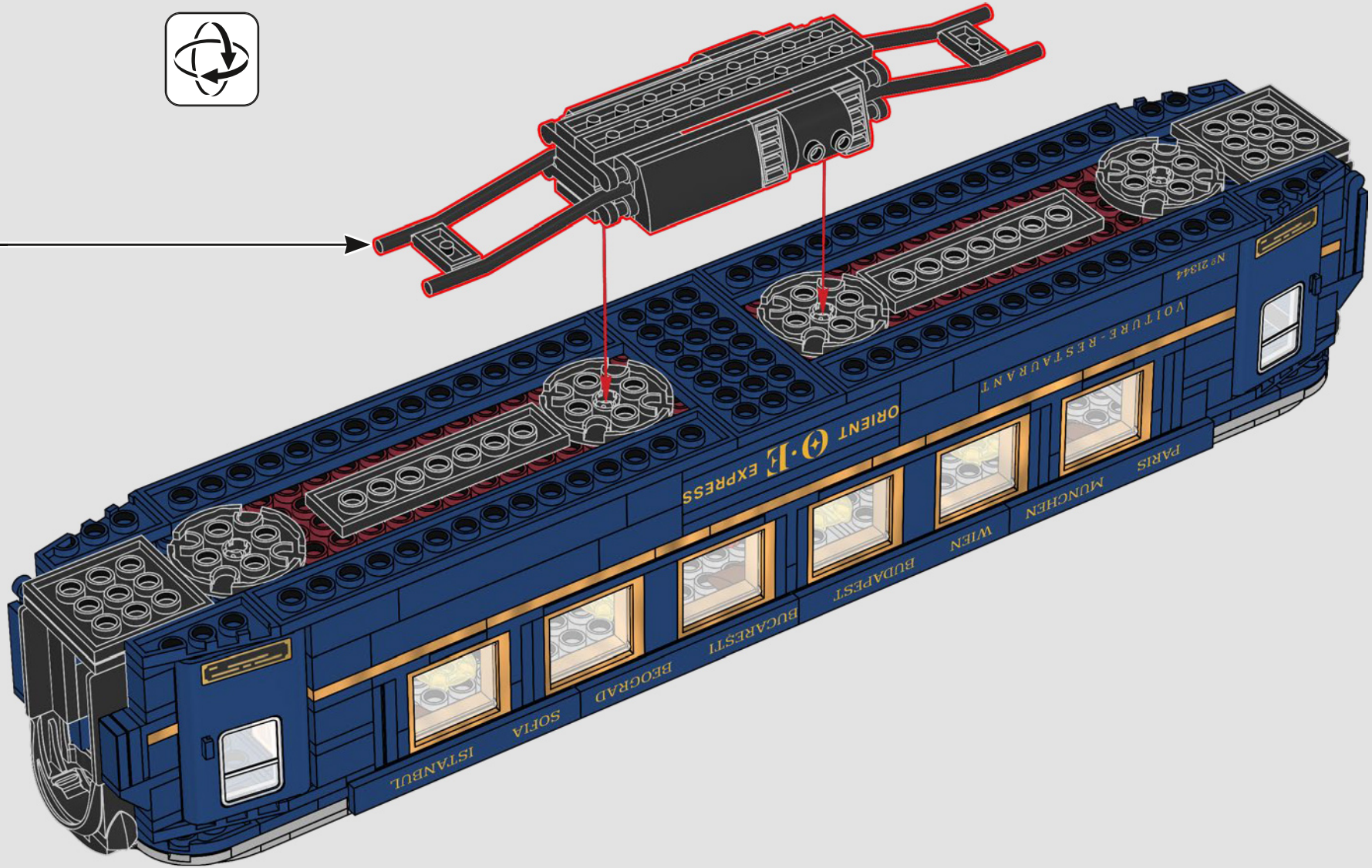

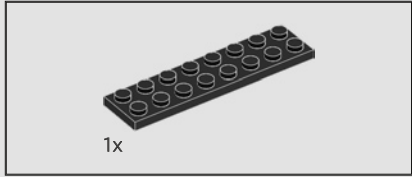
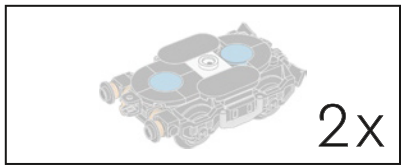

119

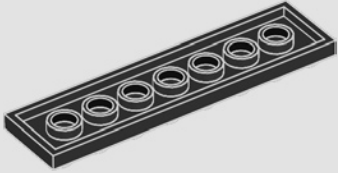

120

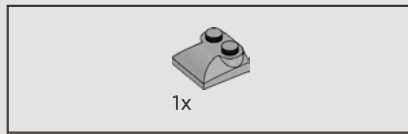
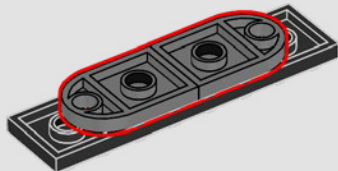

121

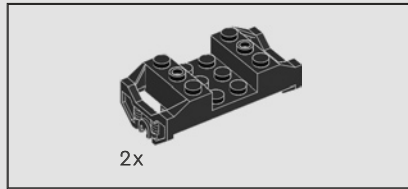
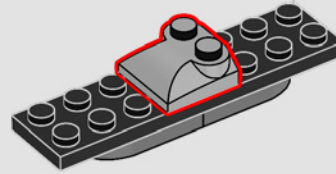

122

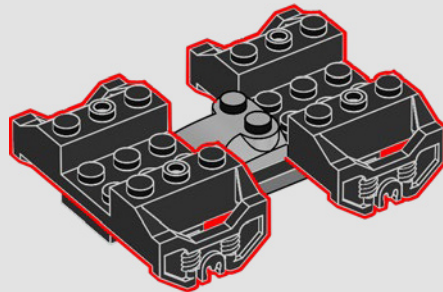

123

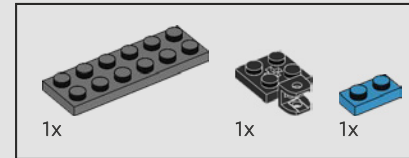
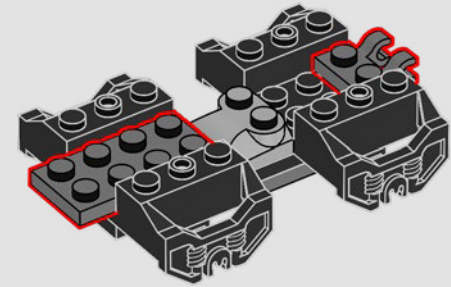

124

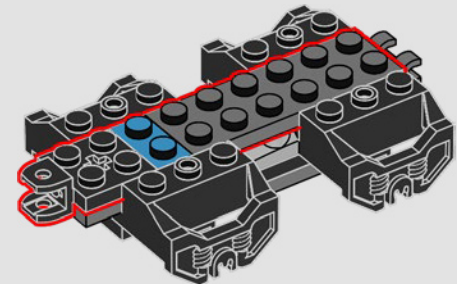

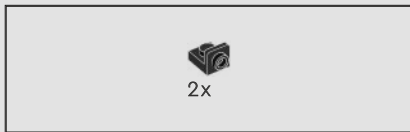

125

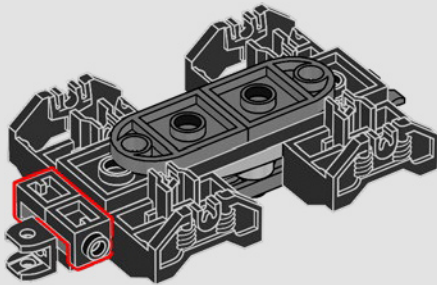

126

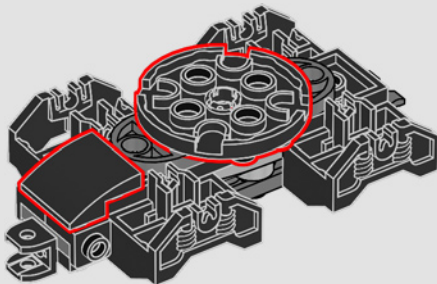

127

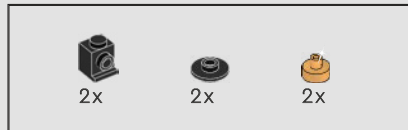
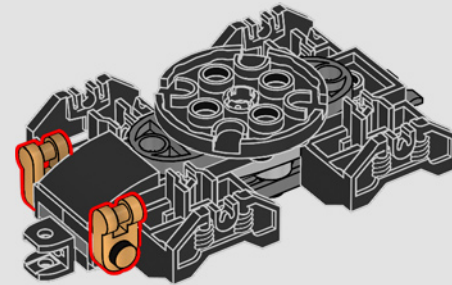

128

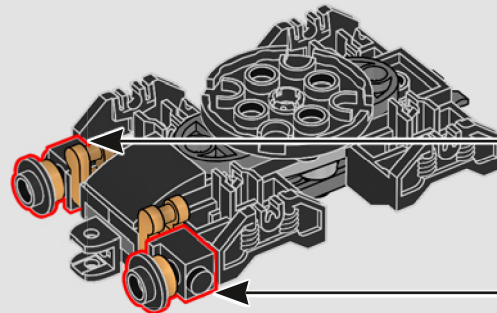
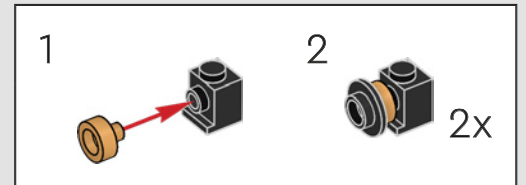

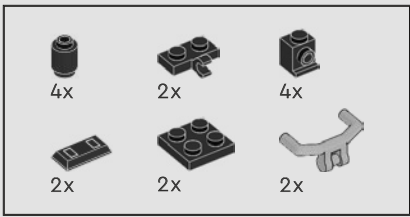

129

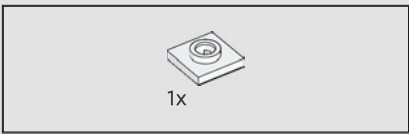
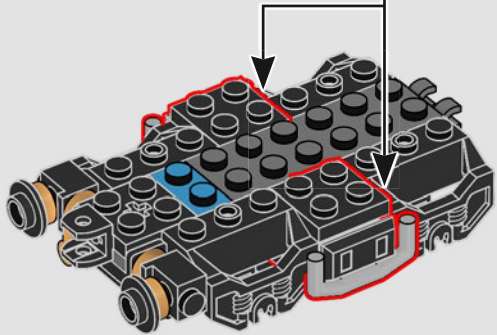
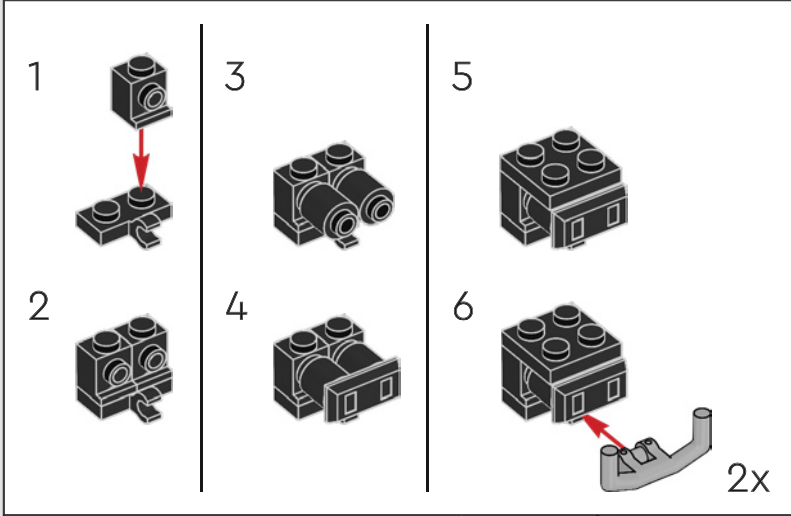

130

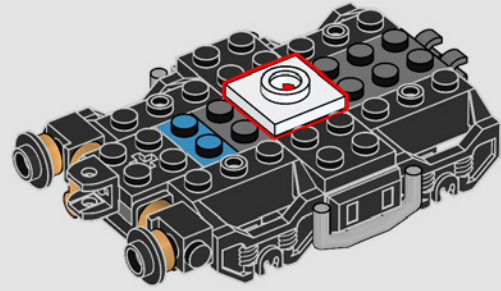

131

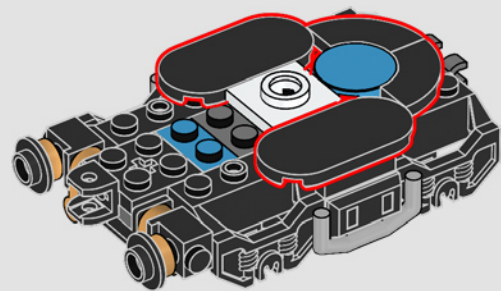



132

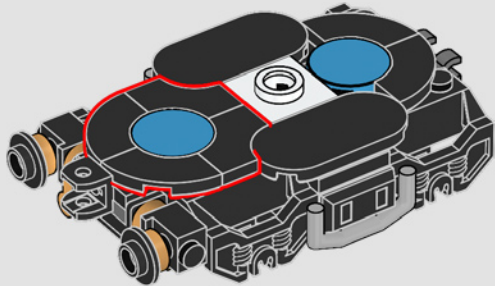

133

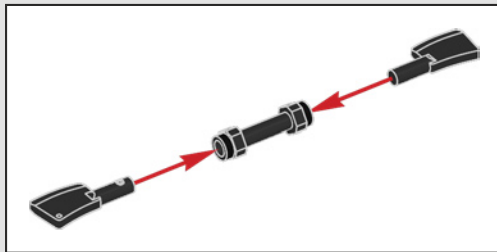
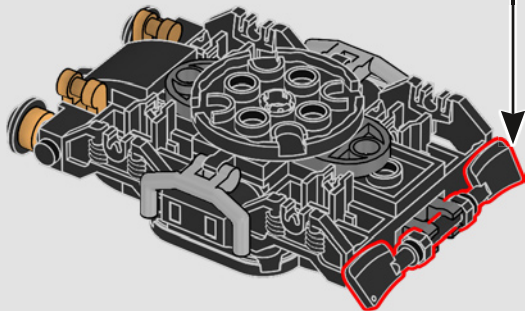

134

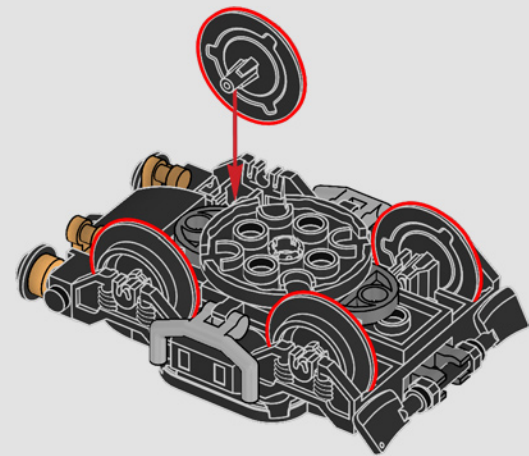

2x

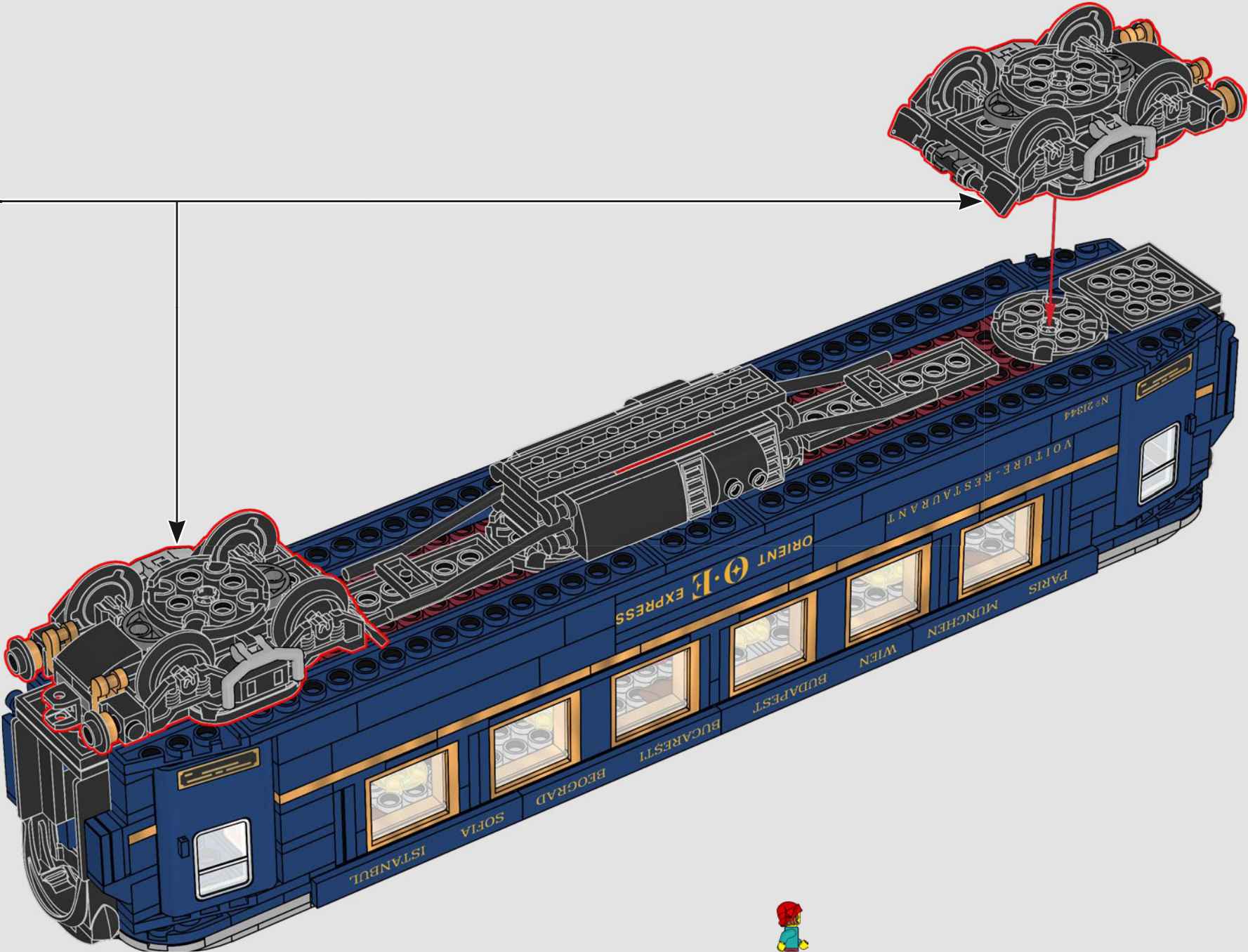

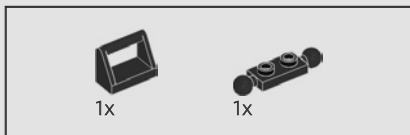

Próxima parada: VIENA

"Tras una maravillosa velada con una magnífica cena, llegó el momento de buscar el coche cama".

136

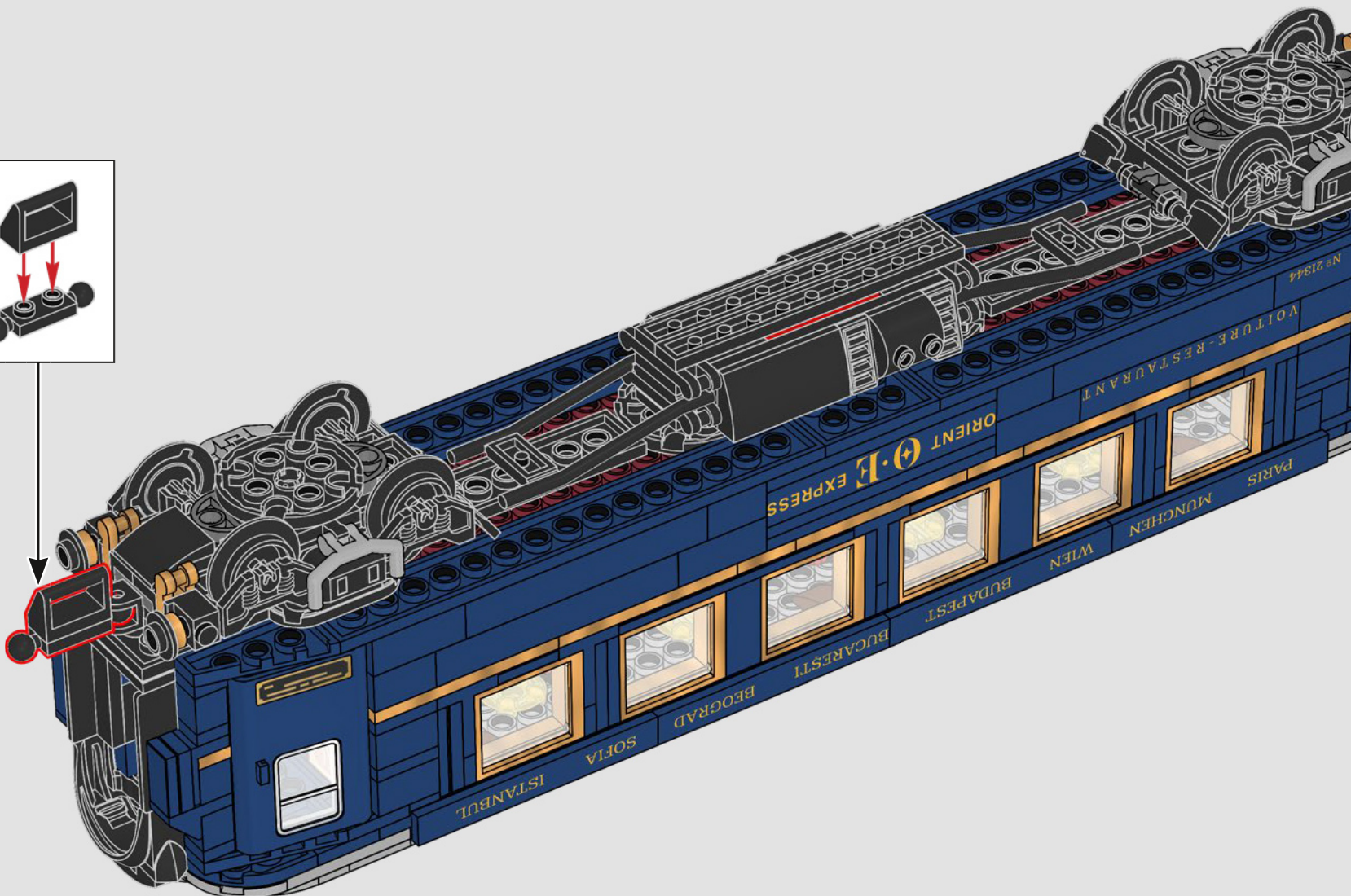
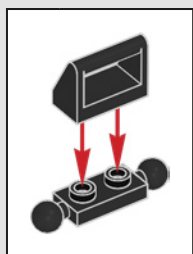

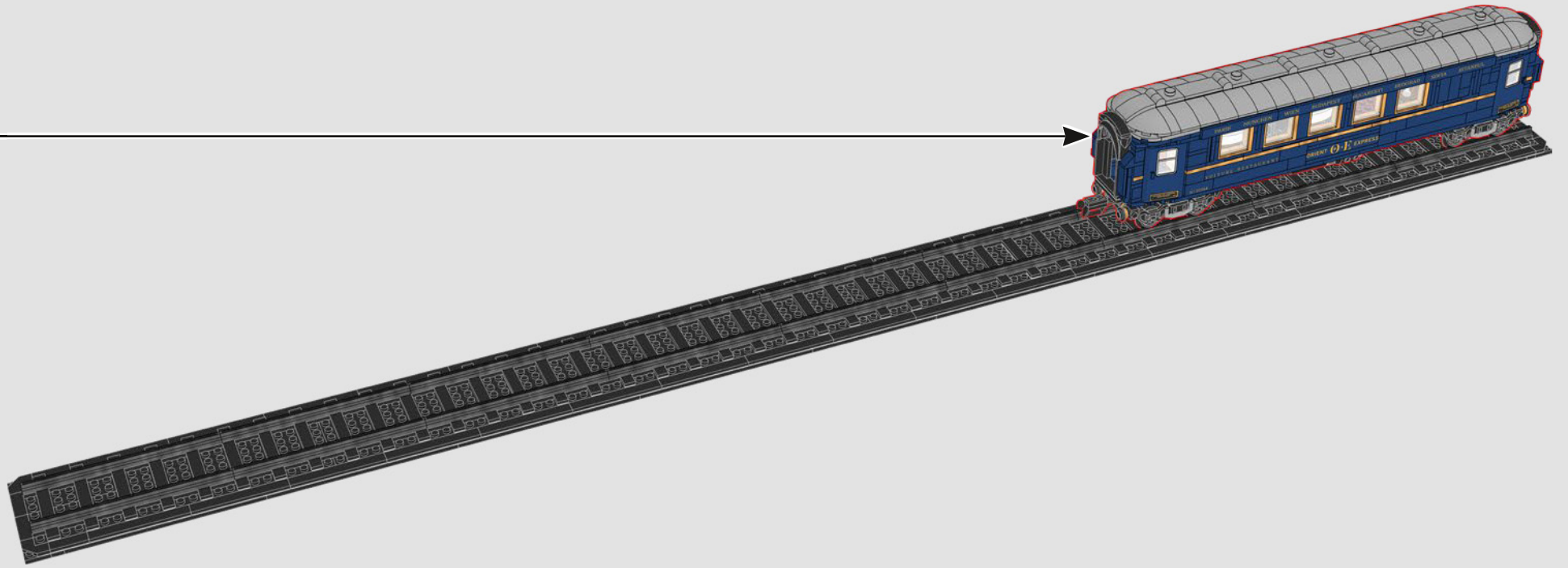

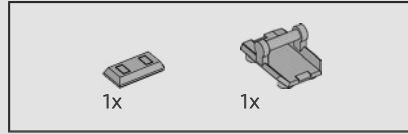
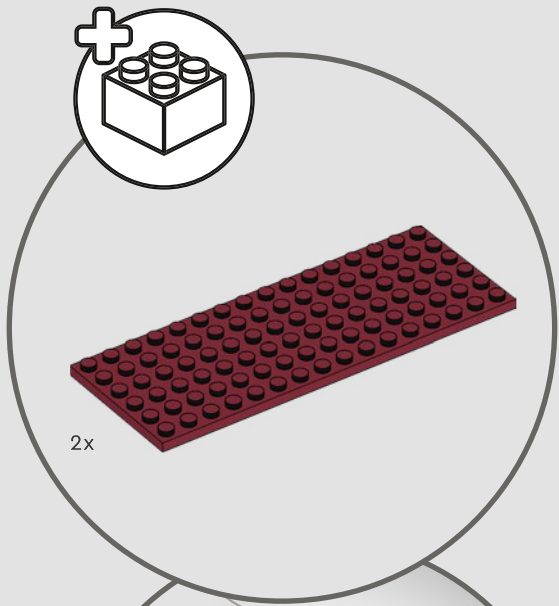

1

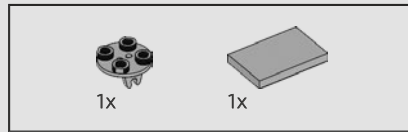
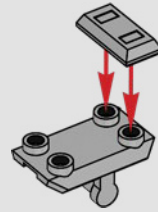

2

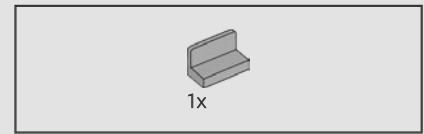
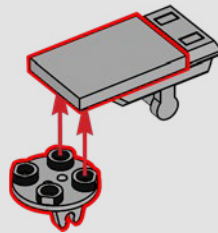

3

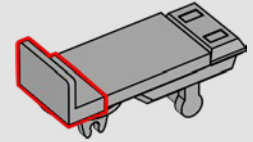

4

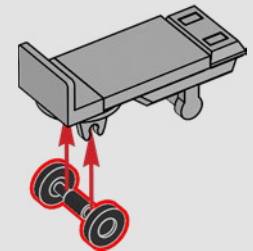

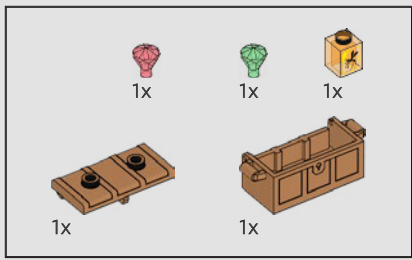

5

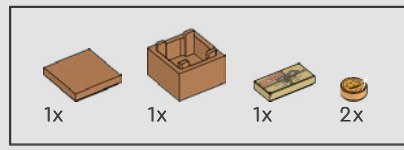
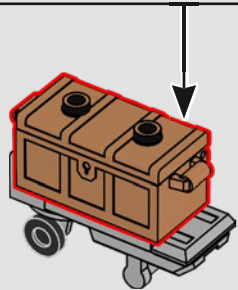
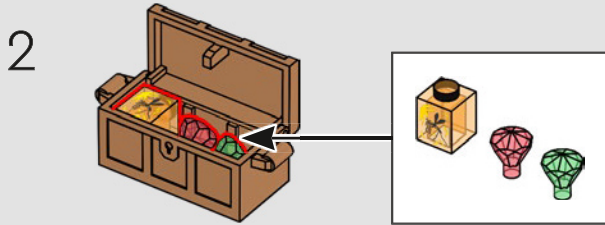
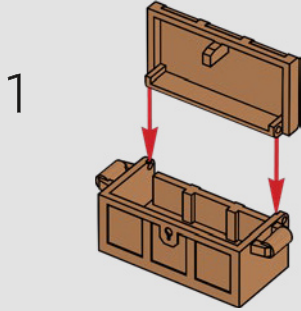

6

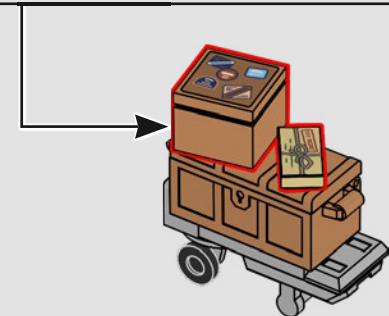
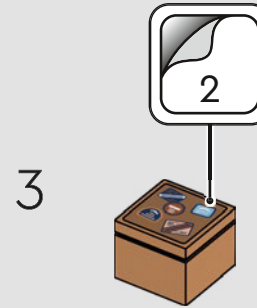
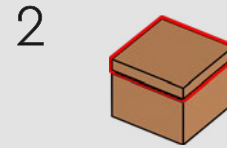
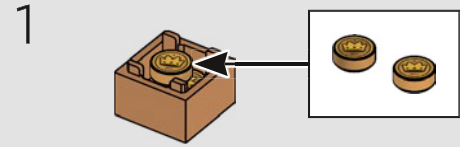

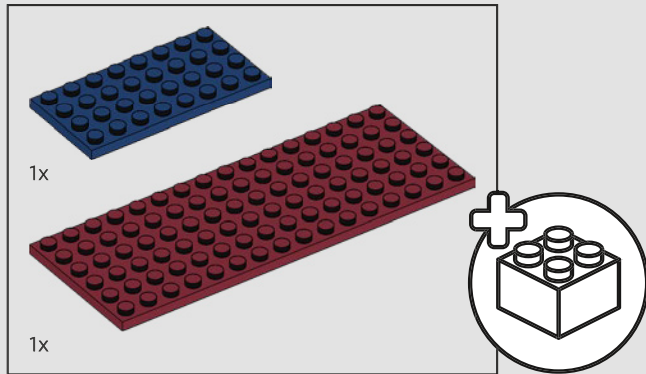
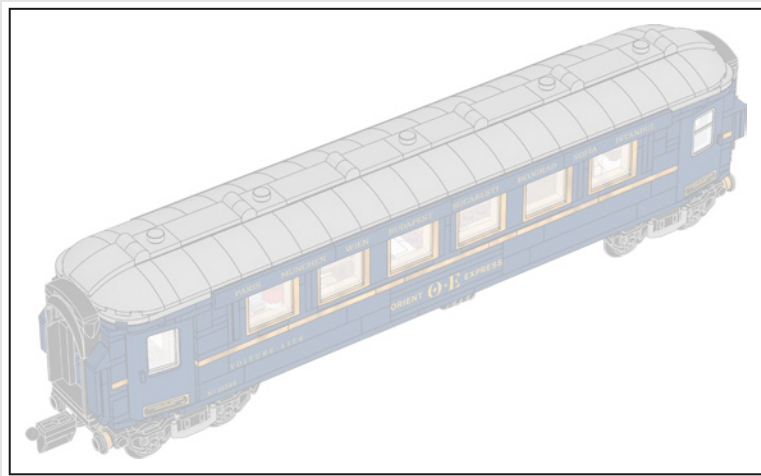

138

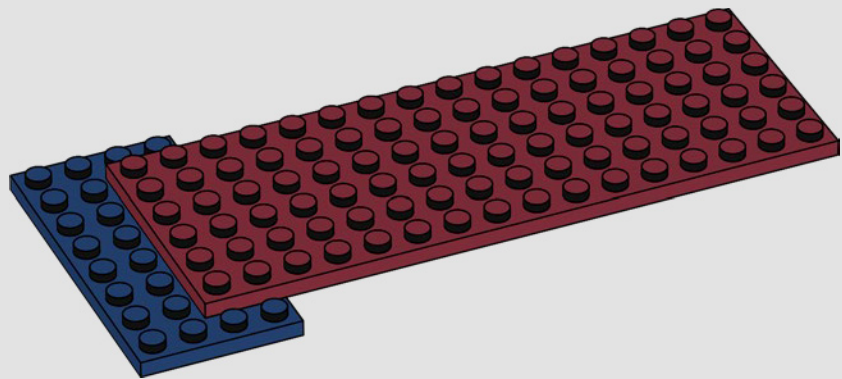

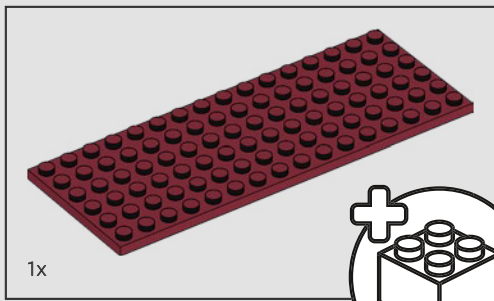

1x

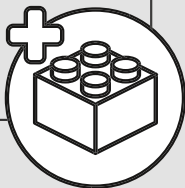

139

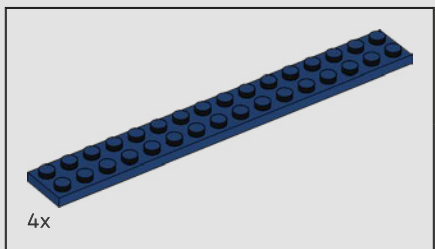
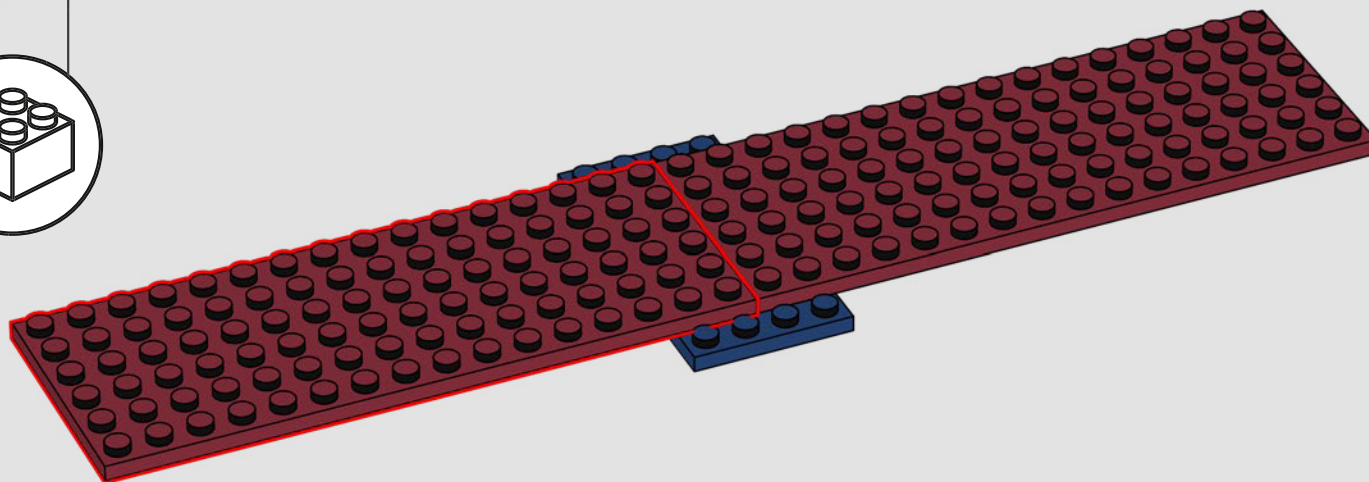

4x

140

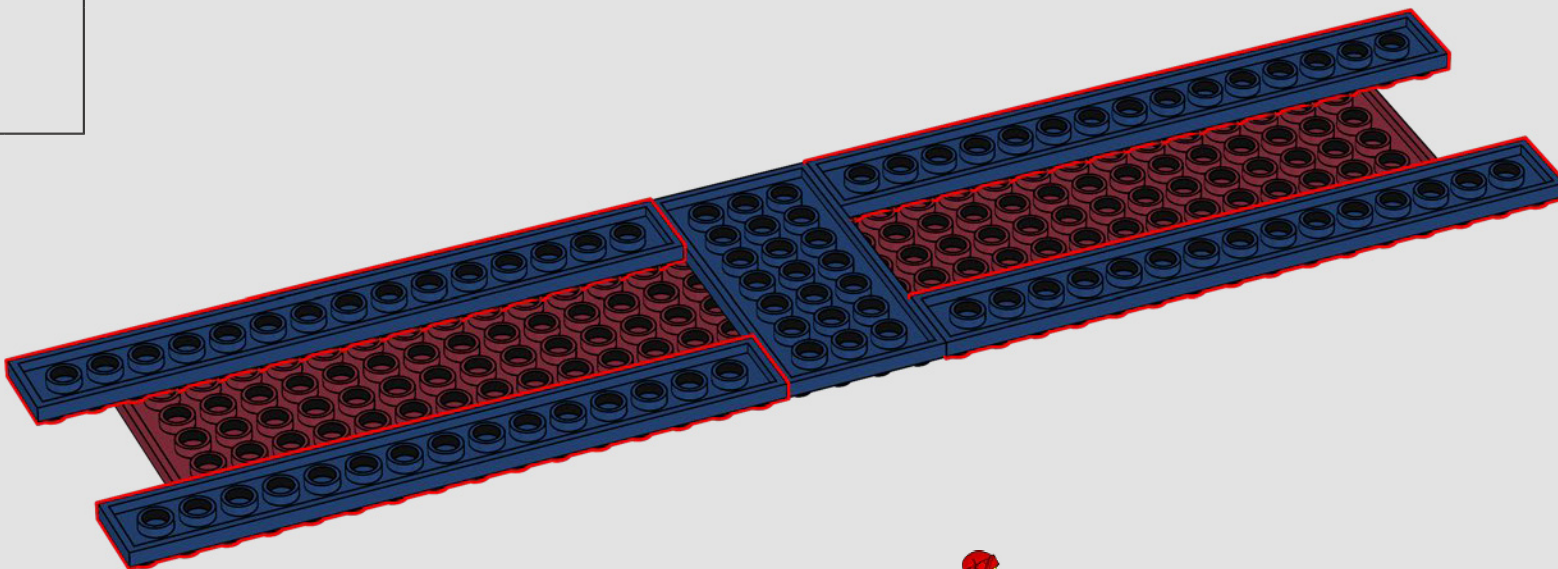

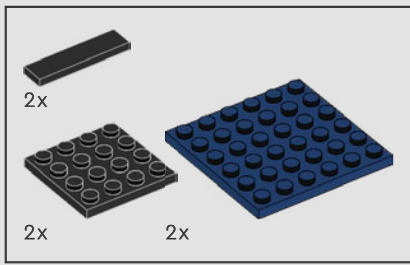

141

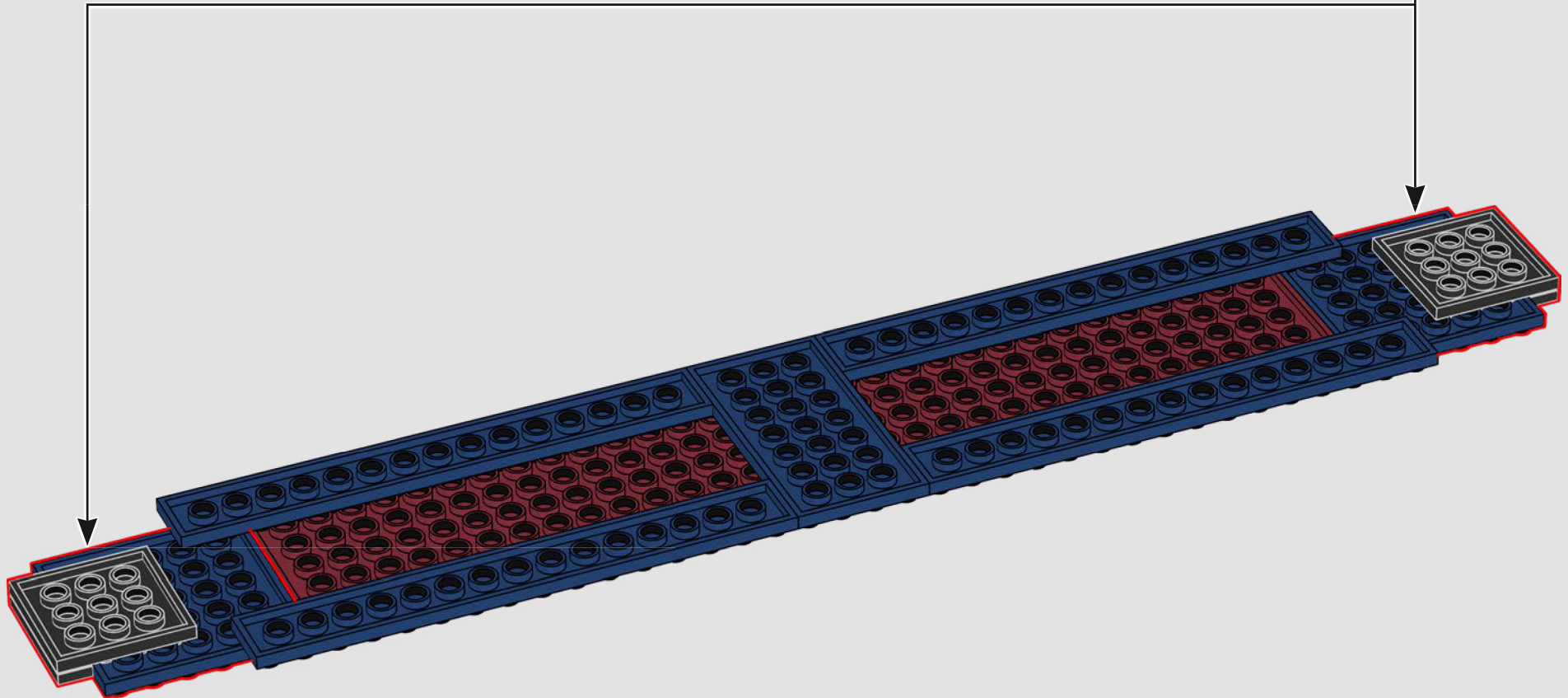
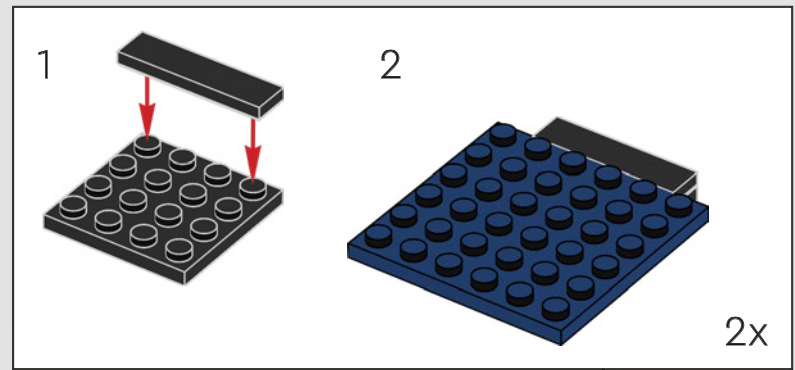

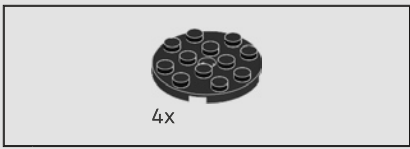

142

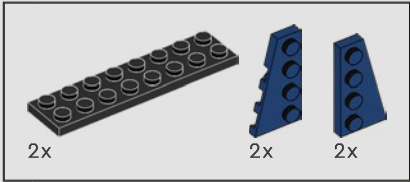
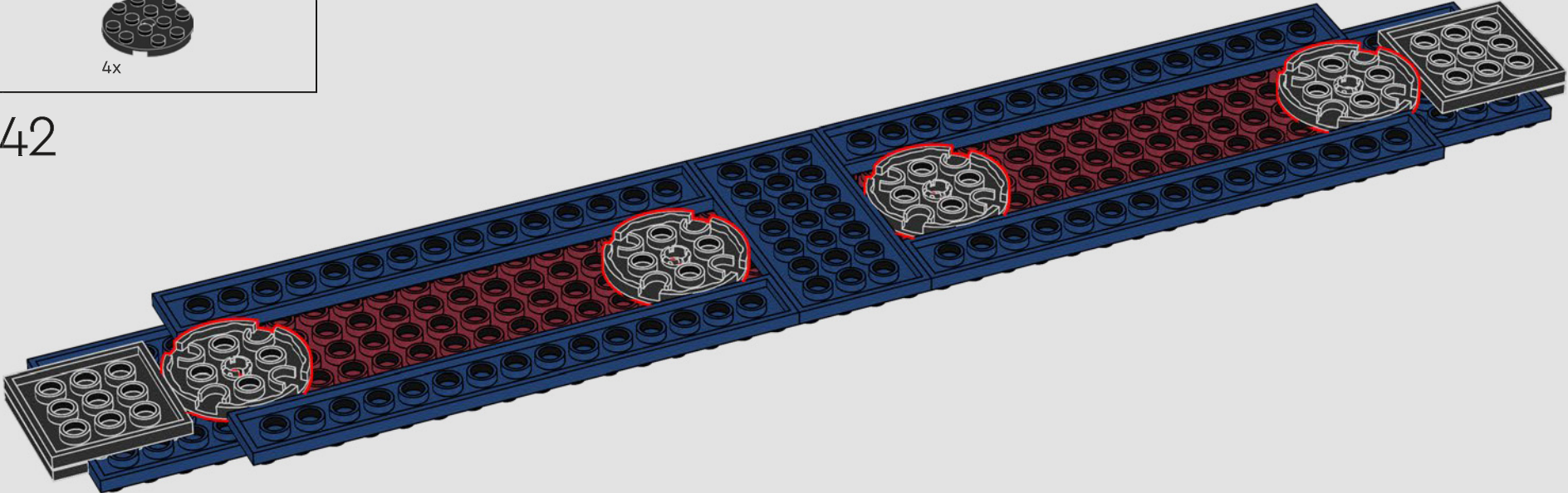

143

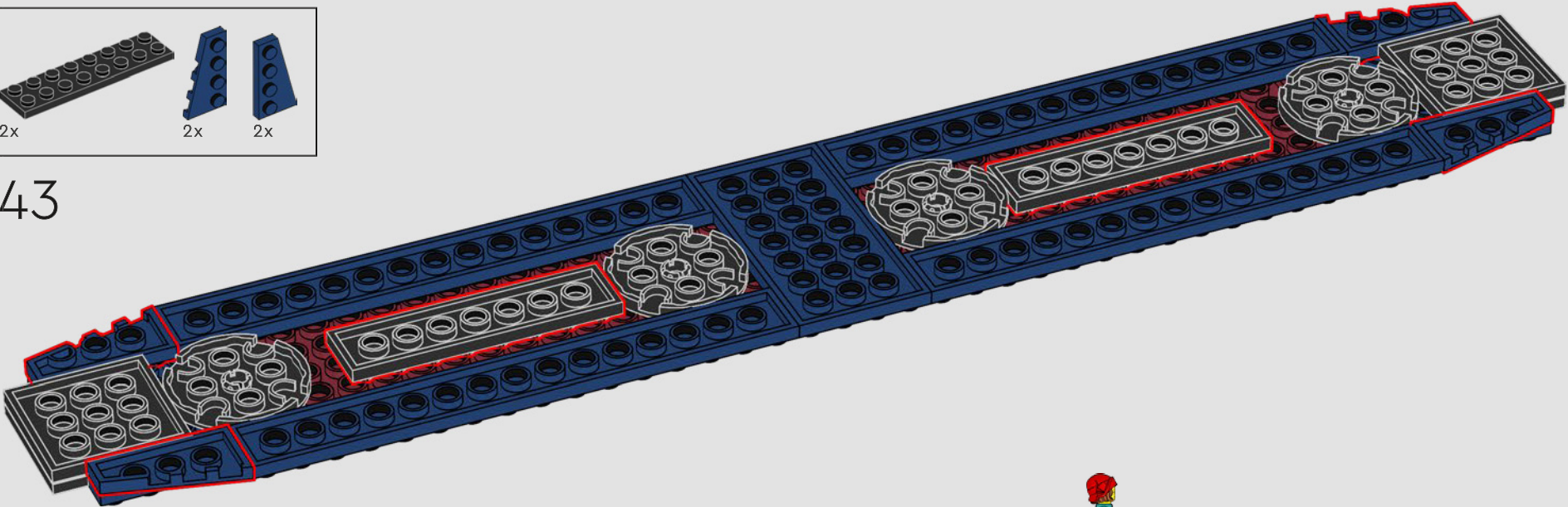

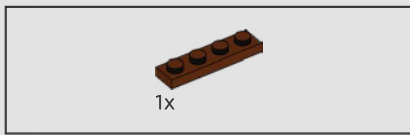

144

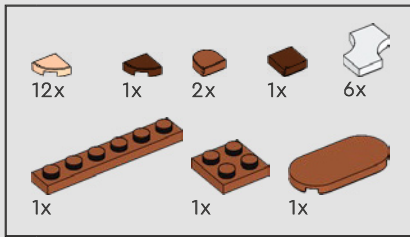
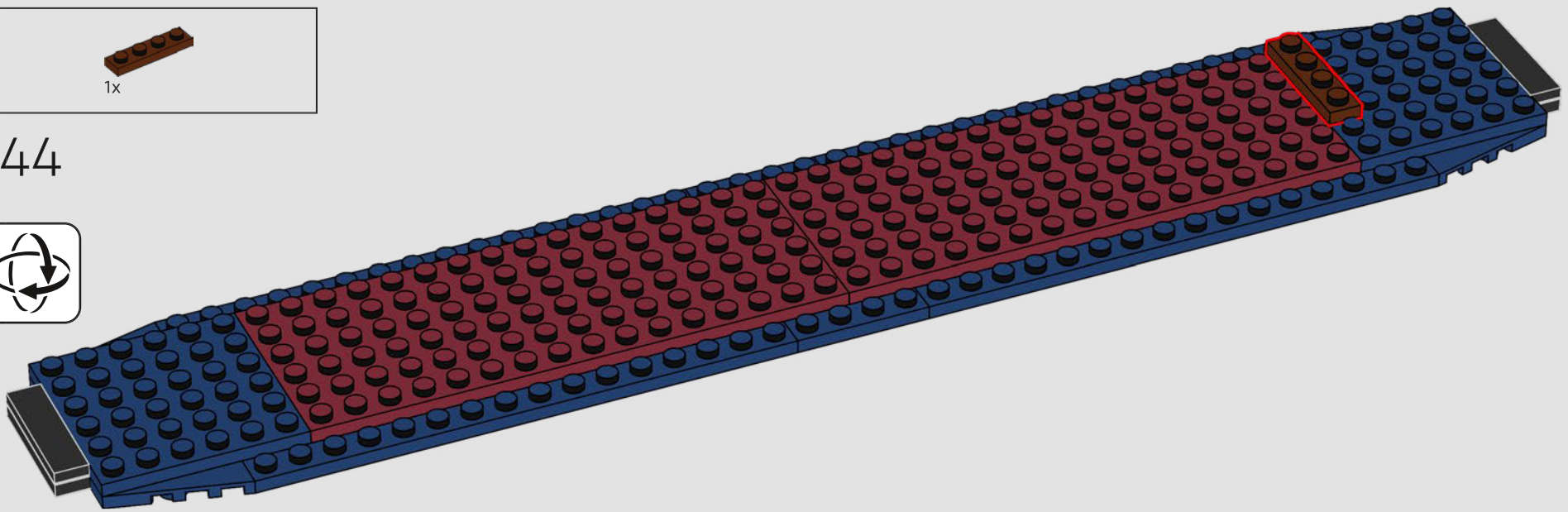

145

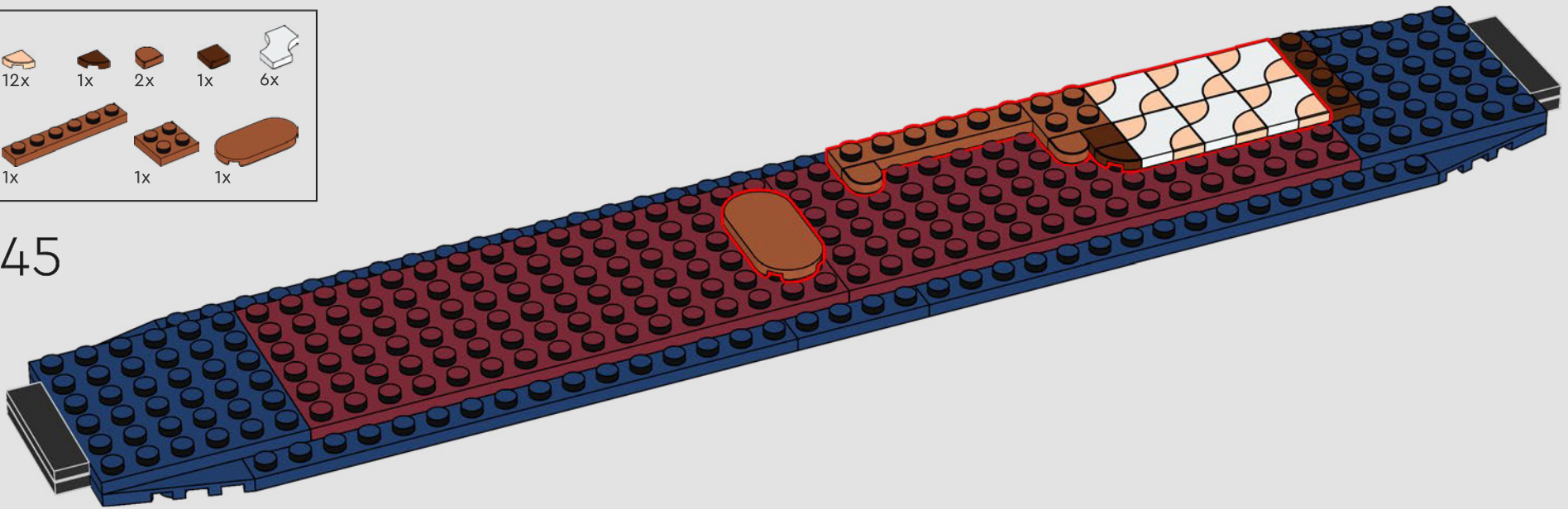

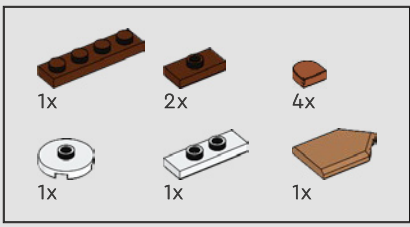

146

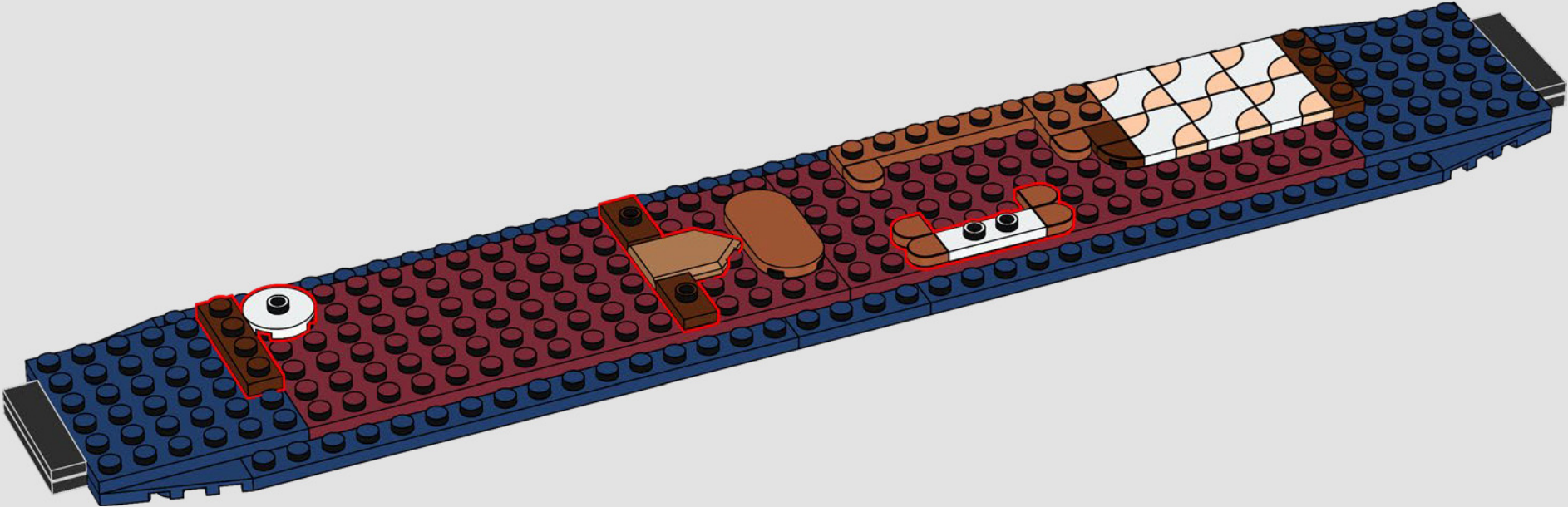

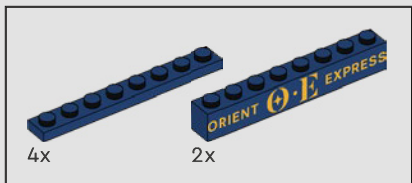

148

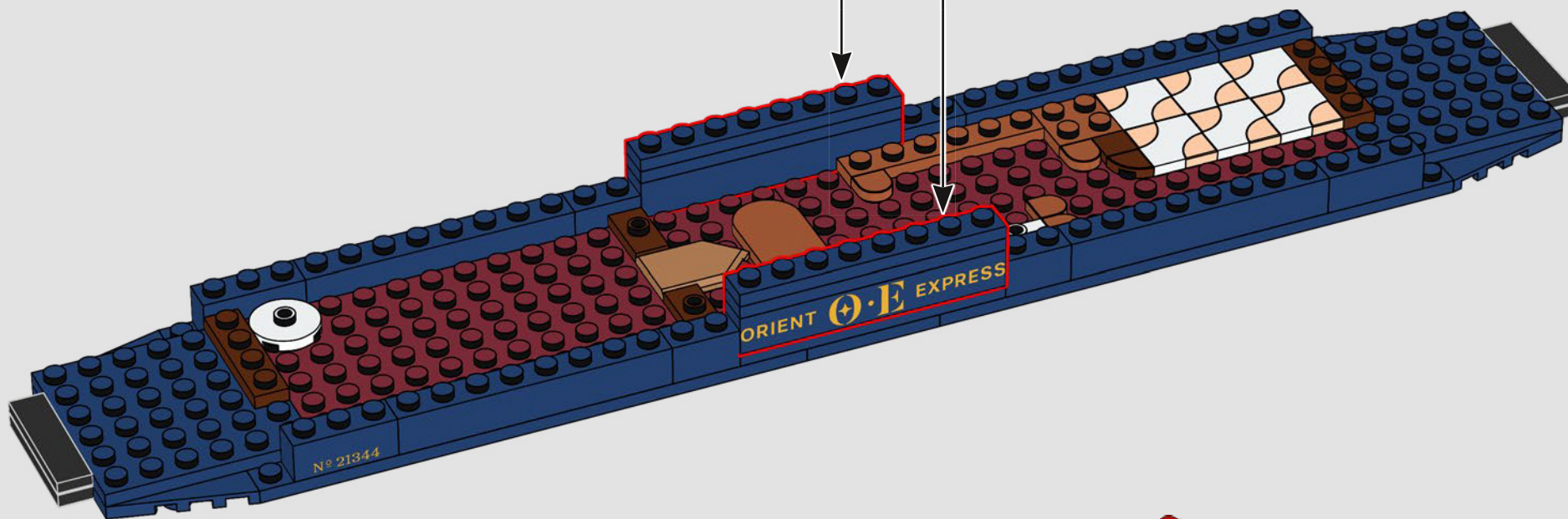
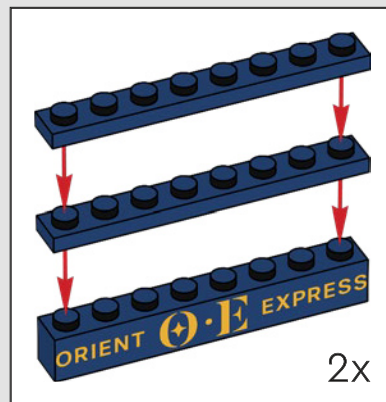

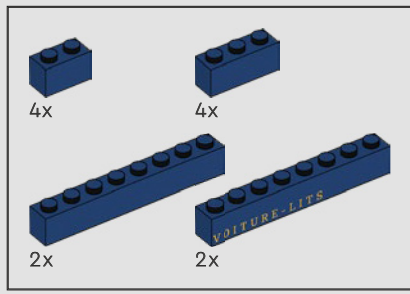

149

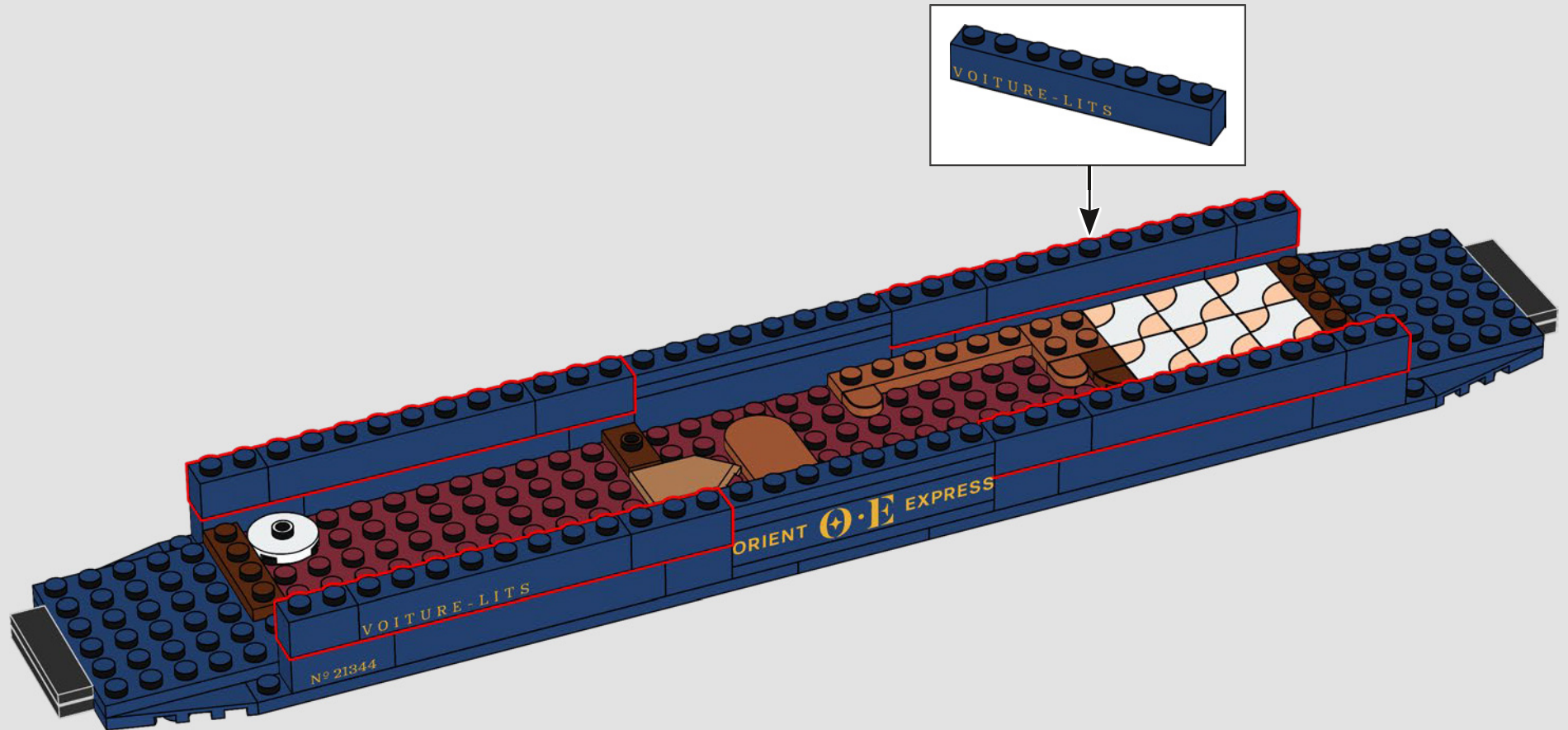

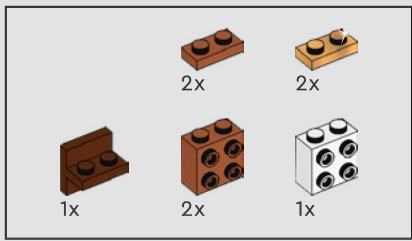

150

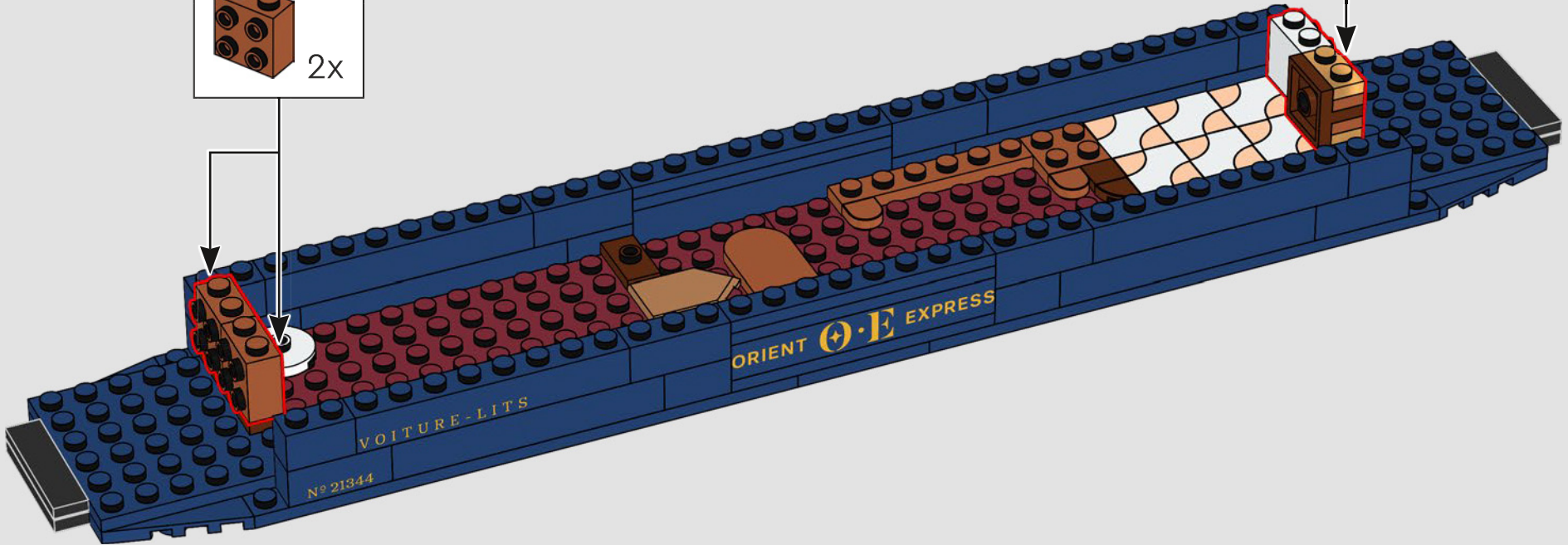
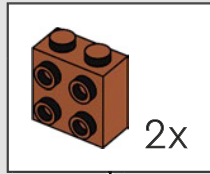
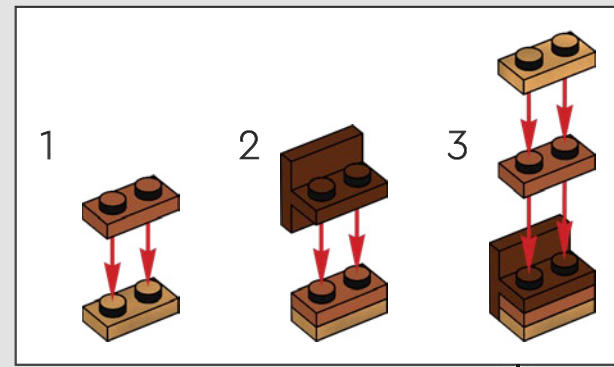

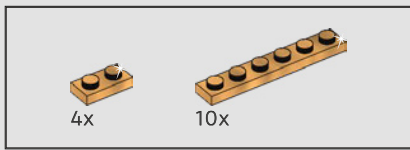

151

..... ●
Próxima parada: BUDAPEST
"Nuestro recorrido hacia Budapest bordeando el río Danubio nos ofreció una espectacular vista de sus aguas tan brillantes como el oro".

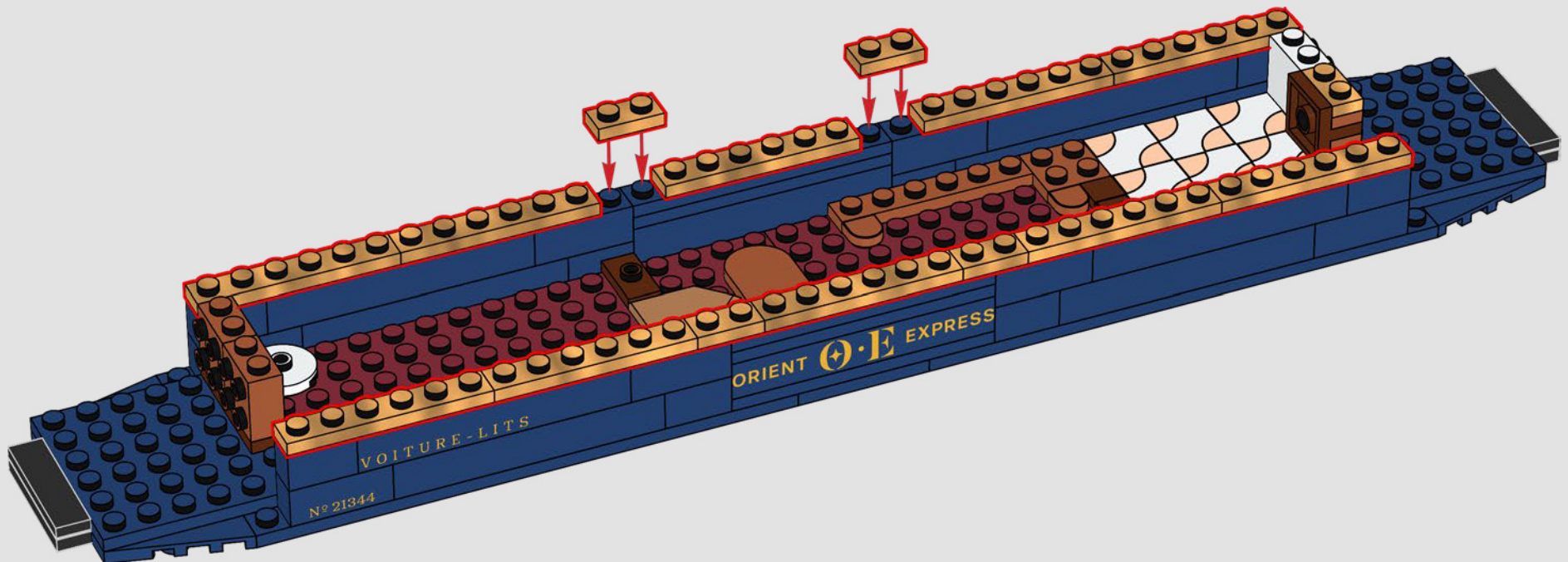

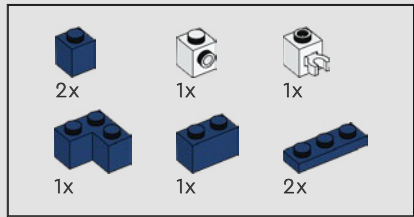

152

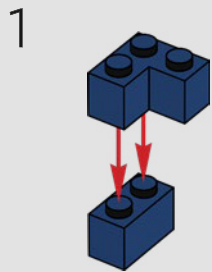

2

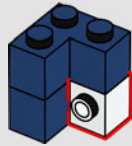

3

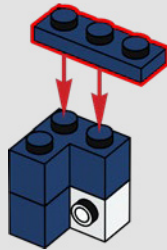

4

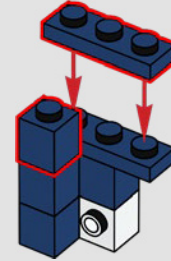

5

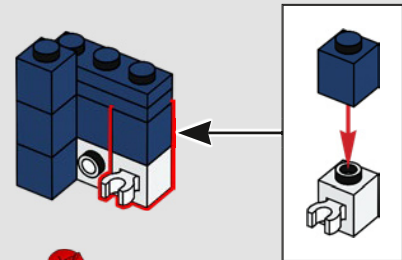

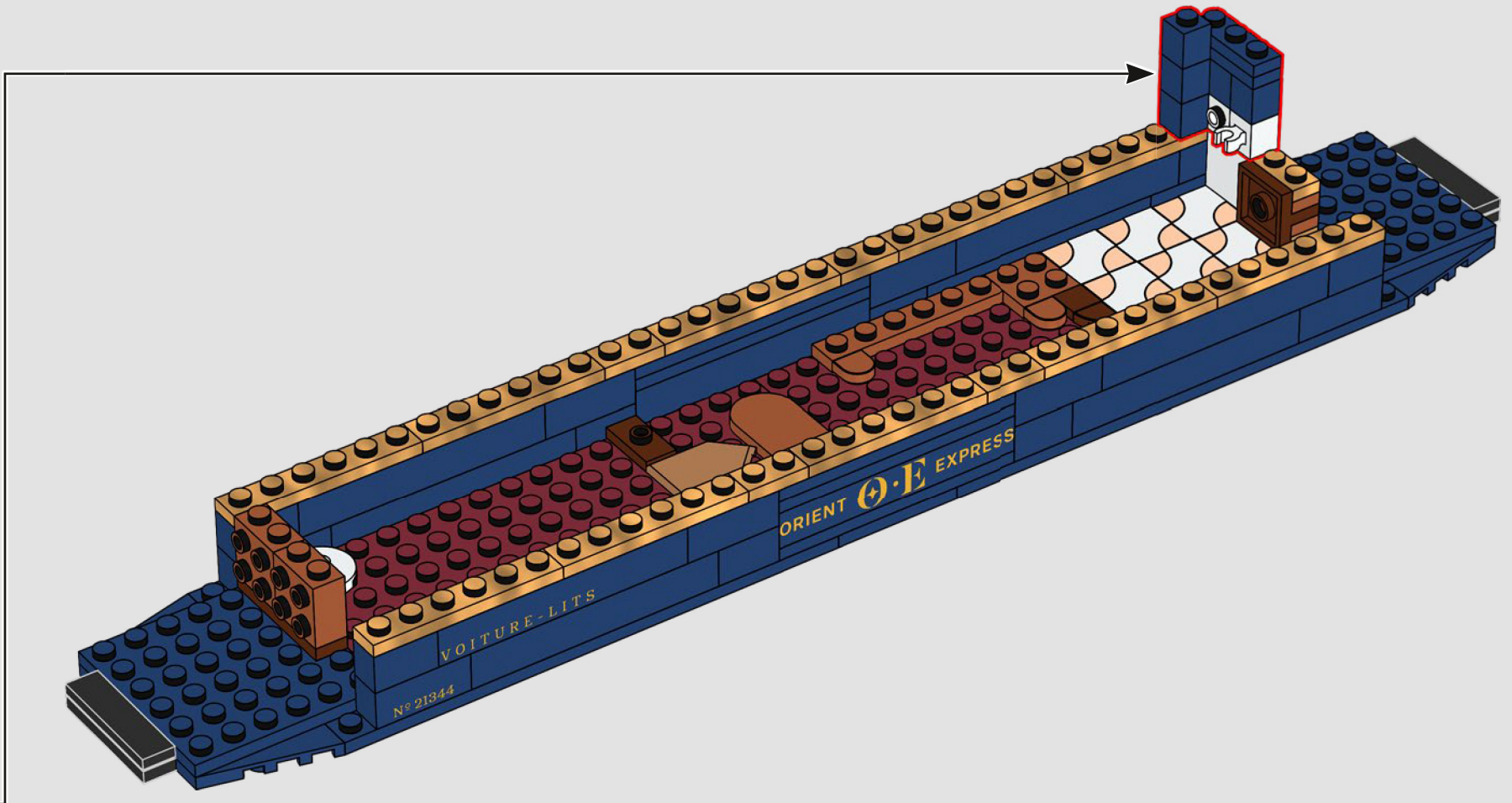

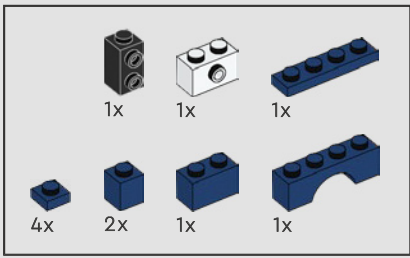

153

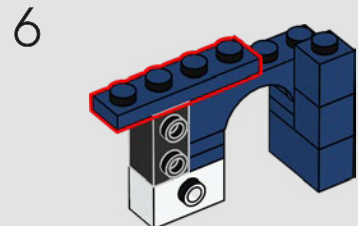
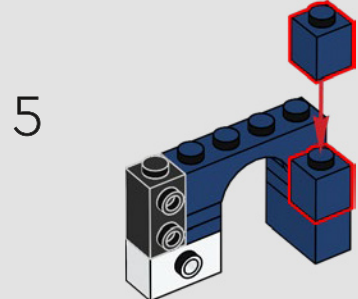
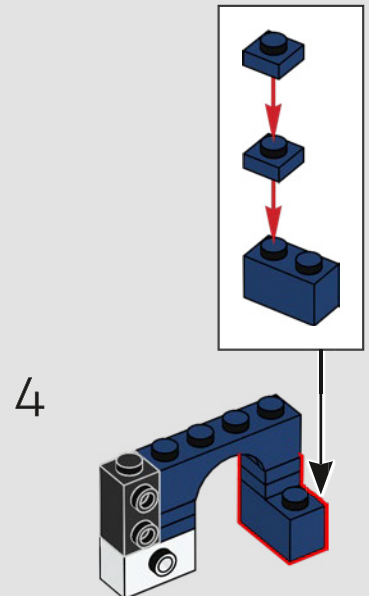
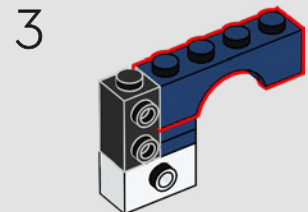
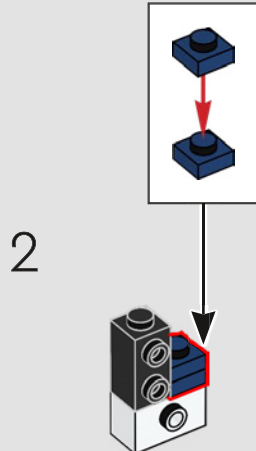
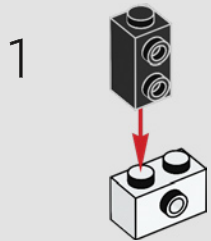

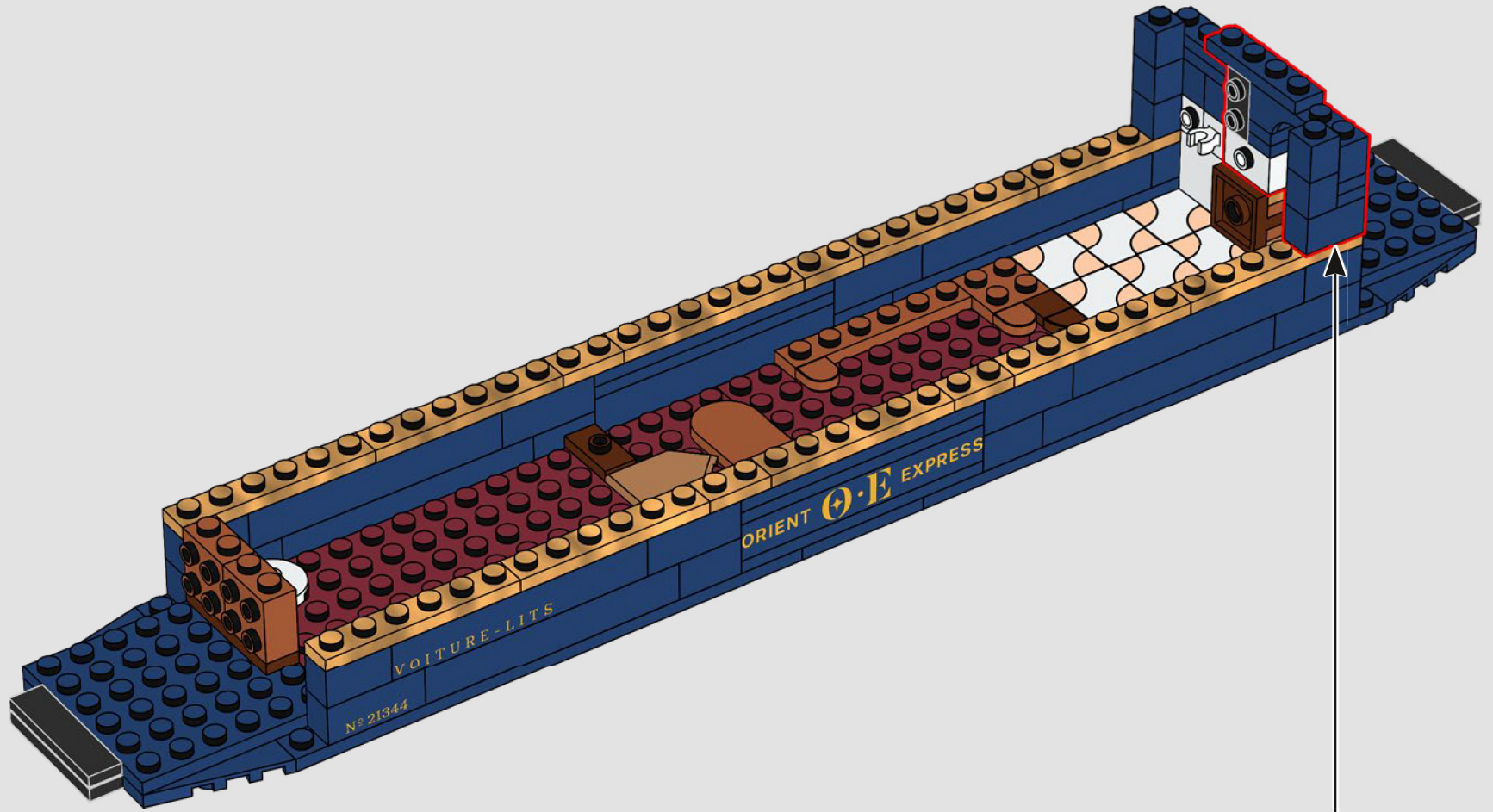

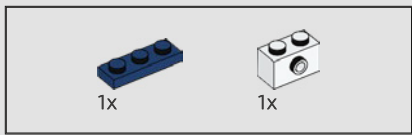

154

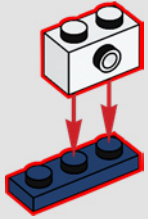

155

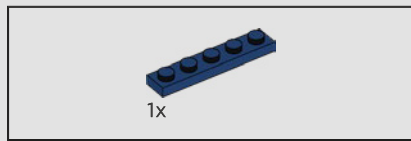
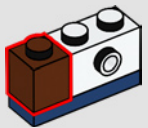

156

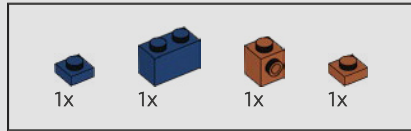
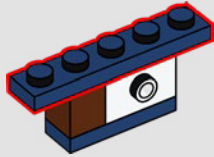

157

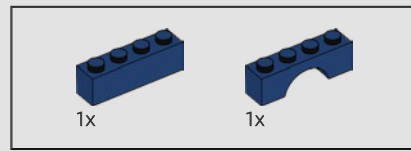
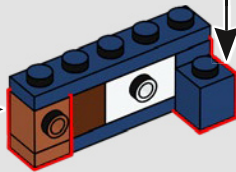
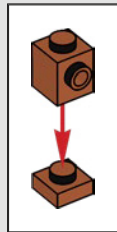
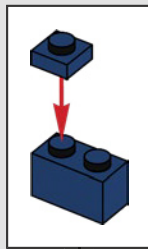

158

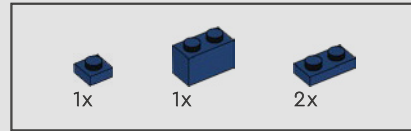
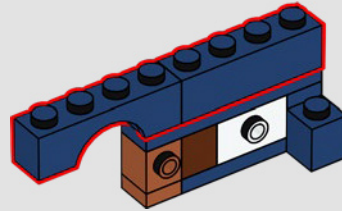

159

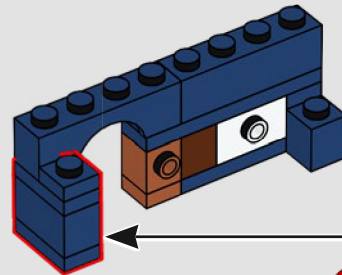
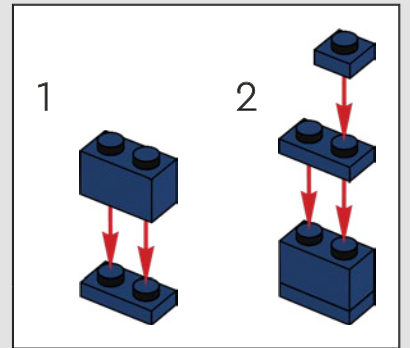

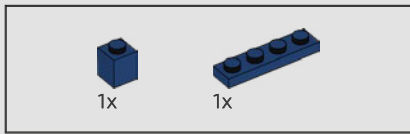

160

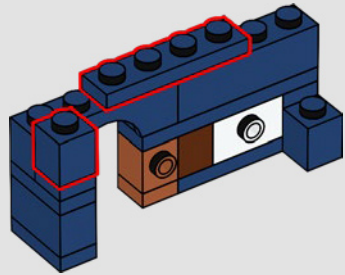

161

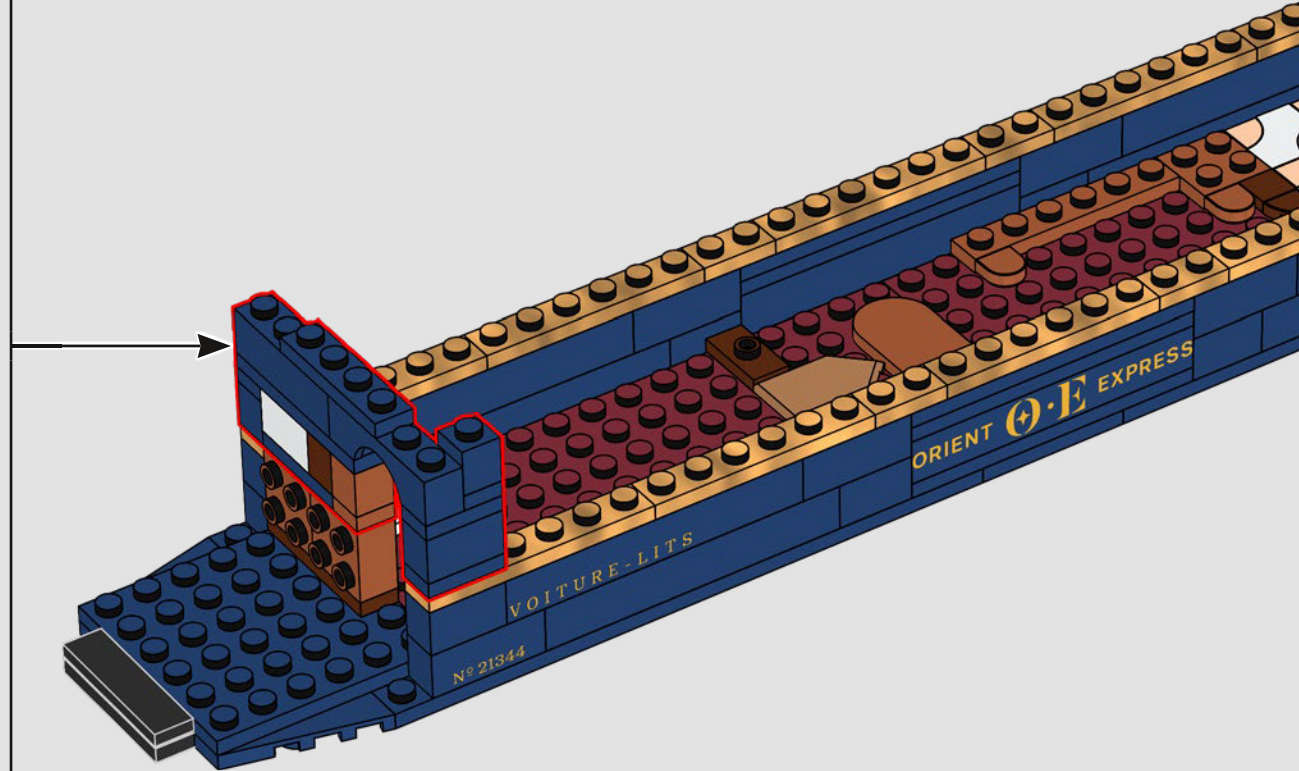

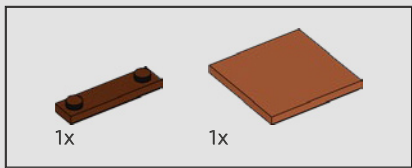

162

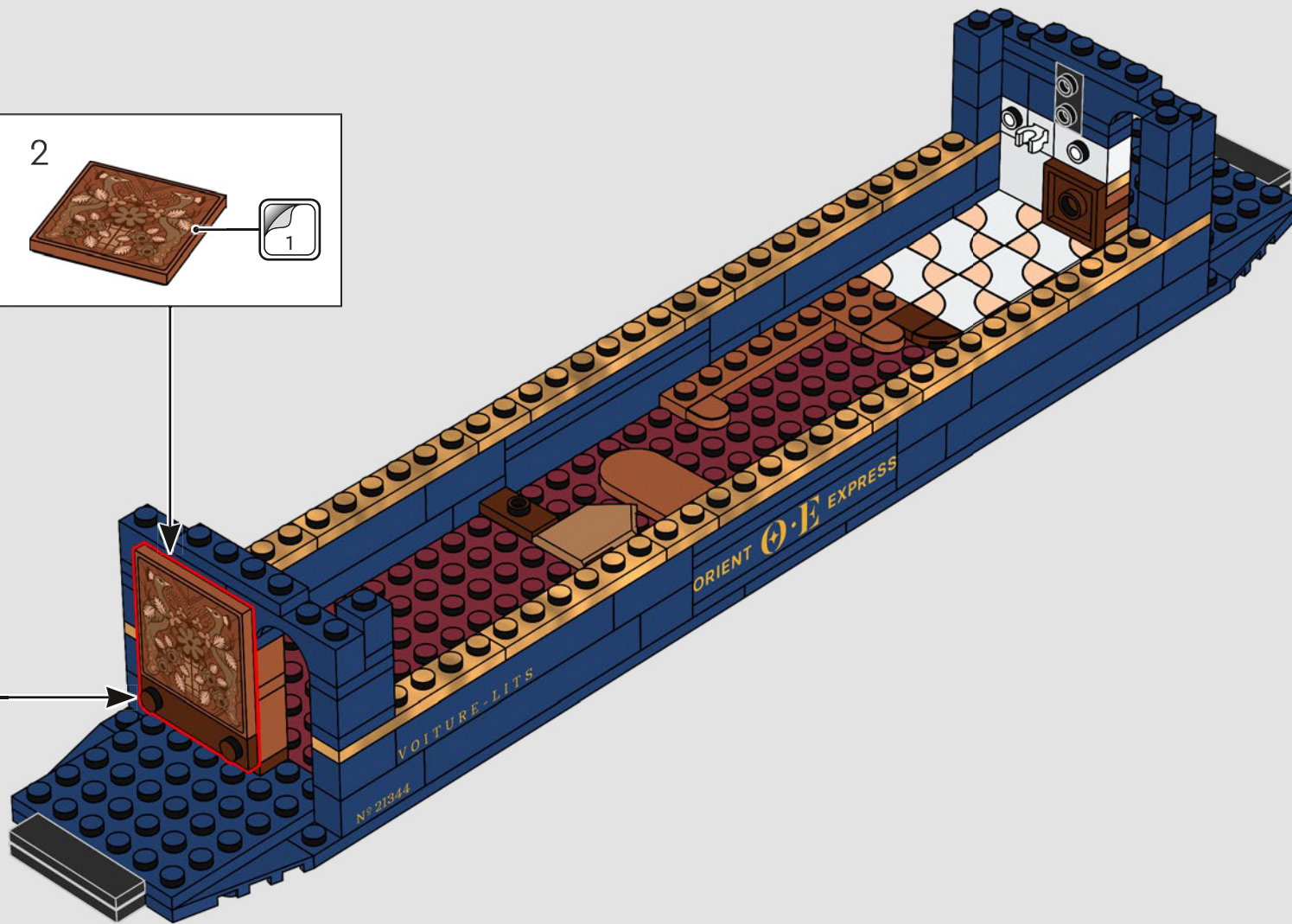
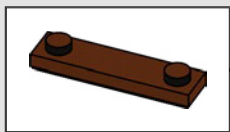

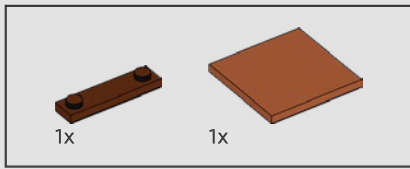

163

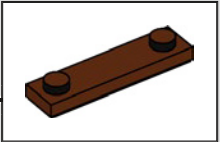
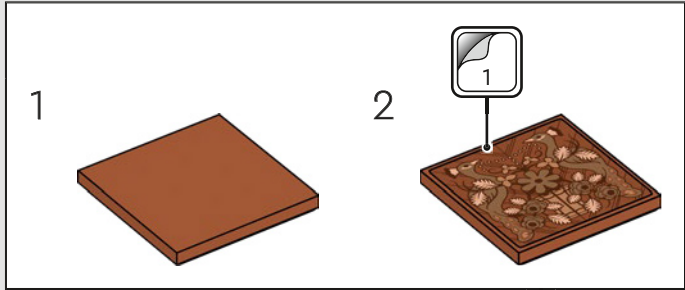
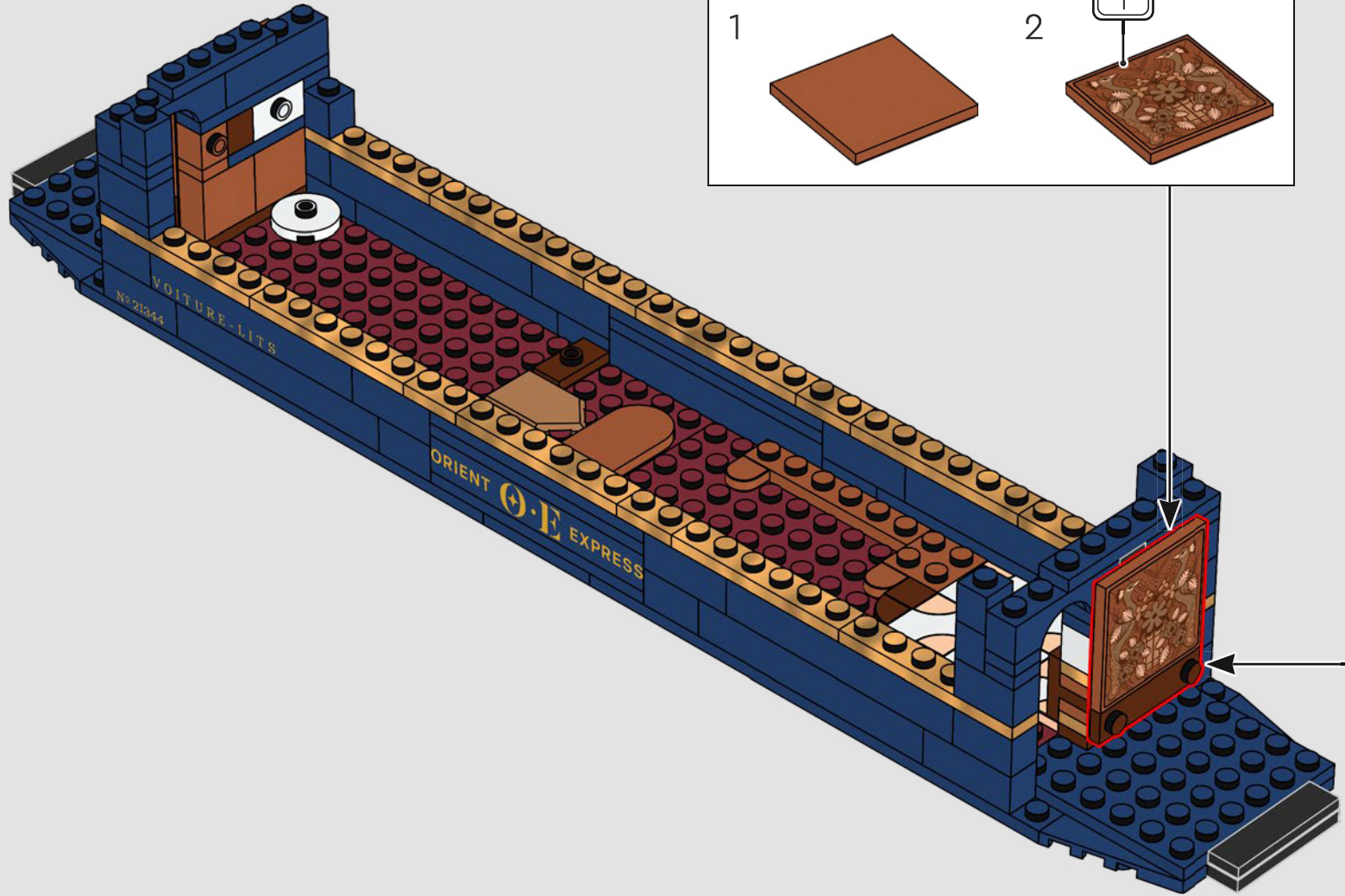

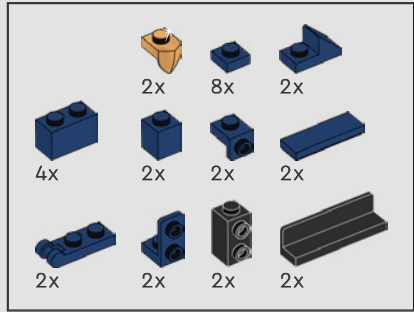
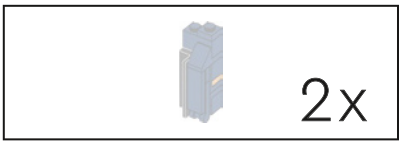

164

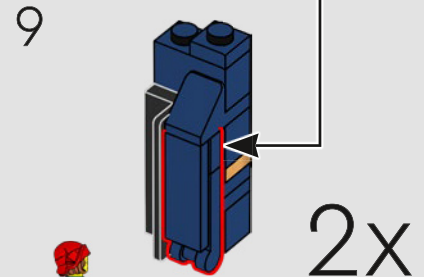
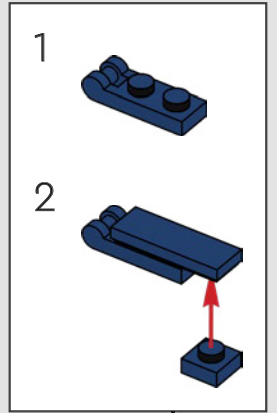
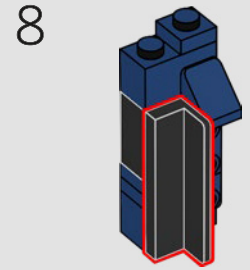
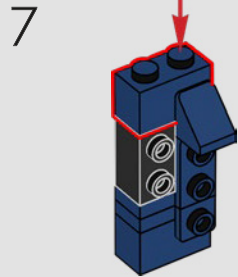
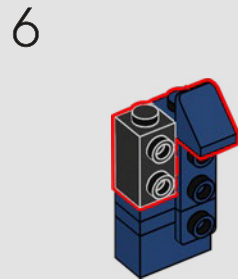
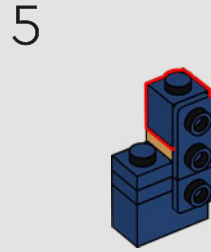
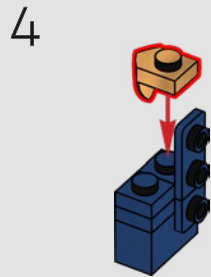
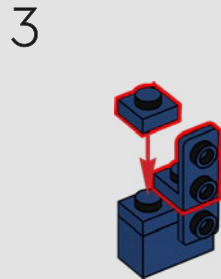
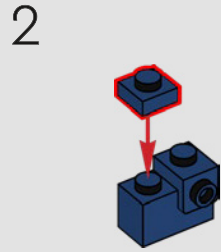
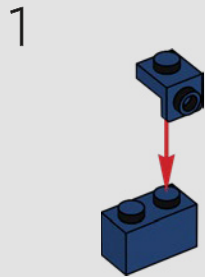

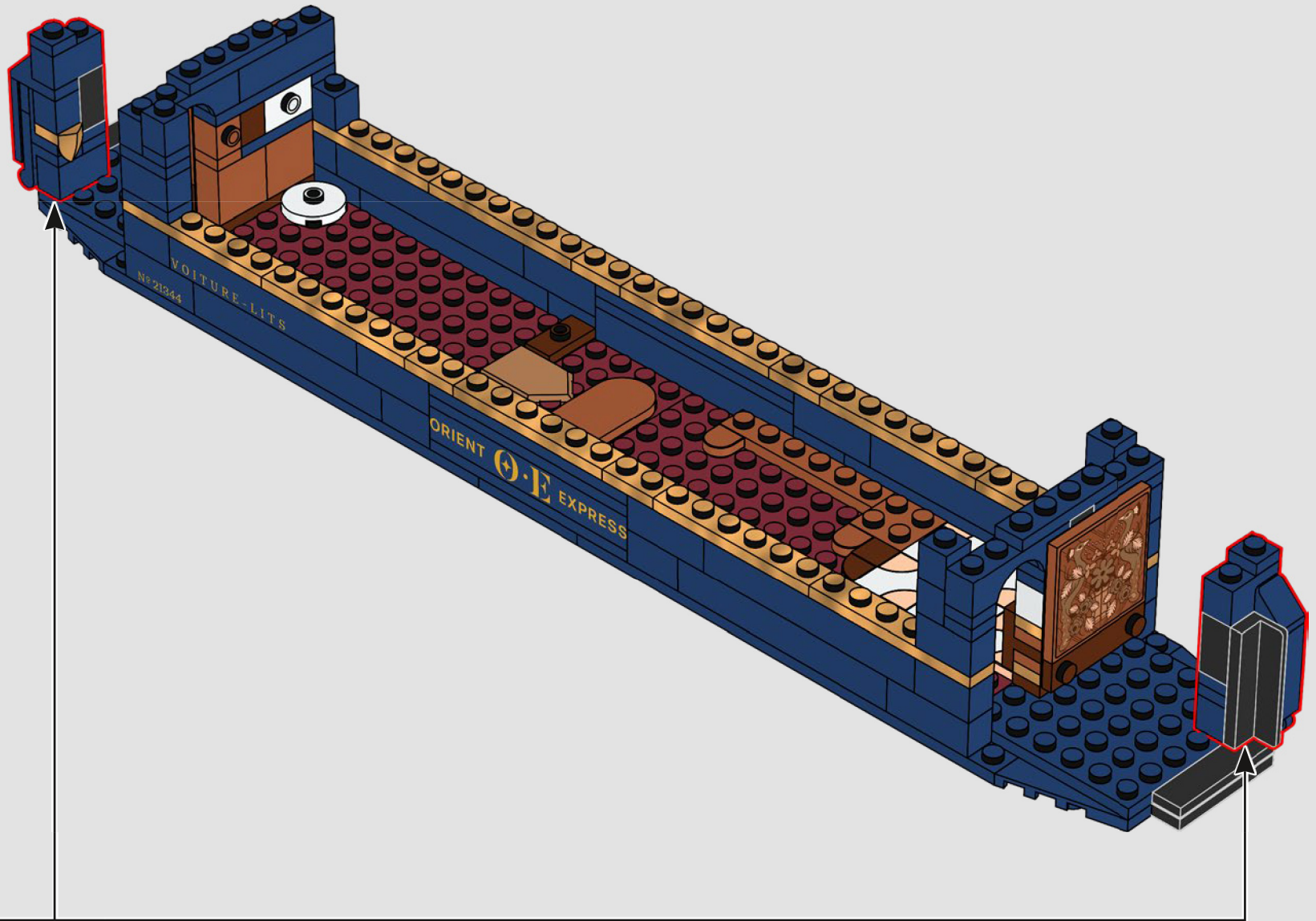



2x

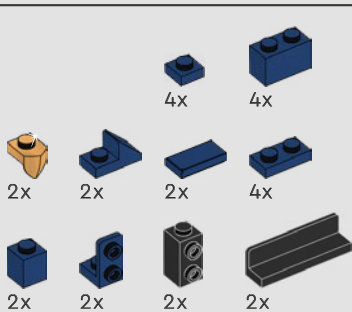

165

1

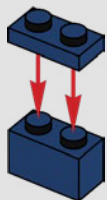

2

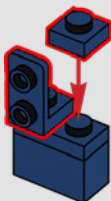

3

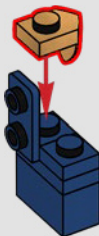

4

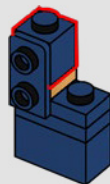

5

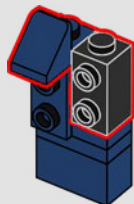

6

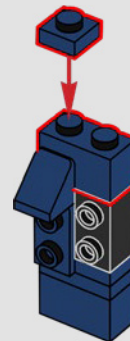

7

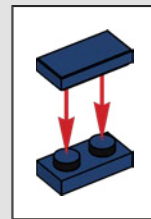

8

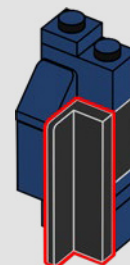

2x



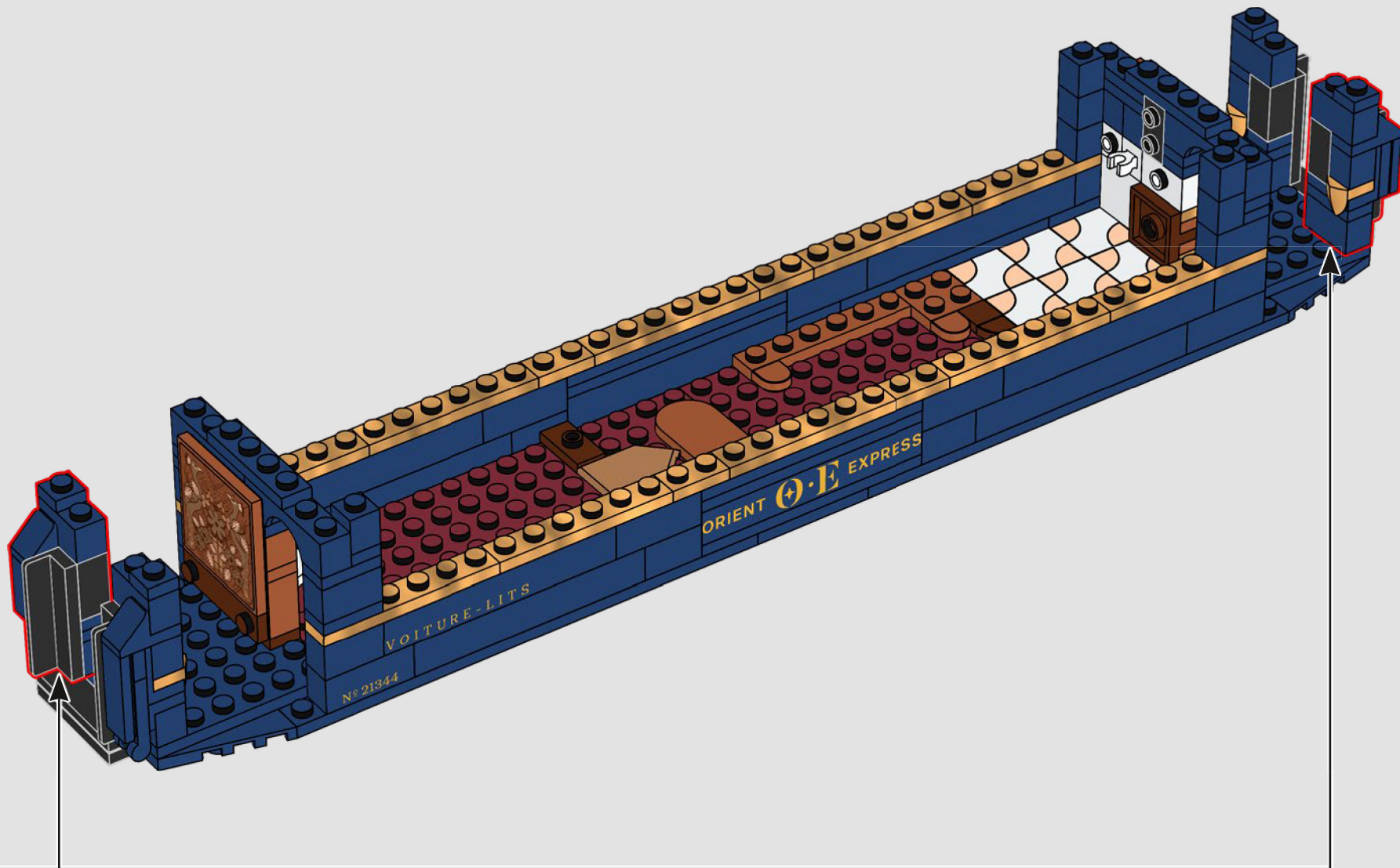

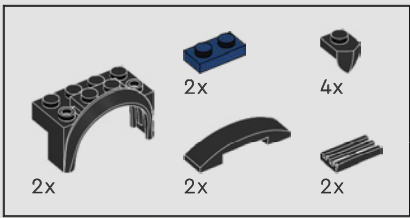

166

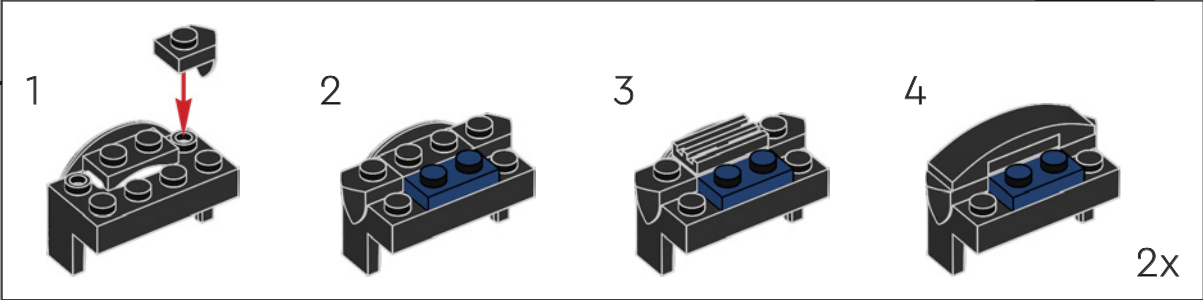
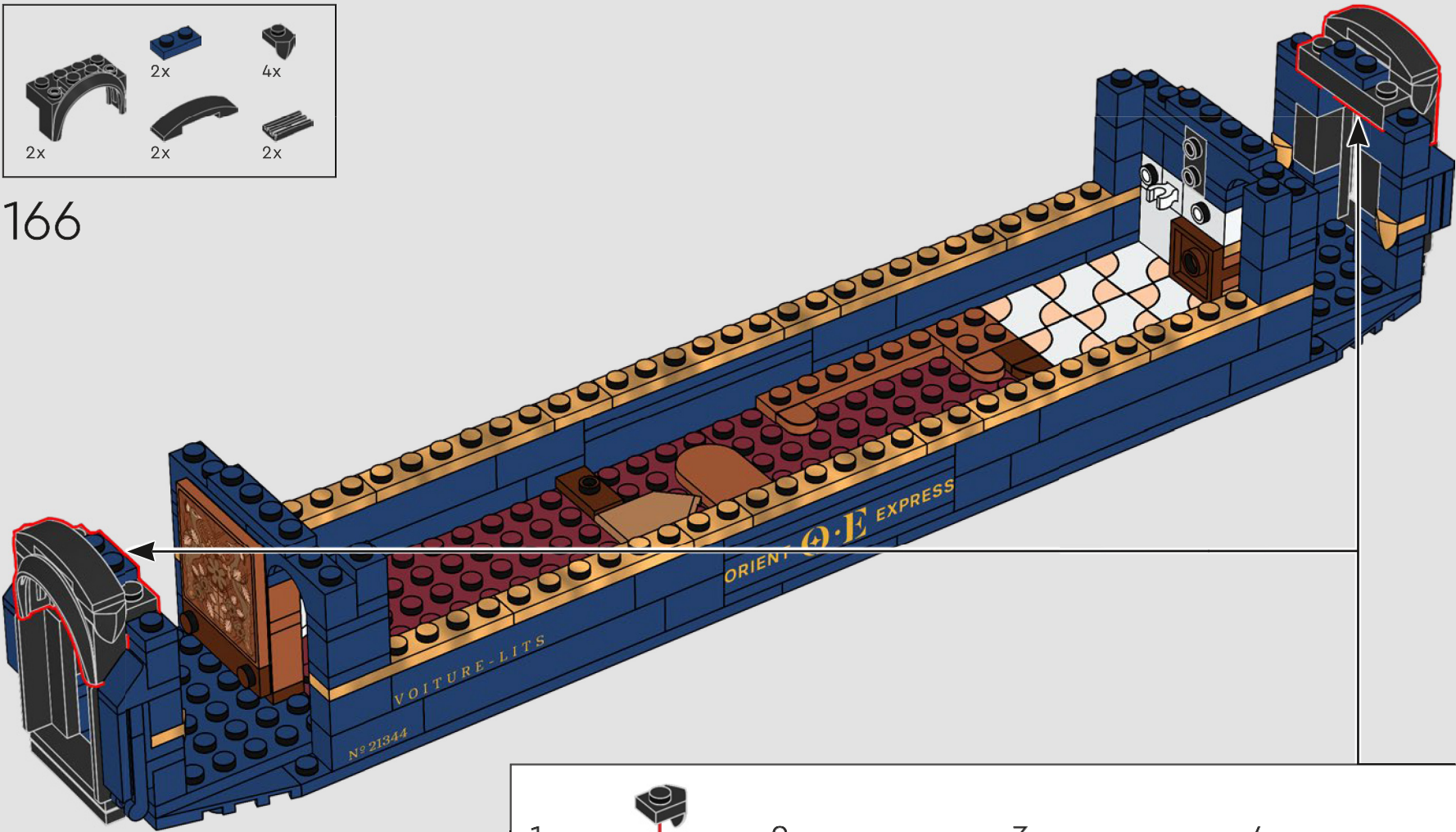

..... ●
"Cada cama tiene su propio revisor,
que atiende todas nuestras necesidades".

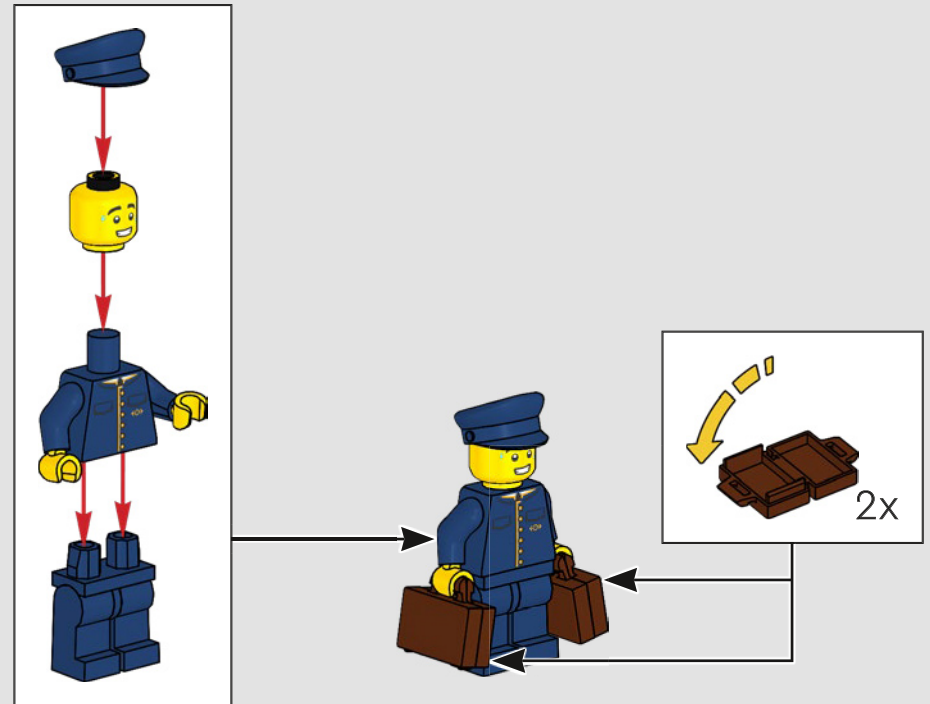

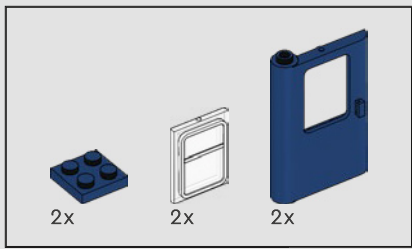

167

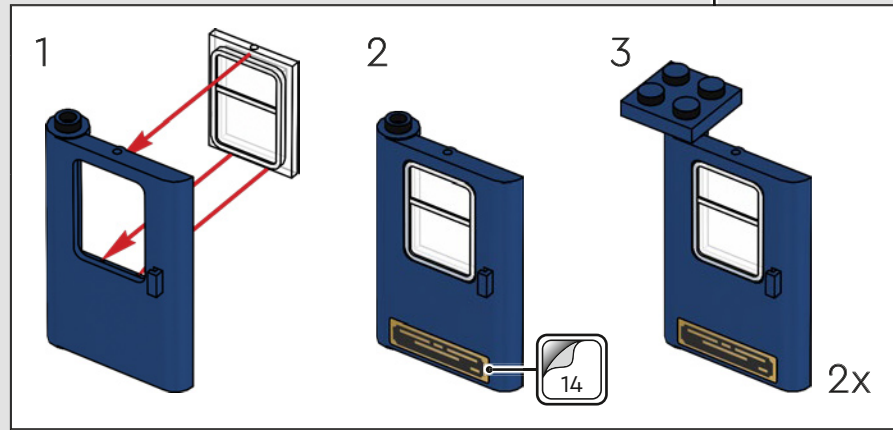
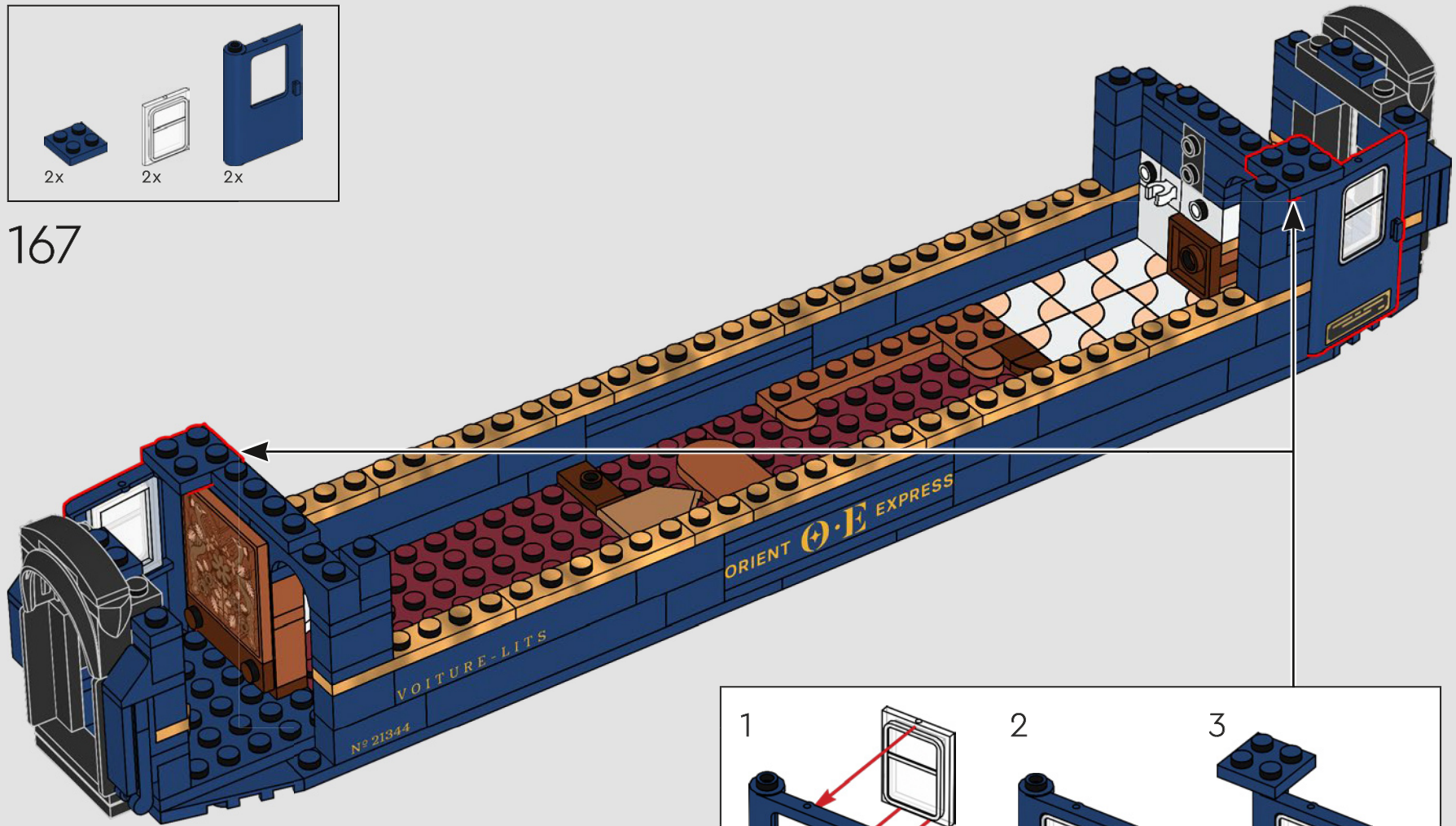

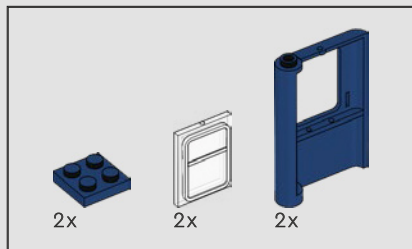

168

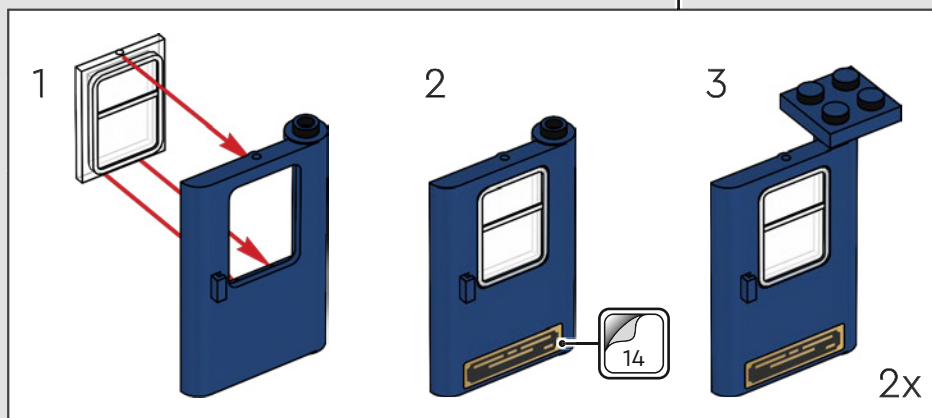
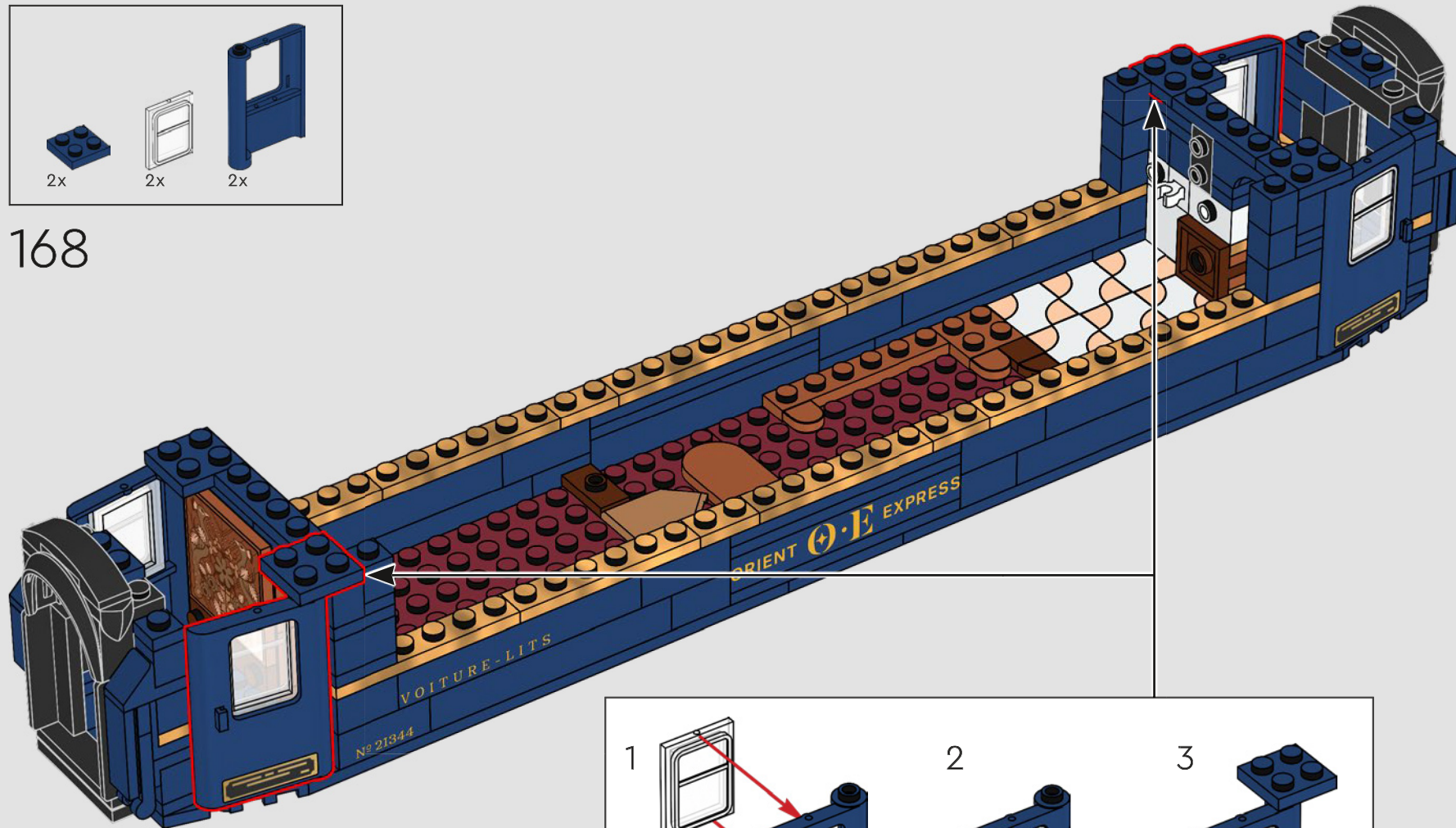

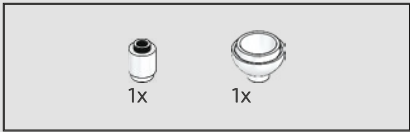

169

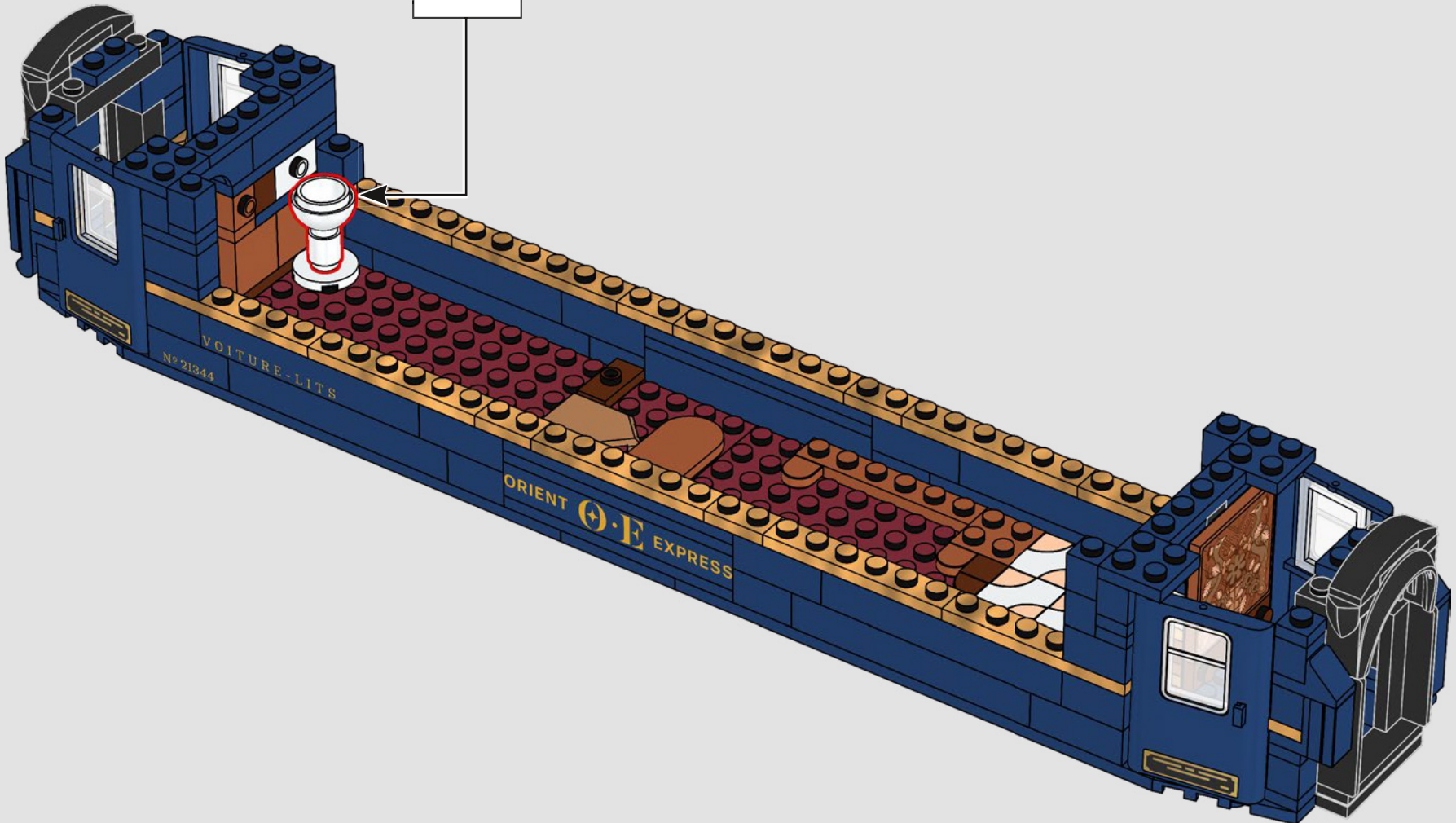



170

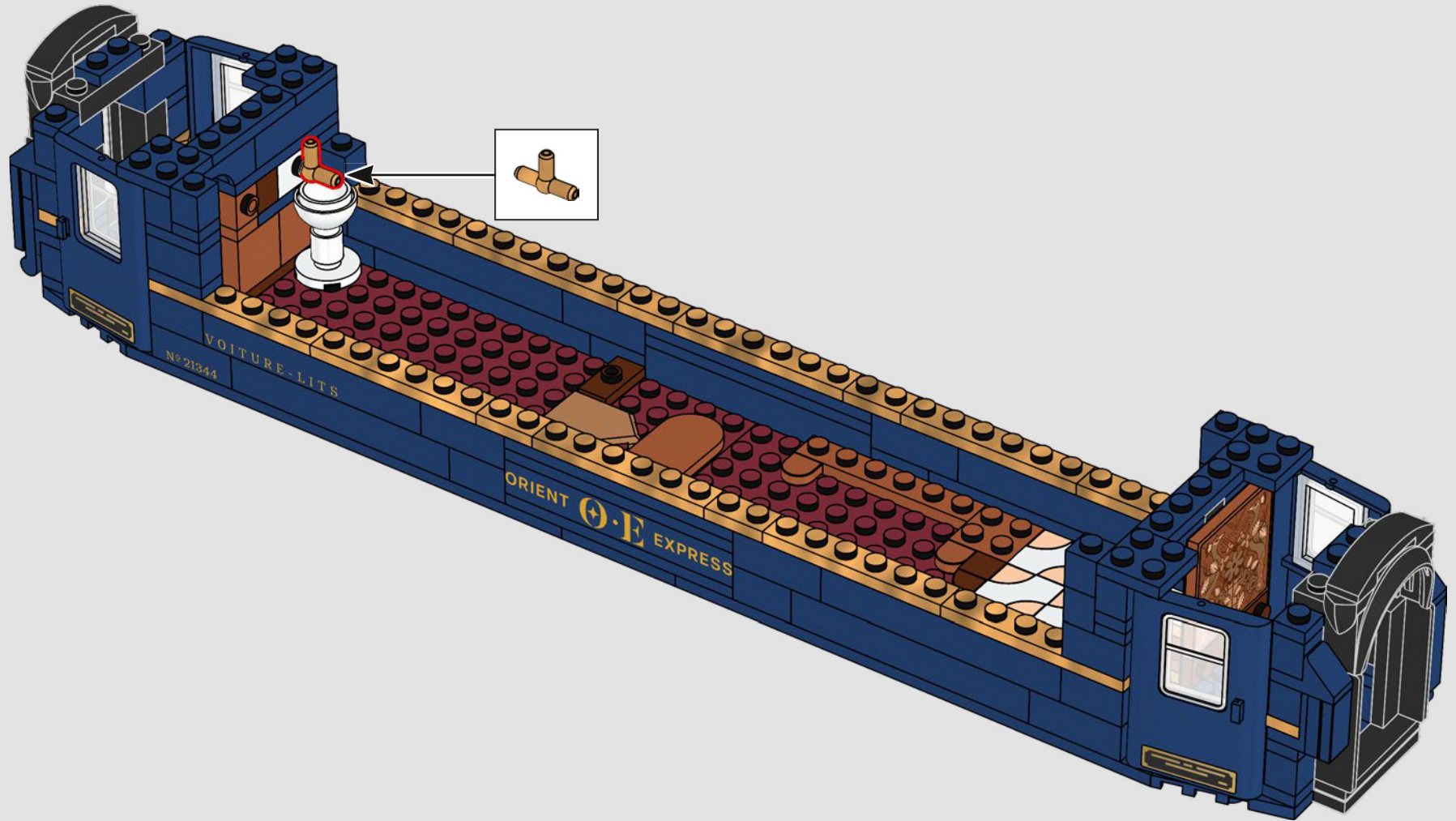

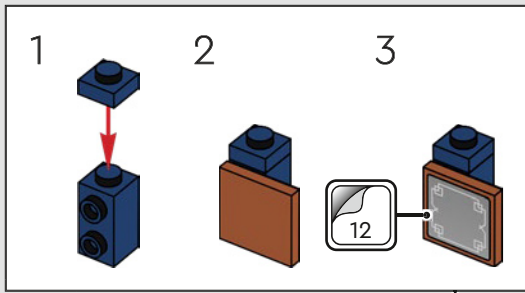
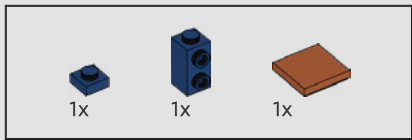

171

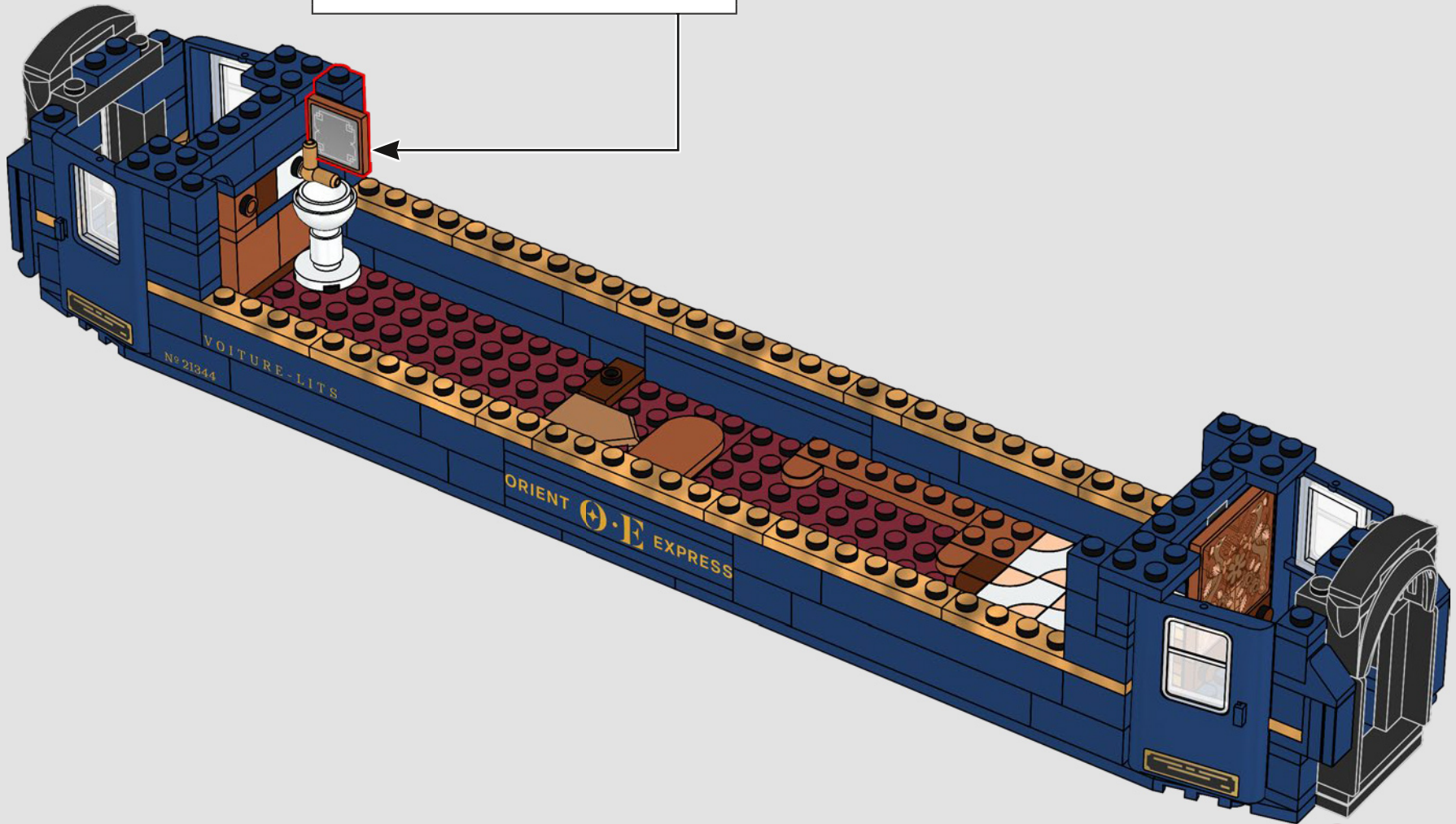

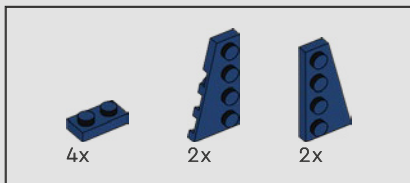

172

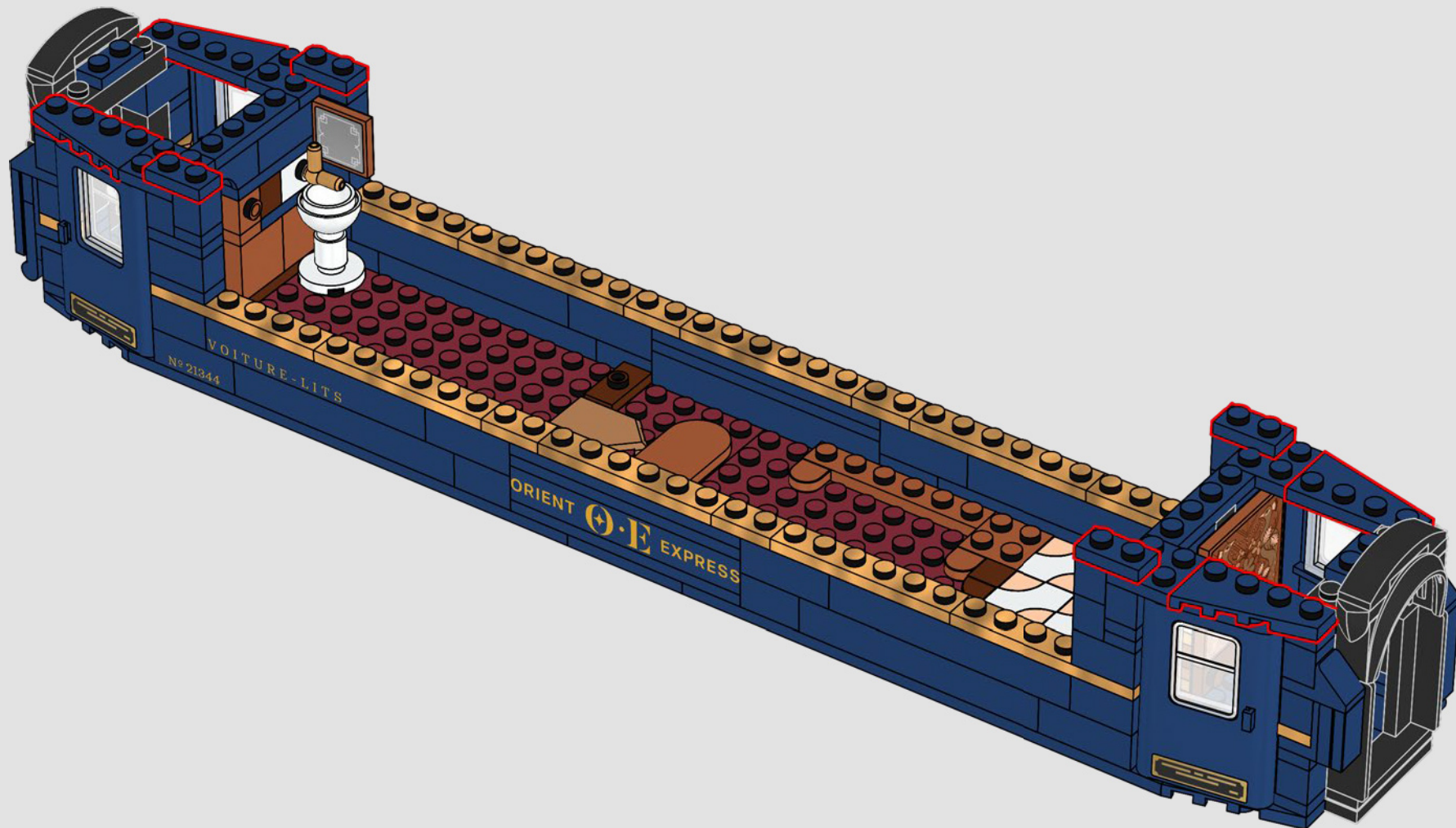

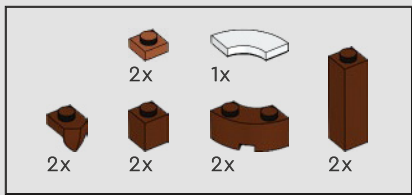

173

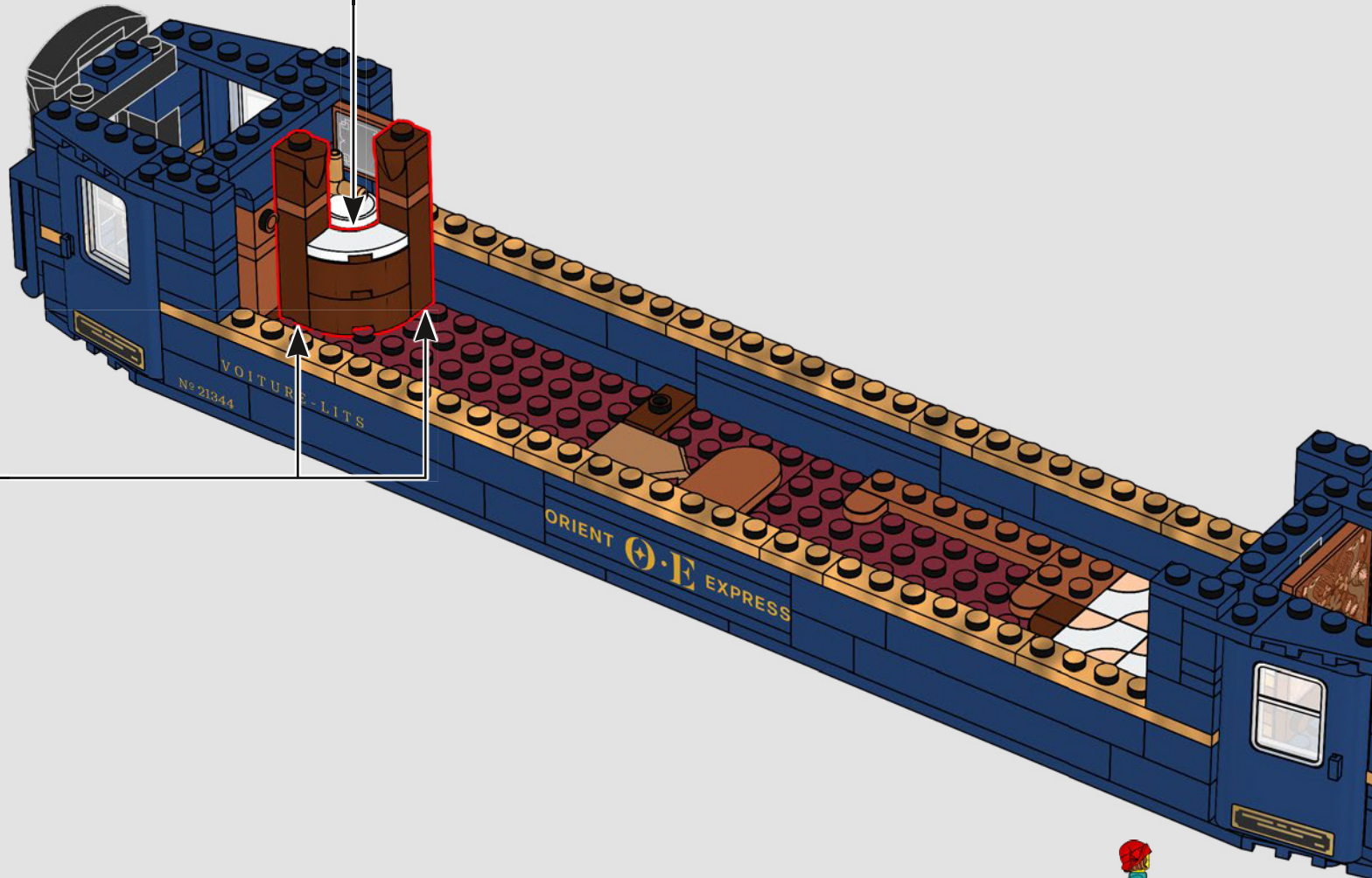
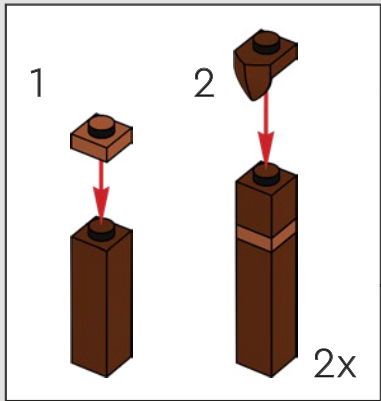
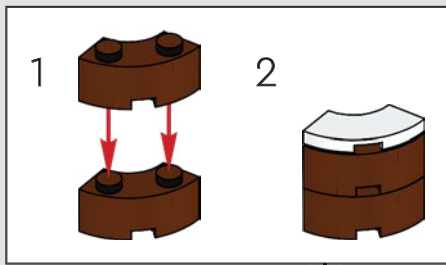

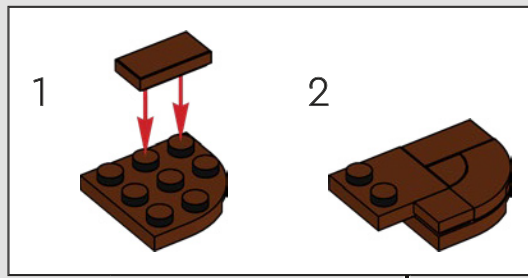
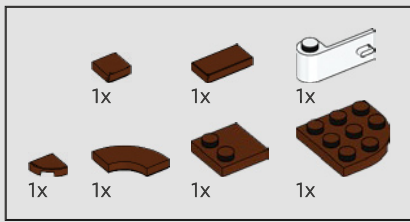

174

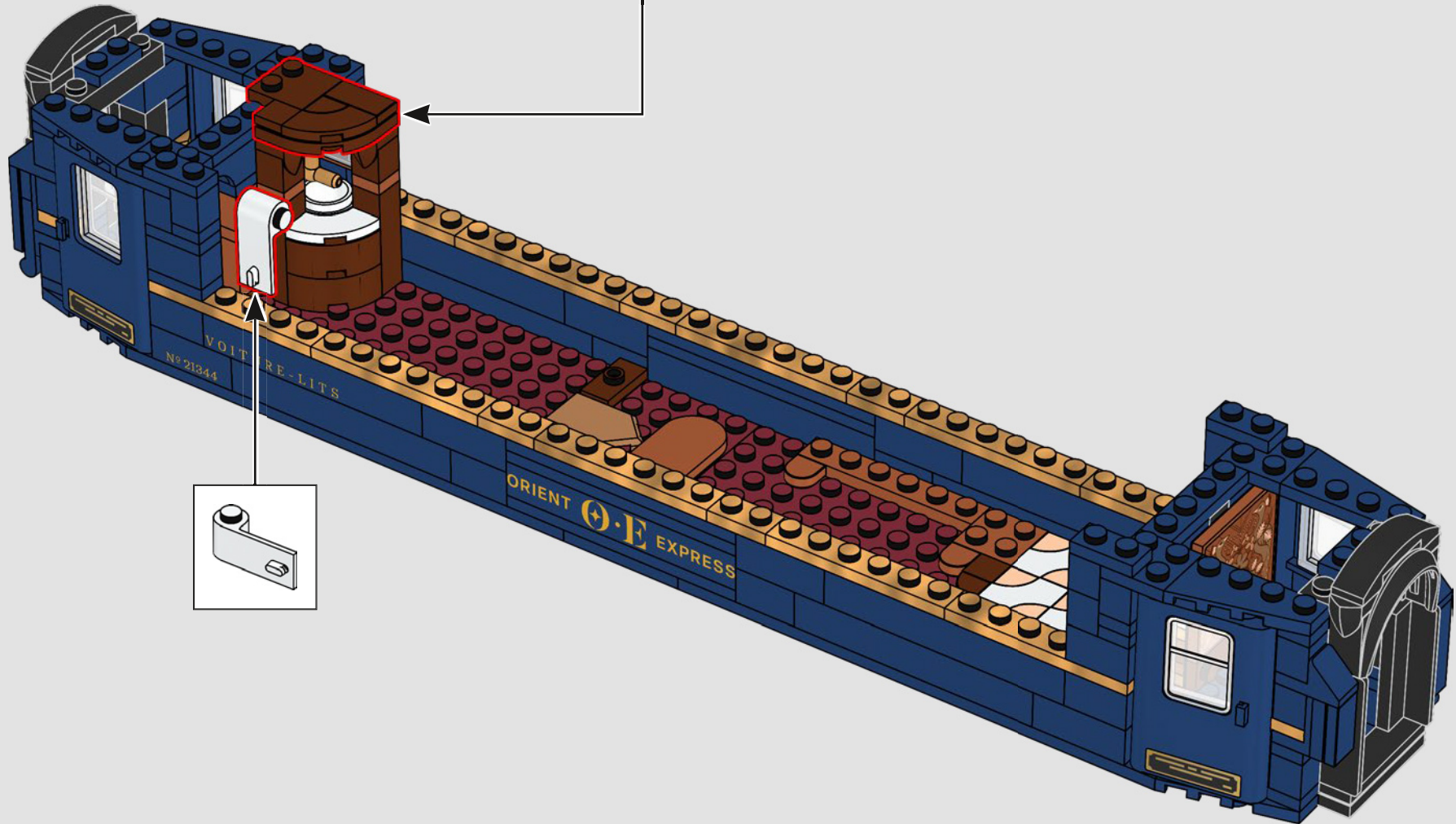



175

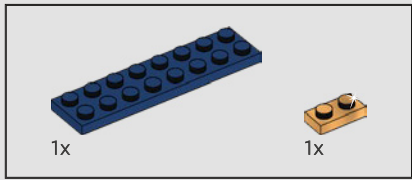
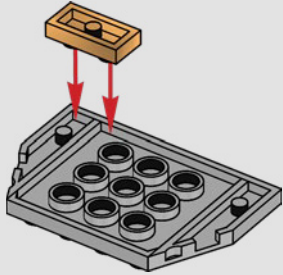

176

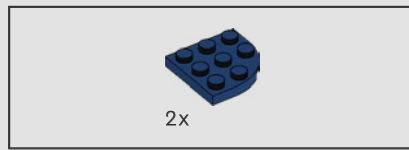
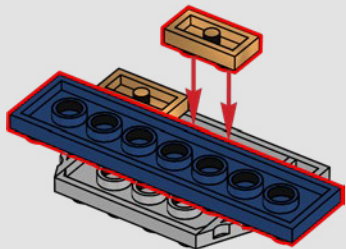

177

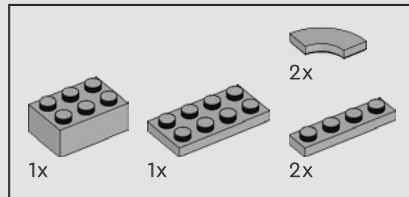
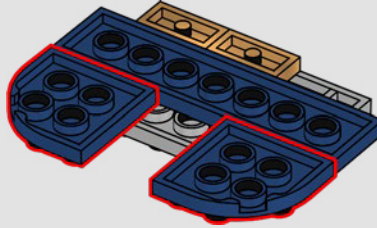

178

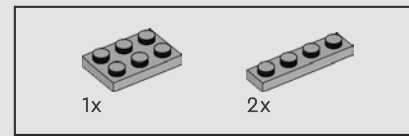
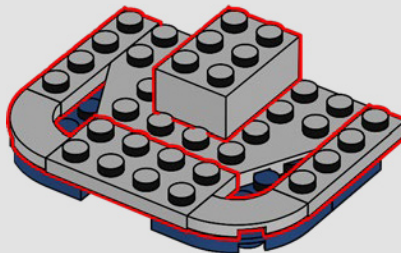

179

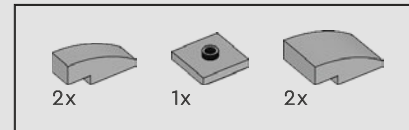
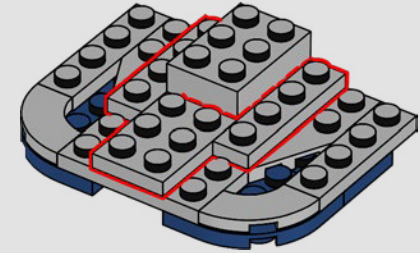

180

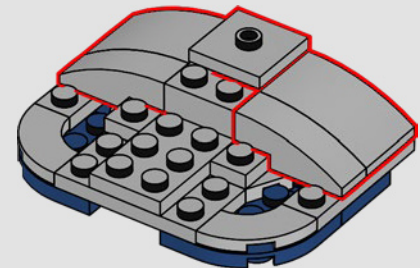

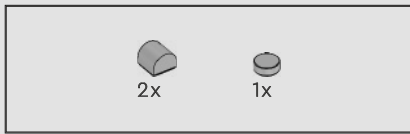

181

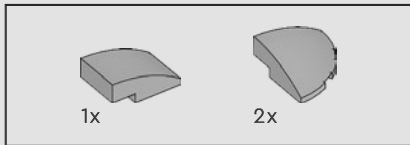
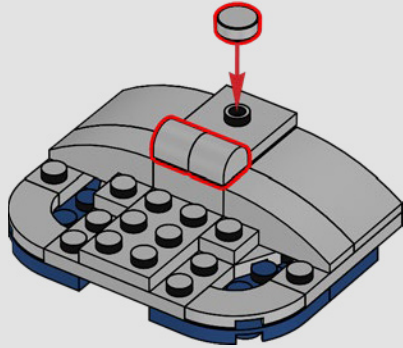

182

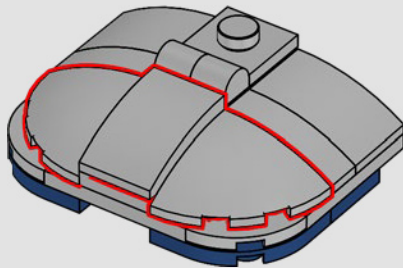

183

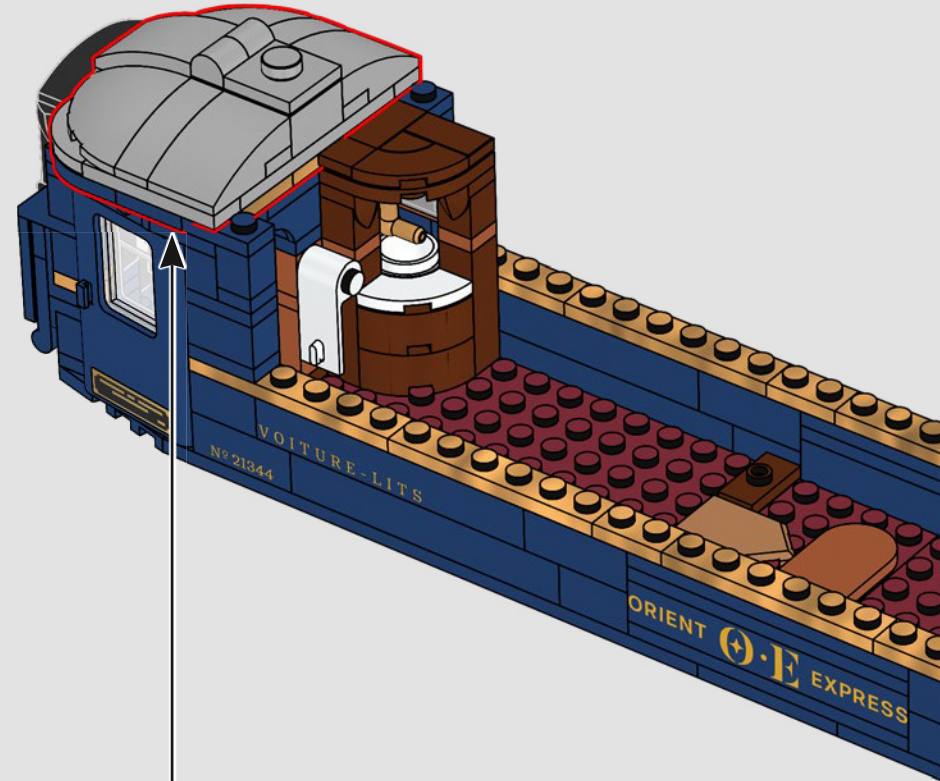

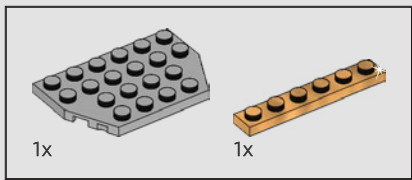

184

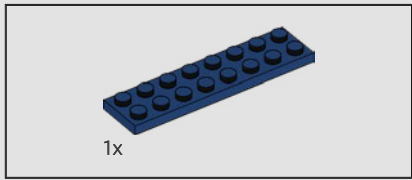
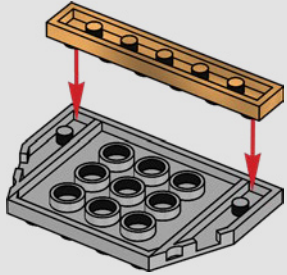

185

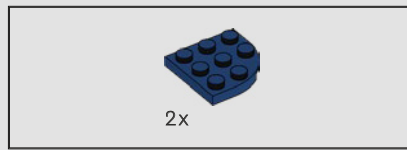
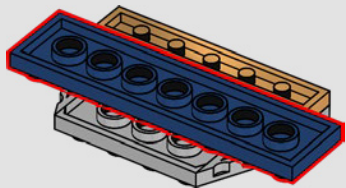

186

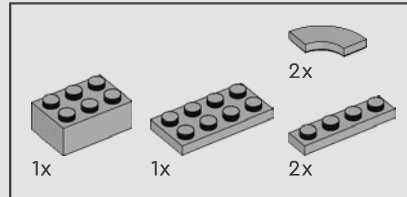
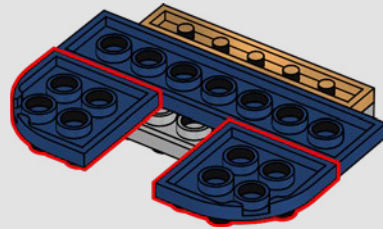

187

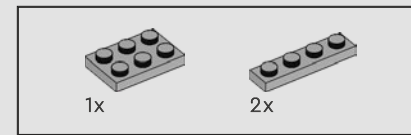
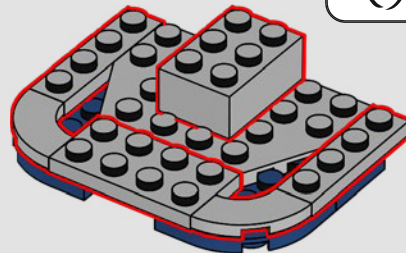

188

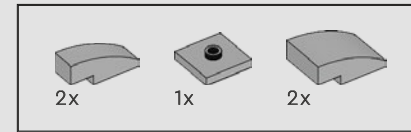
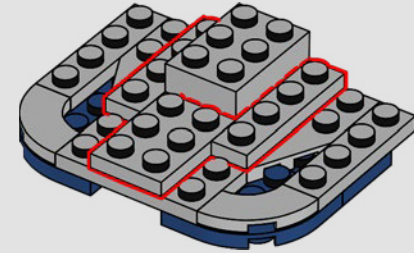

189

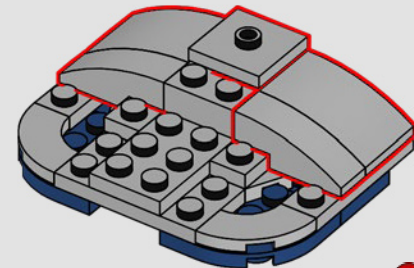

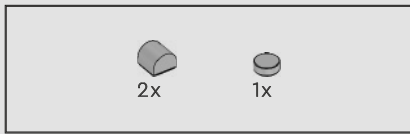

190

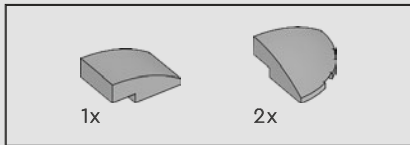
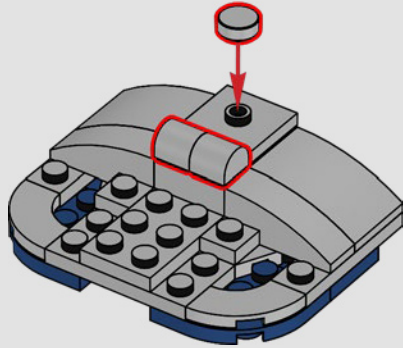

191

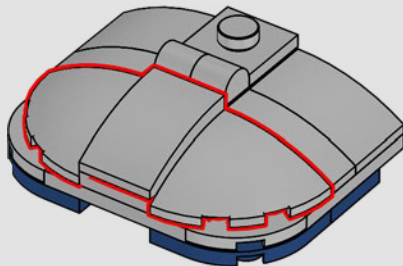

192

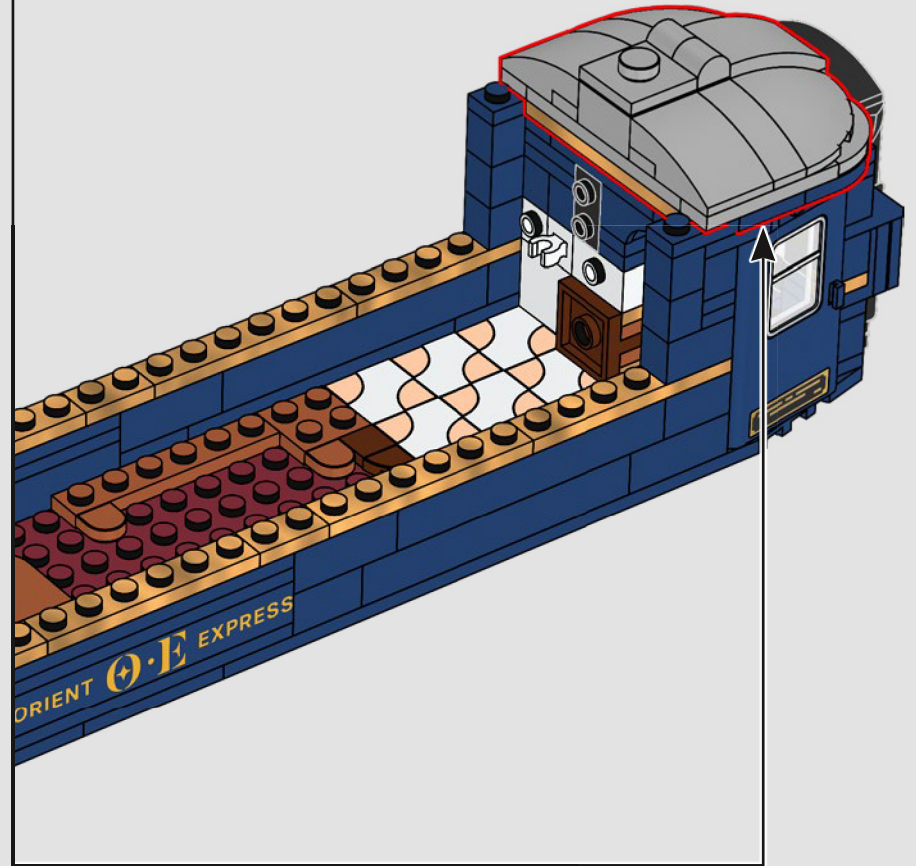

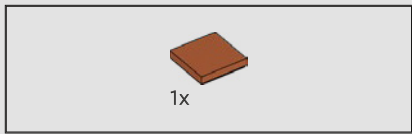

193

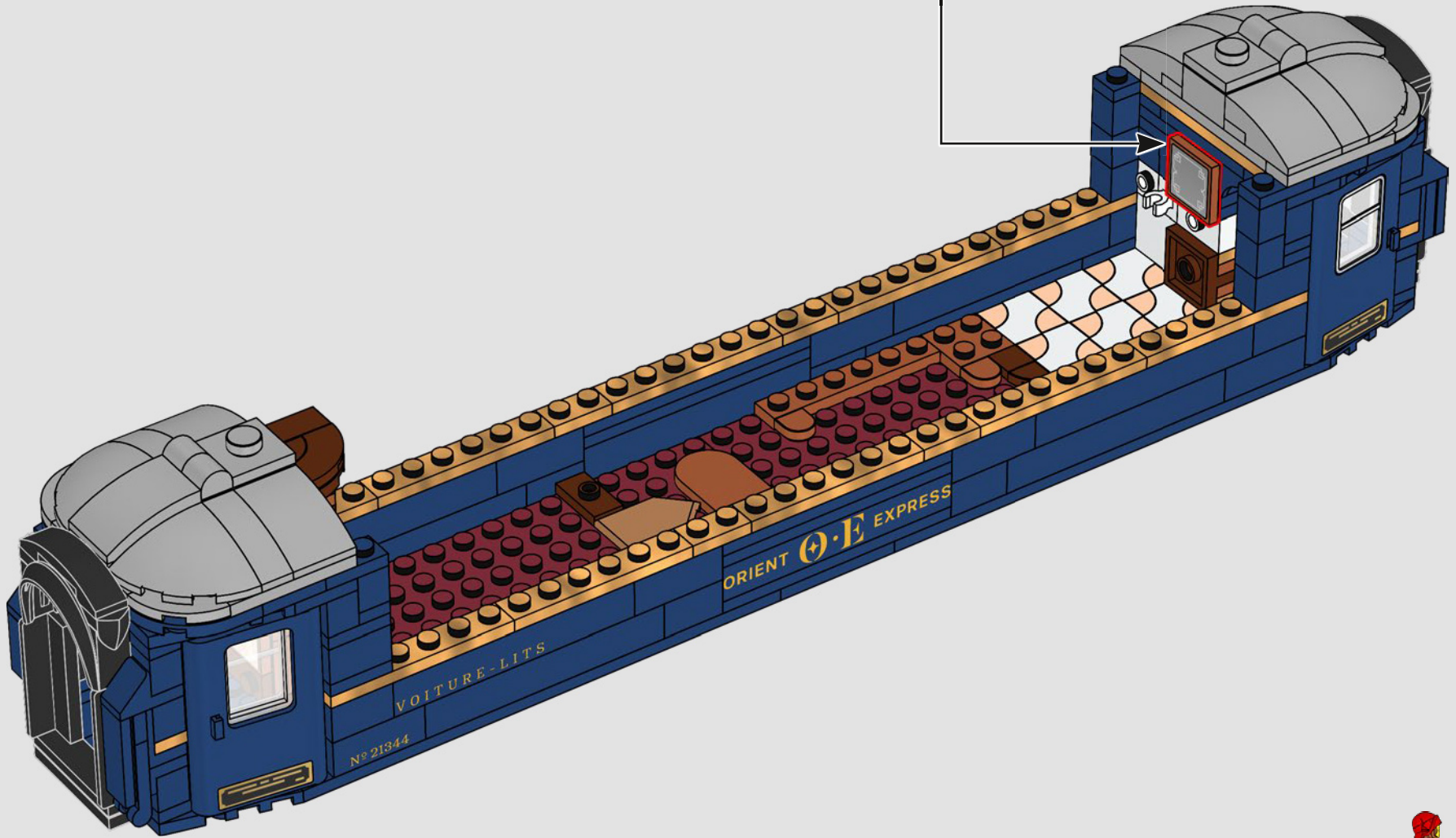
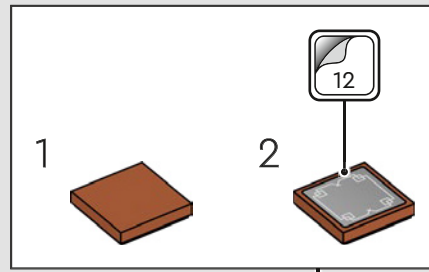

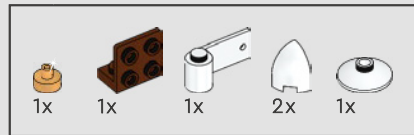

194

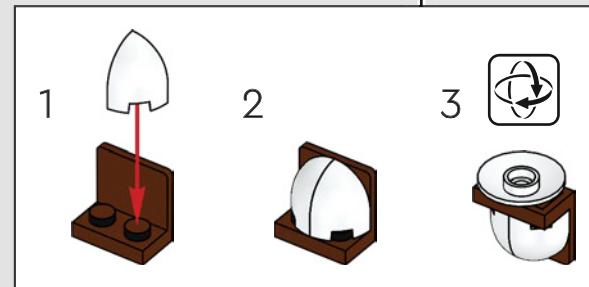
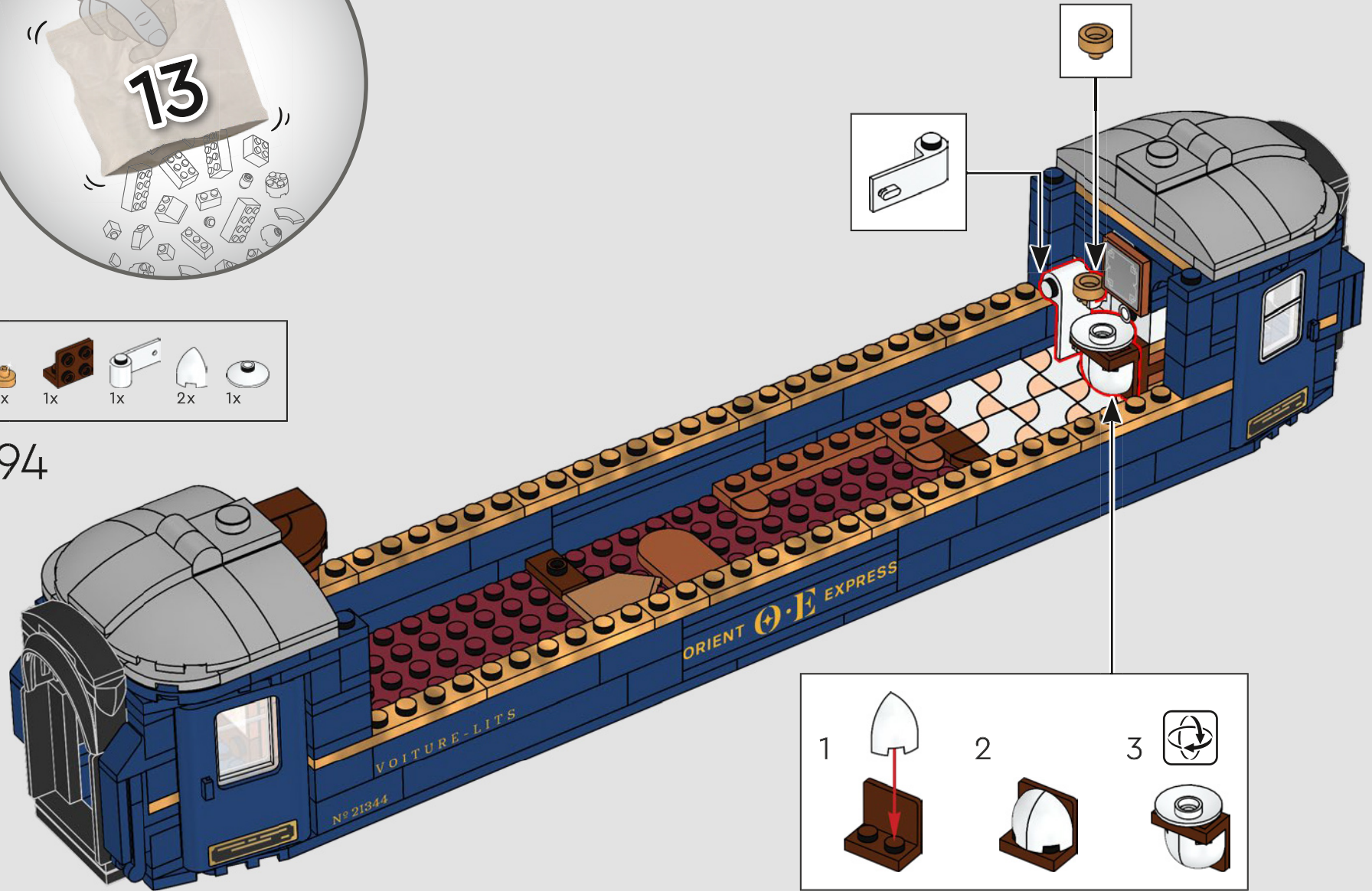

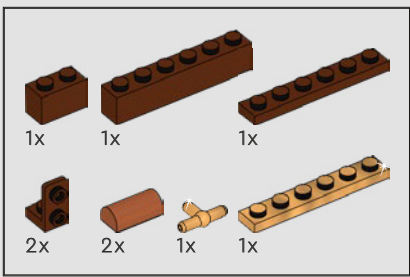

195

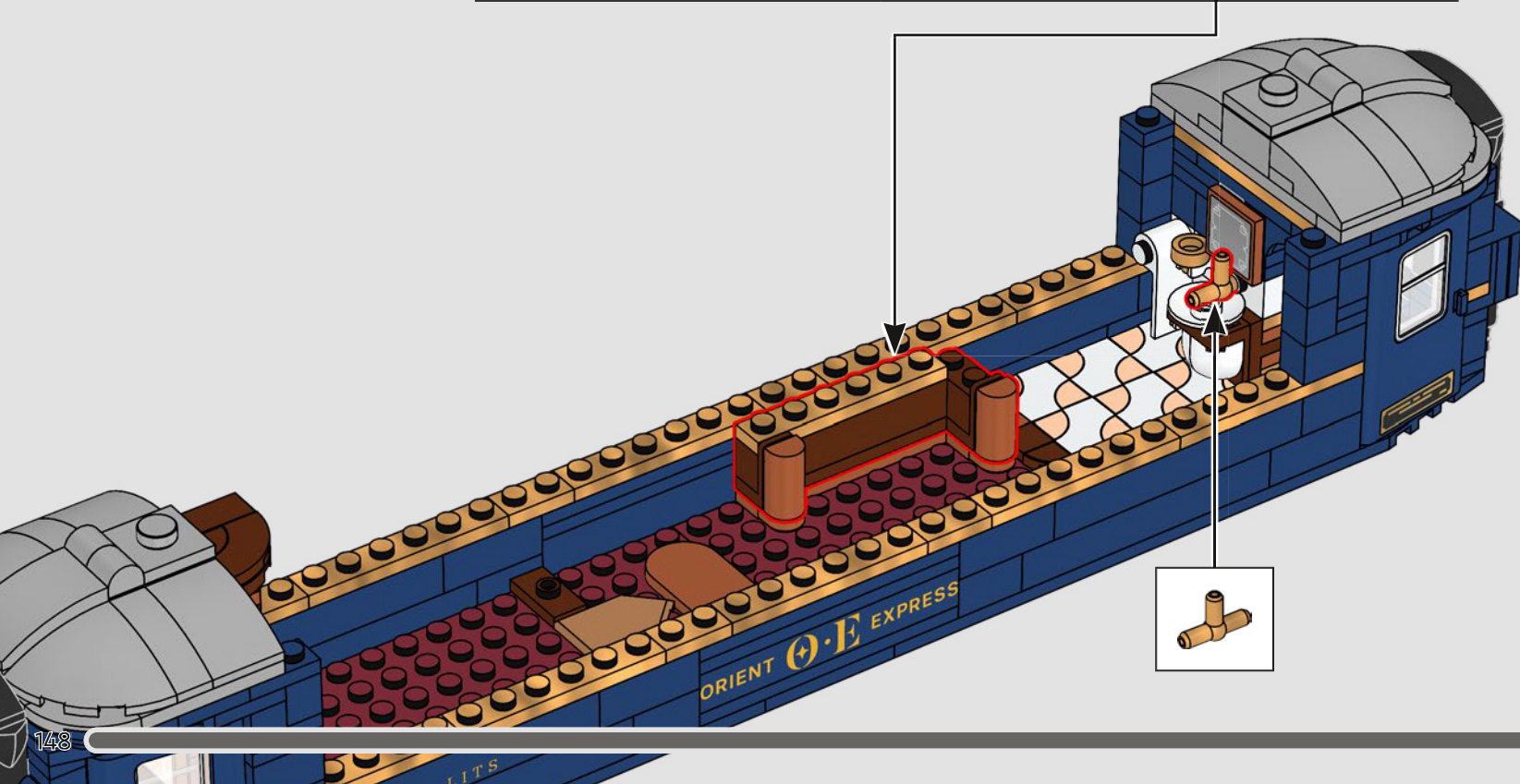
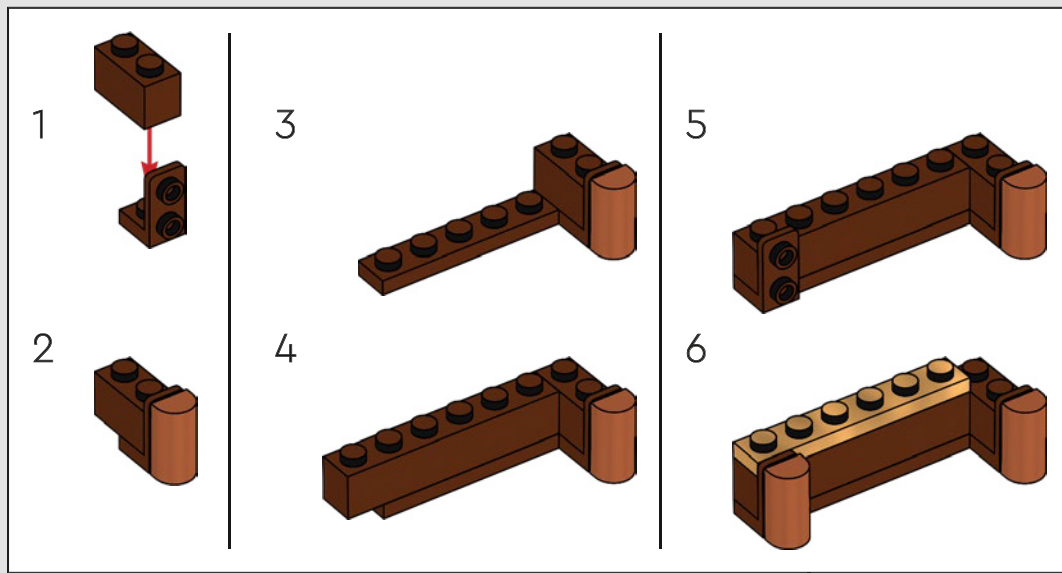

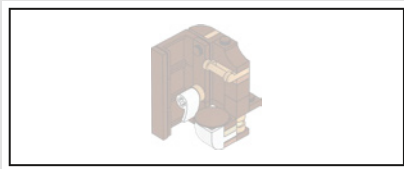

196

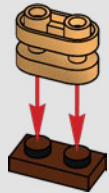

197



198

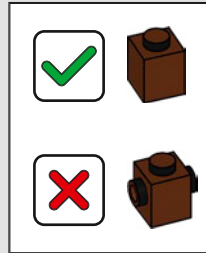

199

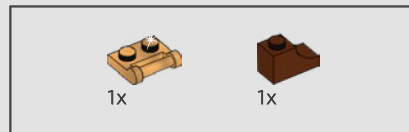
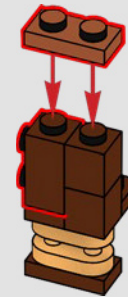
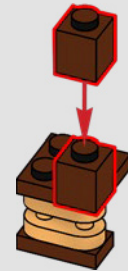

200



201

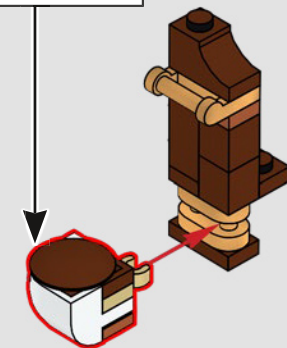
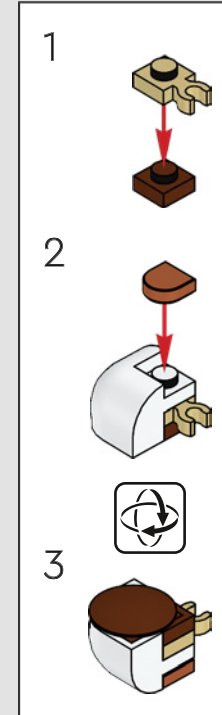

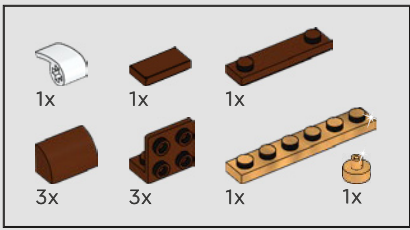

202

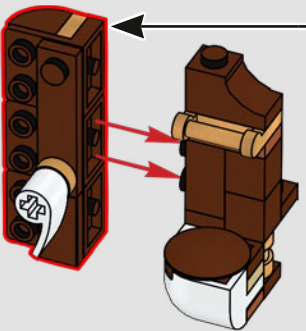
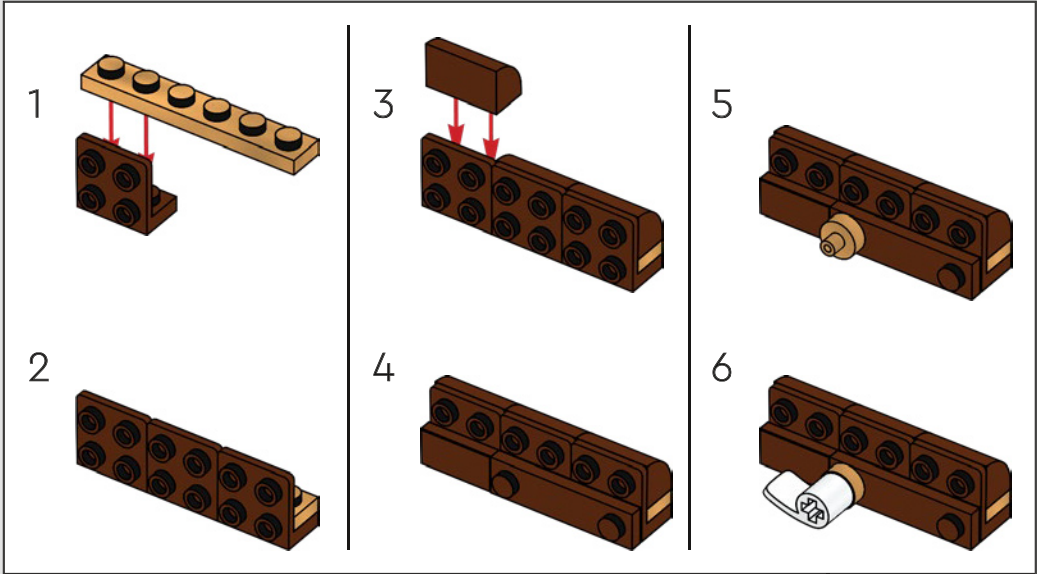

203

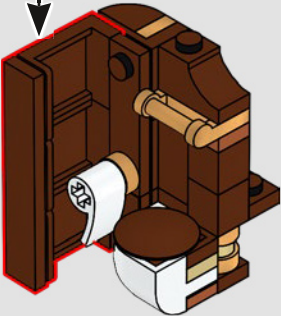
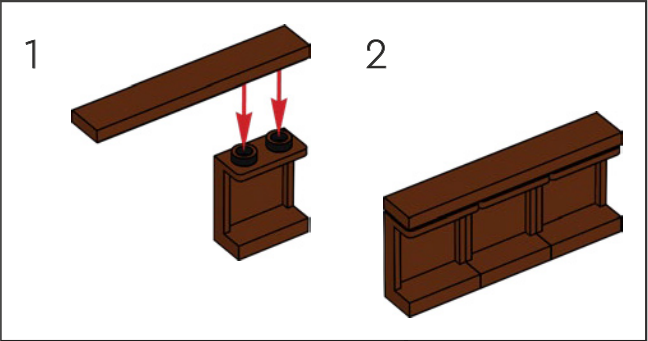

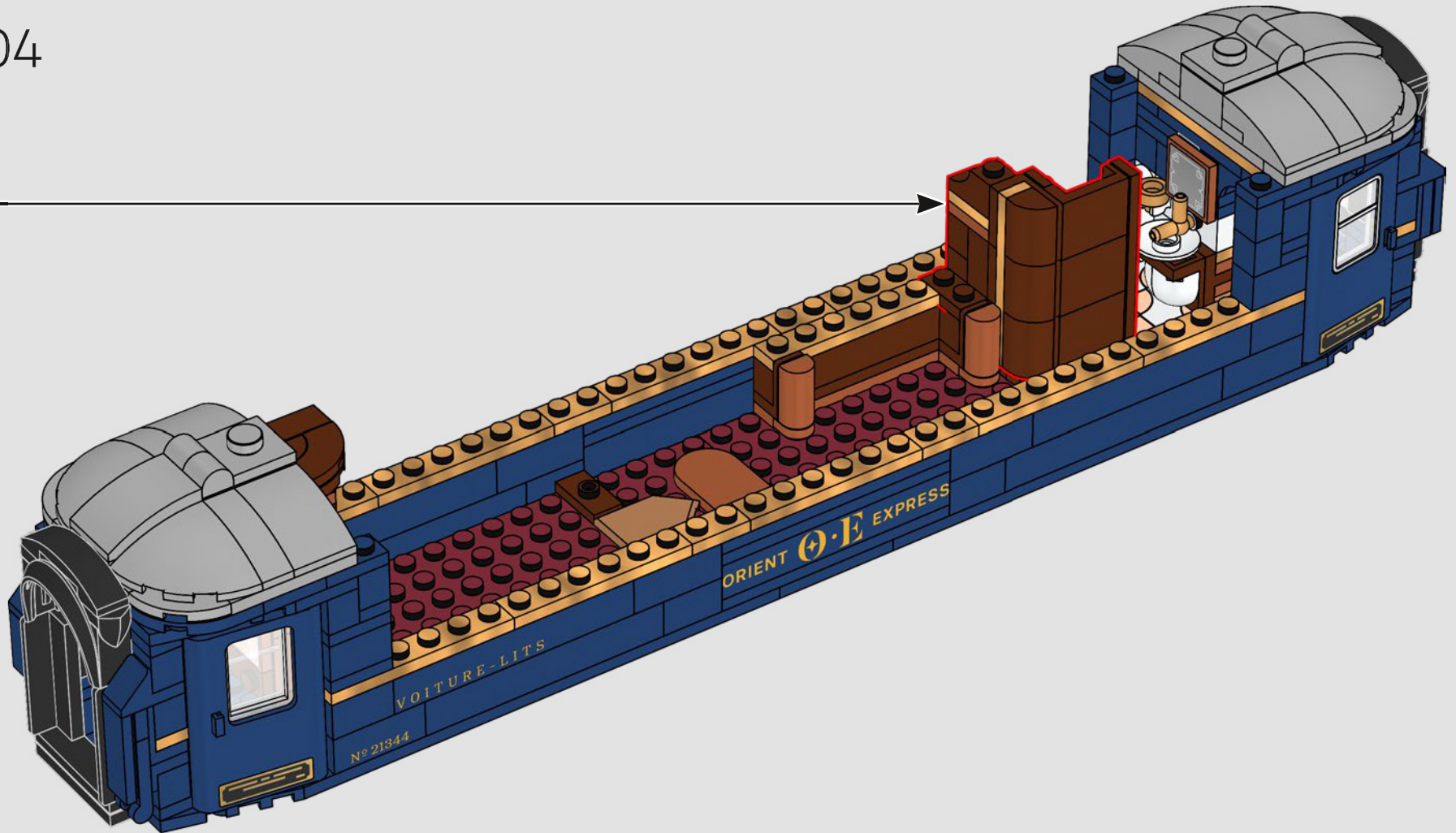

..... ●
"Los compartimentos de primera clase cuentan con un cuarto de baño privado decorado con encantadoras baldosas".

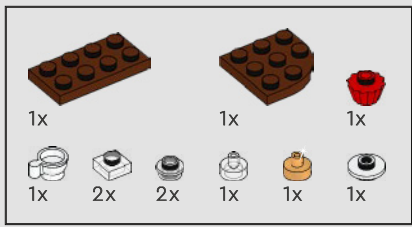

205

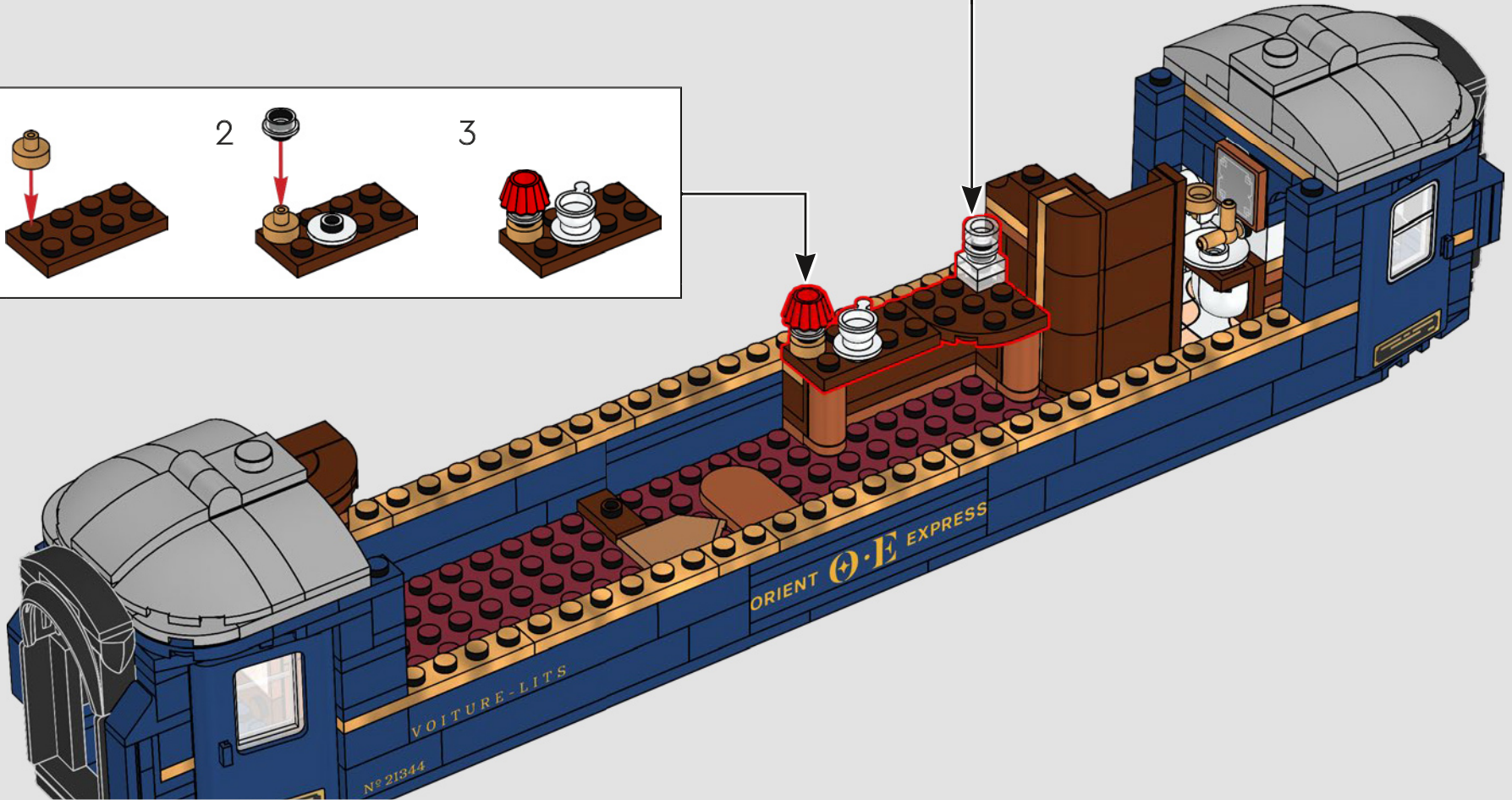
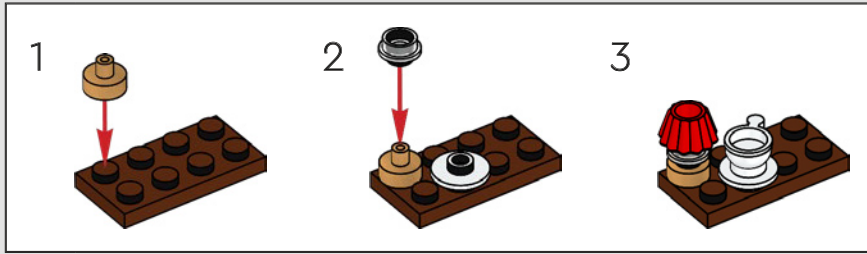
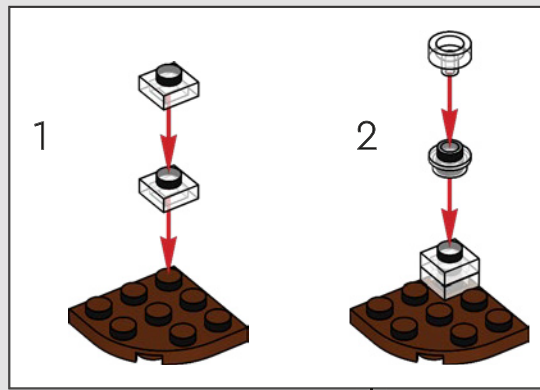

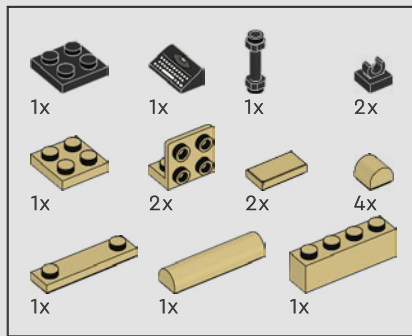

206

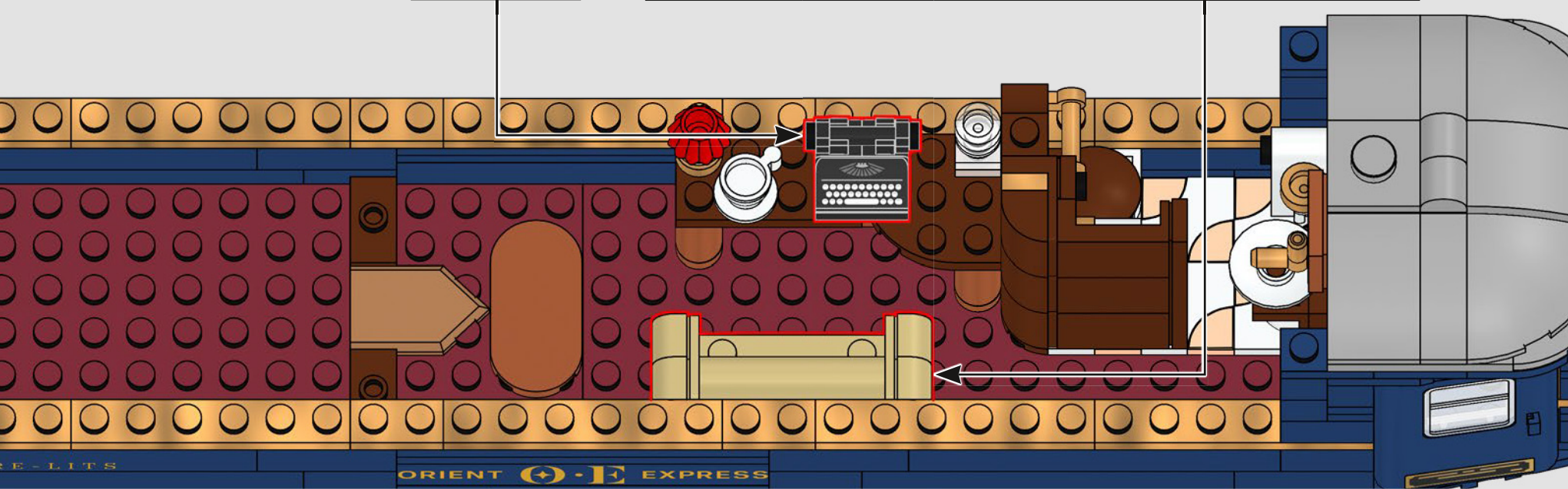
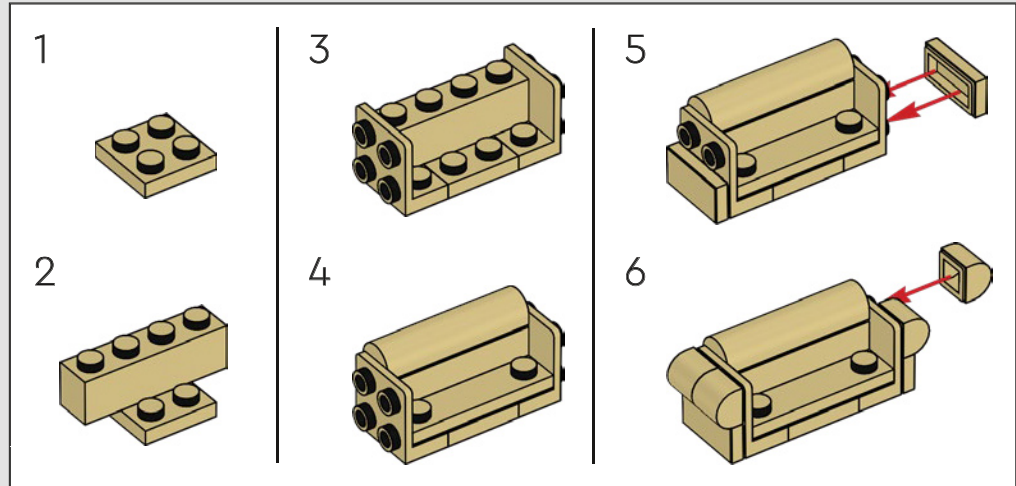
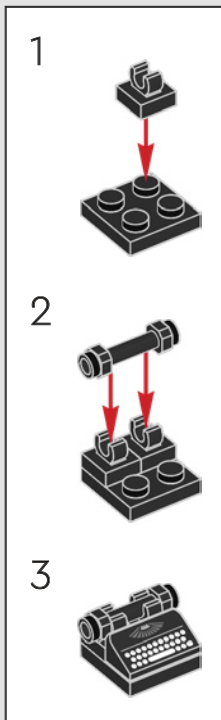

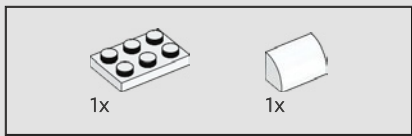

207

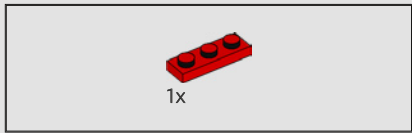
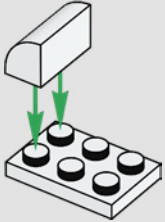

208

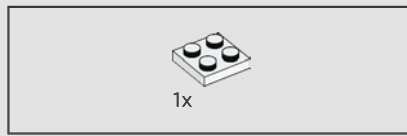
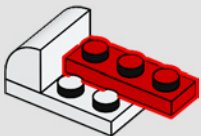

209

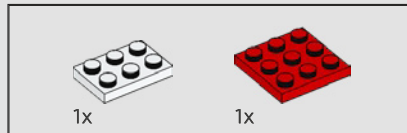
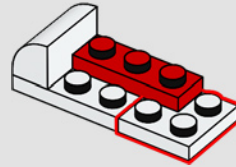

210

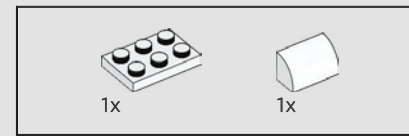
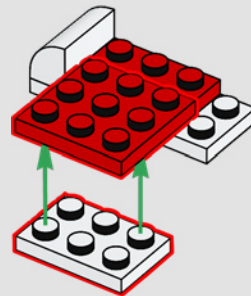

211

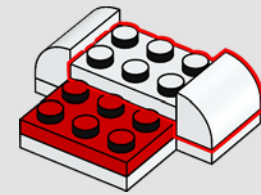

212

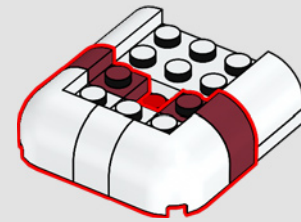

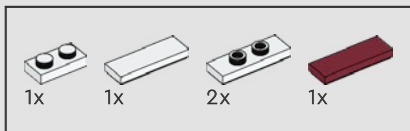

213

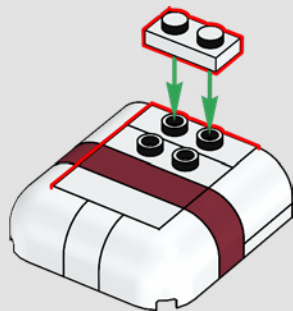

214

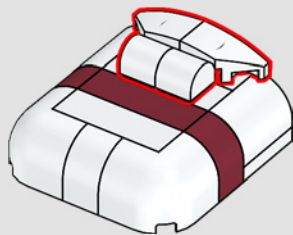

215

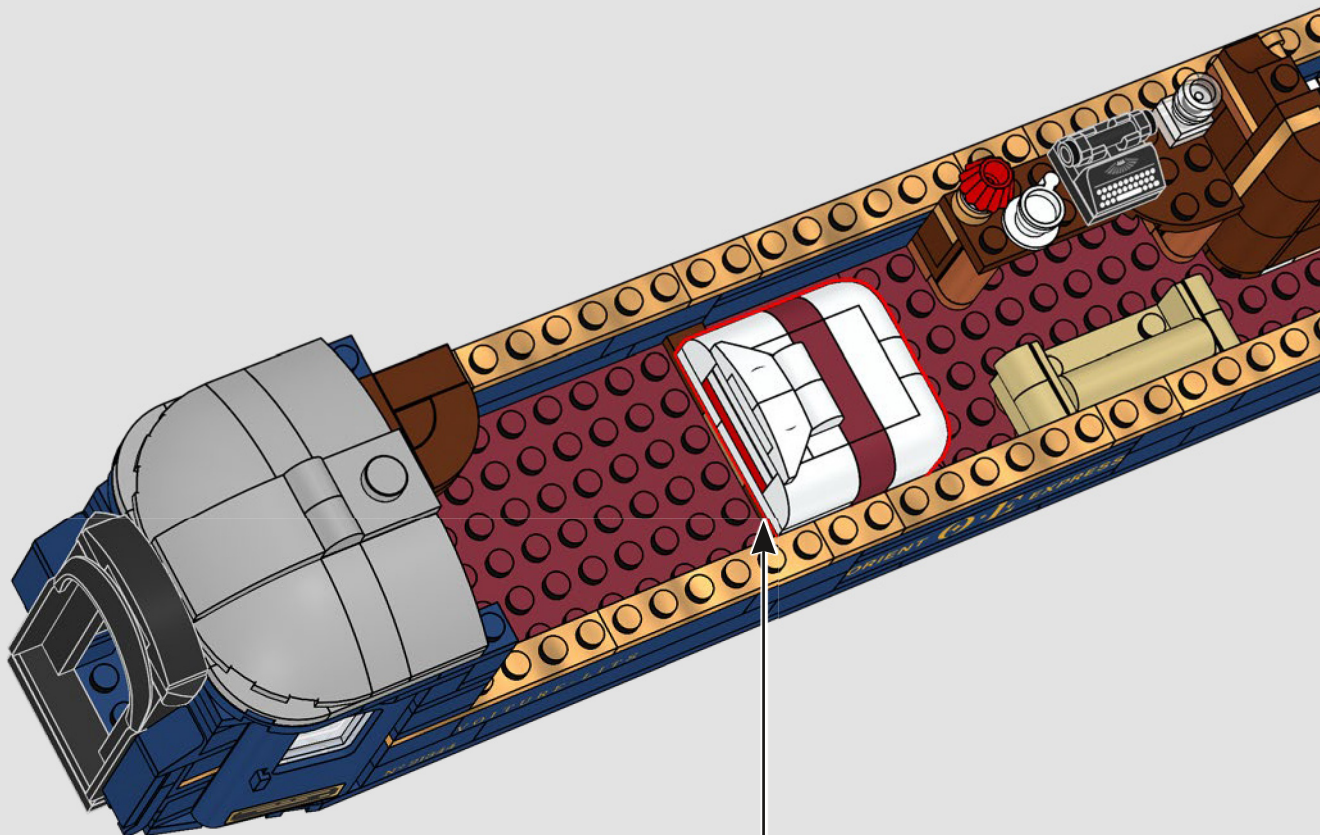

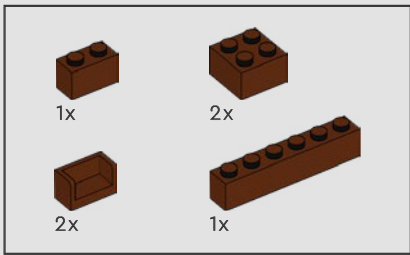

216

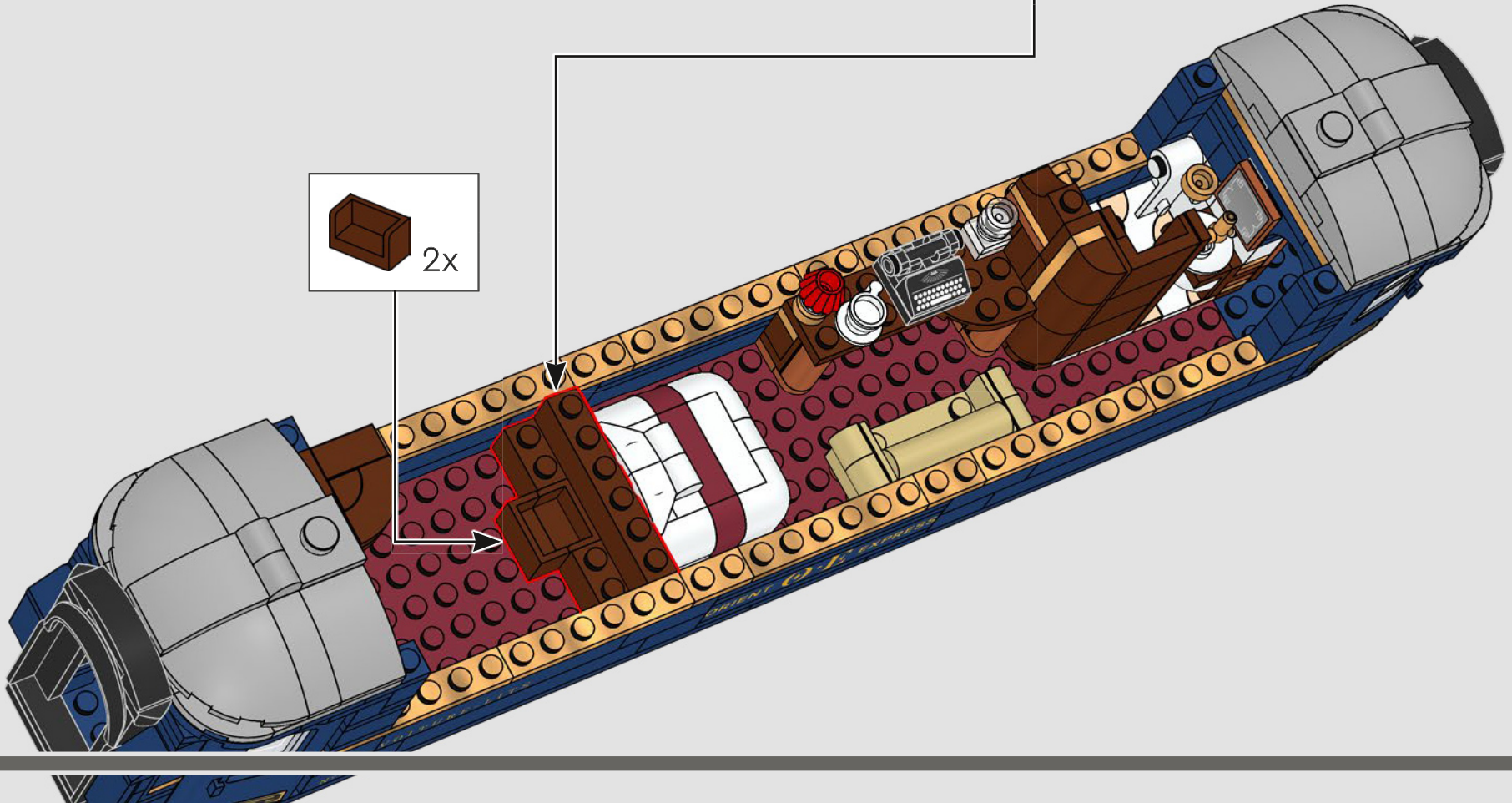
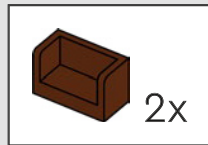
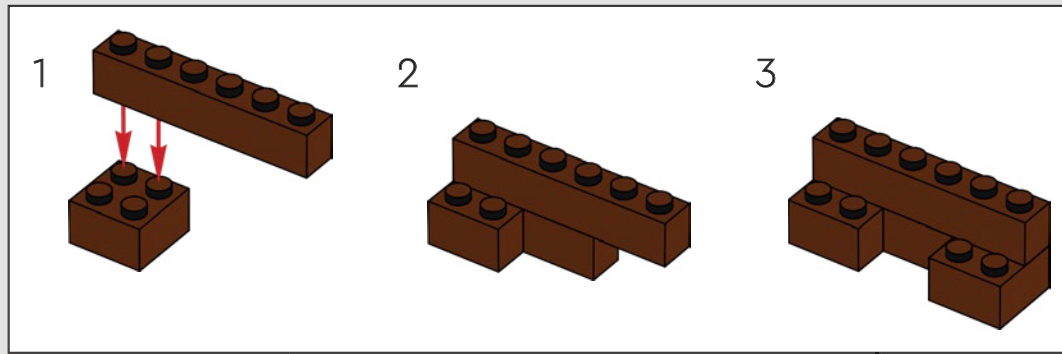



217

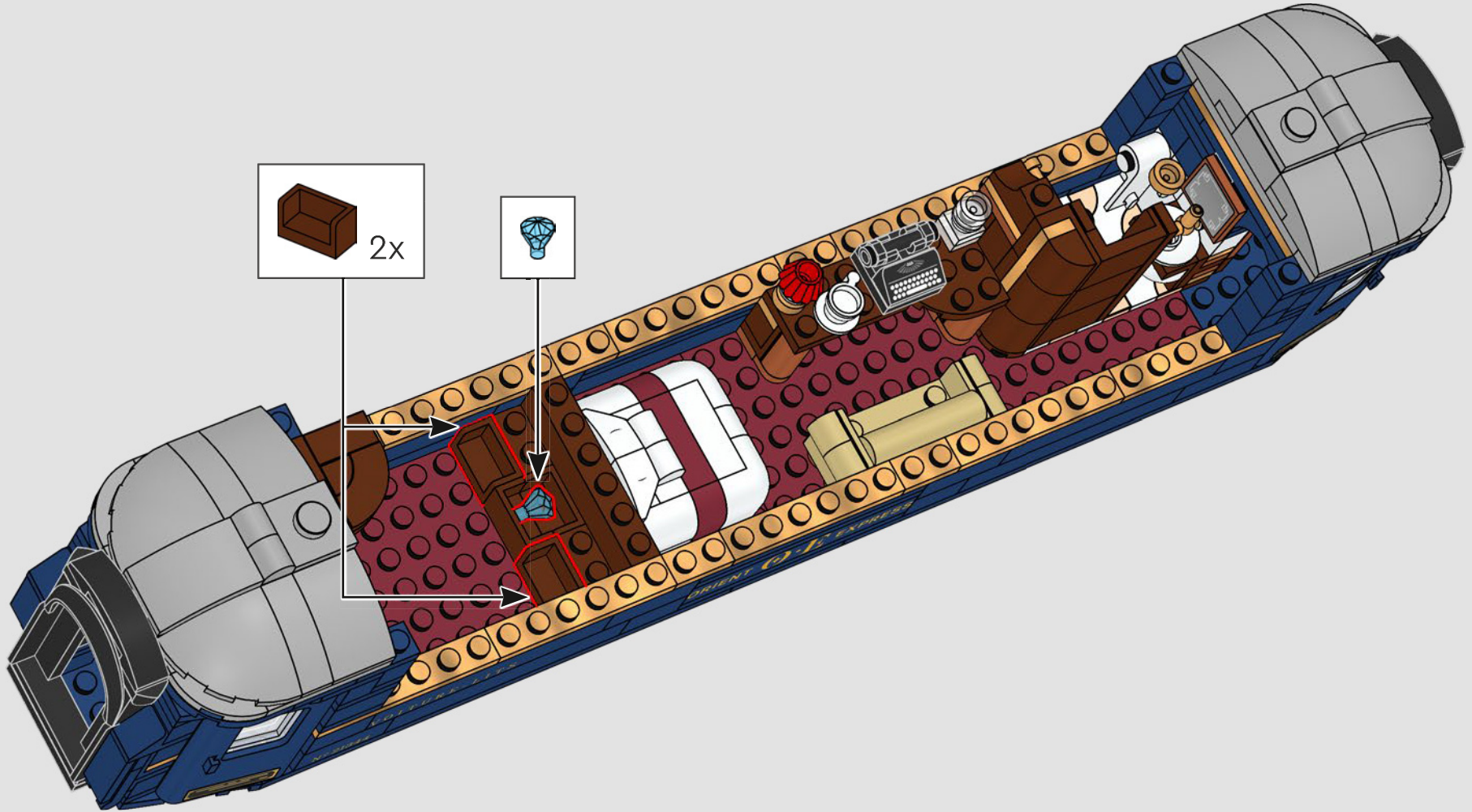

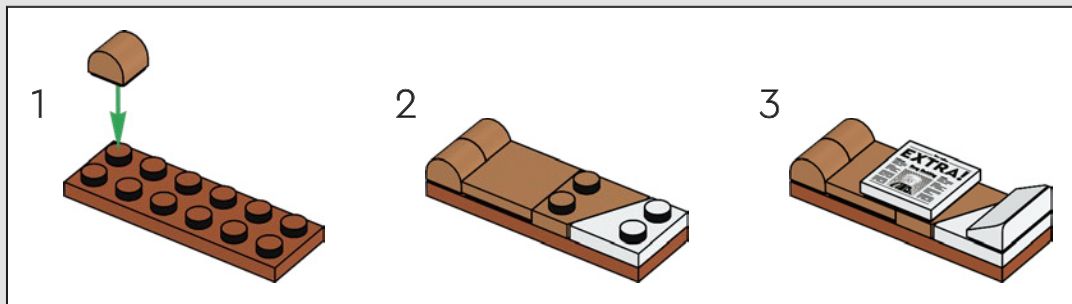
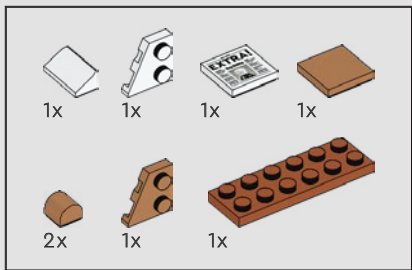

218

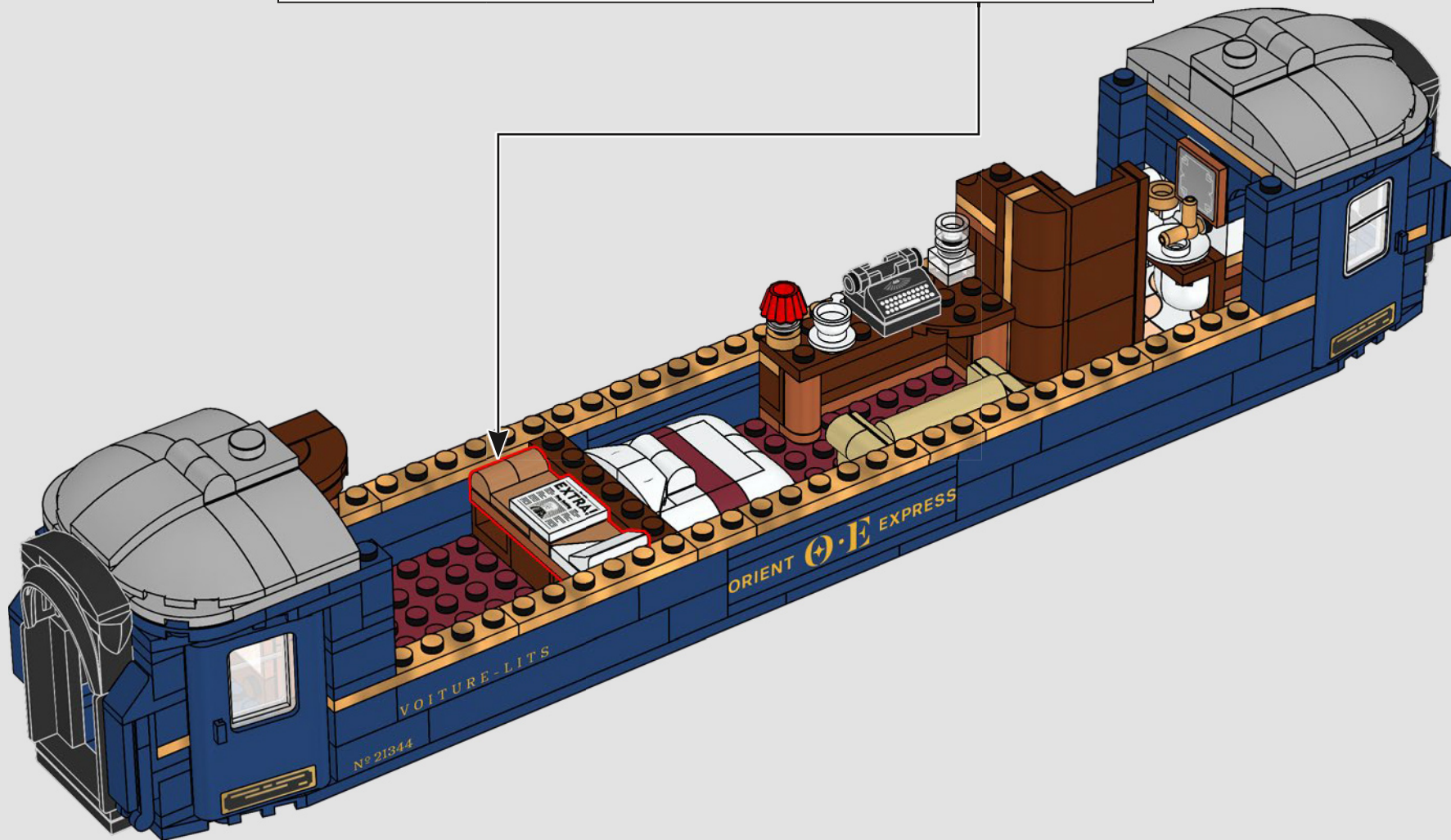

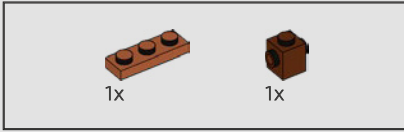
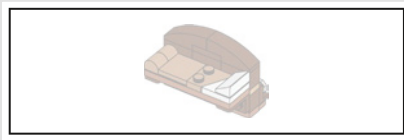

219

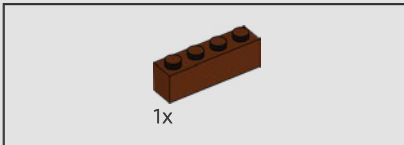
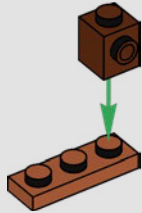

220

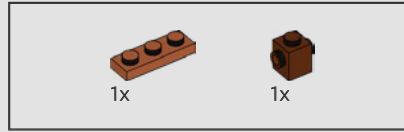
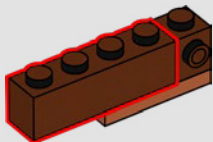

221

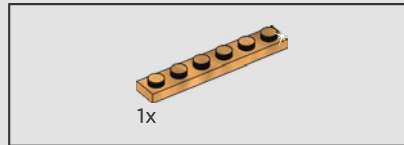
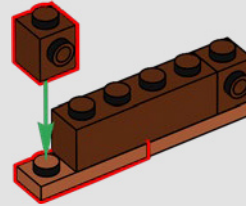

222

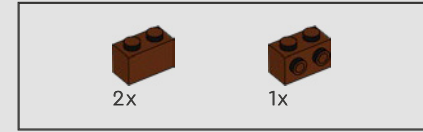
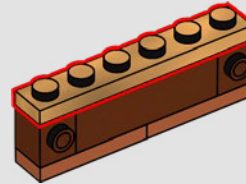

223

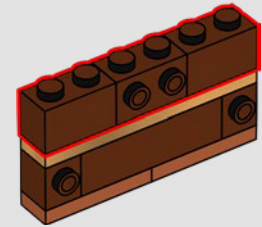

224

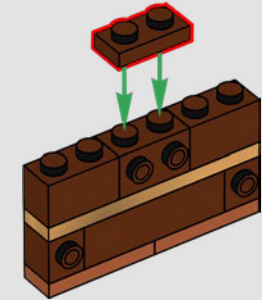



225

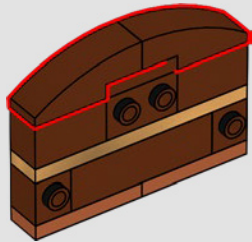

226

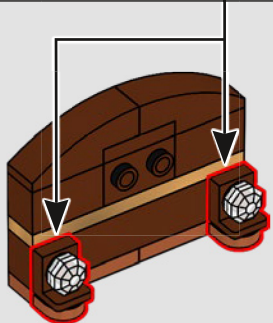
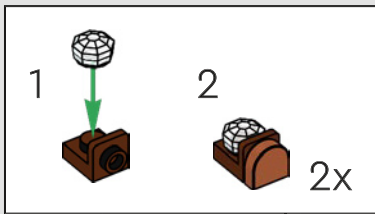

227

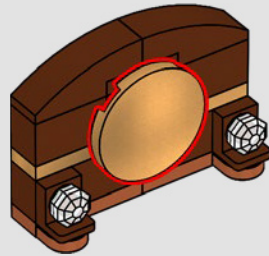

228

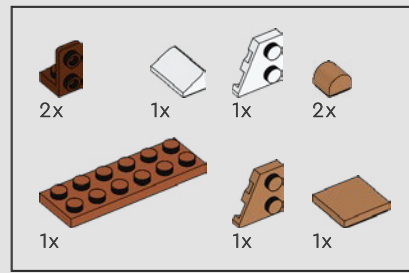
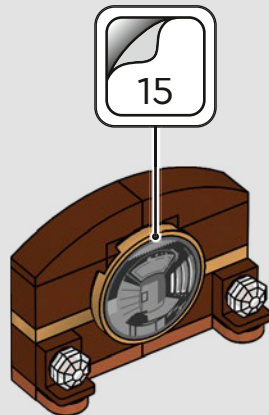

229

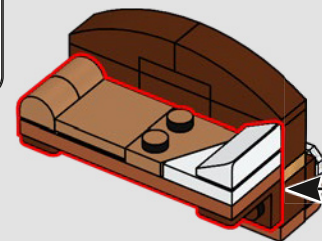
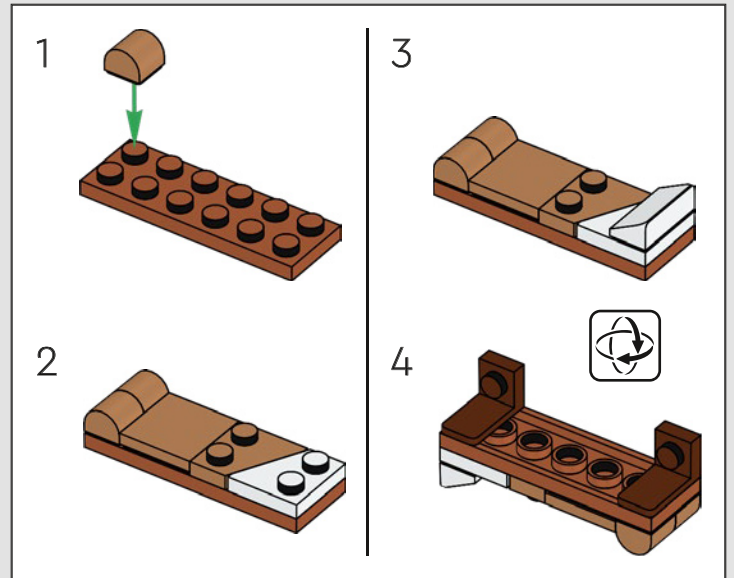

230

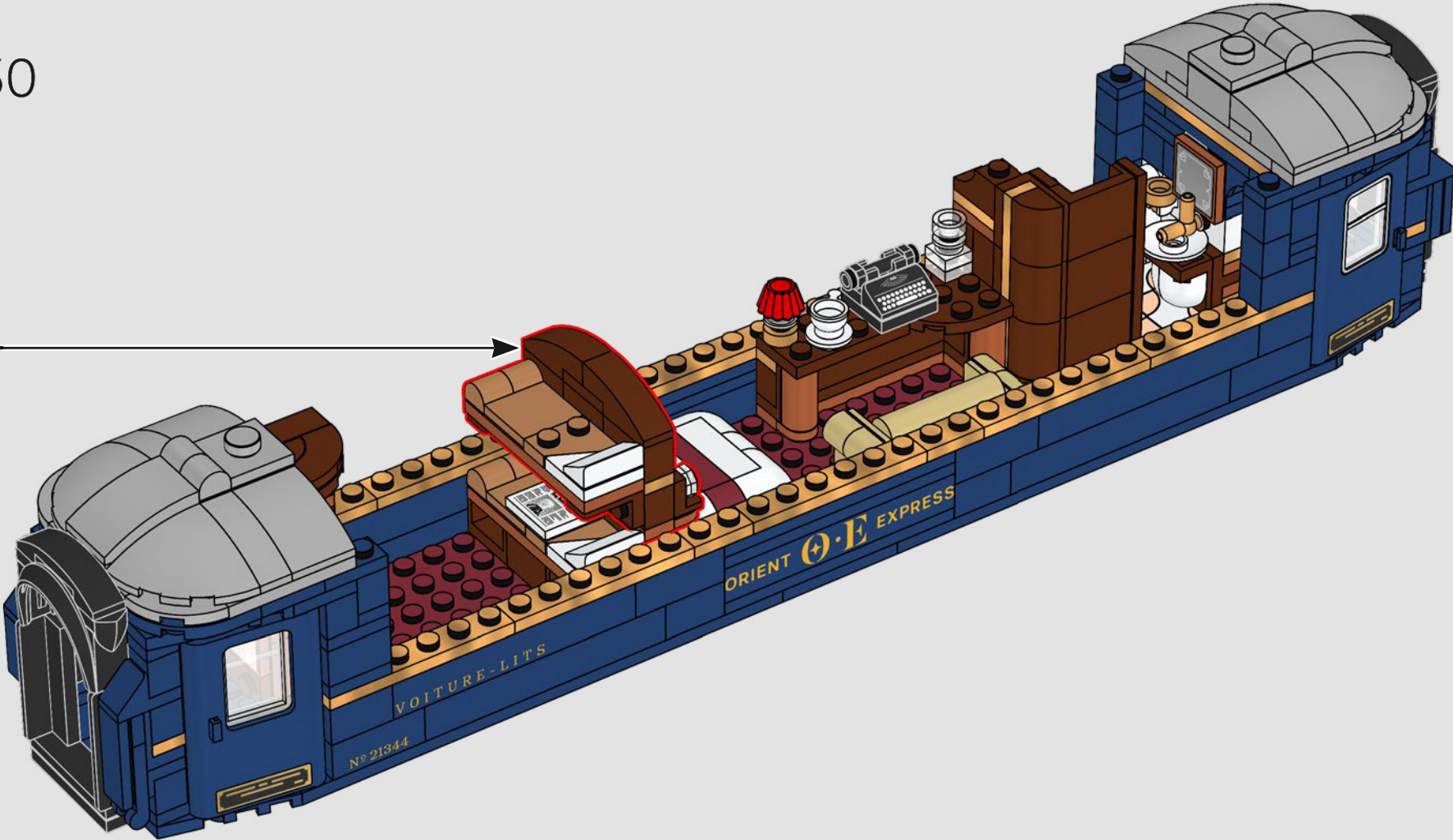

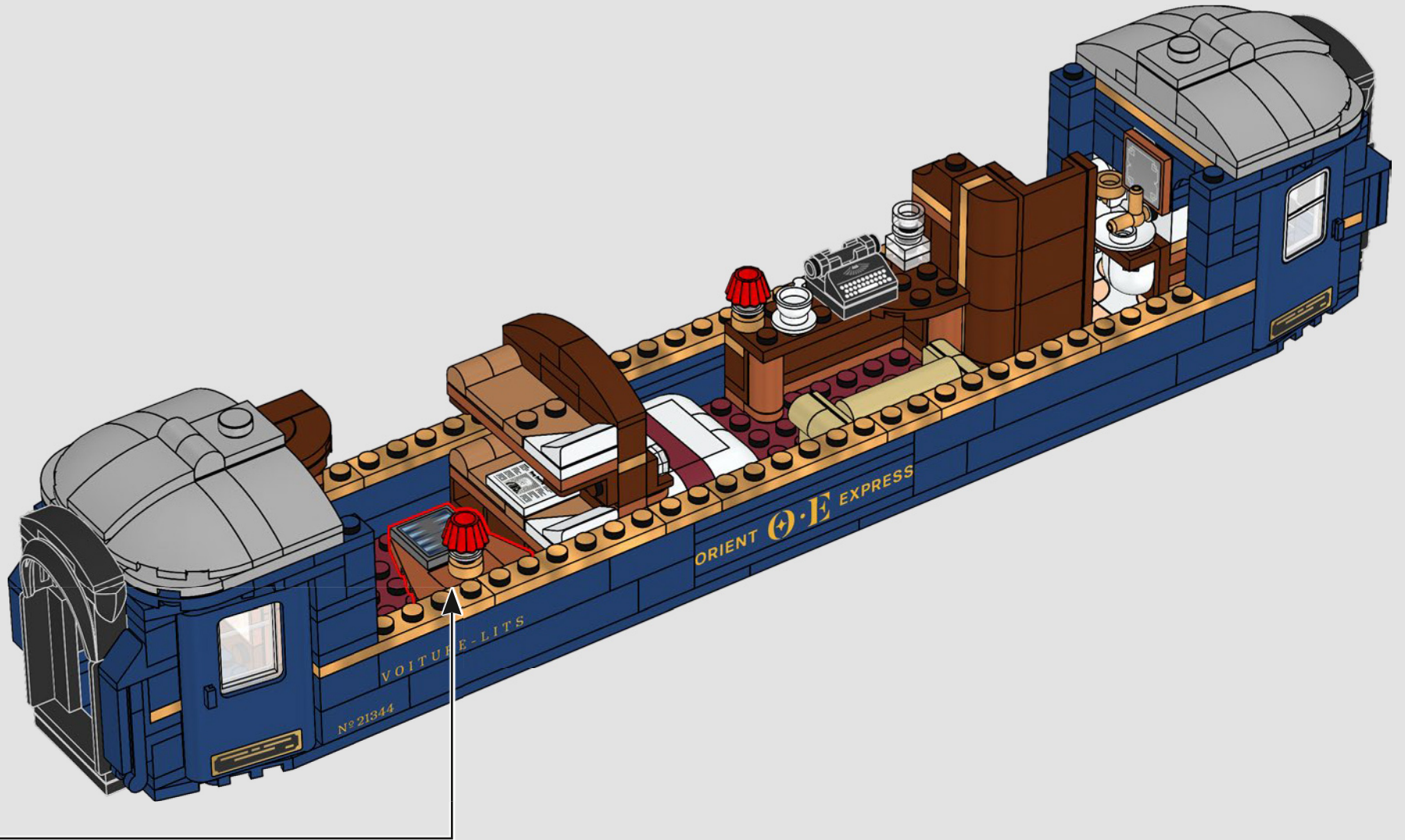



●
Próxima parada: BUCAREST

"Esta vibrante ciudad es nuestra próxima parada.
Sus amplios bulevares están llenos de actividad".

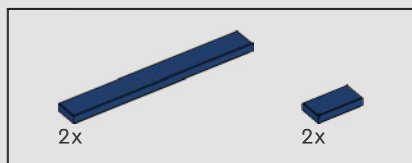

232

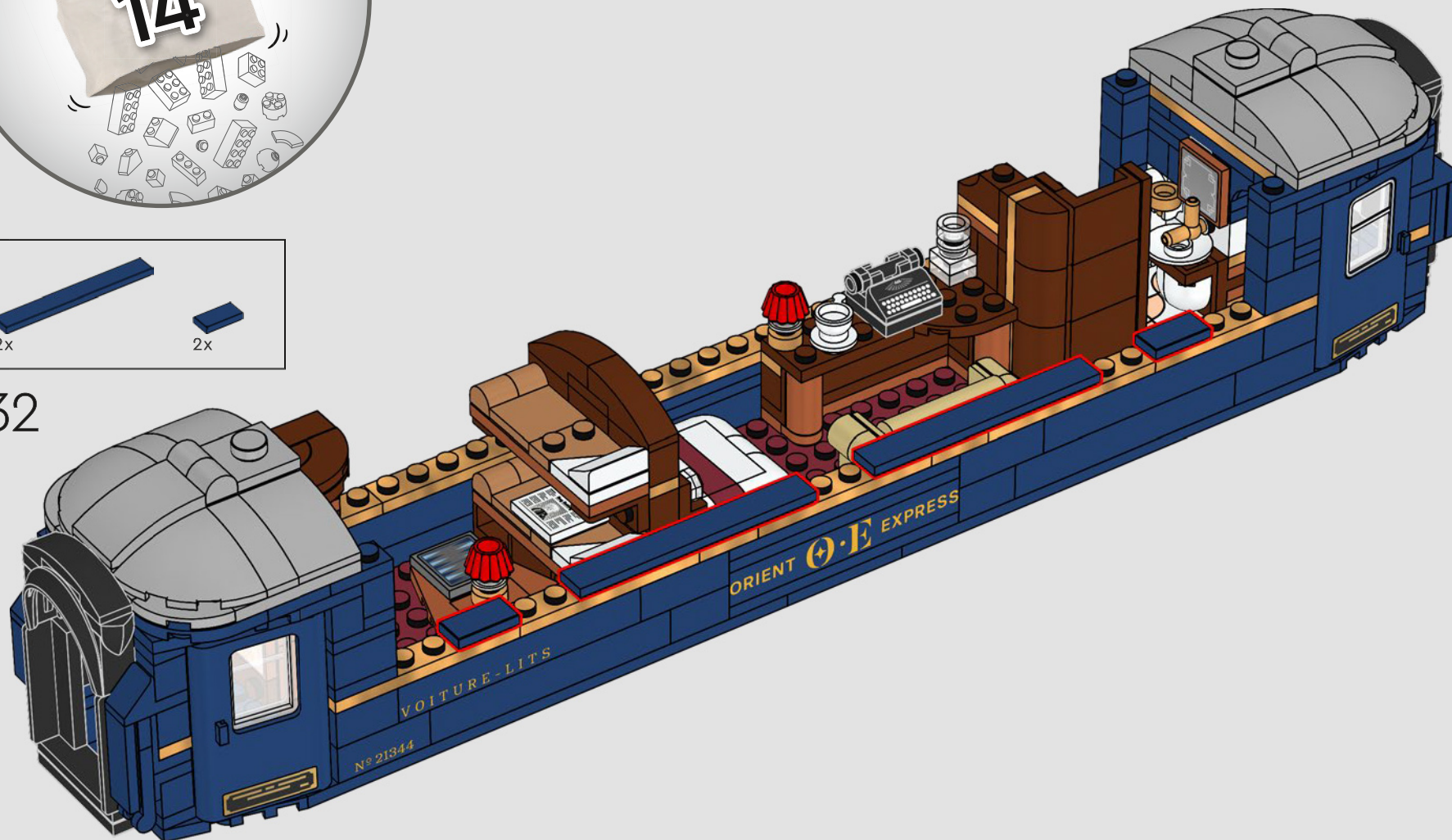

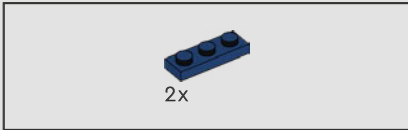
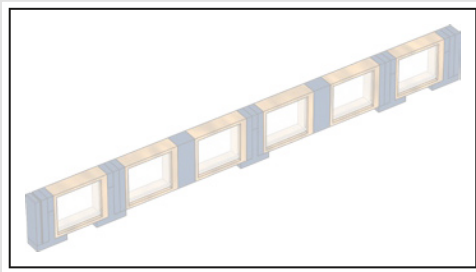

2x

233

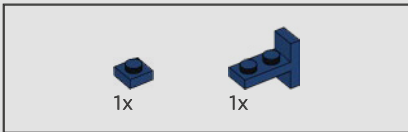
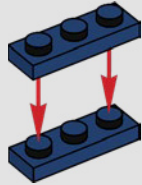

1x

1x

234

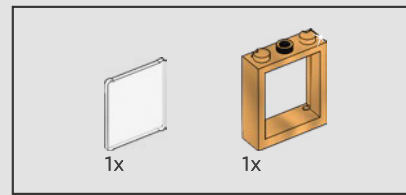
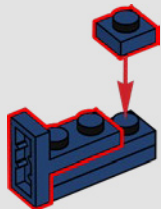

1x

1x

235

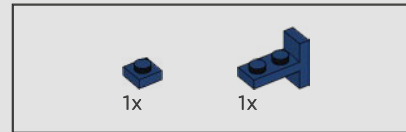
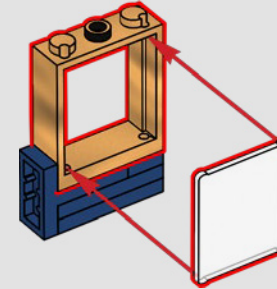

1x

1x

236

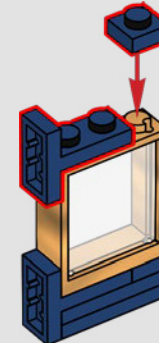

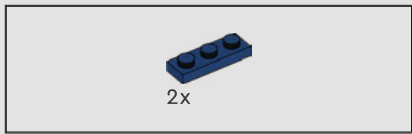

237

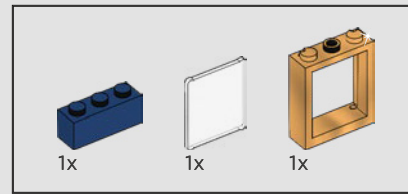
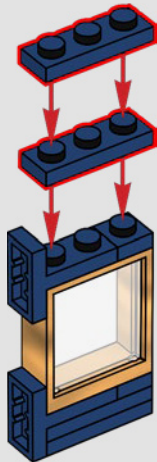

238

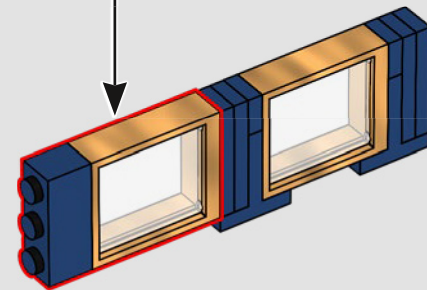
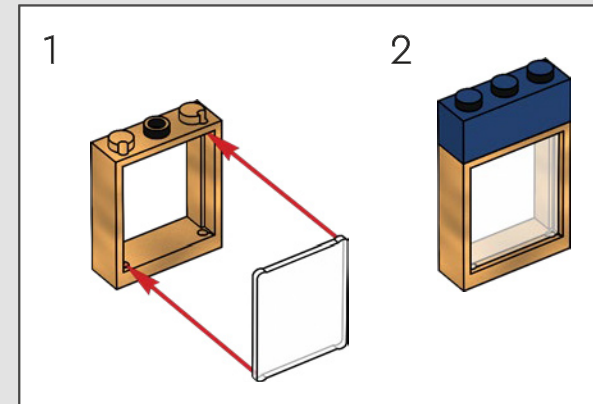

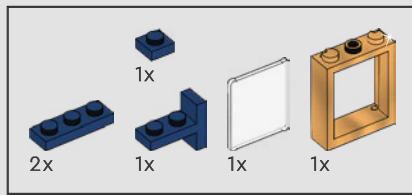

239

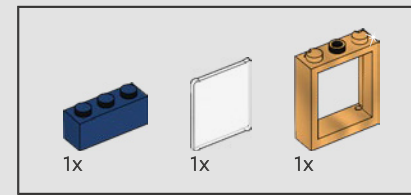
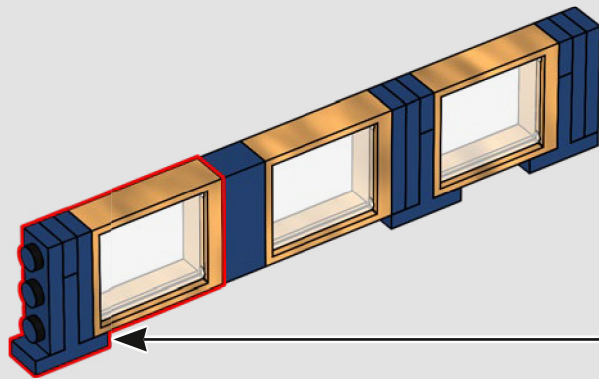
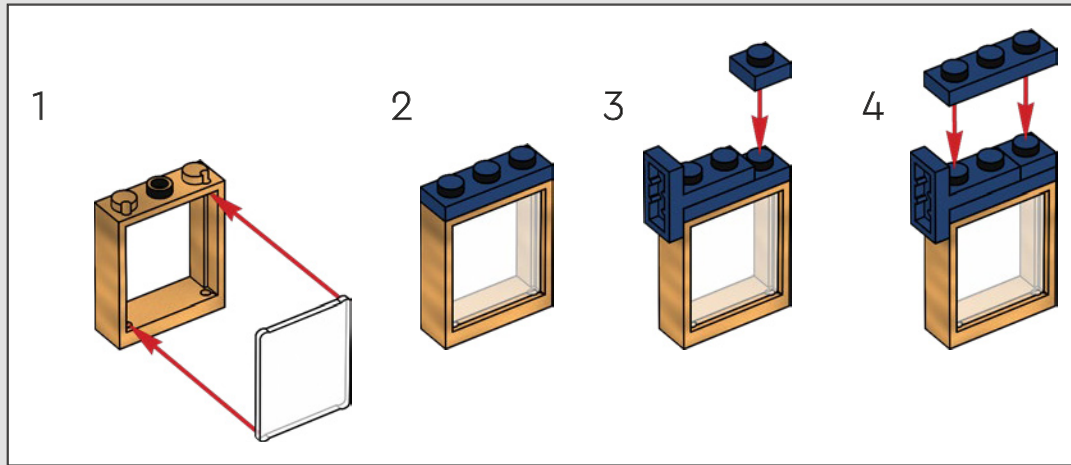

240

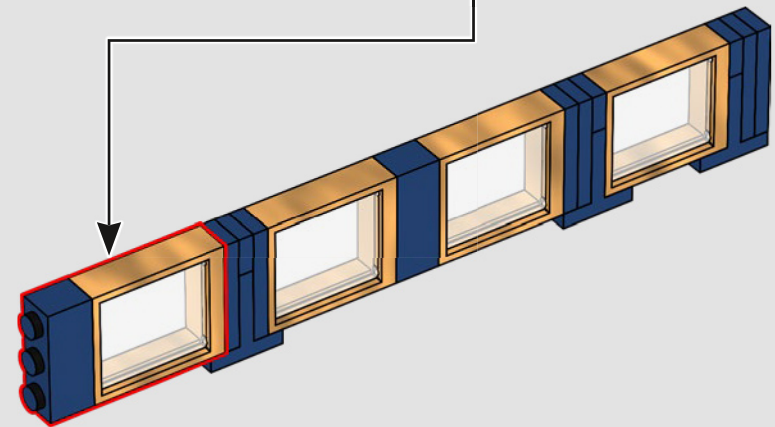
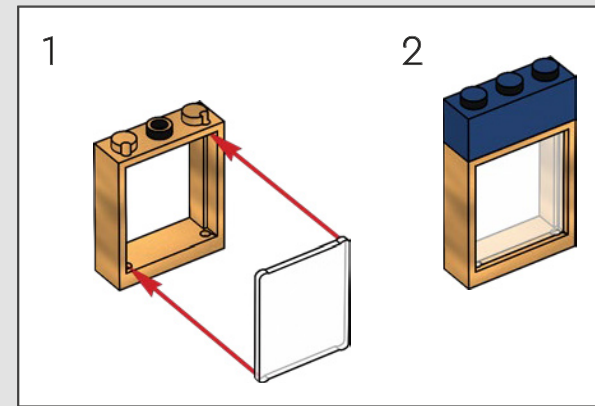

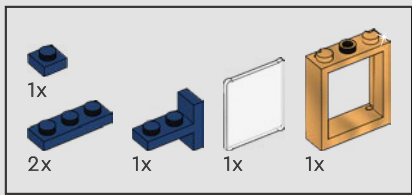

241

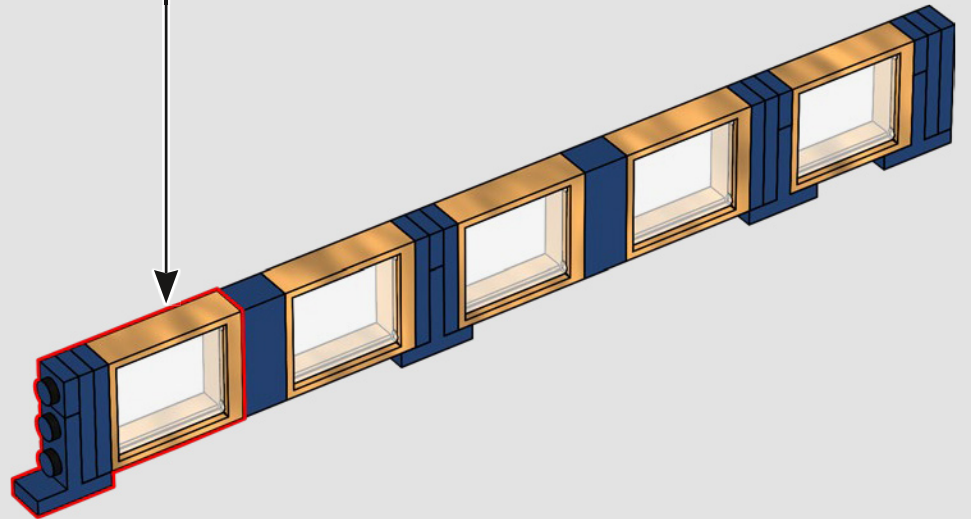
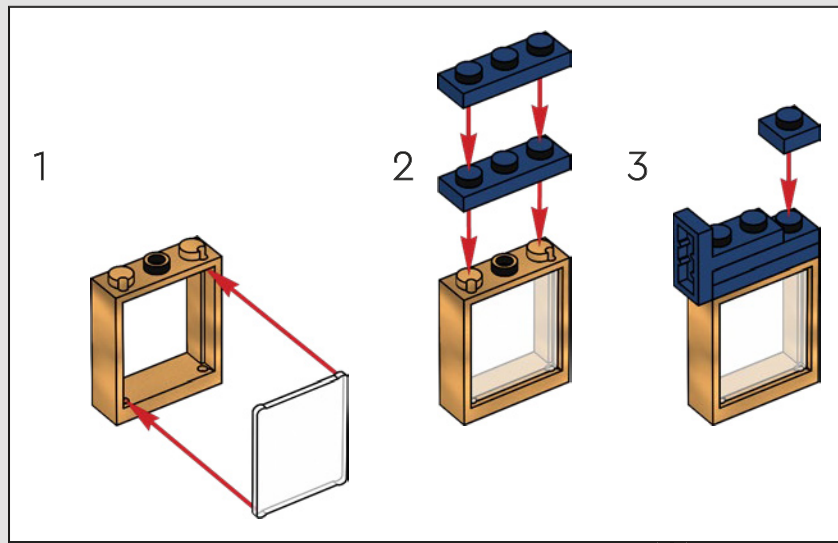

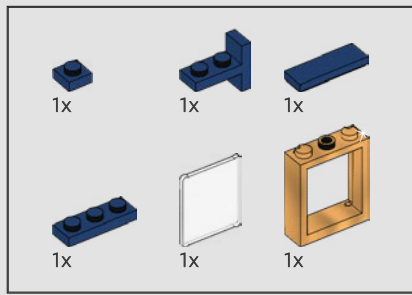

242

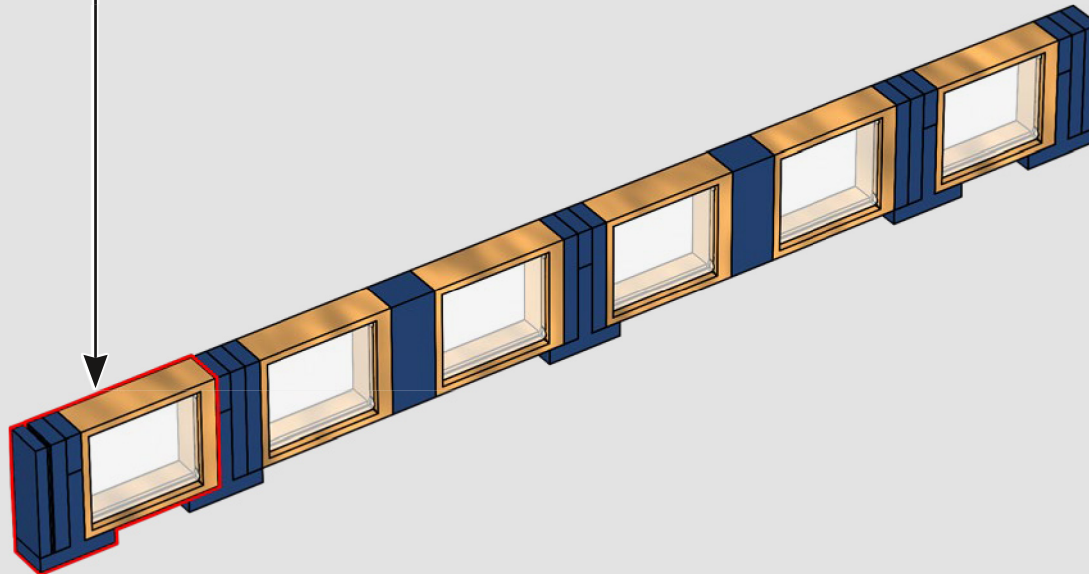
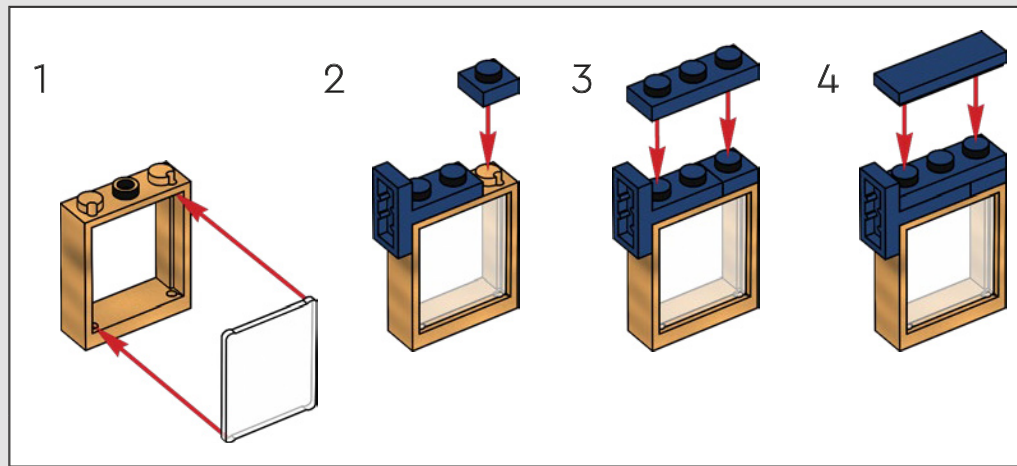

243

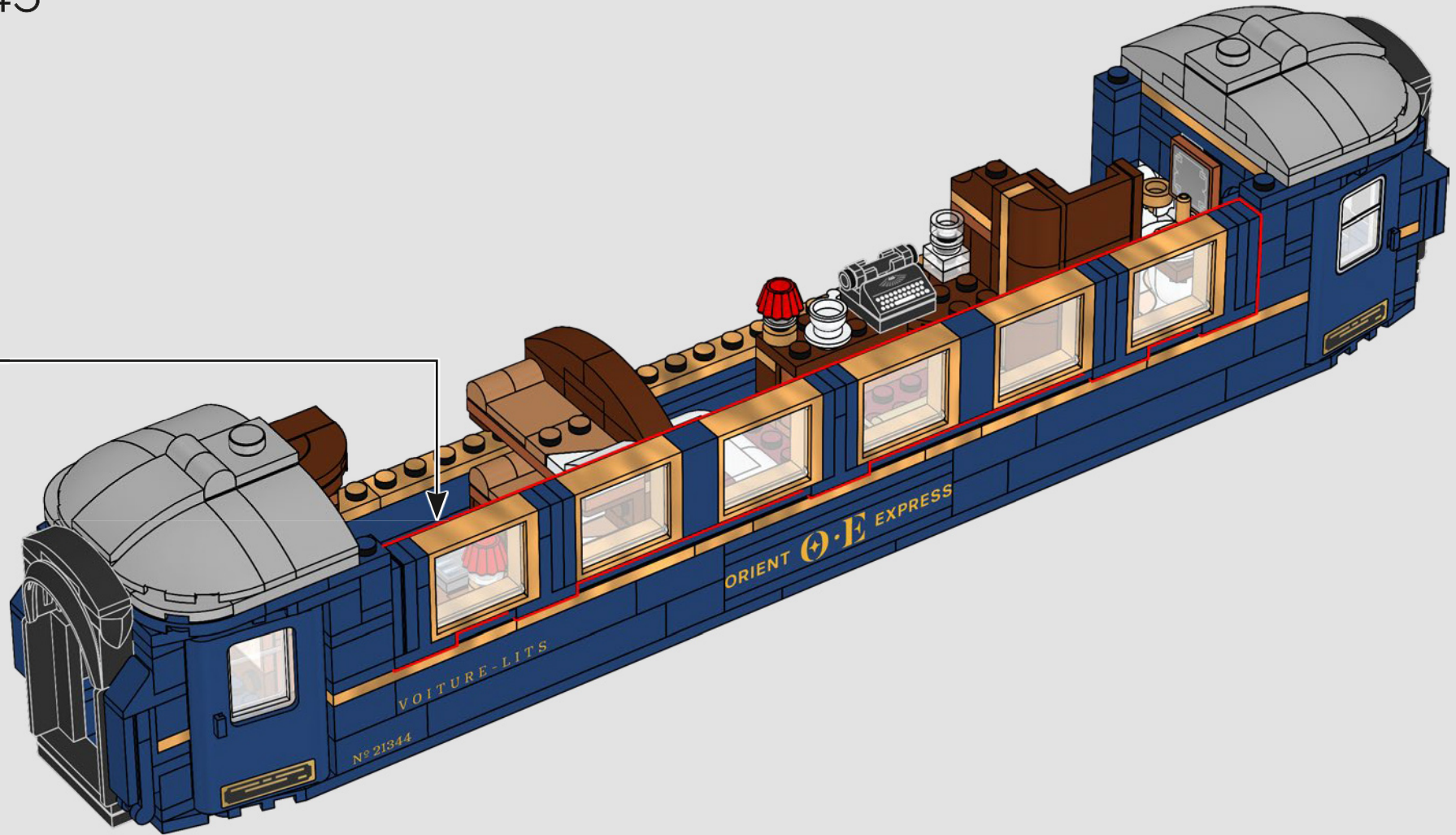

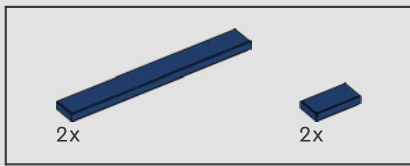

244



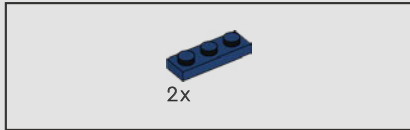
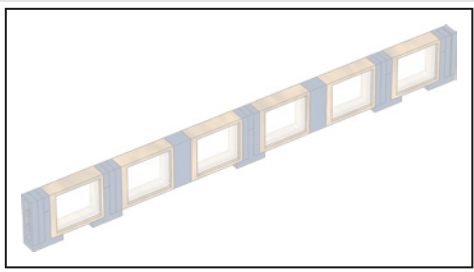

245

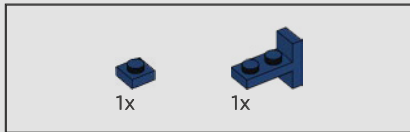
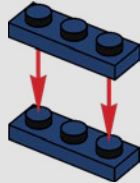

246

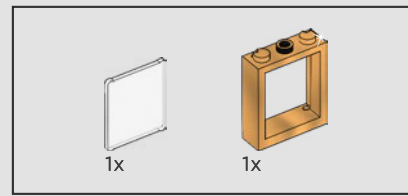
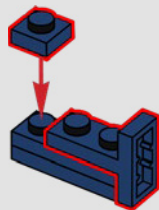

247

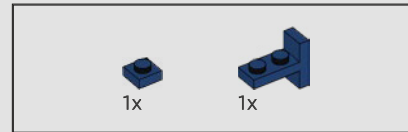
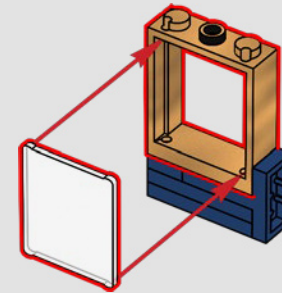

248

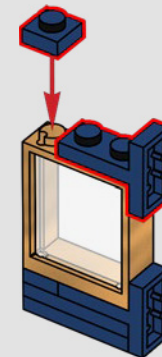

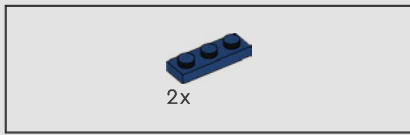

249

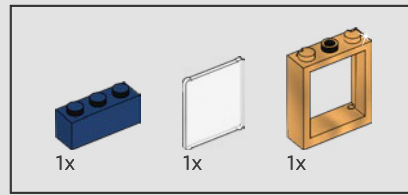
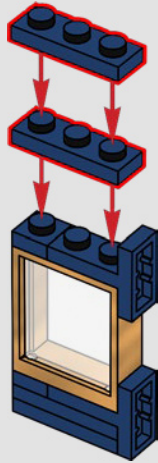

250

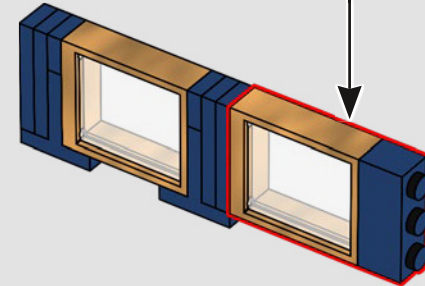
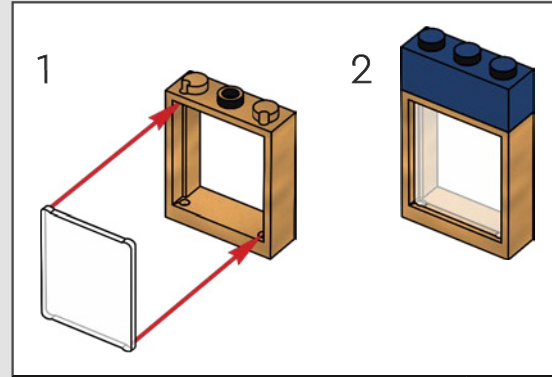

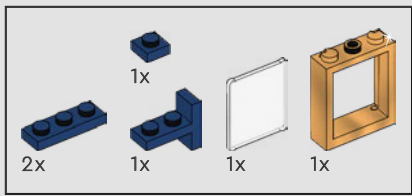

251

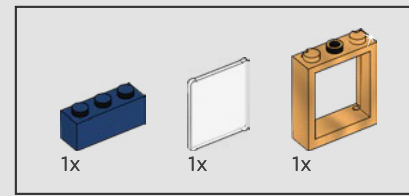
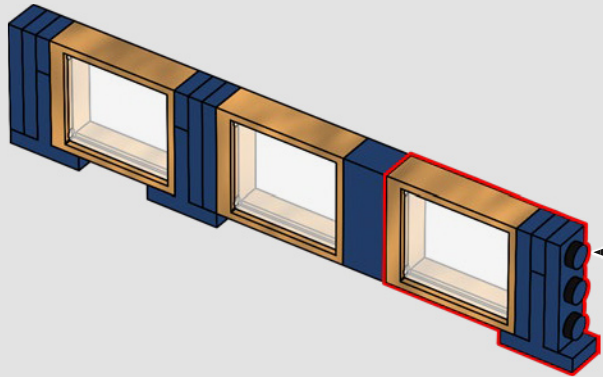
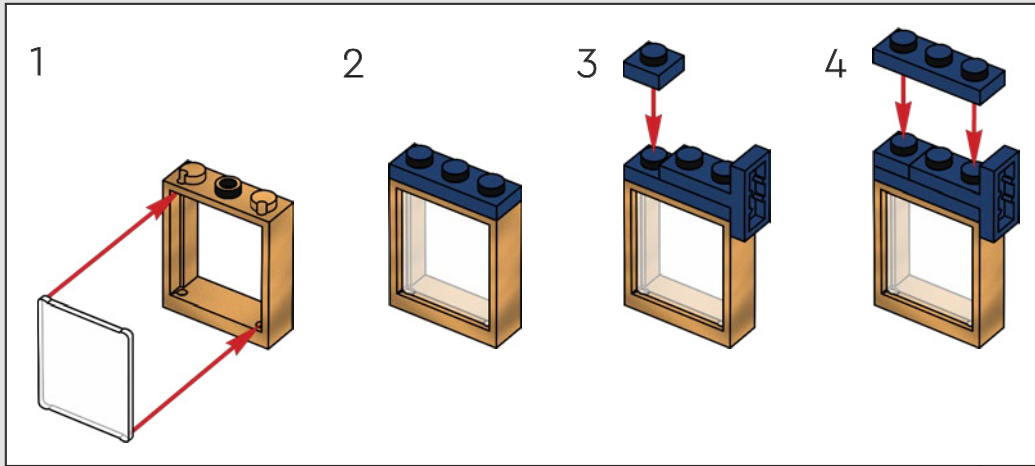

252

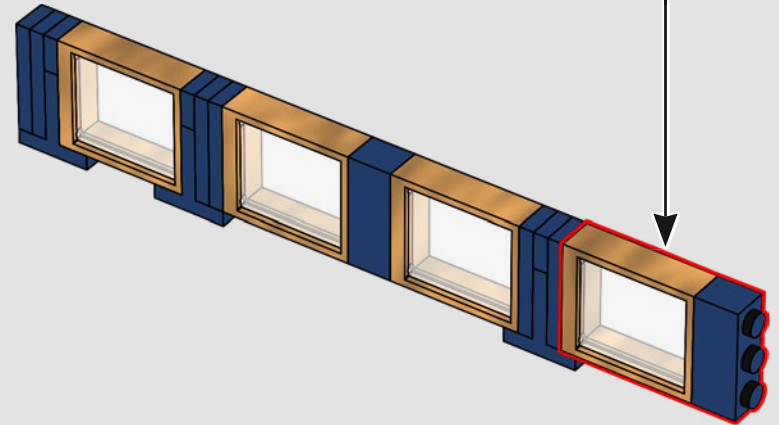
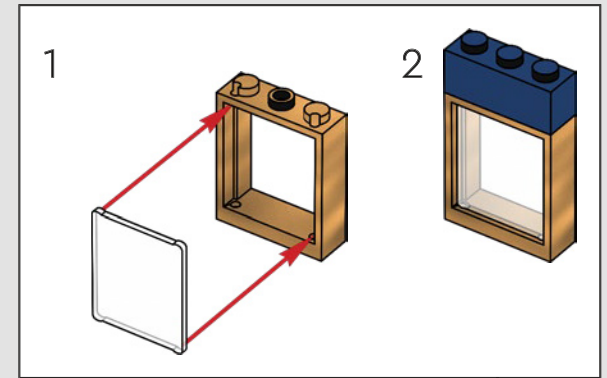

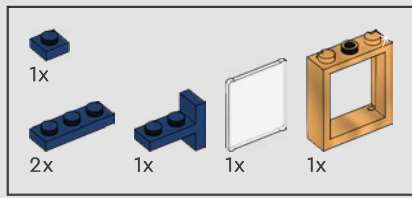

253

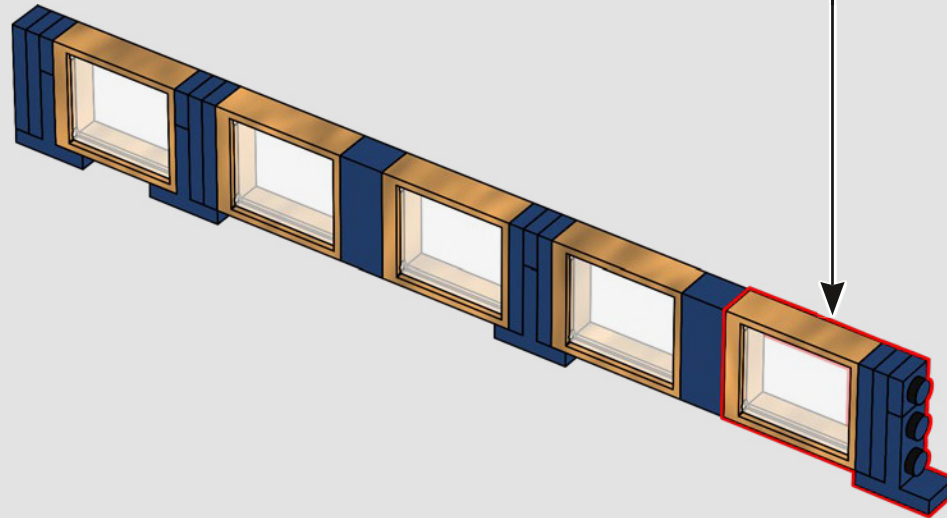
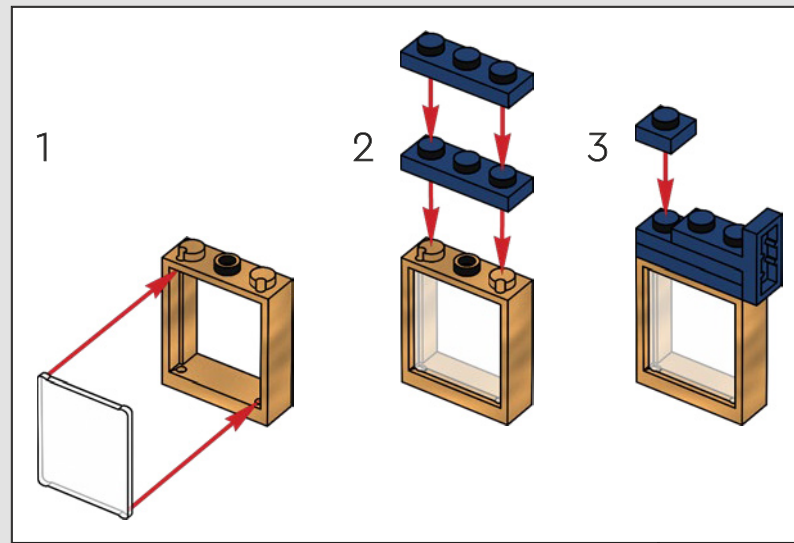

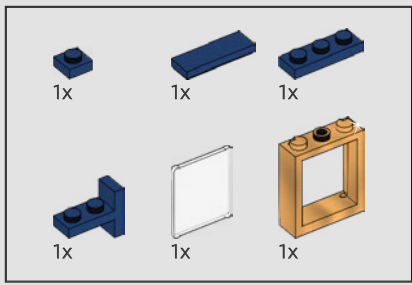

254

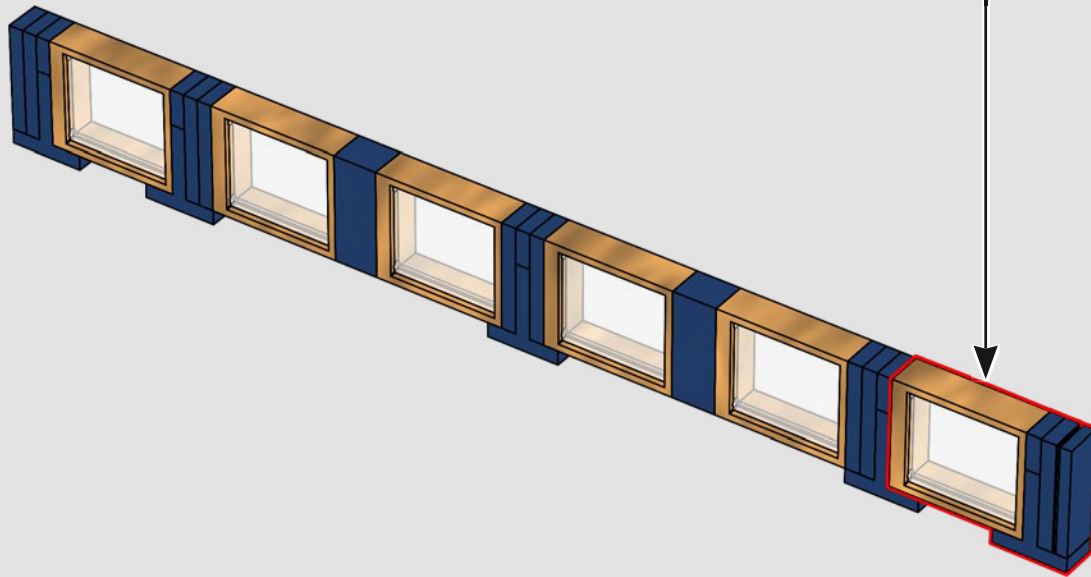
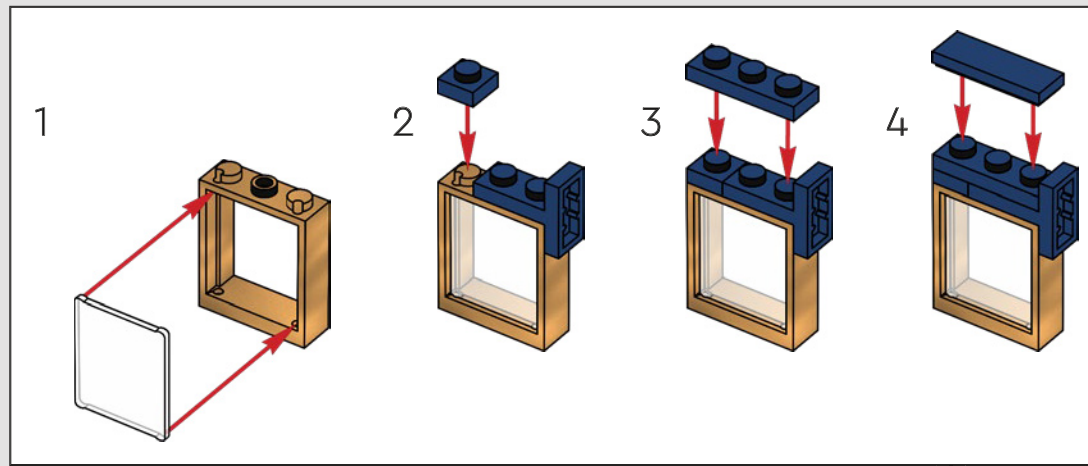

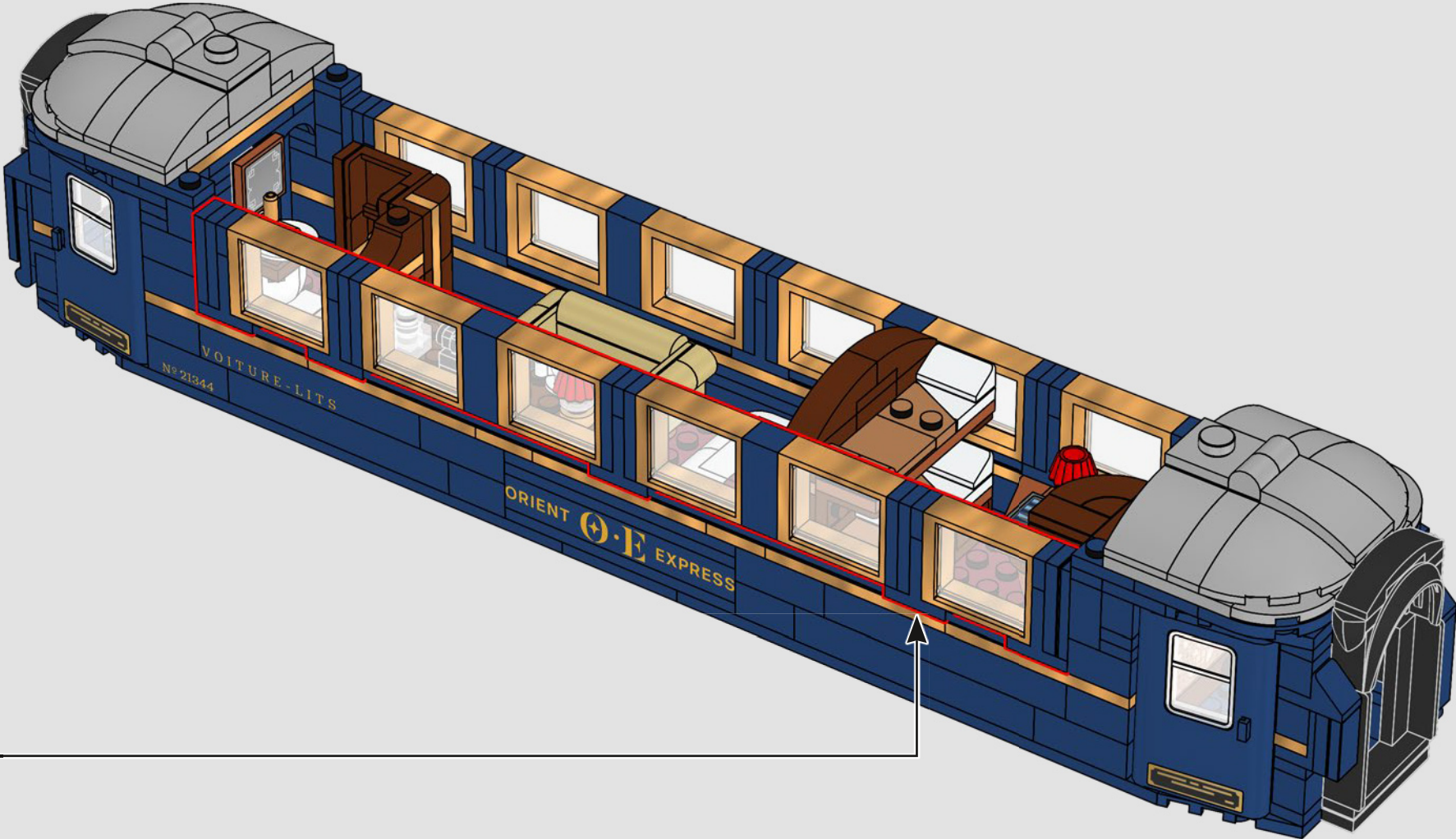



●
"Los pasajeros llevan todo tipo de artículos en su equipaje, desde objetos personales hasta artefactos que resulta difícil identificar..., ¡pero algunos llevan DEMASIADAS cosas!".

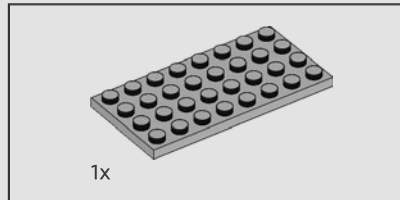
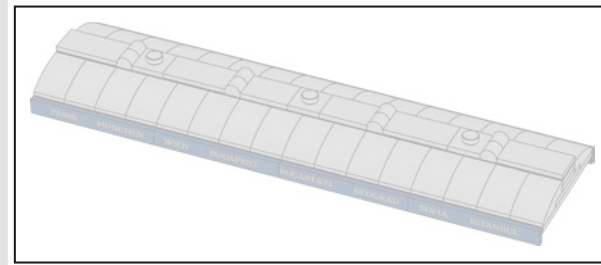
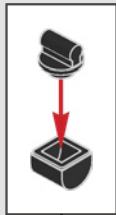
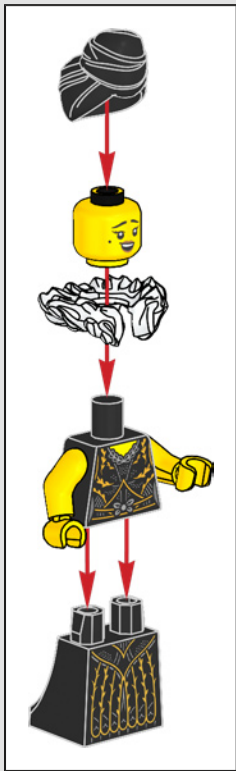

256

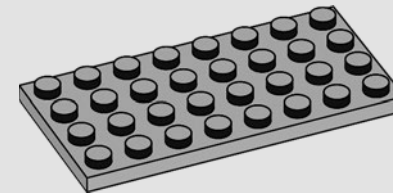

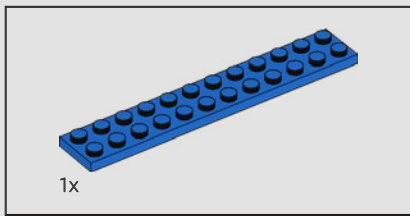

257

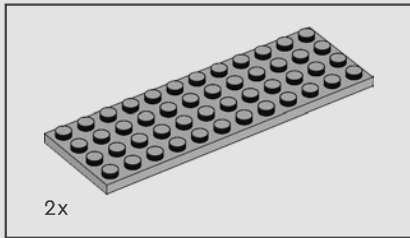
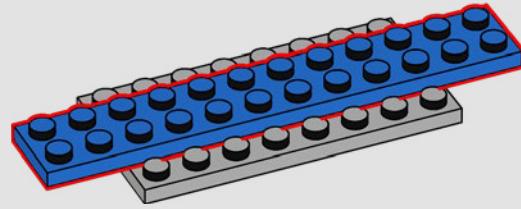

258

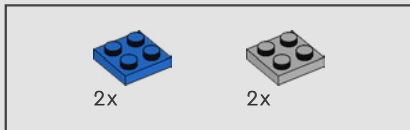
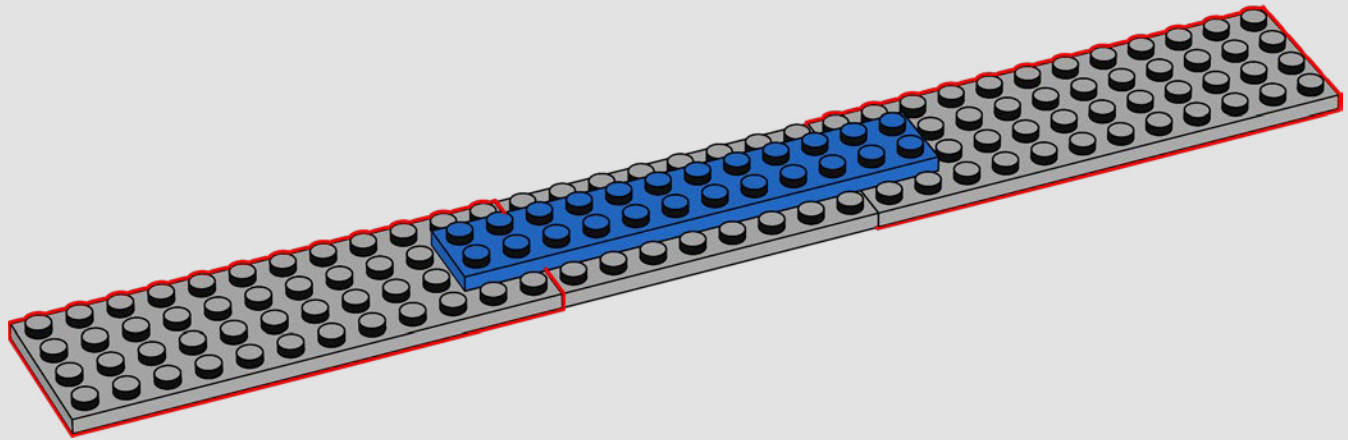

259

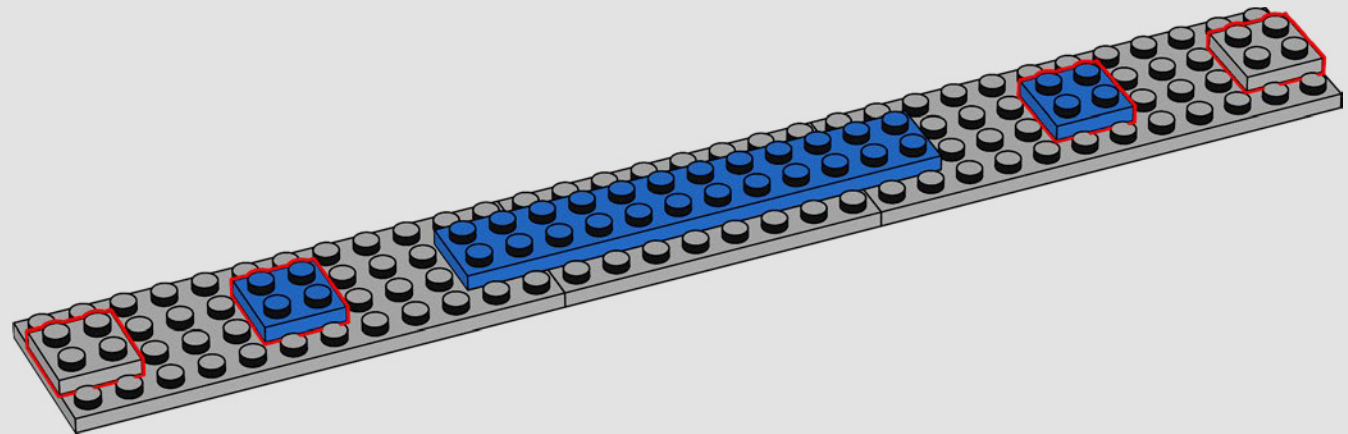



260

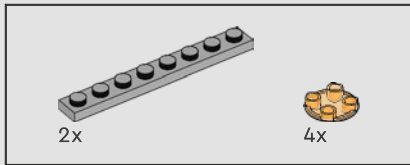
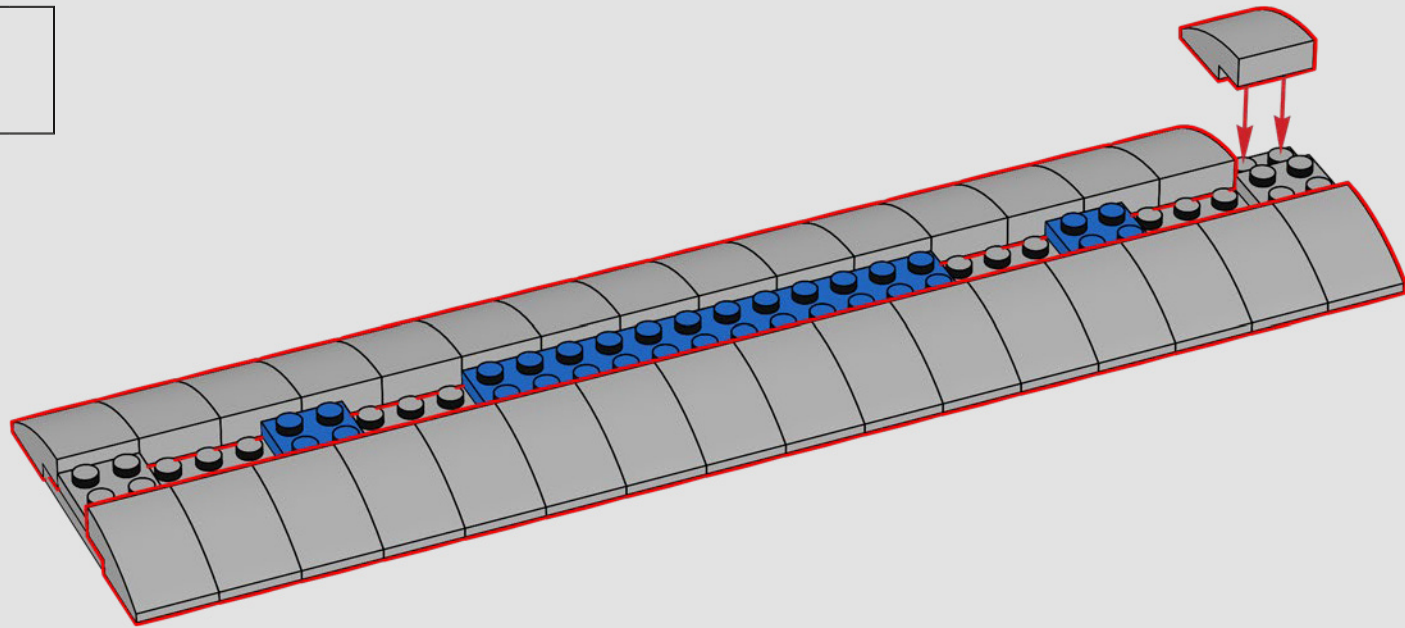

261

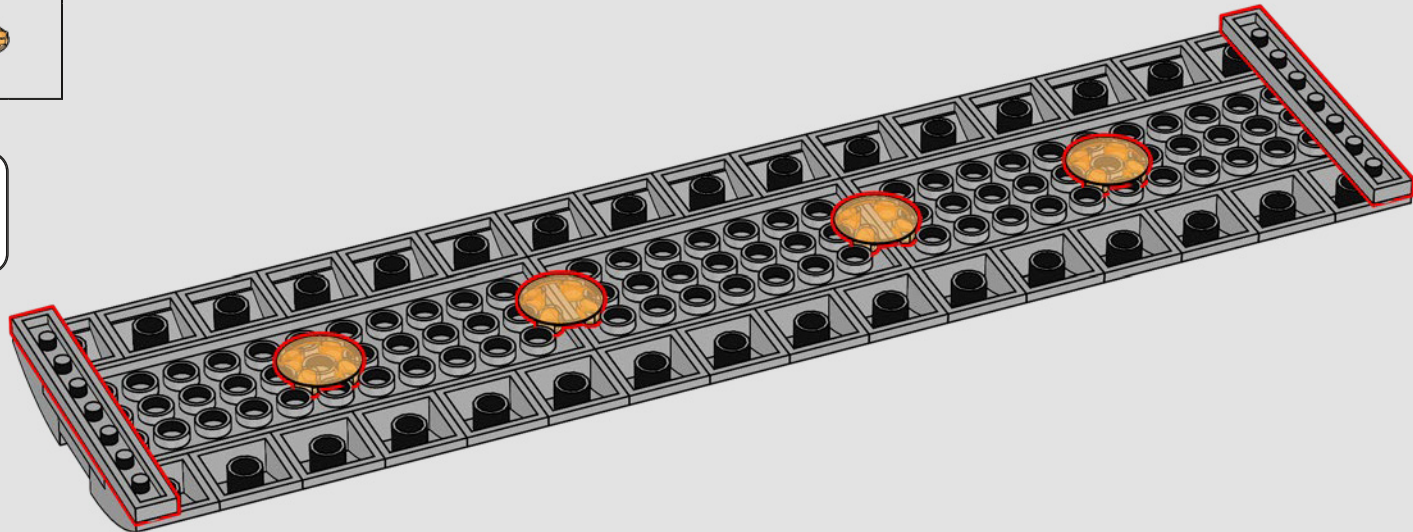

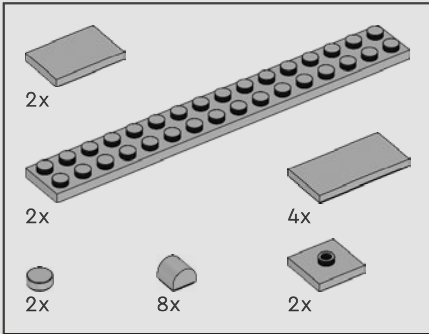
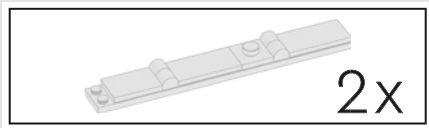

262

1

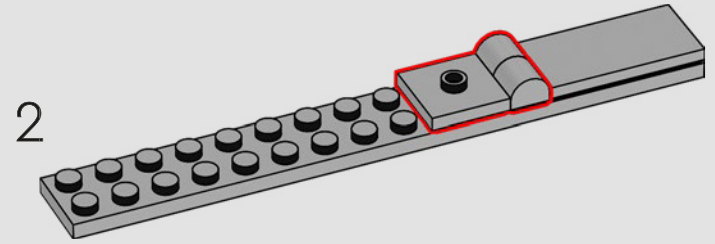
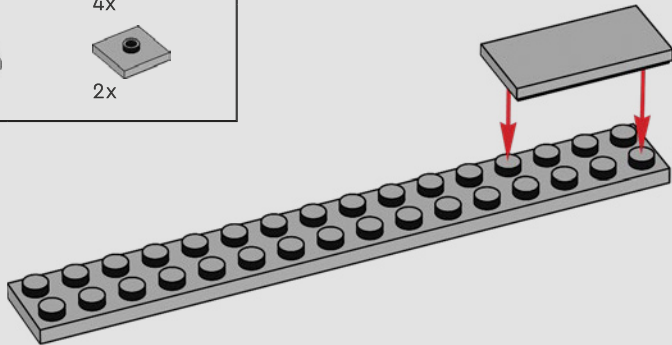

3

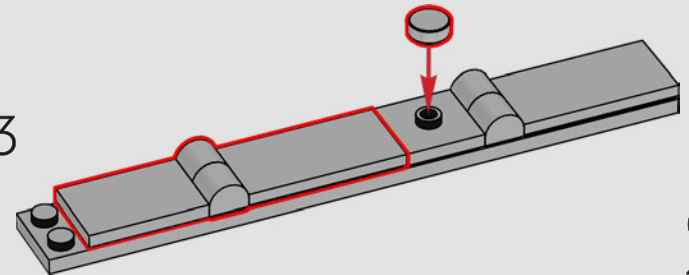

2x

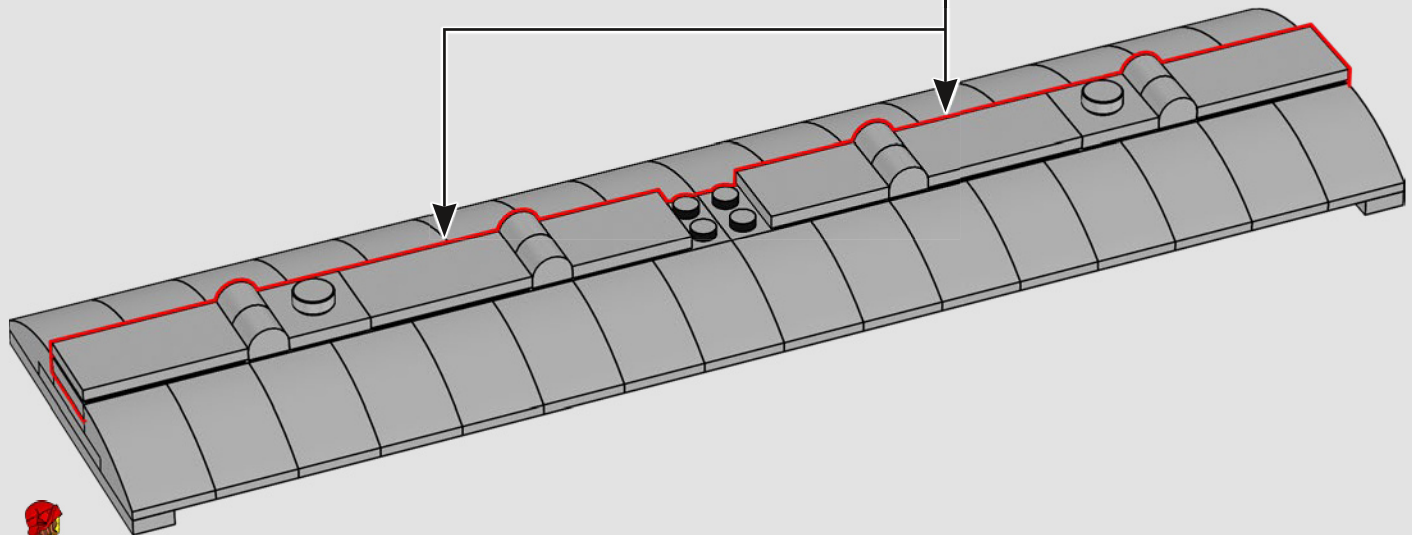

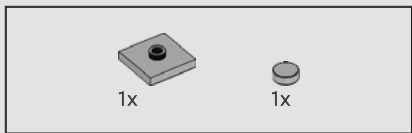

263

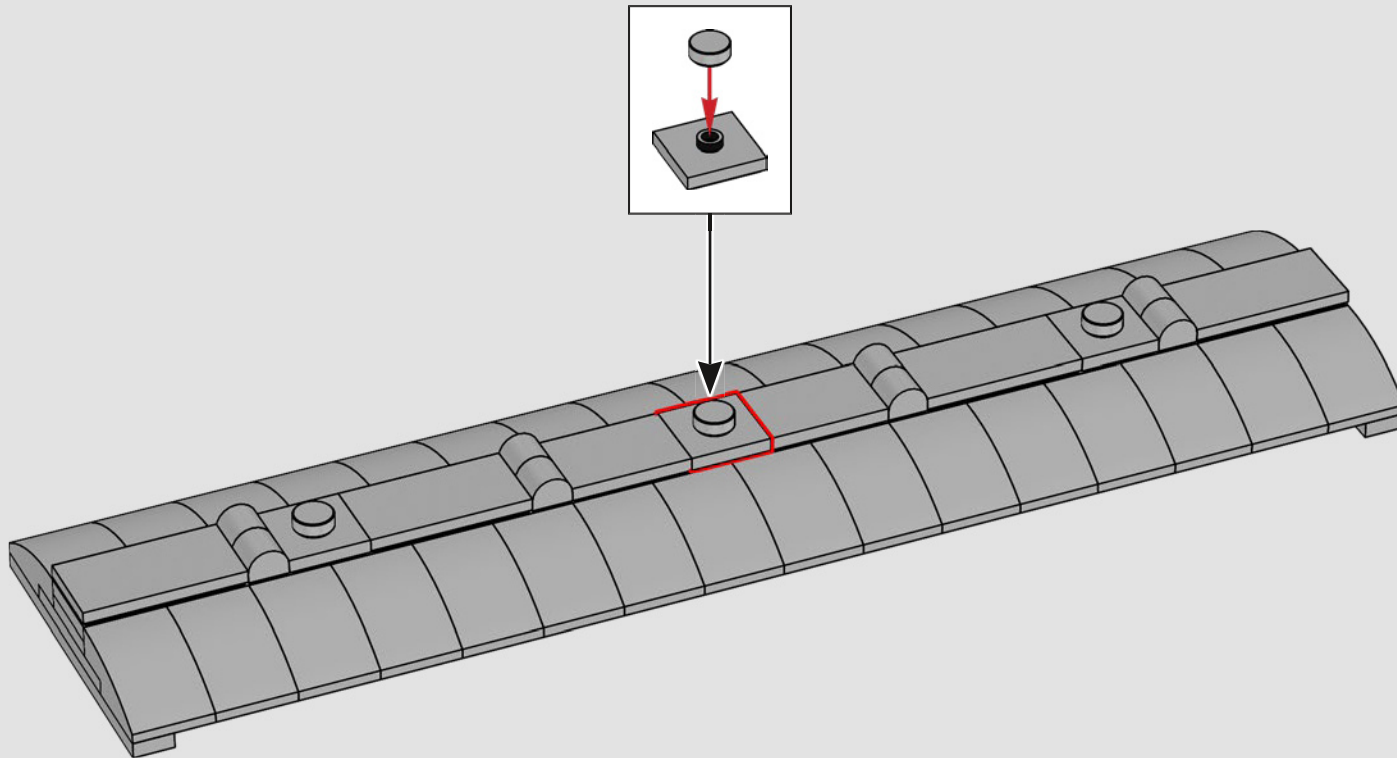

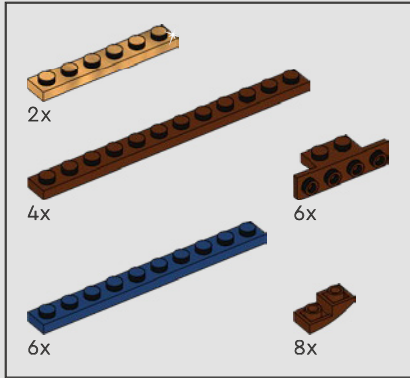
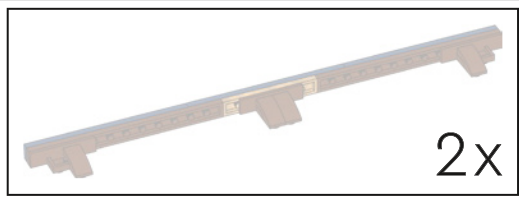

264

1

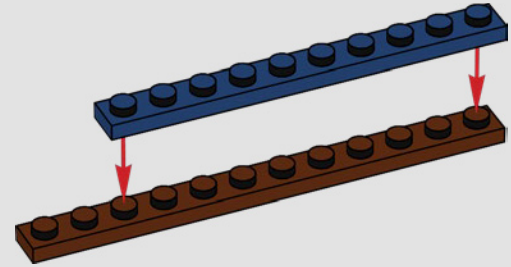

2

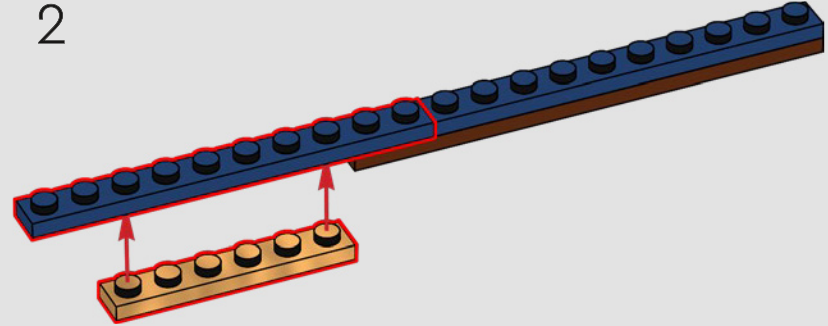

3

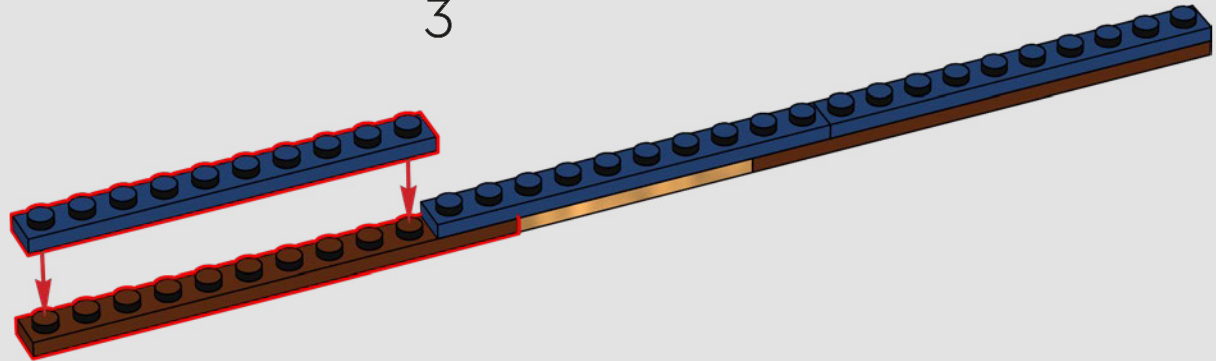

4

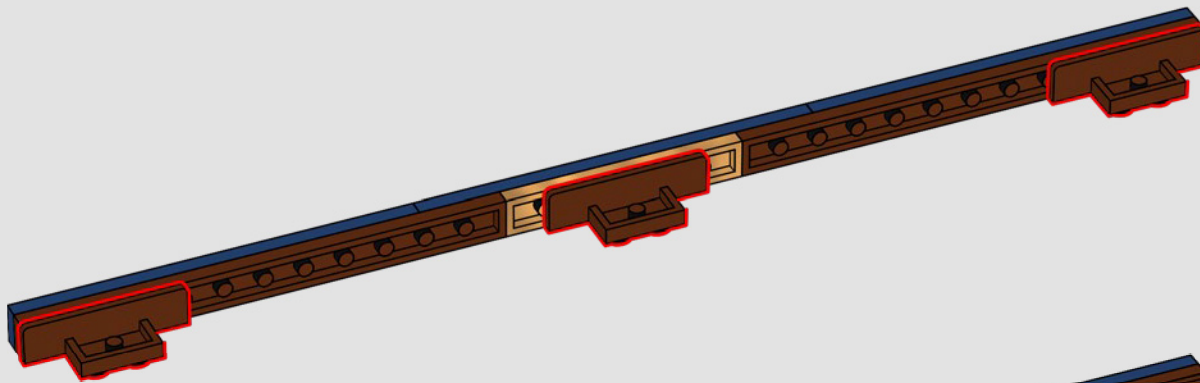

5

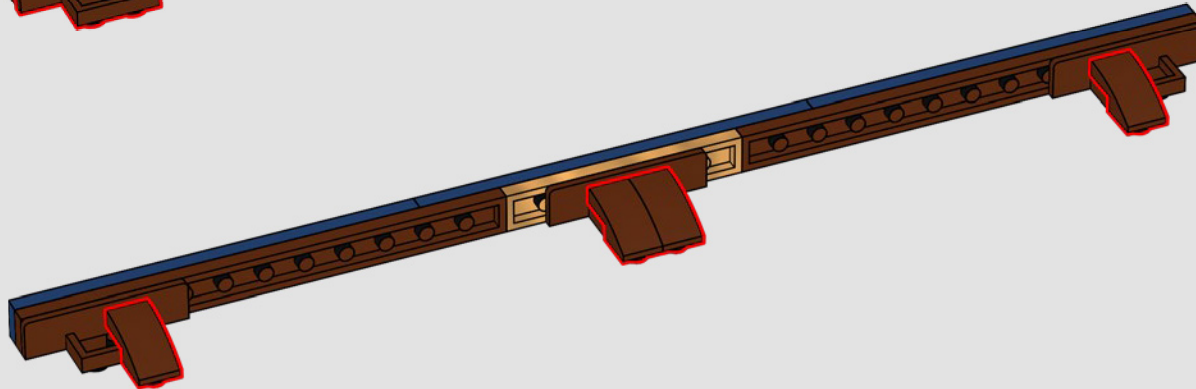

2x

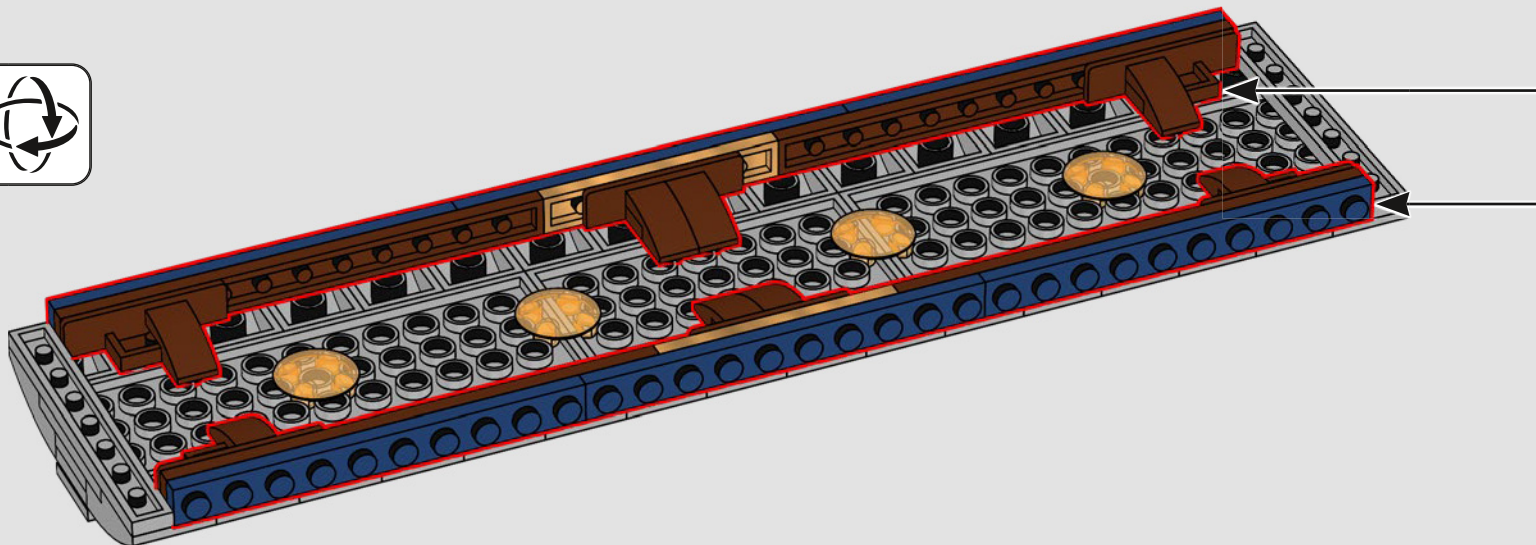

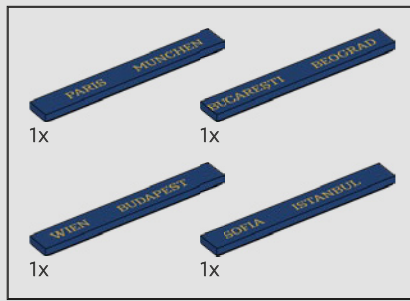

265

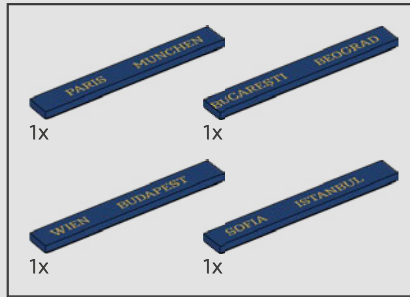
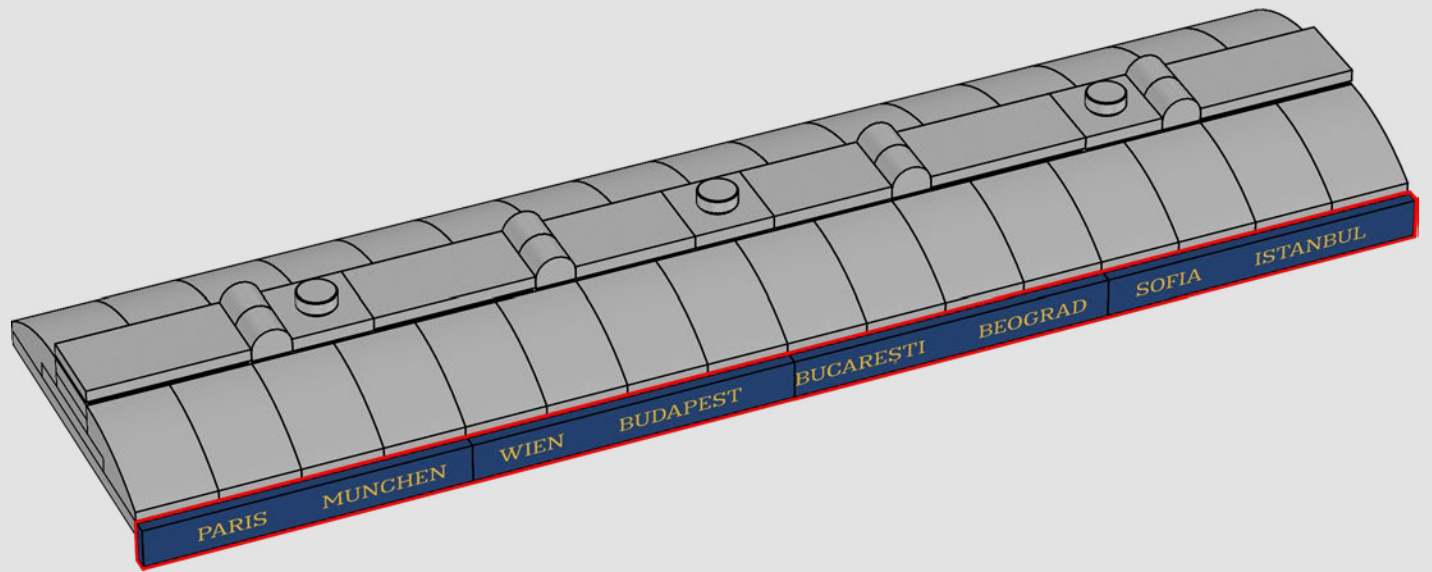

266

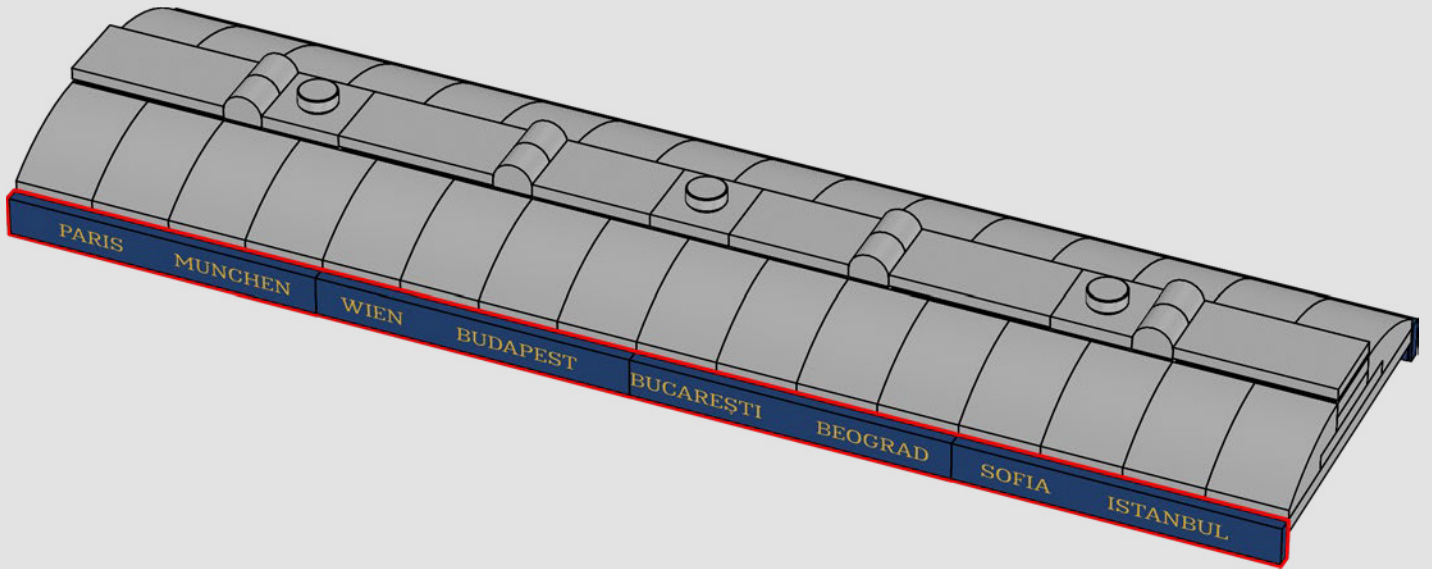

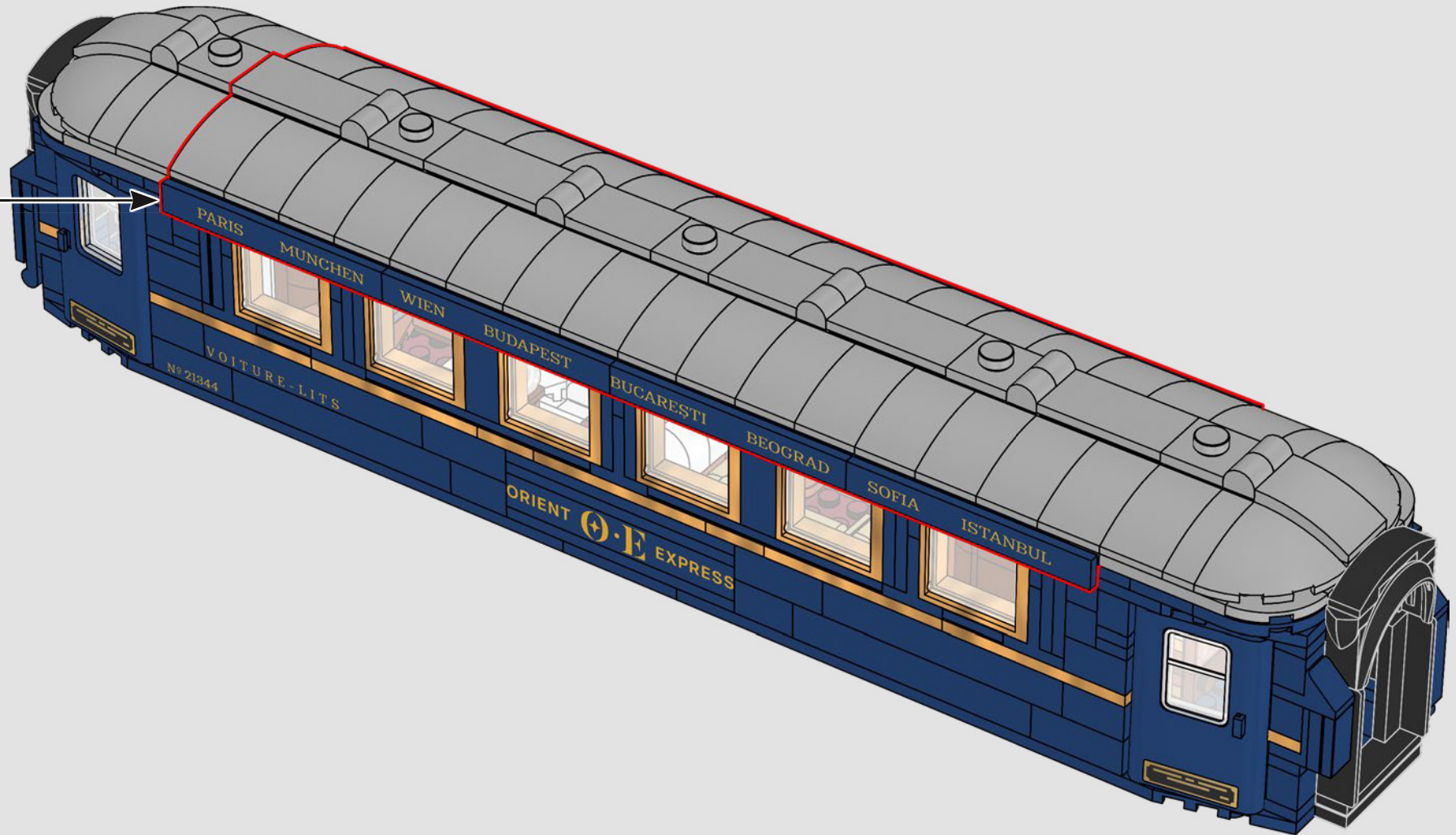

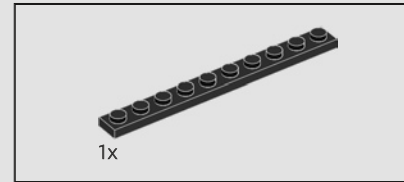
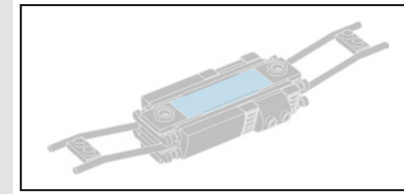
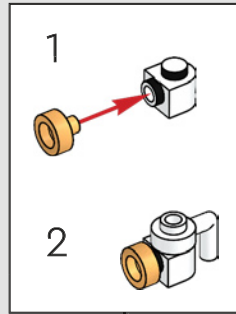
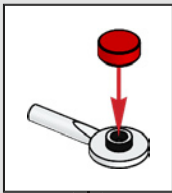
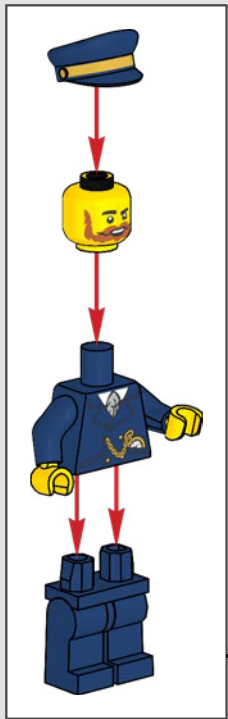

268

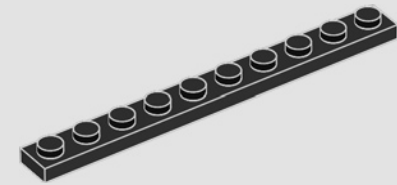

●
Próxima parada: BELGRADO
"El jefe de estación supervisa el acoplamiento de cada vagón al tren".

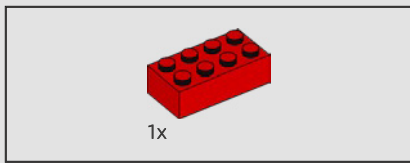

269

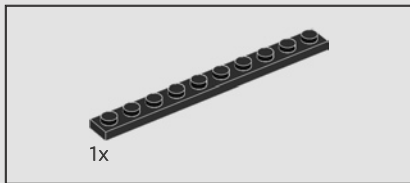
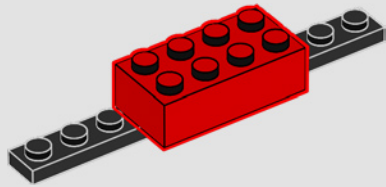

270

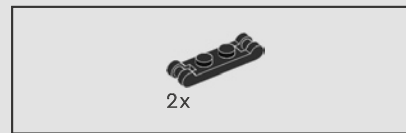
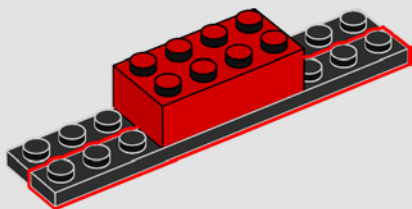

271

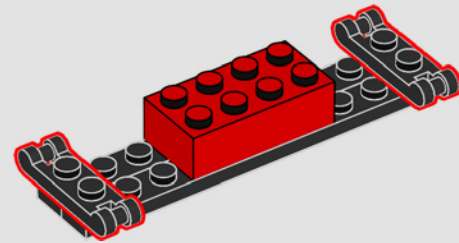

272

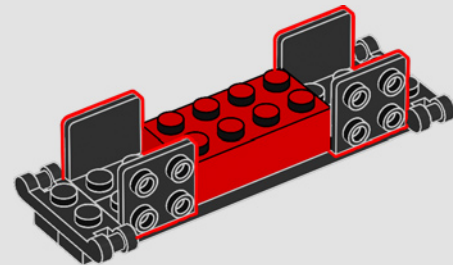

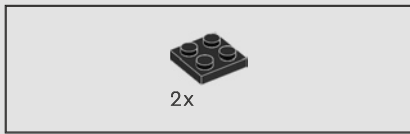

273

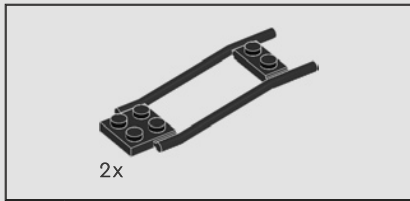
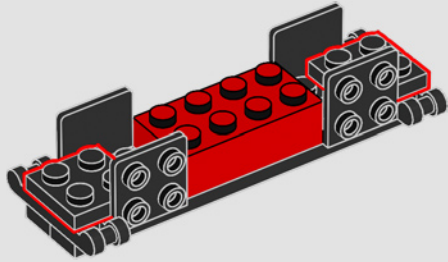

274

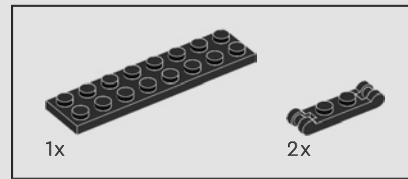
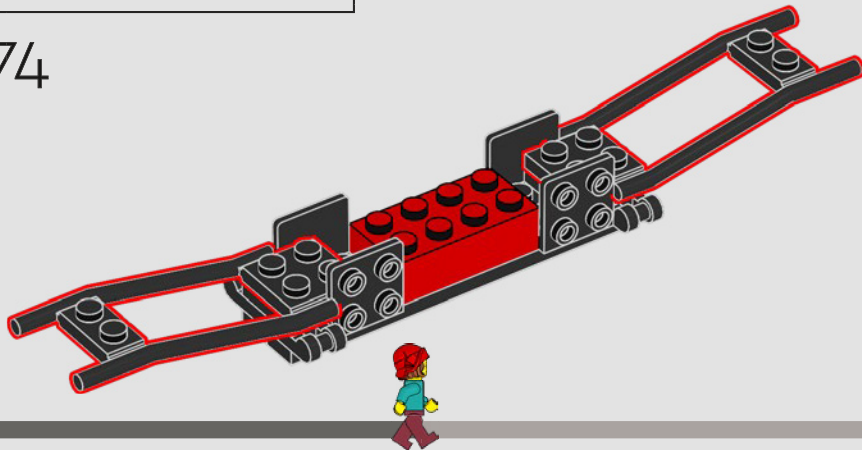

275

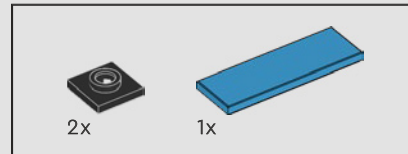
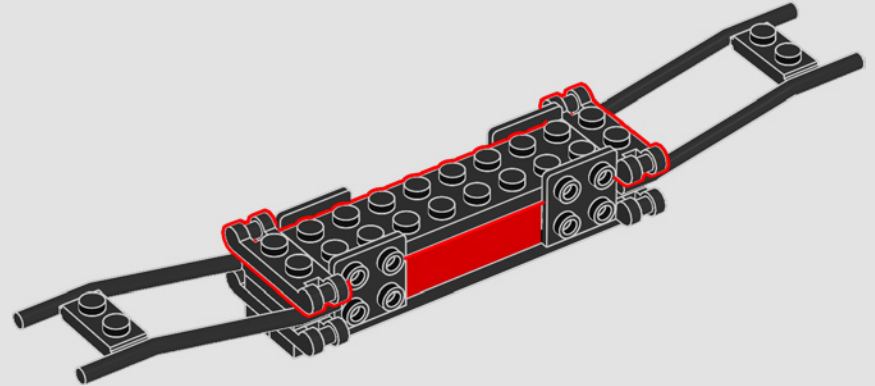

276

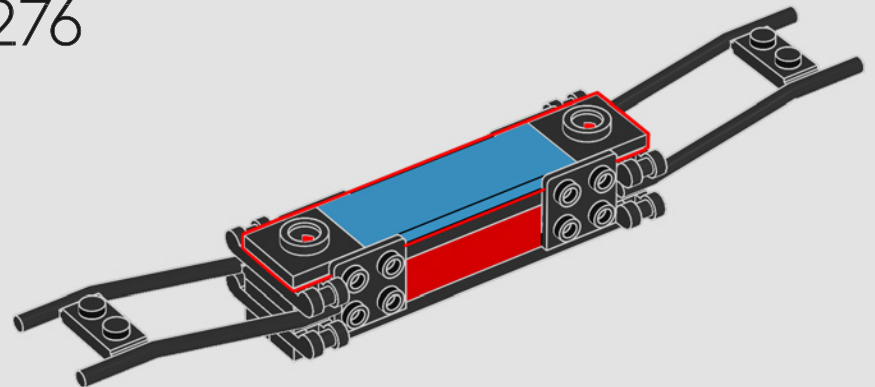

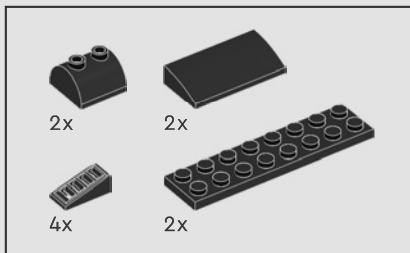

277

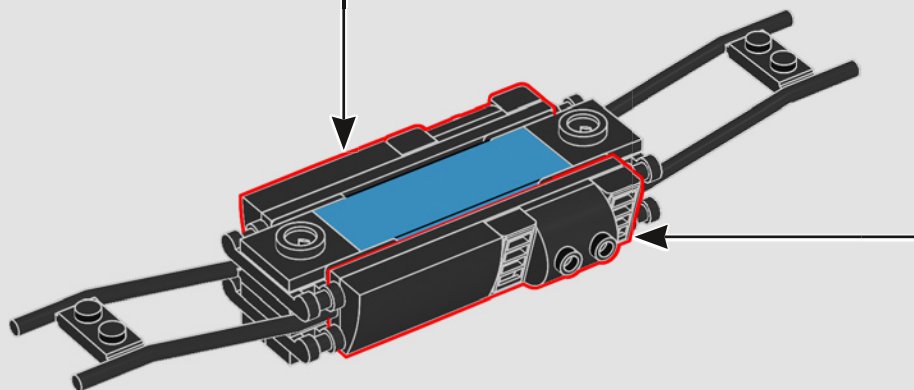
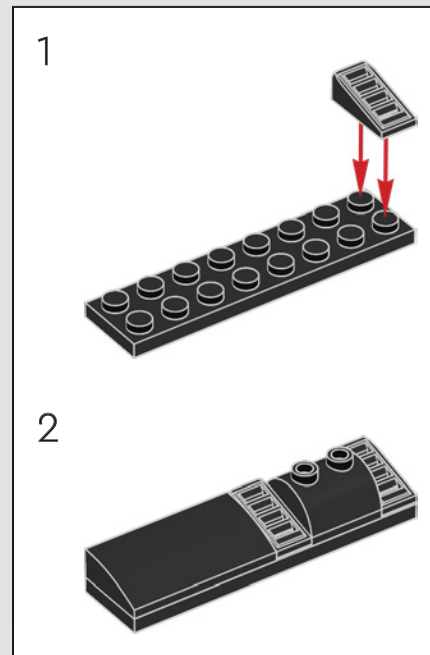
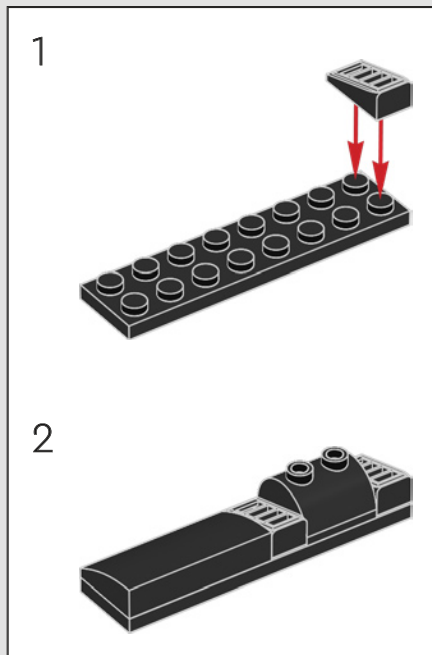

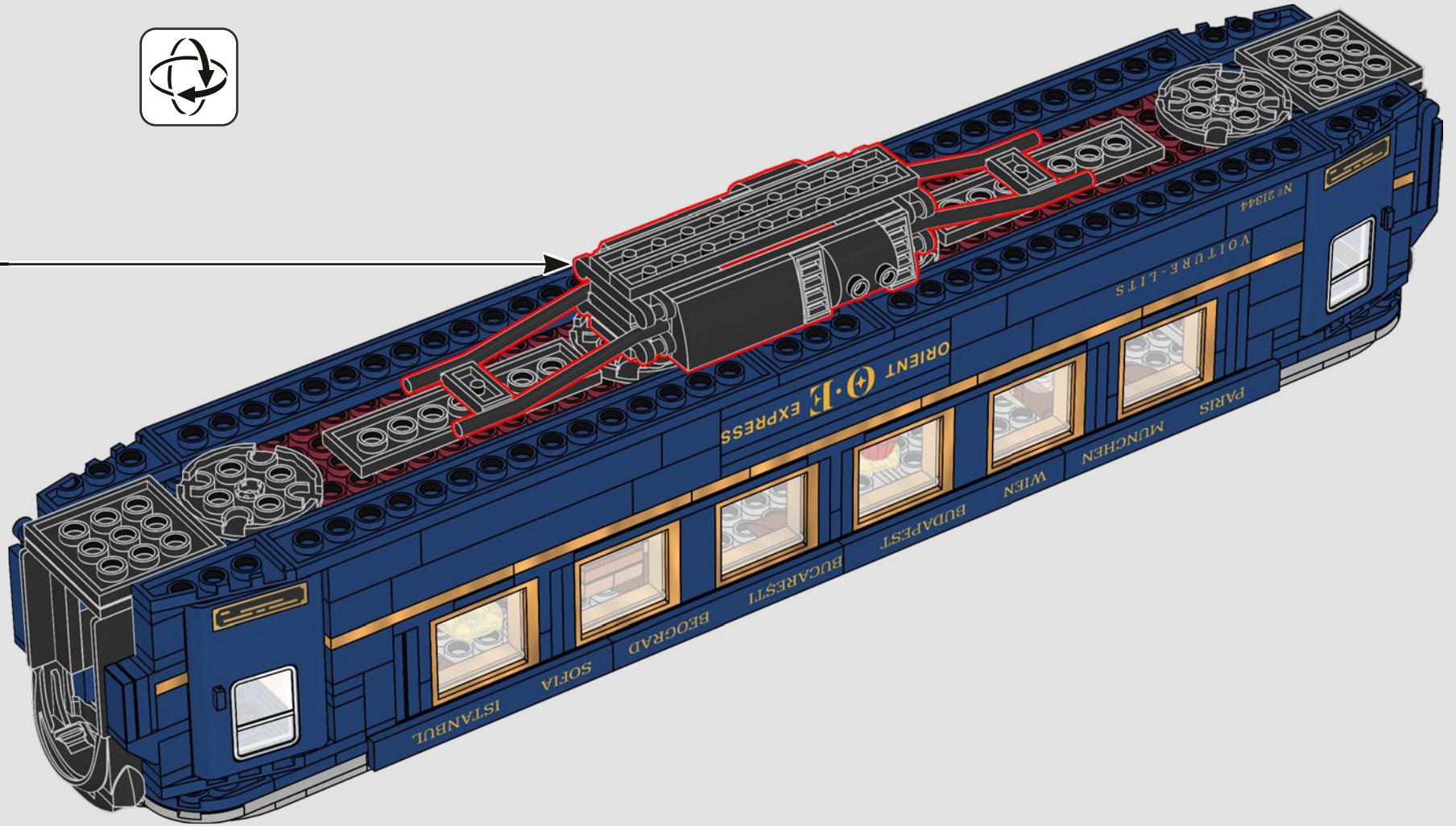

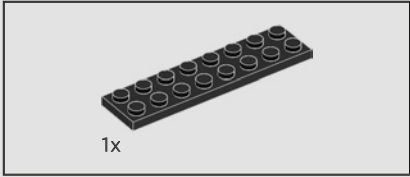
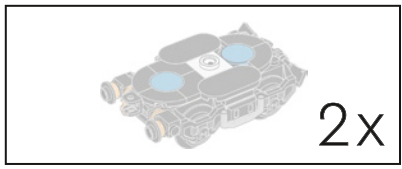

279

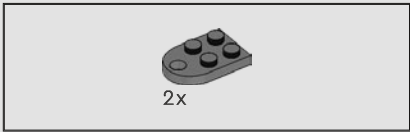
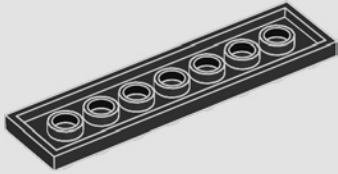

280

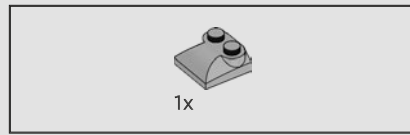
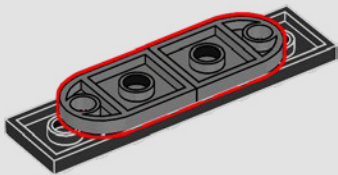

281

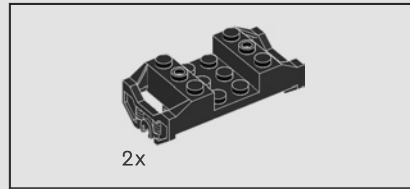
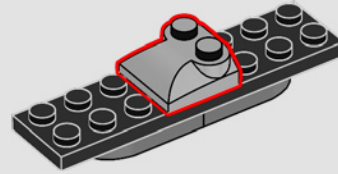

282

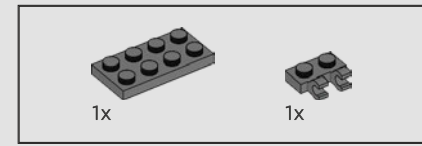
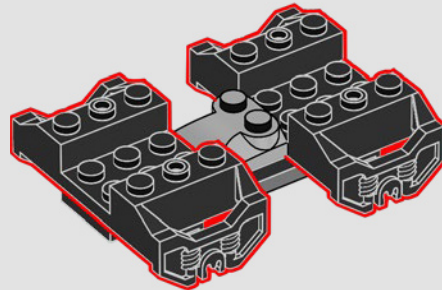

283

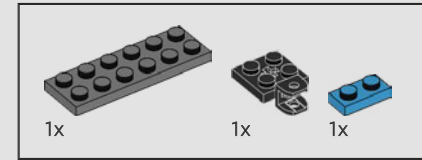
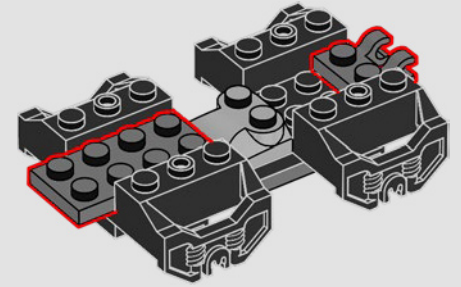

284

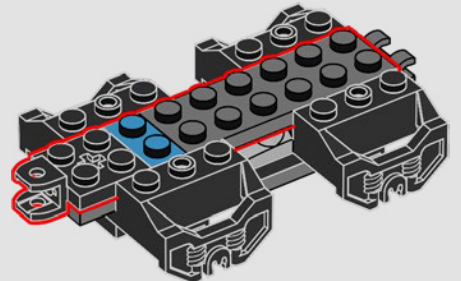

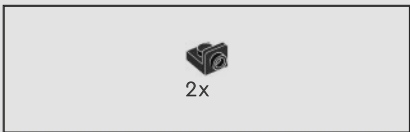

285

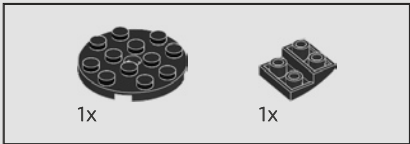
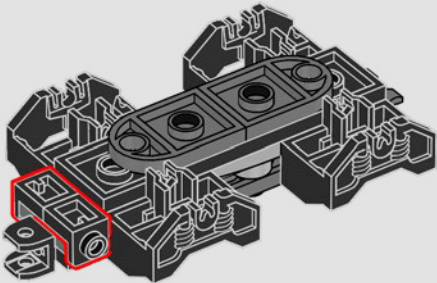

286

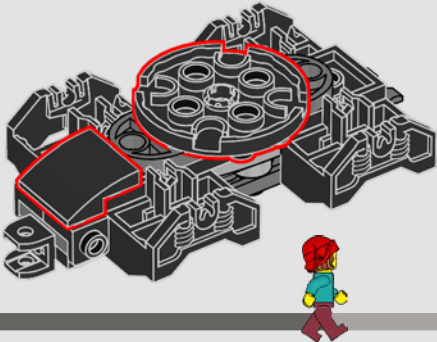

287

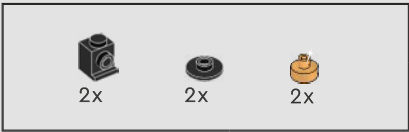
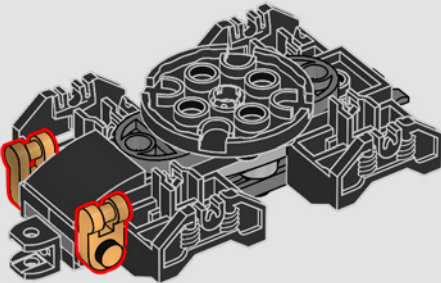

288

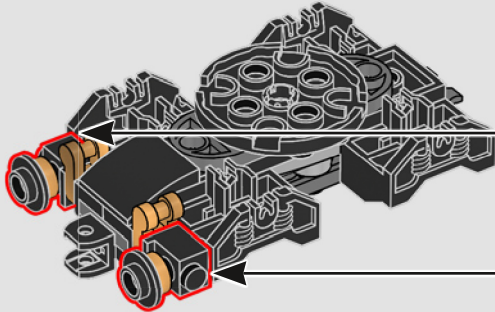
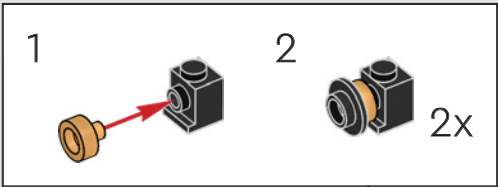

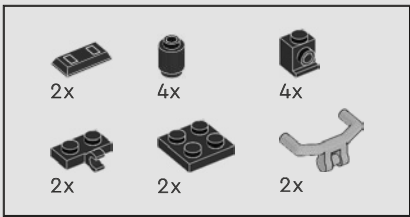

289

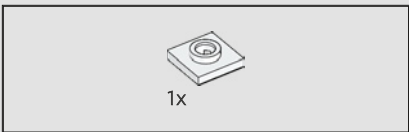
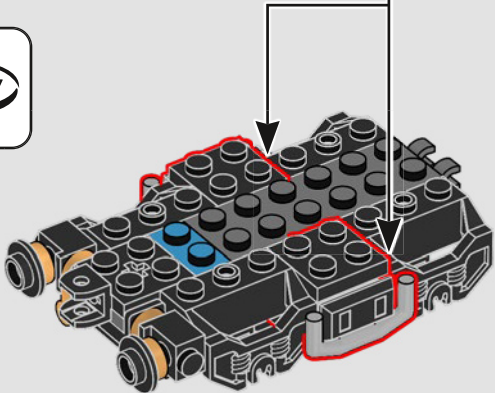
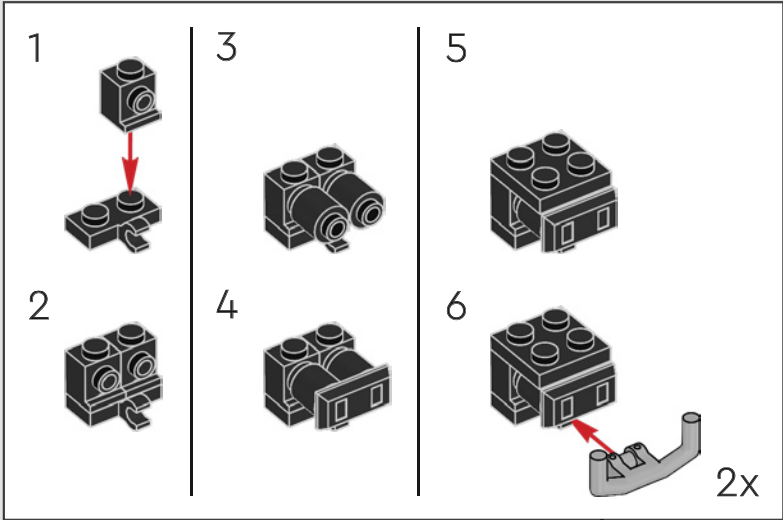

290

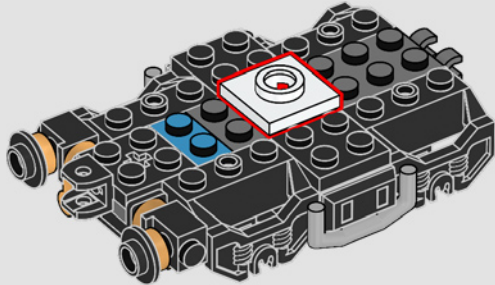

291

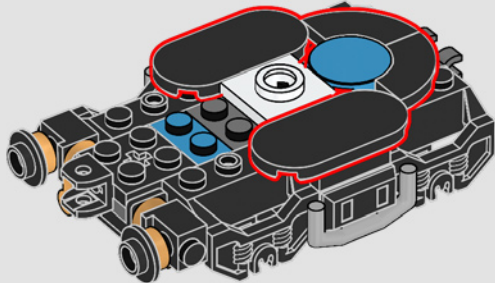

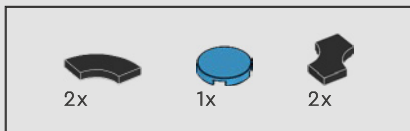

292

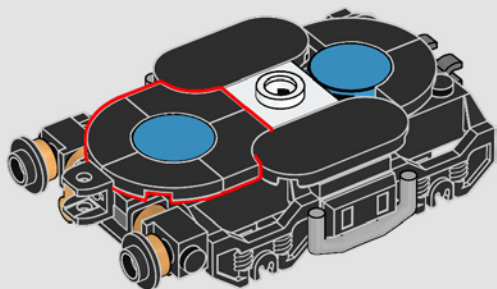

293

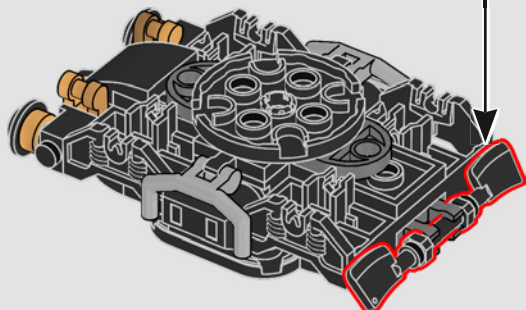
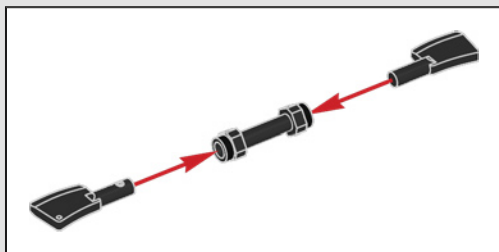

294

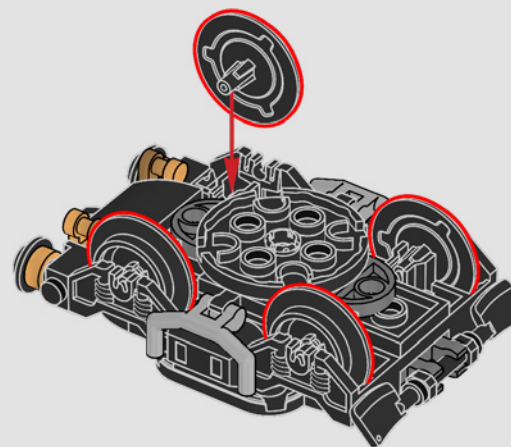

2x

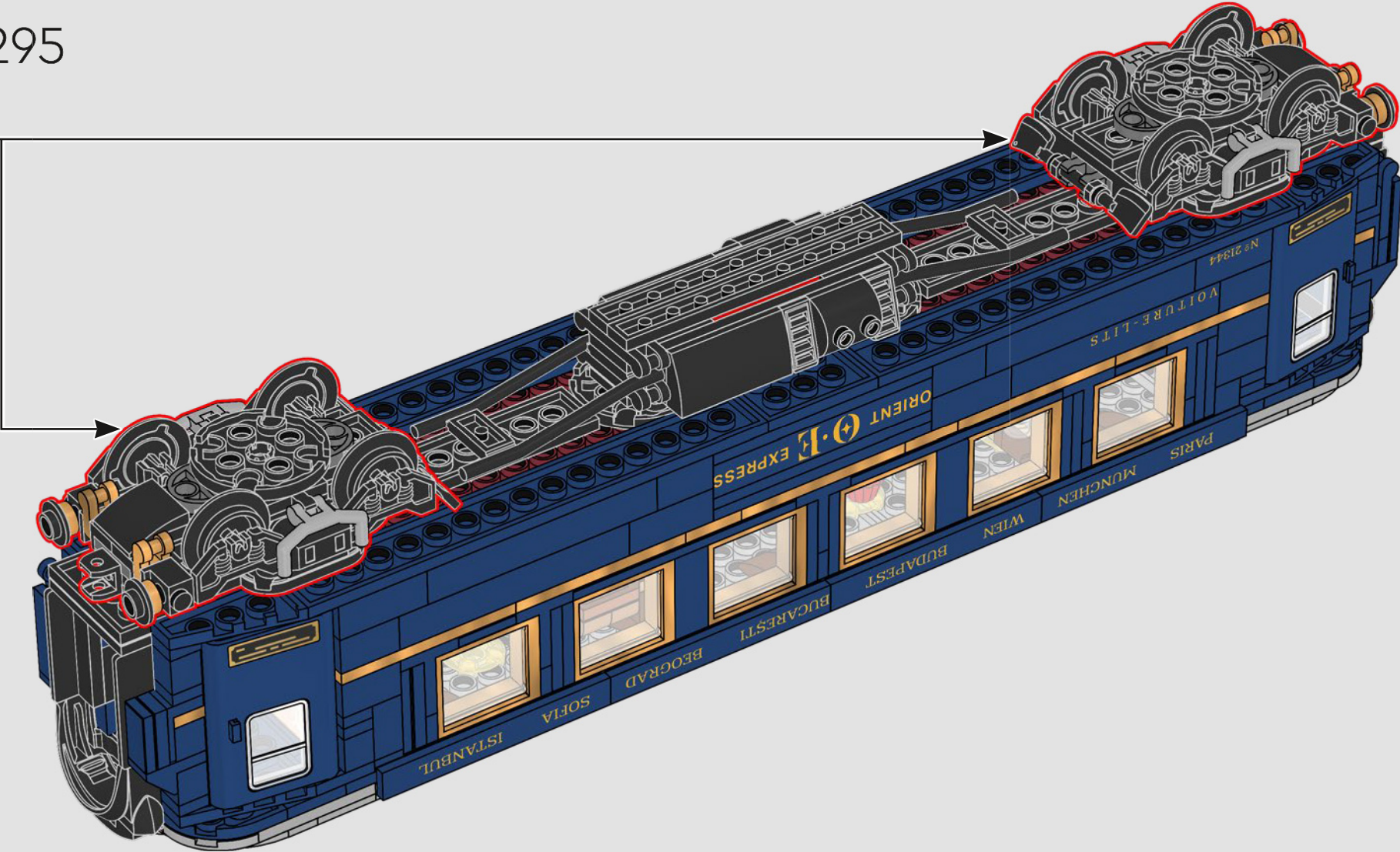



296

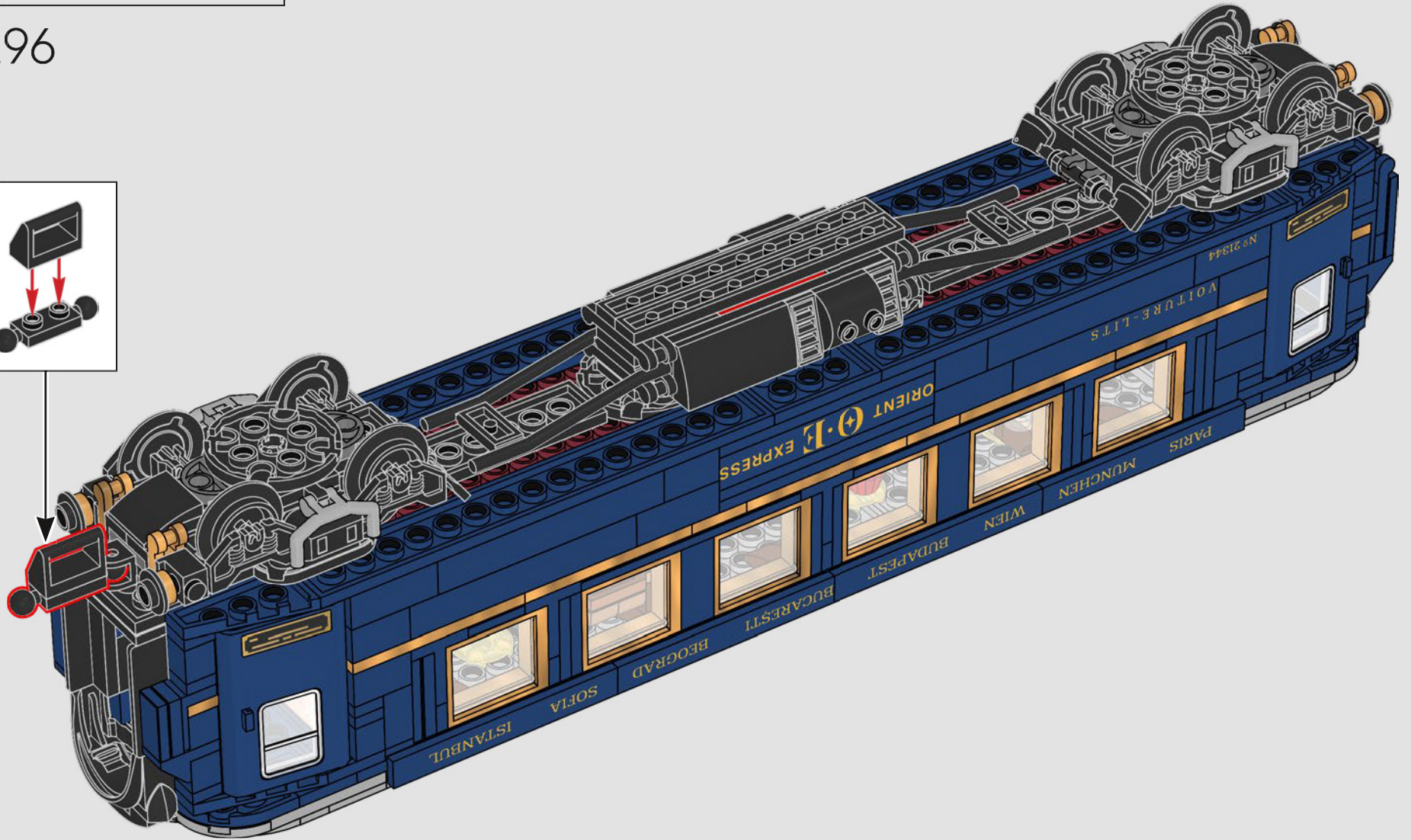
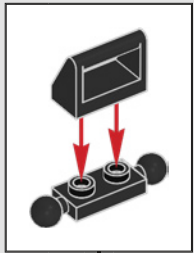

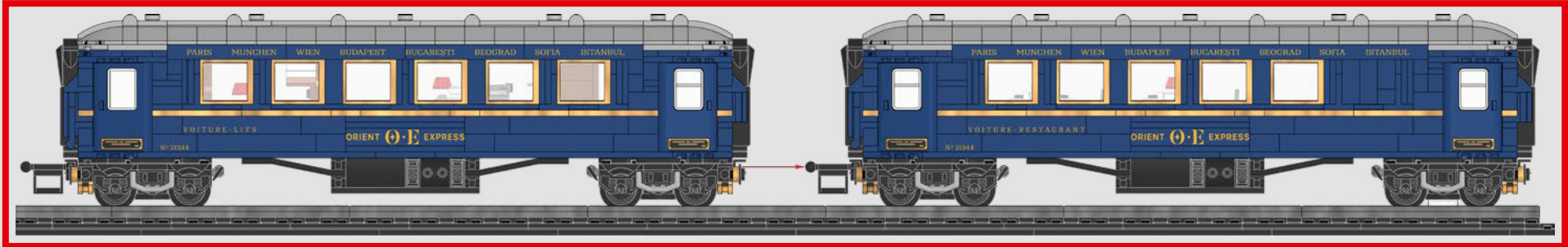
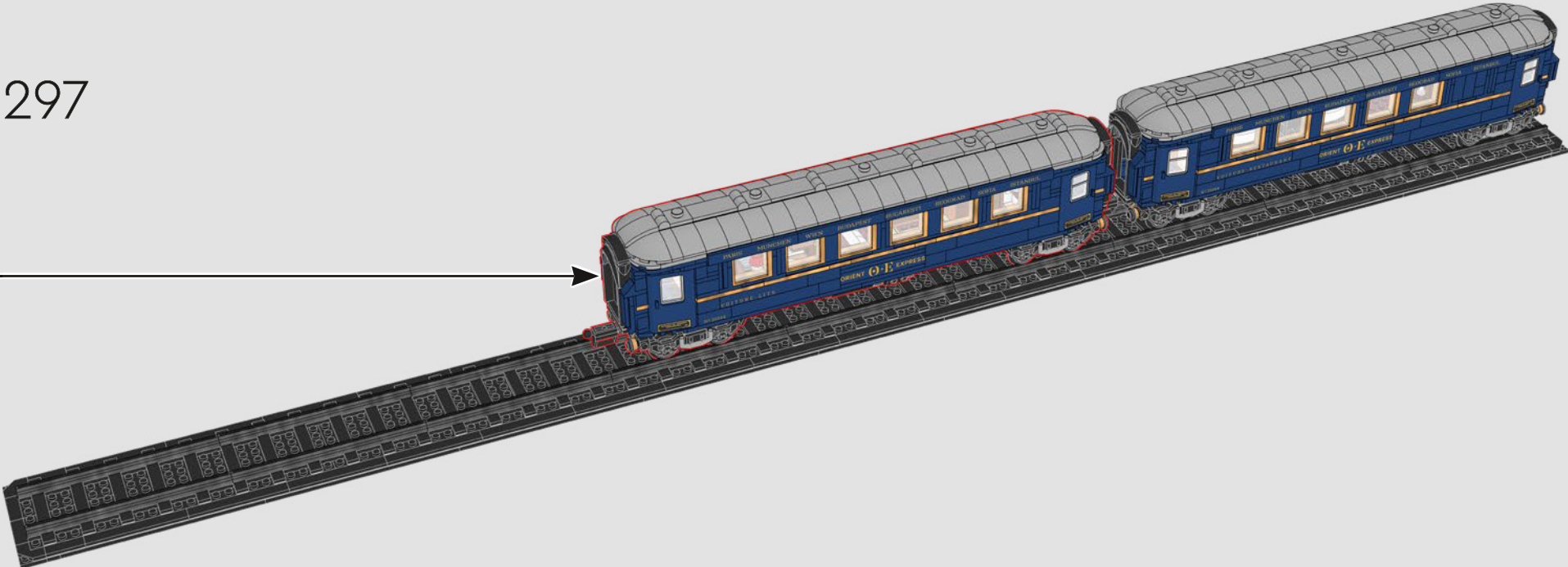

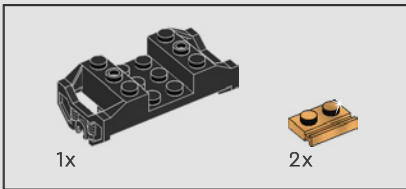
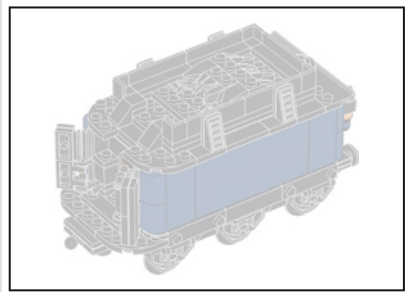

298

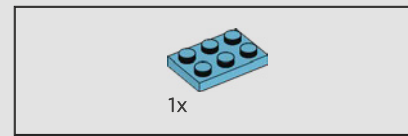
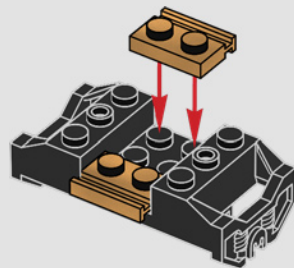

299

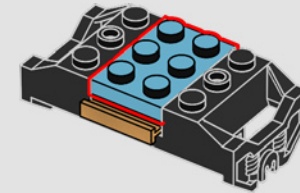

300

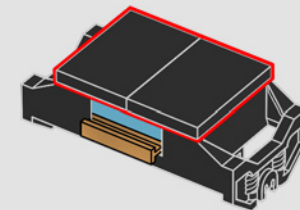

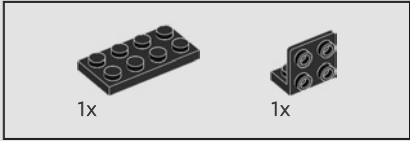
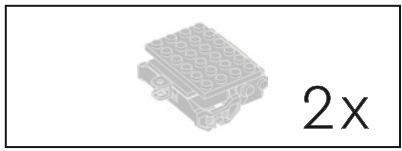

301

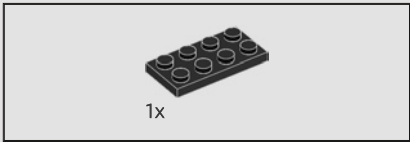
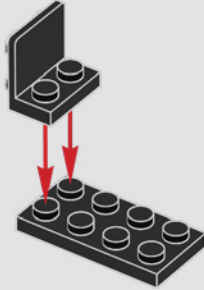

302

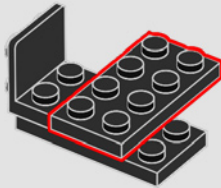

303

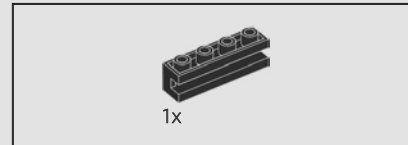
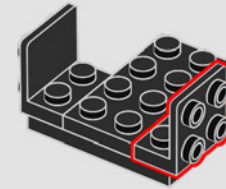

304

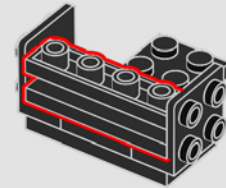



305

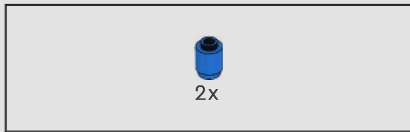
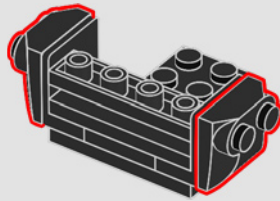

306

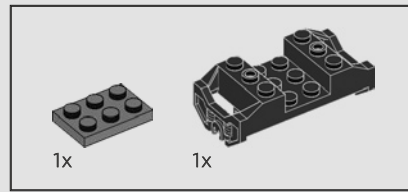
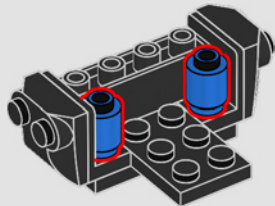

307

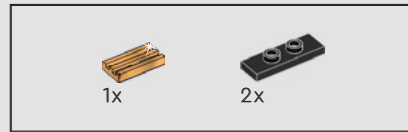
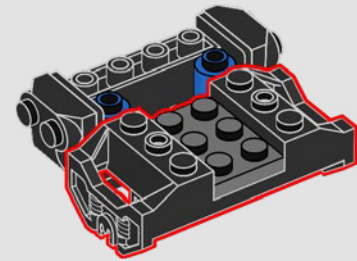
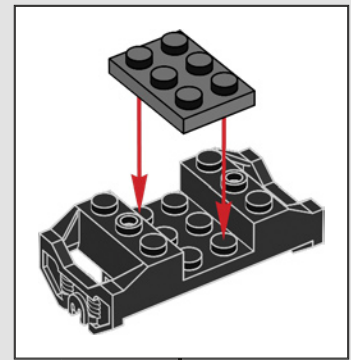

308

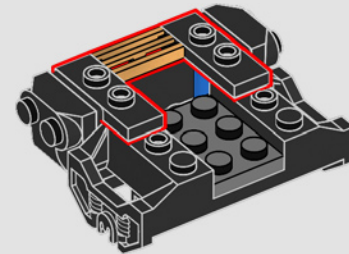

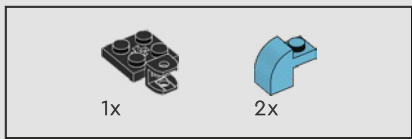

309

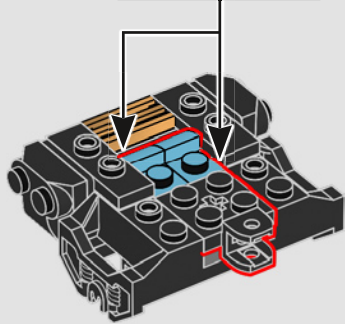
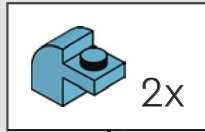

310

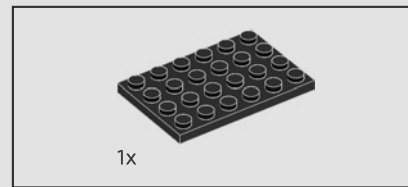
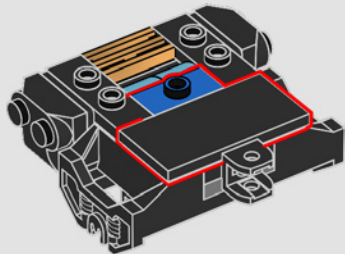

311

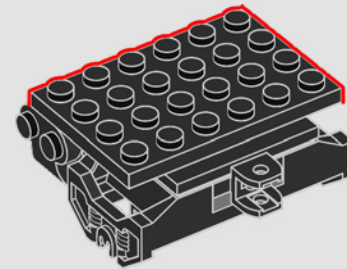

2x

312

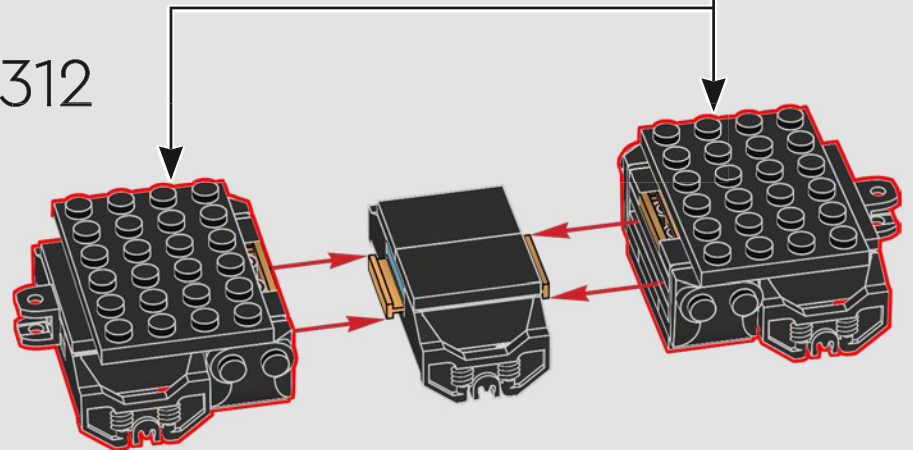

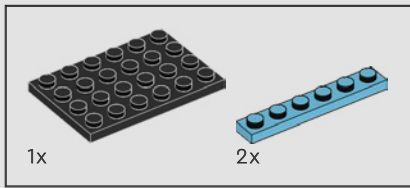

313

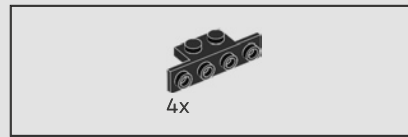
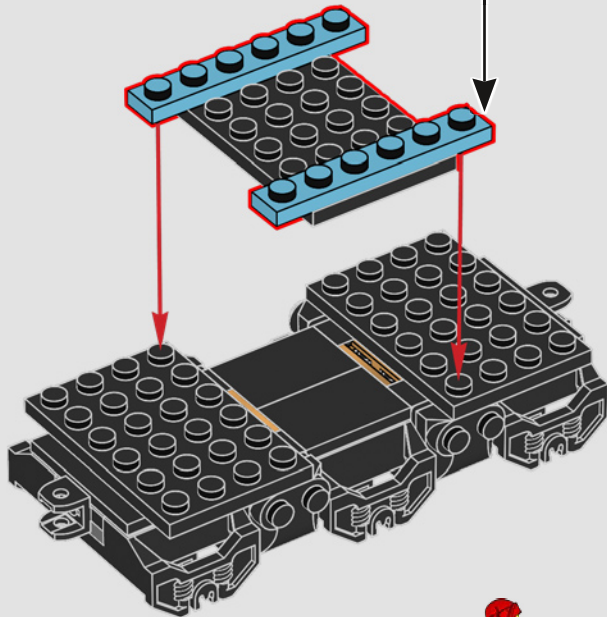
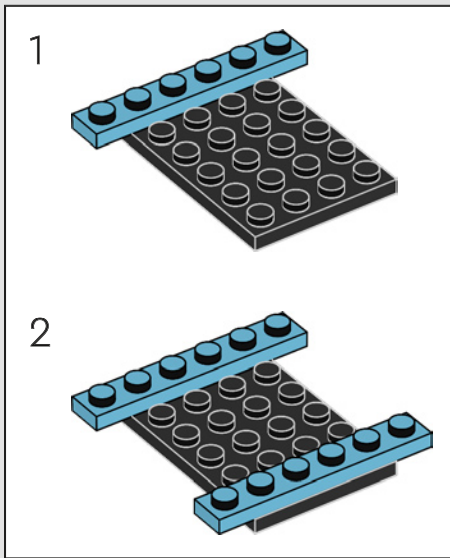

314

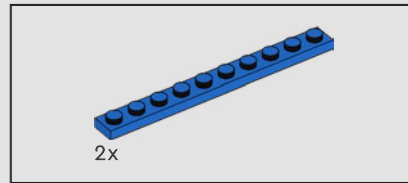
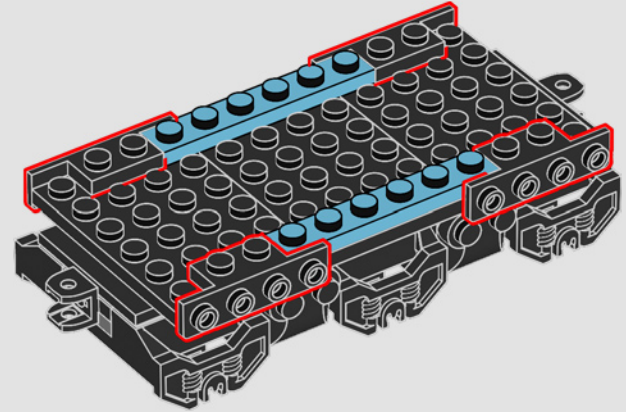

315

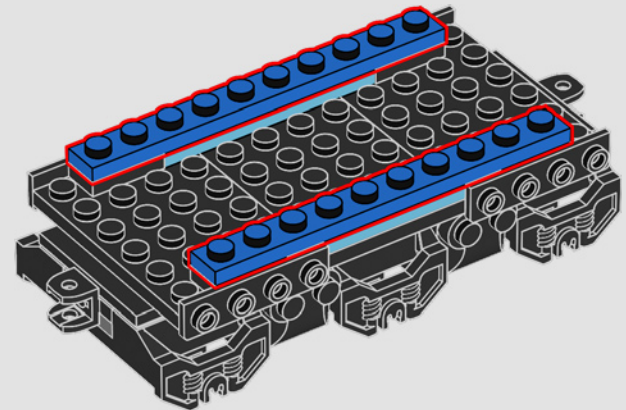

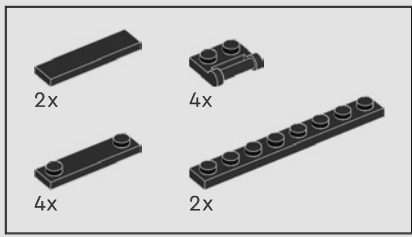

316

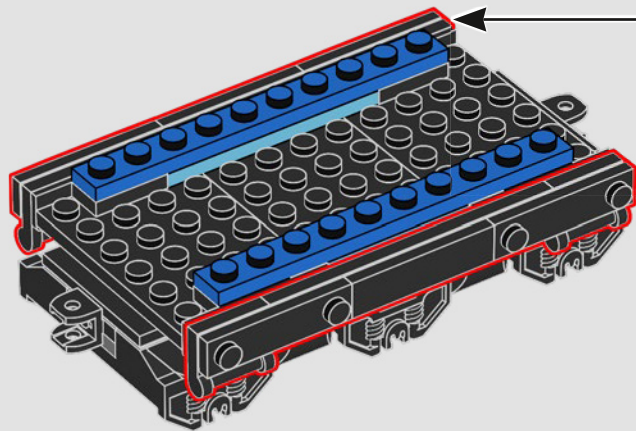
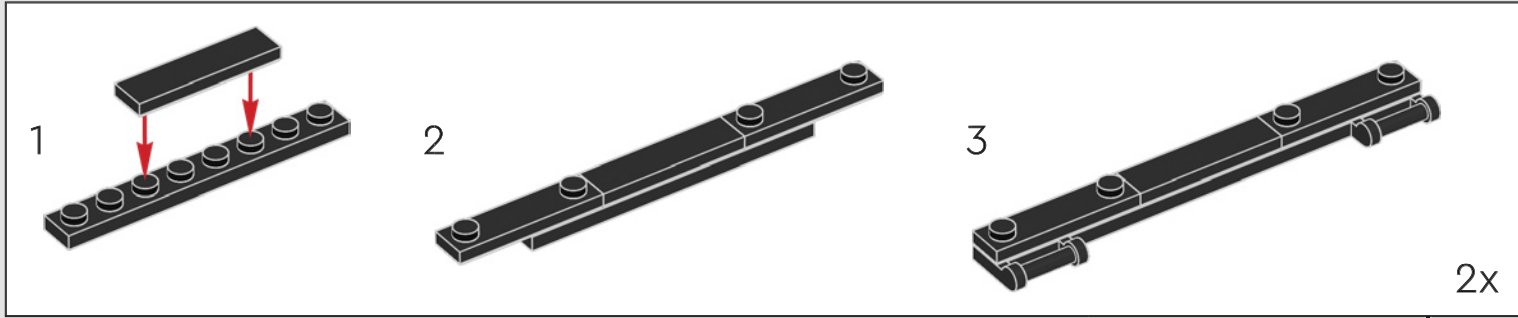

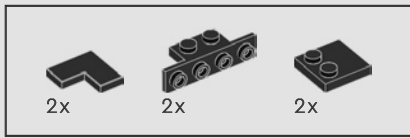

317

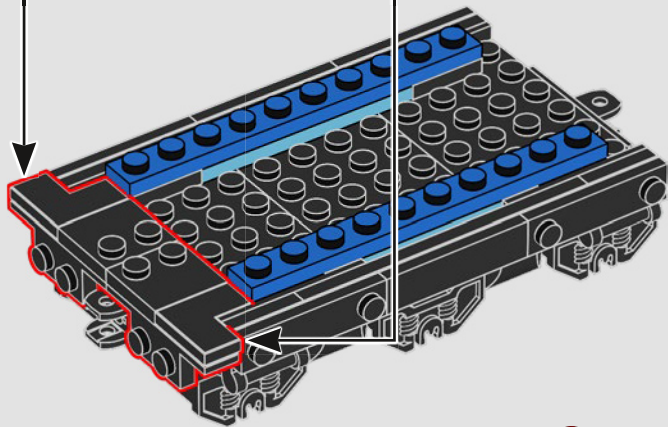
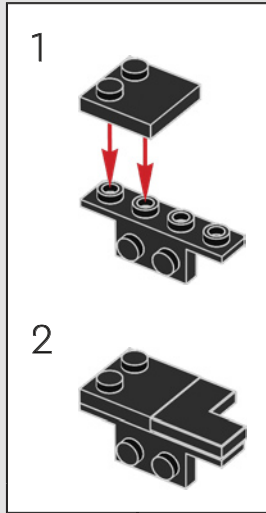
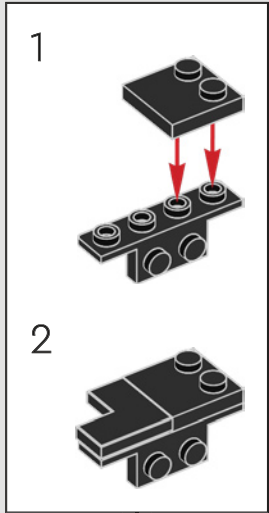

318

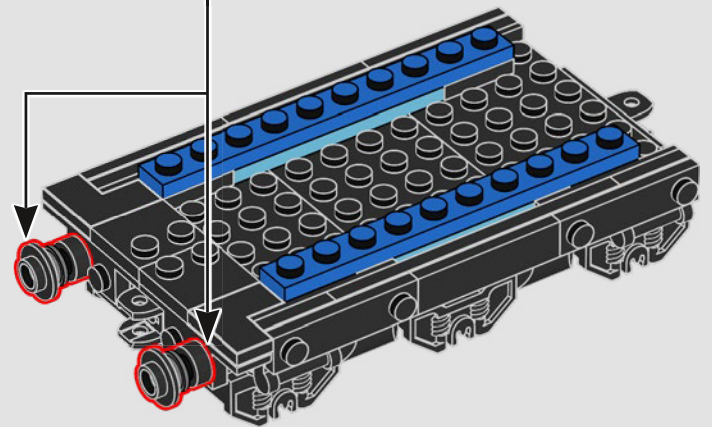
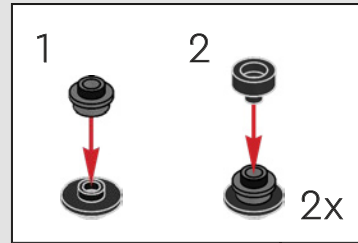

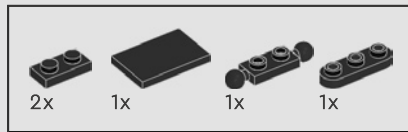

319

“Puede verse que la locomotora no deja de expulsar vapor. ¡El tender de carbón tiene que ser muy grande para alimentar semejante máquina!”.

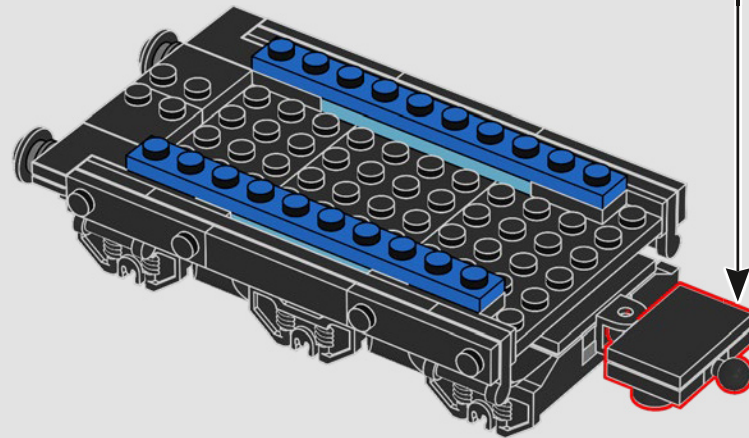
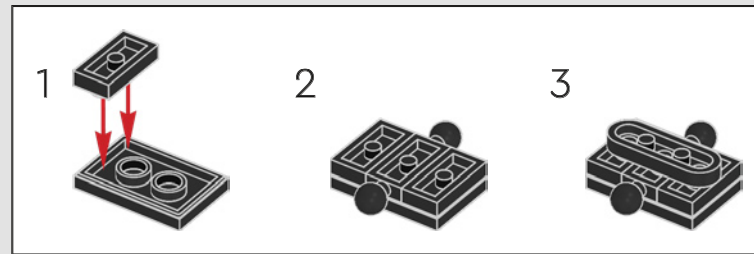

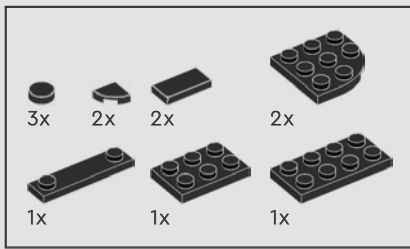

320

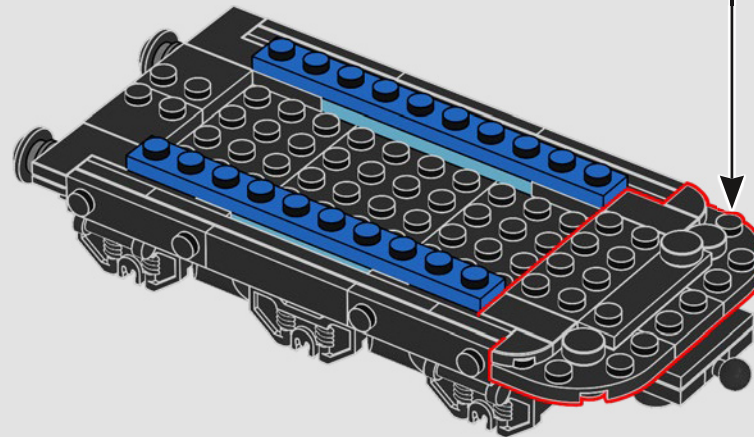
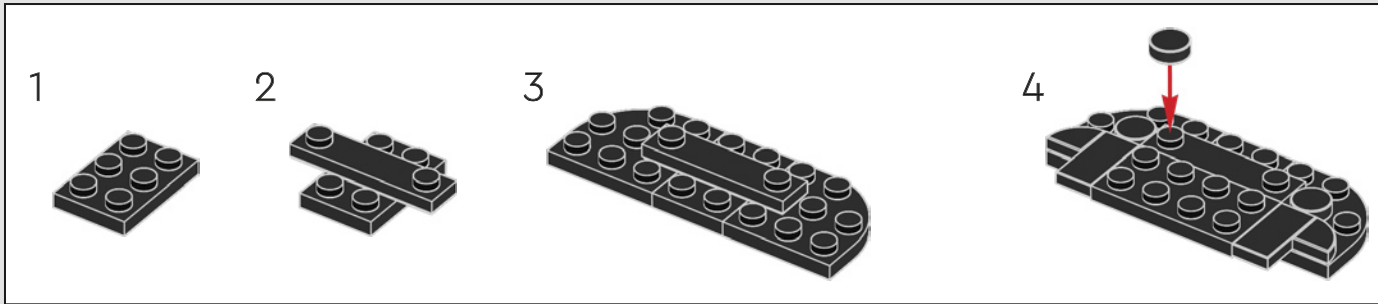

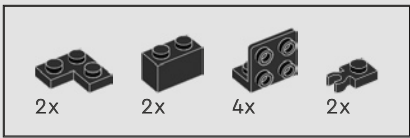

321

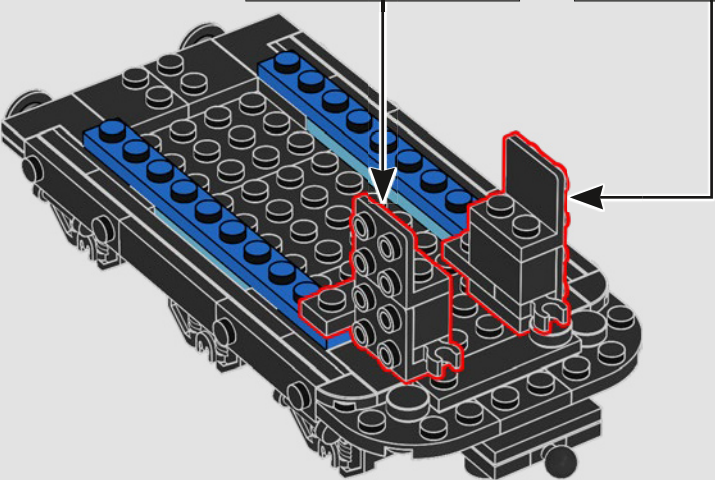
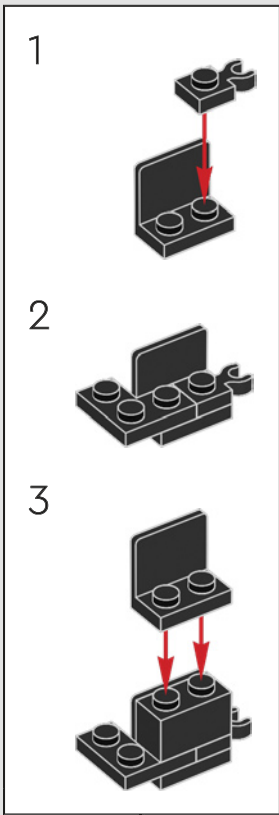
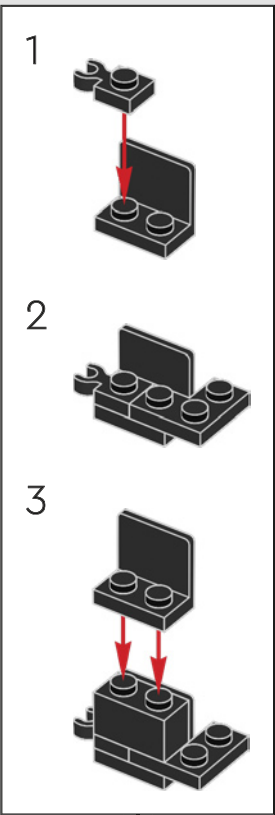



322

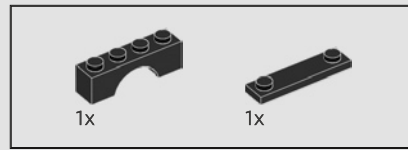
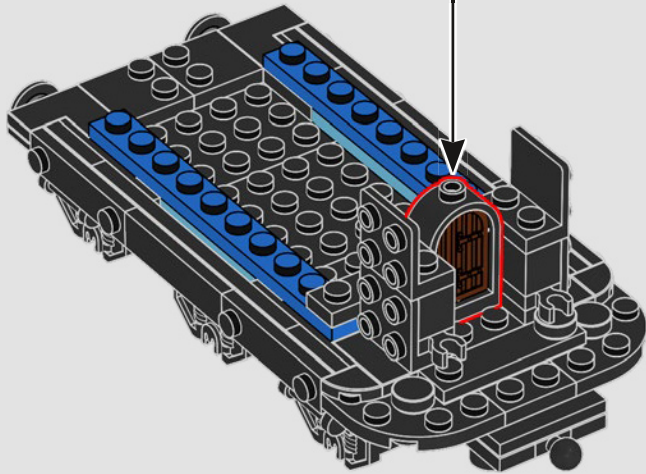
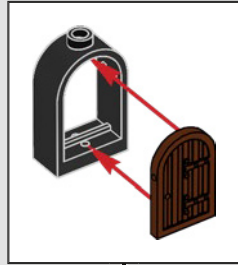

323

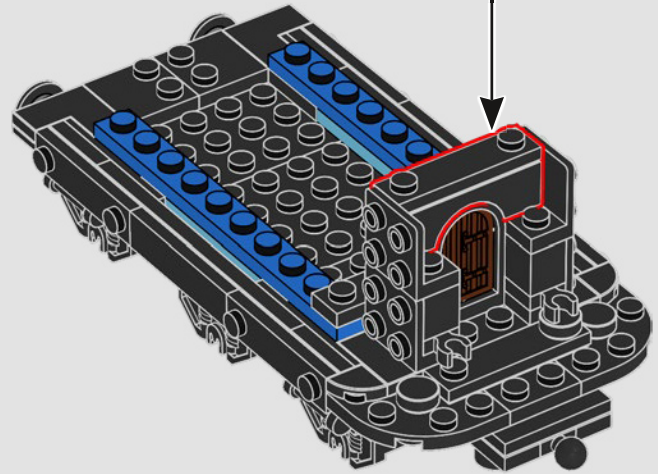
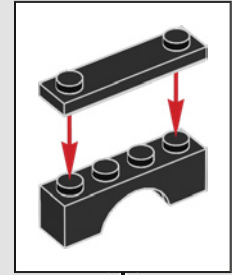

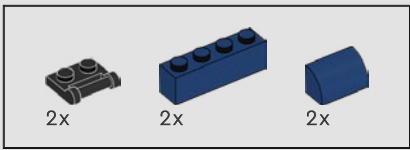

324

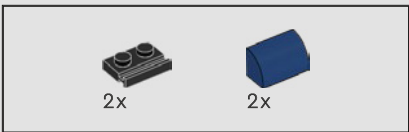
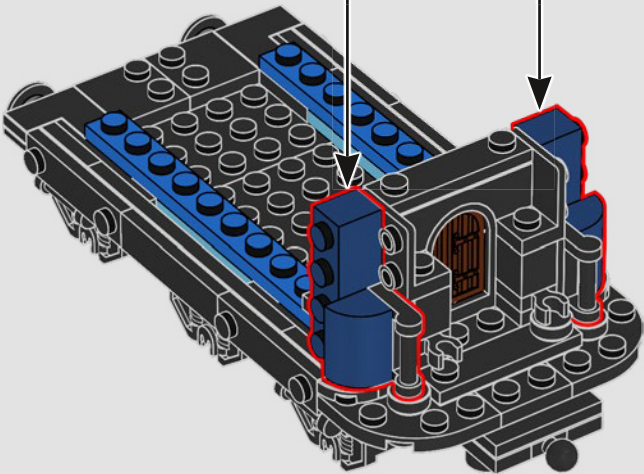
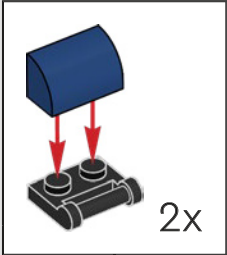

325

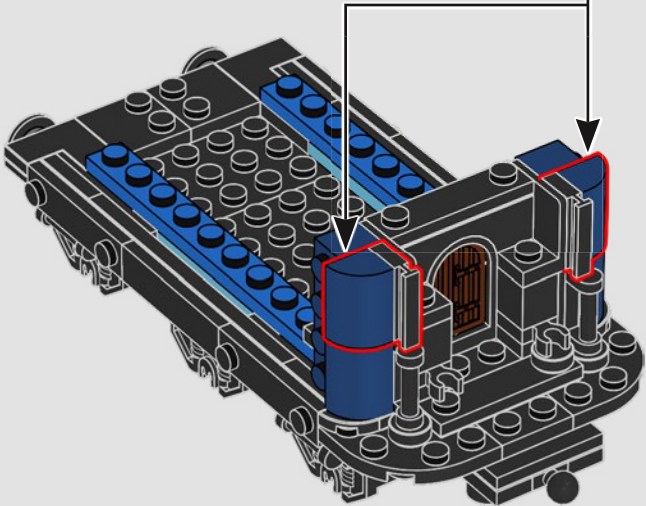
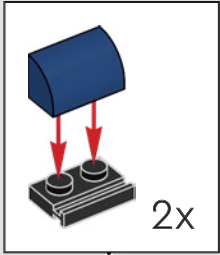



326

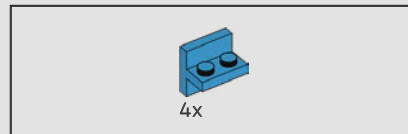
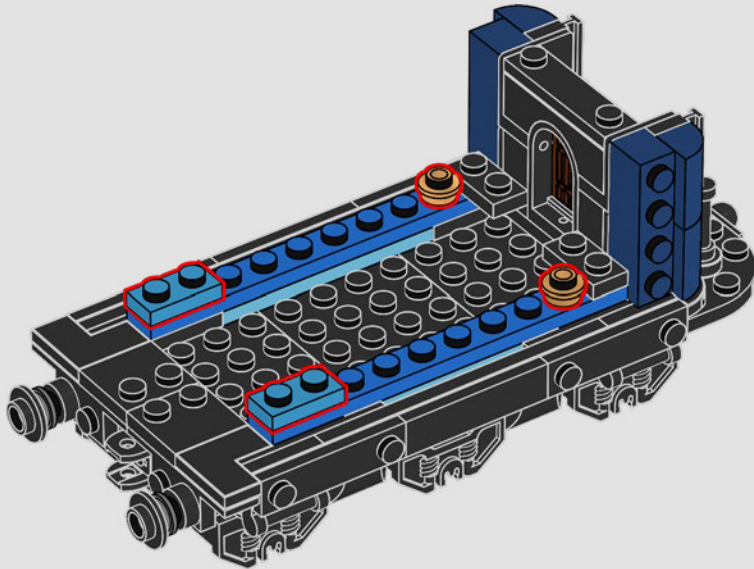

327

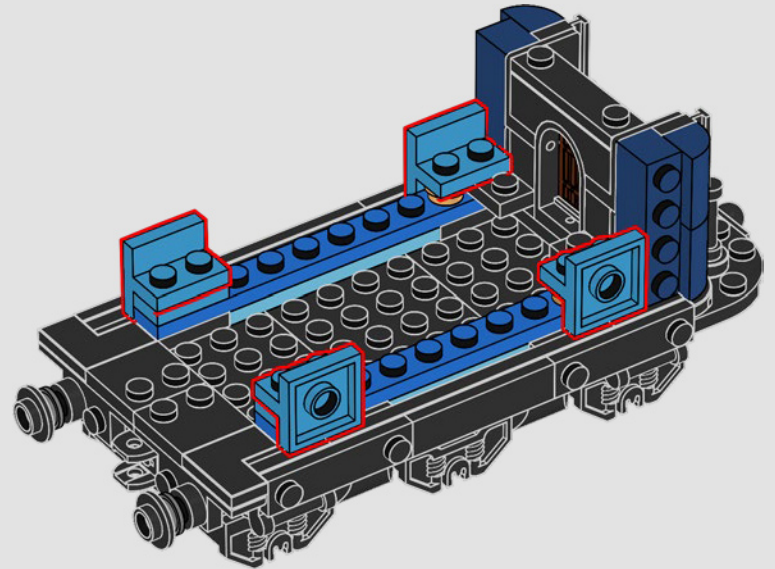



2x

328

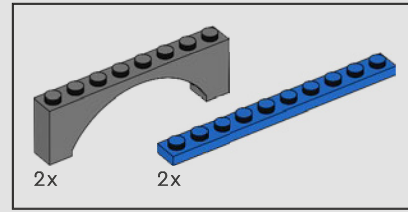
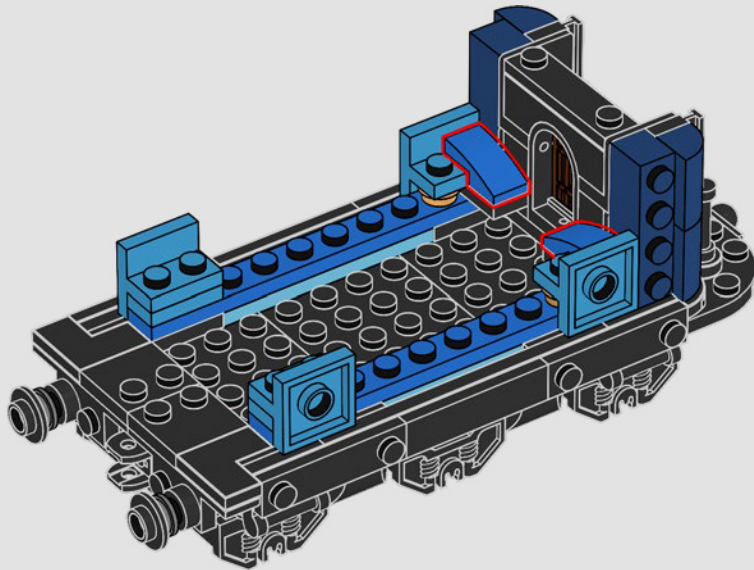

329

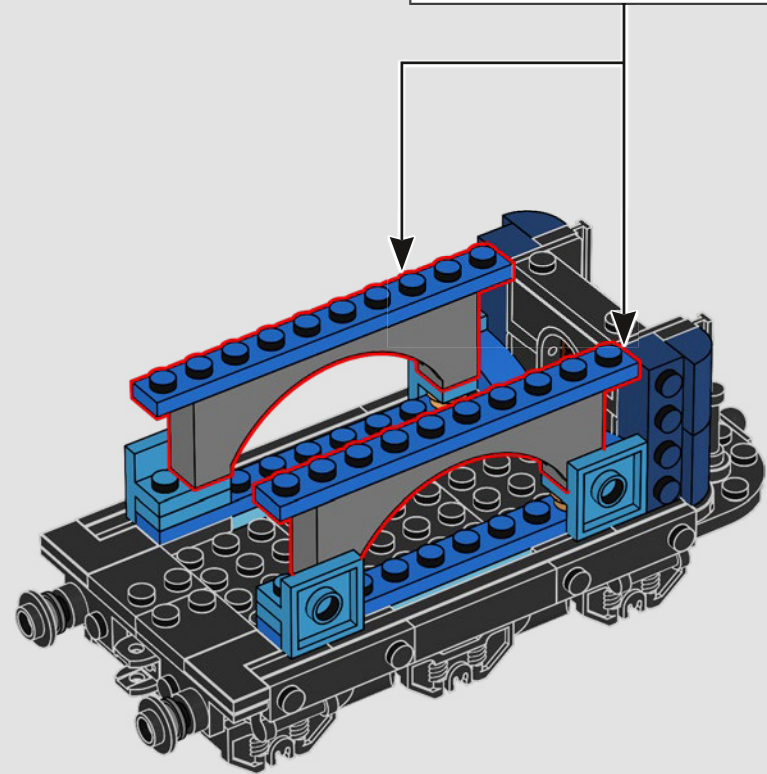
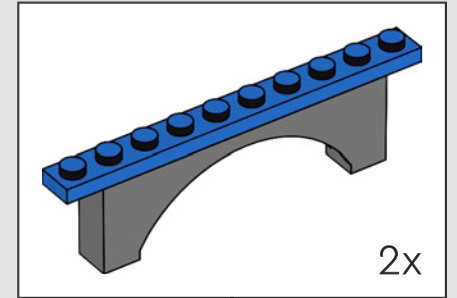

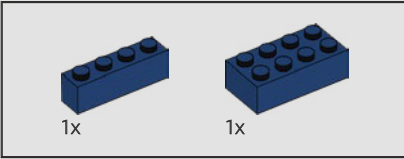
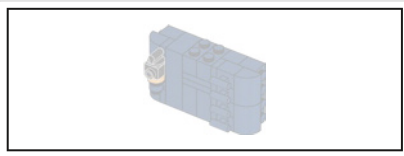

330

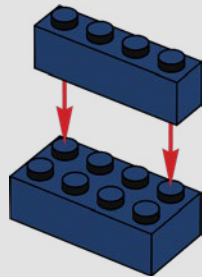

331

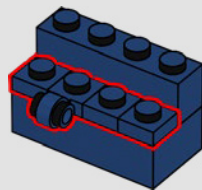

2x

332

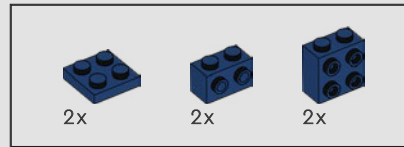
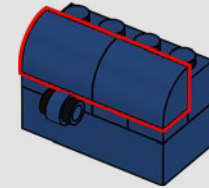

2x

2x

2x

333

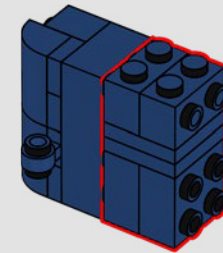
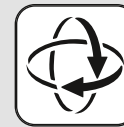
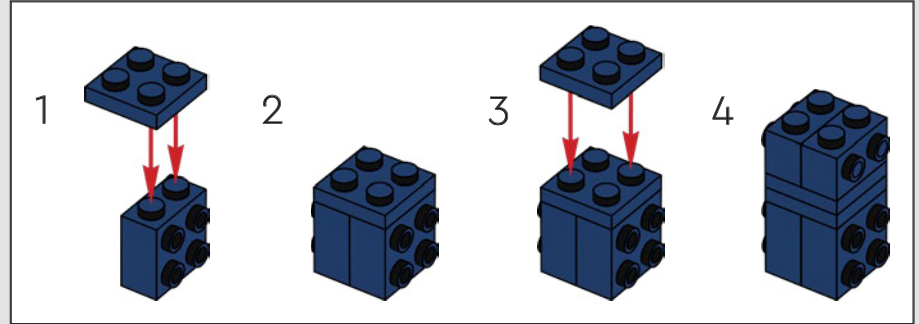

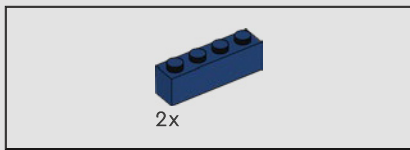

334

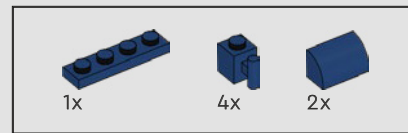
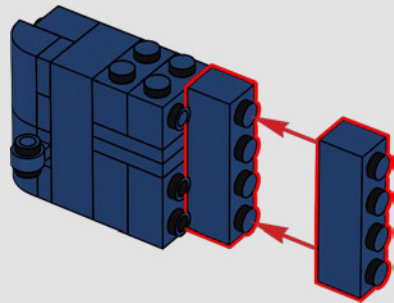

335

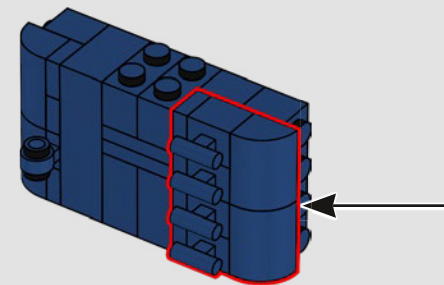
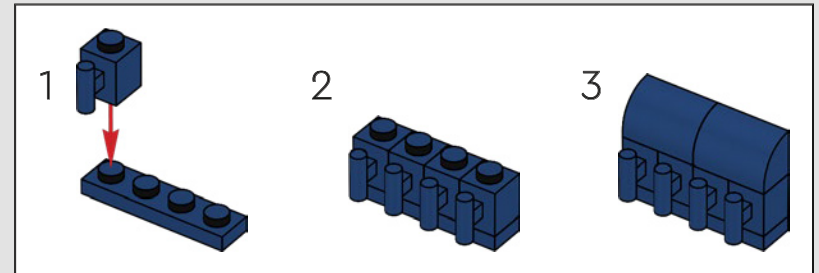



336

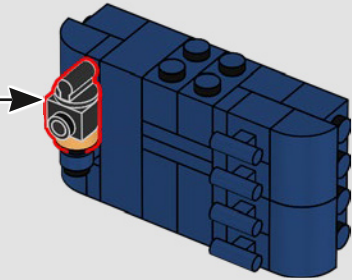
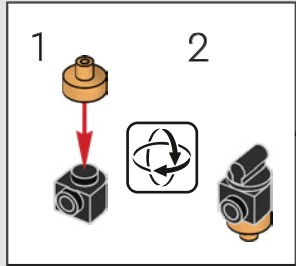

337

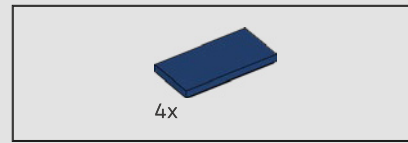
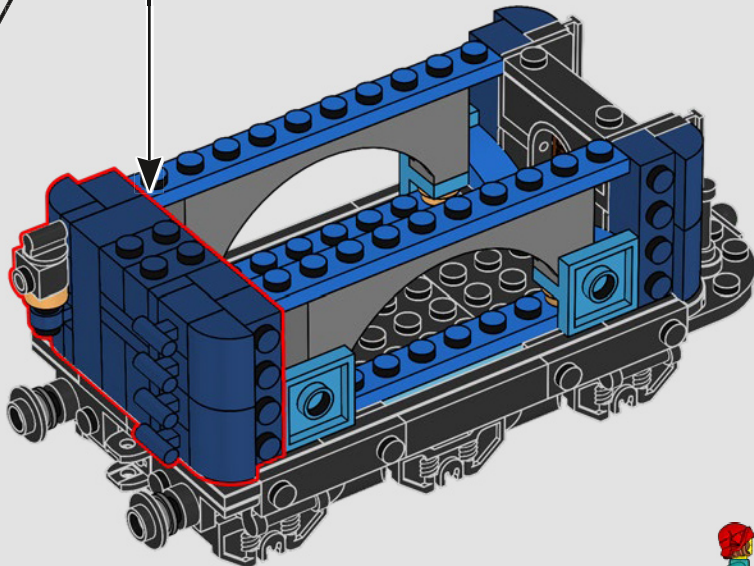

338

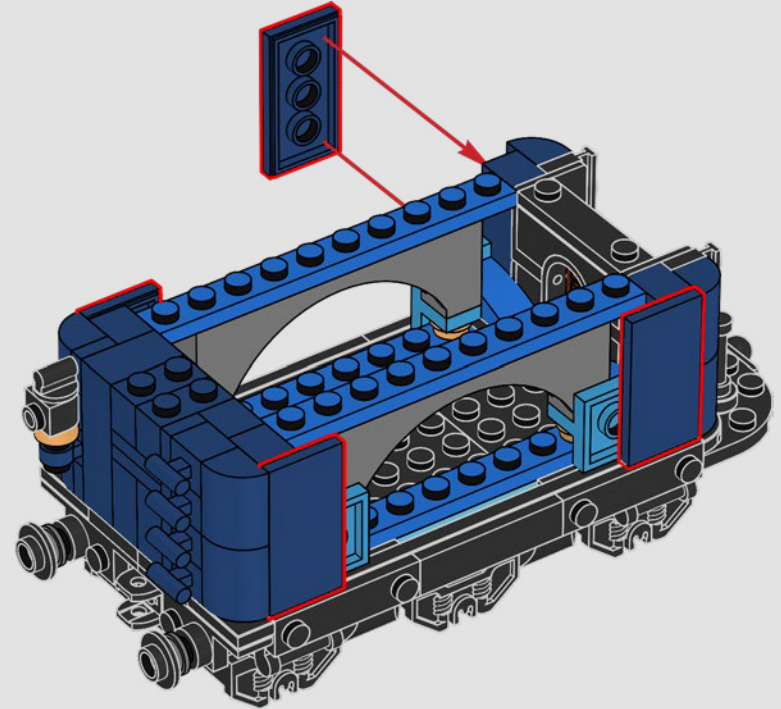

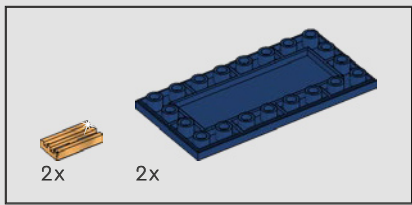

339

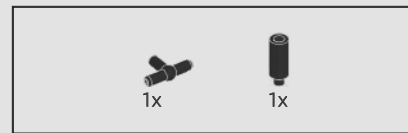
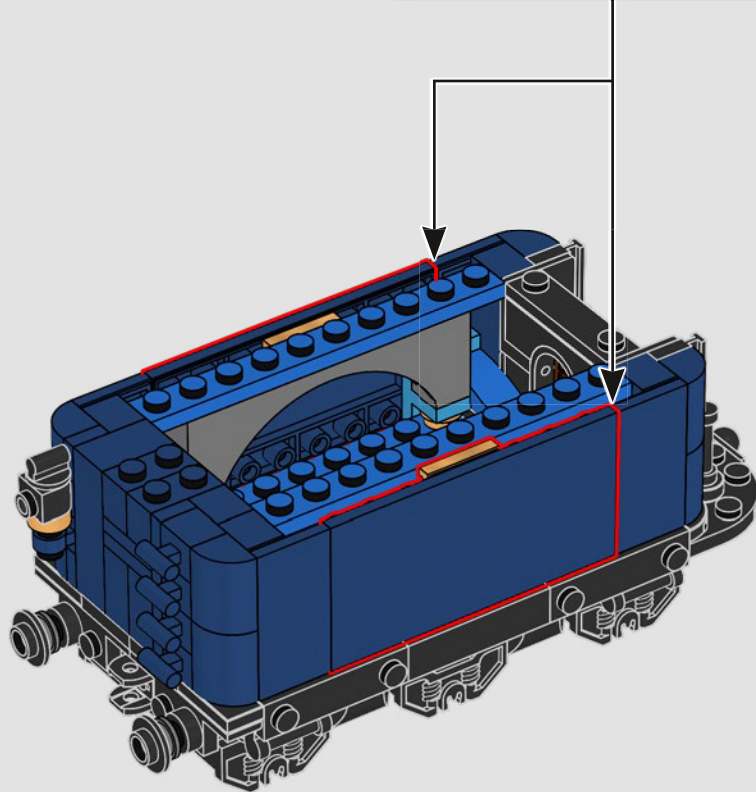
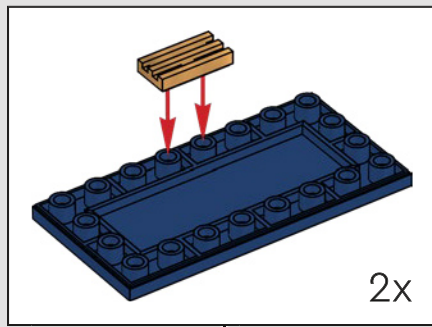

340

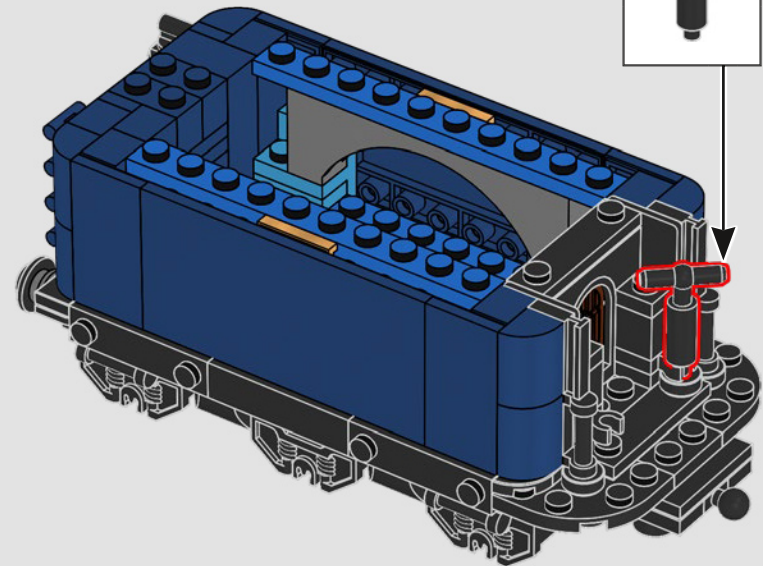
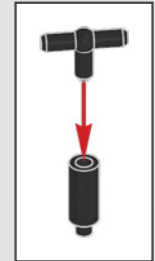

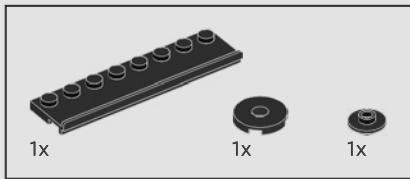

341

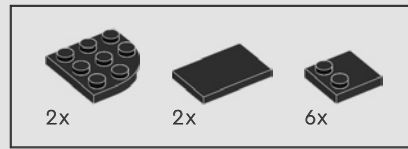
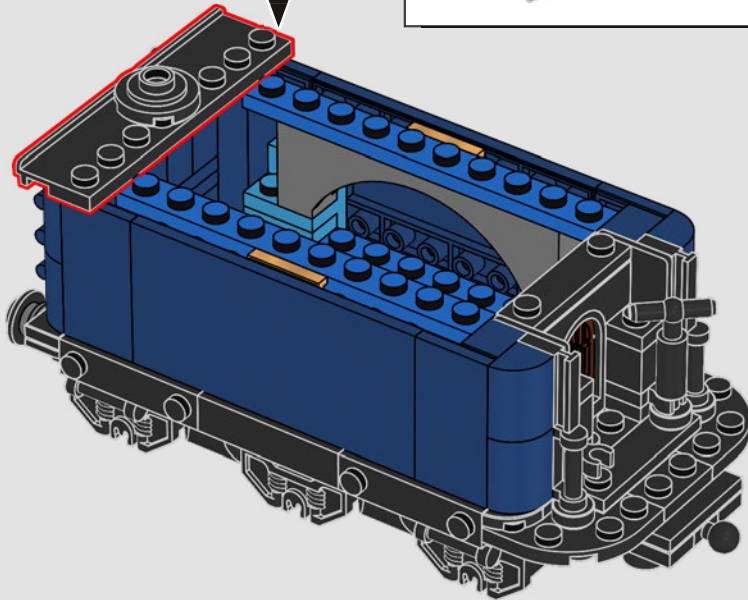
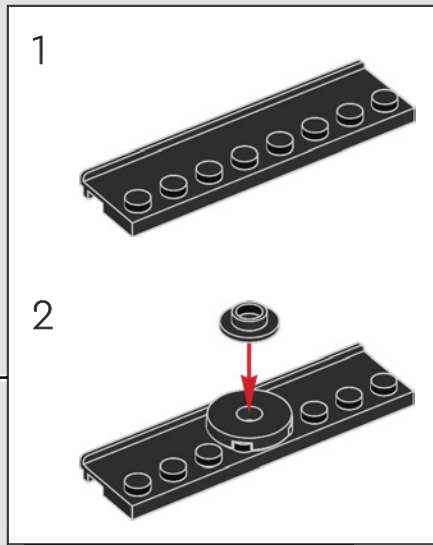

342

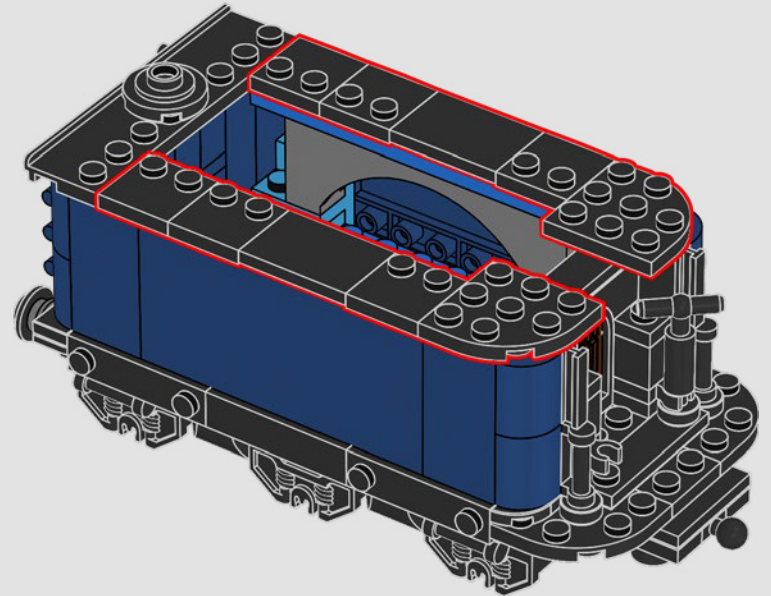

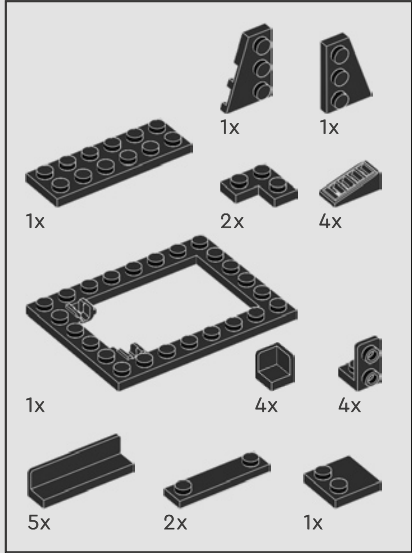
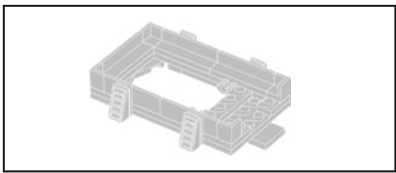

343

1

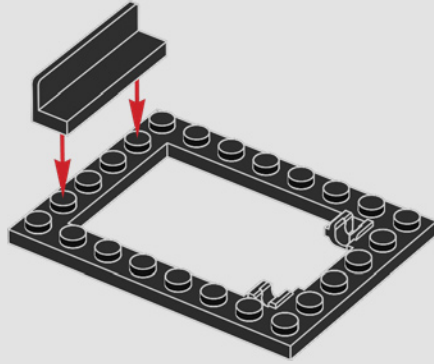

2

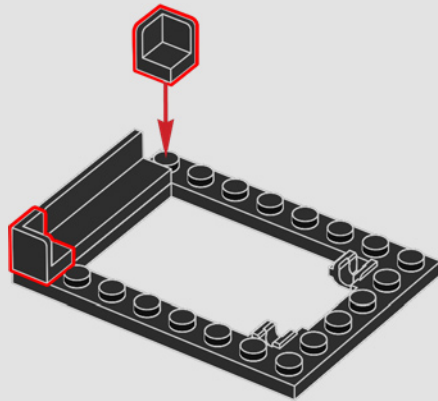

3

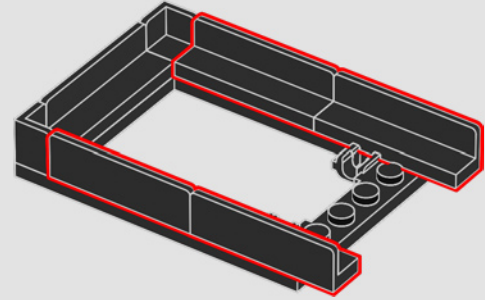

4

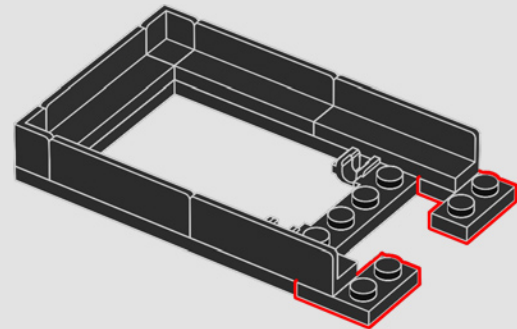

5

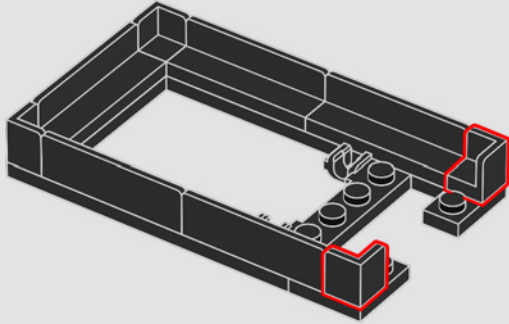

6

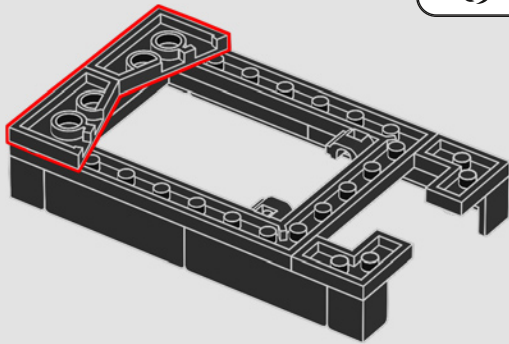

7

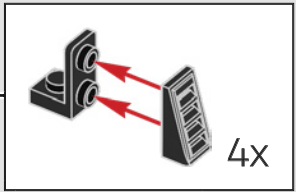
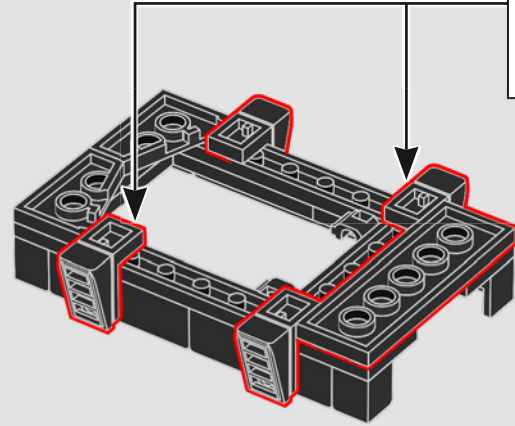

8

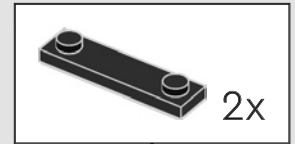
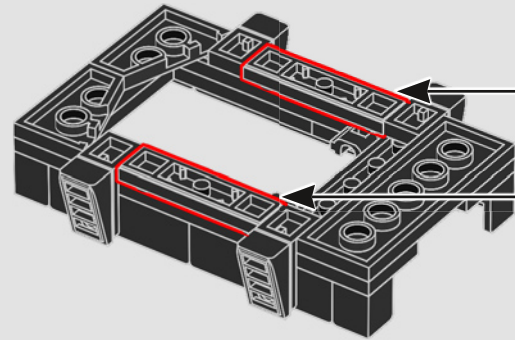



9

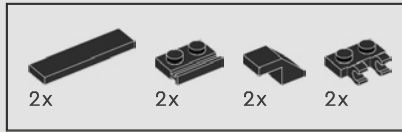
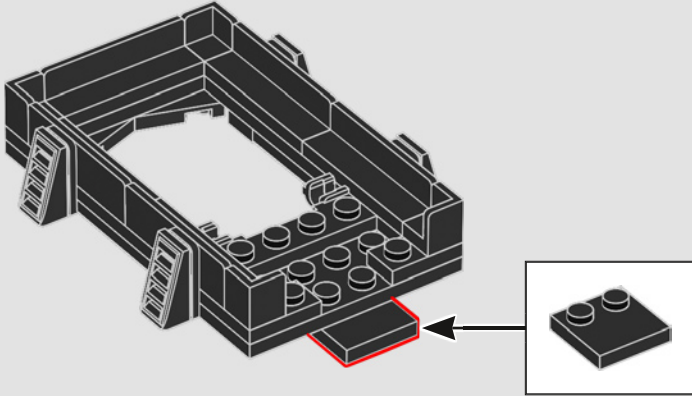

344

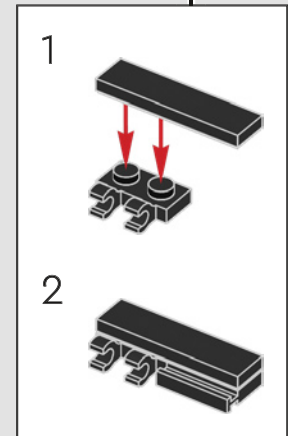
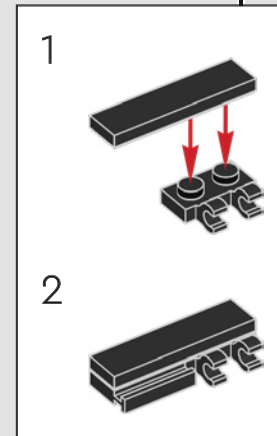
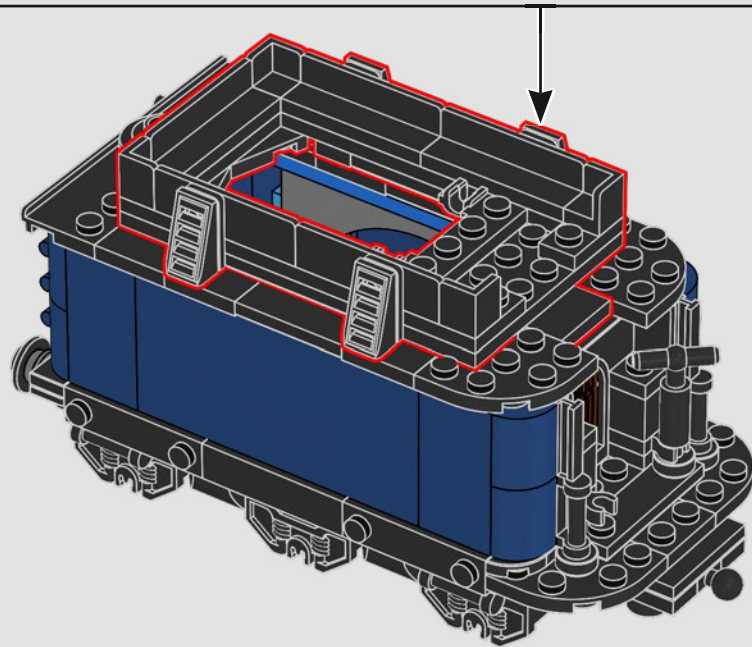
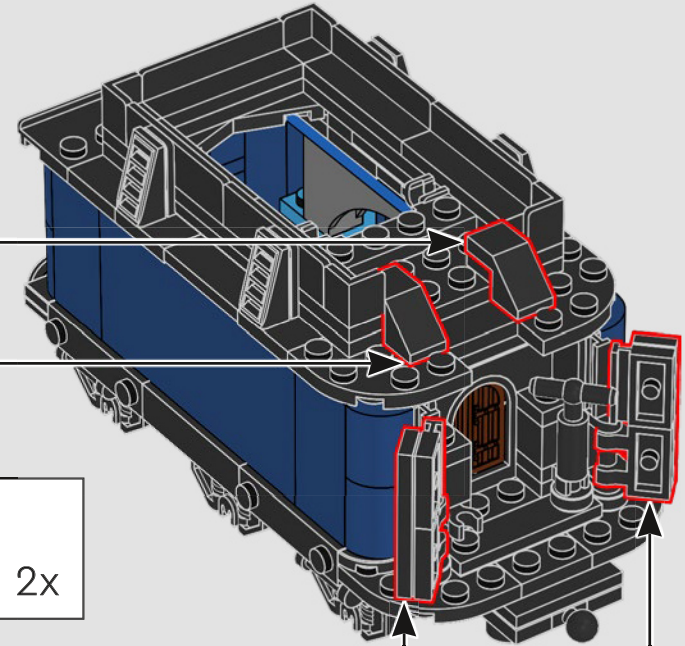



345

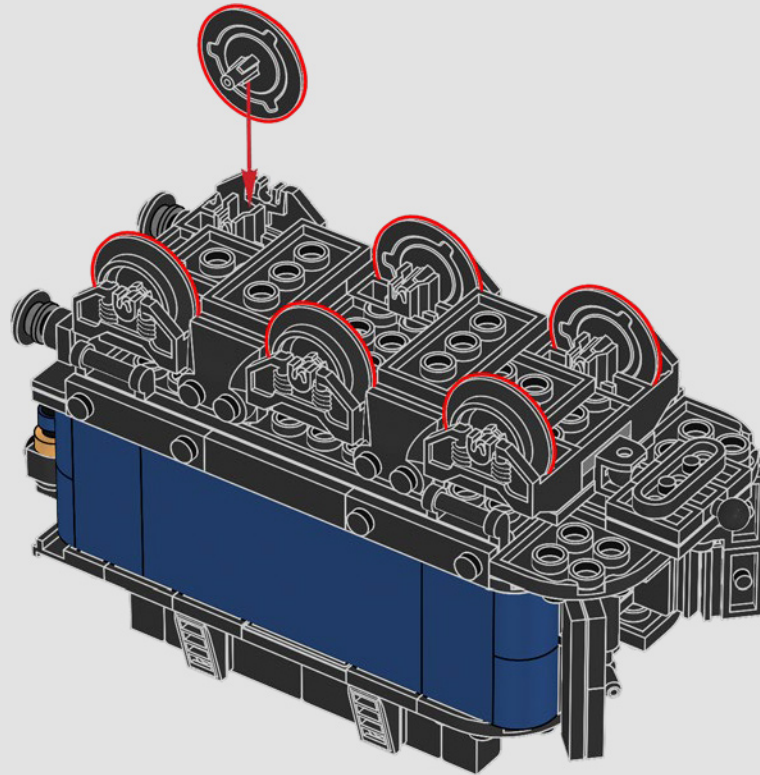

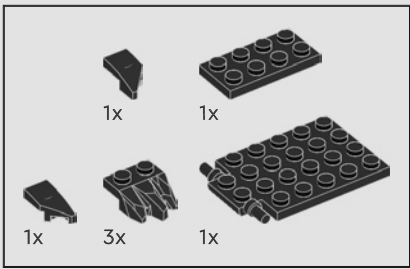

346

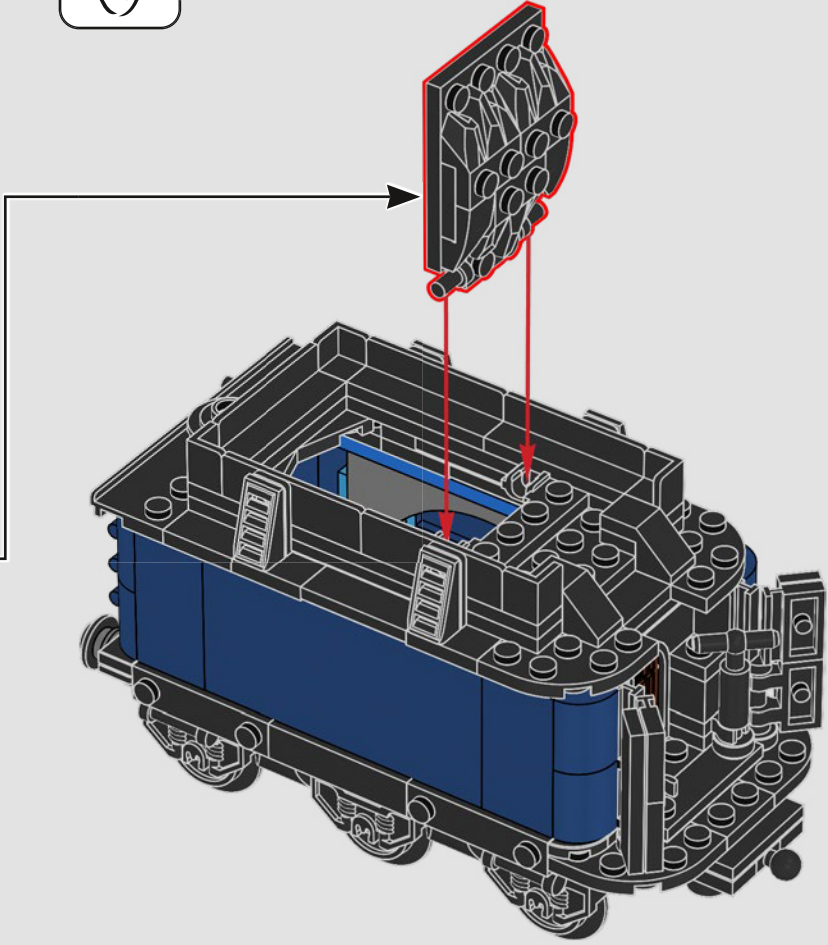
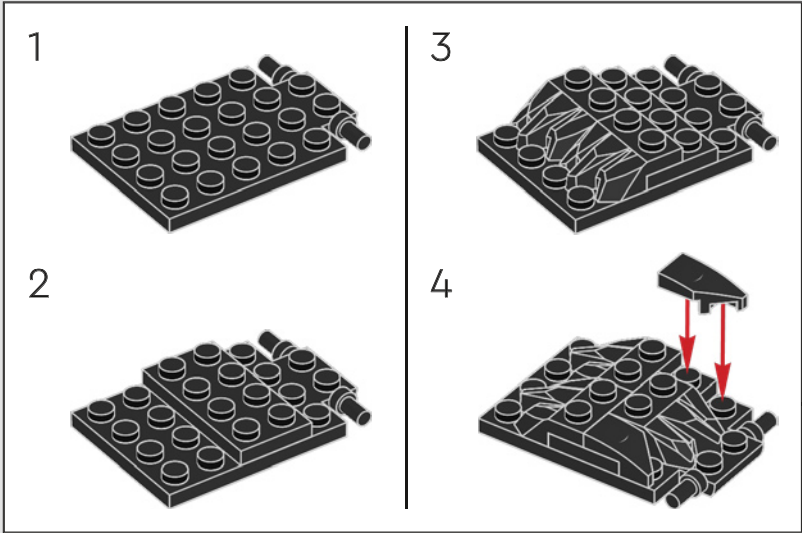

347



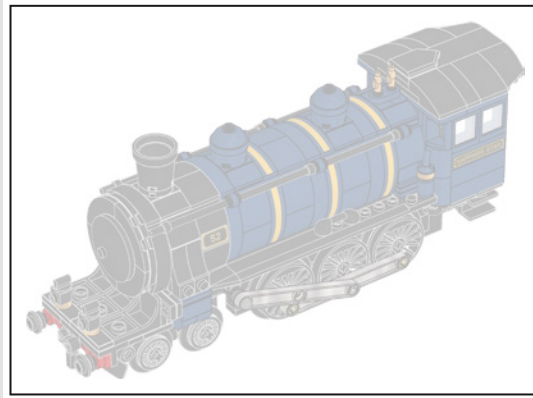
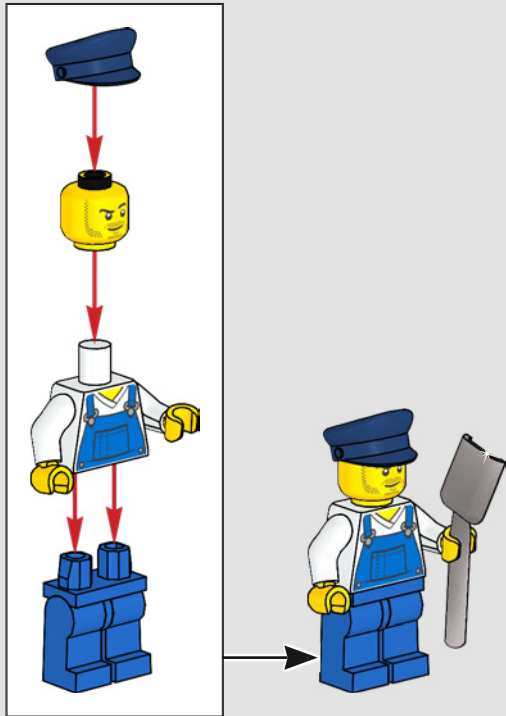

348

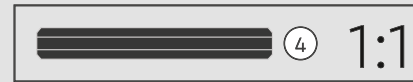
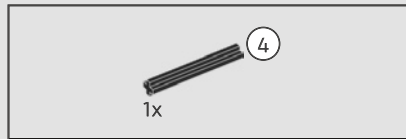

349

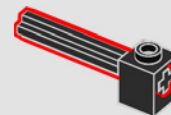

..... ●
"El maquinista aviva el fuego y mantiene la locomotora en las mejores condiciones durante todo el viaje".



350

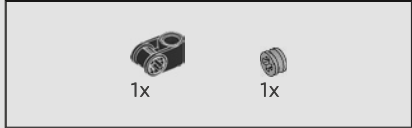
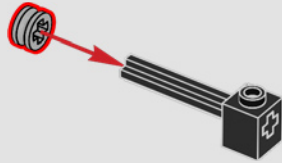

351

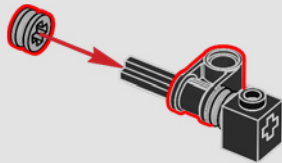

352

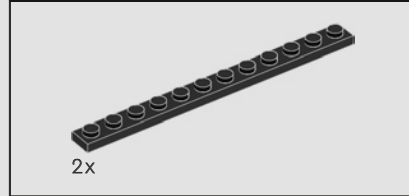
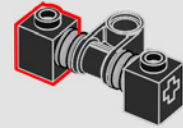

353

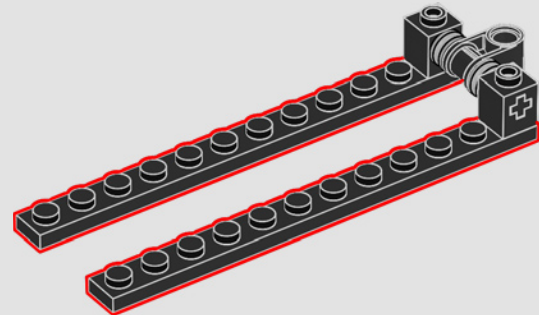

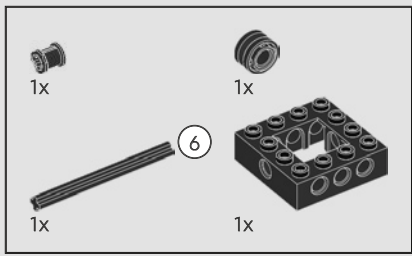

354

1

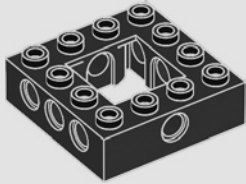

2

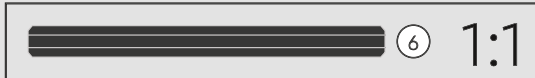
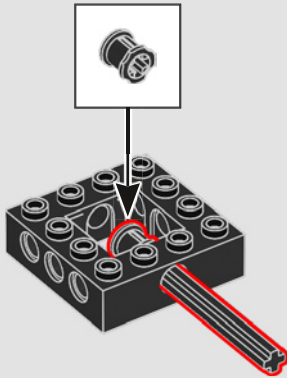

3

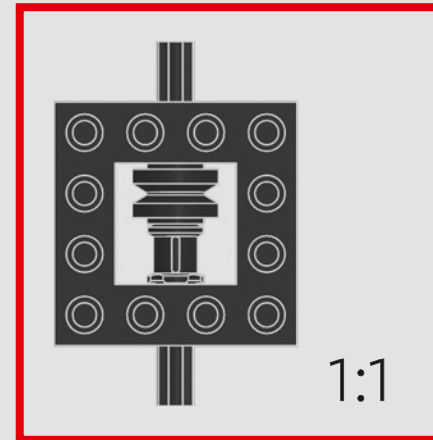
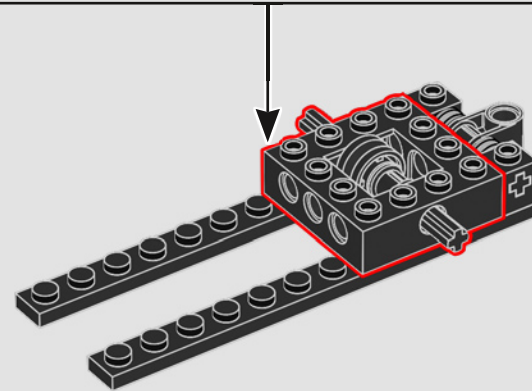
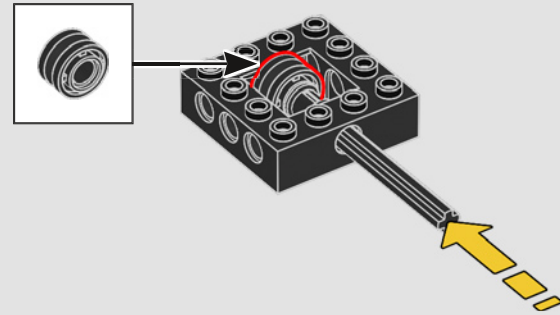

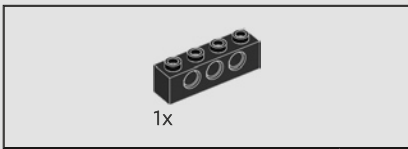

355

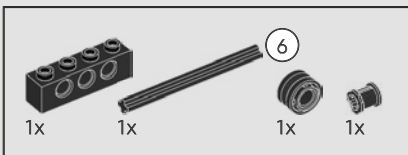
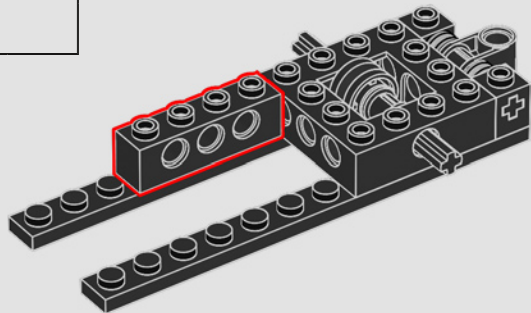

356

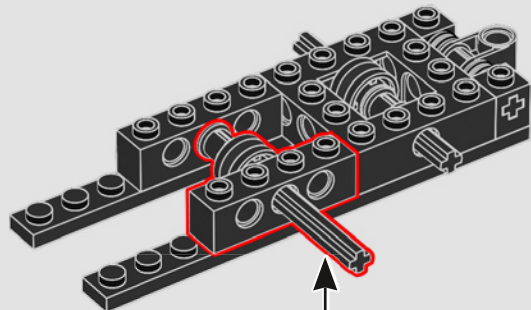
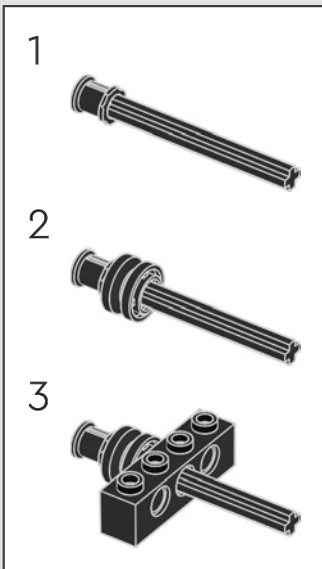

357

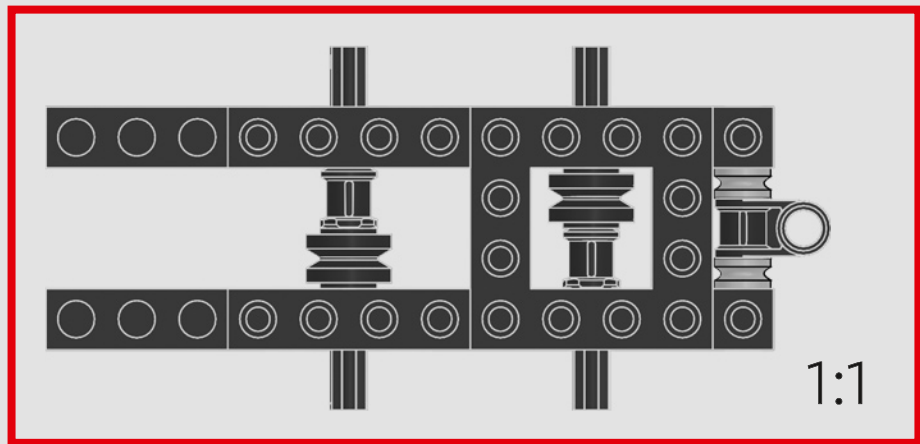
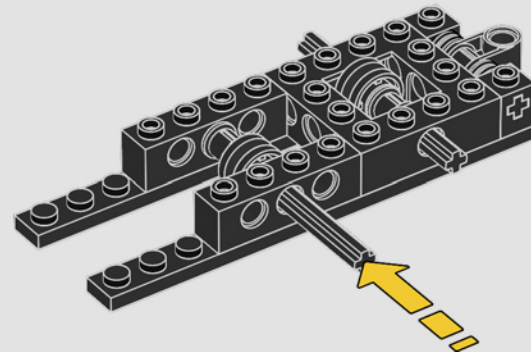

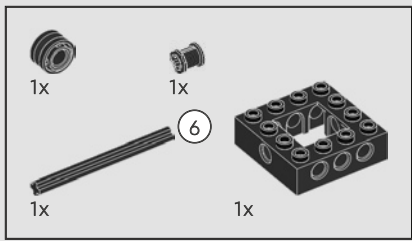

358

1

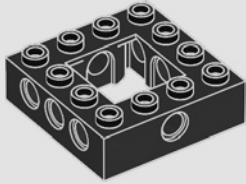

2

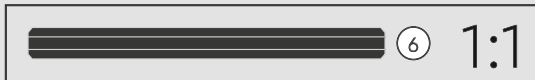
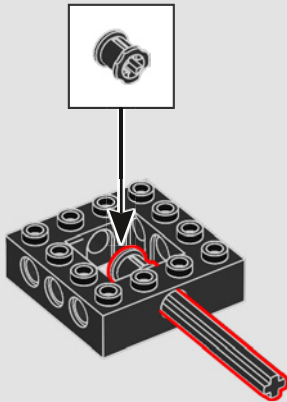

3

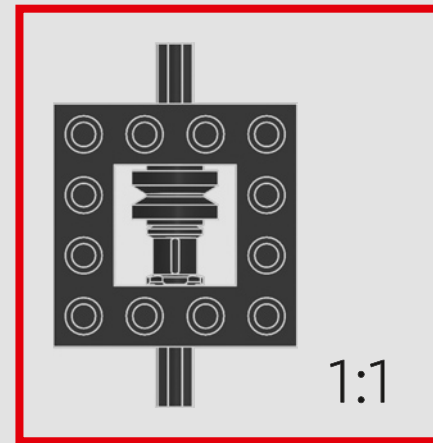
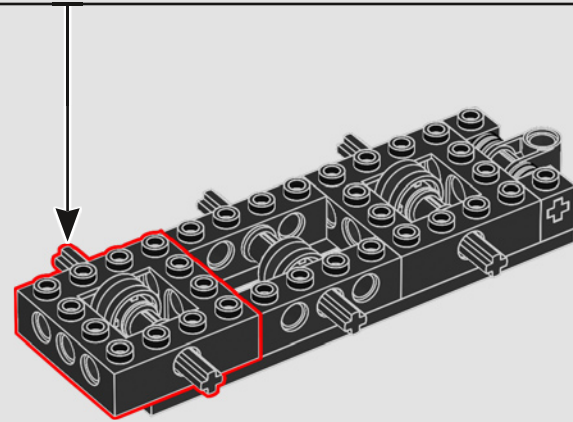
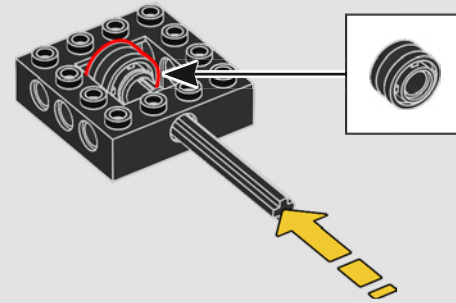

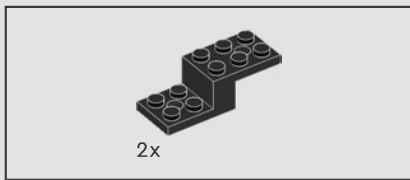

359

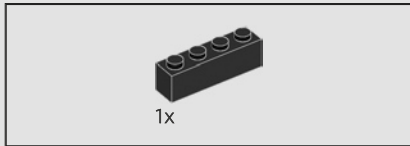
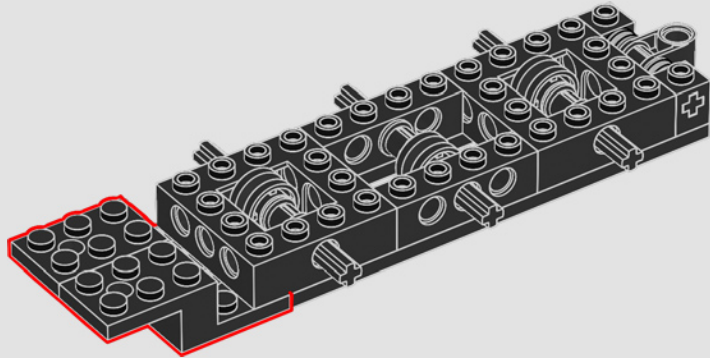

360

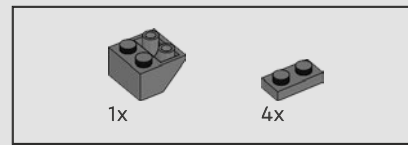
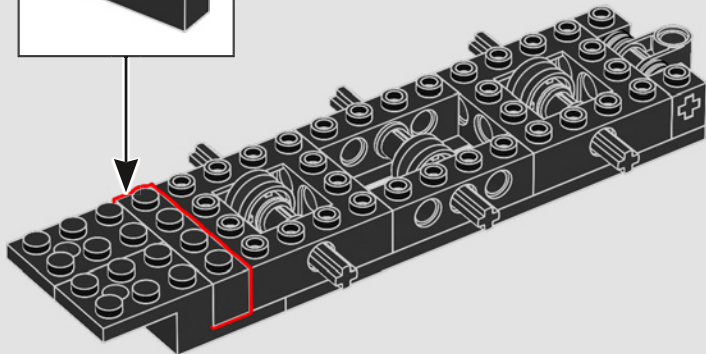
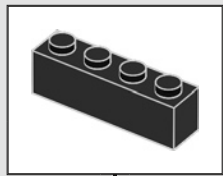

361

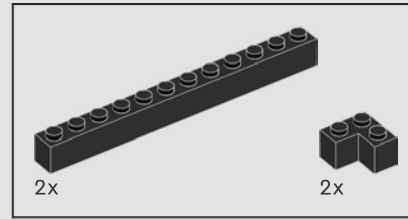
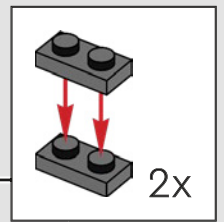
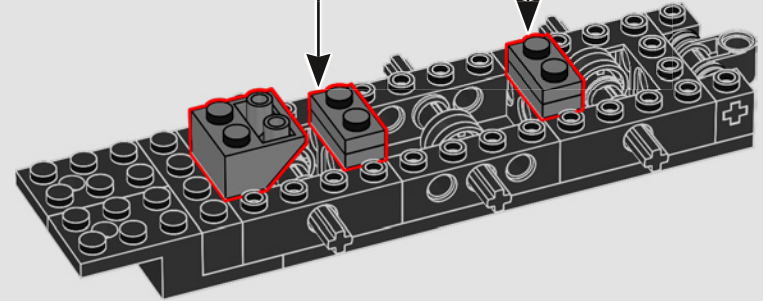

362

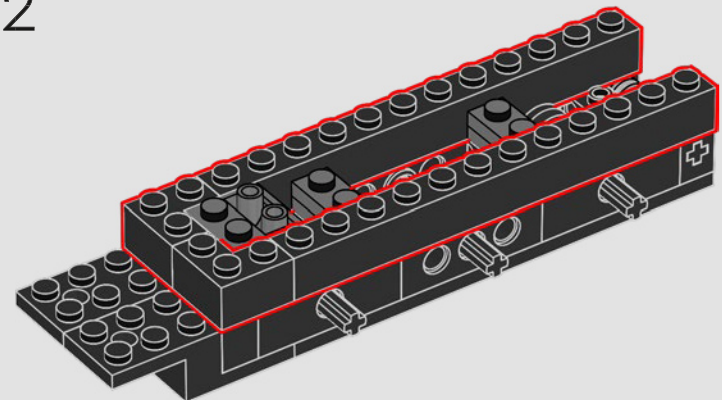

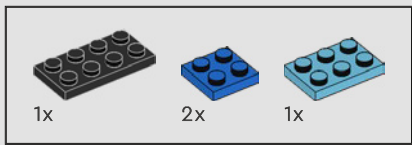

363

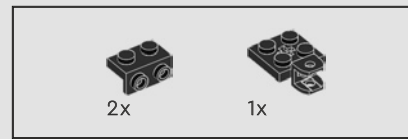
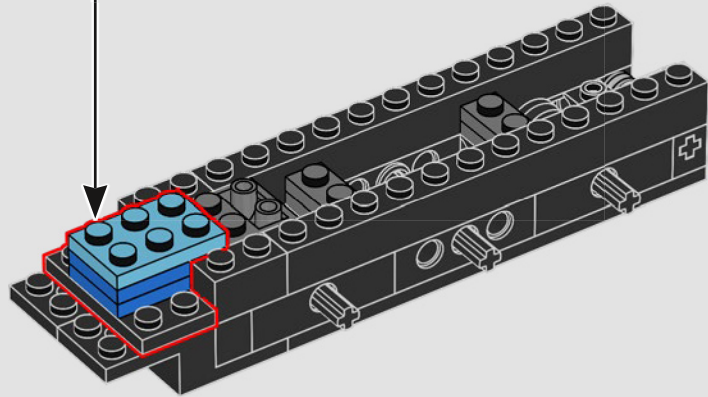
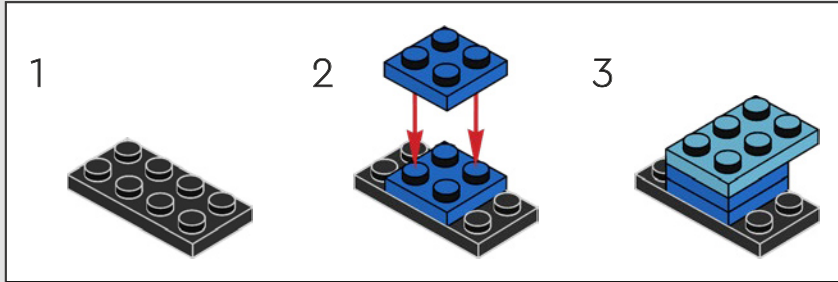

364

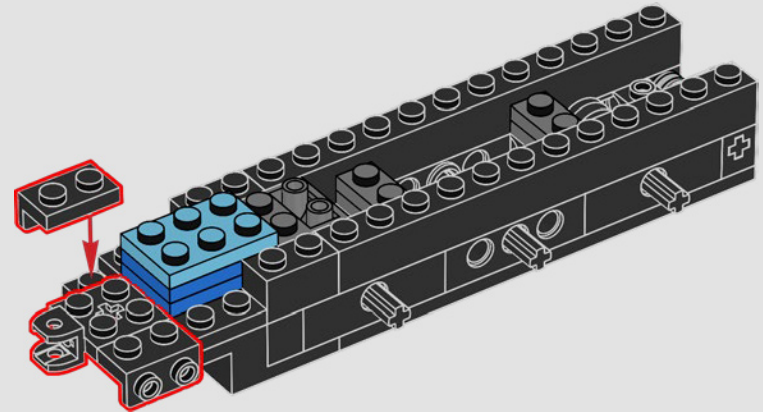

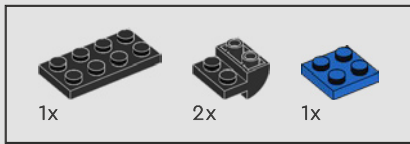

365

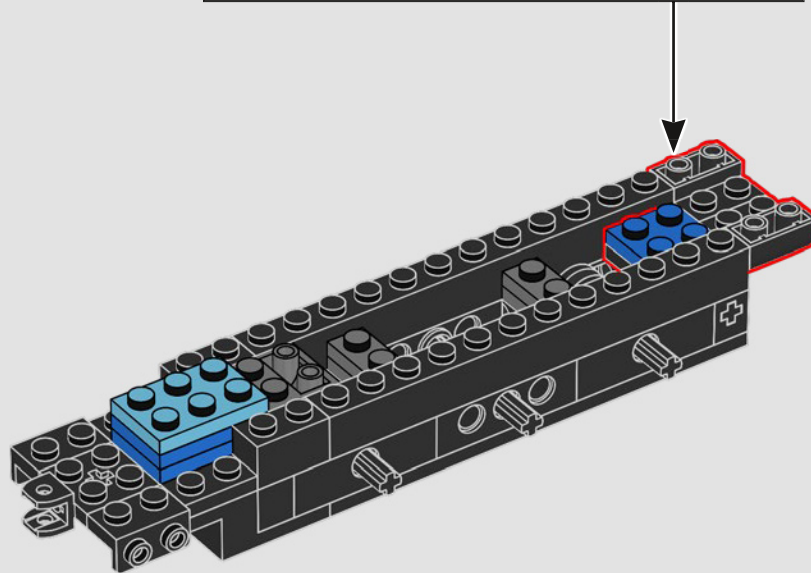
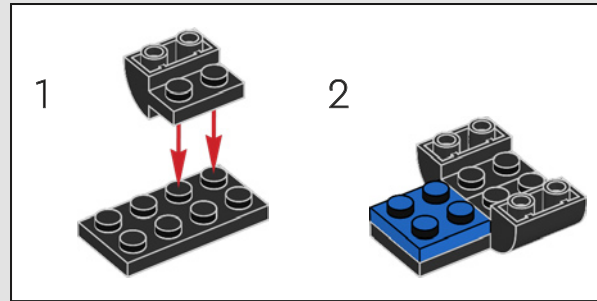

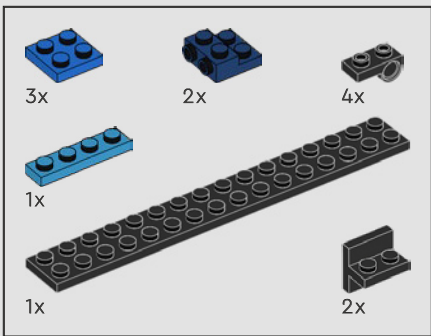

366

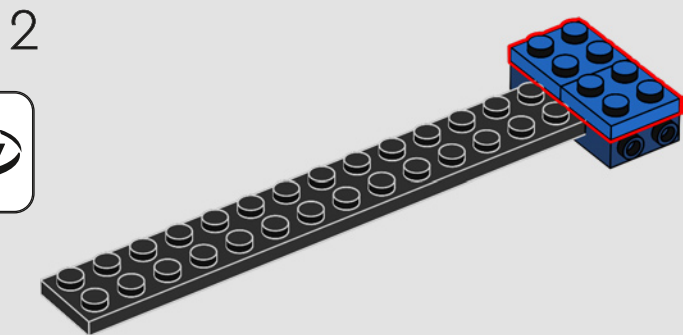
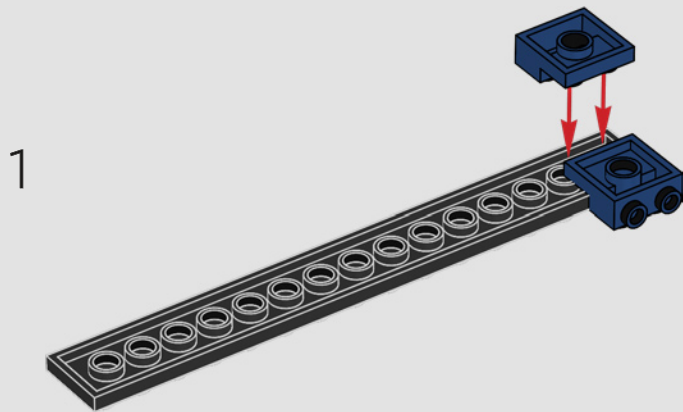

3

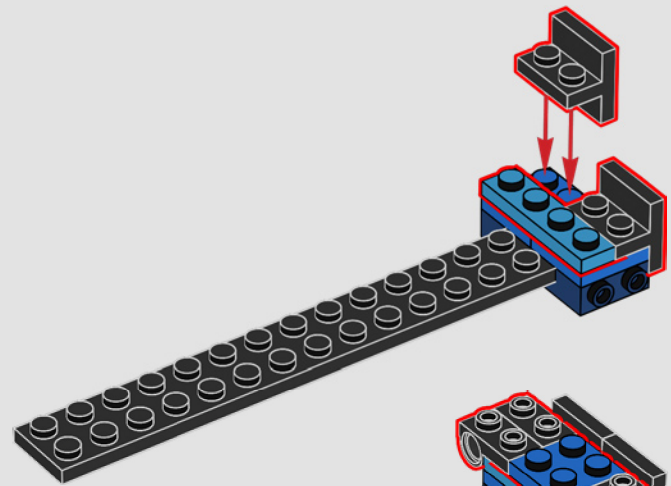

4

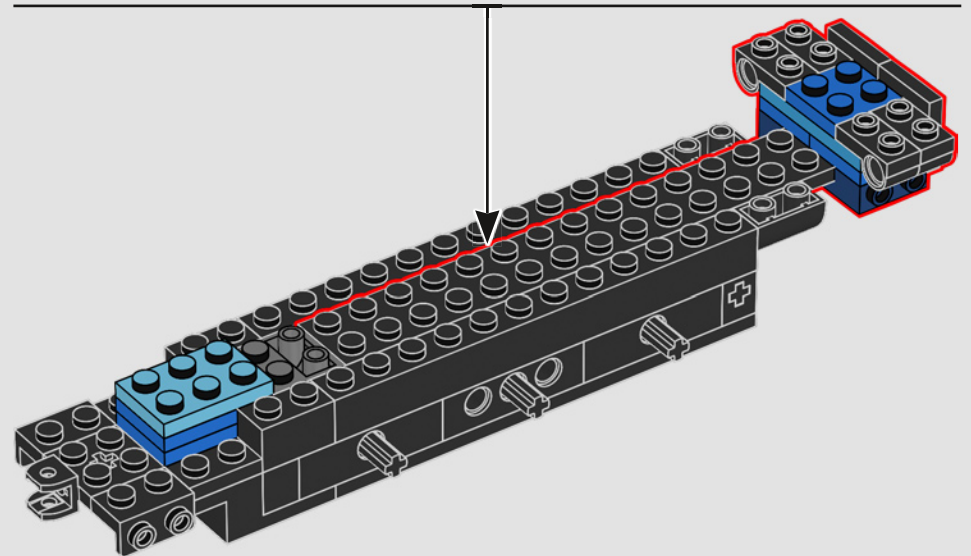
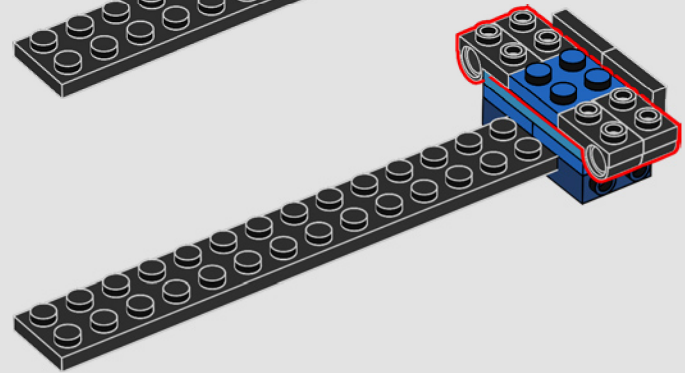

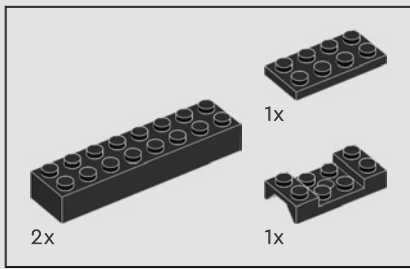

367

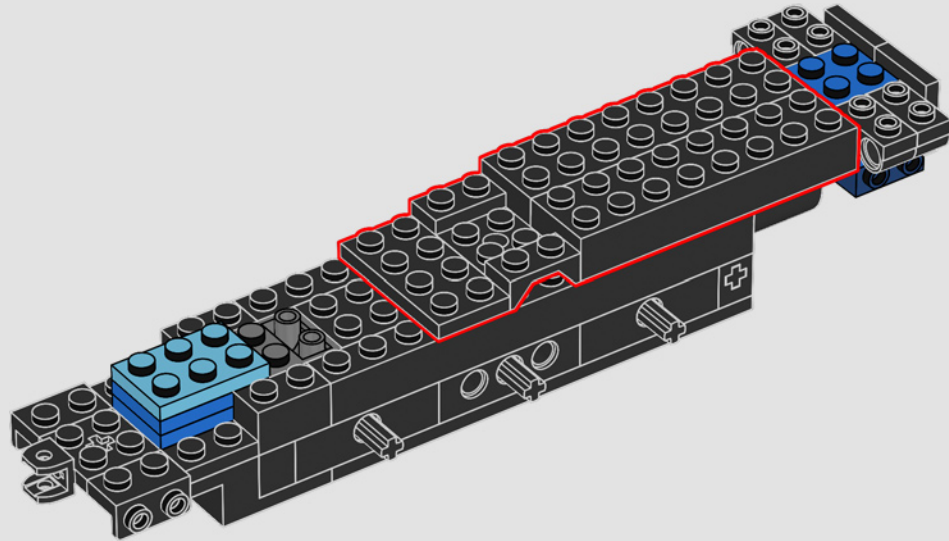

368

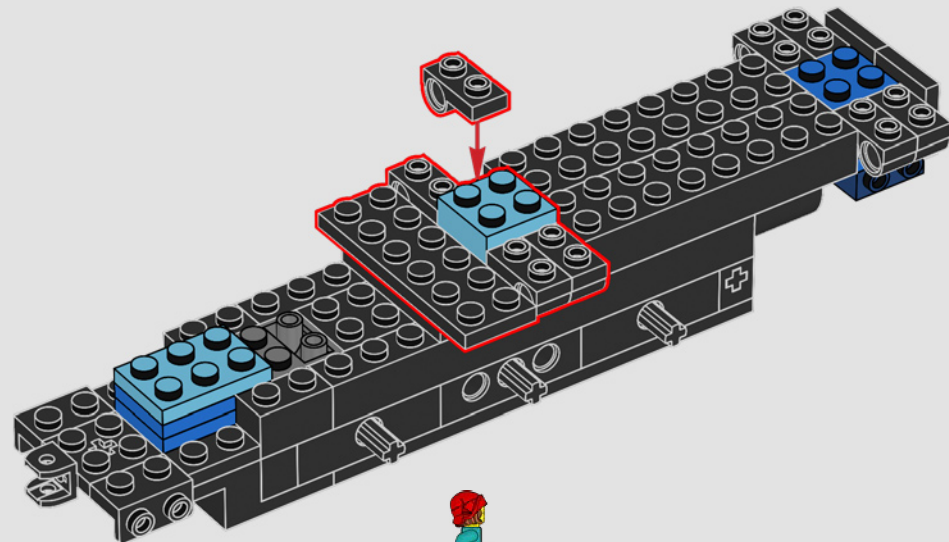

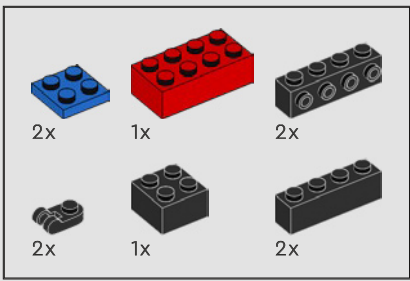

369

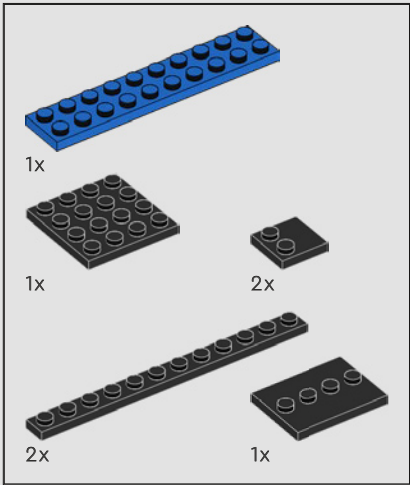
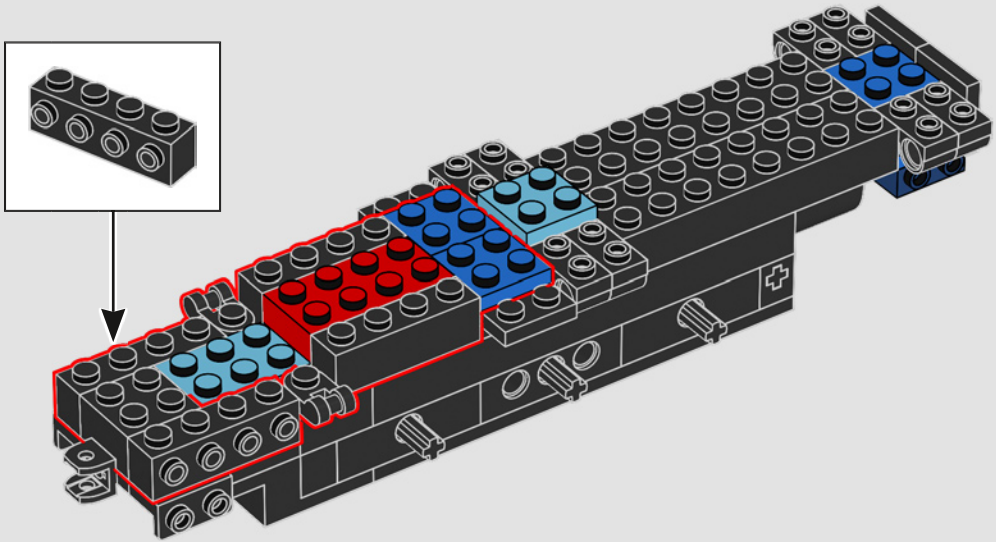

370

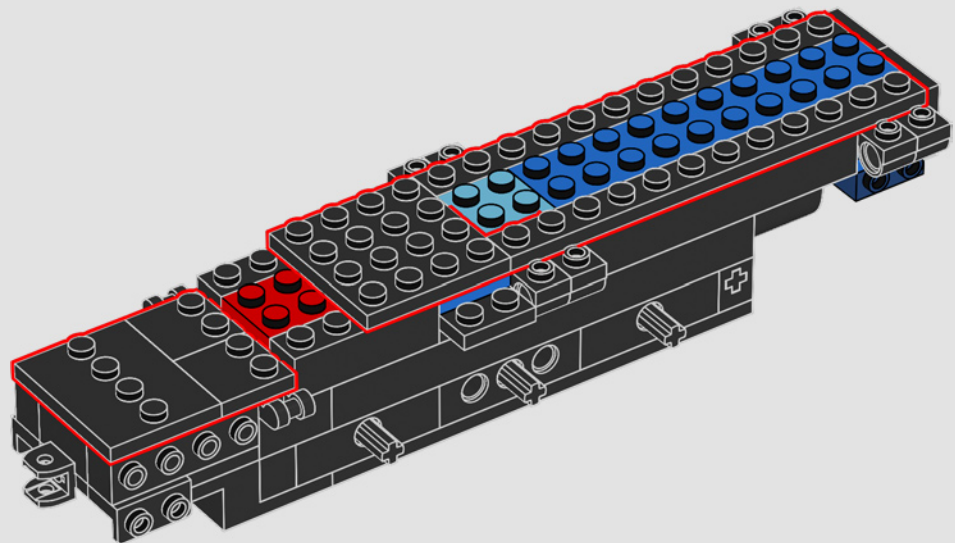



371

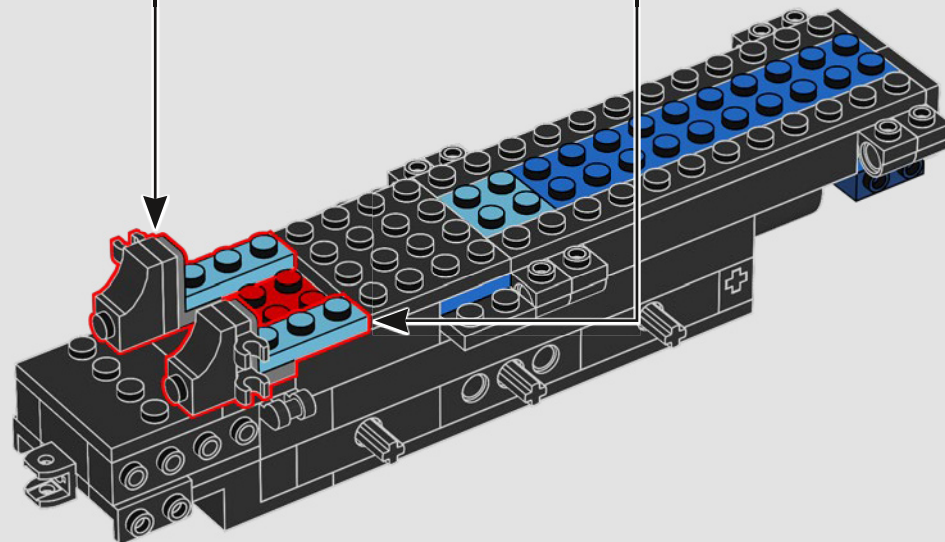
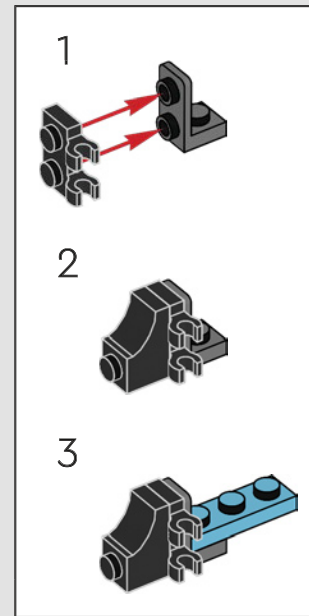
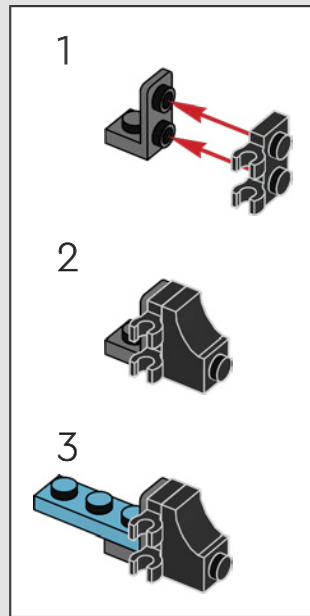

Próxima parada: SOFÍA
"Avanzamos hacia nuestra próxima
parada atravesando la cordillera
de los Balcanes a toda máquina".

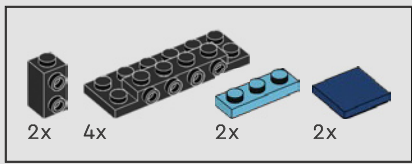

372

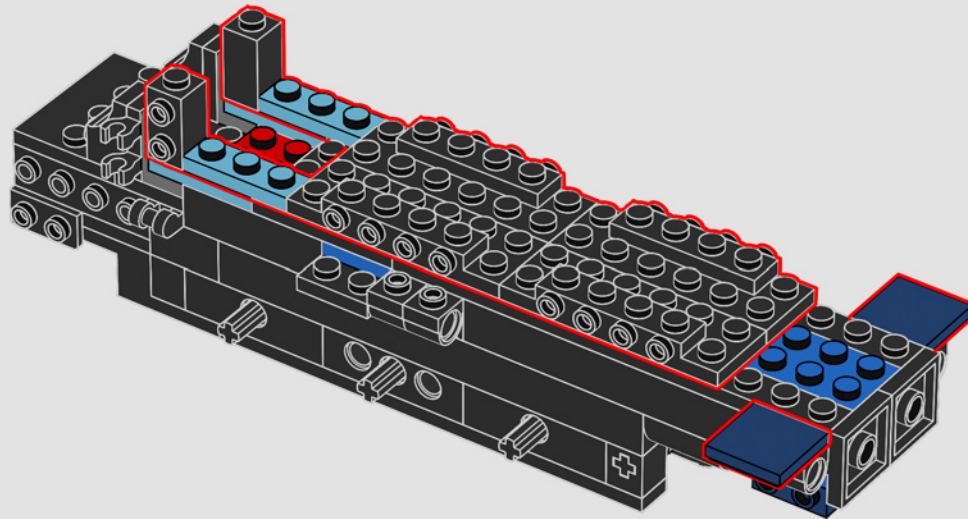

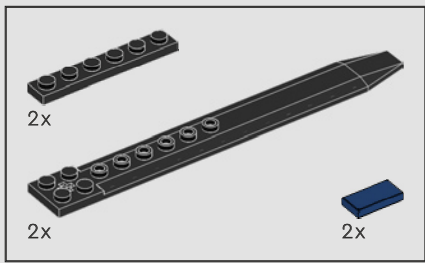

373

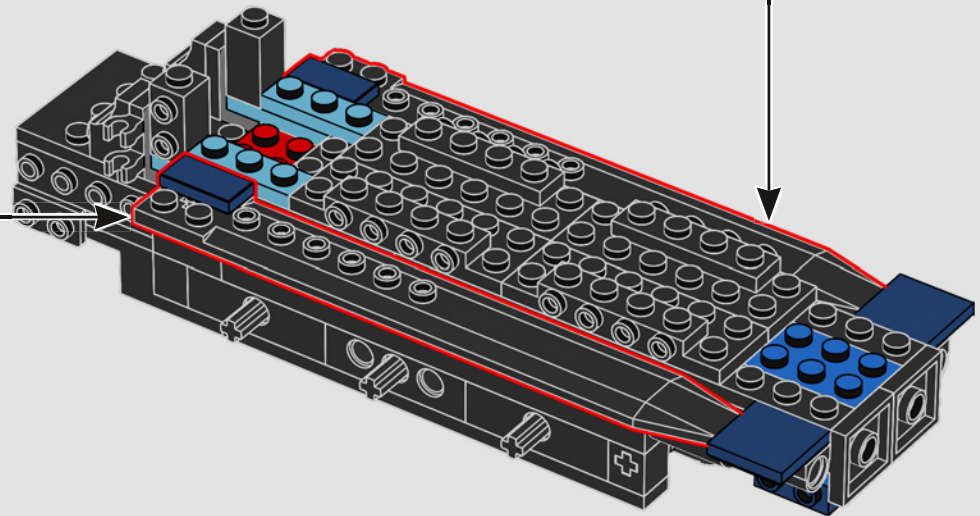
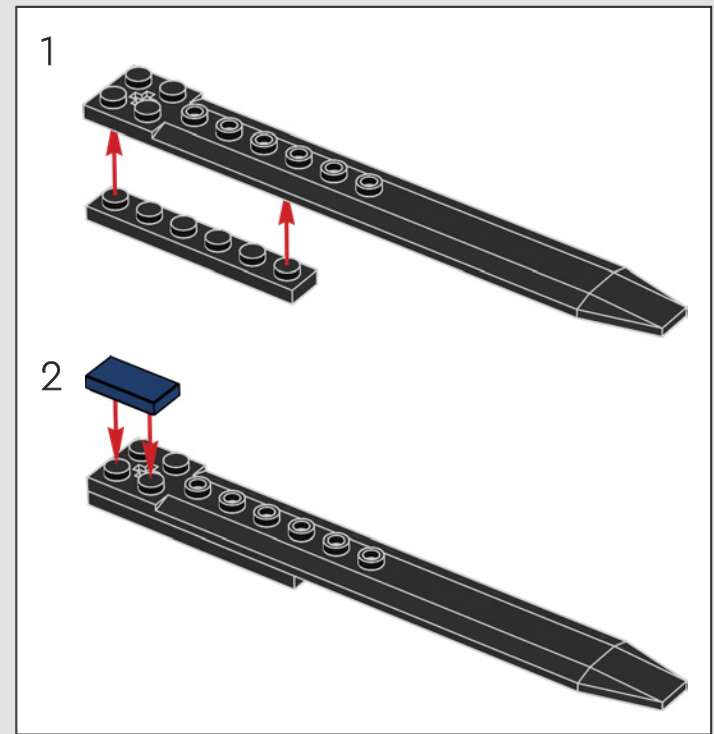
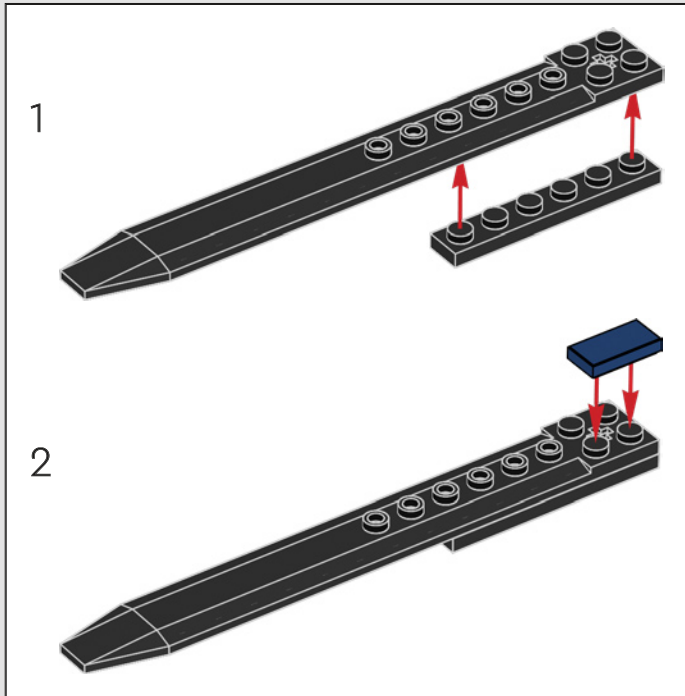

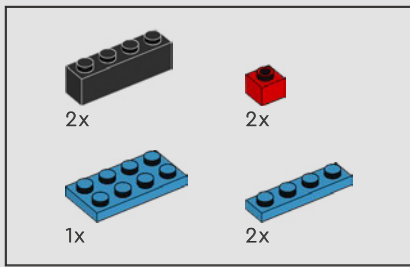

374

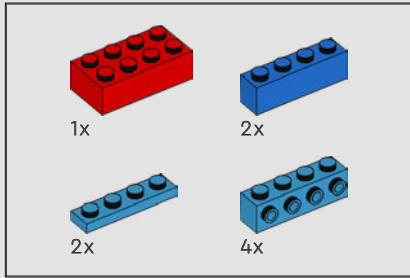
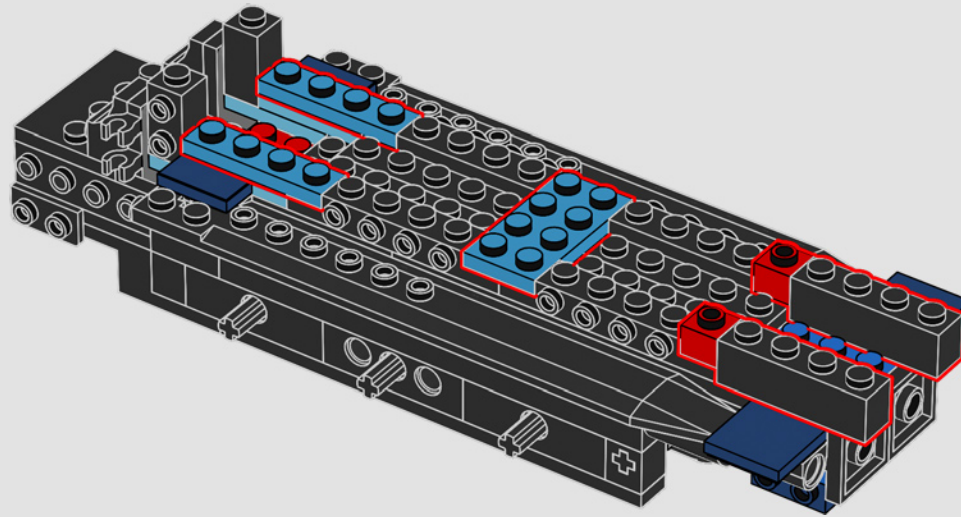

375

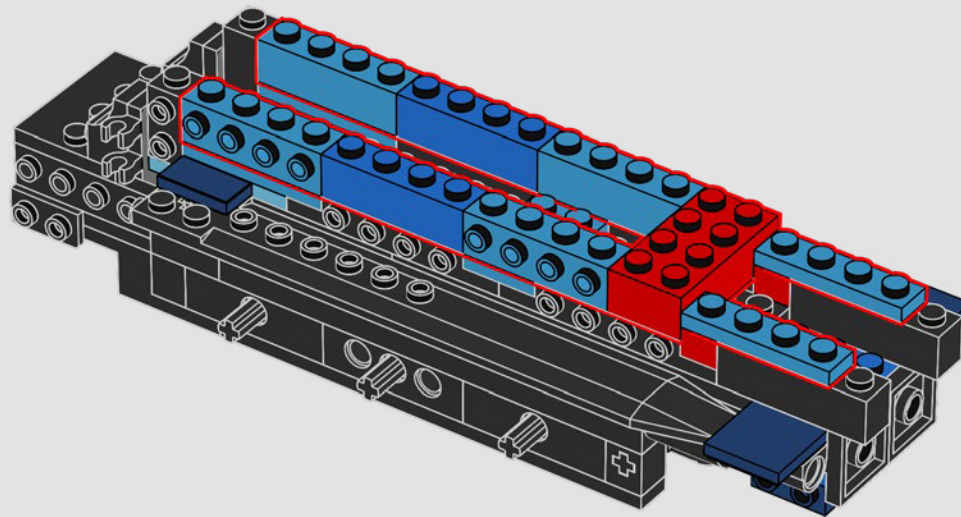

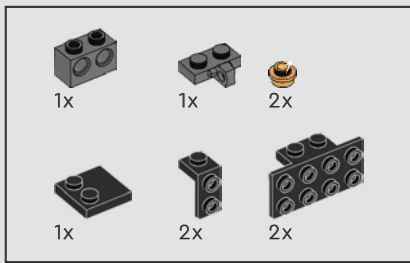

376

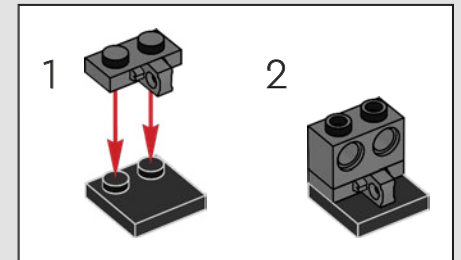
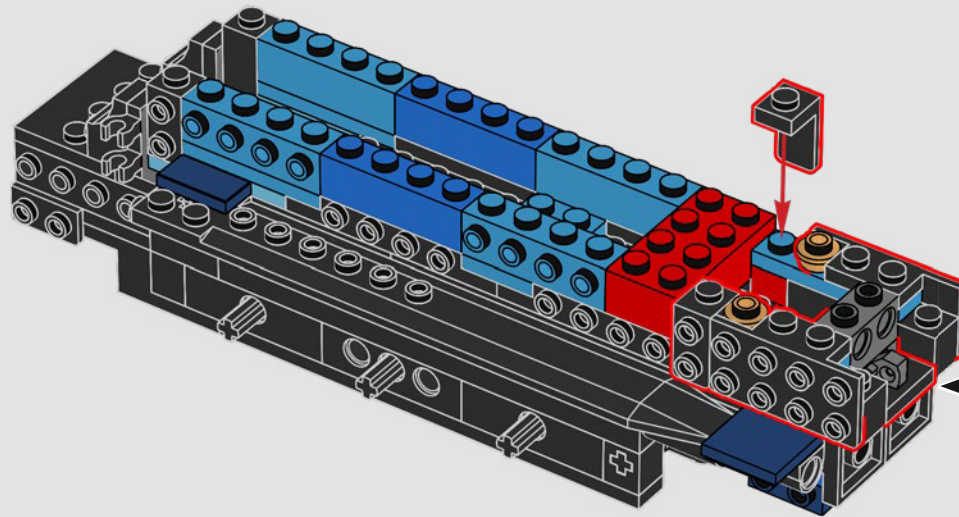

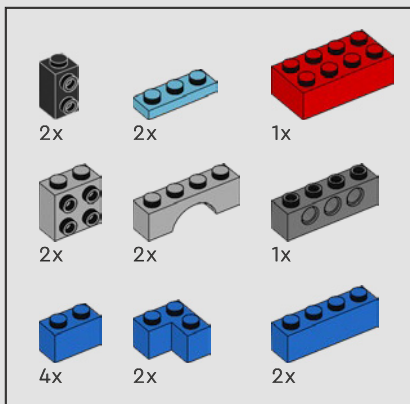

377

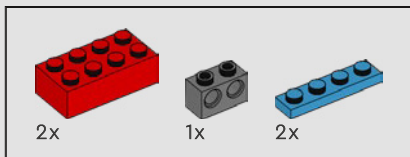
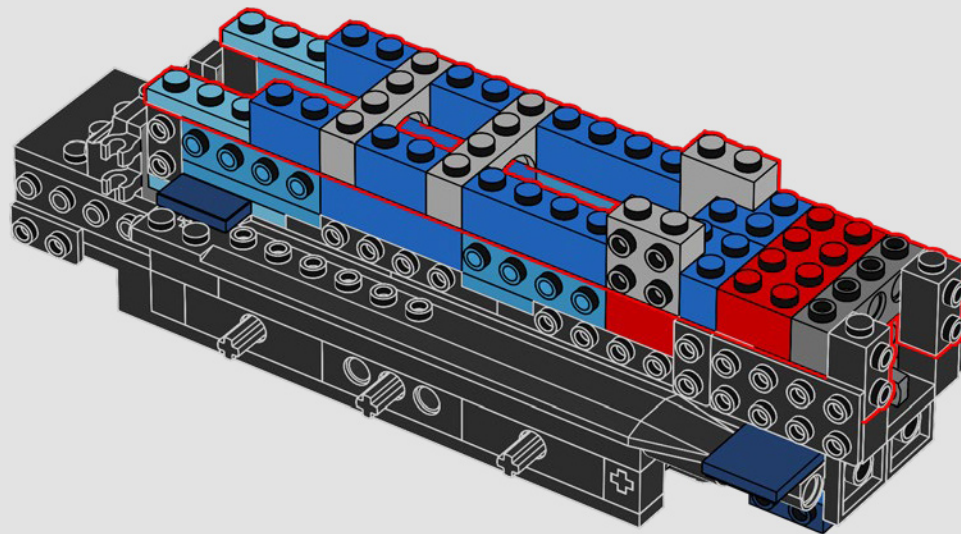

378

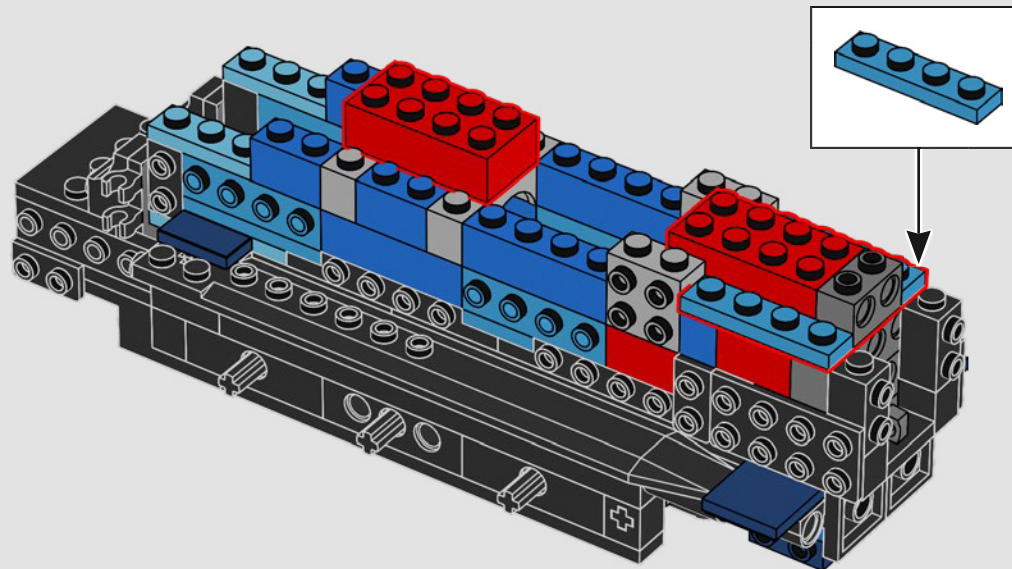

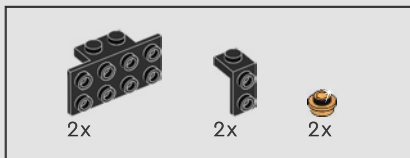

379

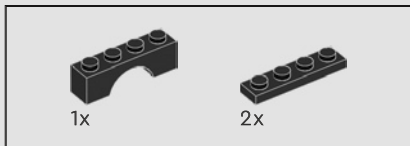
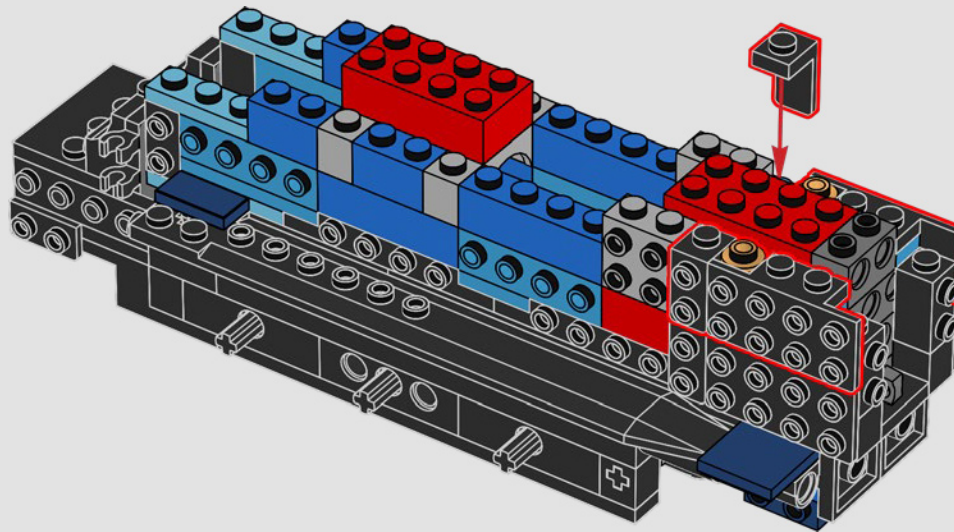

380

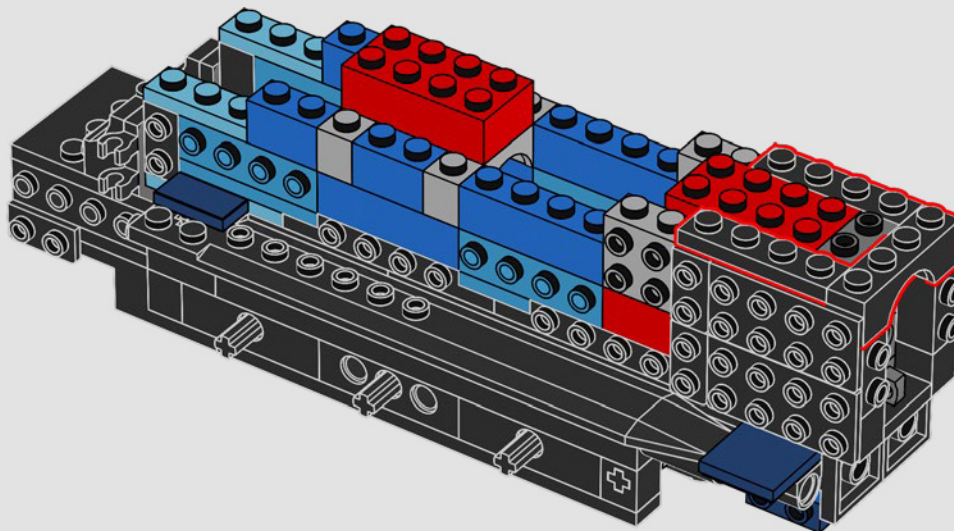

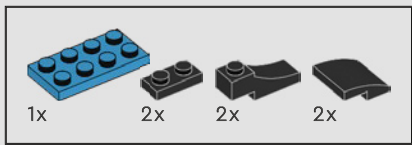

381

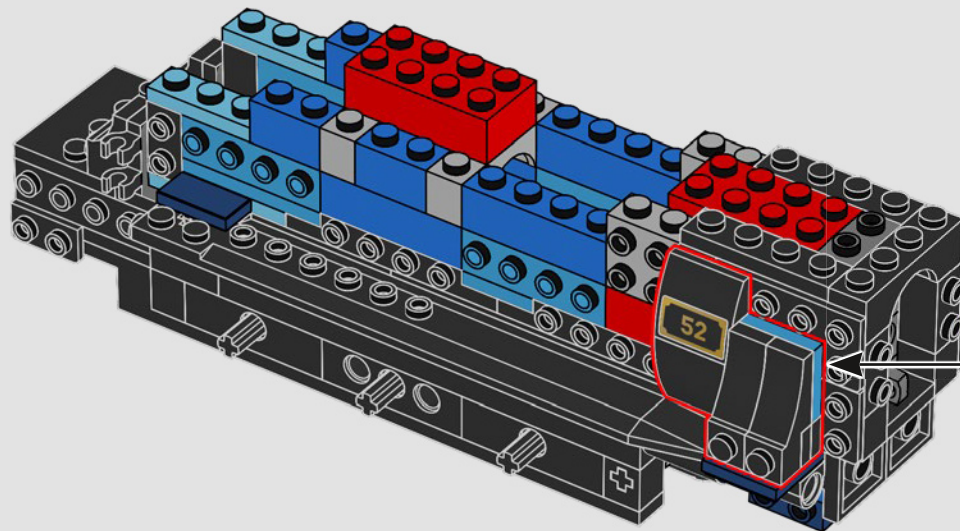
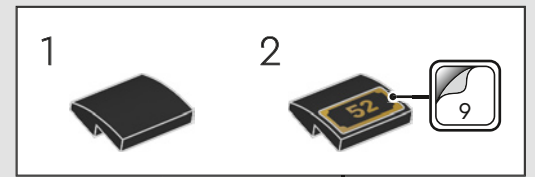
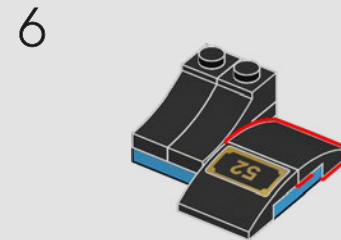
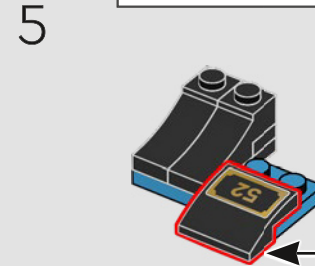
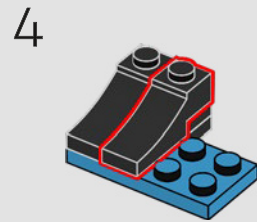
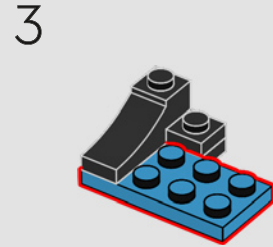
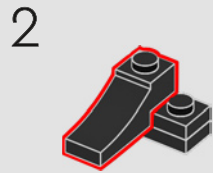
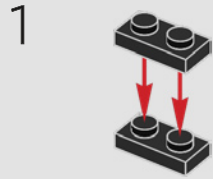

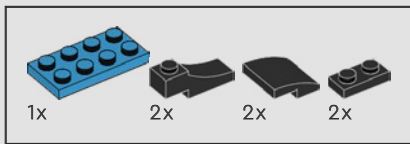

382

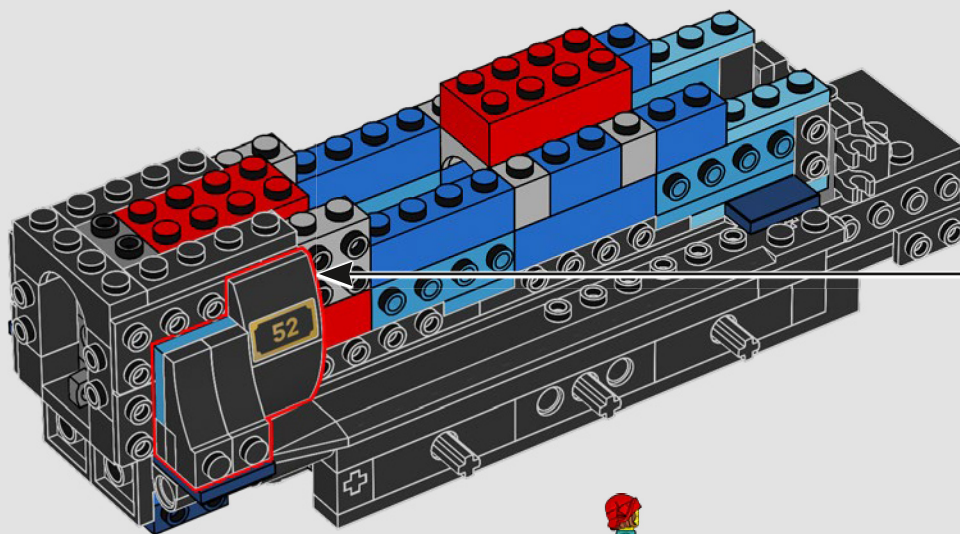
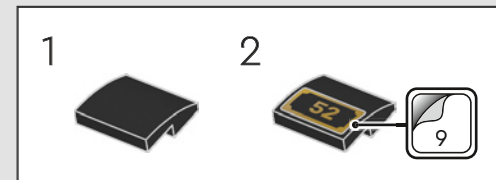
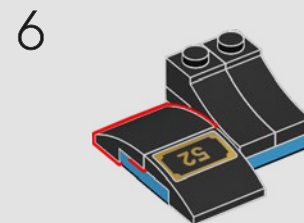
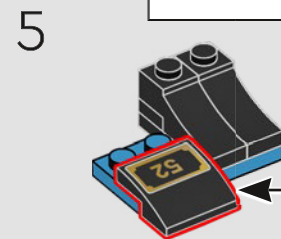
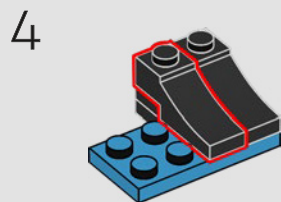
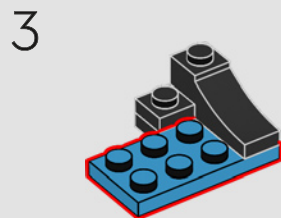
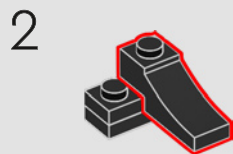
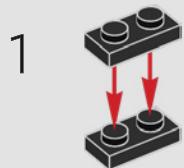

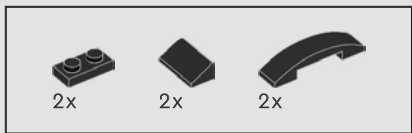

383

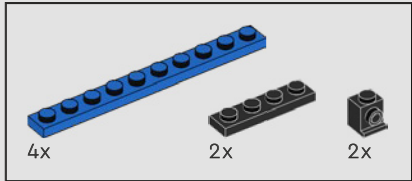
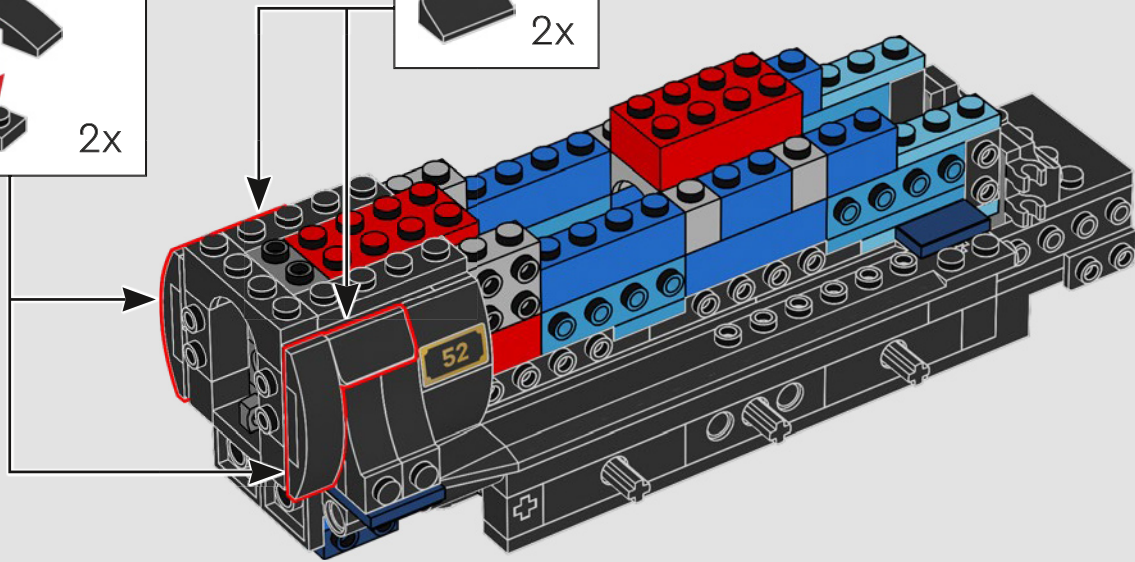
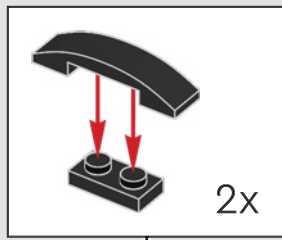

384

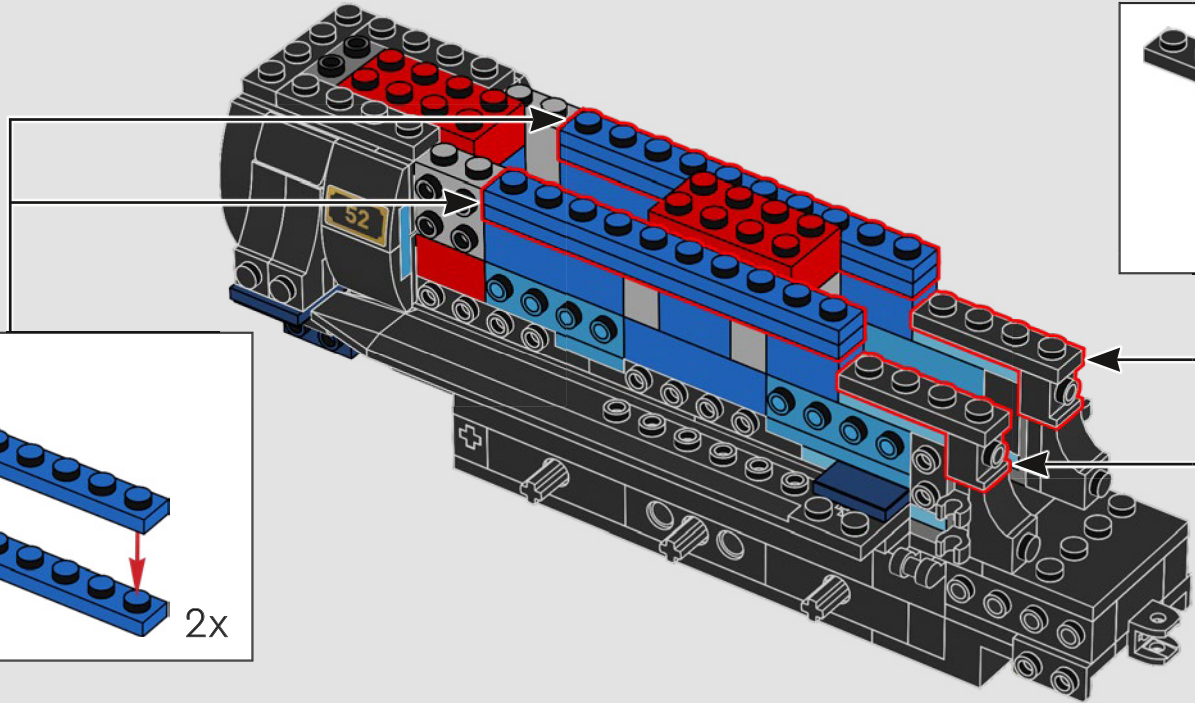
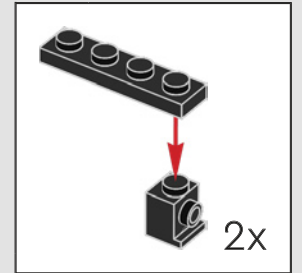
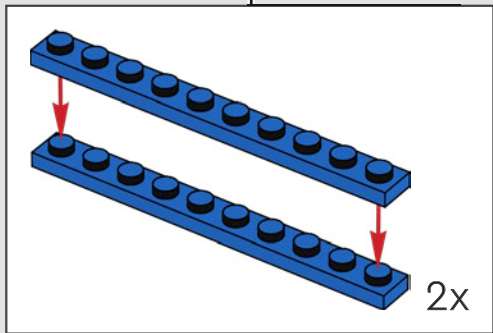

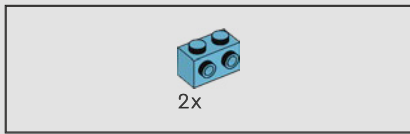

385

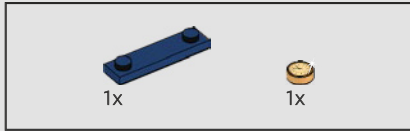
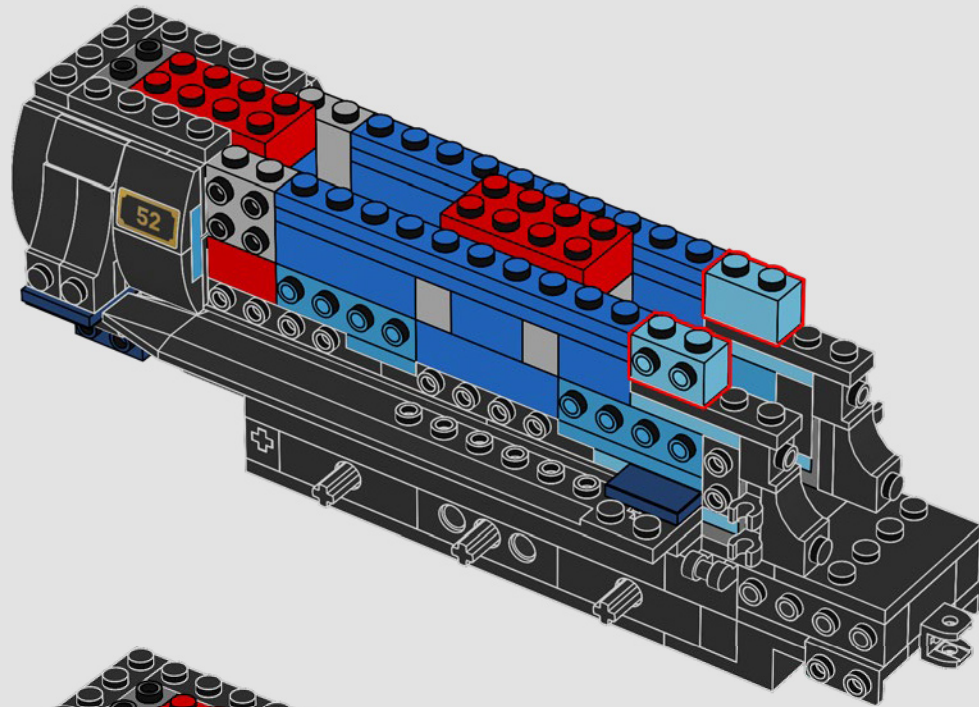

386

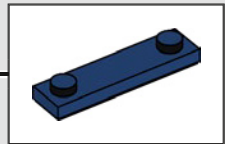
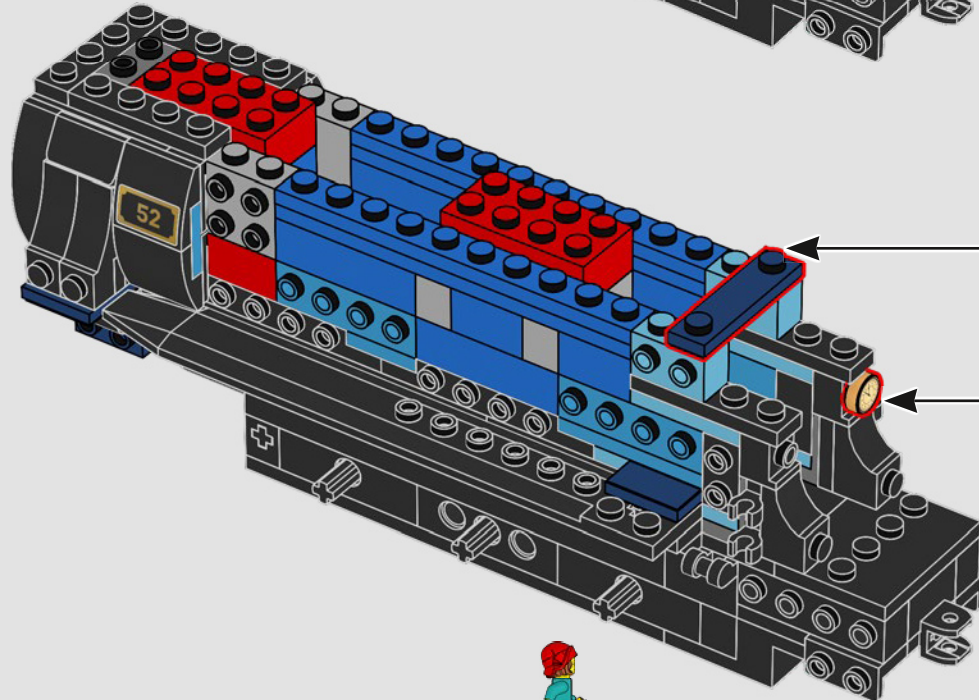

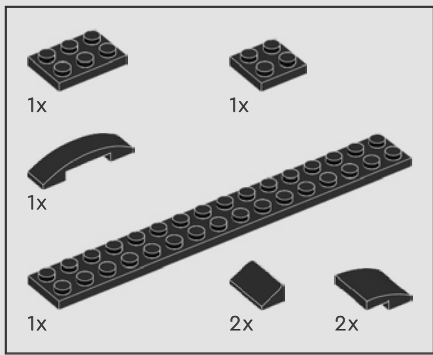

387

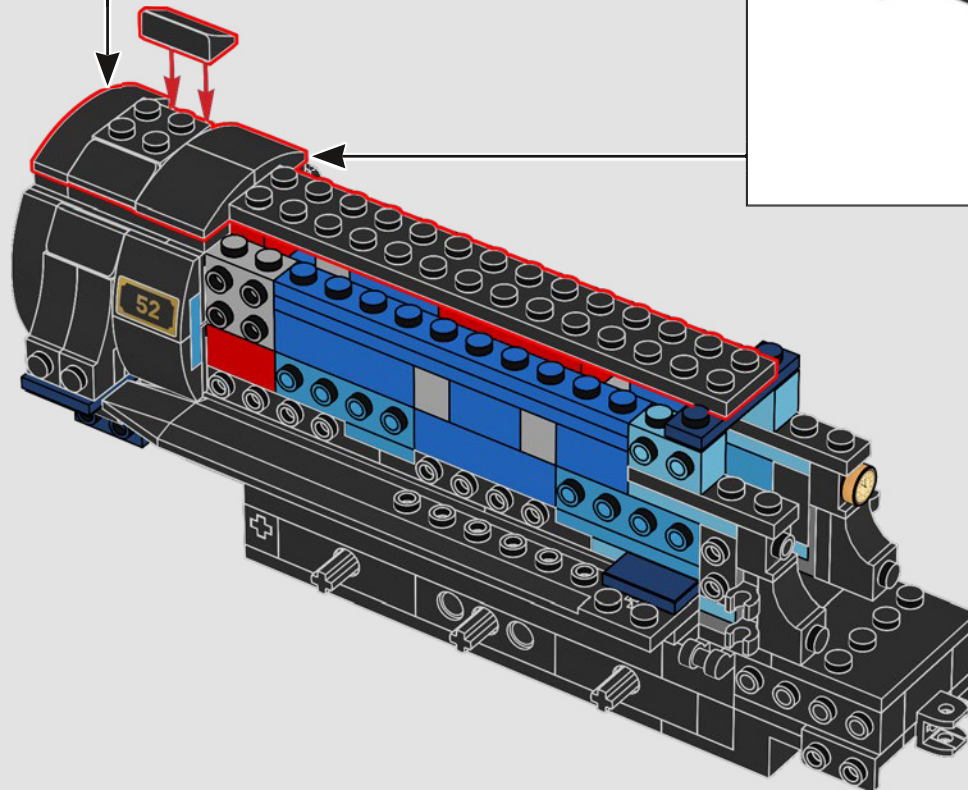
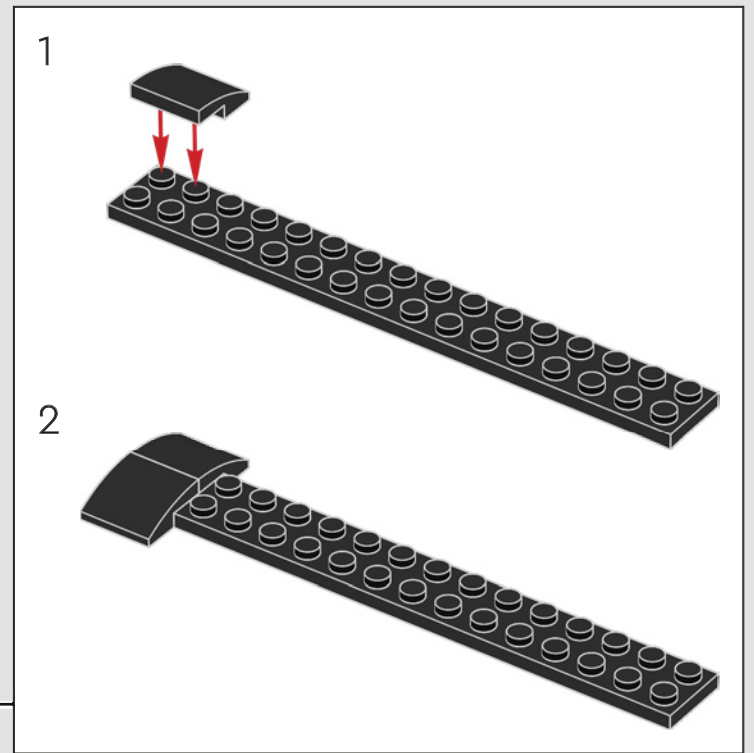
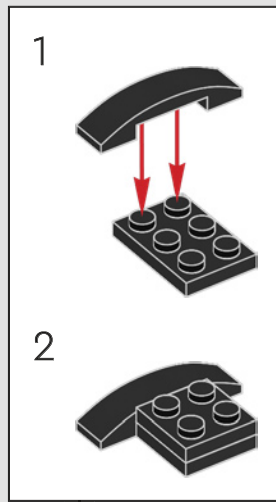

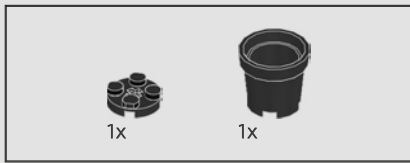

388

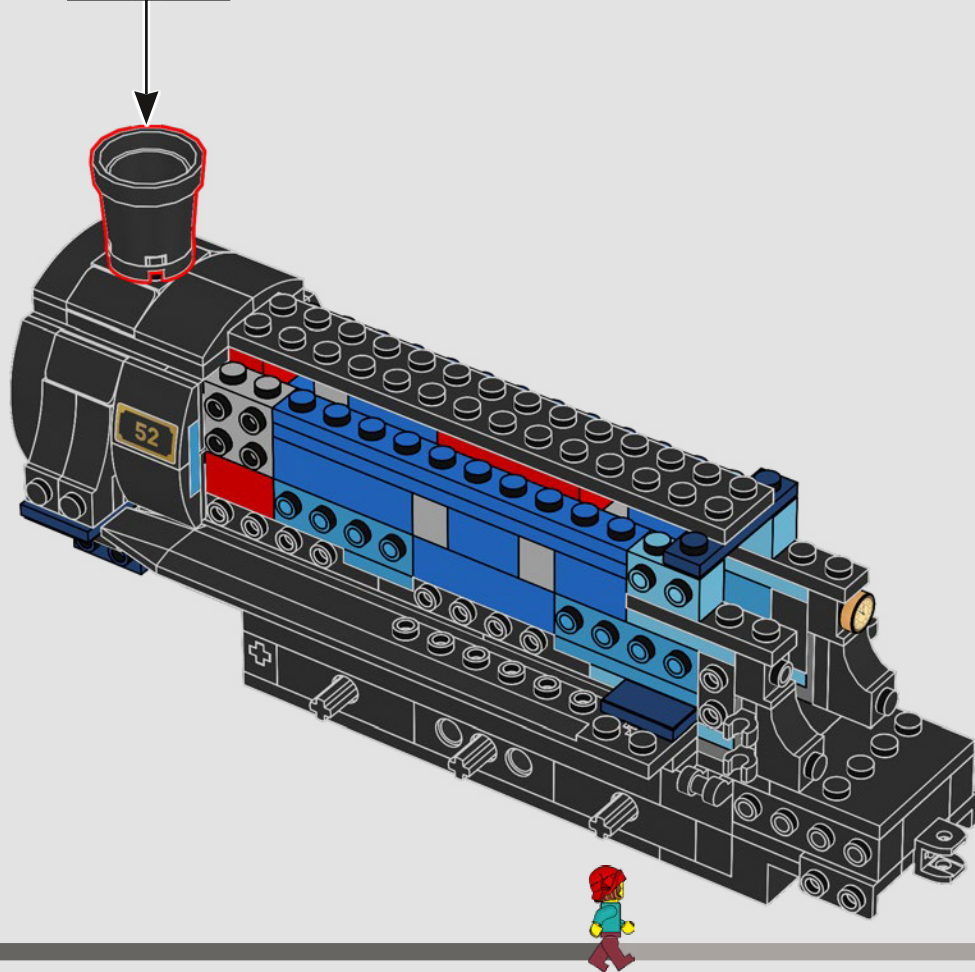
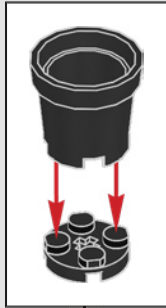

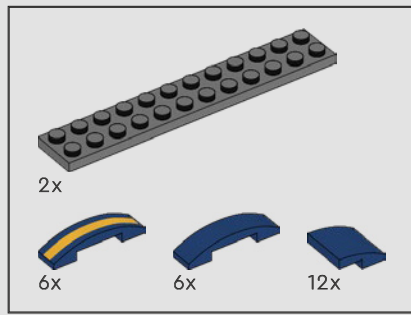

389

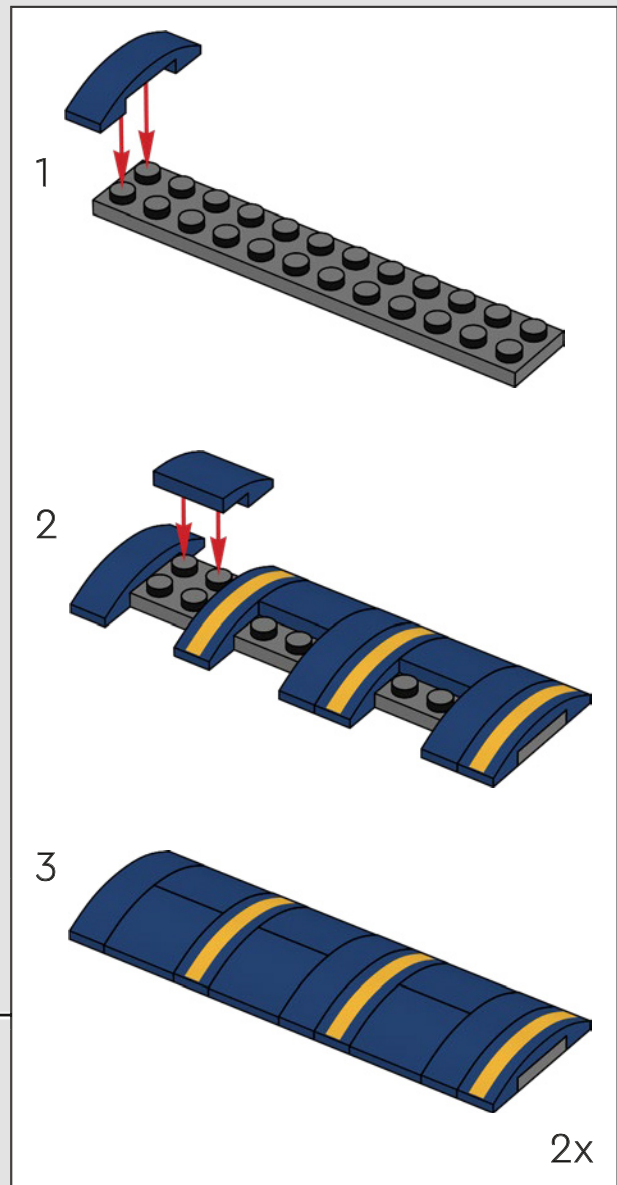
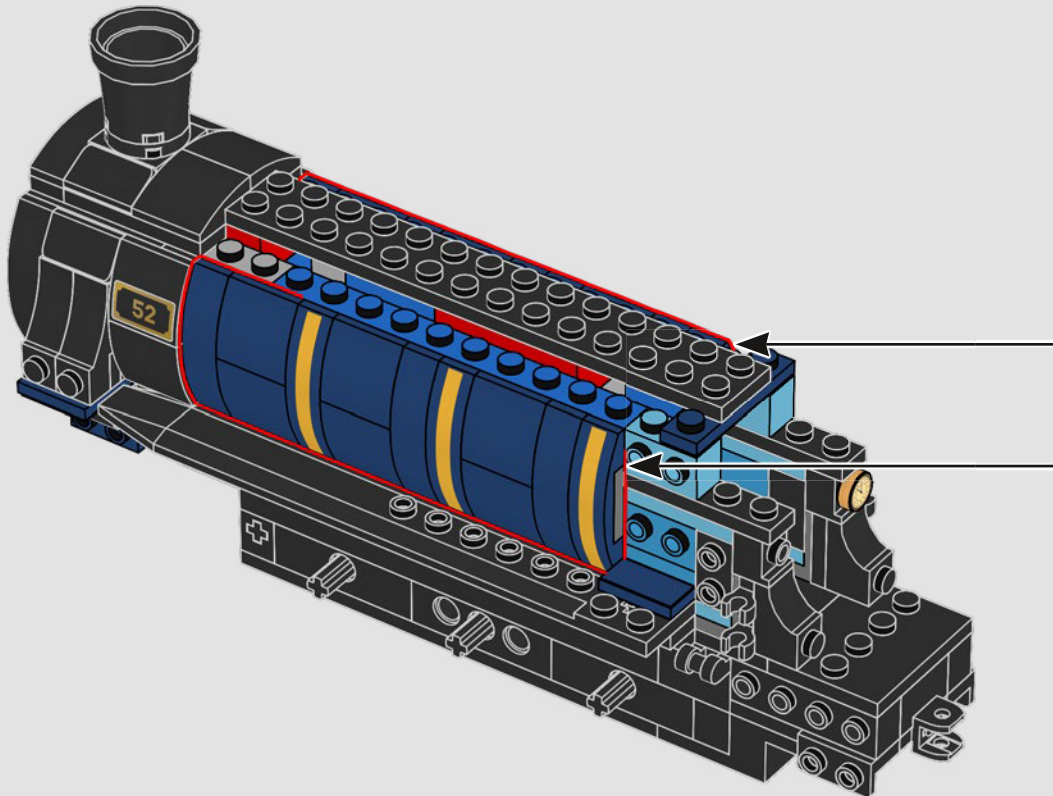

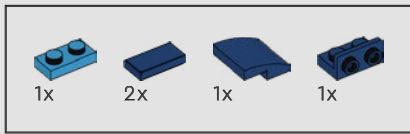

390

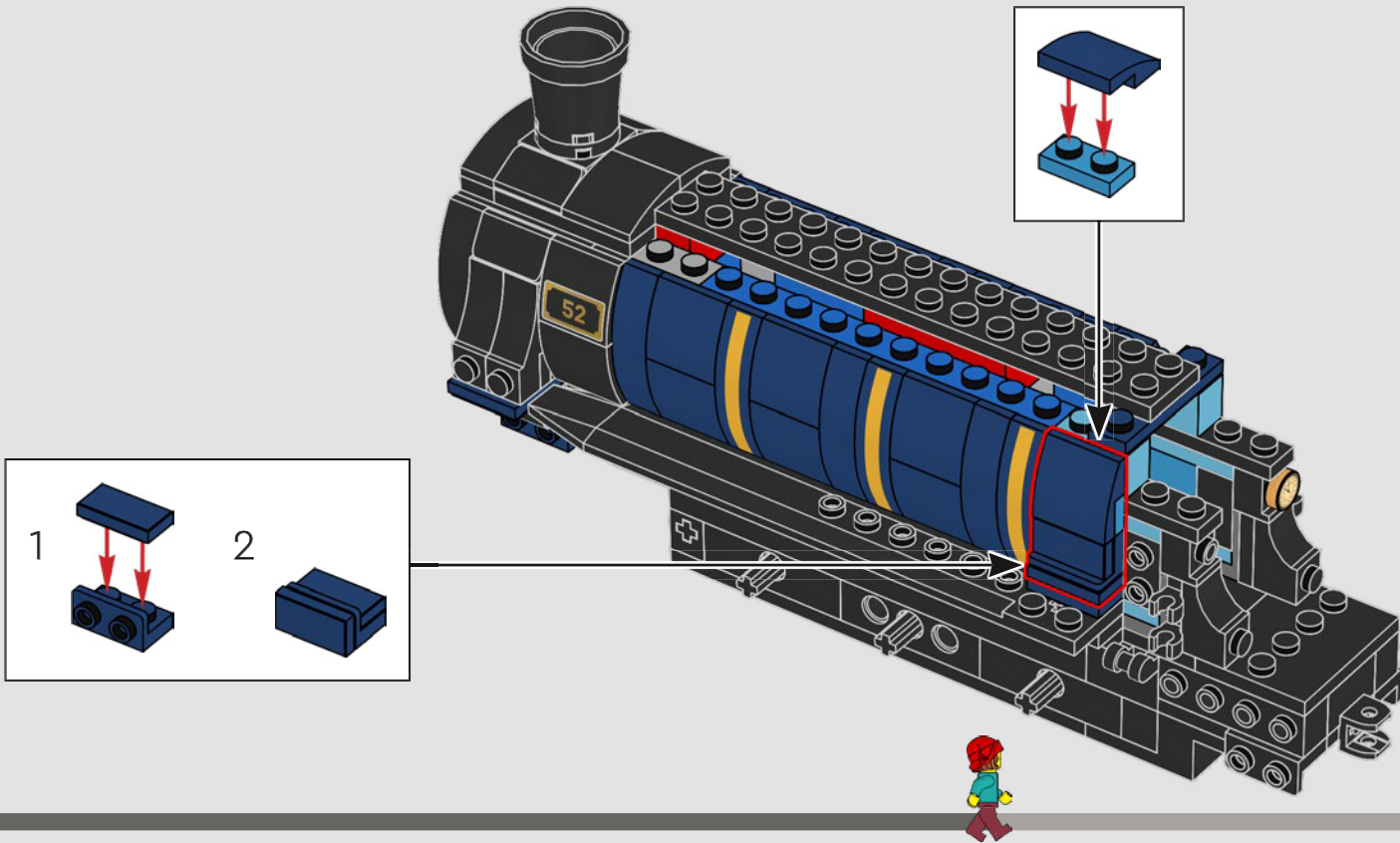

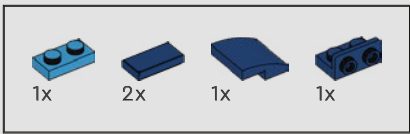

391

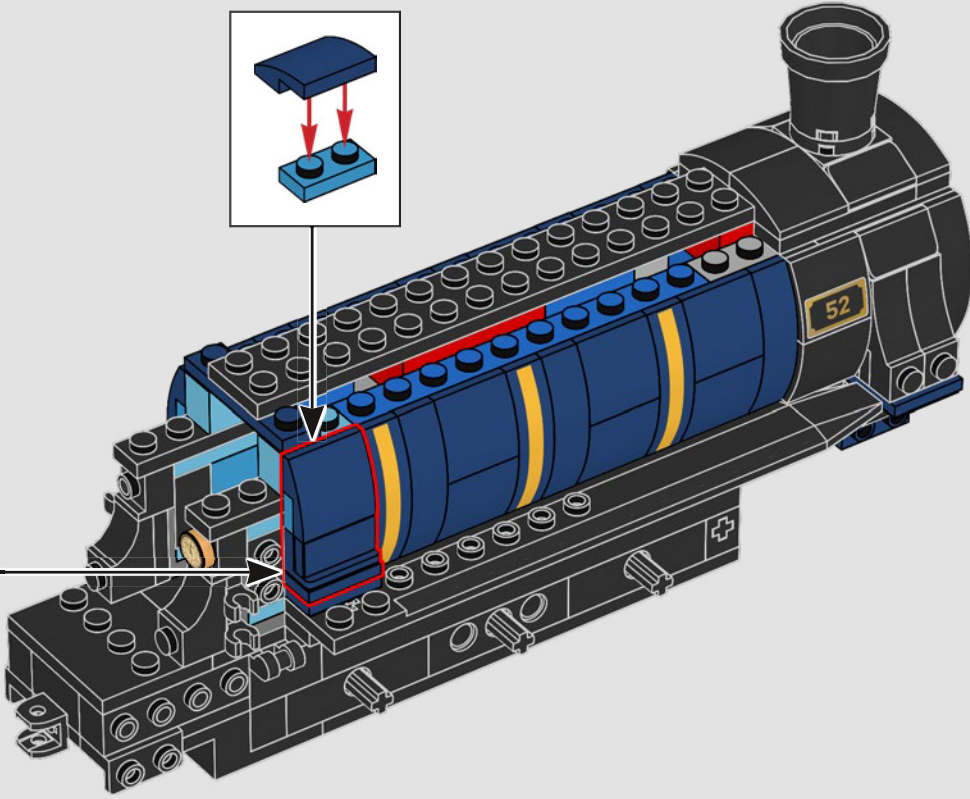
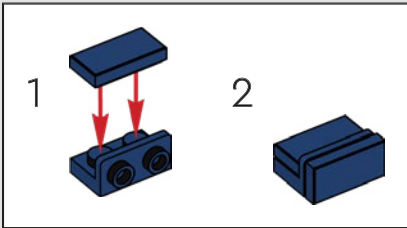
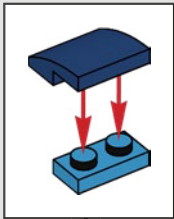

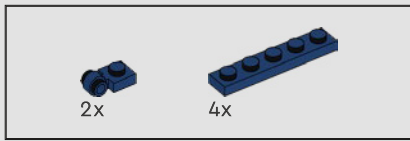

392

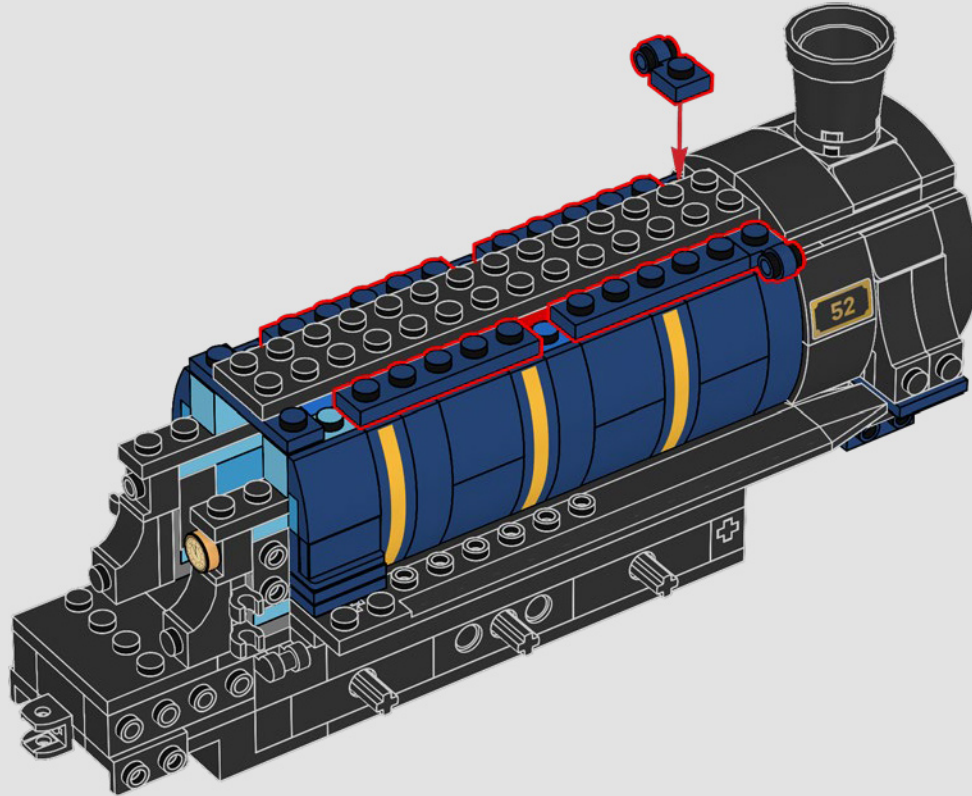

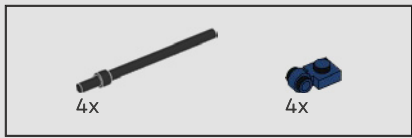

393

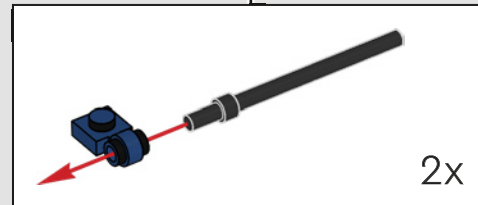
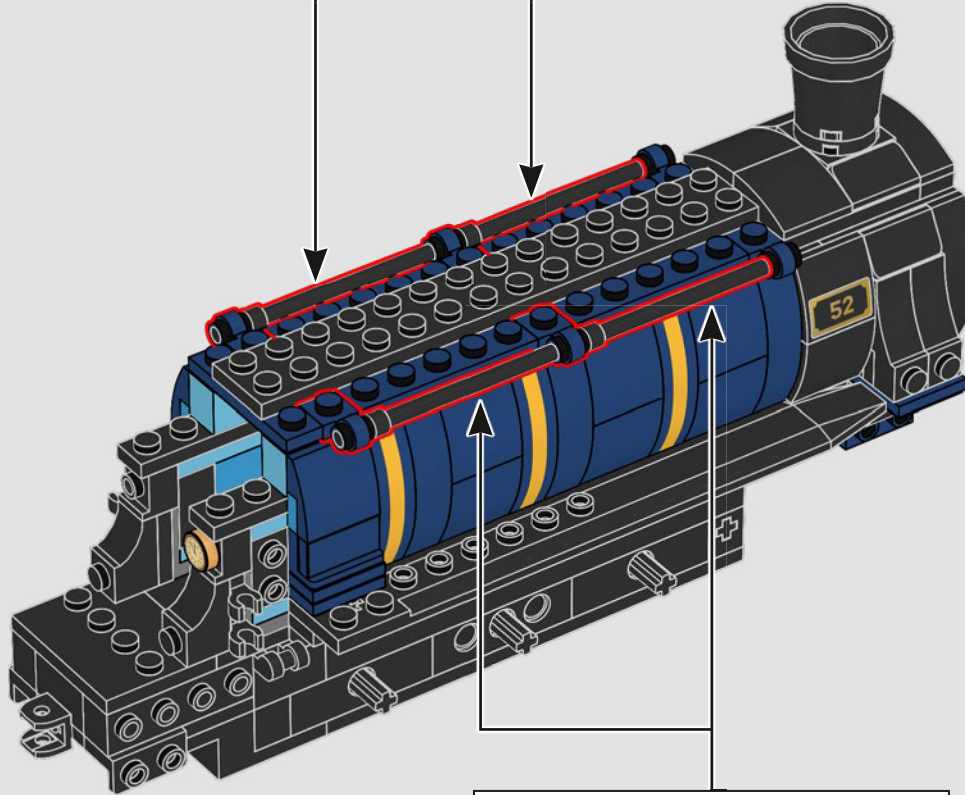
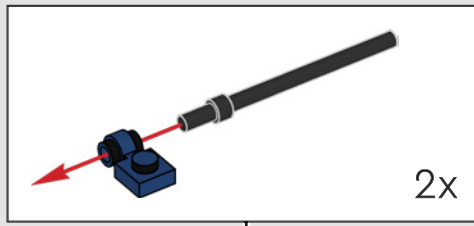

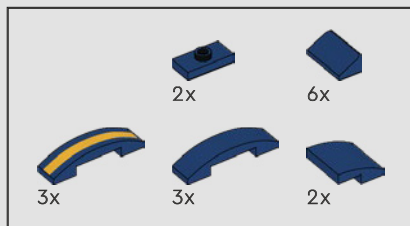

394

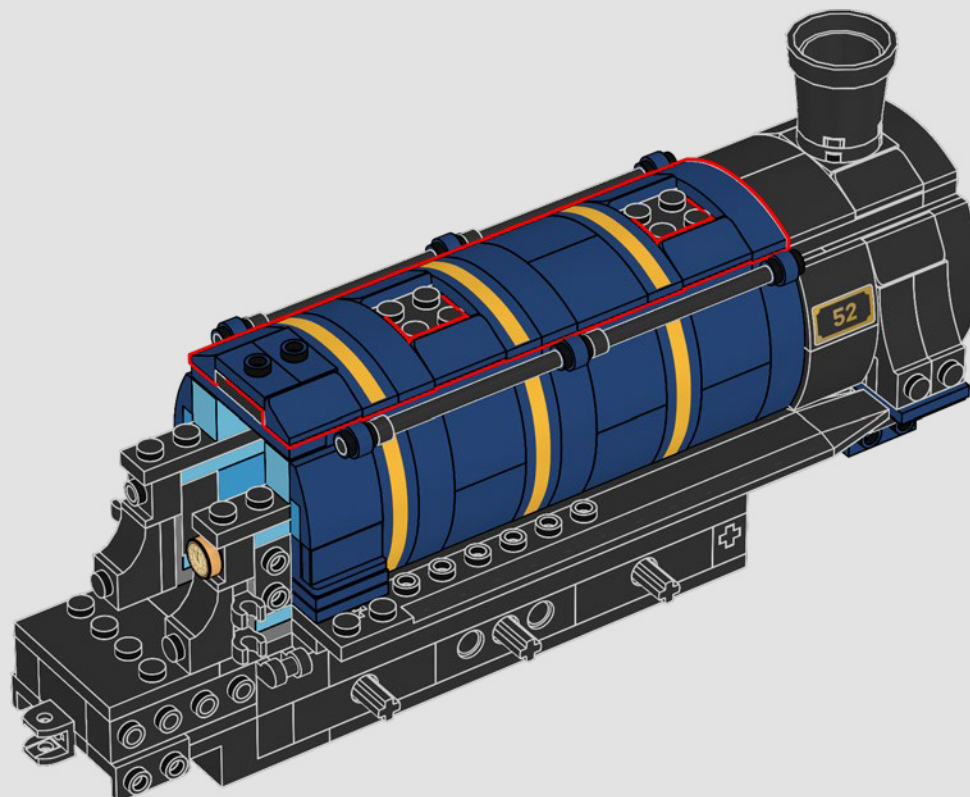

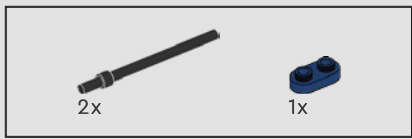

395

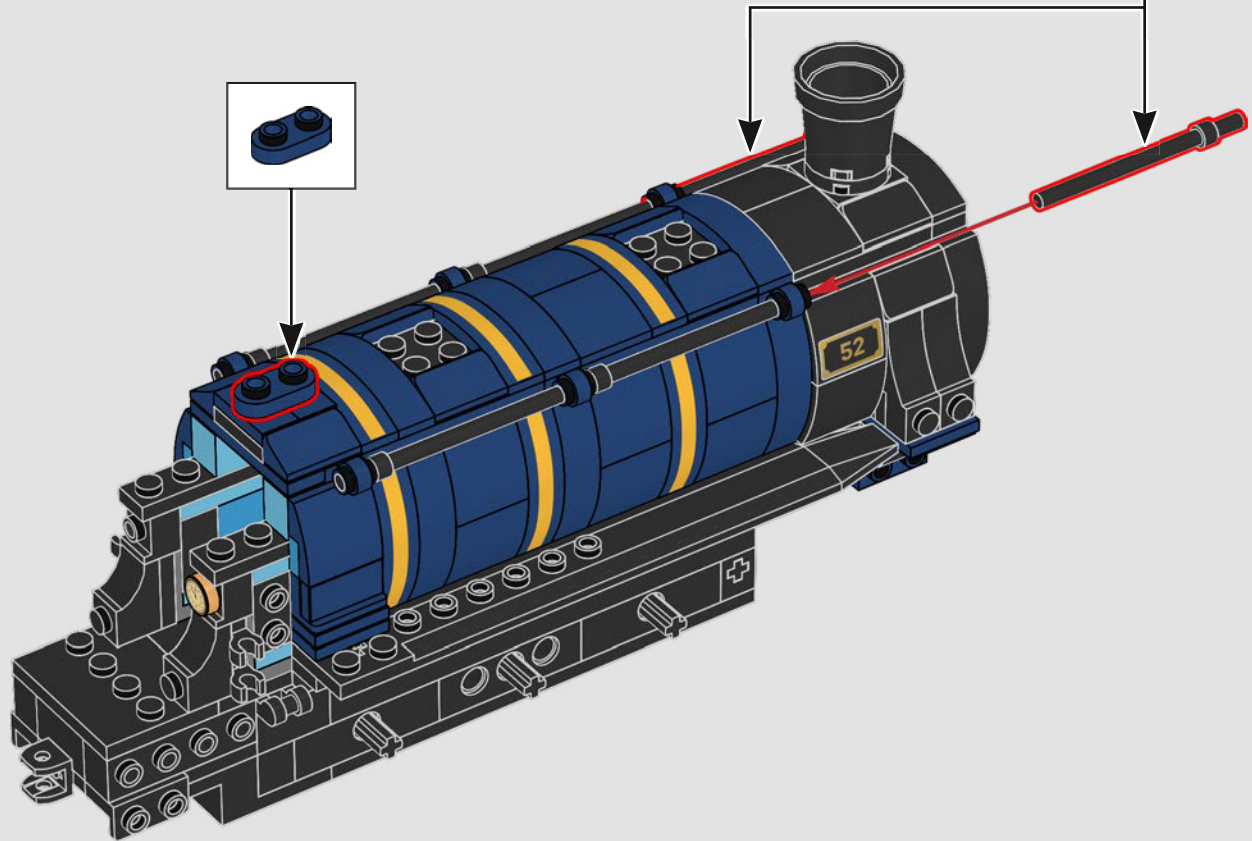

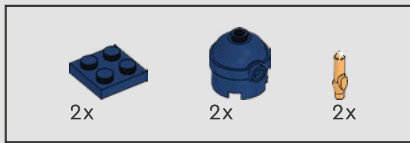

396

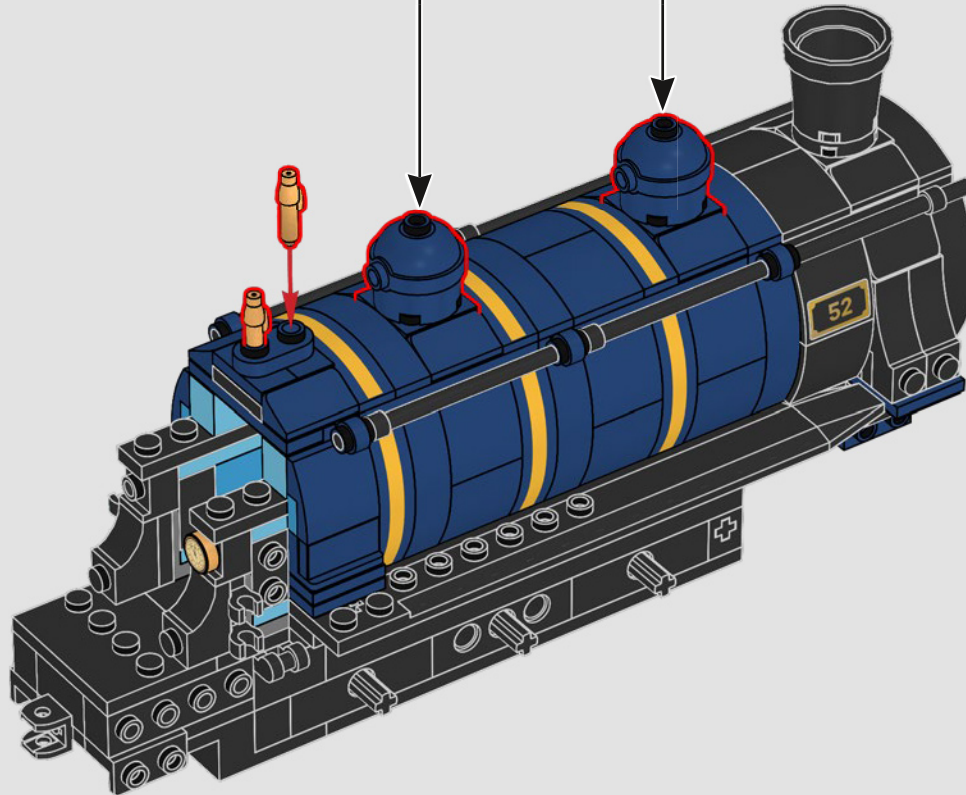
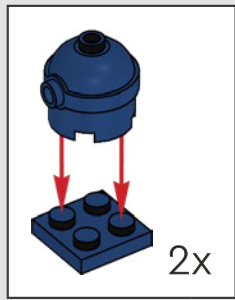

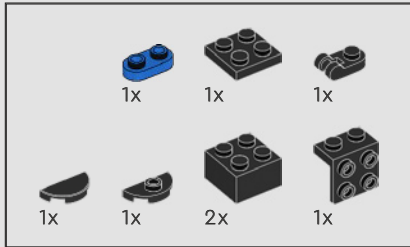
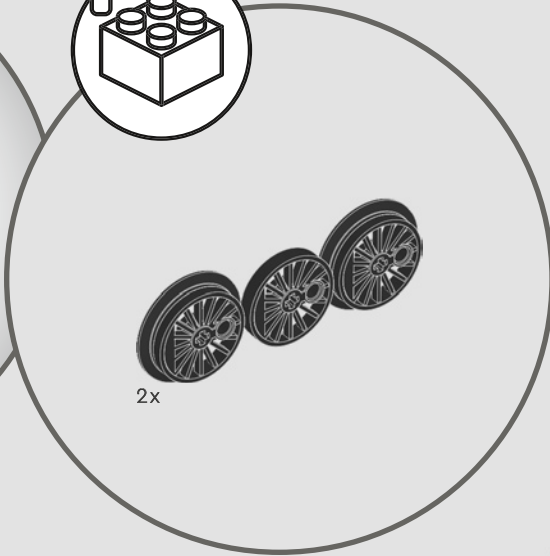
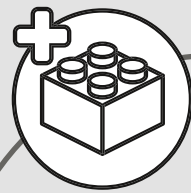

397

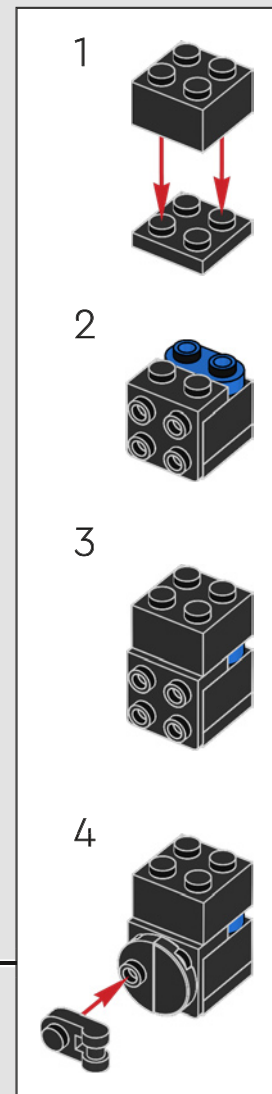
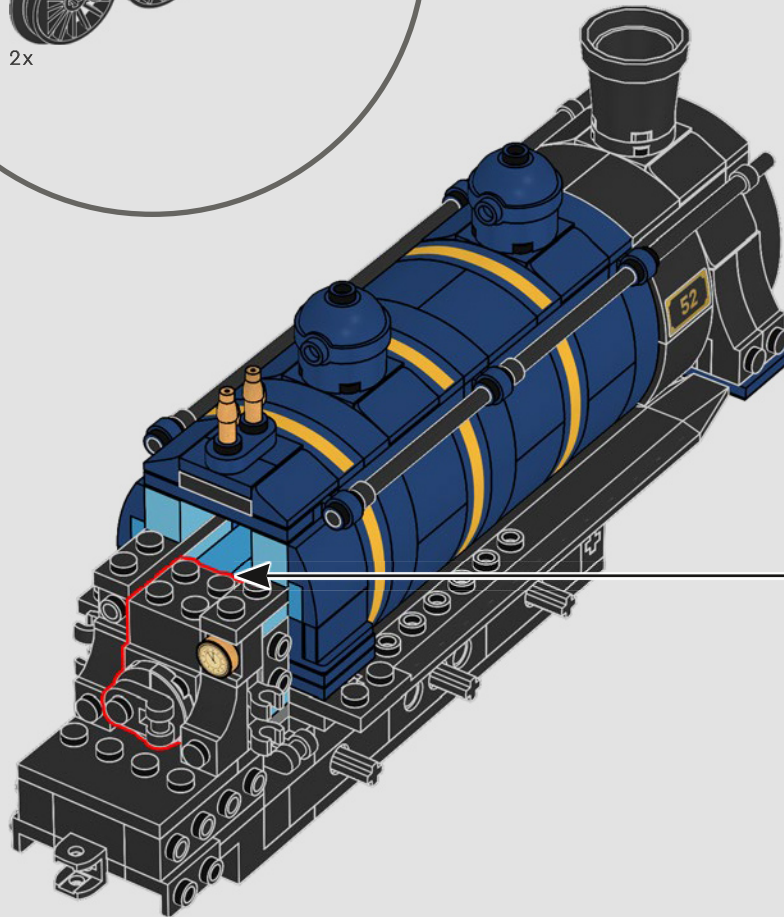



398

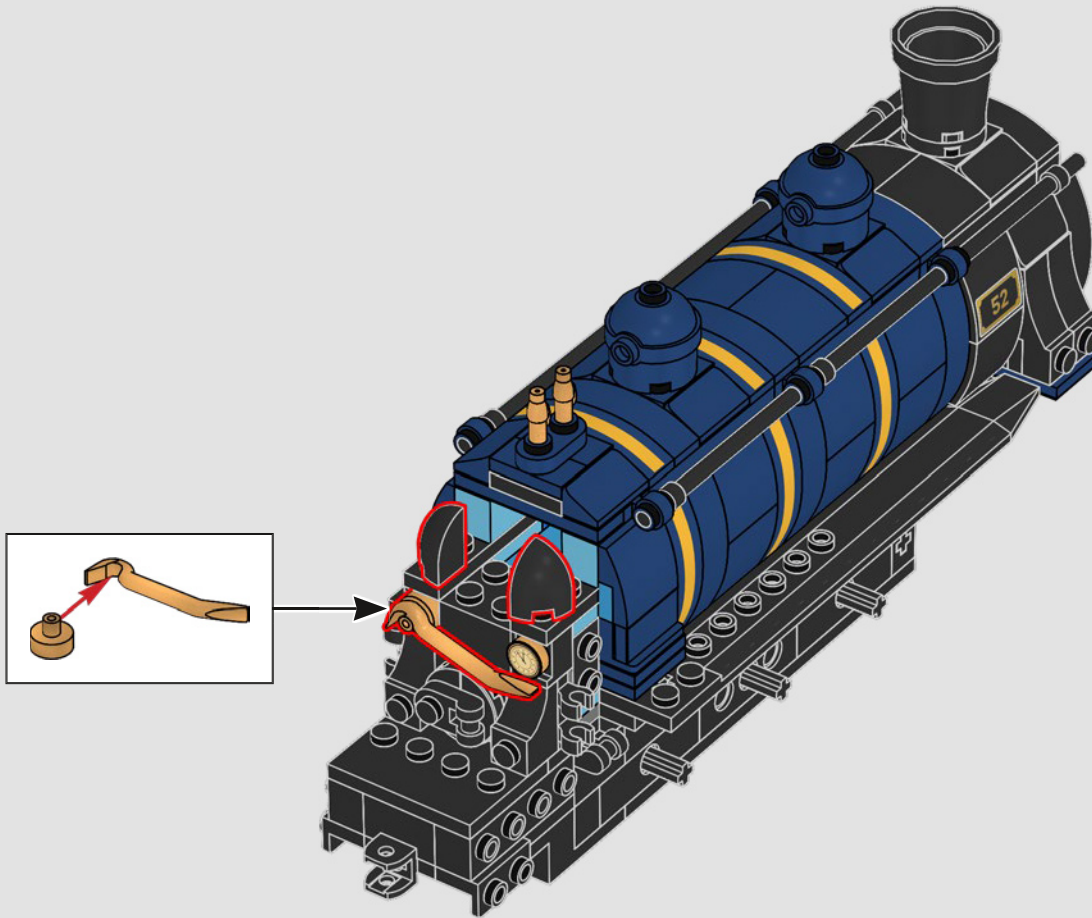

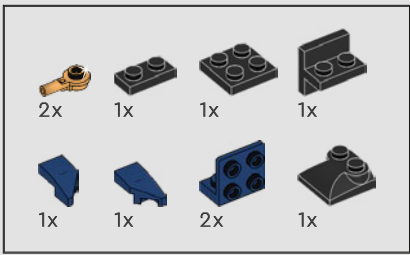

399

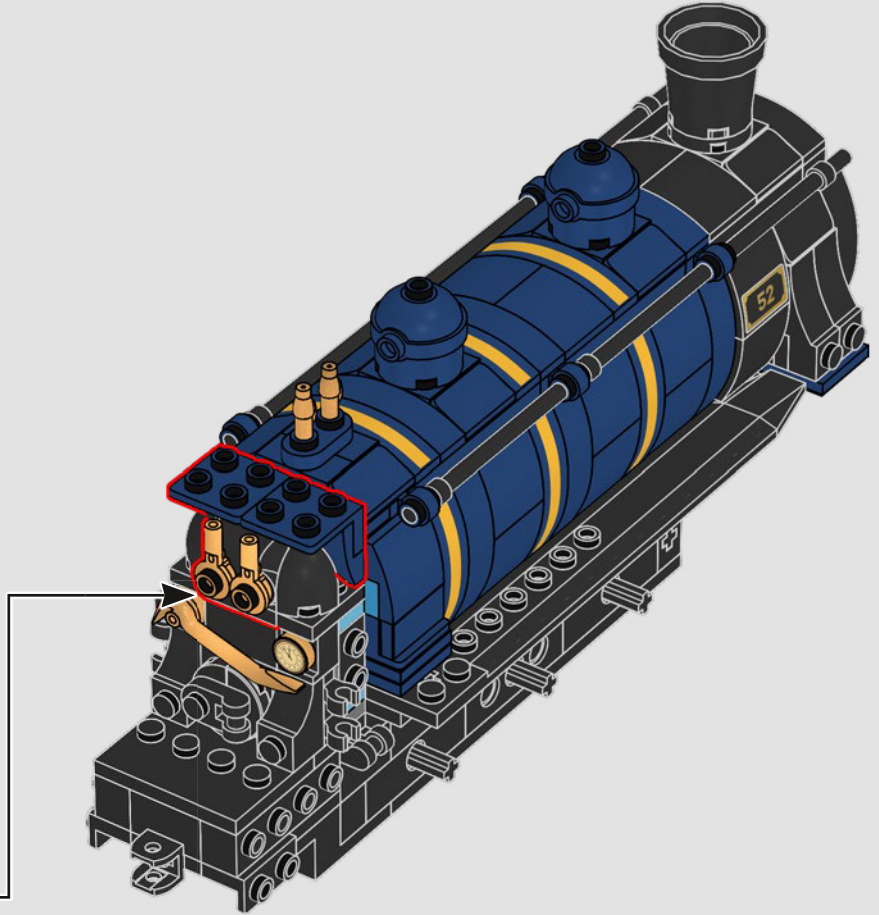
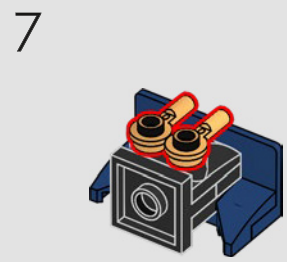
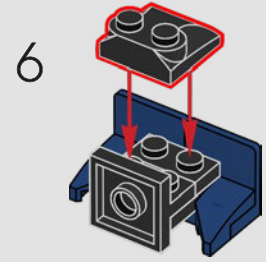
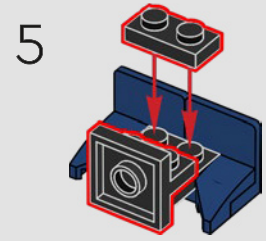
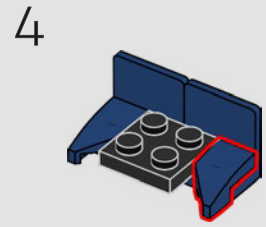
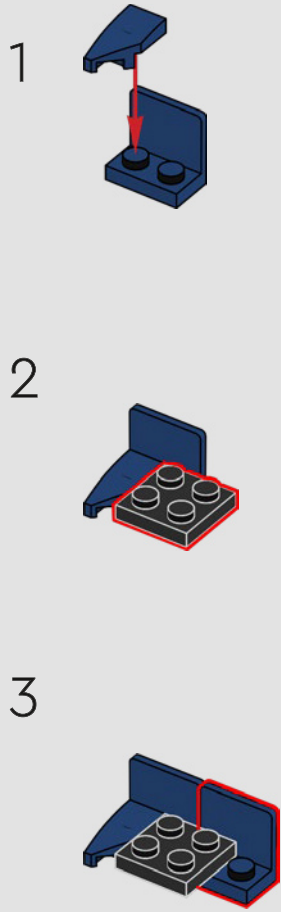

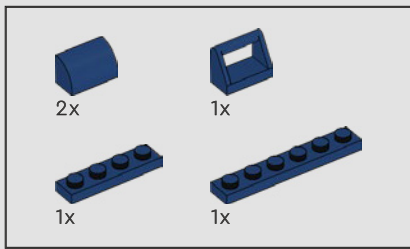

400

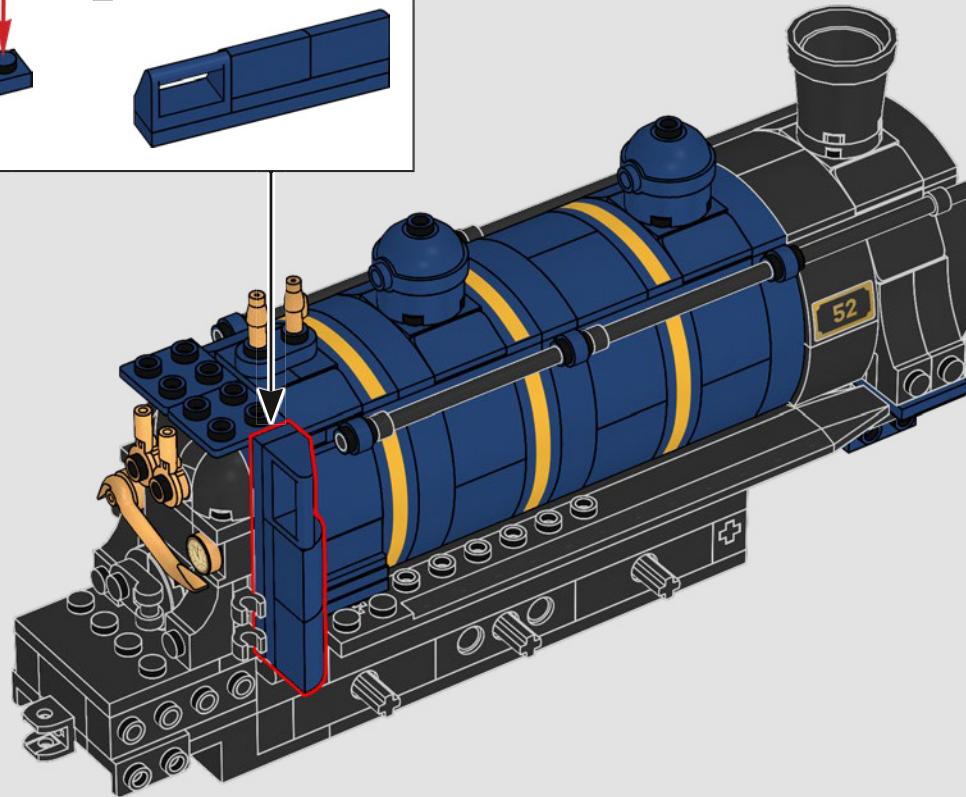
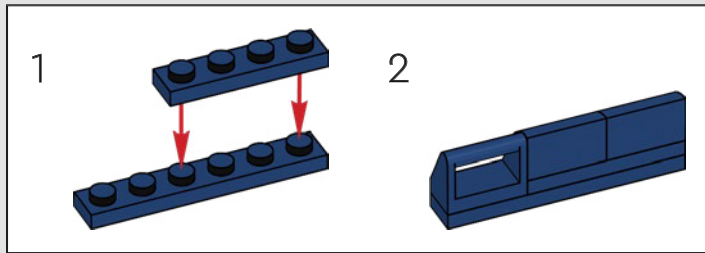

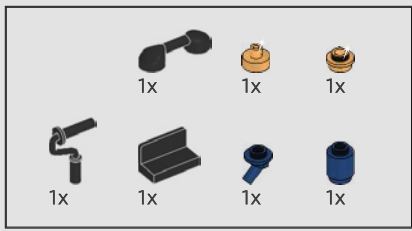

401

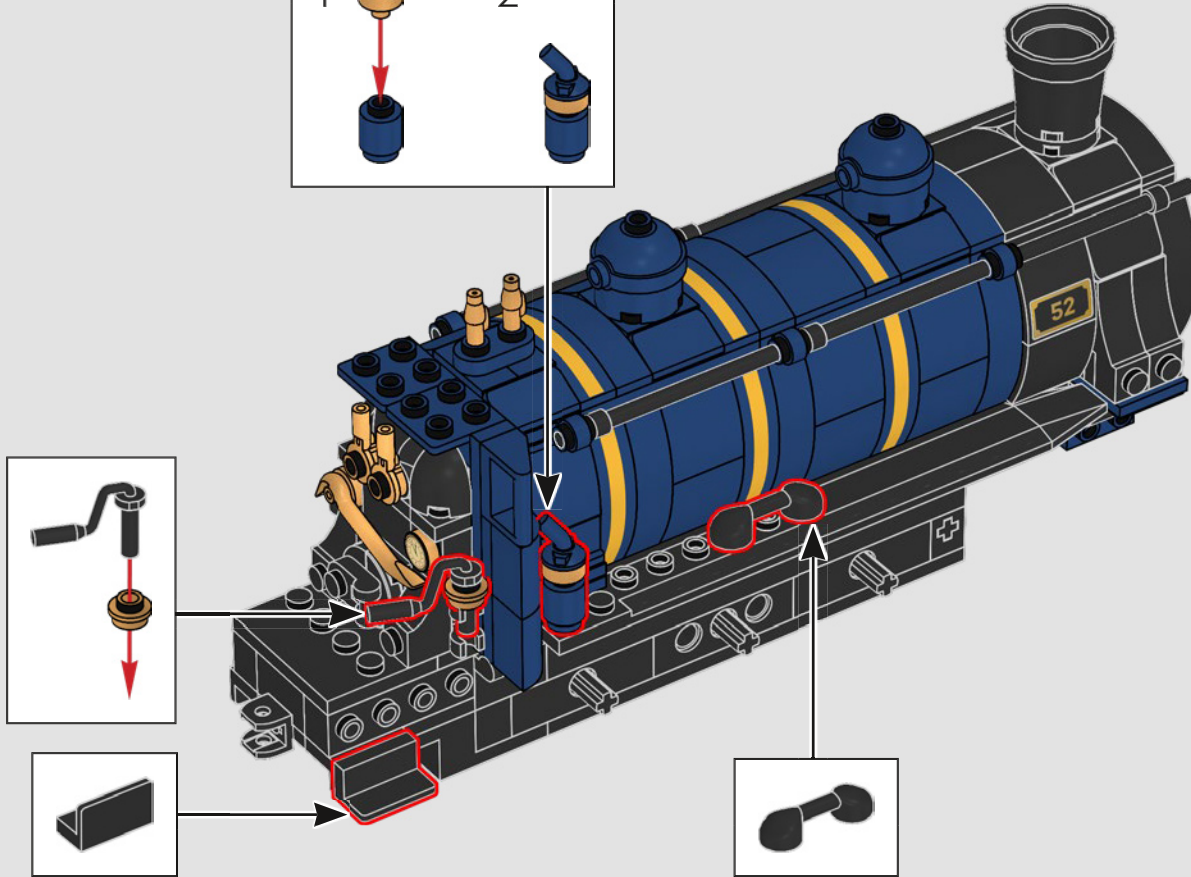
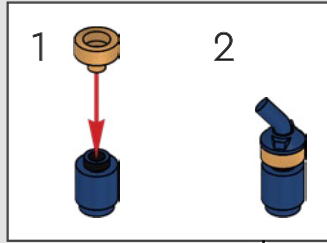

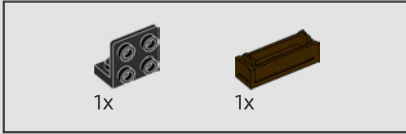
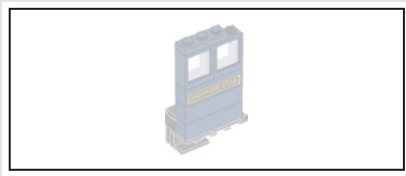

402

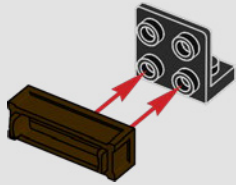

403

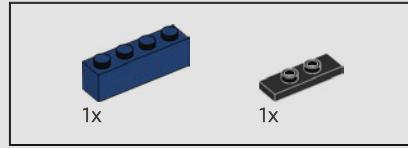
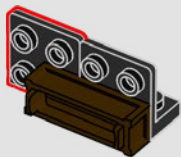

404

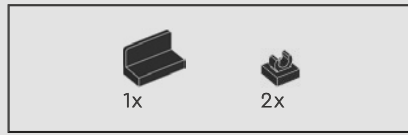
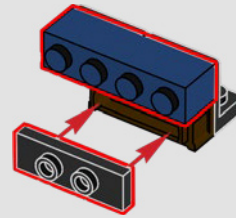

405

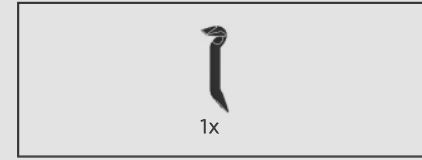
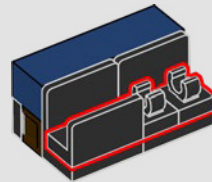

406

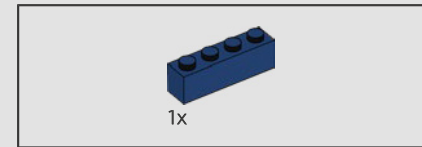
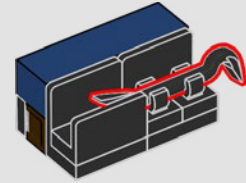

407

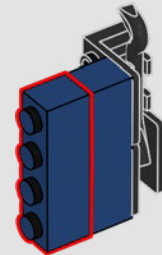
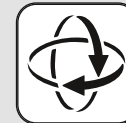

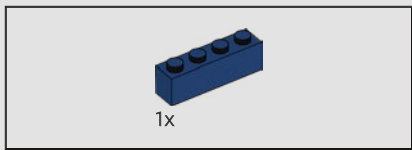

408

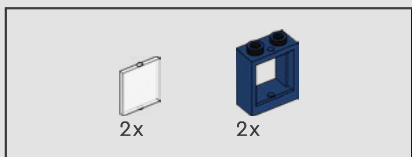
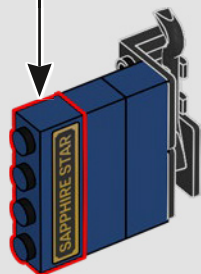
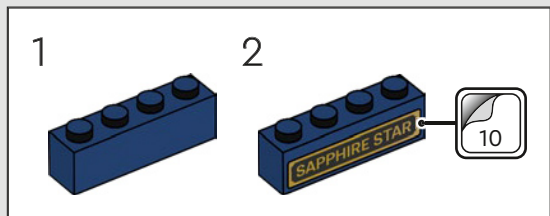

409

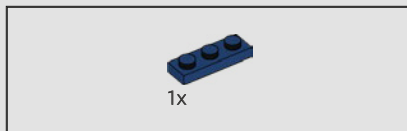
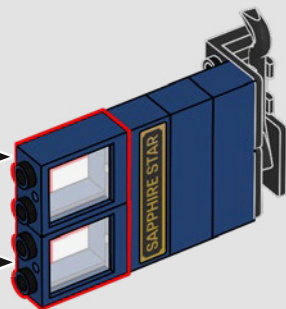
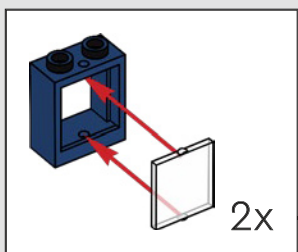

410

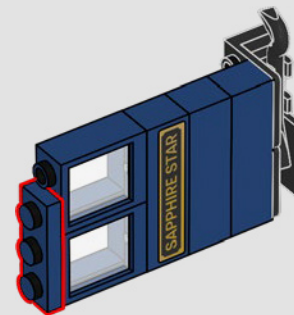

411

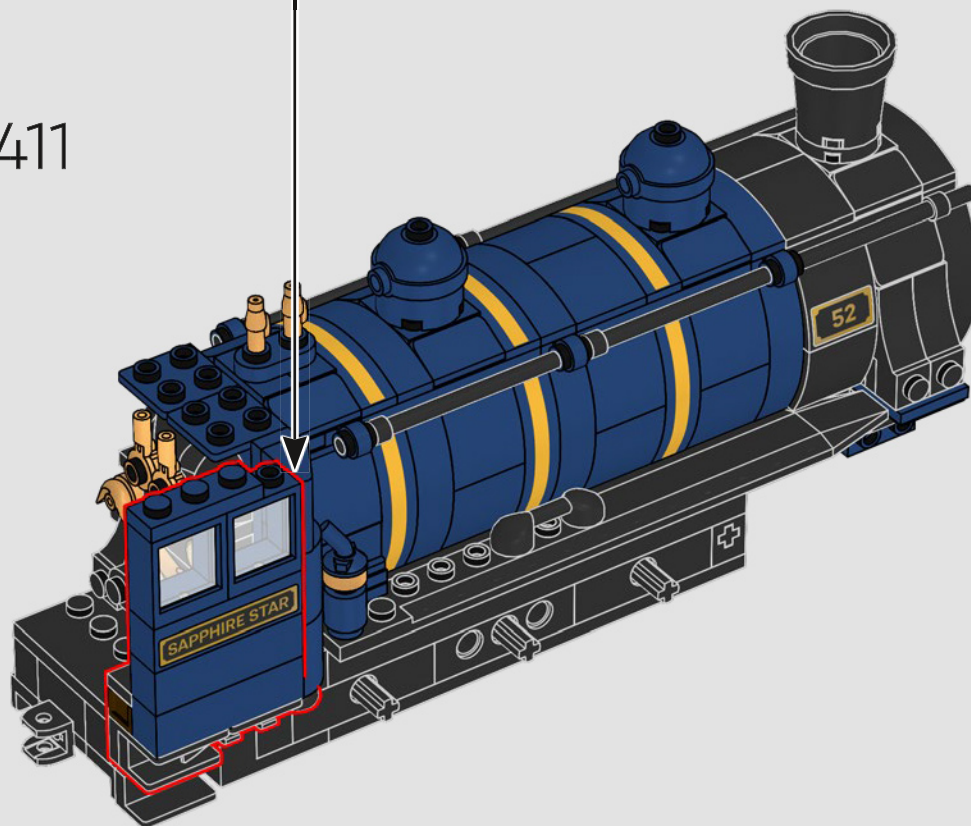

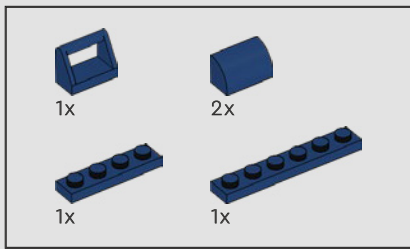

412

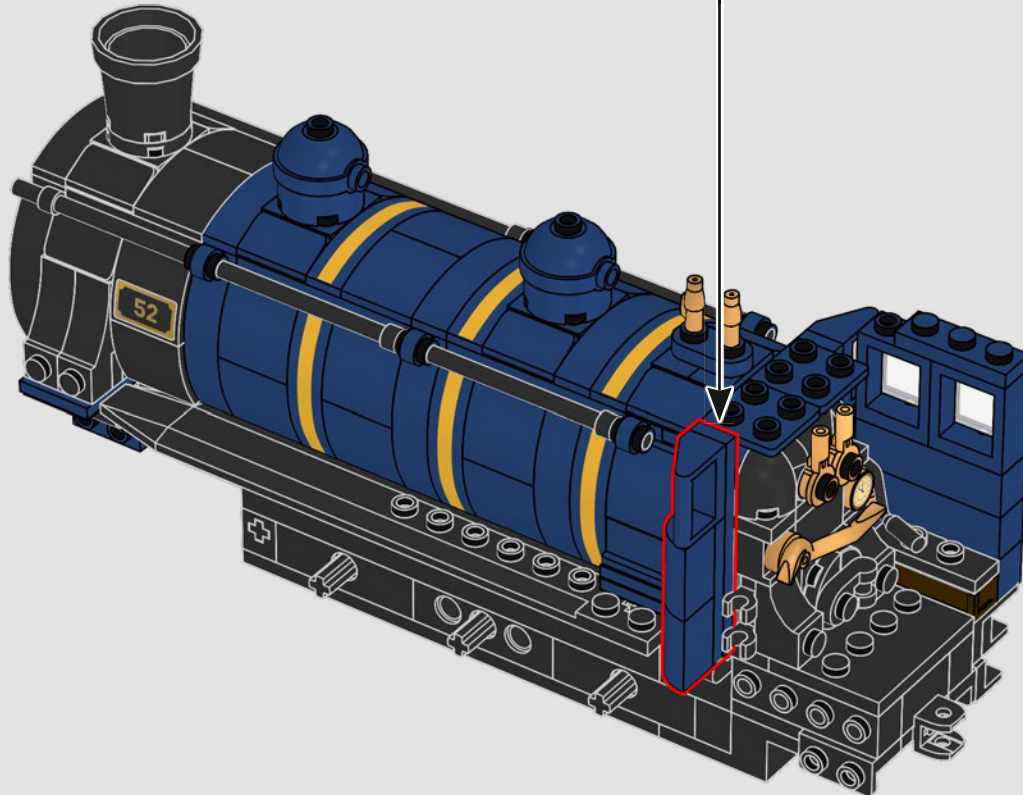
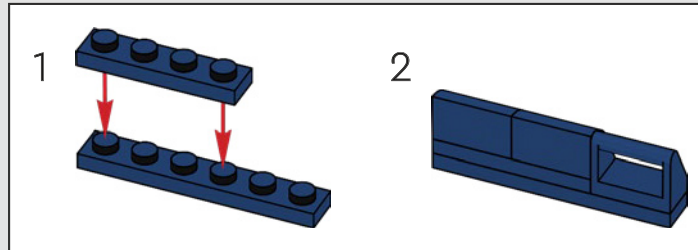

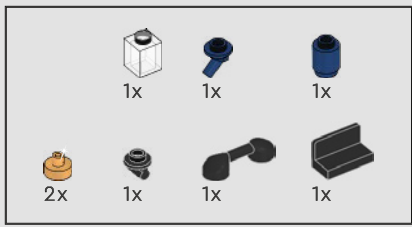

413

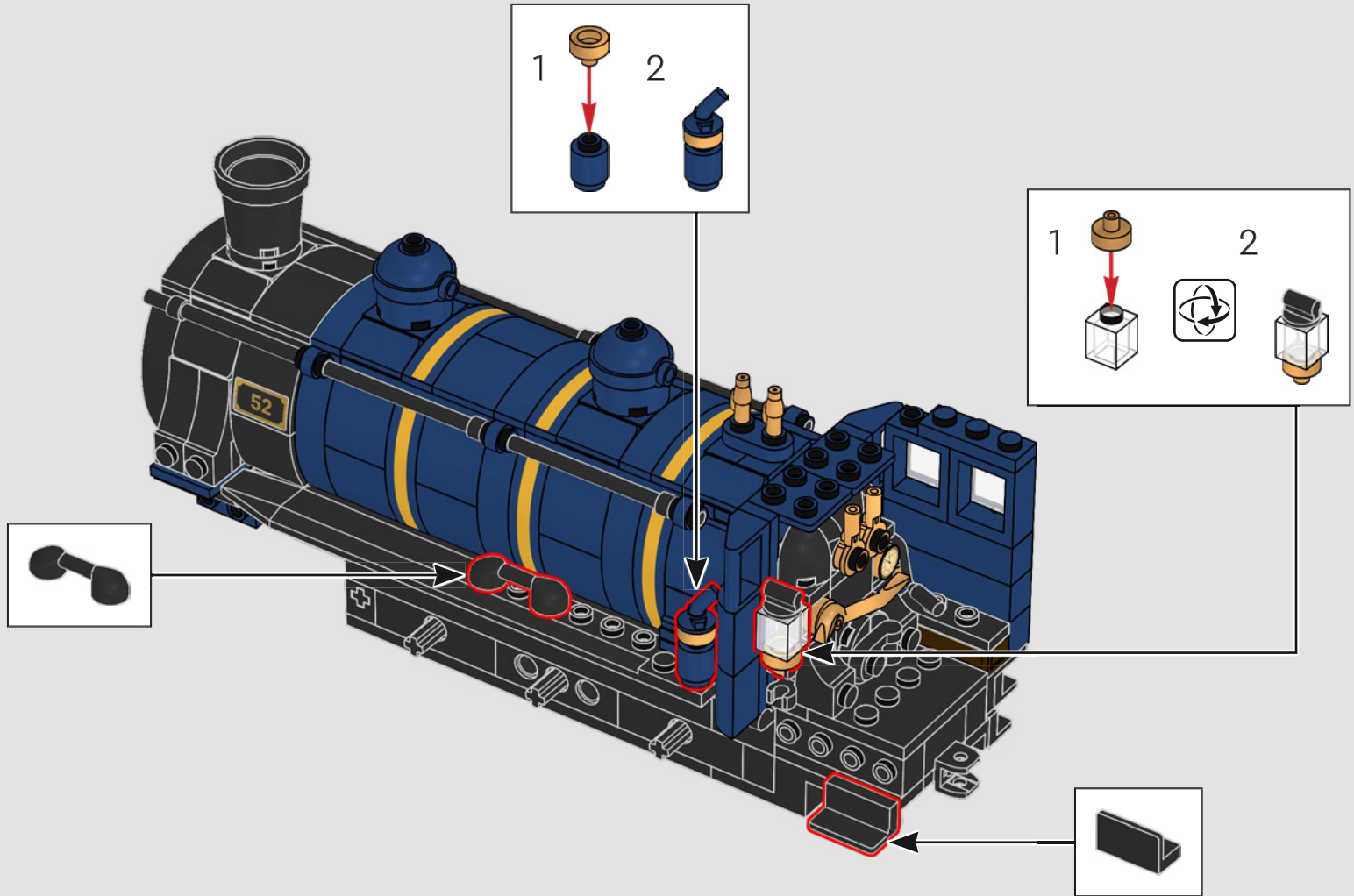

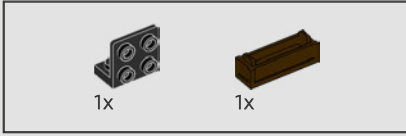
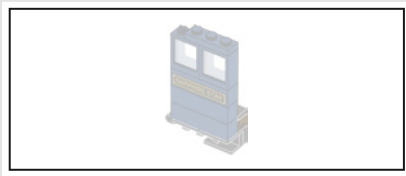

414

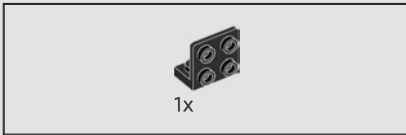
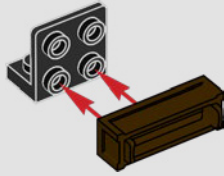

415

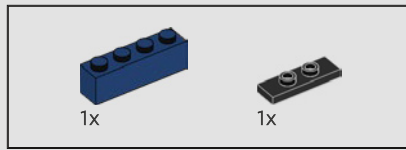
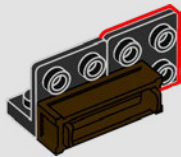

416

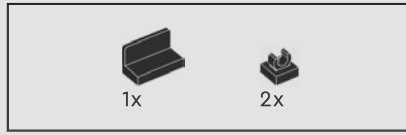
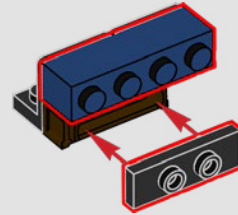

417

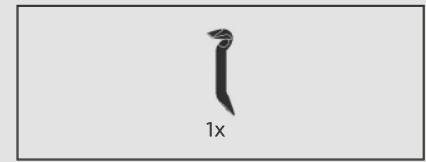
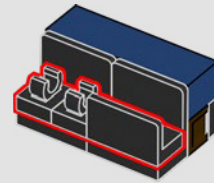

418

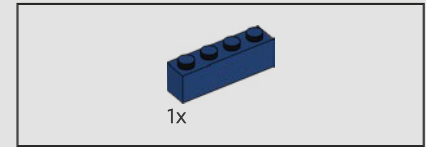
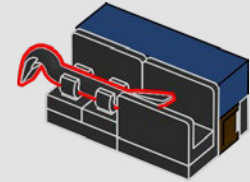

419

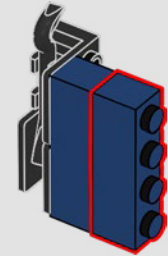

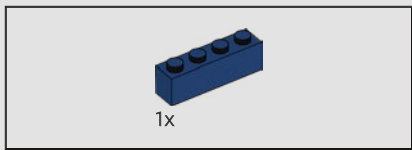

420

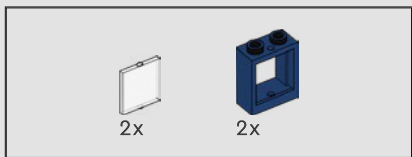
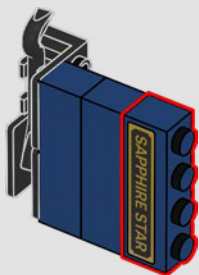
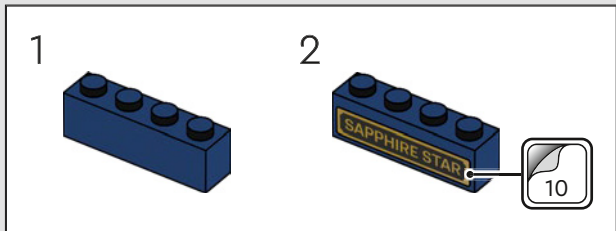

421

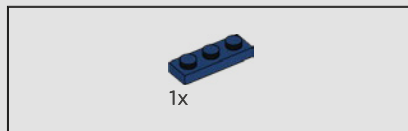
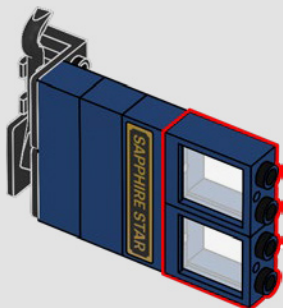
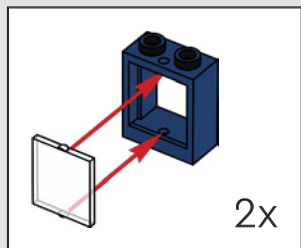

422

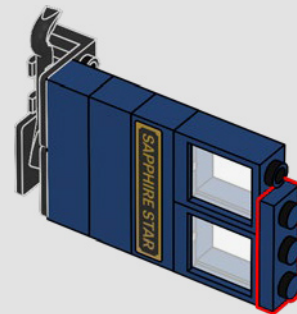

423

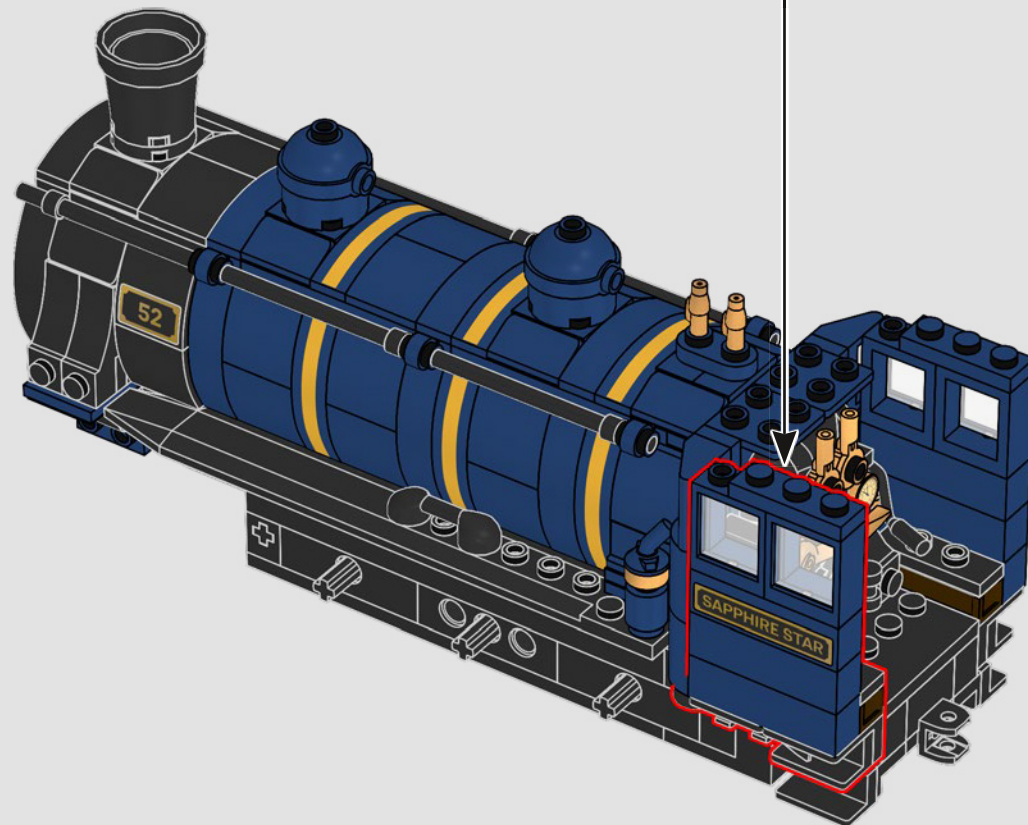

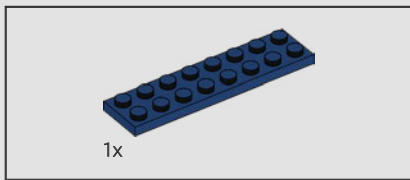

424

..... ●
"¡La Sapphire Star es una auténtica joya!
Me recuerda a un tren nocturno que
tomé en la Isla Esmeralda años atrás".

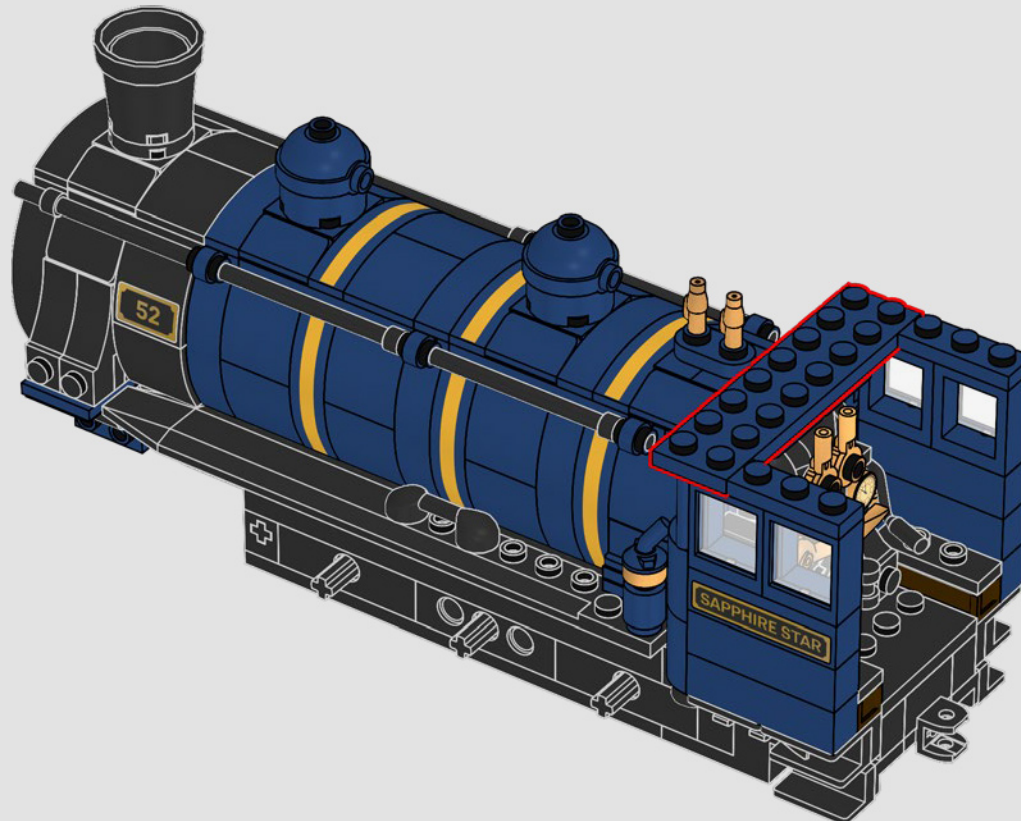

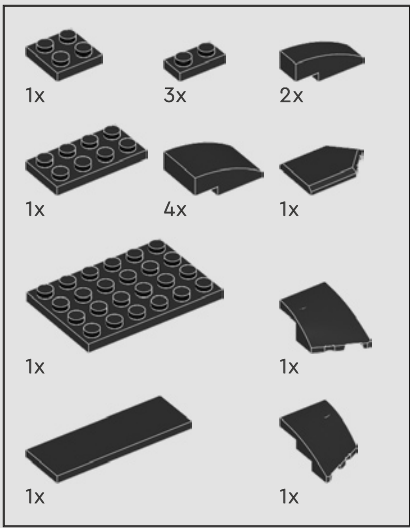

425

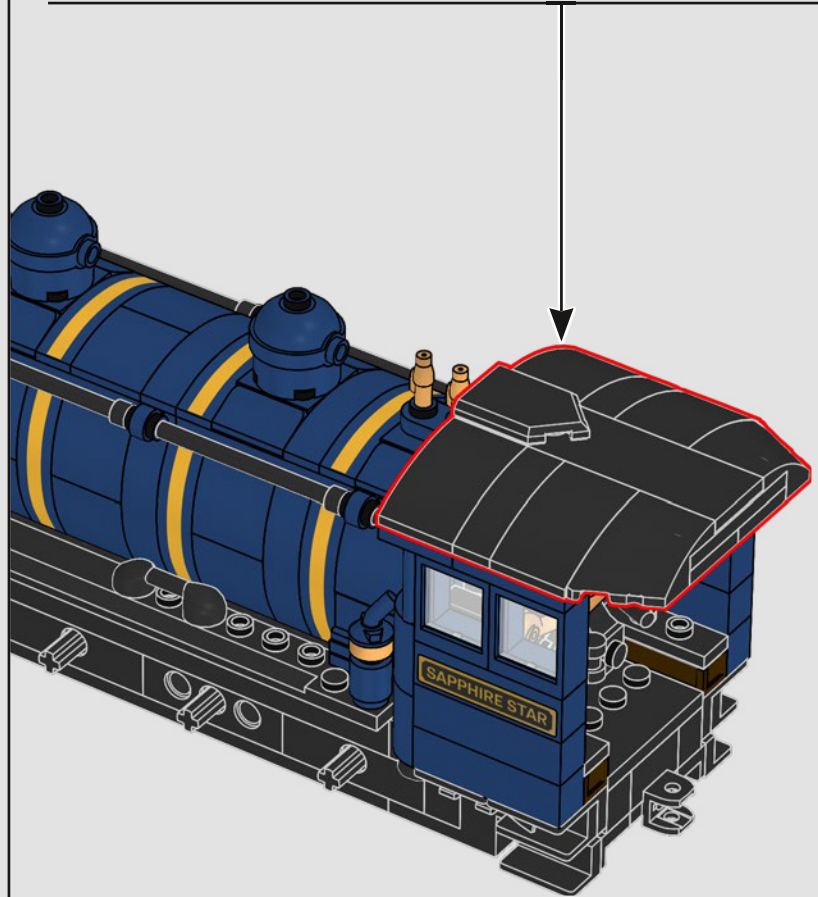
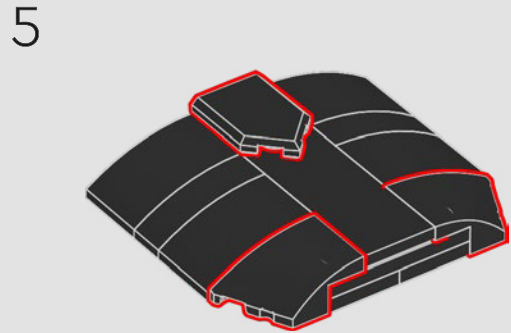
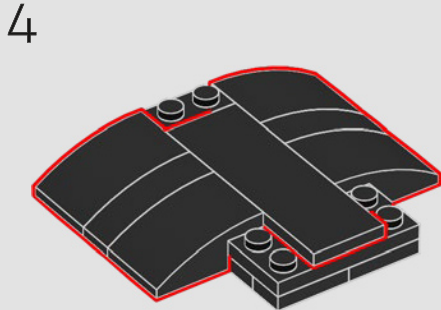
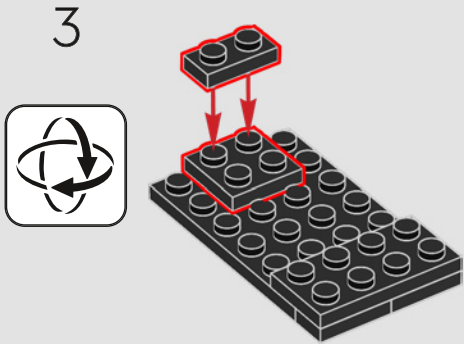
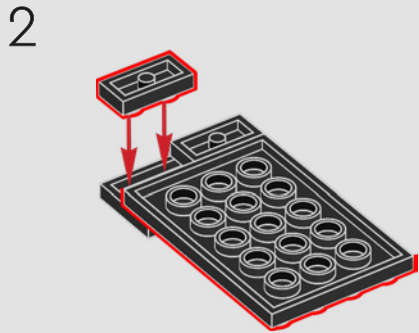
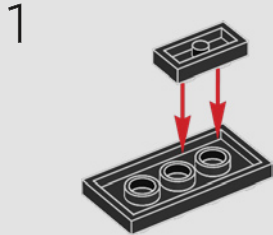

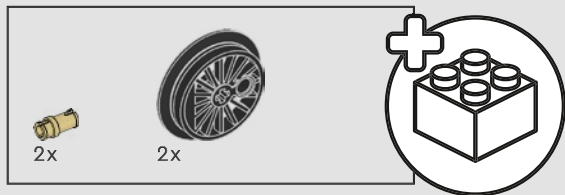

426

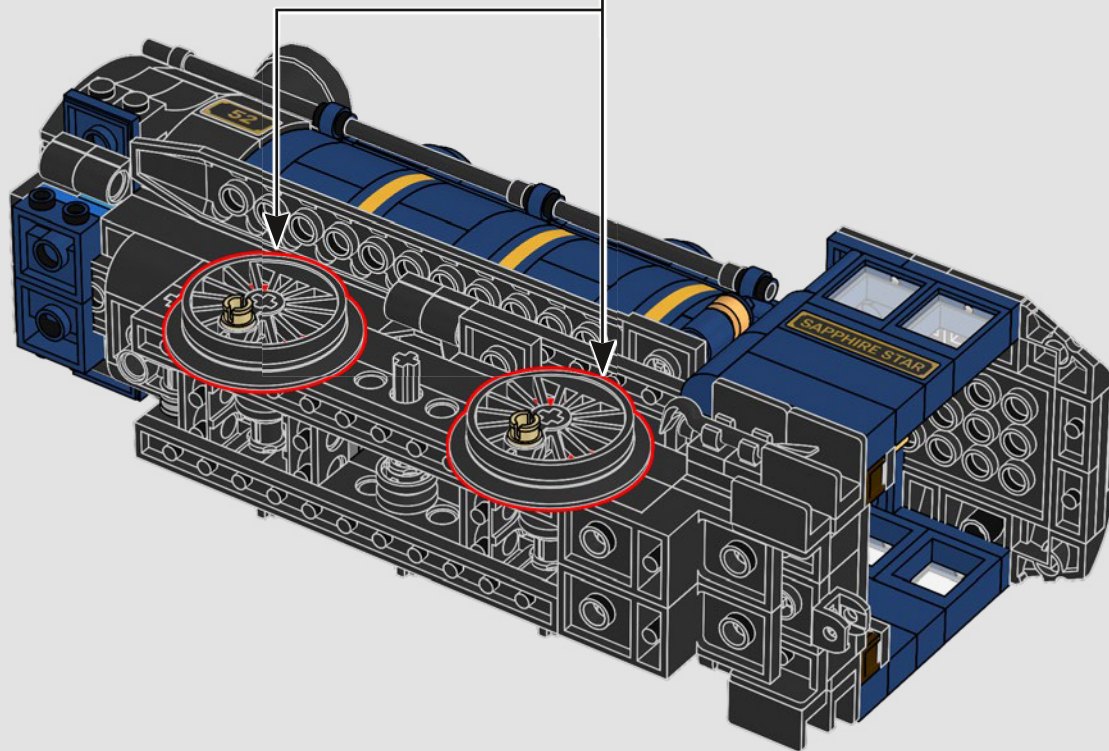
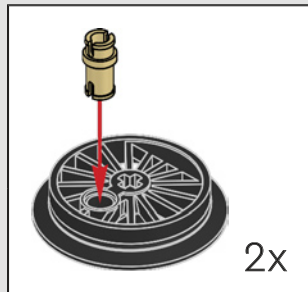

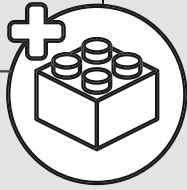
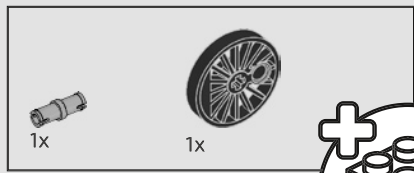

427

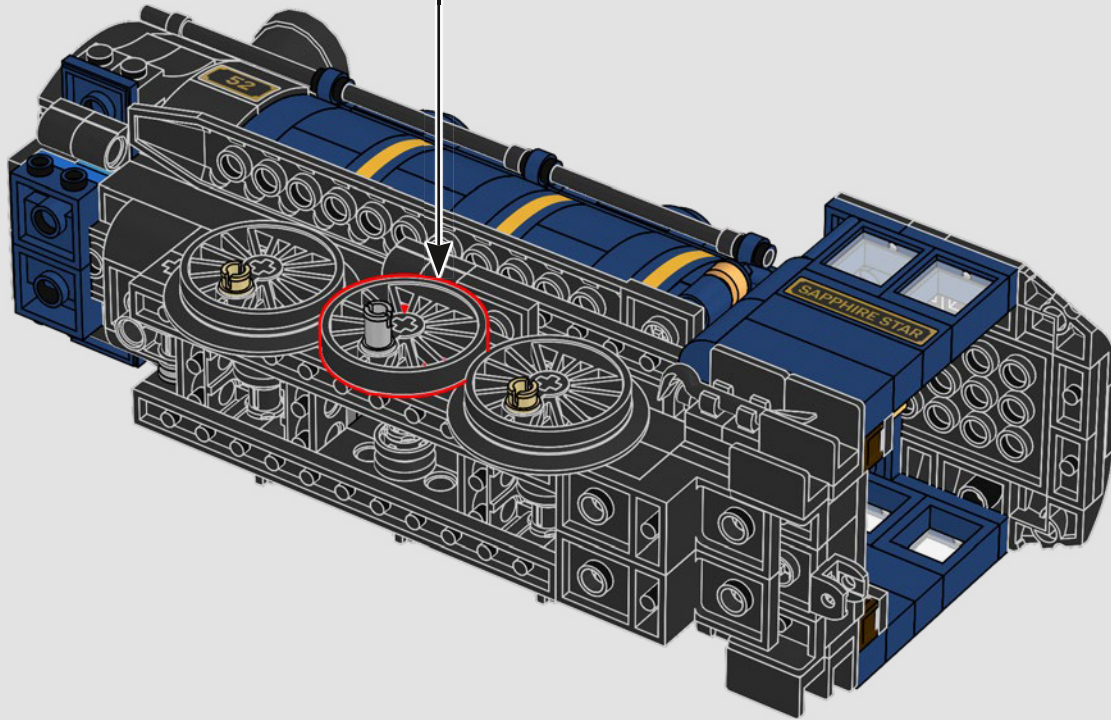
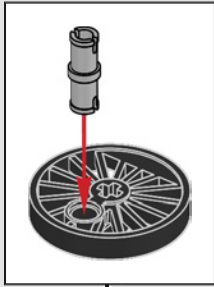

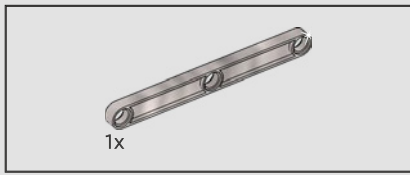

428

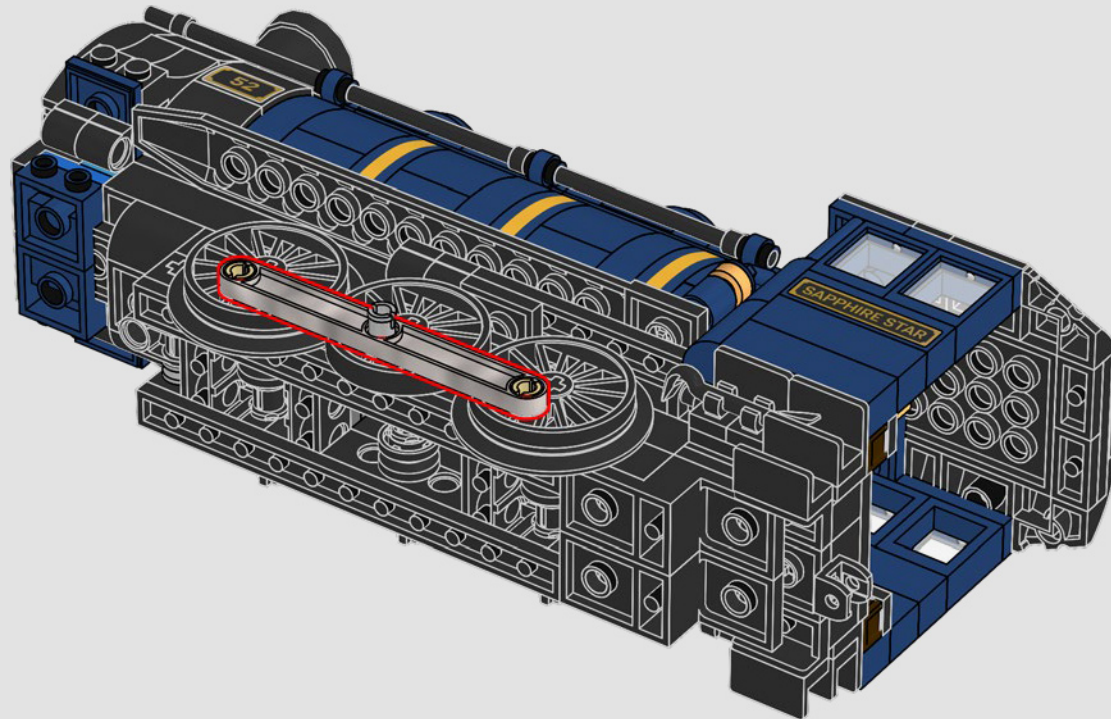

..... ●
"Estas bielas de acoplamiento plateadas tienen un diseño totalmente nuevo creado especialmente para esta locomotora".





429

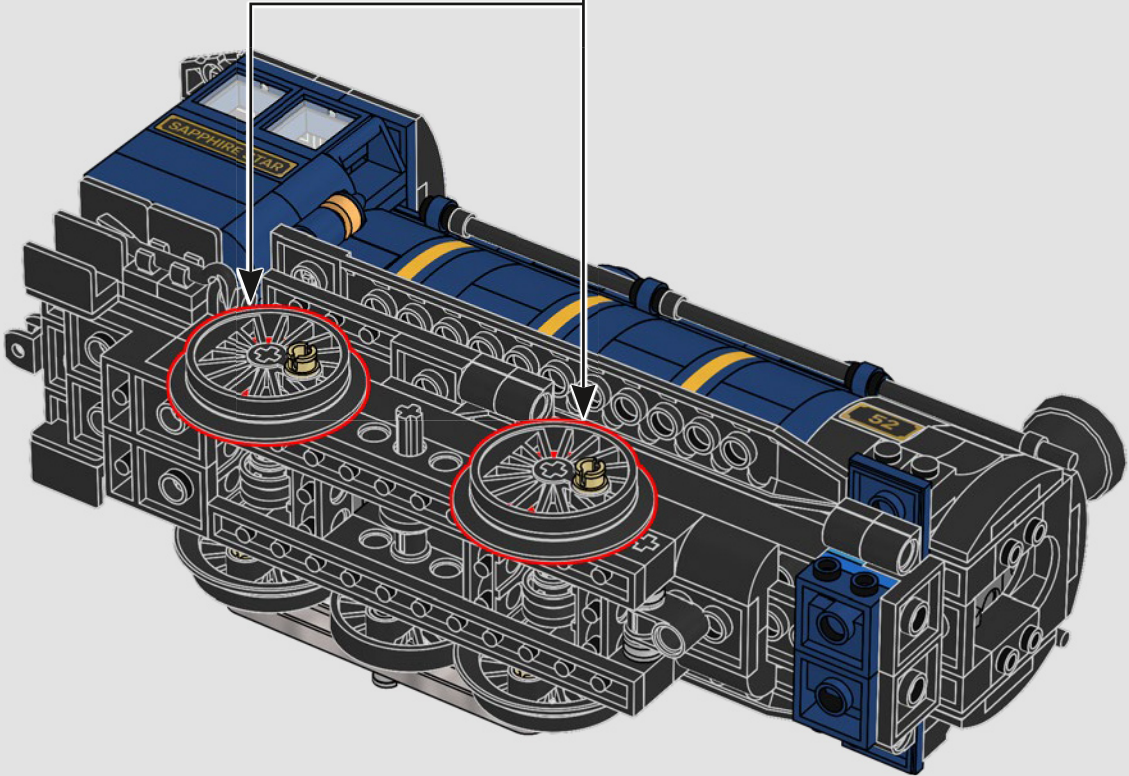
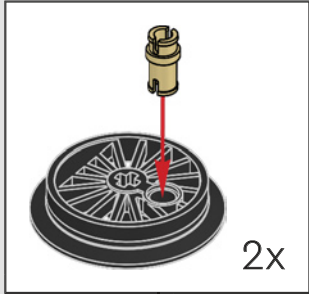
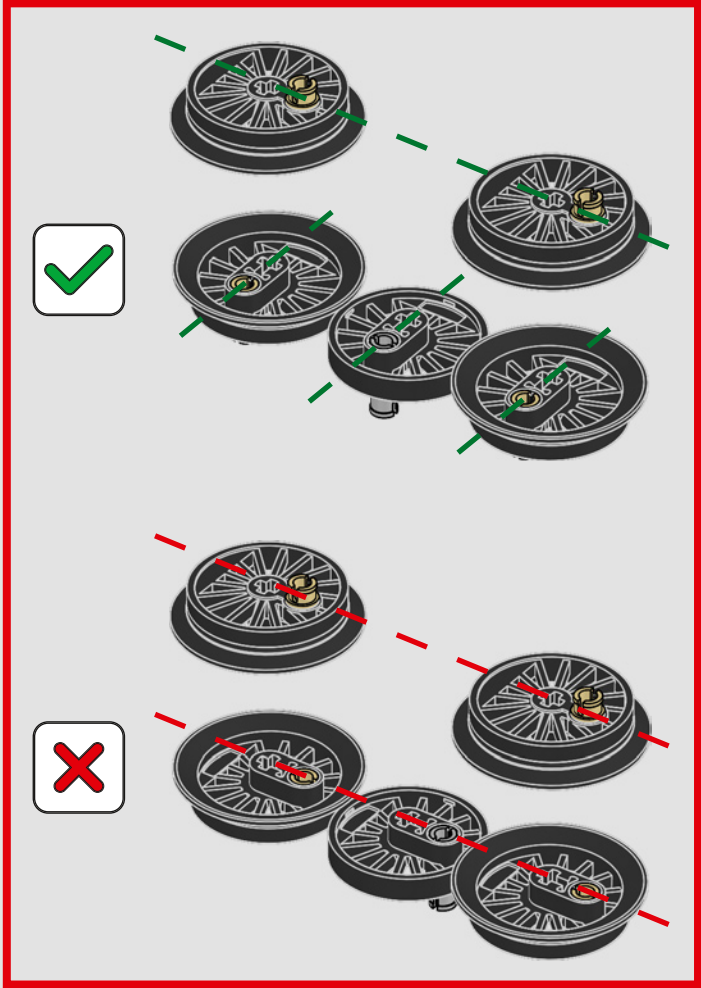



430

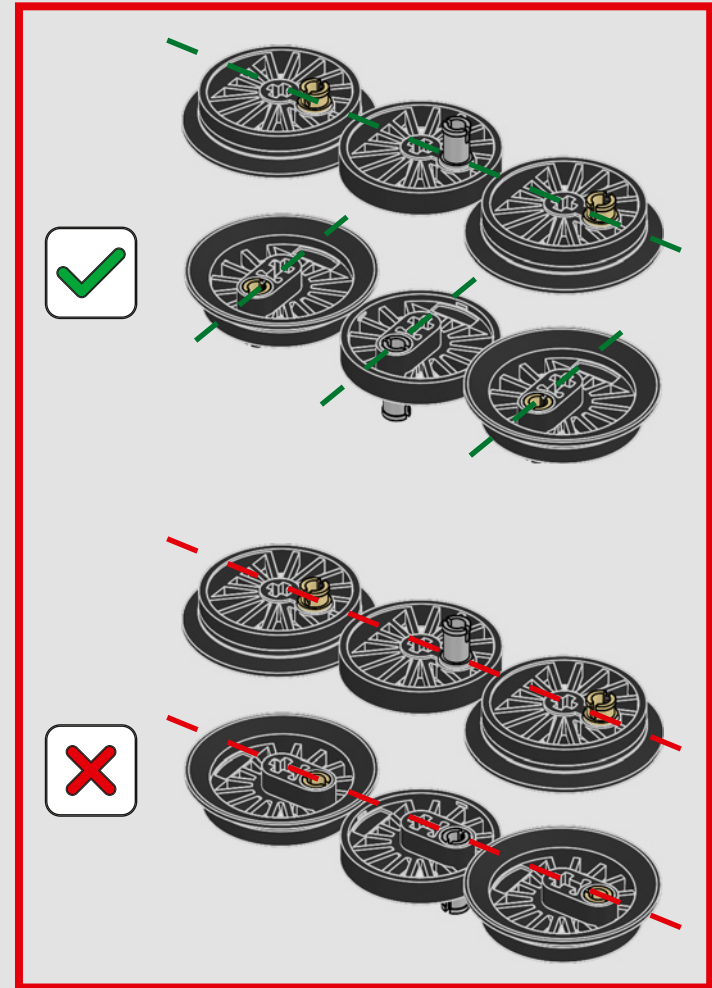
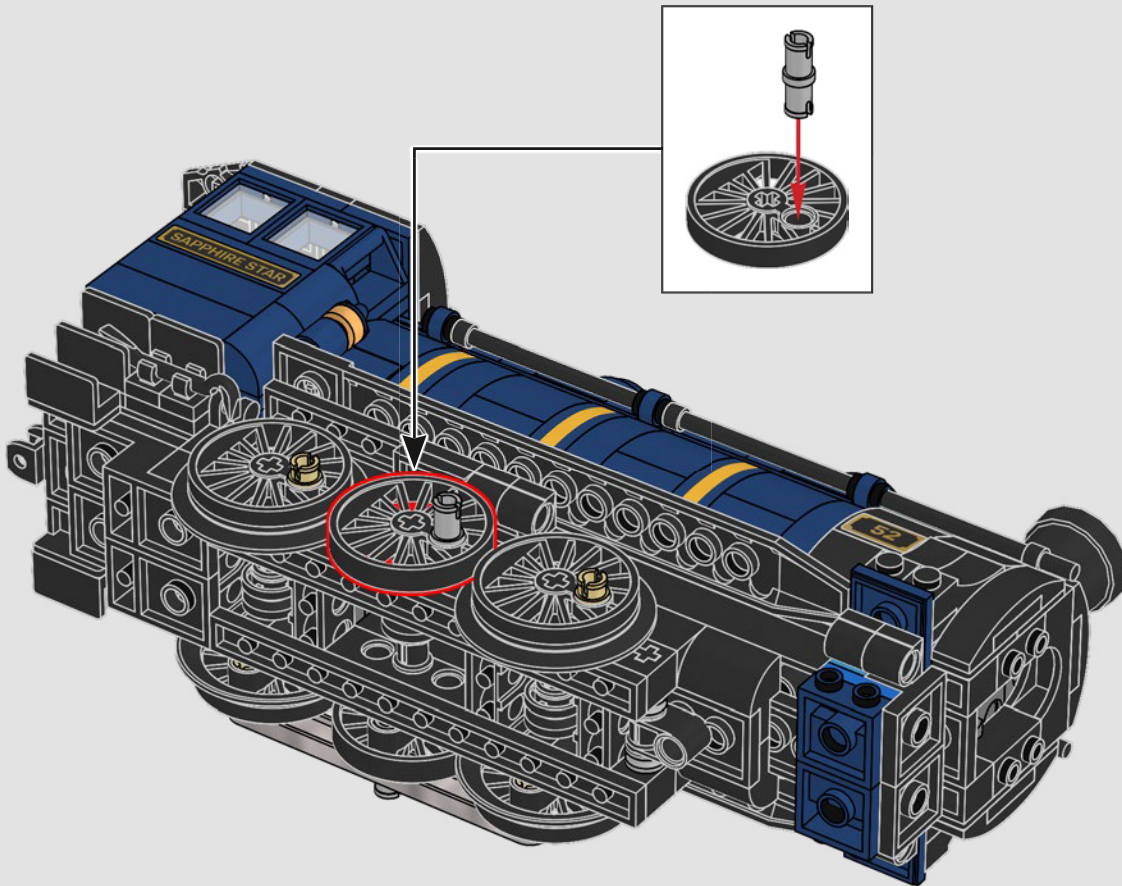

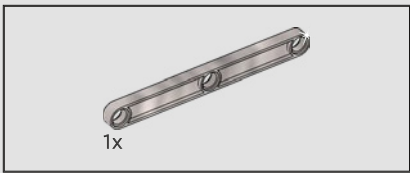

431

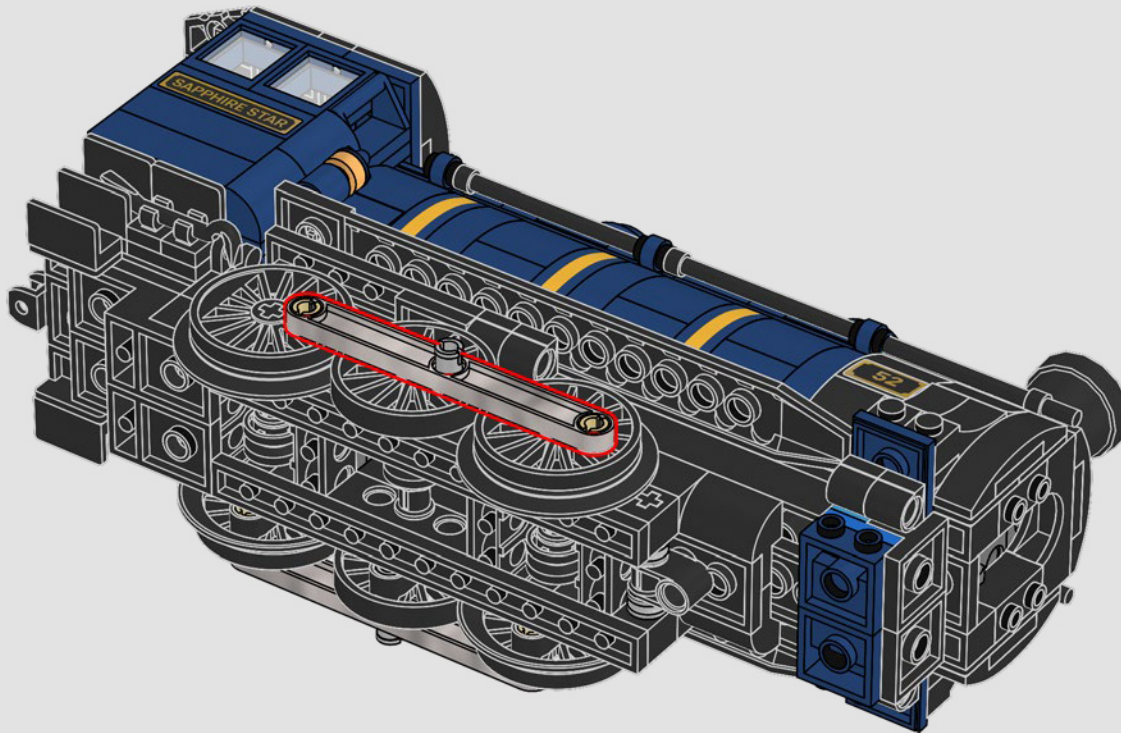

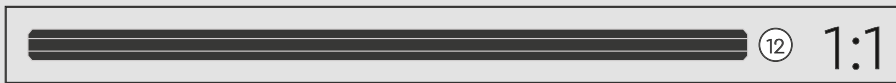
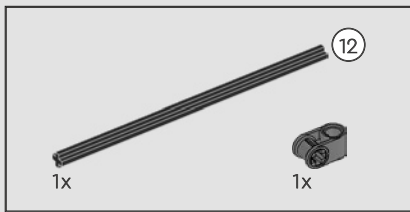

432

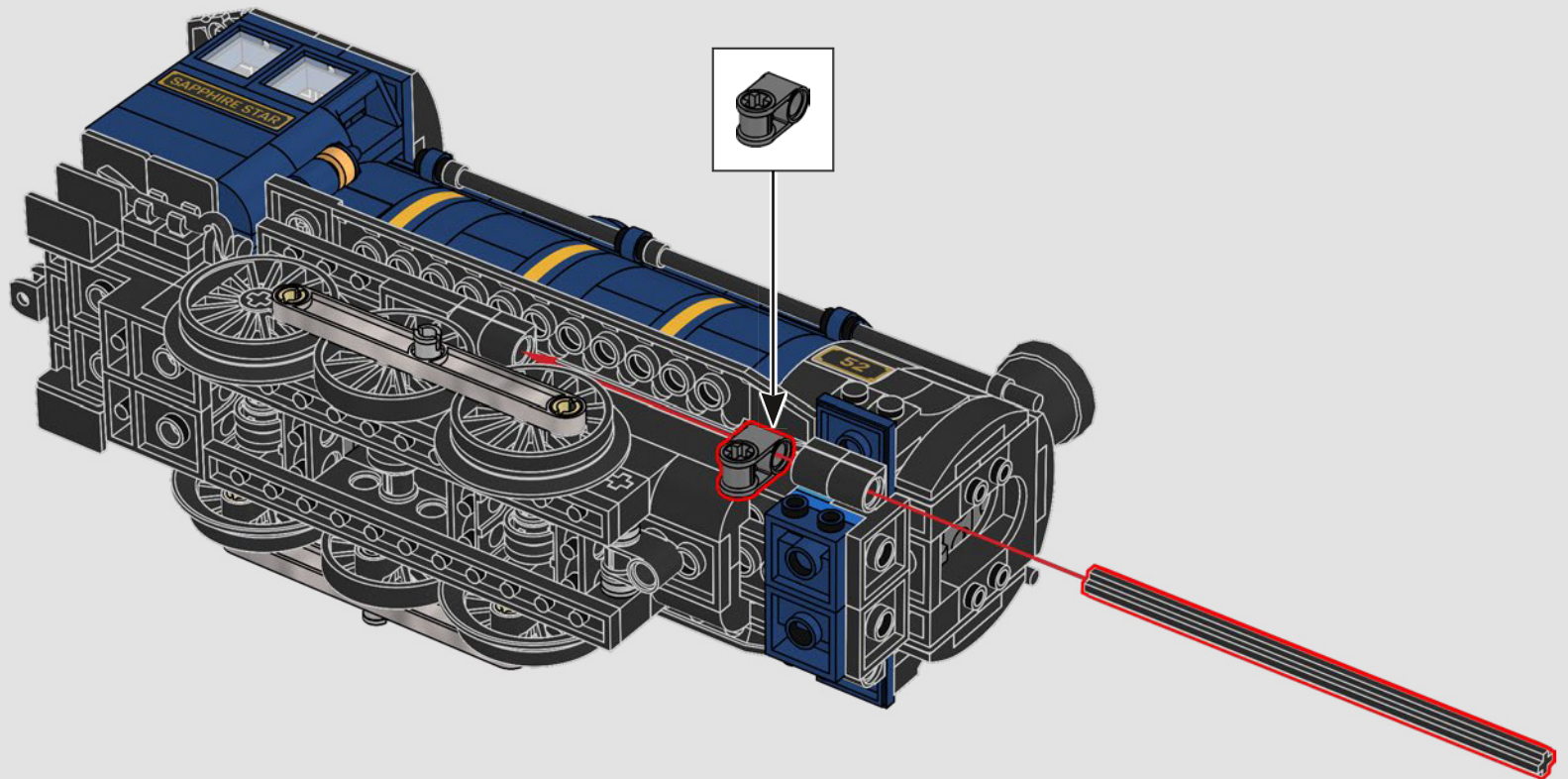

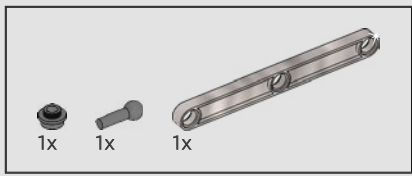

433

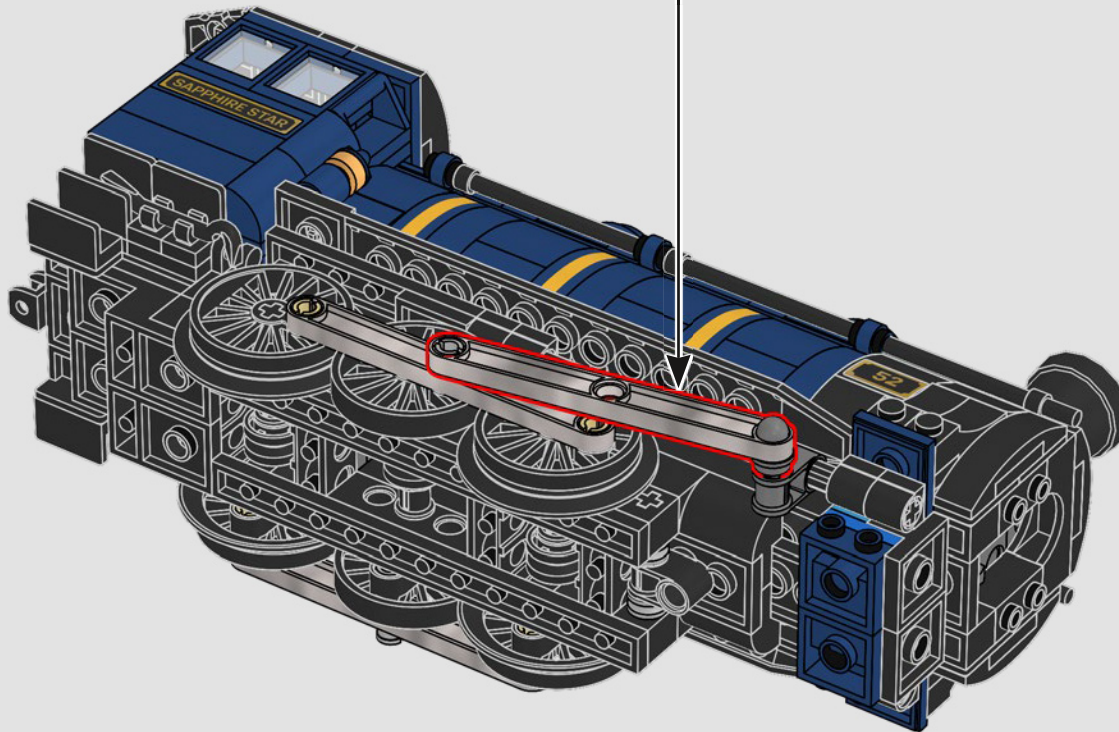
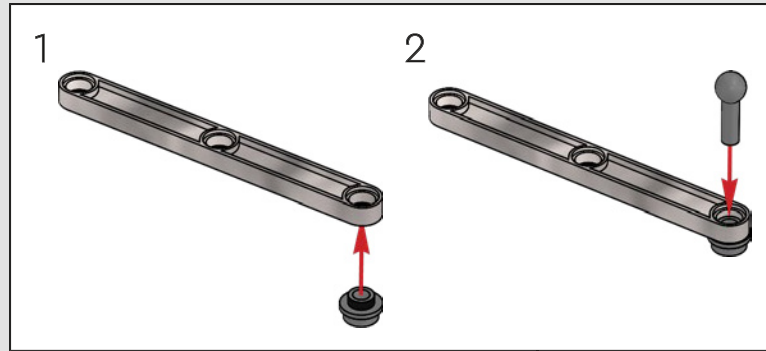

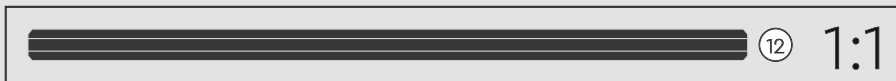
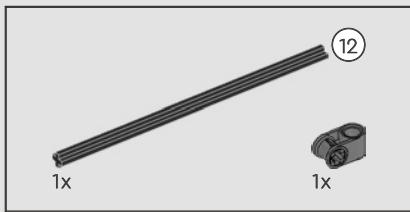

434

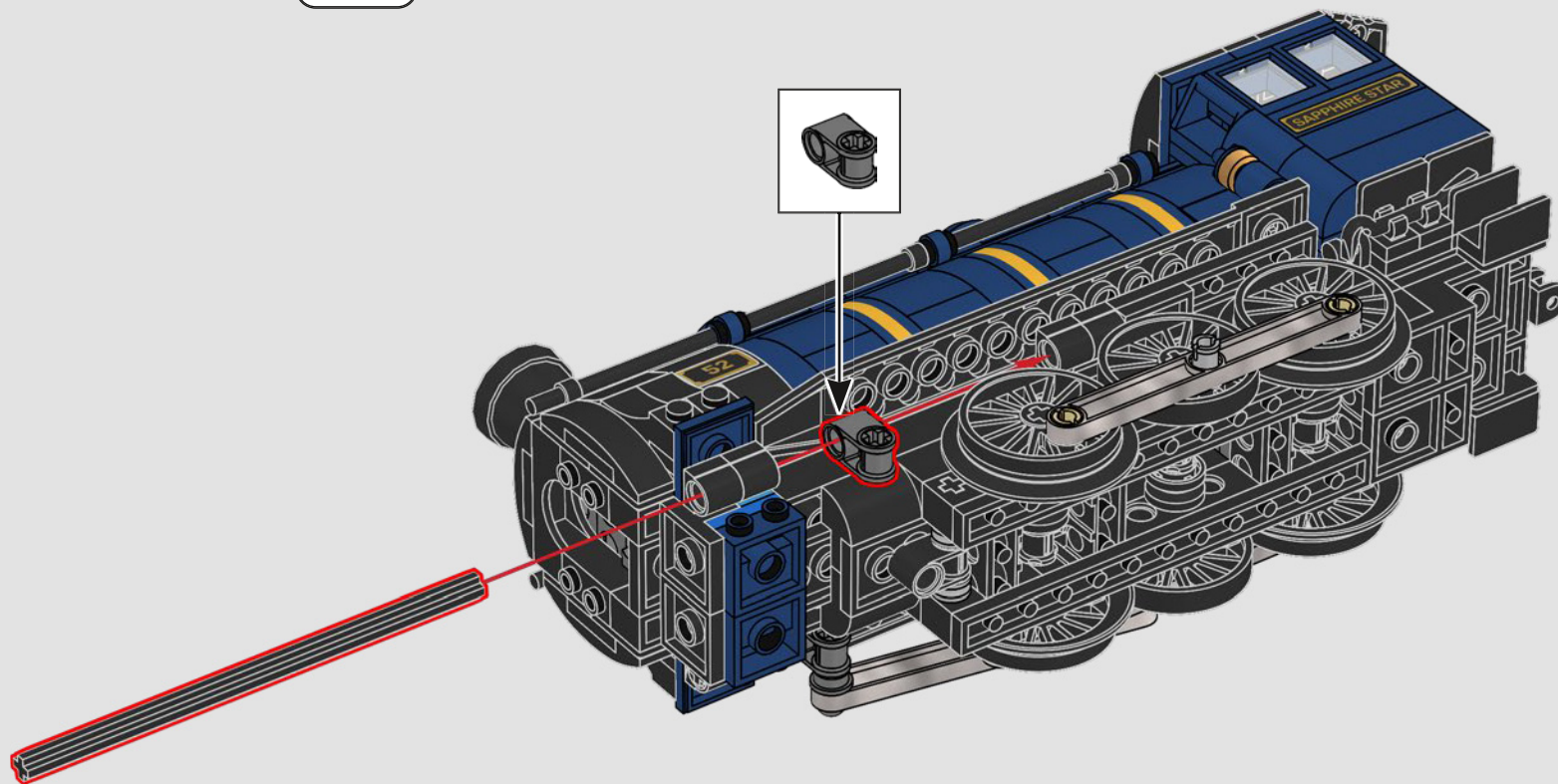

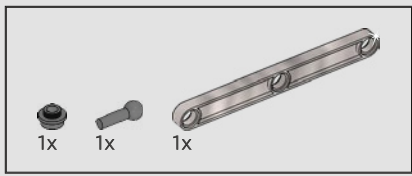

435

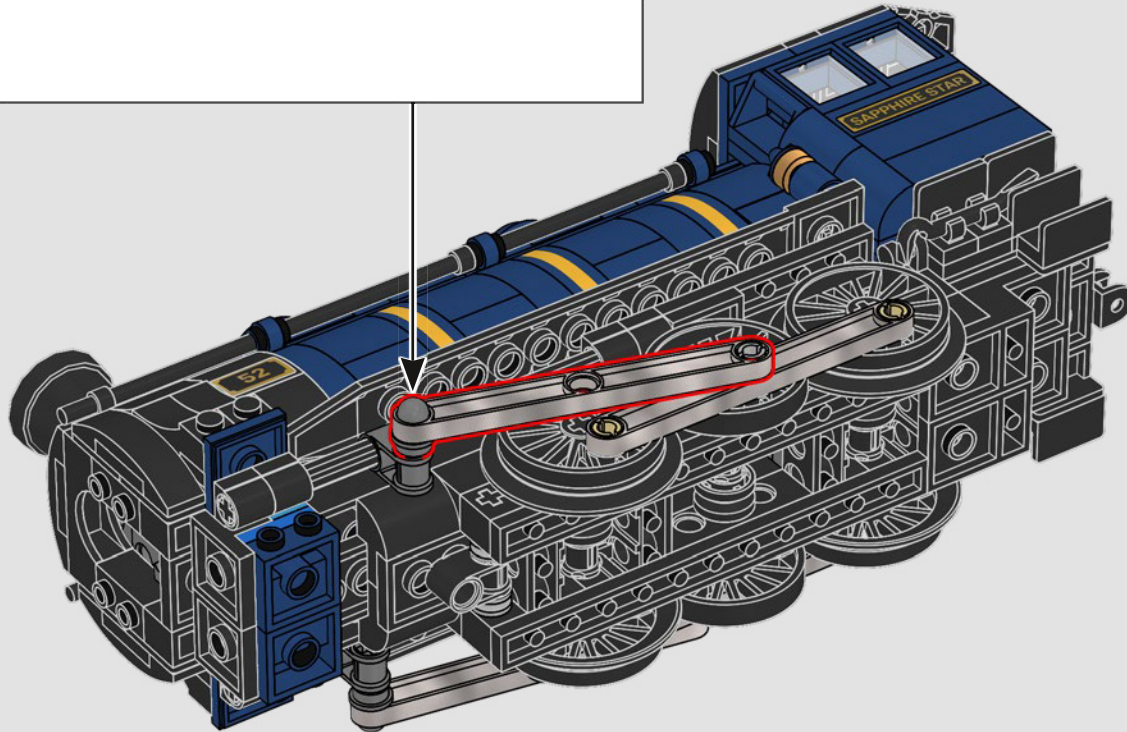
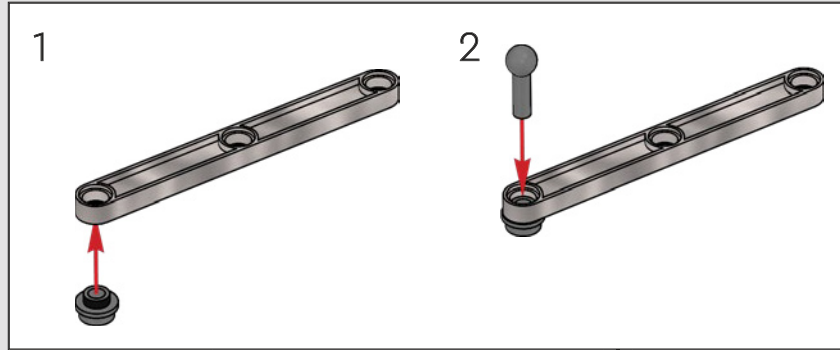

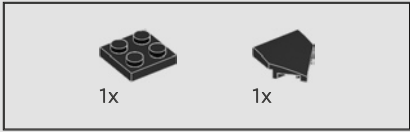
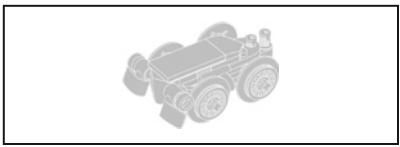

436

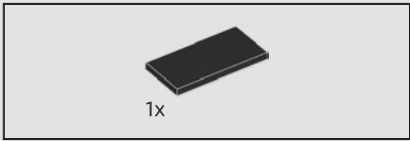
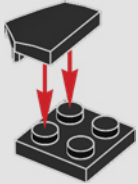

437

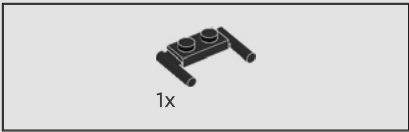
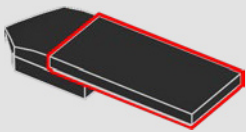

438

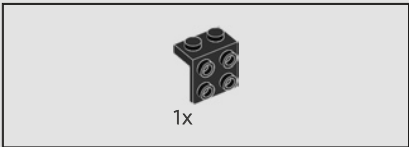
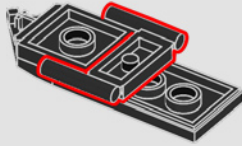

439

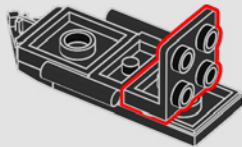

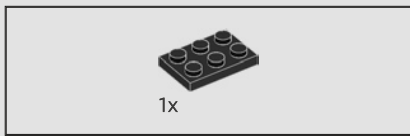

440

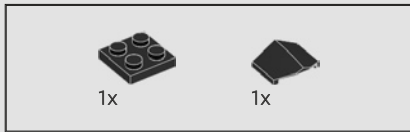
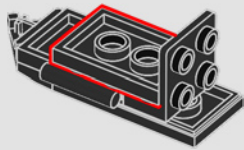

441

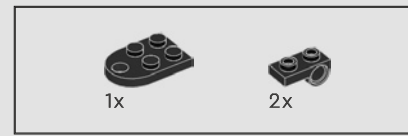
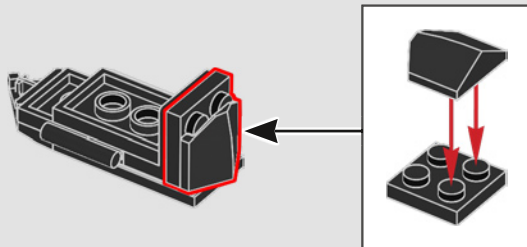

442

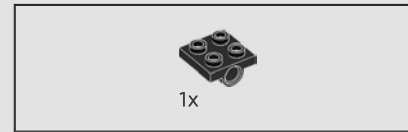
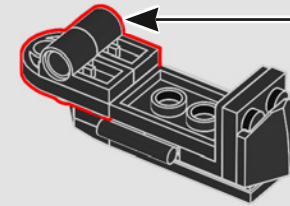
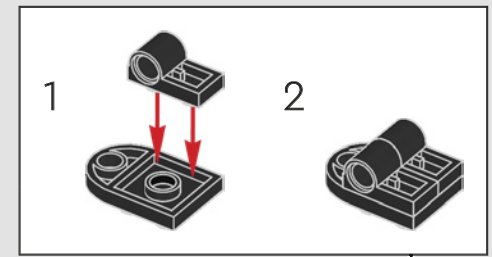

443

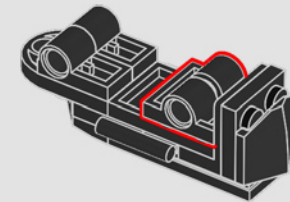

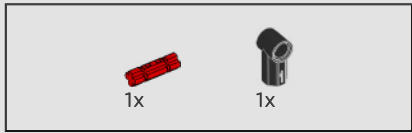
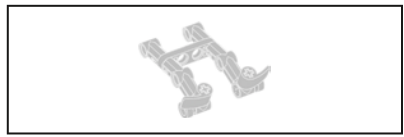

444

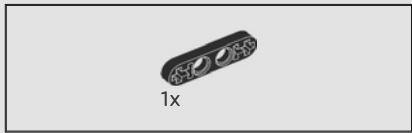
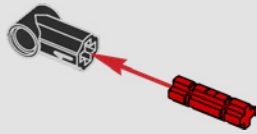

445

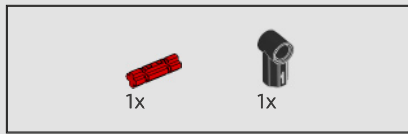

446

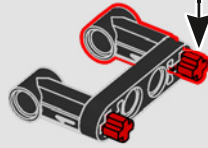
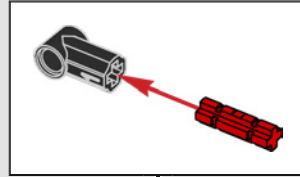

447

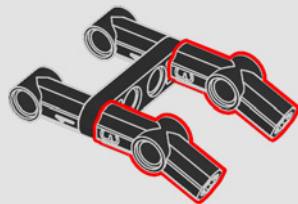

448

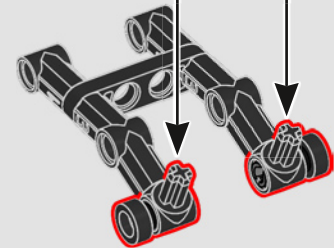
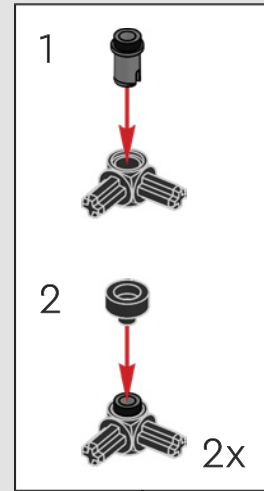



449

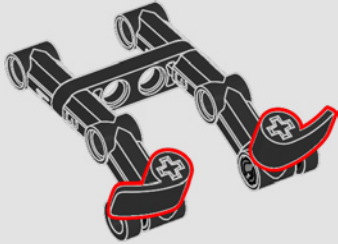

450

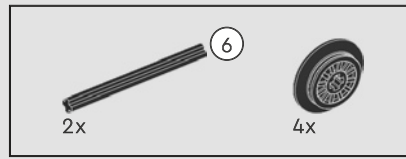
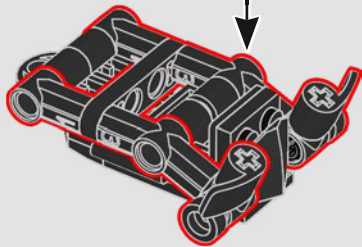

451

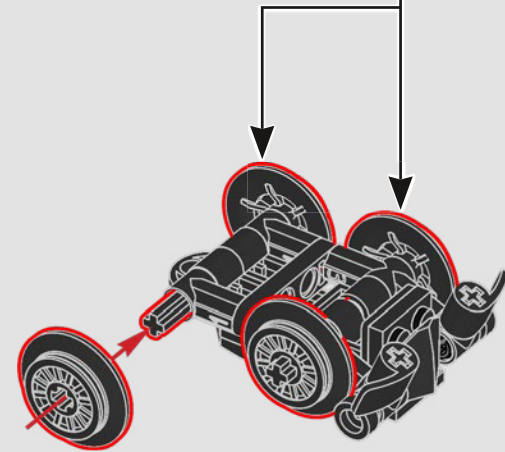
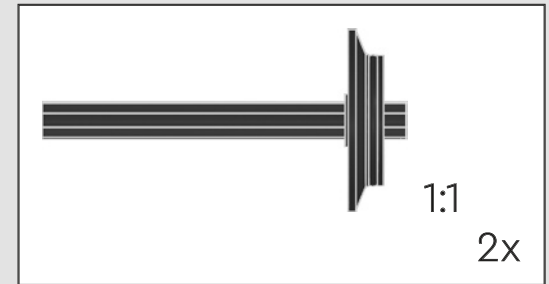
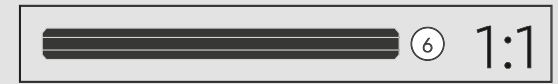

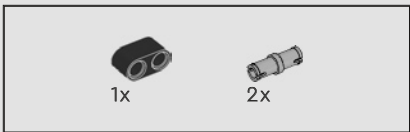

452

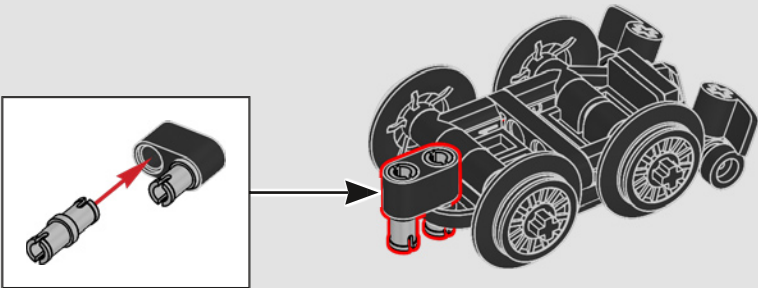

453

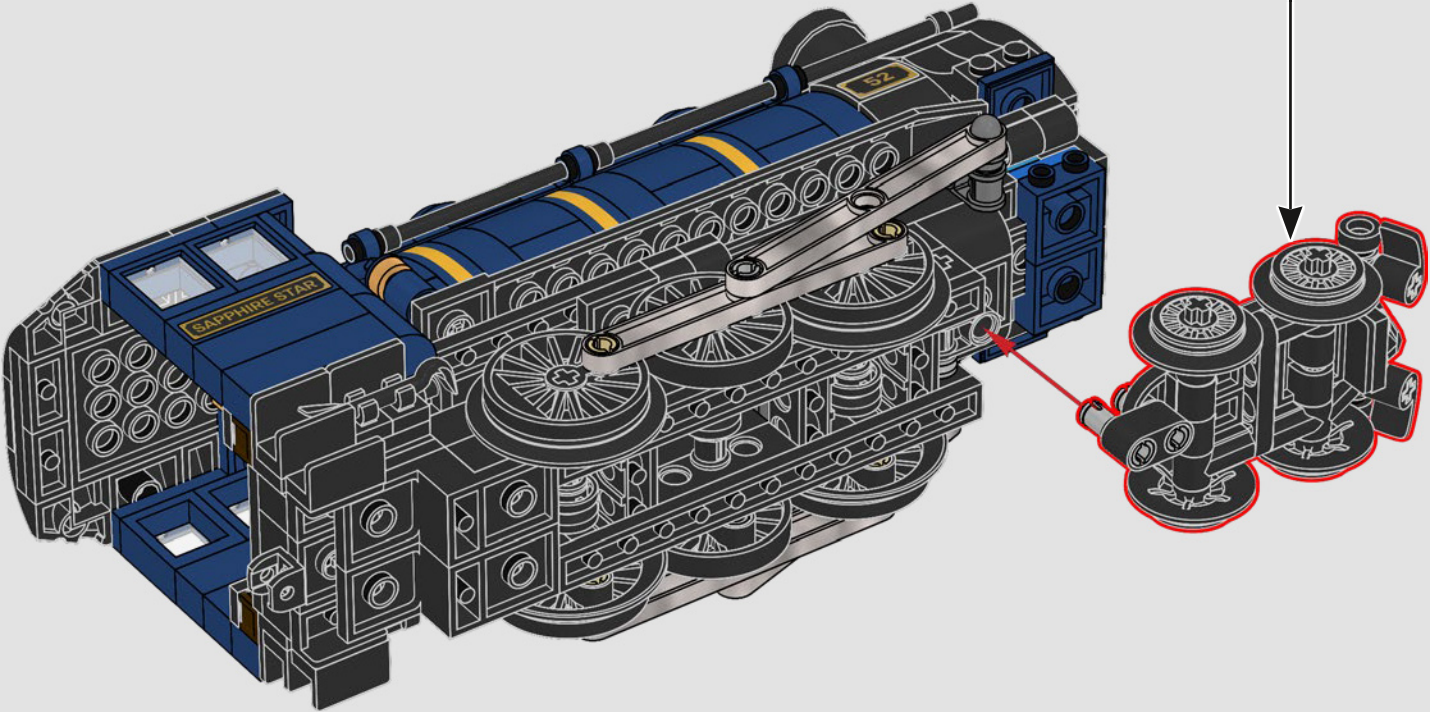

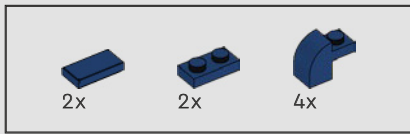

454

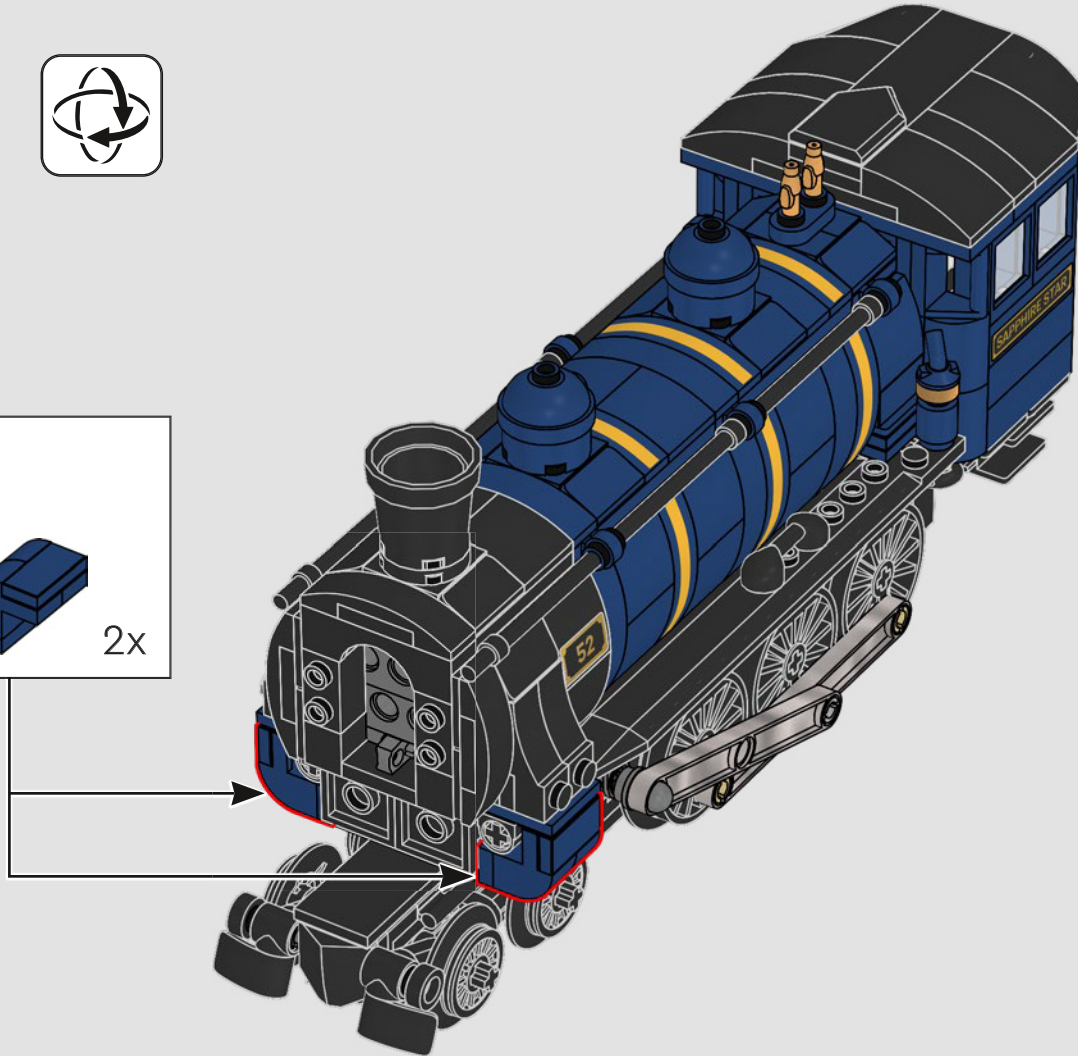
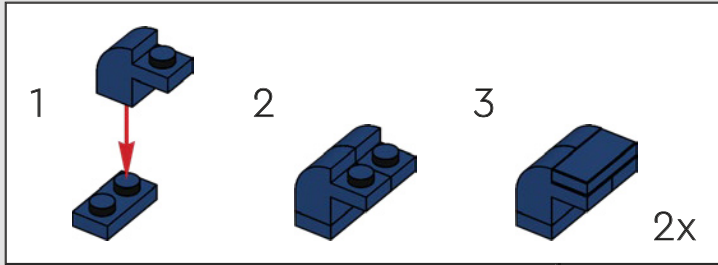

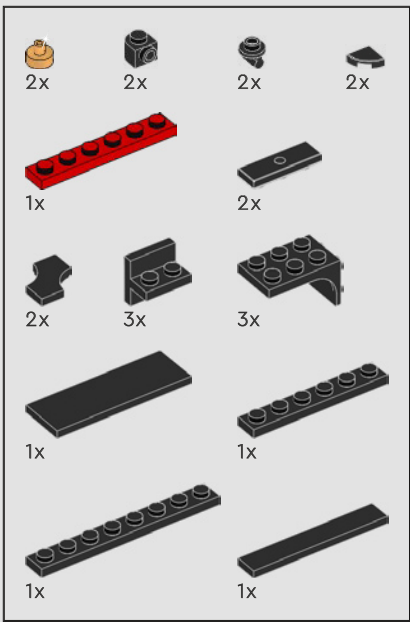

455

1

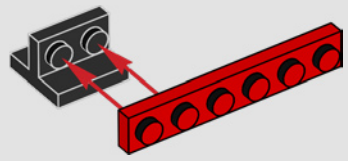

2

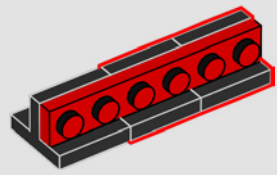

3

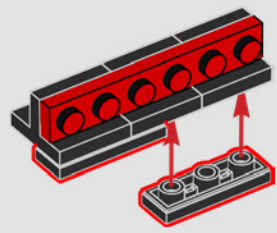

4

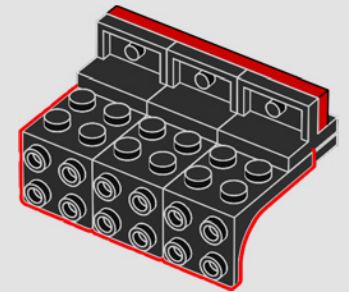

5

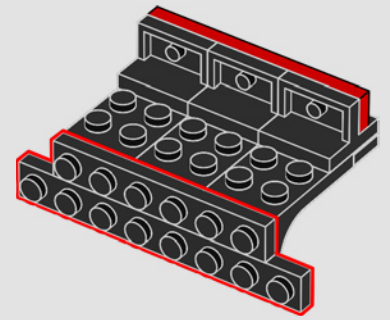

6

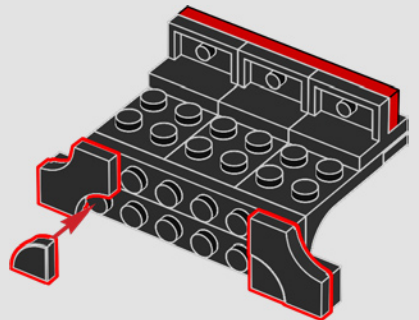

7

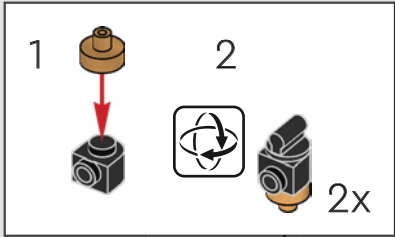
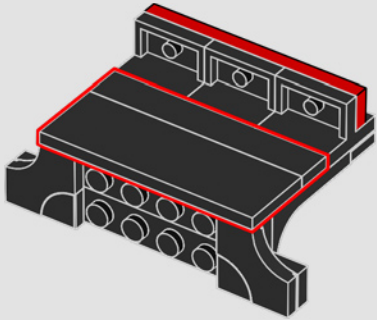

8

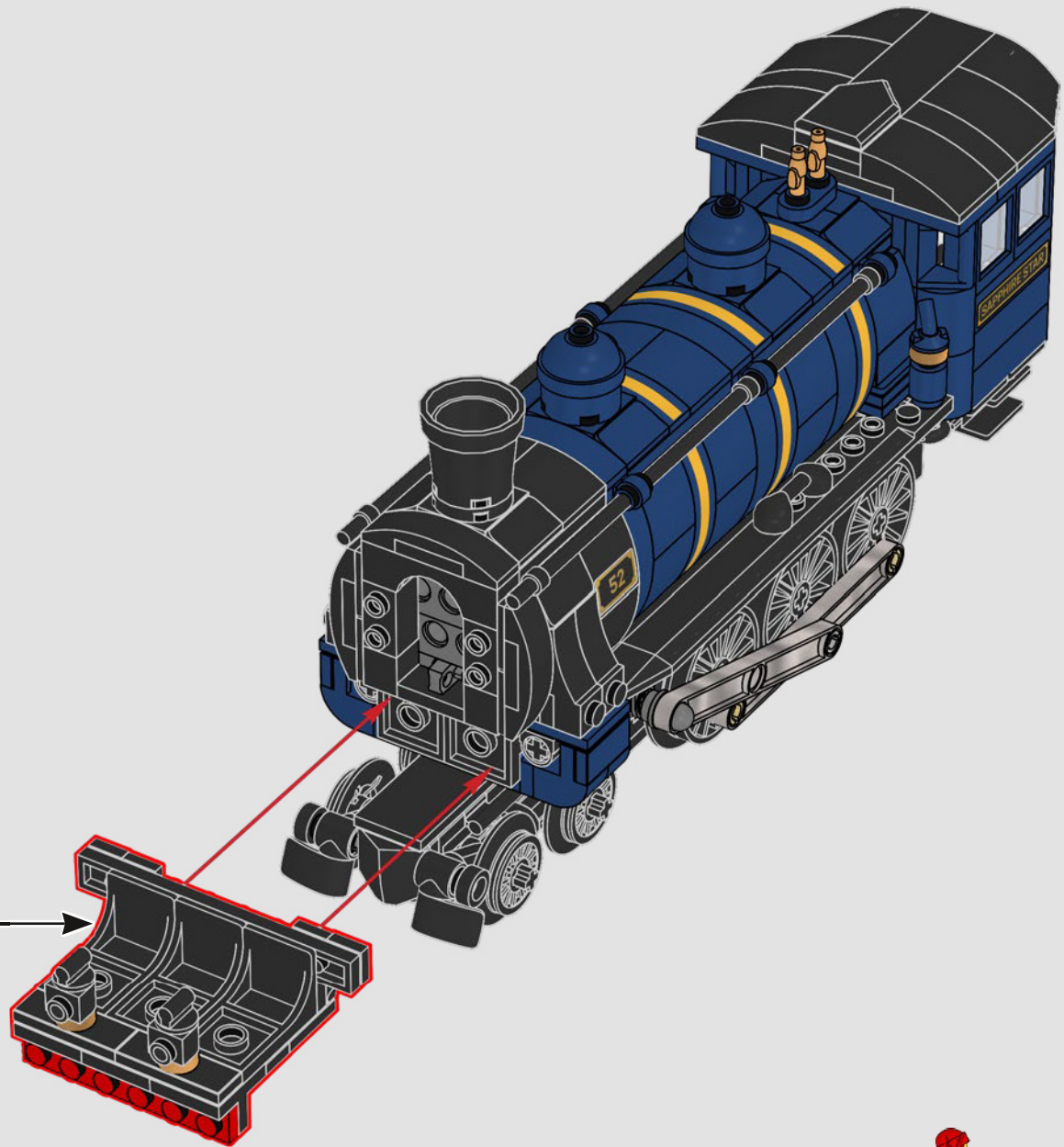
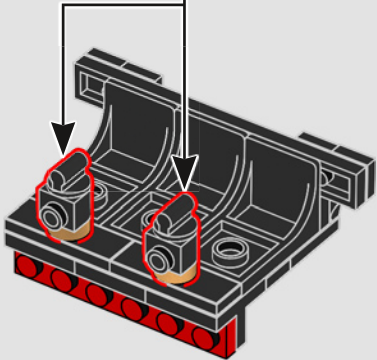

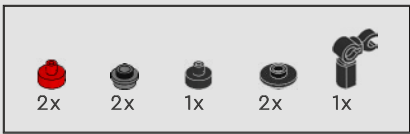

456

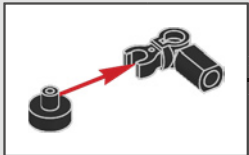
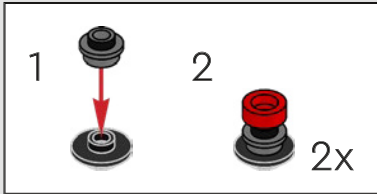
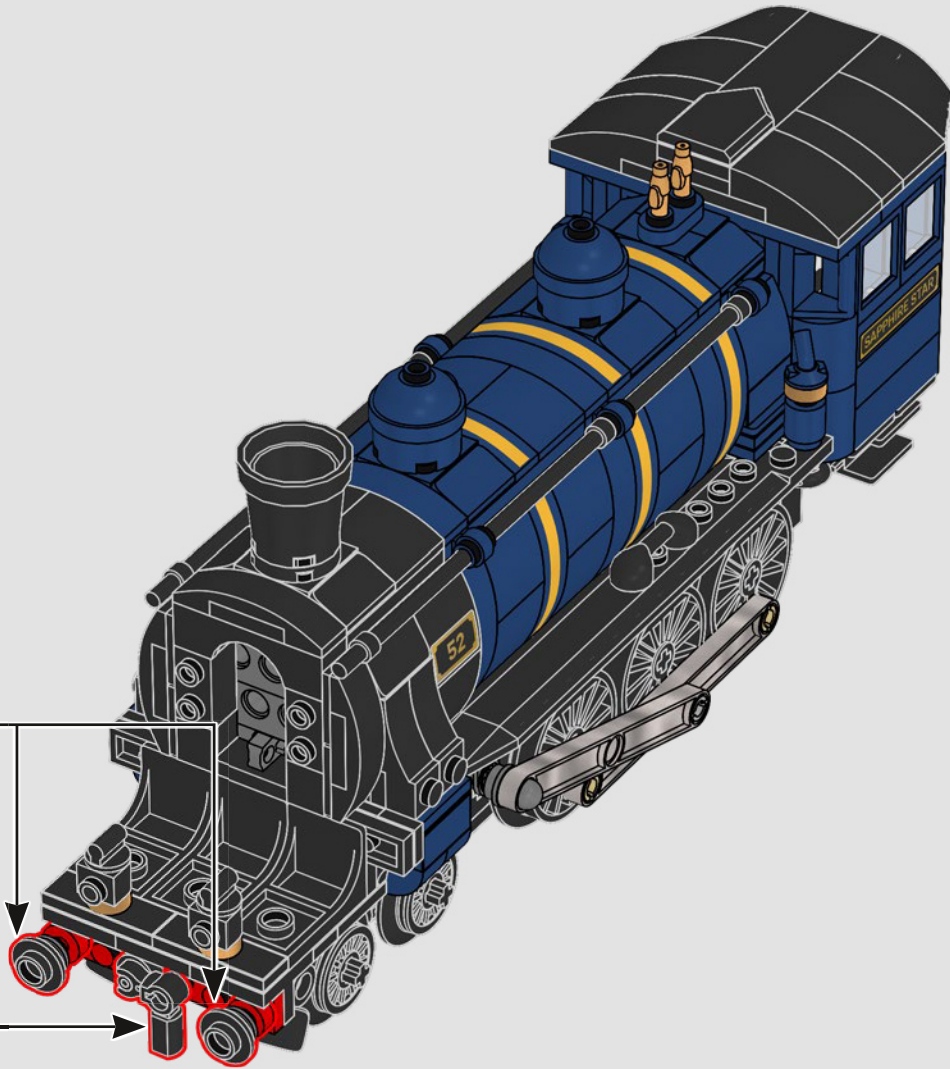

Destino: ESTAMBUL

"La última parada. ¡Desde aquí puedes conseguir transporte hacia lugares exóticos como Bagdad, El Cairo, Teherán, Jerusalén o Bombay!".

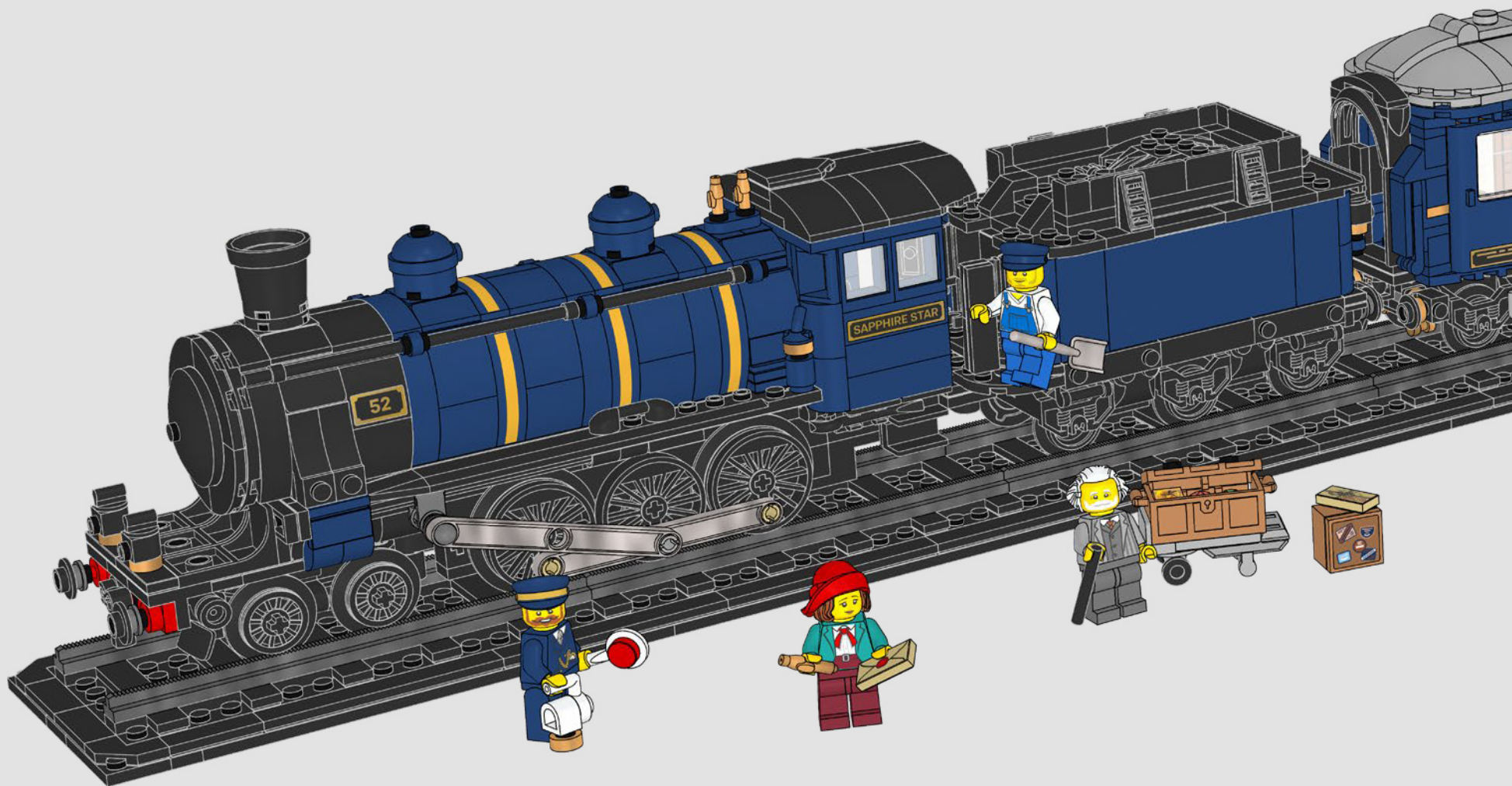

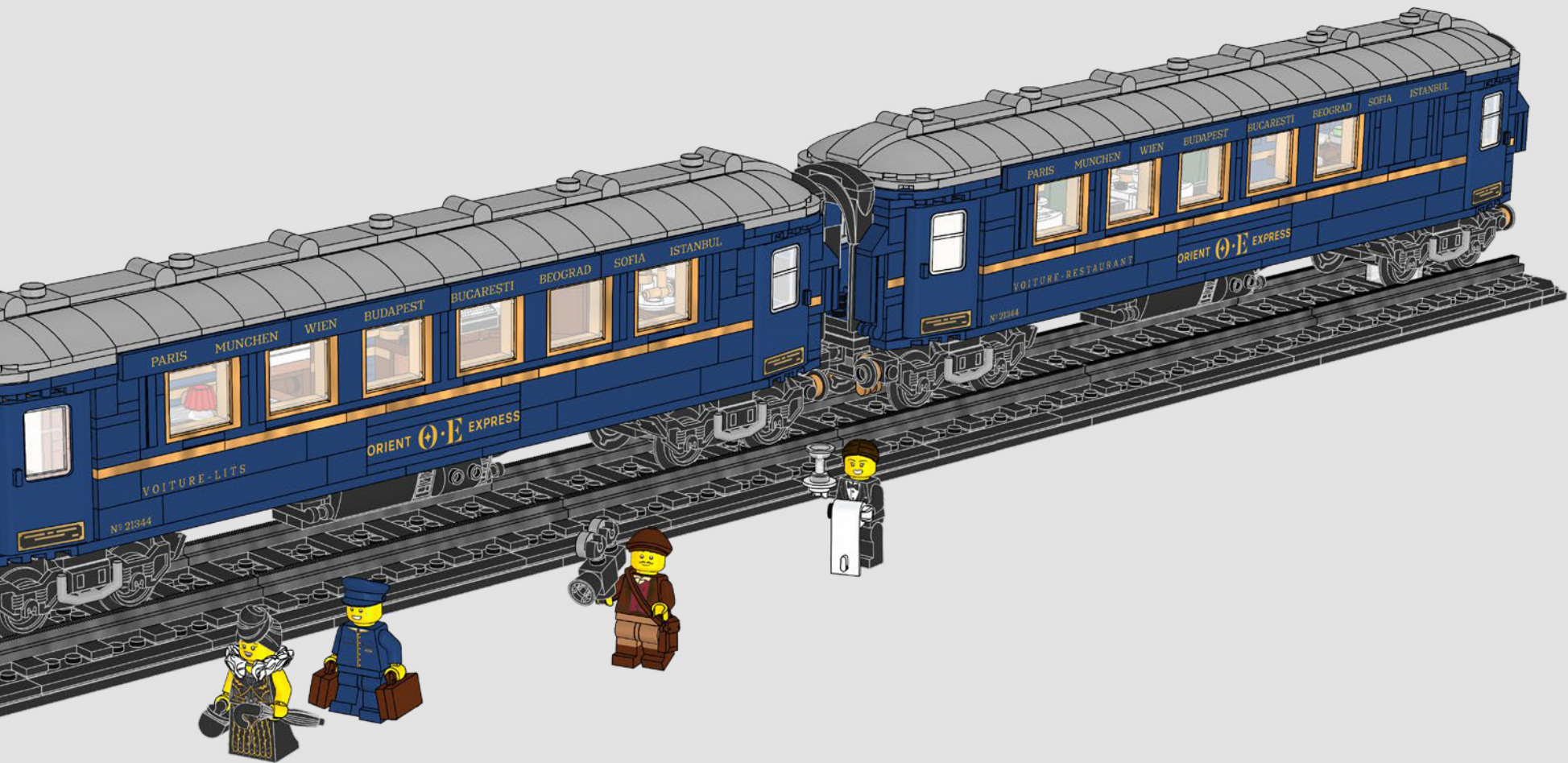



IDEAS

GATHER SUPPORT
HOL DIR UNTERSTÜTZUNG
RECUEILLEZ DES VOTES
CHIEDI DI ESSERE SUPPORTATO
CONSIGUE APOYOS
OBTÉM APOIO
争取支持
ZDOBĄDŹ GŁOSY

ZÍSKEJTE PODPORU
ZÍSKAJTE PODPORU
SZEREZZ TÁMOGATÁST!
CERE SPRIJIN
ПОЛУЧЕТЕ ПОДКРЕПА
IEGŪSTI ATBALSTU
KOGU TOĒTUST
RINK PALAIKYMĄ

SHARE YOUR IDEA
TEILE DEINE IDEE
PARTAGEZ VOTRE IDÉE
CONDIVIDI LA TUA IDEA
COMPARTÉ TU IDEA
PARTILHA A TUA IDEIA
分享创意
PODZIEL SIĘ POMYSŁEM

SDÍLEJTE SVÉ NÁPADY
ZDIEĽAJTE SVOJE NÁPADY
OSZD MEG AZ ÖTLETED!
ÎMPĂRȚĂȘEȘTE IDEEA TA
СПОДЕЛЕТЕ ИДЕИТЕ СИ
PARĀDI SAVU IDEJU
JAGA OMA IDEED
PASIDALINK SAVO IDĒJA

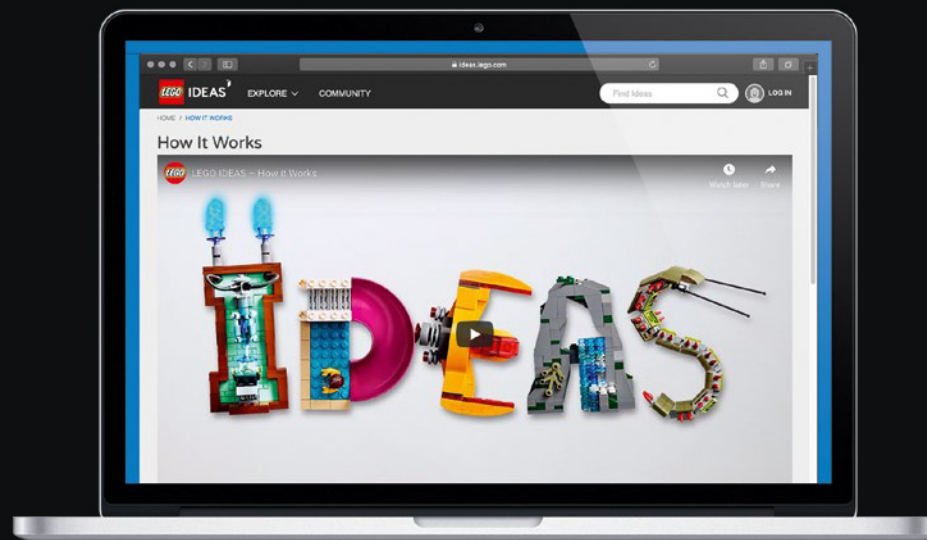
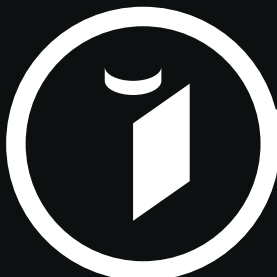
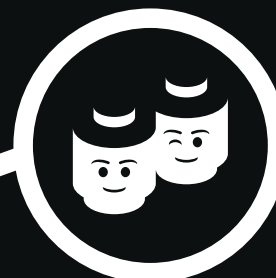

LEGO® REVIEW
LEGO® PRÜFUNG
EXAMEN PAR LEGO®
REVIEW LEGO®
REVISIÓN DE LEGO®
AVALIAÇÃO LEGO®
乐高®审核
OCENA LEGO®

OUZENÍ DESIGNÉRY LEGO®
POSÚDENÉ DIZAJNÉRMÍ LEGO®
LEGO® VÉLEMÉNYEZÉS
VERIFICARE LEGO®
ПРЕГЛЕД НА LEGO®
LEGO® RECENZIIA
LEGO® ARVUSTUS
LEGO® APŽVALGA

NEW LEGO® PRODUCT
NEUES LEGO® PRODUKT
NOUVEAU PRODUIT LEGO®
NUOVO PRODOTTO LEGO®
NUEVO PRODUCTO LEGO®
NOVO PRODUTO LEGO®
全新乐高®产品
NOWY PRODUKT LEGO®



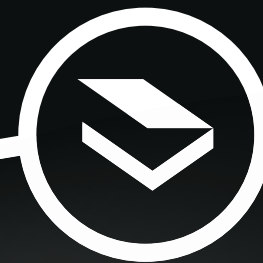























































































NOVÁ STAVEBNICE LEGO®
NOVÁ STAVEBNICA LEGO®
ÚJ LEGO® TERMÉK
PRODUS LEGO® NOU
НОВ ПРОДУКТ LEGO®
JAUNS LEGO® PRODUKTS
UUS LEGO® TOODE
NAUJAS LEGO® PRODUKTAS



ideas.LEGO.com

1x 407001	1x 6434569	1x 474001	1x 4114084	4x 306223	1x 6123730	16x 306226	1x 6181713	1x 4177444	5x 301026	4x 303226
1x 4558952	3x 302301	1x 6172674	1x 6257600	2x 6055065	1x 6218310	2x 6436425	2x 6369578	1x 6261371	4x 371026	14x 303426
1x 6321349	1x 302201	2x 4537987	1x 6352222	2x 6092582	1x 6384058	2x 6344819	1x 6308912	2x 6396456	8x 6254045	3x 346026
1x 6218823	2x 6126046	1x 4527637	2x 6174925	12x 302223	1x 6384051	4x 4548180	4x 6211476	4x 302426	8x 243126	3x 346026
1x 6218823	1x 6415097	1x 6219621	4x 6013938	1x 6315482	1x 6434805	1x 6323421	2x 6458098	110x 302326	8x 243126	3x 346026
2x 6383982	1x 4558168	1x 6334236	2x 6215539	4x 6315482	1x 6288000	2x 6267487	4x 4200023	6x 306926	10x 302026	4x 447726
1x 306201	7x 6195371	1x 390001	1x 6284574	1x 9341	1x 6372016	1x 6273589	6x 6053077	4x 241226	3x 4560182	4x 303526
2x 6442360	7x 302101	6x 6475151	1x 6465499	4x 300423	1x 6352820	1x 6181720	1x 6390748	2x 421226	1x 6076678	2x 6037390
1x 6050914	1x 6446788	4x 6235083	4x 6454454	2x 4558606	6x 6186675	4x 6138173	4x 6328095	4x 242026	1x 663626	4x 4514845
2x 4547489	1x 6348055	1x 6396958	2x 4142865	4x 301023	26x 407026	2x 265326	2x 4251161	19x 302226	3x 366626	2x 611226
1x 6213880	1x 6437184	4x 6238334	2x 6397571	8x 447723	13x 6228987	2x 4162443	1x 6390749	20x 6192346	5x 4243819	2x 244526
2x 6258135	2x 6168618	2x 4114026	1x 6284163	1x 362321	1x 4214559	2x 370126	4x 6147790	2x 6133722	2x 6318582	18x 428226
1x 6213881	6x 6449595	1x 6284163	1x 6455324	1x 6217123	2x 300426	2x 6039194	7x 4613153	8x 4558170	2x 379526	8x 6094066
2x 6248827	2x 6132203	4x 6286329	1x 6286329	1x 383223	2x 235726	2x 365926	2x 365926	6x 6199908	2x 379526	
1x 6285777	1x 6093053	1x 6375672	1x 6455324	7x 300121	2x 235726	2x 365926	2x 365926	5x 302126	2x 379526	
3x 6299937	2x 6023806	1x 4113916	1x 4113916	1x 366621	3x 300326	2x 6222427	4x 4587844	5x 6162892	82x 416226	

- 17x 4255413
- 40x 4249891
- 2x 6454453
- 4x 6228123
- 4x 6453215
- 22x 6233955
- 13x 4264569
- 1x 6275133
- 2x 6463543
- 4x 6465404
- 2x 6463544
- 12x 6277303
- 1x 6224377
- 4x 6256616
- 2x 6429965
- 5x 6135606
- 2x 4177741
- 6x 6216905
- 8x 6186683
- 1x 6214811
- 1x 6214812
- 12x 6384915
- 4x 6411363
- 16x 6061569
- 9x 6037886
- 9x 6453216
- 4x 6464198
- 62x 4184108
- 2x 6092588
- 32x 4528981
- 20x 4528488
- 12x 6037890
- 2x 4205004
- 8x 6132566
- 41x 4177735
- 7x 4502089
- 1x 6256610
- 4x 4569836
- 5x 6384913
- 2x 4508313
- 4x 6453208
- 12x 6250216
- 4x 6453207
- 8x 4507080
- 4x 6453209
- 4x 6453210
- 5x 6027627
- 4x 6106692
- 12x 6200663
- 2x 6429734
- 2x 6454464
- 8x 6120642
- 7x 6328107
- 2x 6097457
- 2x 6224472
- 2x 6371455
- 20x 6464203
- 2x 6470186
- 4x 6407191
- 1x 6236571
- 8x 4502091
- 8x 4529954
- 8x 6251836
- 4x 6382723
- 1x 6253883
- 8x 6450823
- 4x 6254479
- 2x 6409752
- 1x 6410902
- 2x 6391515
- 2x 4162916
- 1x 6463580
- 1x 6409766
- 4x 6454450
- 4x 6454451
- 4x 6315608
- 1x 6435099
- 1x 6308322
- 1x 6252040
- 8x 6171727
- 4x 4538760
- 2x 4210762
- 1x 4213607
- 1x 4211000
- 2x 6336390
- 1x 6266248
- 4x 6350292
- 8x 4225733
- 6x 6231765
- 1x 4222693
- 2x 6261374
- 4x 4211063
- 1x 4211055
- 2x 4211043
- 4x 4211065
- 4x 4211002
- 2x 6313652
- 2x 4211067

 2x 6258831	 5x 6171894	 1x 6146223	 1x 6201911	 2x 6253167	 2x 6149677	 1x 6236915
 10x 6284071	 4x 4211396	 1x 6468371	 1x 6468374	 1x 6397820	 5x 6341553	 4x 6172636
 4x 4211386	 16x 4211445	 1x 6195471	 1x 6408343	 2x 6322211	 2x 6238874	 12x 6168623
 2x 6123809	 4x 4211395	 1x 6152344	 2x 6268857	 3x 6311210	 4x 6226436	 1x 4211159
 8x 6407412	 8x 4560183	 1x 6195471	 1x 6270078	 16x 6172922	 1x 6290983	 1x 6037289
 24x 6262085	 1x 6402193	 8x 4644102	 2x 6329114	 1x 6365885	 2x 6251470	 1x 6102360
 8x 4251163	 4x 4211425	 4x 4494475	 6x 4211242	 2x 6409552	 1x 4211190	 1x 6342958
 76x 6132207	 4x 4211425	 2x 6271165	 2x 6177699	 2x 6299939	 6x 6257604	 2x 4283660
 2x 4211435	 2x 4211407	 4x 4211807	 2x 4211180	 2x 6325975	 2x 4211186	 1x 6228841
 4x 4211397	 4x 4211401	 1x 6134378	 5x 4211149	 2x 4211288	 1x 4579690	 1x 6424037
 10x 6126082	 4x 4211486	 2x 6420741	 2x 4211210	 2x 4221744	 1x 4211204	 1x 6398342
		 8x 6163990	 2x 4211225	 5x 4211151	 1x 4221590	 1x 6063447
		 4x 4211725	 2x 4211193	 1x 4211257	 2x 6326103	 4x 6291040
				 7x 6196221	 8x 6055145	 3x 6064188

2x
6395635

2x
6364352

3x
6464199

12x
6218047

4x
4490599

22x
6186672

2x
6335111

8x
6212377

2x
6338242

30x
6449109



 [LEGO.com/service](https://www.LEGO.com/service)

2x
6375358

1x
6372427

7x
6190252

1x
6400656

1x
6327553

1x
6477142

1x
6173139

1x
6056774

8x
6083975

1x
6370621

2x
6452472

1x
4585493

23x
6459521

1x
6451126

2x
6310366

4x
6296061

3x
6102990

2x
6433733

1x
6435640

1x
6467618

1x
6435310

1x
6394960

1x
6102984

2x
6287309

12x
6275872

8x
4653988

4x
6424641

8x
6346764

7x
6133728

4x
6250001

3x
6210675

2x
6337197

4x
6453350

1x
6210601

18x
6454456

1x
4653970

2x
6348142

4x
6335566

6x
6119107

2x
4619513

2x
4625036

9x
6146926

2x
6411330

1x
4583299

1x
4541496

4x
6411595



YOU COULD WIN



YOU COULD WIN

Your feedback will help shape the future development of this product series.

Visit:

DU KÖNNTEST GEWINNEN

Dein Feedback trägt zur Weiterentwicklung dieser Produktreihe bei.

Geh auf:

VOUS POURRIEZ GAGNER

Vos commentaires nous aideront à concevoir les futurs produits de cette gamme.

Visitez :

POTRESTI VINCERE TU

La tua opinione ci aiuterà a migliorare la creazione futura di questa linea di prodotti.

Visita:

PUEDES GANAR

Tu opinión contribuirá al futuro de esta serie de productos.

Visita:

轻松获奖

您的反馈将有助于我们在今后改进本产品系列。

请访问:

[LEGO.com/productfeedback](https://www.lego.com/productfeedback)

You also have the chance to win a LEGO® set.

Terms and conditions apply.*

Außerdem hast du die Chance, ein LEGO® Set zu gewinnen.

Es gelten die Teilnahmebedingungen.*

Vous pourriez également gagner un ensemble LEGO®.

Des conditions s'appliquent.*

Hai anche la possibilità di vincere un set LEGO®.

Termini e condizioni sono applicabili.*

También tienes la oportunidad de ganar un set LEGO®.

Aplican términos y condiciones.*

您还有机会赢取乐高®套装。

条款和条件适用。*

*[LEGO.com/productfeedback-terms](https://www.lego.com/productfeedback-terms)

ORIENT EXPRESS



LEGO and the LEGO logo are trademarks of the LEGO Group. ©2023 The LEGO Group.
ORIENT EXPRESS™ is a registered trade mark of Orient Express. All rights reserved.