



NINJAGO

Masters of Spinjitzu



2508



1

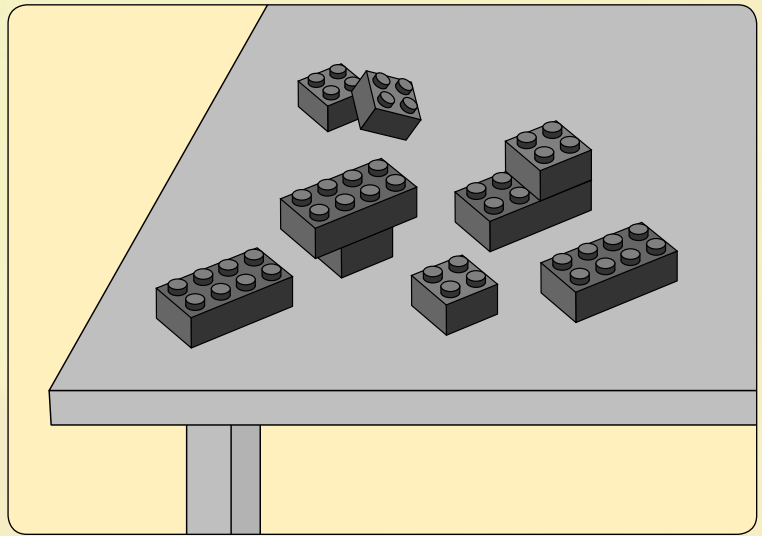
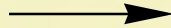
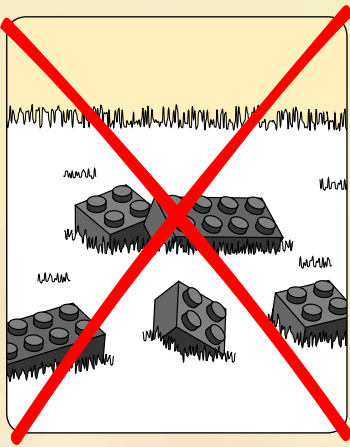

2

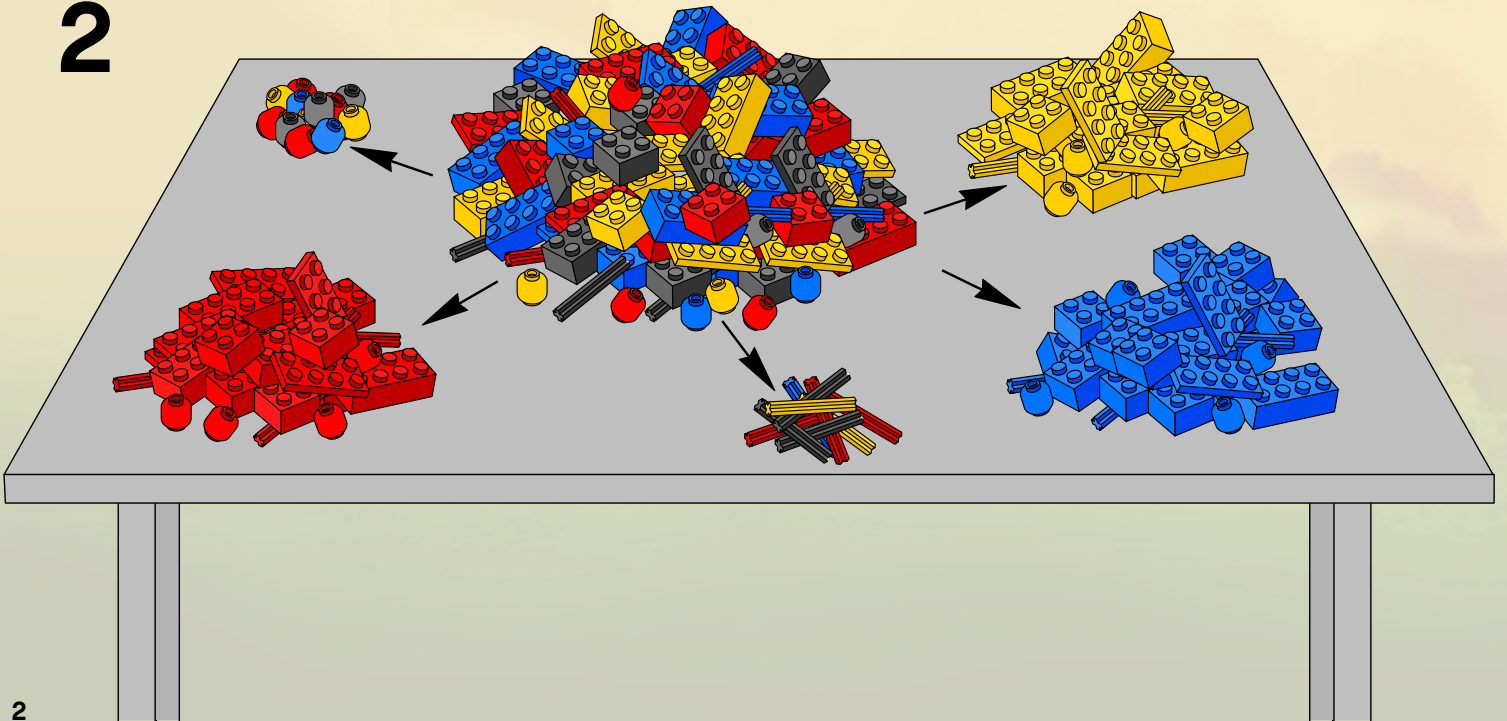

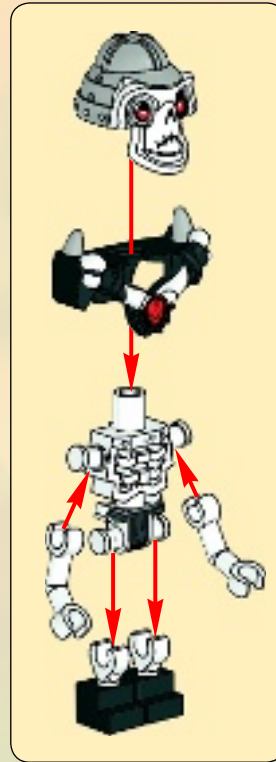
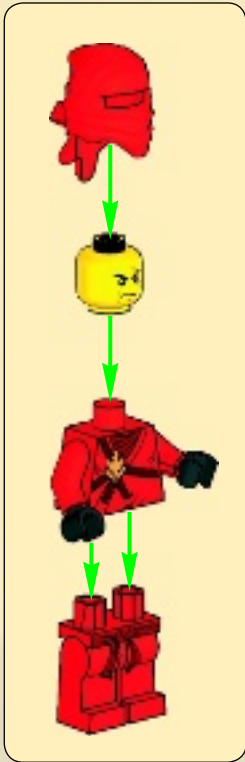

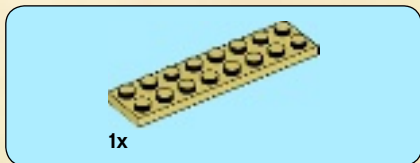
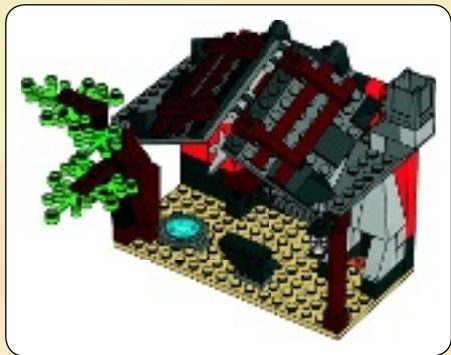

1

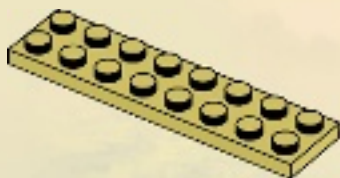

2

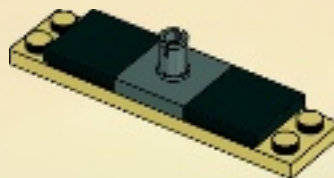



3

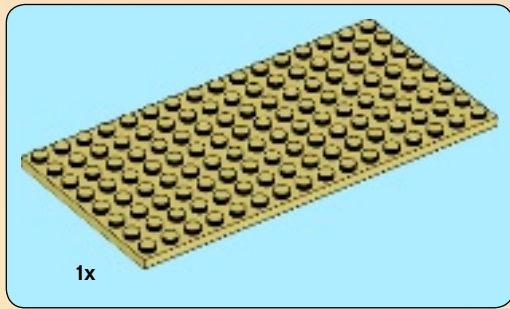
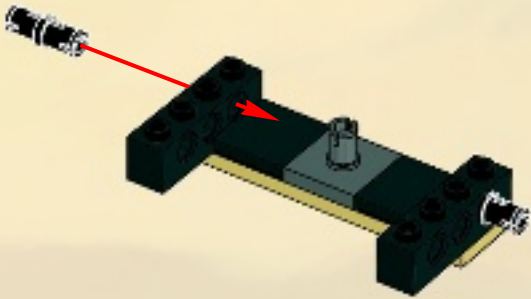

4

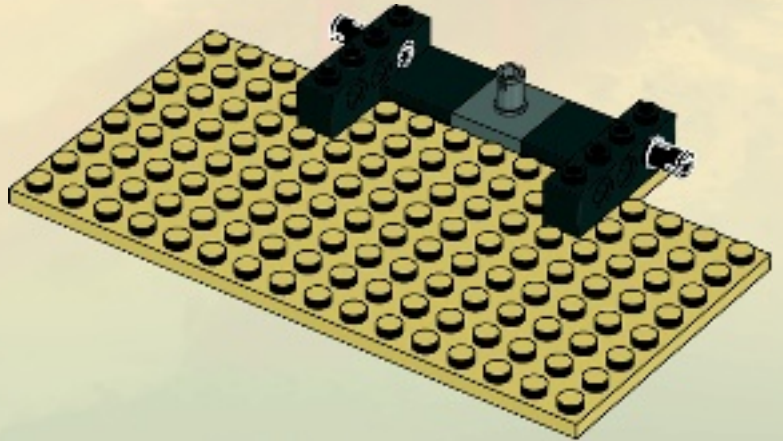



5

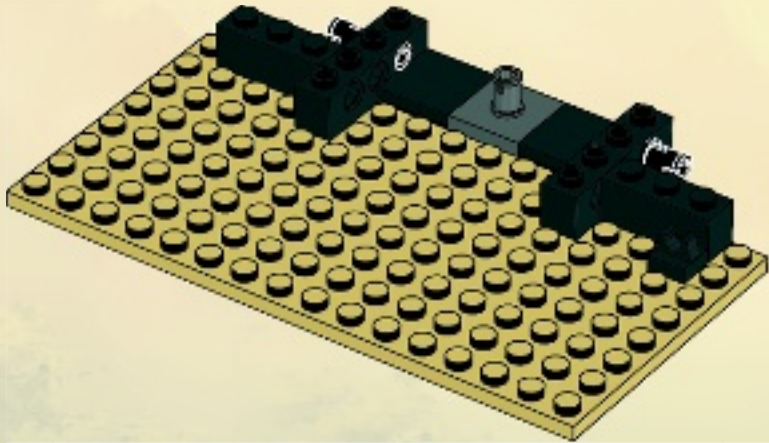



2x



1x

6

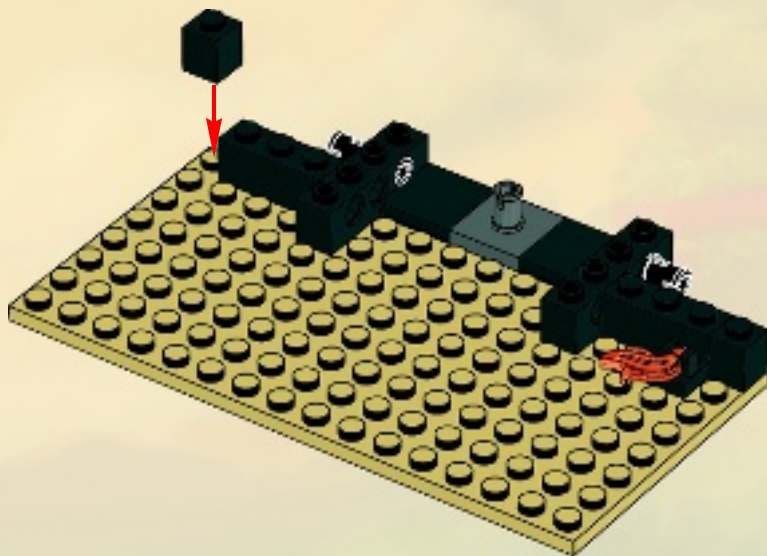



2x

7

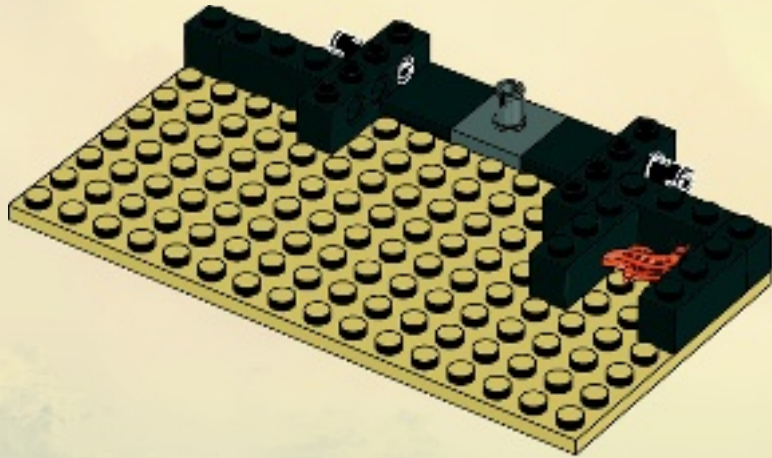

8



2x



2x

8

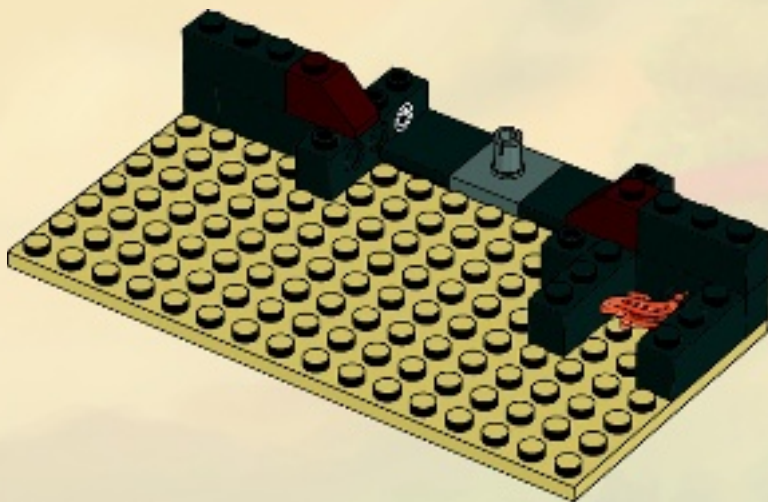



12x

9



2x

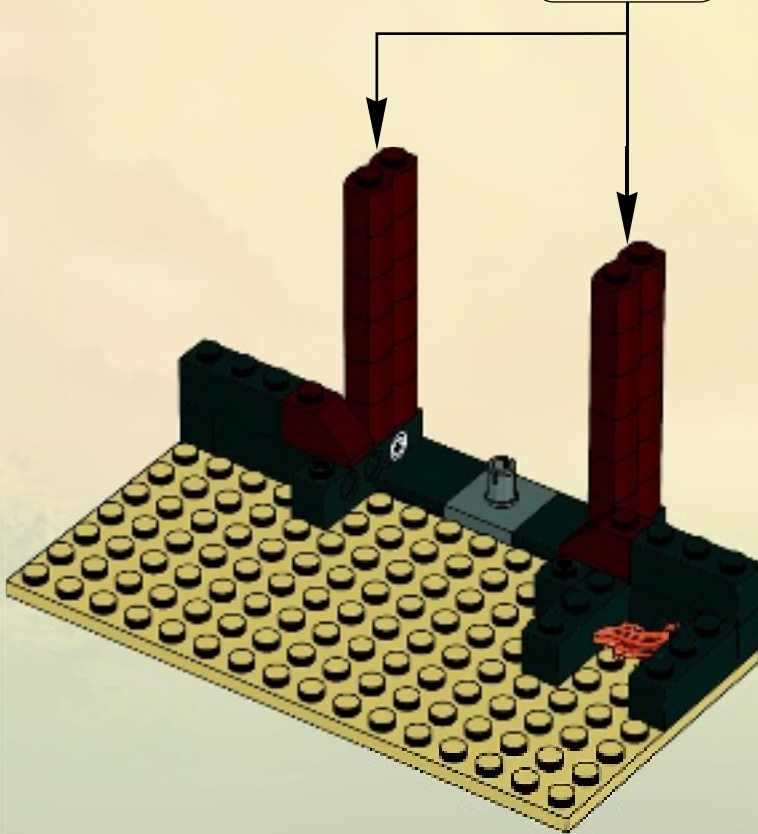

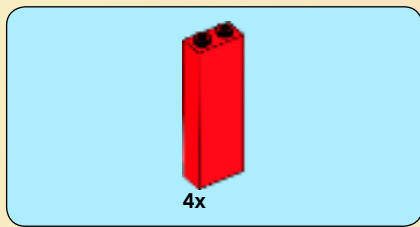

10

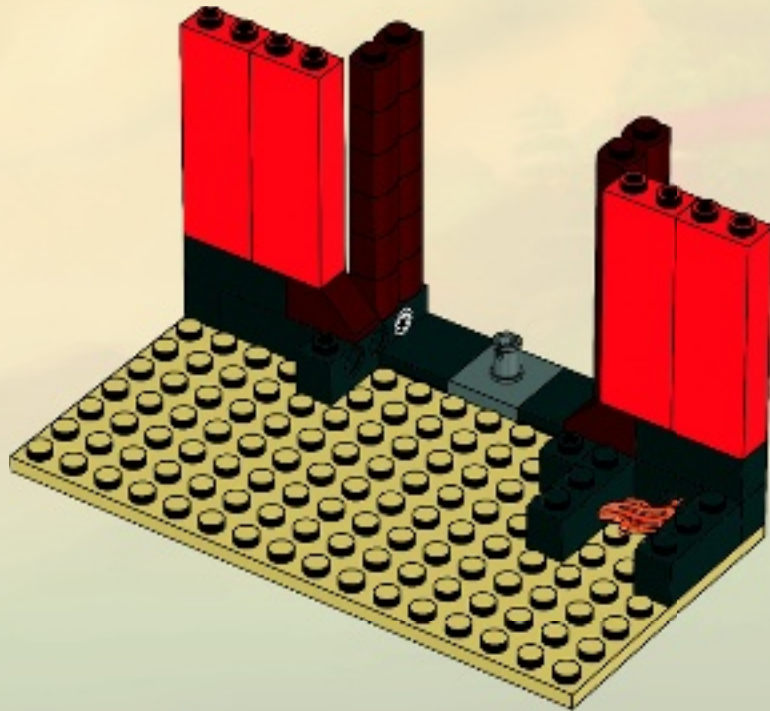

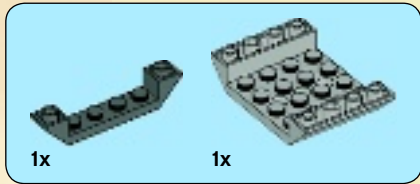

1

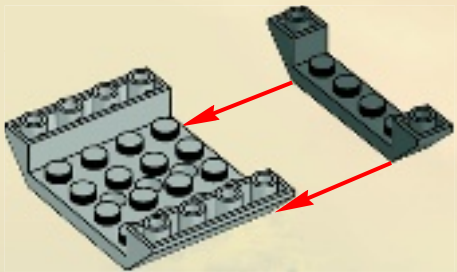

2

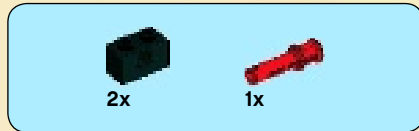
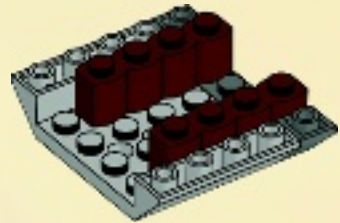

3

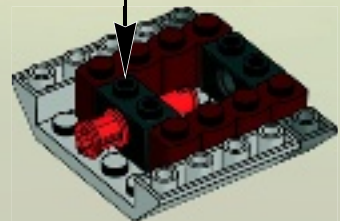
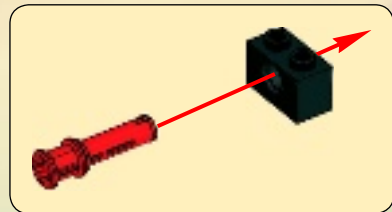

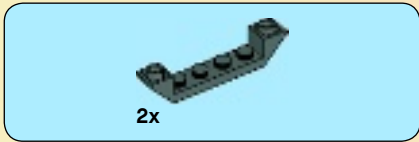

4

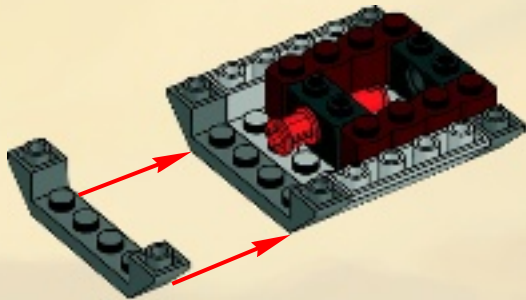

5

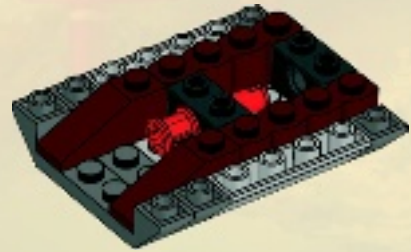

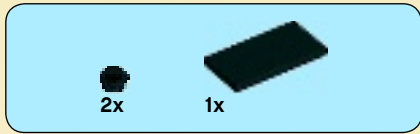

6

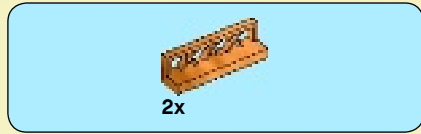
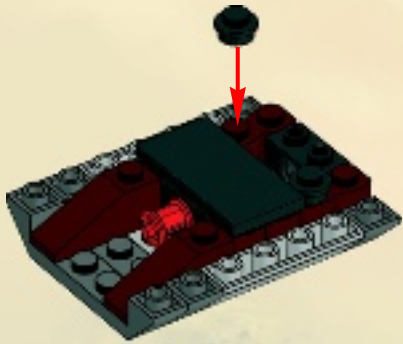

7

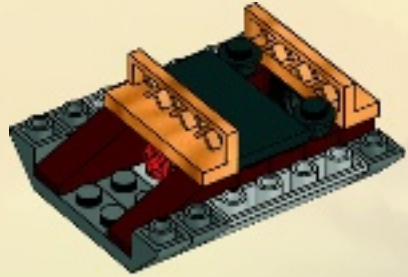



8

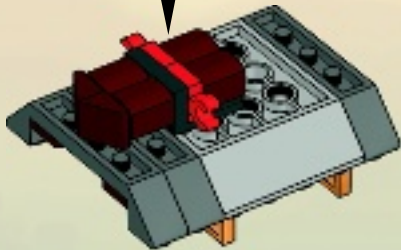
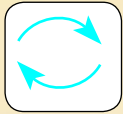
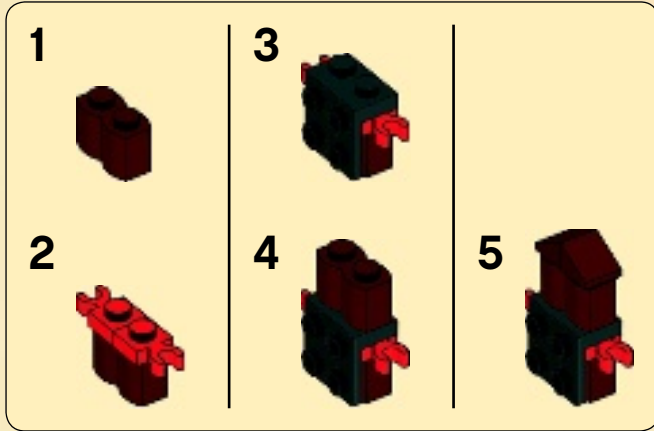

9

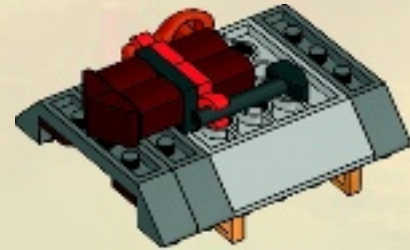

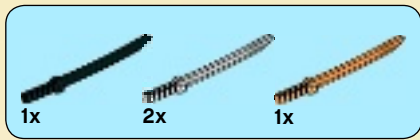

10

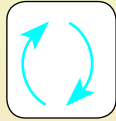

11

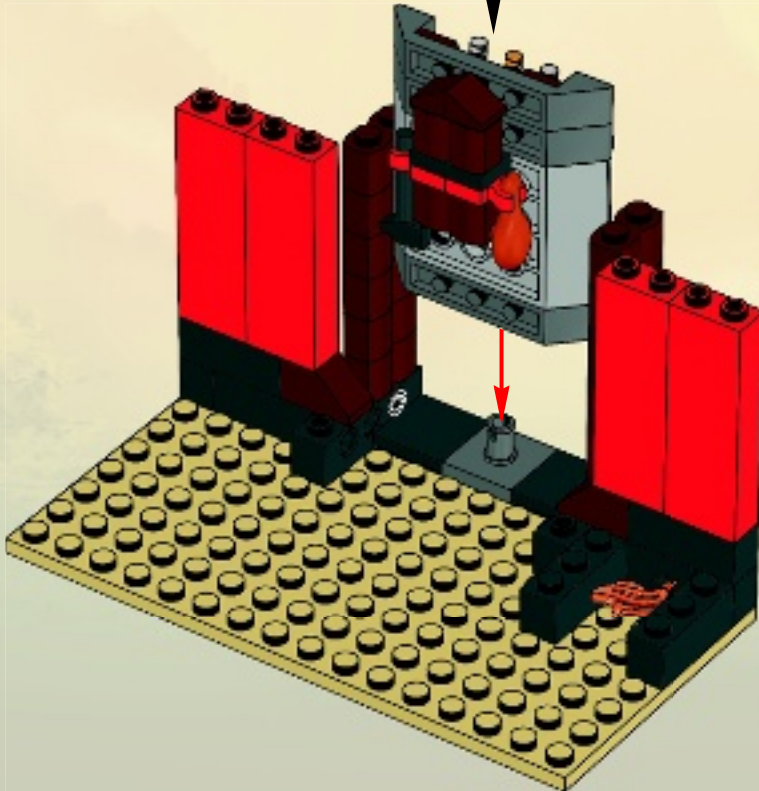

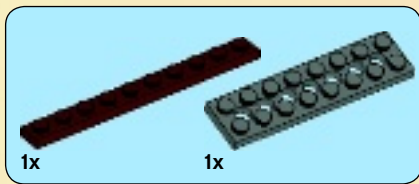

12

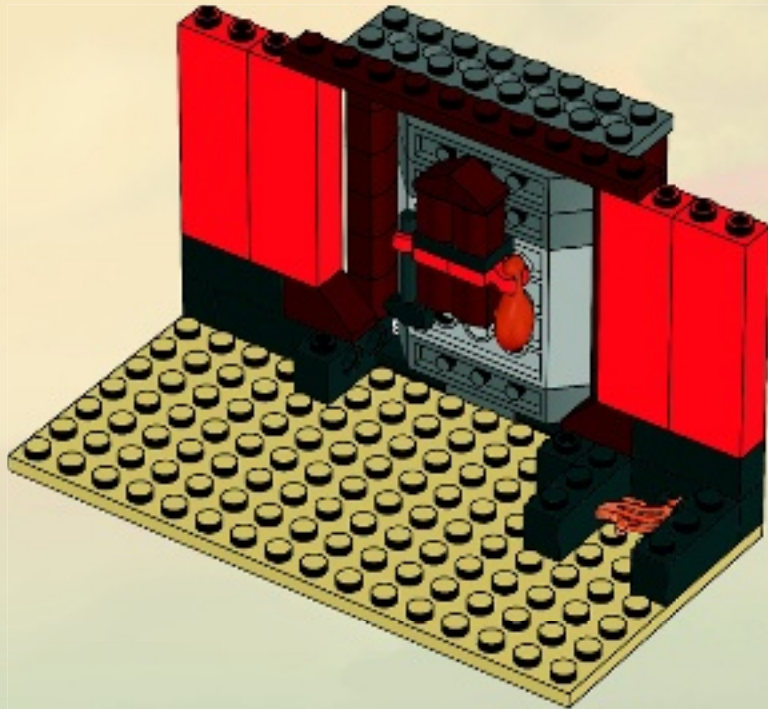

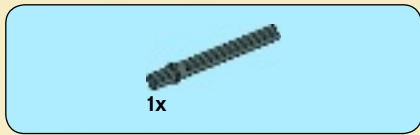

13

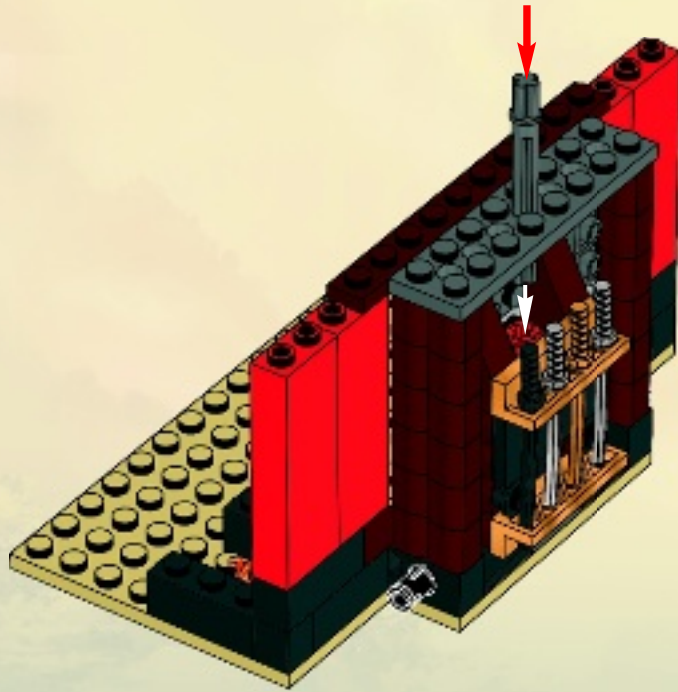
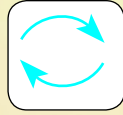



2x



2x

14

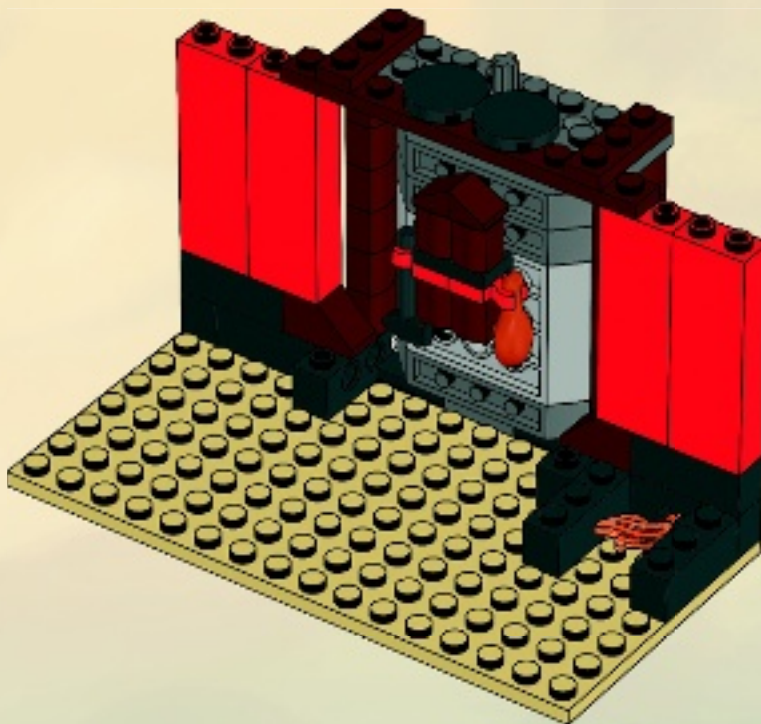
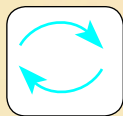



4x



1x

15

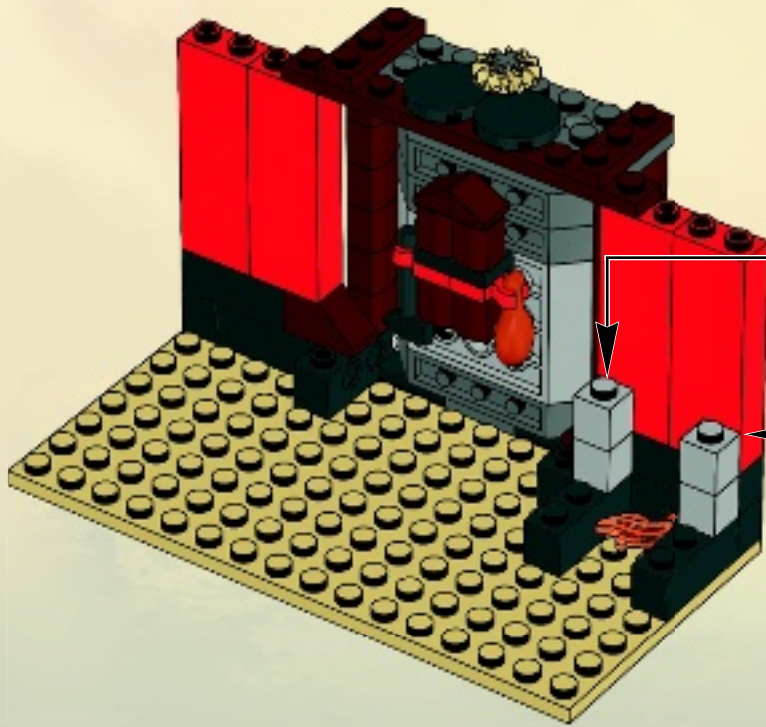

2x



1x



2x



1x

16

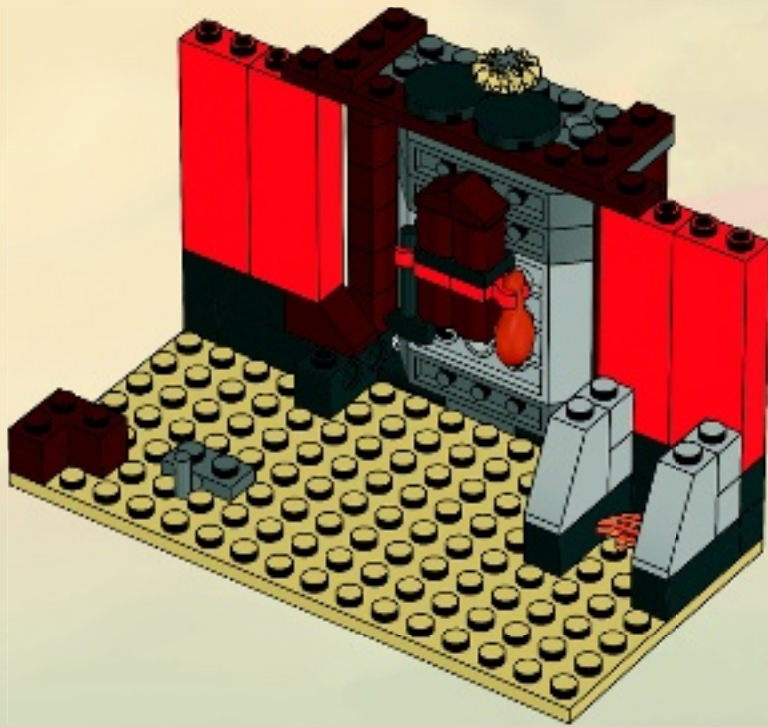

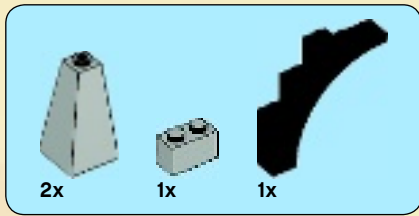

17

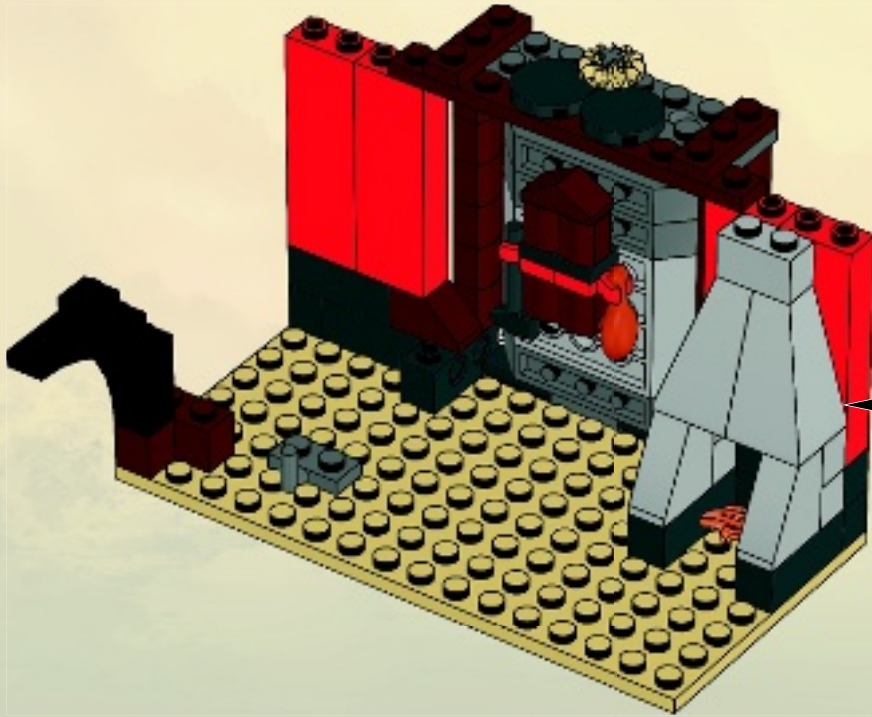
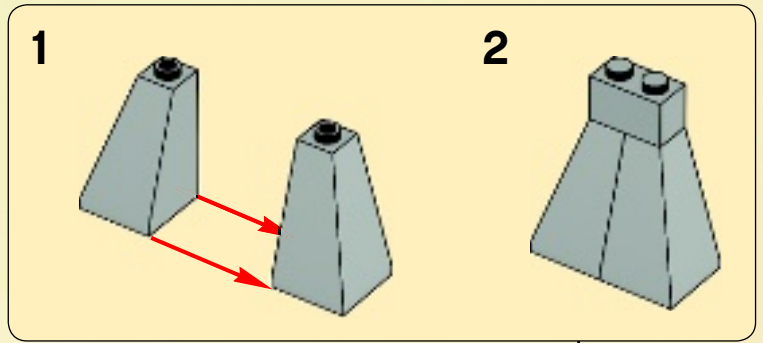

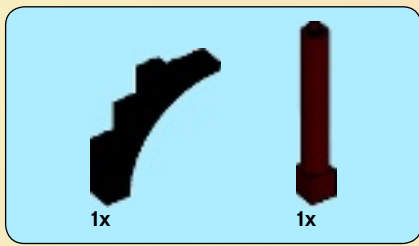

18

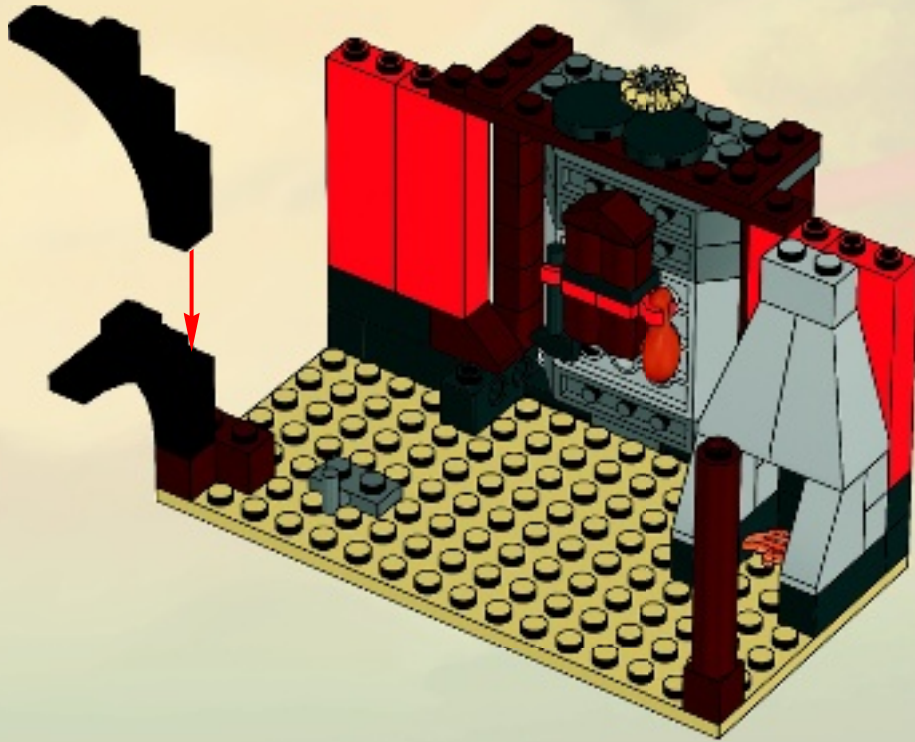

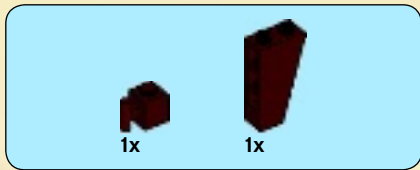

19

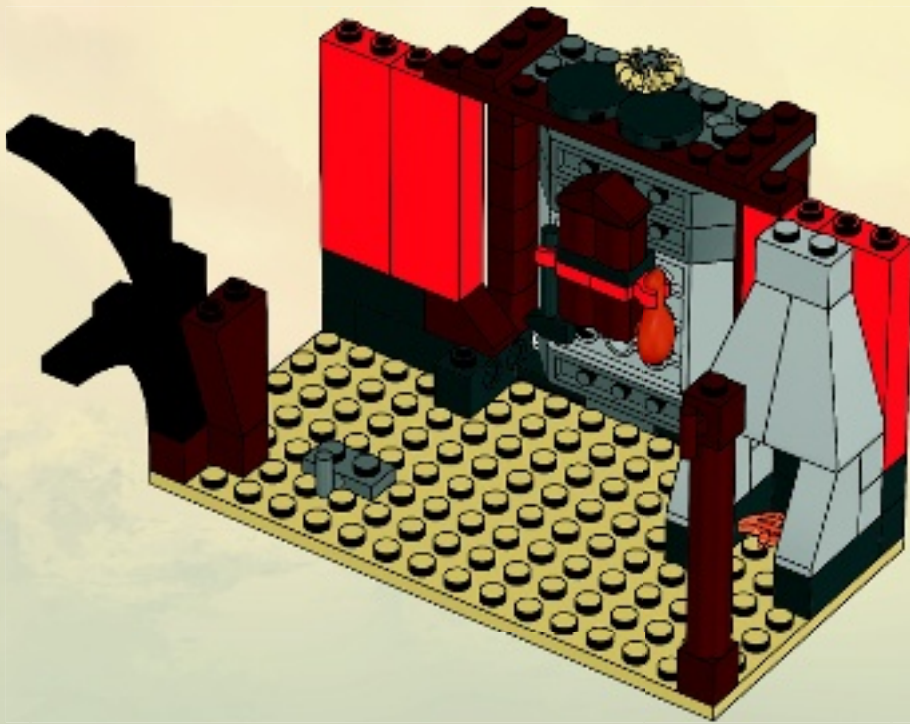



1x

20

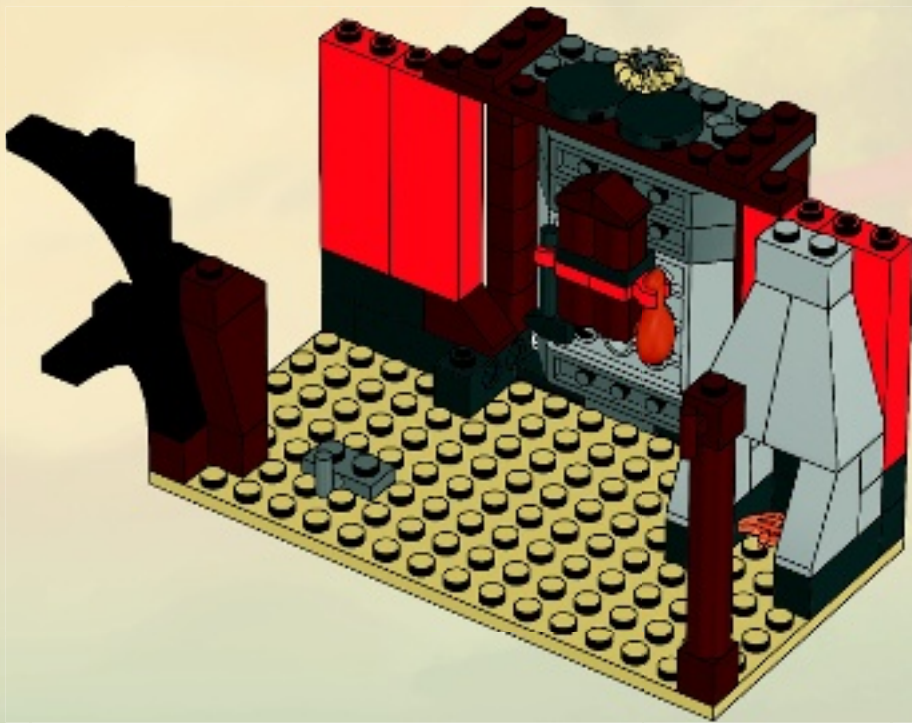

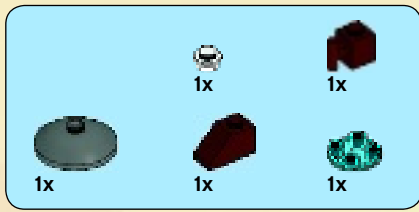

21

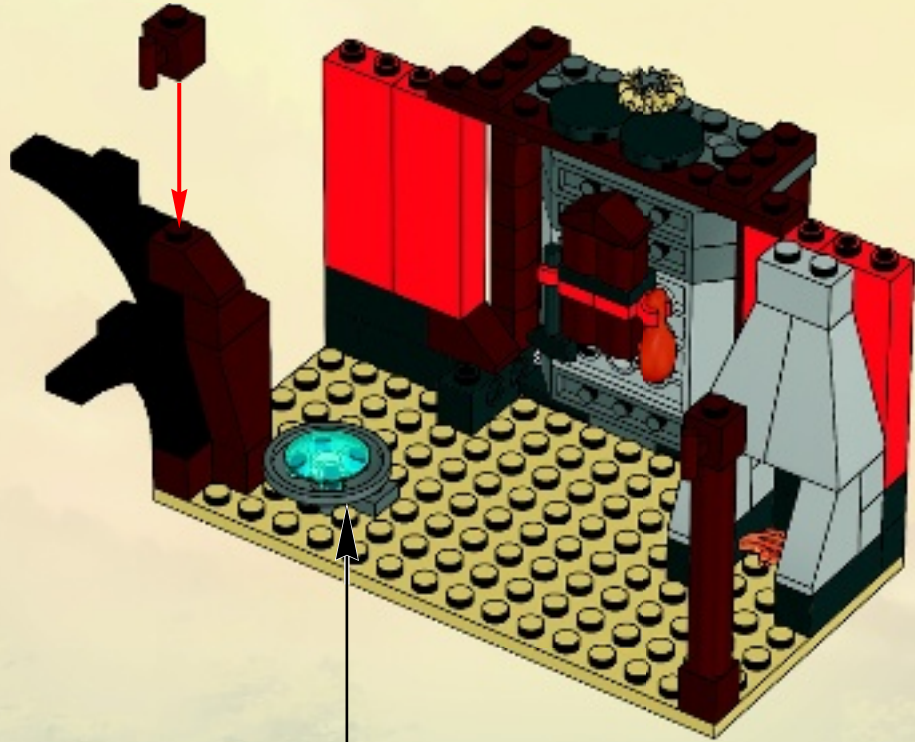

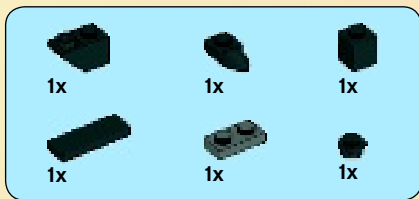

22

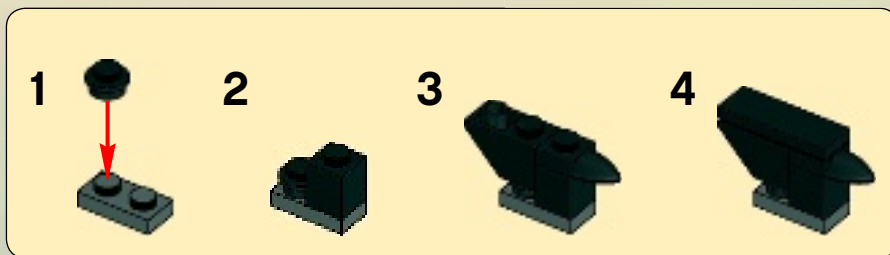
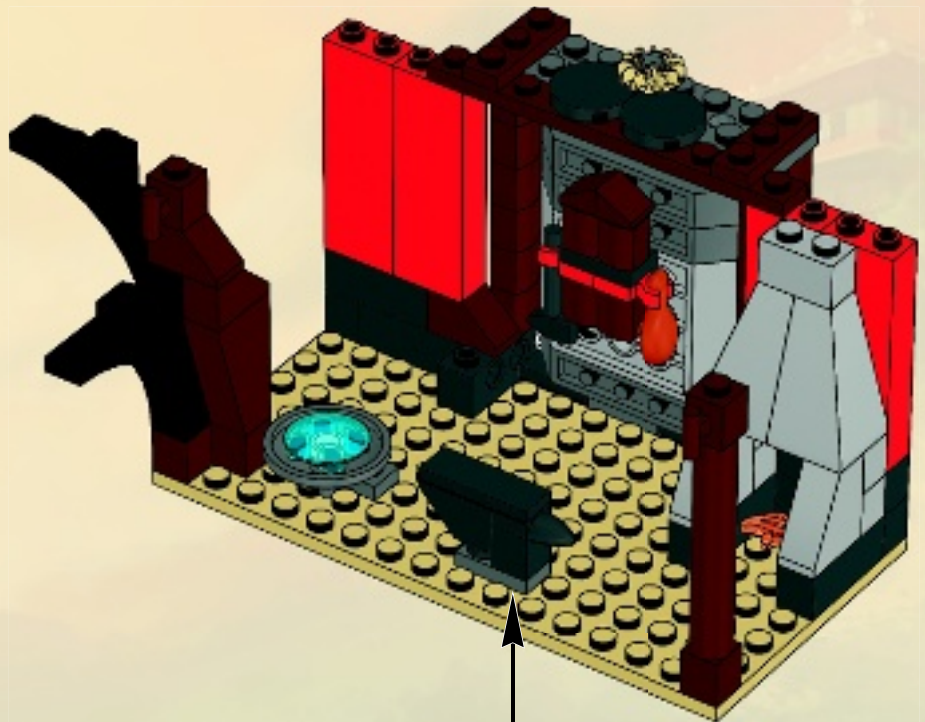

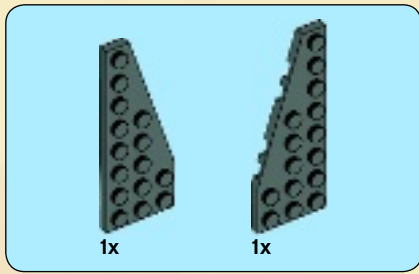

23

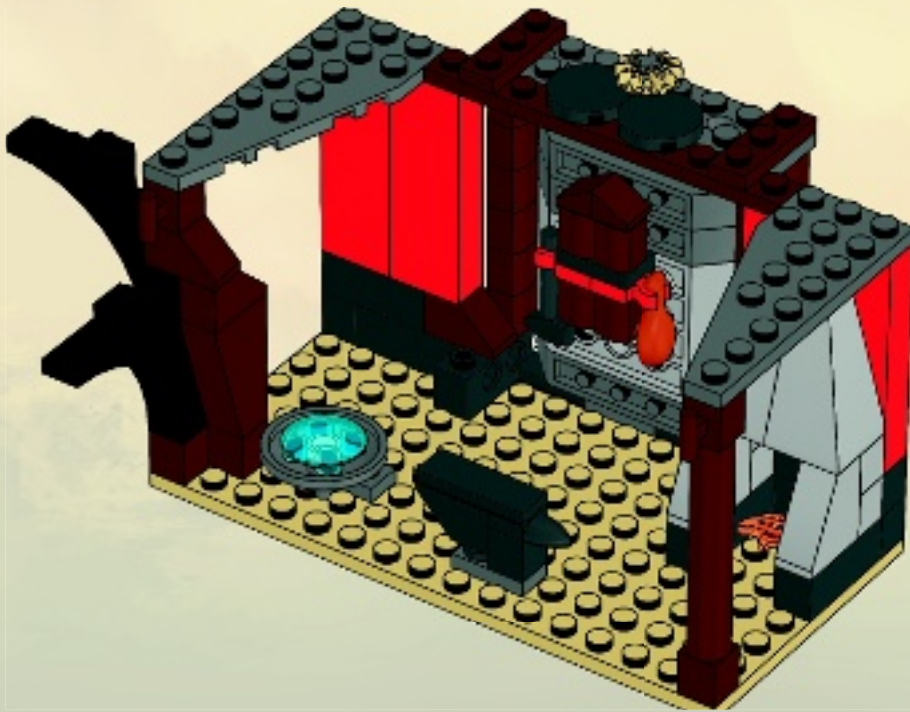



24

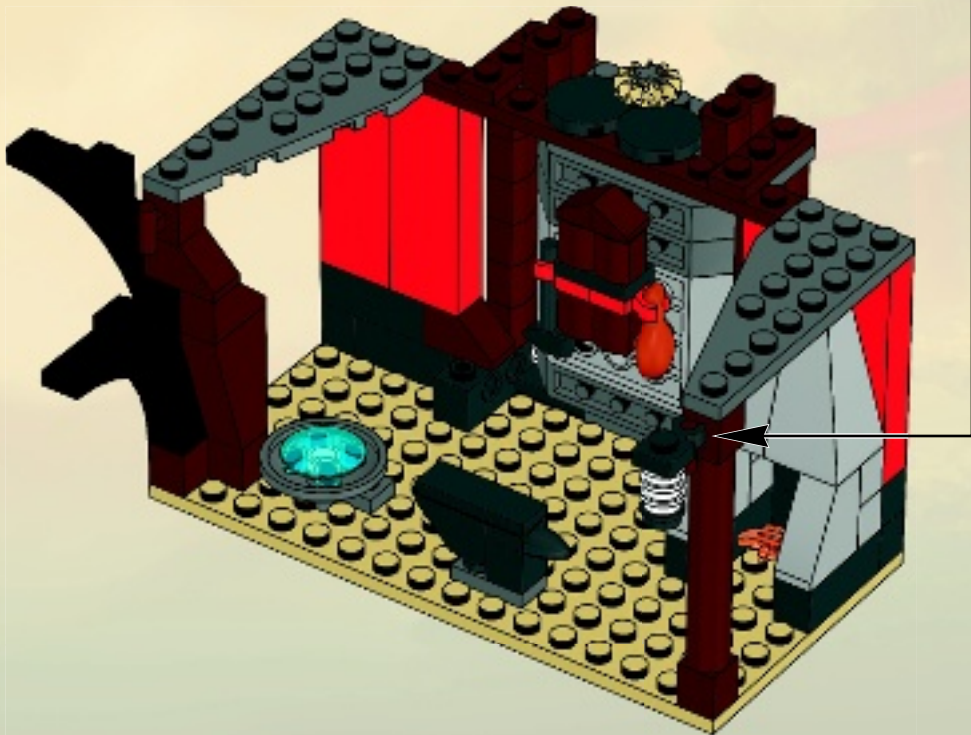
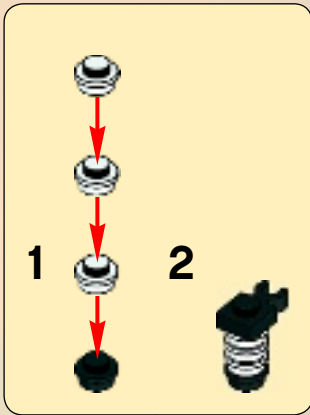

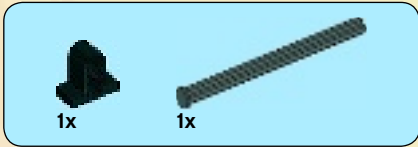

1

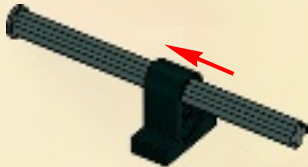

2

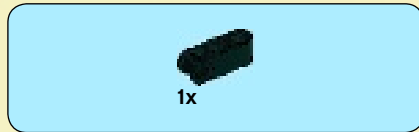
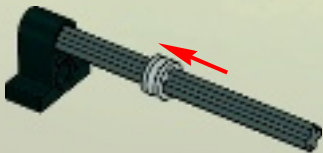

3

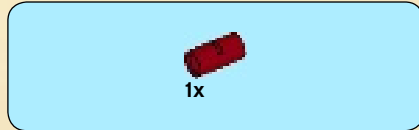

4

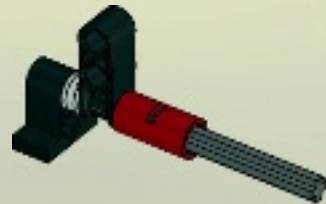



5

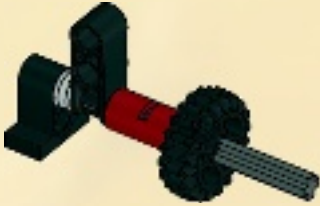

6

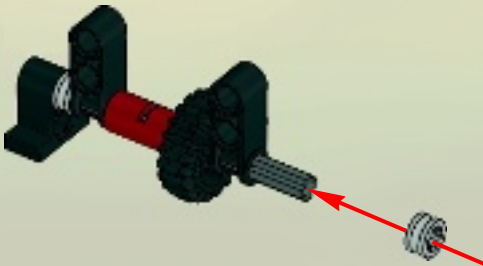

7

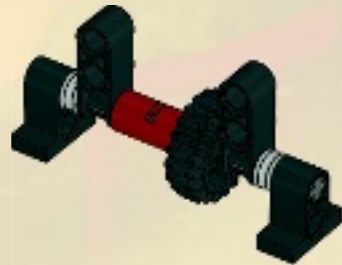

25

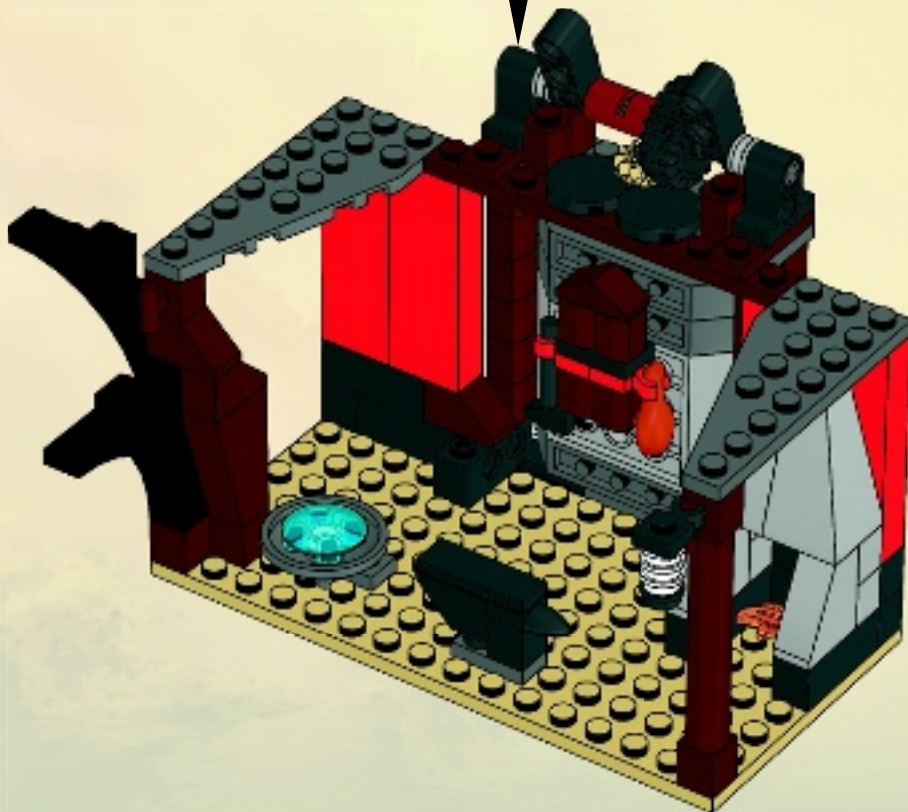



2x

26

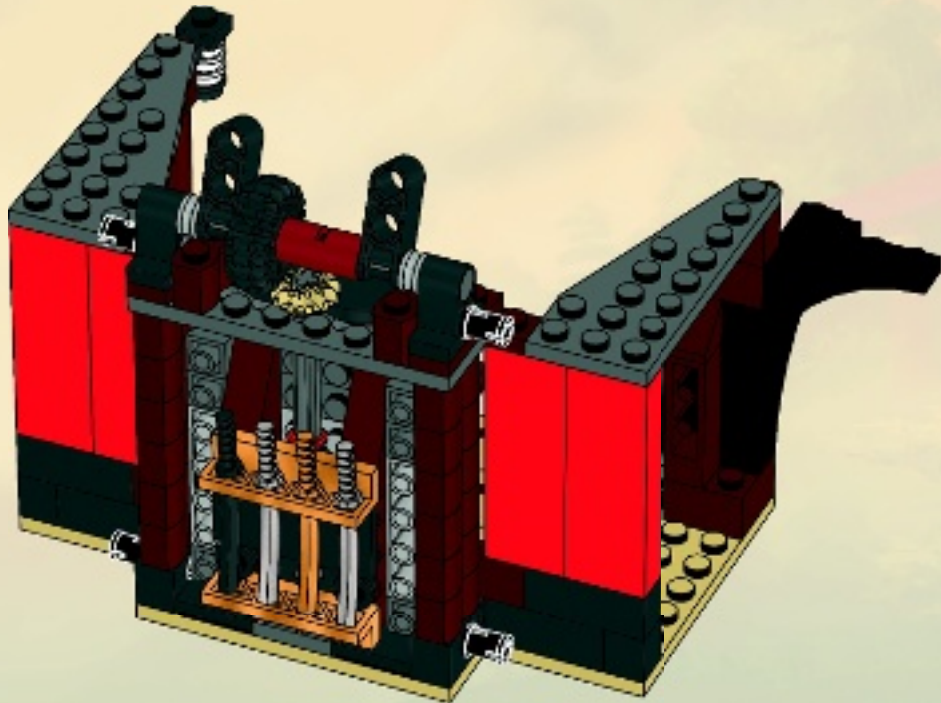
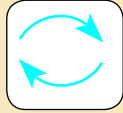

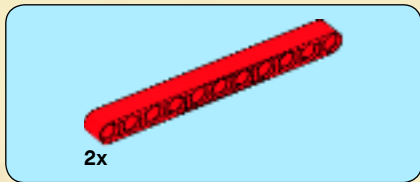

27

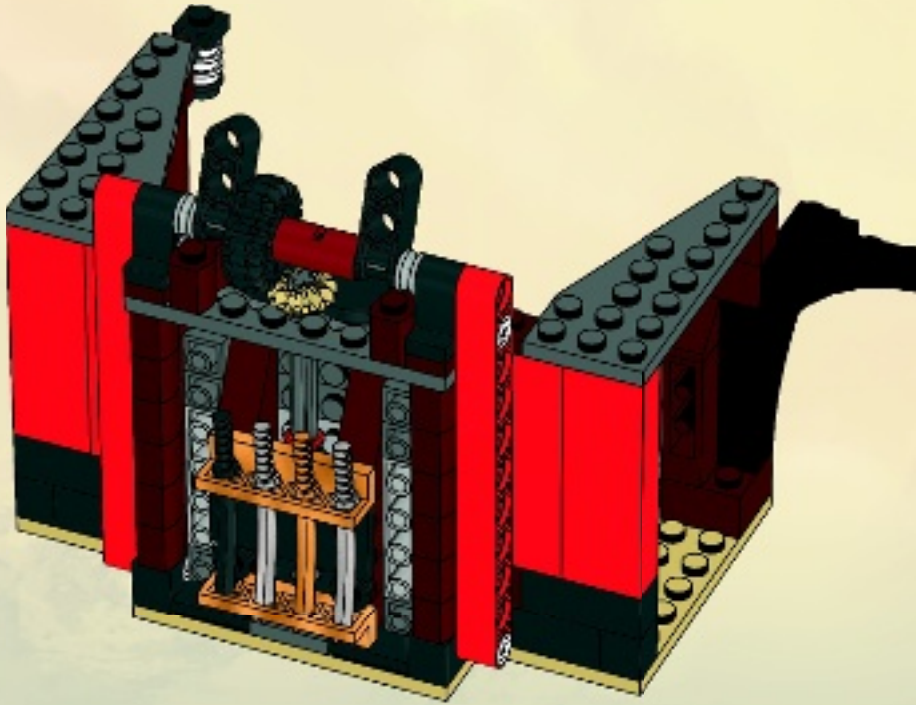

28

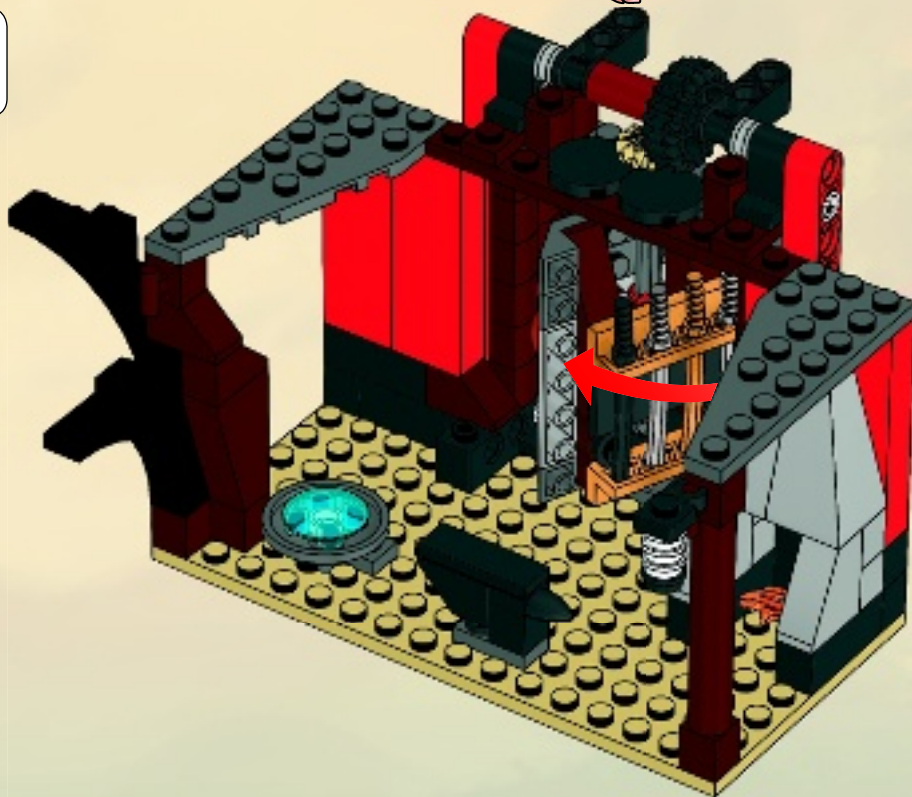
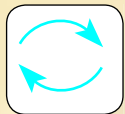

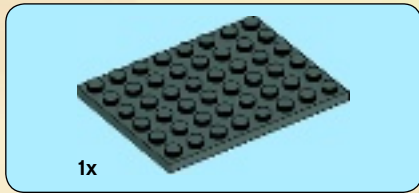
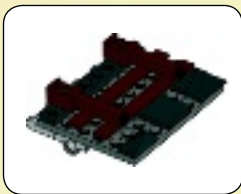

1x

1



2x

1x

2

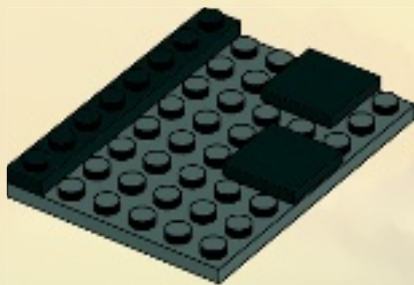

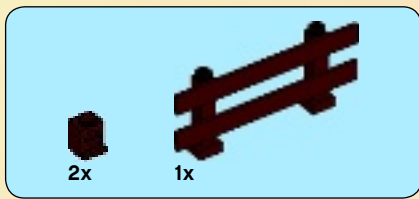

3

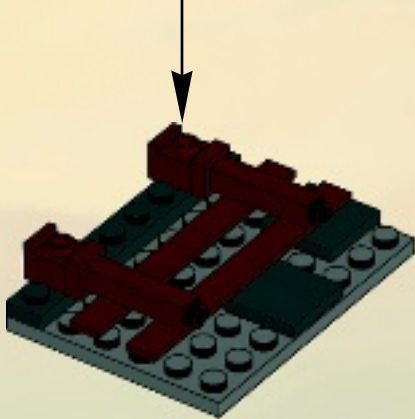
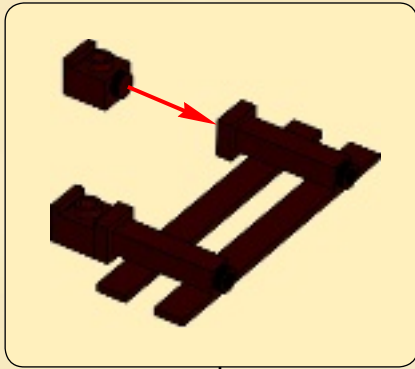

4

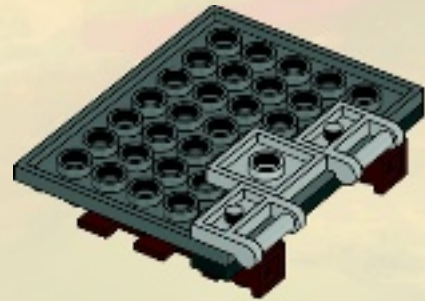
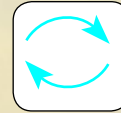

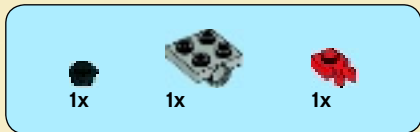

5

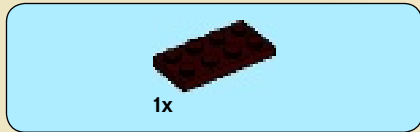
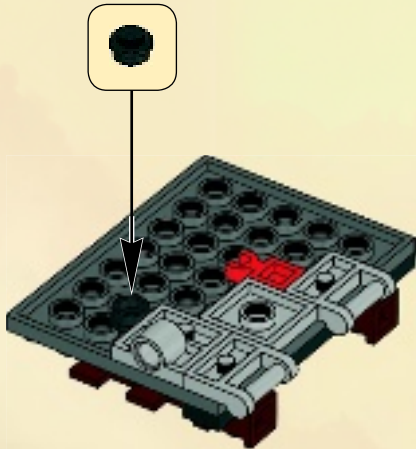

6



7

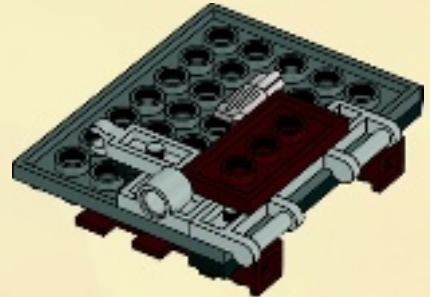

8

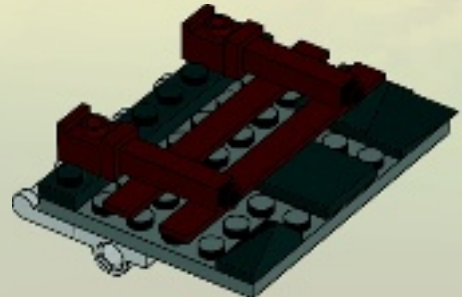
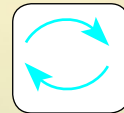

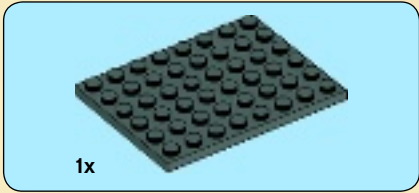

1

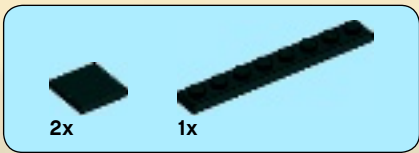

2

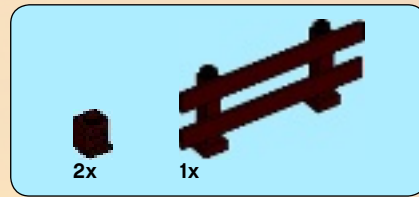

3

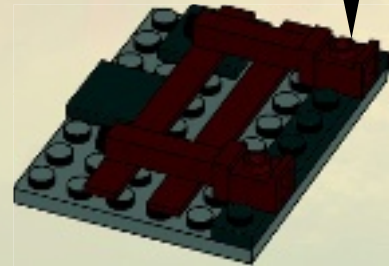
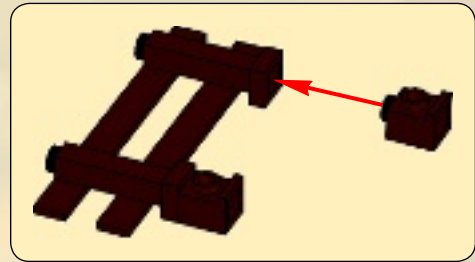



1x



2x

4

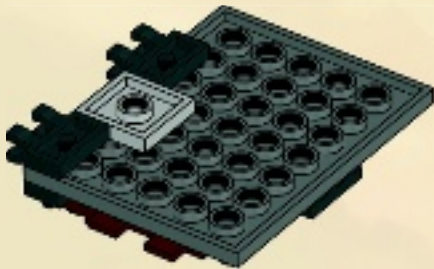

1x



1x



1x

5

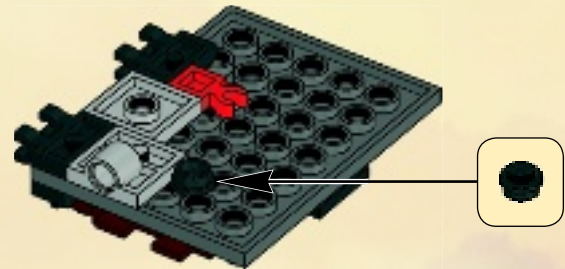



6



7

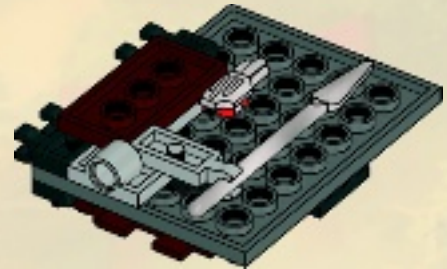



8

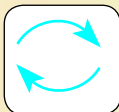

9

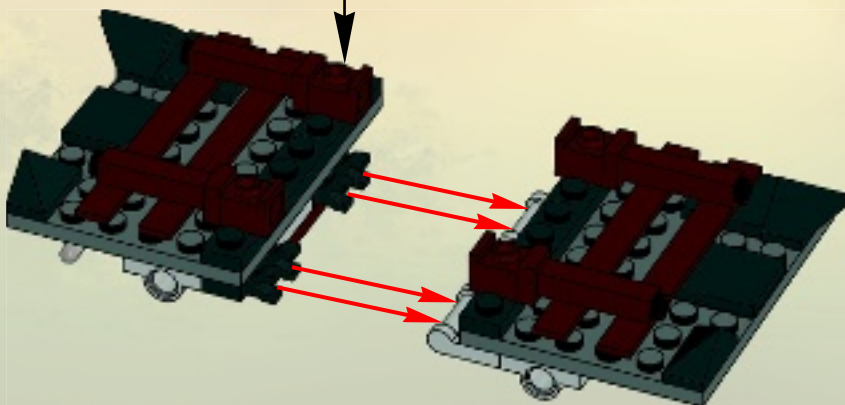



2x

10

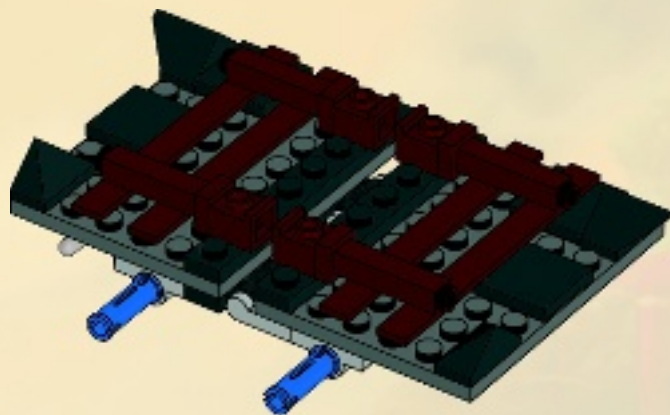



11

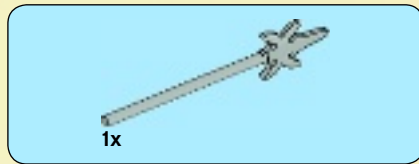
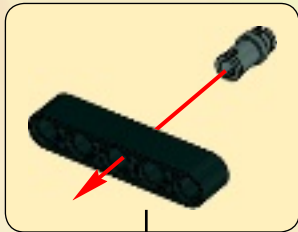

12

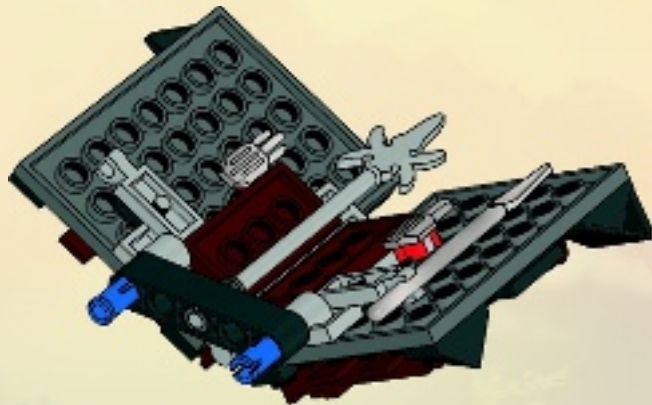
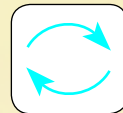

13

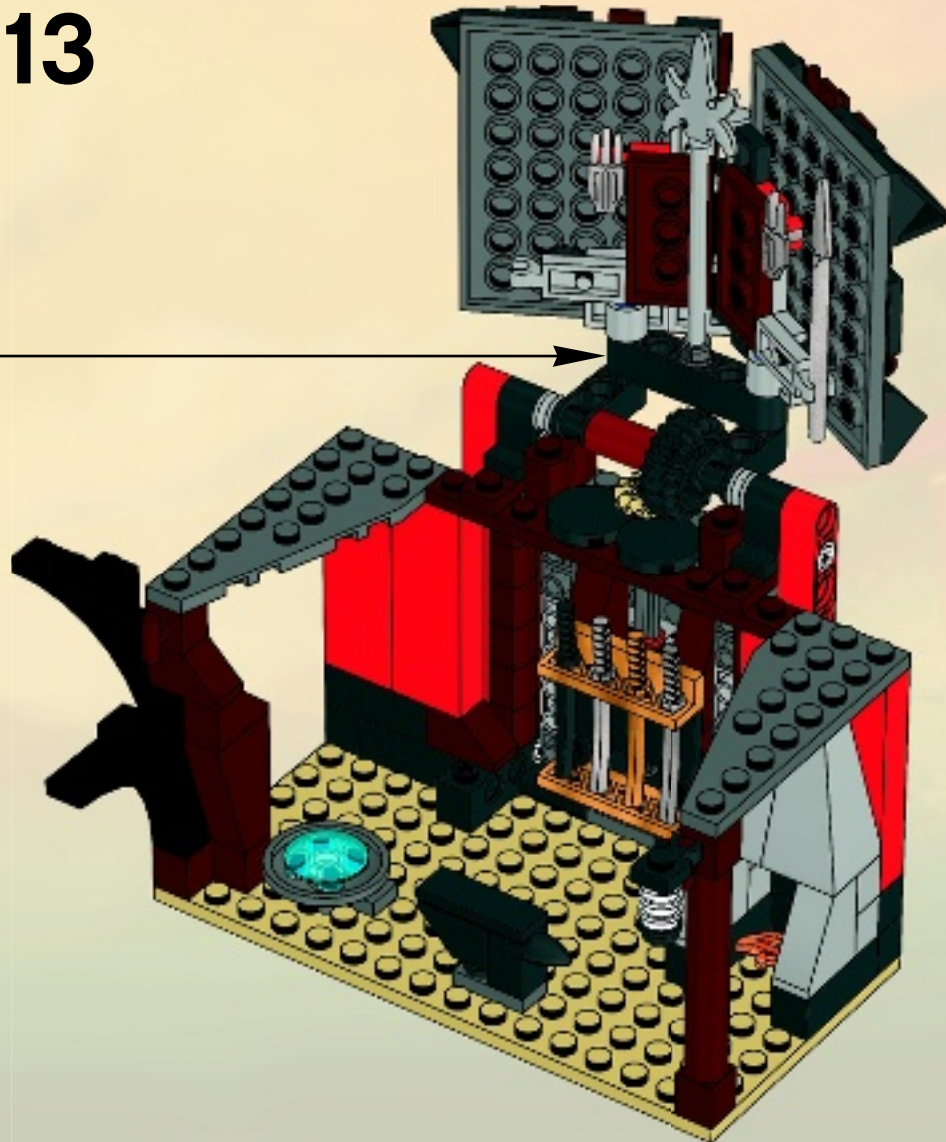



14

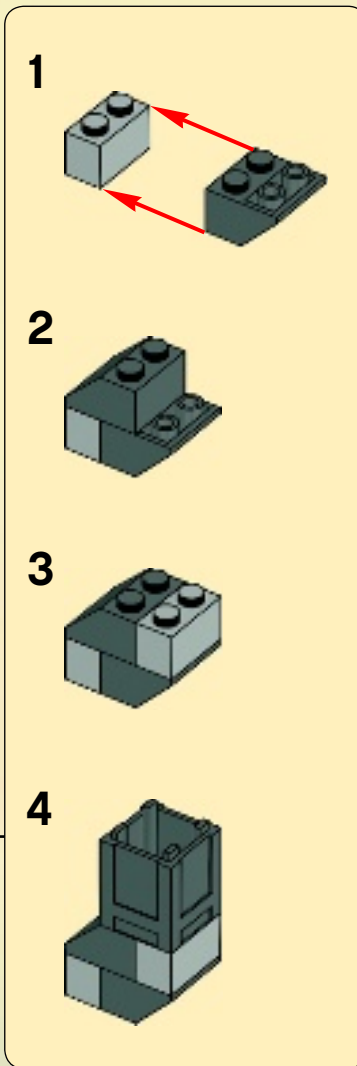
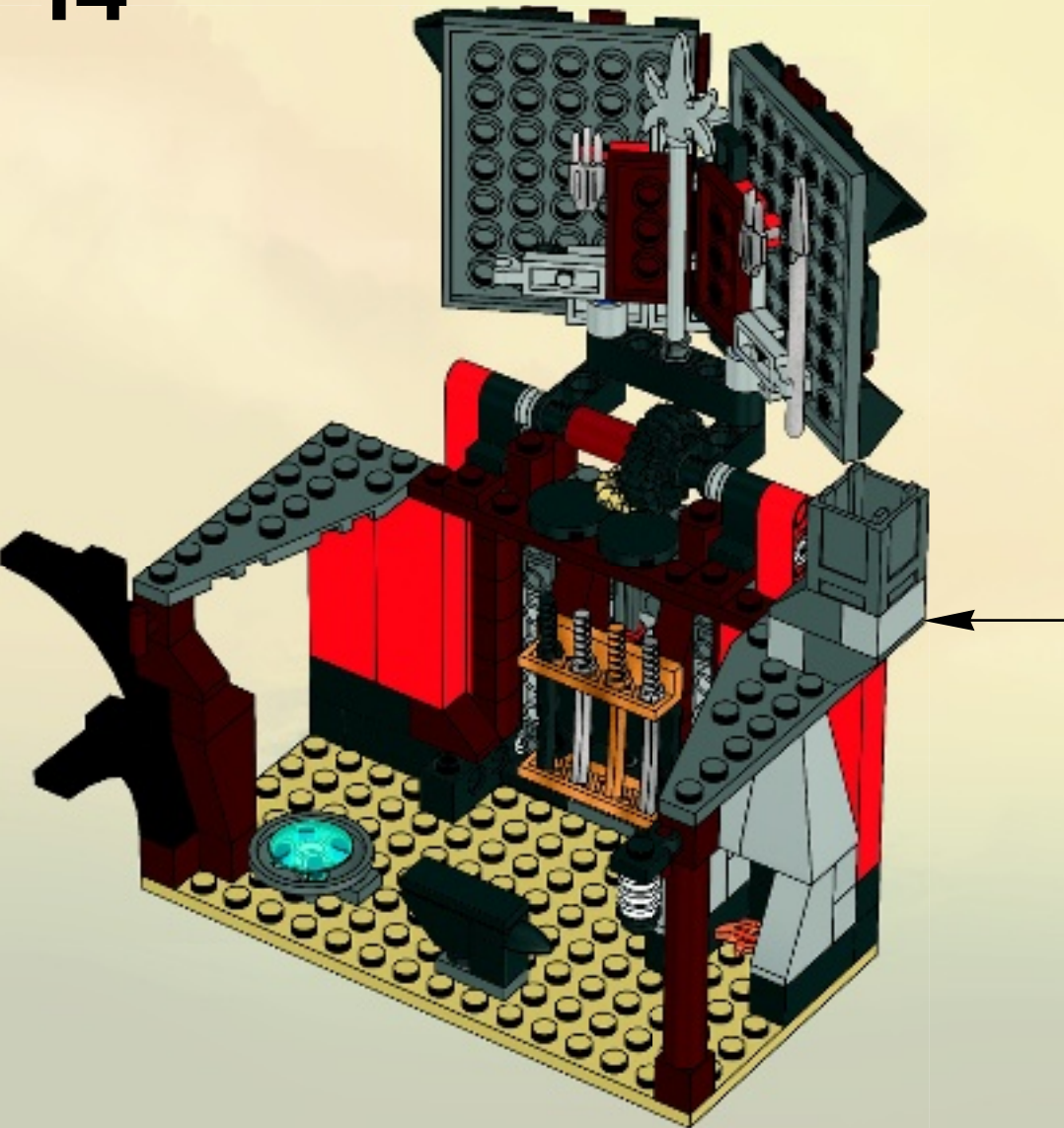



2x

15

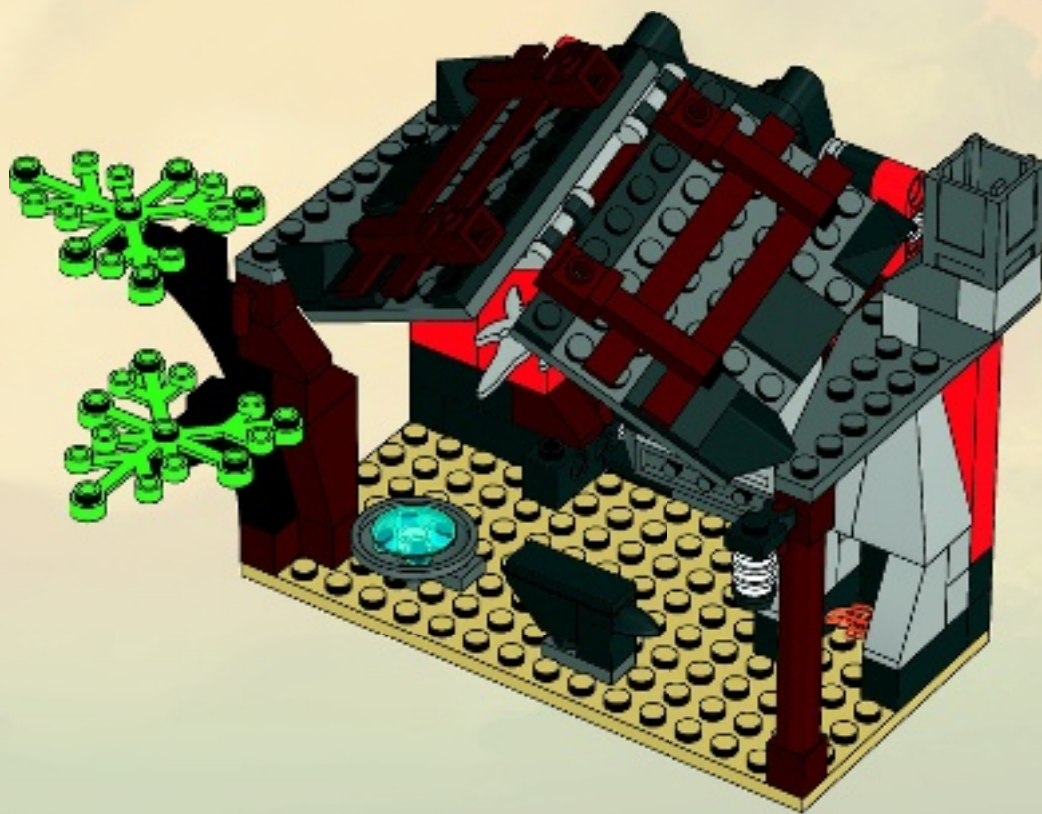

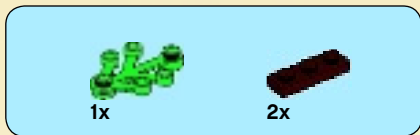

16

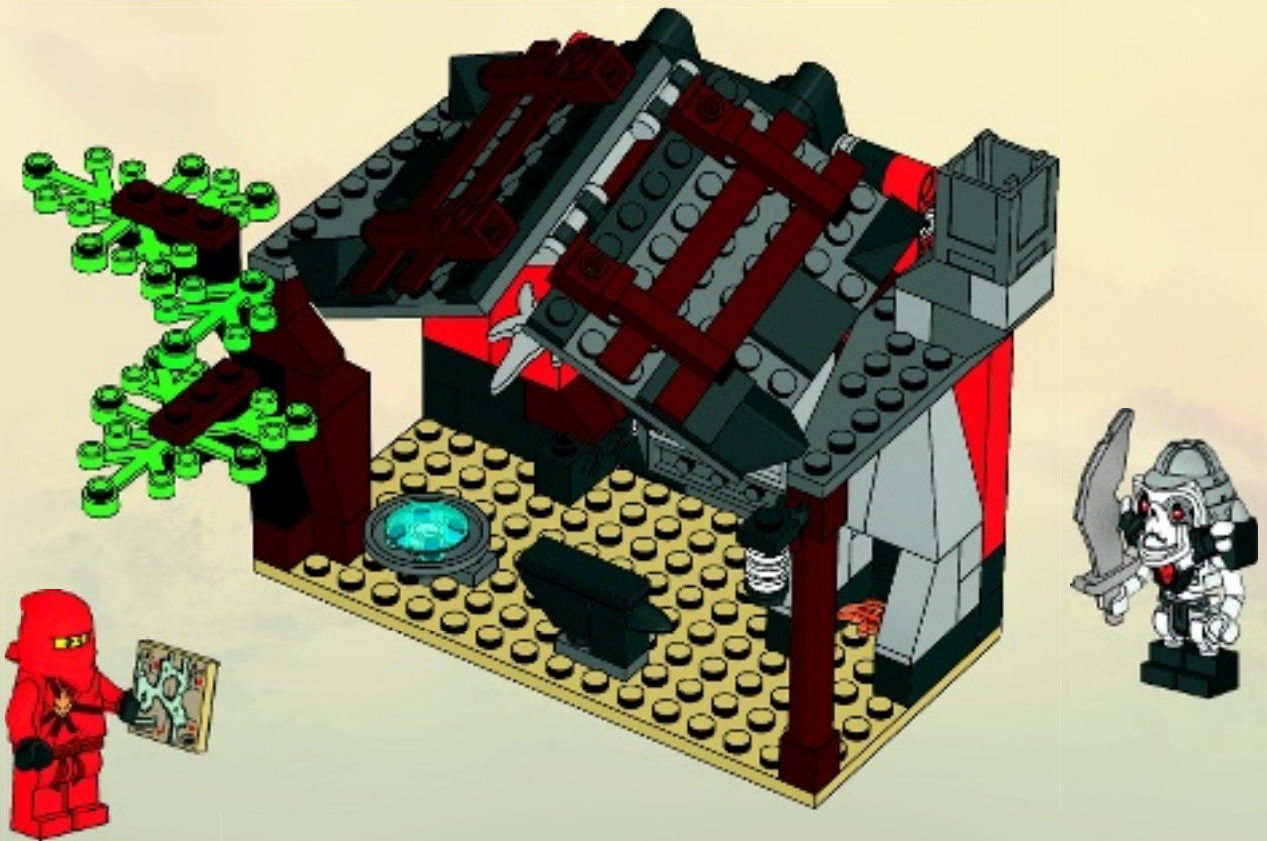

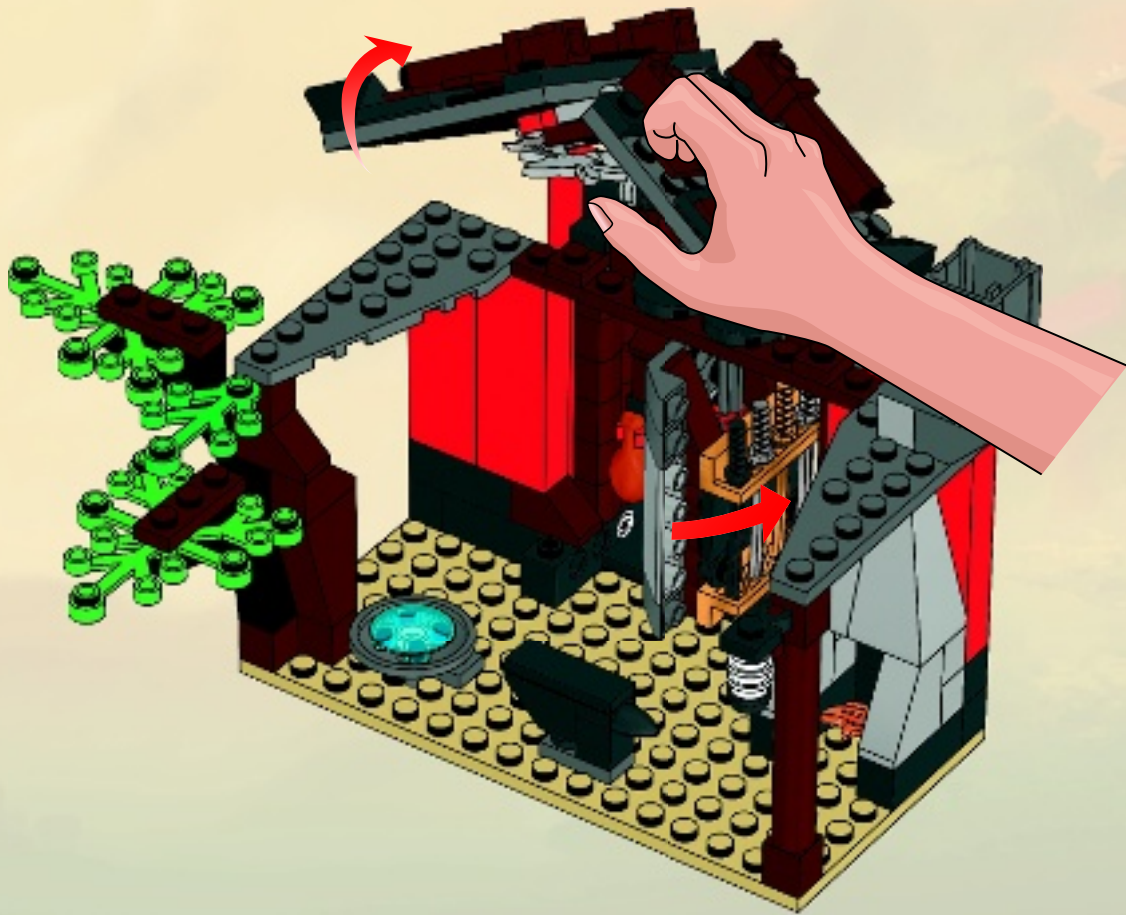



Customer Service

Kundenservice

Service Consommateurs

Servicio Al Consumidor

www.lego.com/service or dial



00800 5346 5555 :



1-800-422-5346 :



LEGO

NINJAGO

Masters of Spinjitzu



2509



2506



2507

2508



2509

2507



2506



2508



NINJAGO

Masters of Spinjitzu





NINJAGO

Masters of Spinjitzu



 2170 2507 2509	 2508 2507	 2170	 2170 2507 2508 2509	 2171	 2171	 2171 2507 2508	 2507	 2507	 2172	 2172
 2172 2507	 2173	 2173 2174	 2173 2256 2508	 2174	 2174 2175	 2175	 2175			
 2255	 2255	 2255 2507 2508	 2256	 2256	 2506	 2506 2507	 2506 2507			
 2506 2507	 2507 2254	 2507	 2508	 2508	 2509	 2509	 2254	 2254		



NINJAGO

Masters of Spinjitzu



2254



2257



2174



2175



2255



2256



NINJAGO

Masters of Spinjitzu

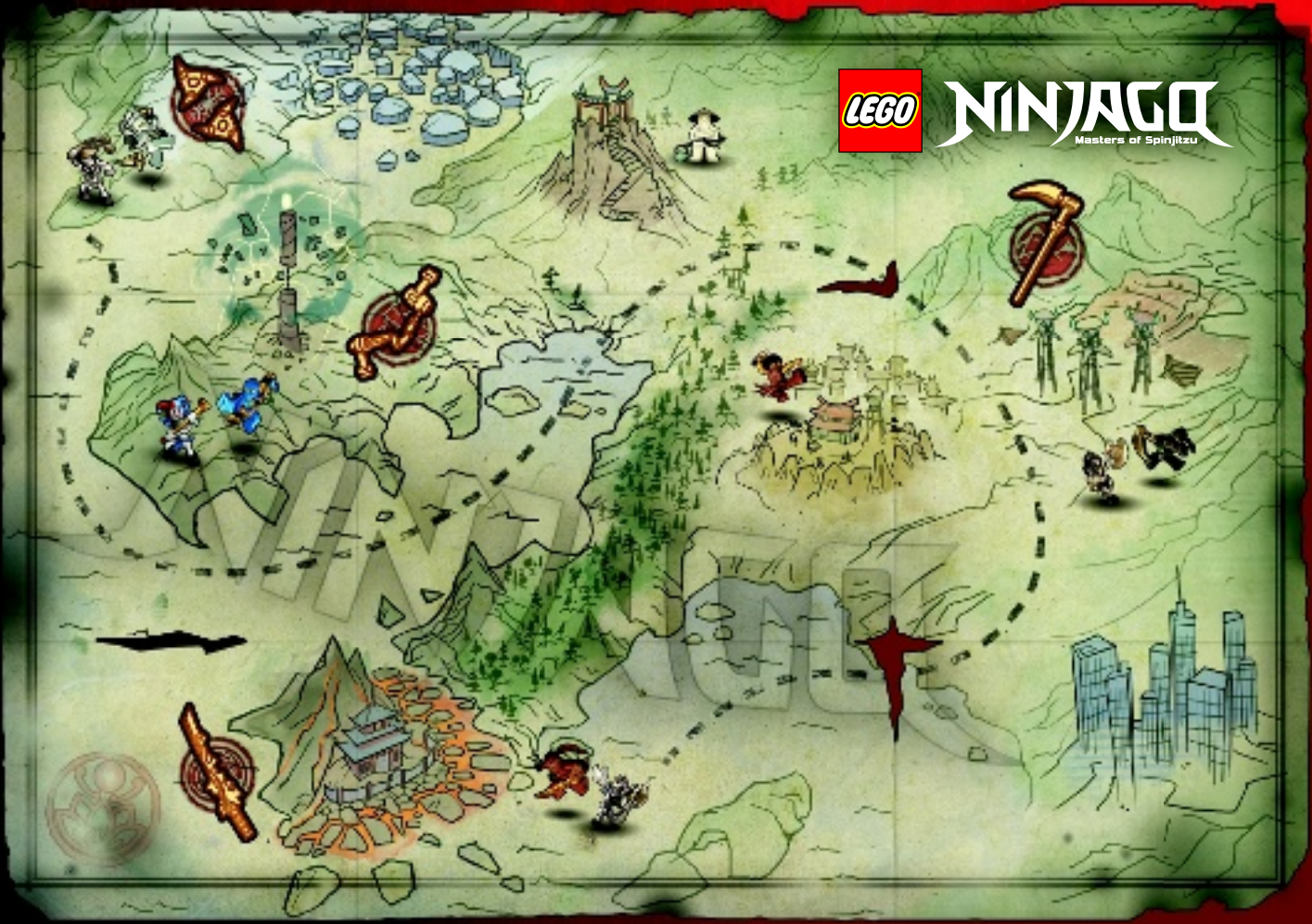



NINJAGO

Masters of Spinjitzu



NINJAGO.COM



NINJAGO

THE VIDEO GAME
LE JEU VIDÉO
EL VIDEO JUEGO



OUT NOW!
MAINTENANT DISPONIBLE !
¡DISPONIBLE AHORA!

LEGO Battles: Ninjago software © 2011 TT Games Publishing Ltd. Produced by TT Games under license from the LEGO Group. LEGO, the LEGO logo, the Brick and the Knob configurations and the Minifigure are trademarks of the LEGO Group. © 2011 The LEGO Group. Hellbent Games and the Hellbent logo are trademarks of Hellbent Games Inc. Nintendo DS is a trademark of Nintendo. © 2011 Nintendo. All other trademarks and copyrights are the property of their respective owners. All rights reserved.

LEGO Battles: Le jeu vidéo Ninjago © 2011 TT Games Publishing Ltd. Produit par TT Games sous licence du LEGO Group. LEGO, le logo LEGO, la Brique et les configurations du Minion et la Figurine sont des marques de commerce de LEGO Group. © 2011 The LEGO Group. Hellbent Games et le logo Hellbent sont des marques de commerce de Hellbent Games Inc. Nintendo DS est une marque de commerce de Nintendo. © 2011 Nintendo. Toutes les autres marques de commerce et droits d'auteur sont la propriété de leurs propriétaires respectifs. Tous droits réservés.

Batallas LEGO®: Software Ninjago © 2011 TT Games Publishing Ltd. Producido por TT Games bajo licencia de the LEGO Group. LEGO, el logo LEGO, el Brick, la configuración del minion y la Minifigura son marcas de the LEGO Group. © 2011 The LEGO Group. Hellbent Games y el Hellbent logo son marcas de Hellbent Games Inc. Nintendo DS es una marca de Nintendo. © 2011 Nintendo. Todas las otras marcas y derechos son propiedad de sus dueños respectivos. Todos los derechos reservados.



www.pegi.info



WB GAMES LOGO, WB SHIELD, TM & © Warner Bros. Entertainment Inc. (s11)

NINTENDO DS

hellbent games





UNIVERSE

MASSIVELY MULTIPLAYER ONLINE GAME
JEU EN LIGNE MASSIVEMENT MULTJOUEUR

Become your favorite Spinjitzu hero in LEGO Universe
Spiele in LEGO Universe deine Lieblings-Figur aus Ninjago
Convírtete en tu héroe favorito de Spinjitzu en LEGO Universe
Deviens ton héros Spinjitzu préféré dans LEGO Universe
Légy olyan, mint kedvenc Ninjago hősöd a LEGO Universe
Transforma-te no teu herói Ninjago favorito em LEGO Universe

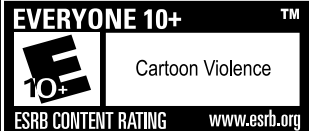

Online Interactions Not Rated by the ESRB



www.LEGOuniverse.com



WIN!

Go to www.LEGOsurvey.com/product to fill out a survey for a chance to win a cool LEGO® Product. No purchase necessary. Open to all residents where not prohibited.

 www.LEGO.com



www.LEGOsurvey.com/product

GEWINNE! WIN!

Nimm an der Umfrage auf www.LEGOsurvey.com/product teil und hab die Chance ein cooles LEGO® Produkt zu gewinnen!
Die Teilnahme am Gewinnspiel führt zu keinerlei Kaufverpflichtungen. Teilnahme in allen nicht ausgeschlossenen Ländern möglich.

GAGNE!

Ga naar www.LEGOsurvey.com/product, vul een enquêteformulier in en maak kans op een cool LEGO® product.
Geen aankoopverplichting. Iedereen mag deelnemen, uitgezonderd ingezetenden van landen waar een enquêteverbod geldt.

GAGNE! 当てよう!

Visite www.LEGOsurvey.com/product pour répondre à un questionnaire et avoir une chance de gagner un produit LEGO® très cool!
Aucune obligation d'achat. Ouvert à tous les résidents des pays autorisés.

www.LEGOsurvey.com/product にアクセスして、アンケートにご記入ください。当選者にはレゴ®製品を差し上げます。
お買い上げの必要はありません。
禁止されていない限り、すべての管轄にご利用いただけます。



NINJAGO

Masters of Spinjitzu

102

