



40594





Get excited about our new packaging!

We're switching from plastic to paper-based packaging. That's why you might find a mix of paper and plastic in our boxes!

Nos nouveaux emballages vous emballeront !

Nous passons des emballages en plastique aux emballages à base de papier. C'est pourquoi vous pourriez trouver un mélange de papier et de plastique dans nos boîtes !

¡Te presentamos nuestros nuevos empaques!

Estamos sustituyendo las bolsas de plástico por bolsas con base de papel. ¡Por eso, puedes encontrar una mezcla de papel y de plástico en nuestras cajas!

[LEGO.com/sustainable-packaging](https://www.lego.com/sustainable-packaging)

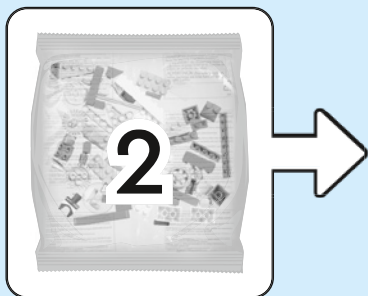
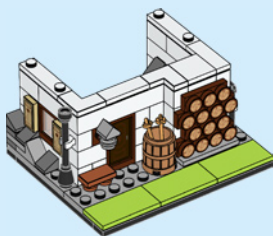
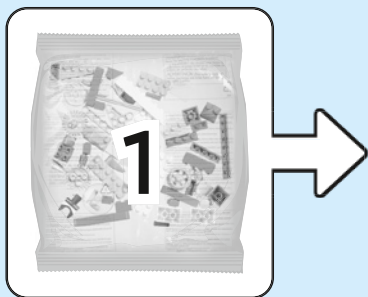



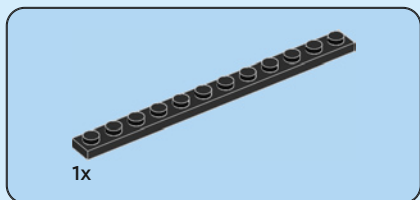

1

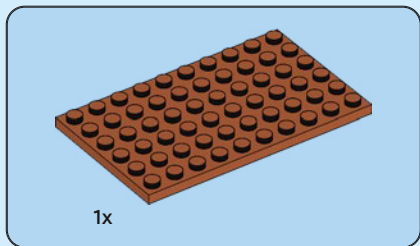
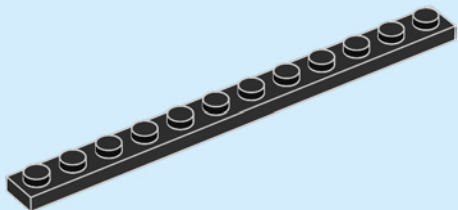

2

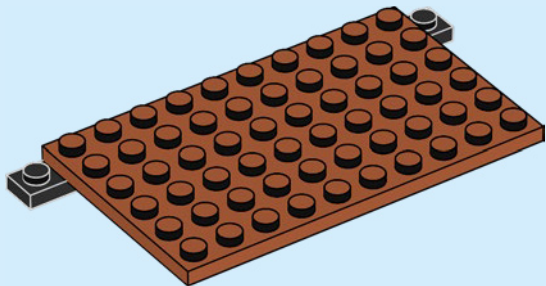

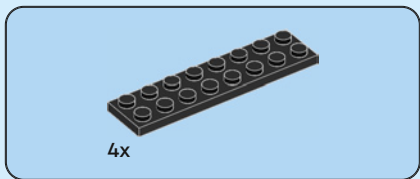

3

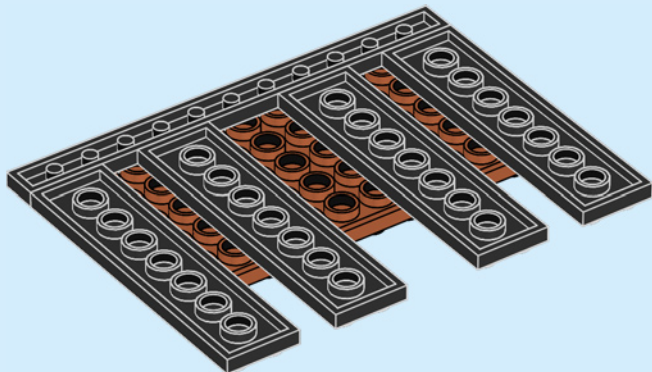

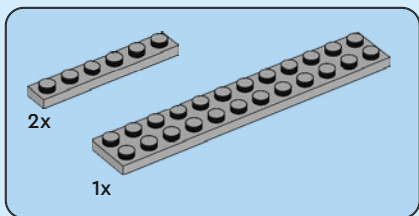

4

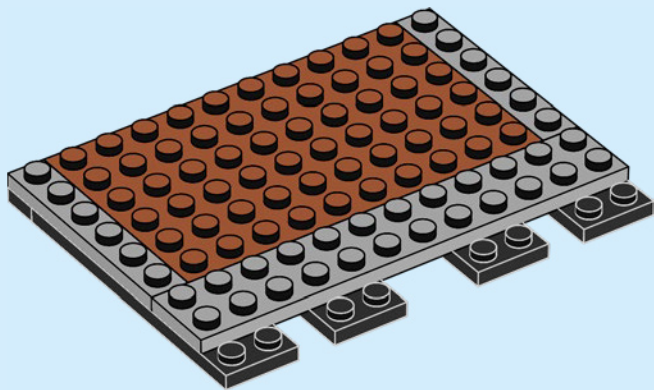

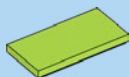

1x

5

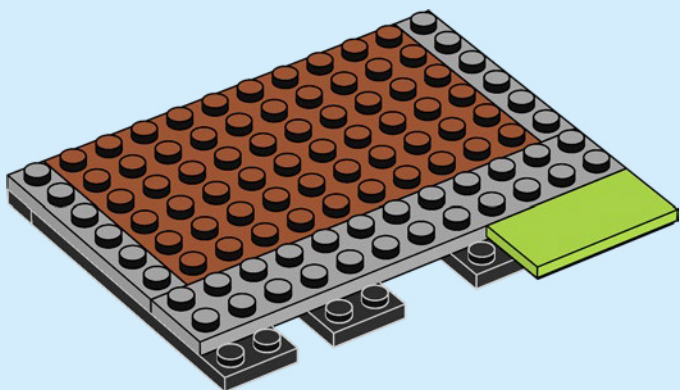

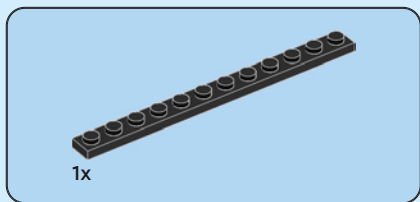

6

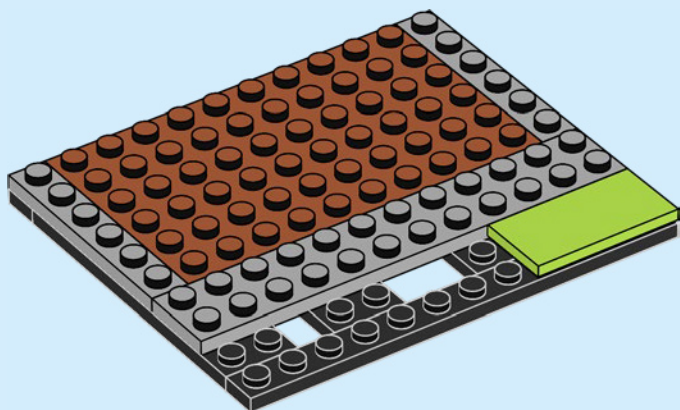

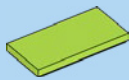

2x

7

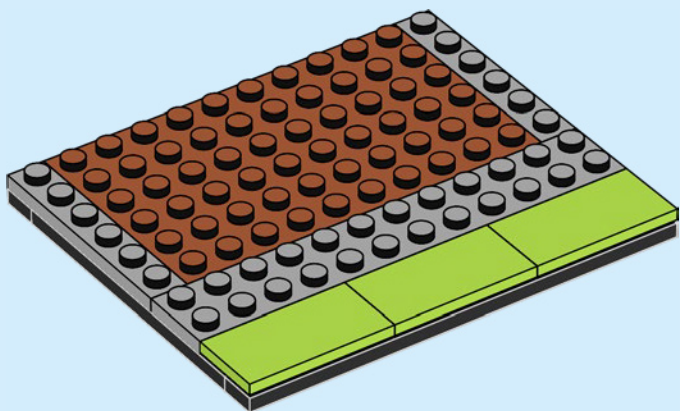

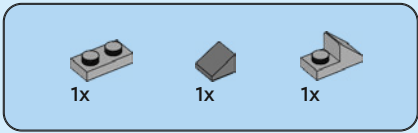

8

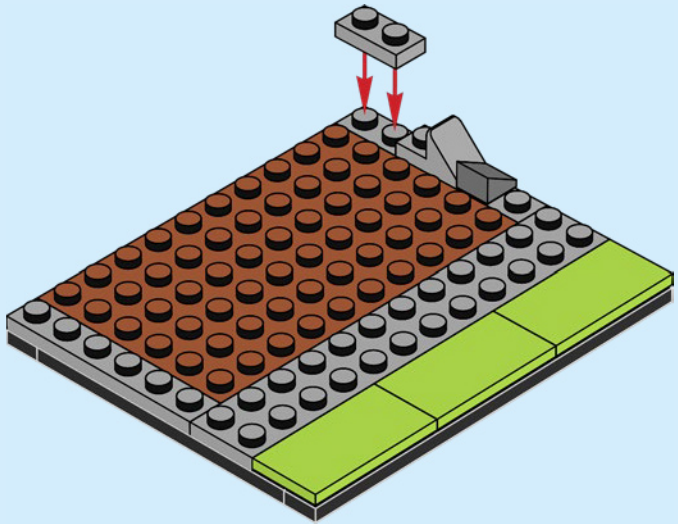



1x



1x

9

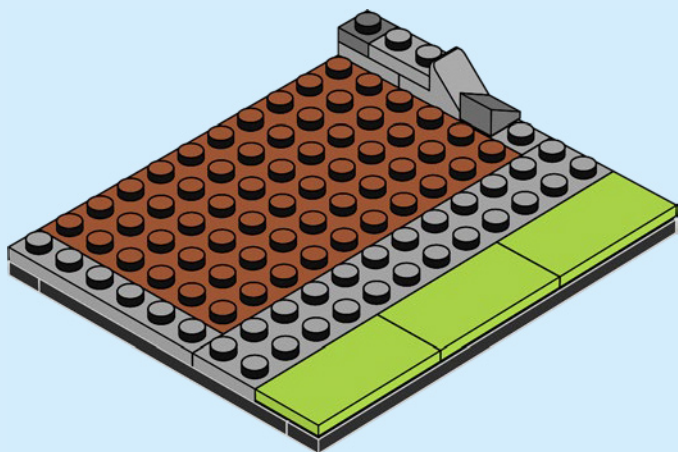

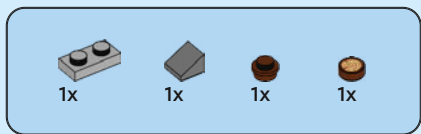

10

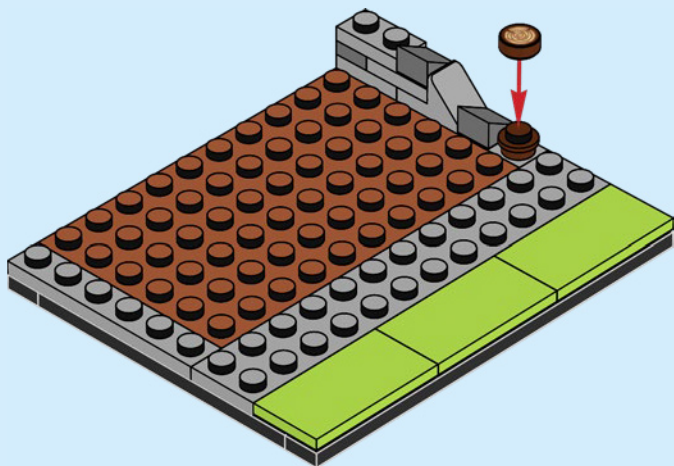



1x



1x

11

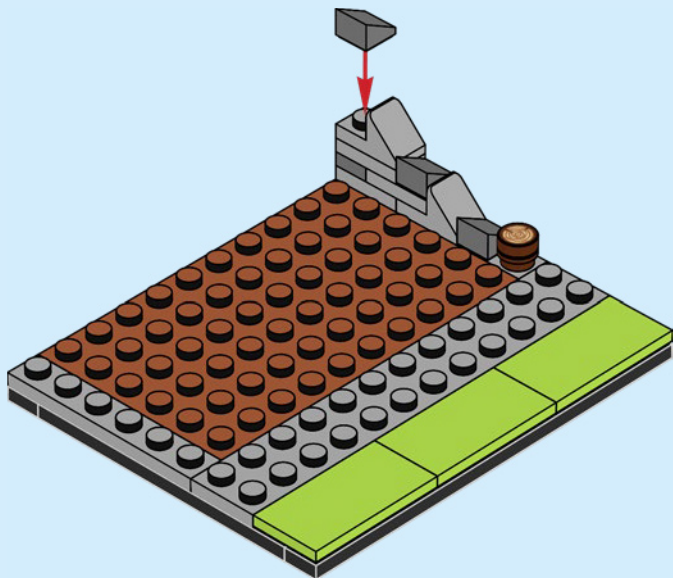



2x

12

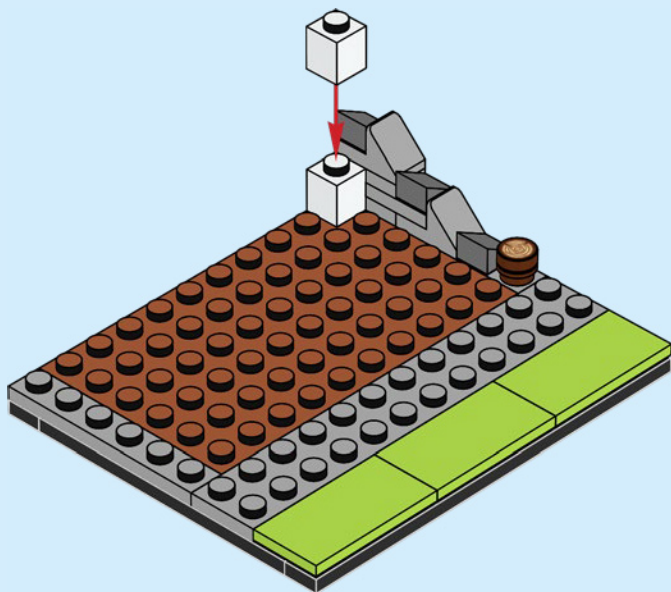

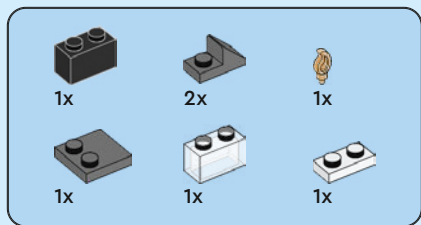

13

1



2

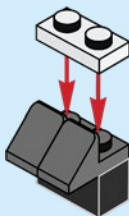

3

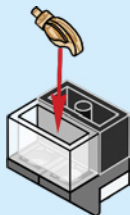

4

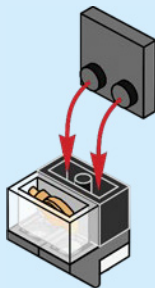

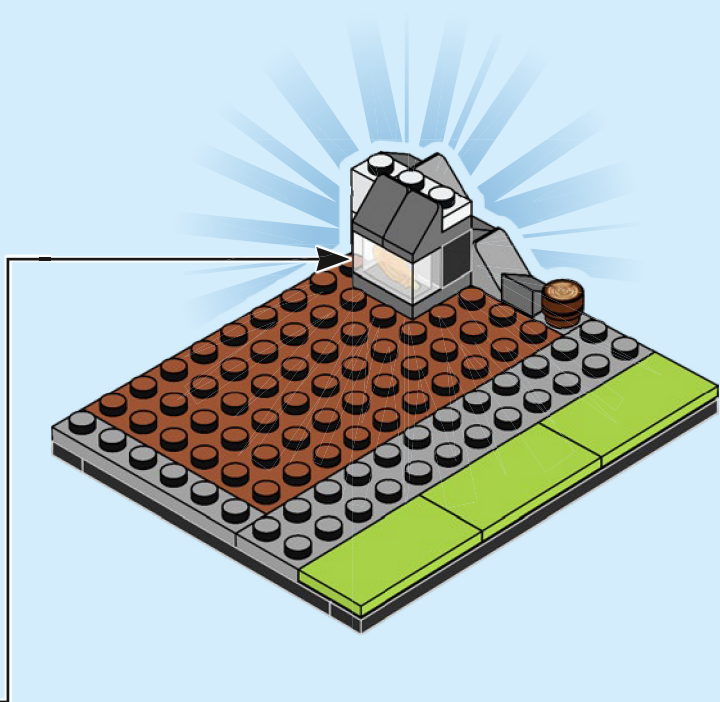

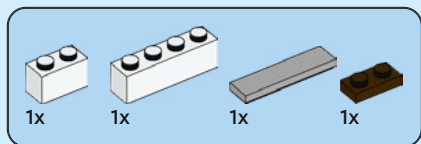

14

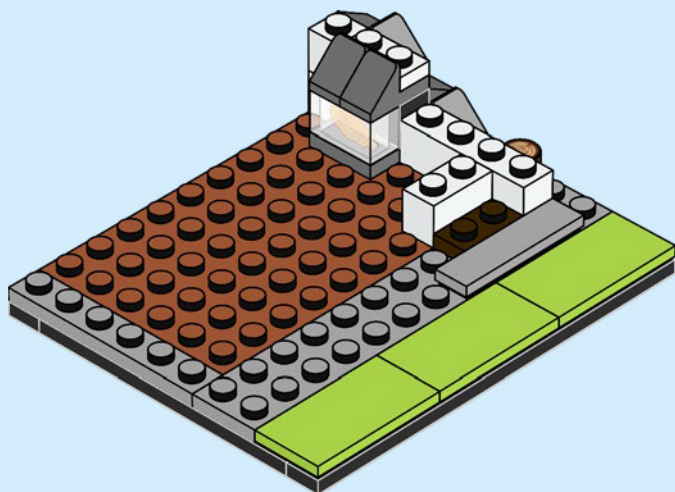

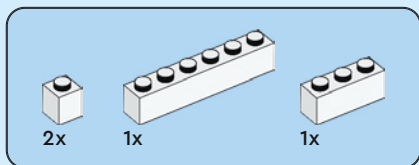

15

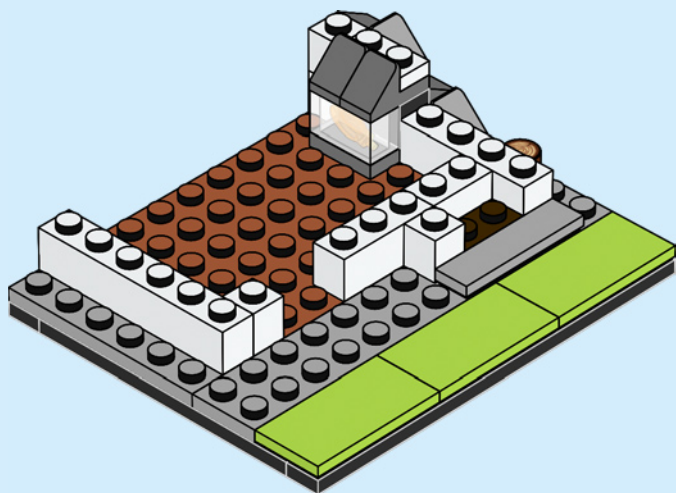



16

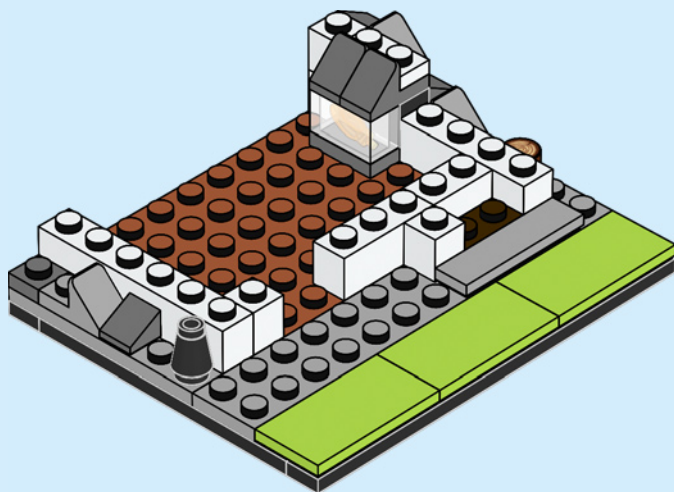



1x



1x



2x

17

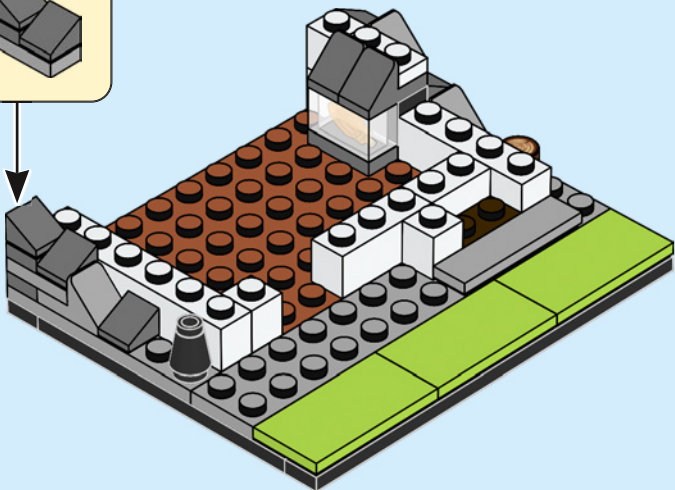
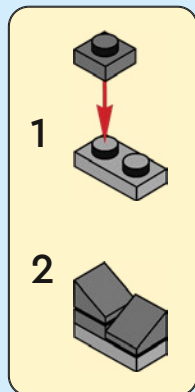



1x



2x



1x

18

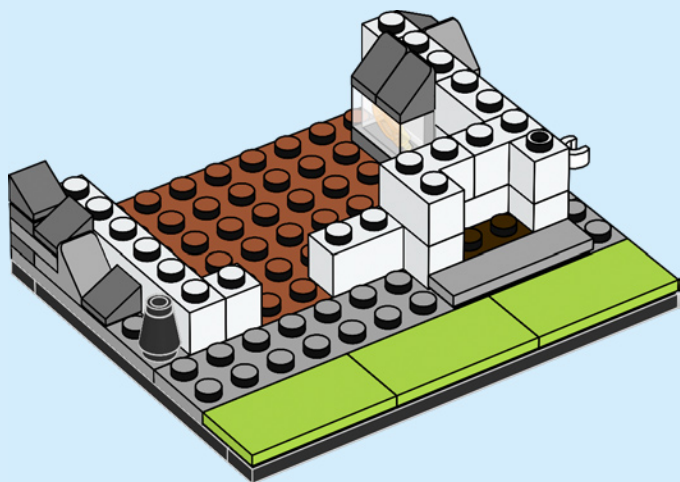



2x



1x

19

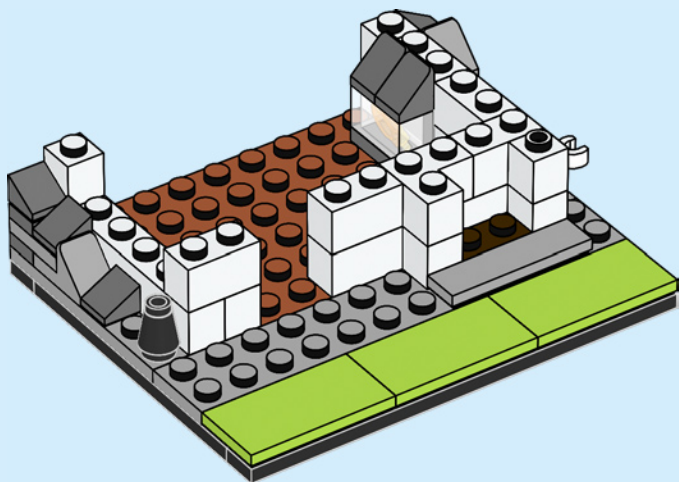

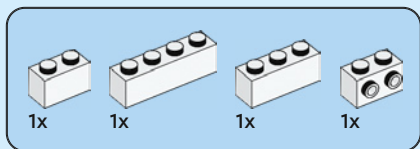

20

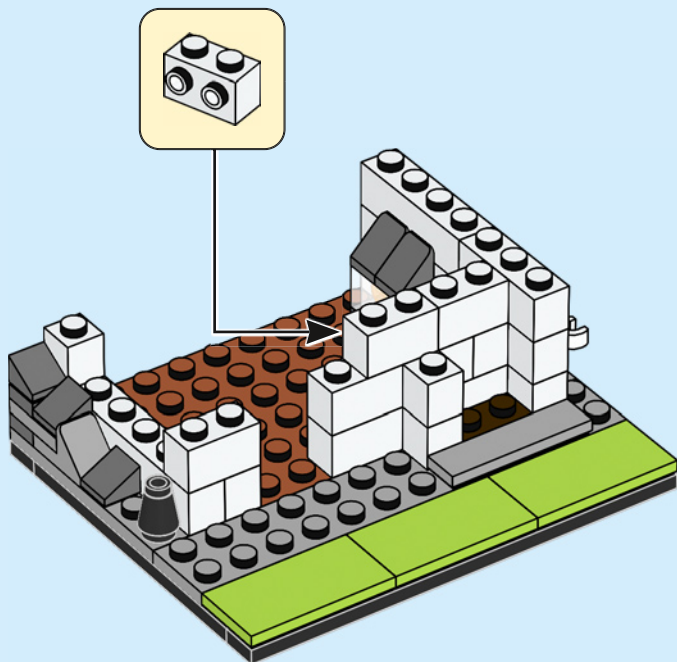



3x



1x



1x

21

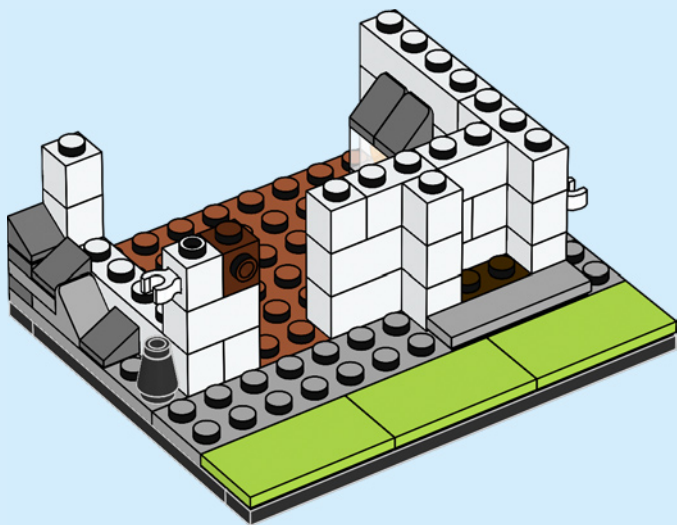



2x



2x



2x

22

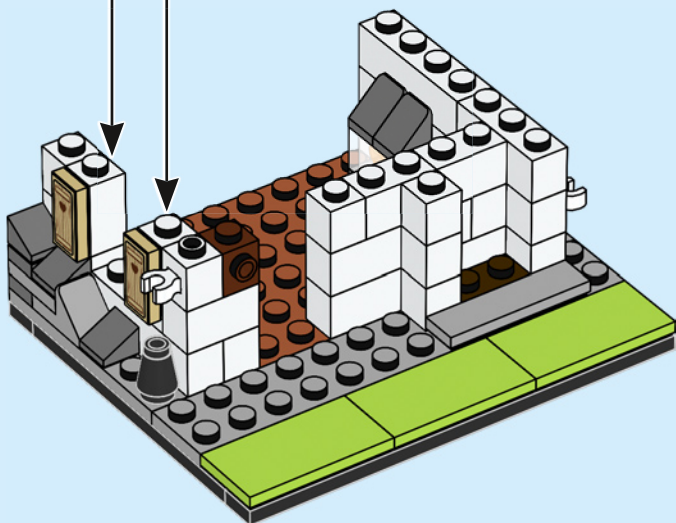
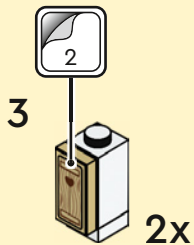
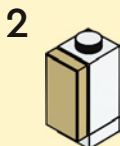
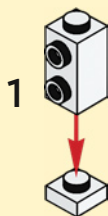

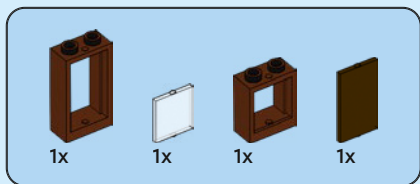

23

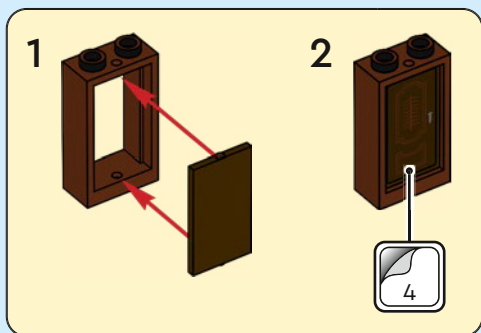
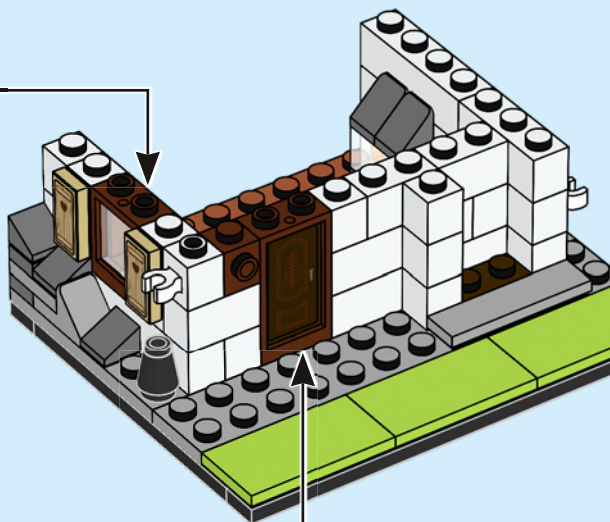
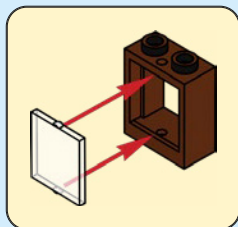



2x



2x

24

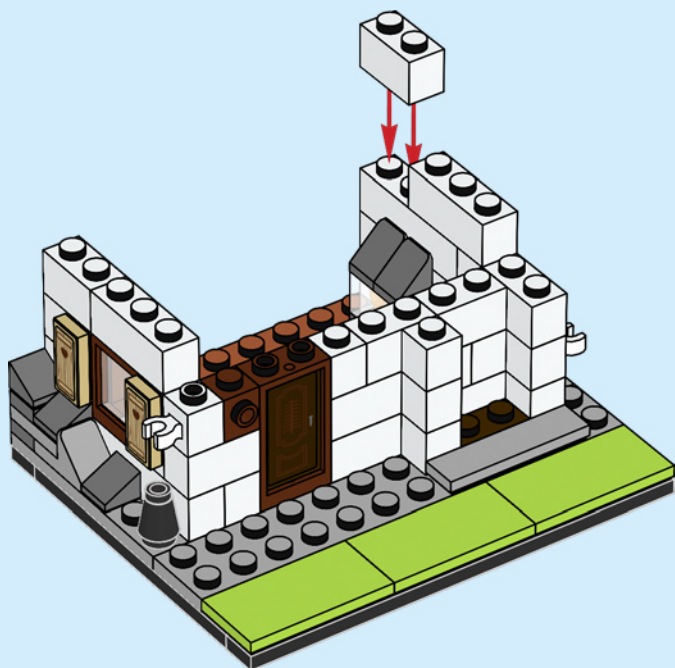

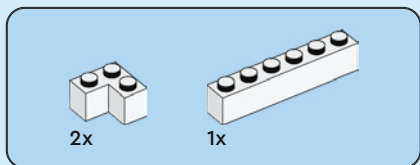

25

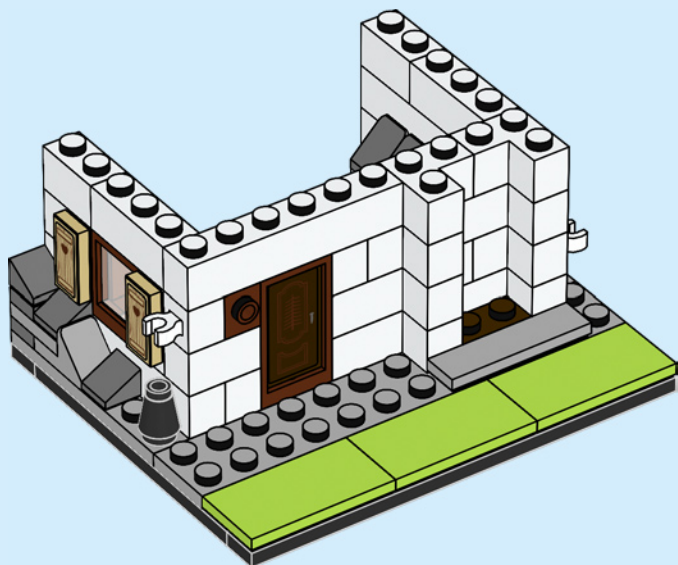

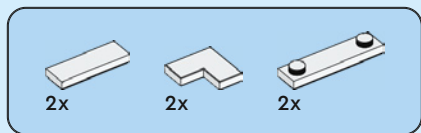

26

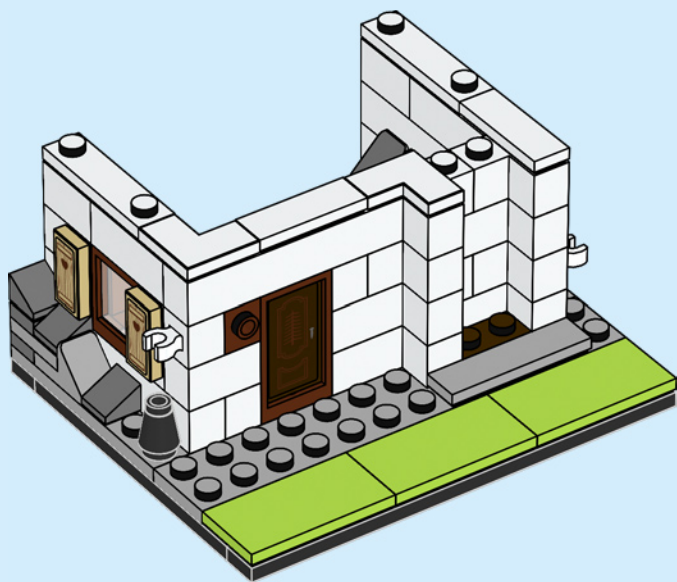

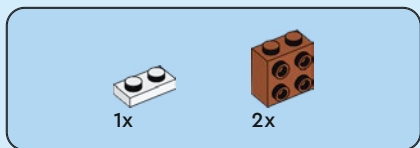

27

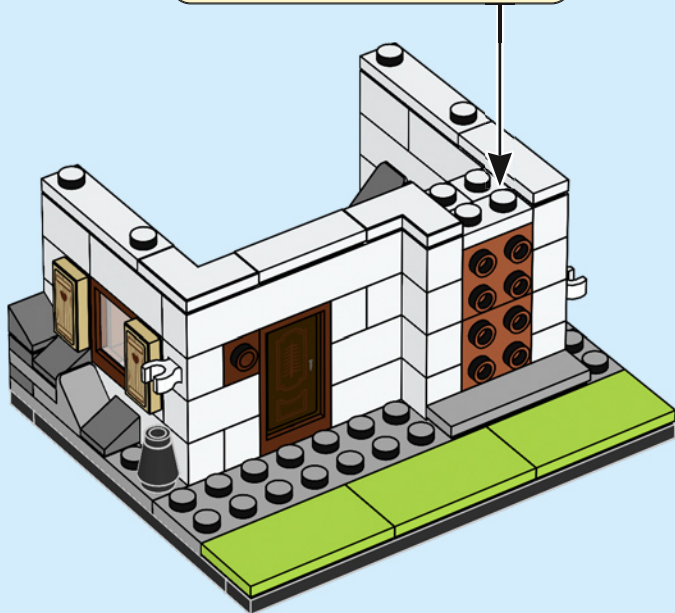
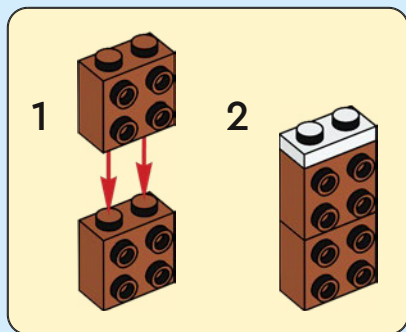



1x



1x

28

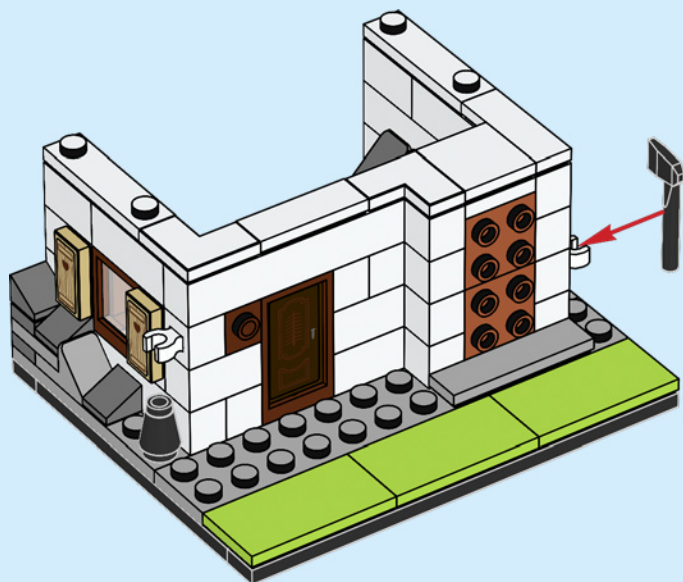



29

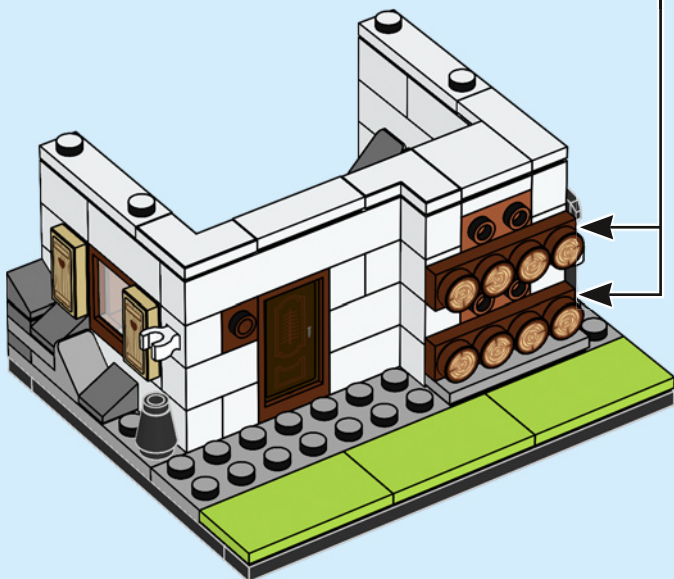



2x



6x

30

1



2



2x

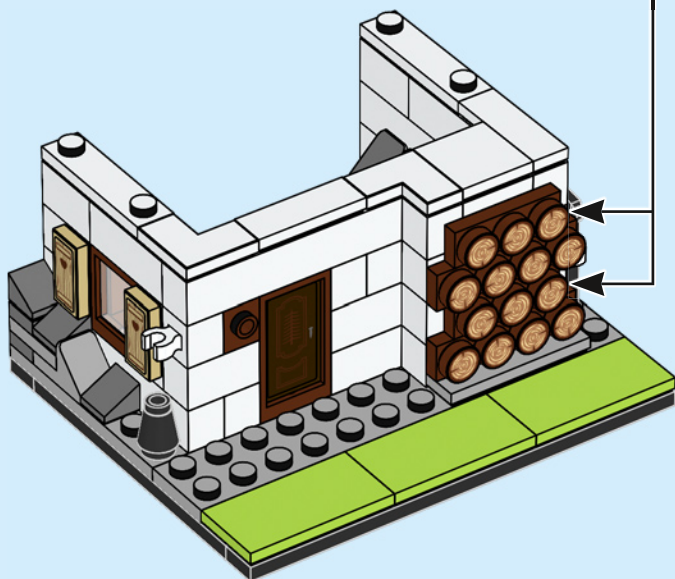



31

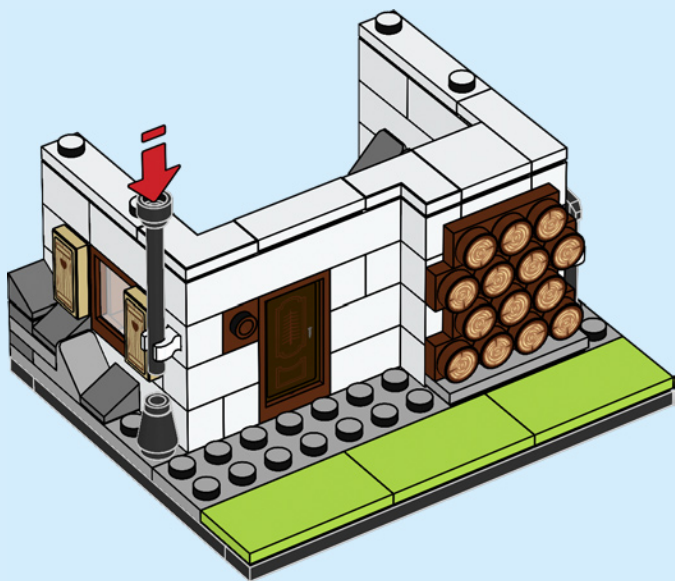

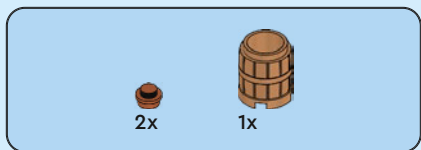

32

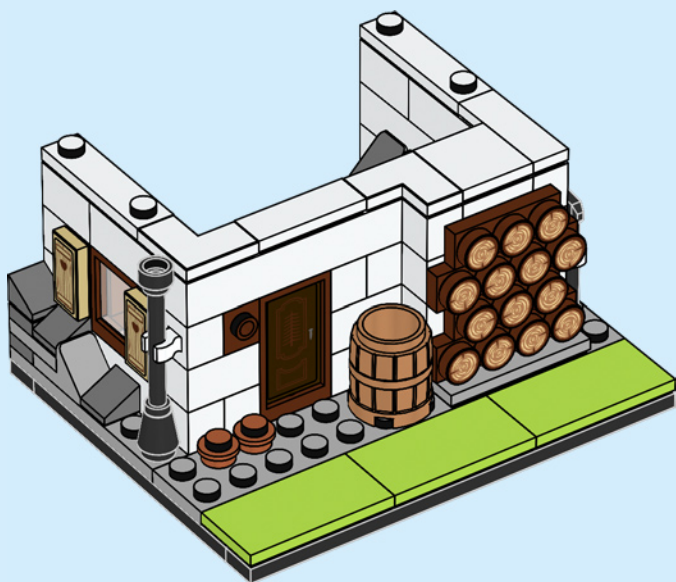

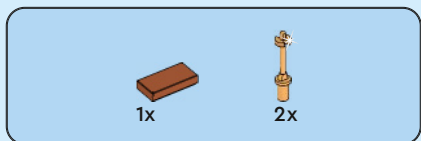

33

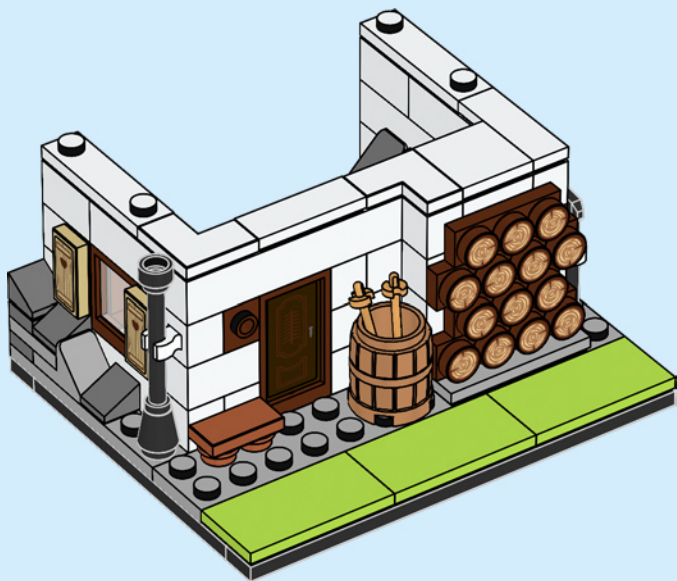



1x



1x



1x

34

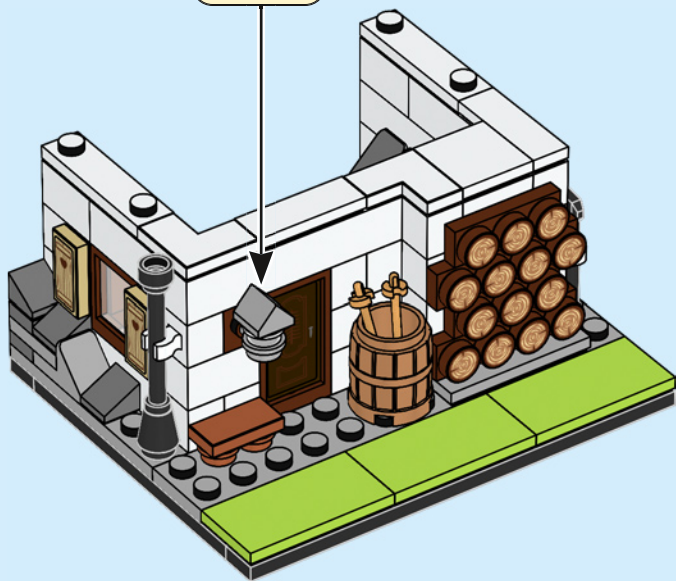
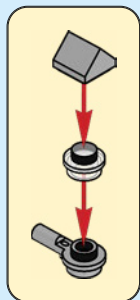



1x



1x



1x



1x

35

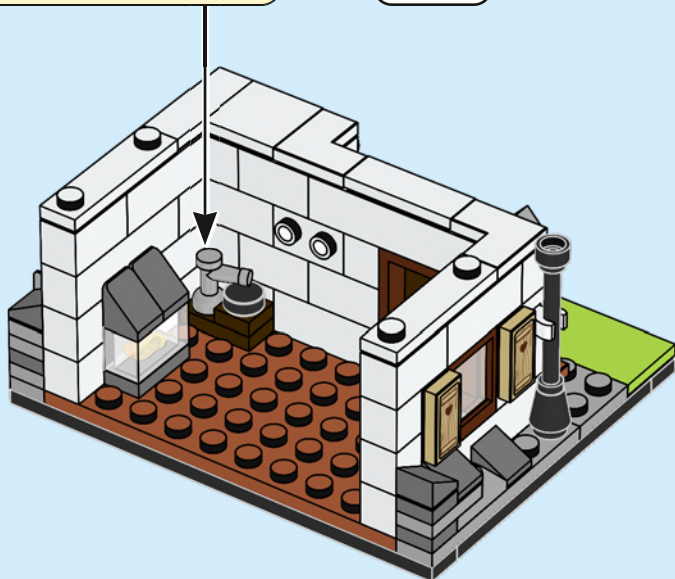
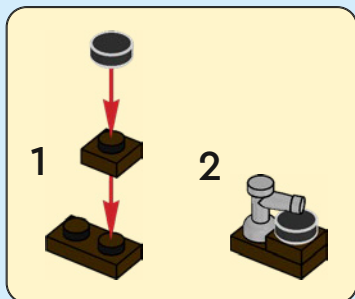



1x



2x



1x

36

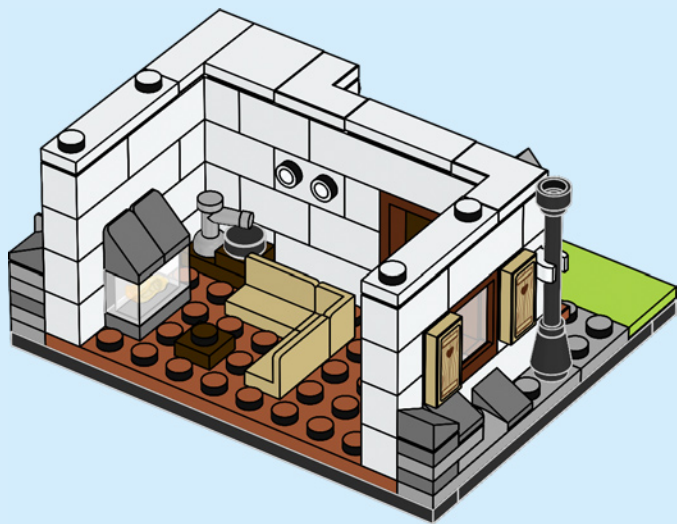

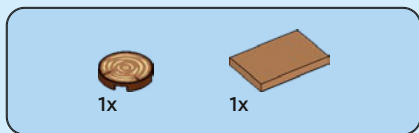

37

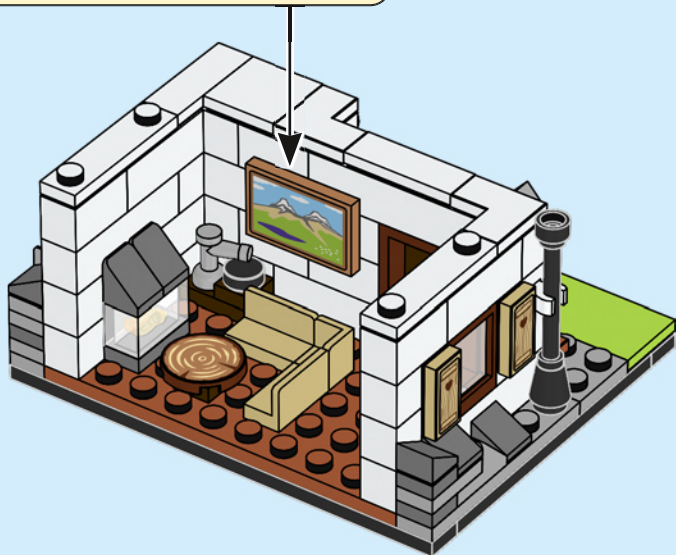
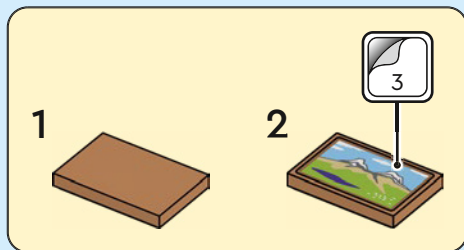



1x



2x



1x

38

1

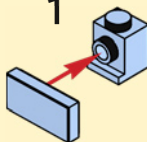

2

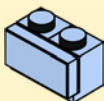

3



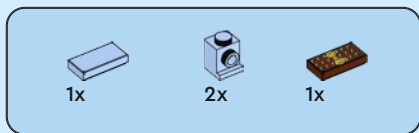

39

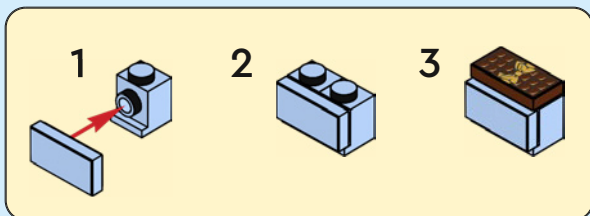

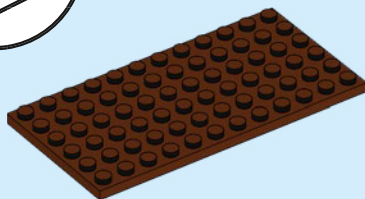
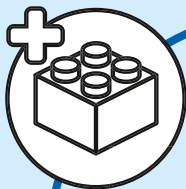

1x



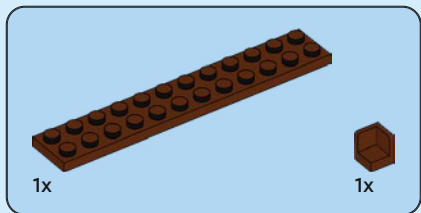

40

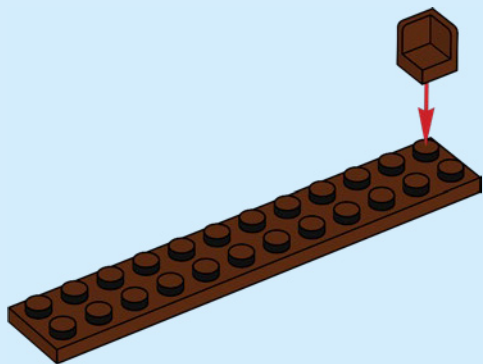

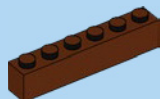

2x



1x

41

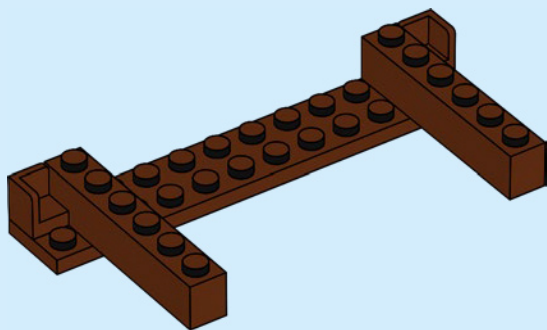

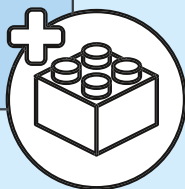
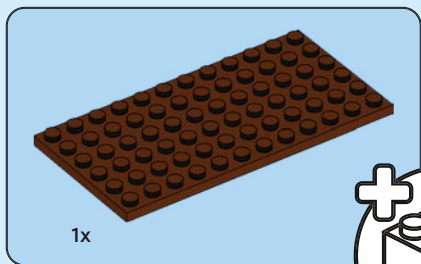

42

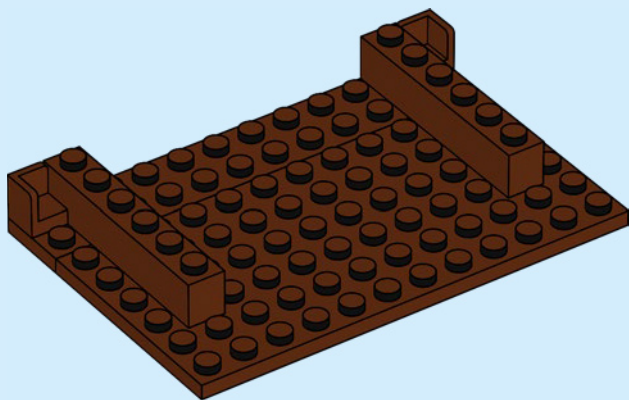



2x

43

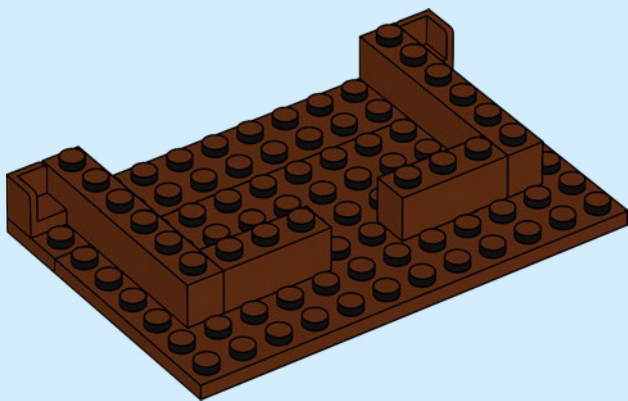

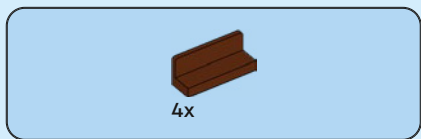

44

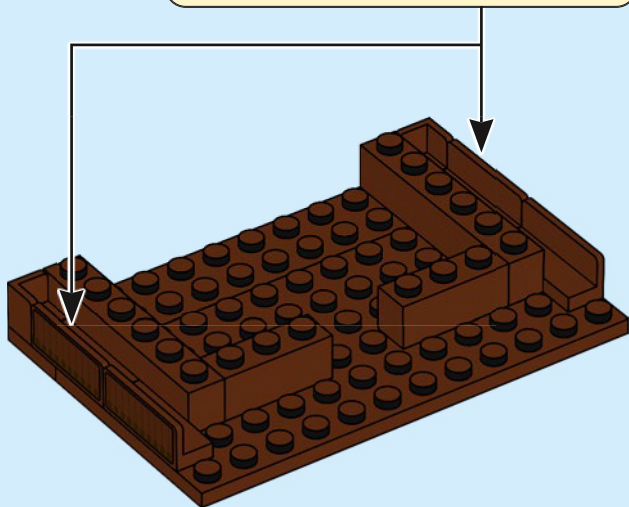
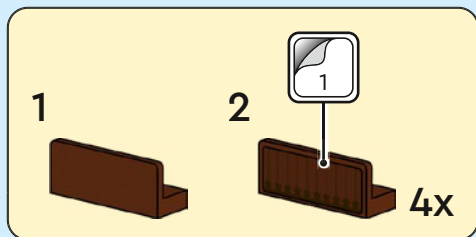



4x



4x

45

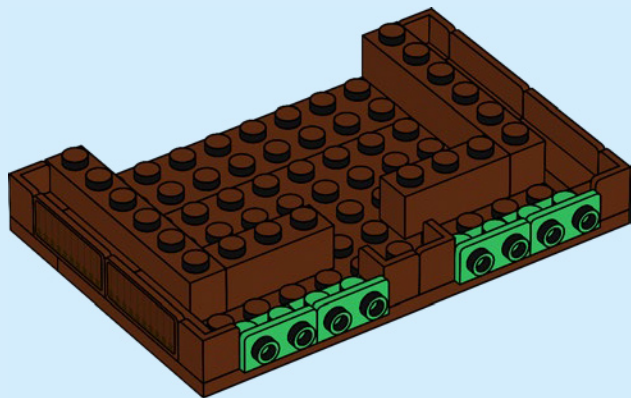



1x



2x

46

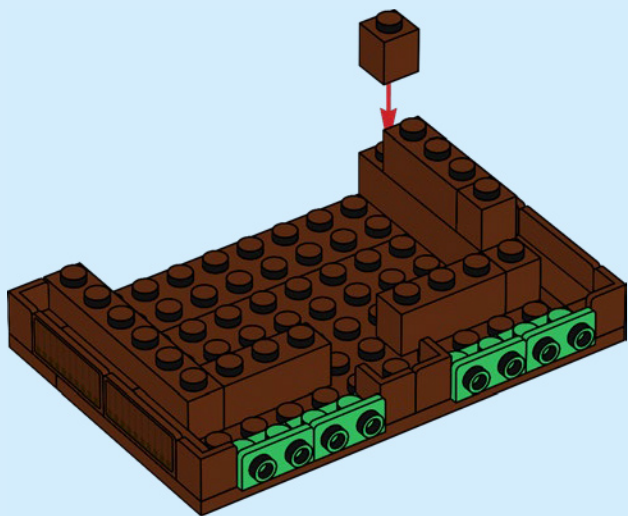



2x



1x



1x

47

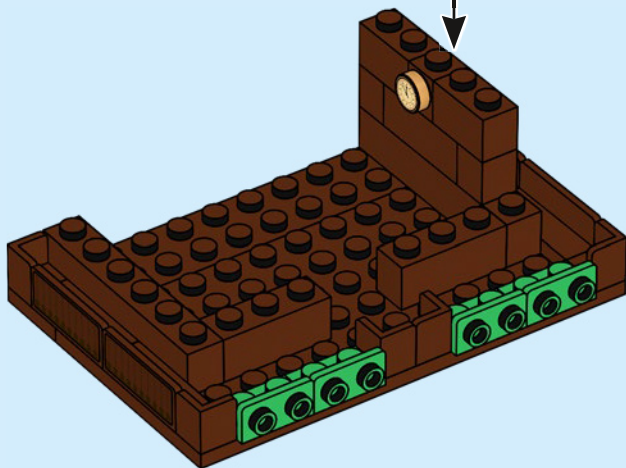
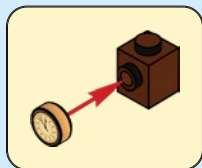



2x

48

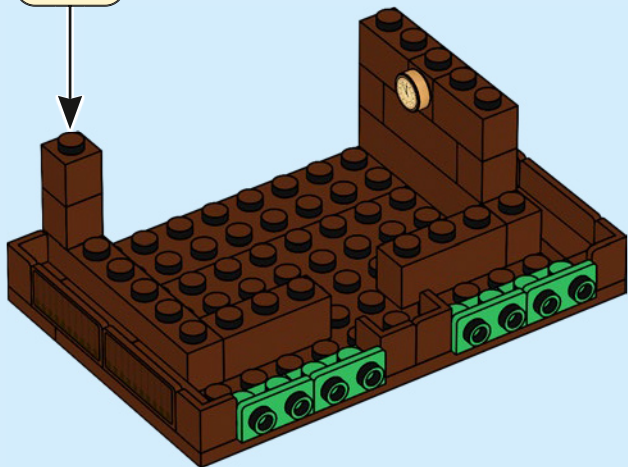
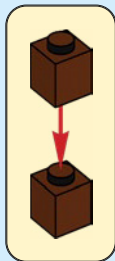



6x



6x



6x

49

1

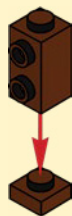

2



3



6x

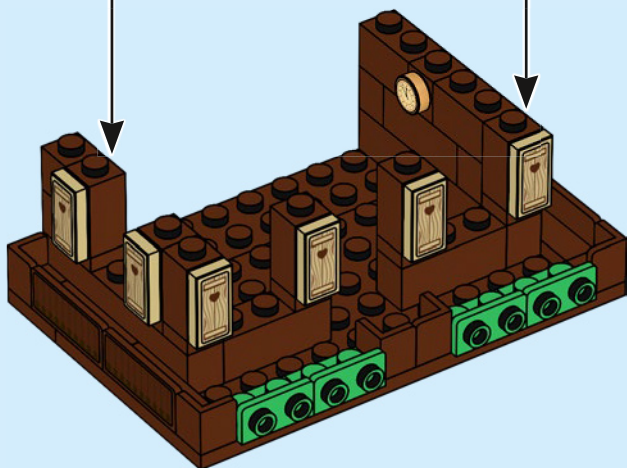

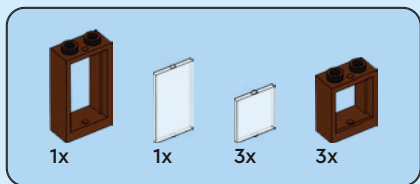

50

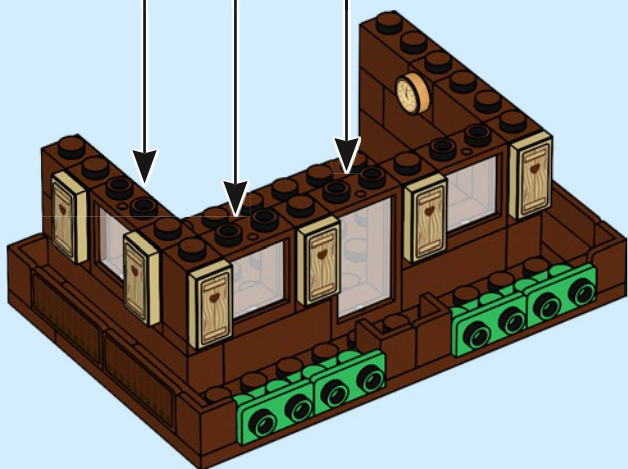
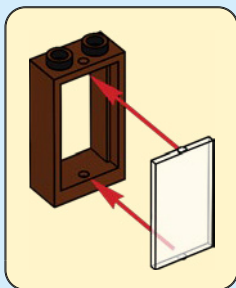
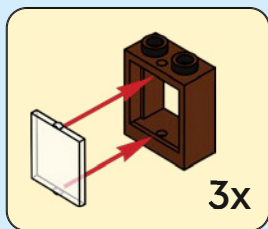

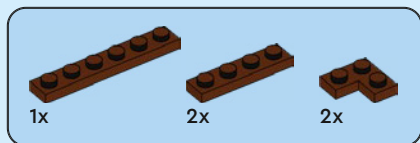

51

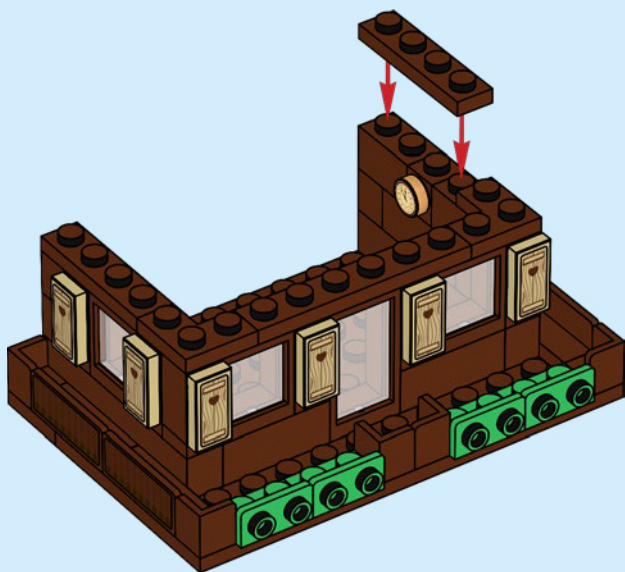



2x



2x

52

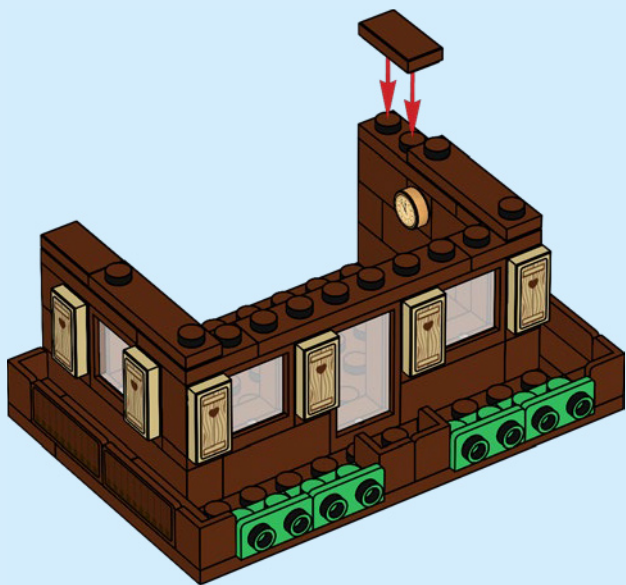

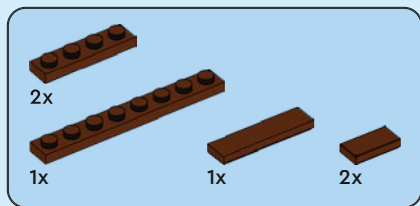

53

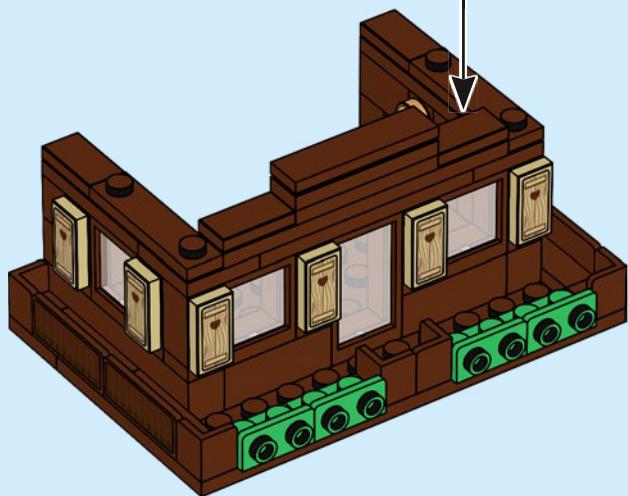
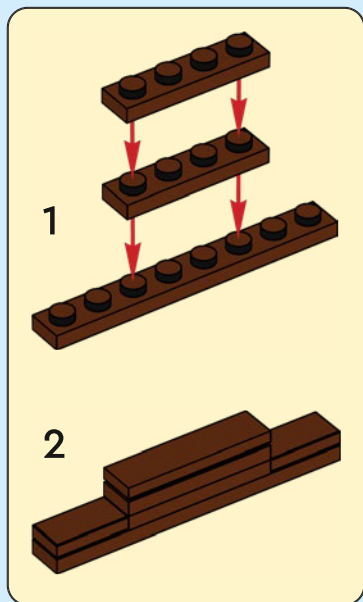



2x



2x

54

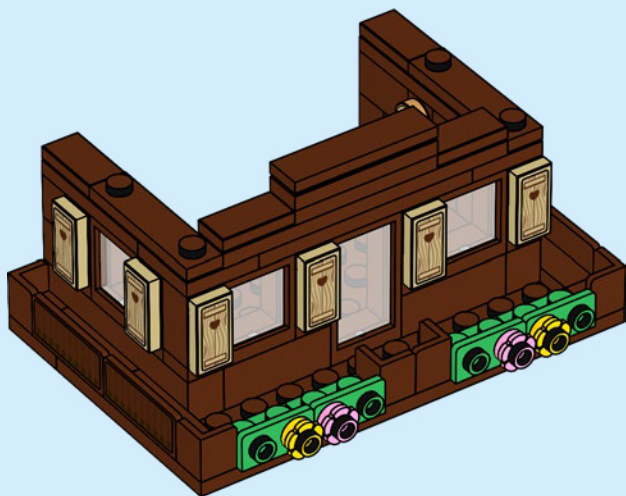



4x



4x

55

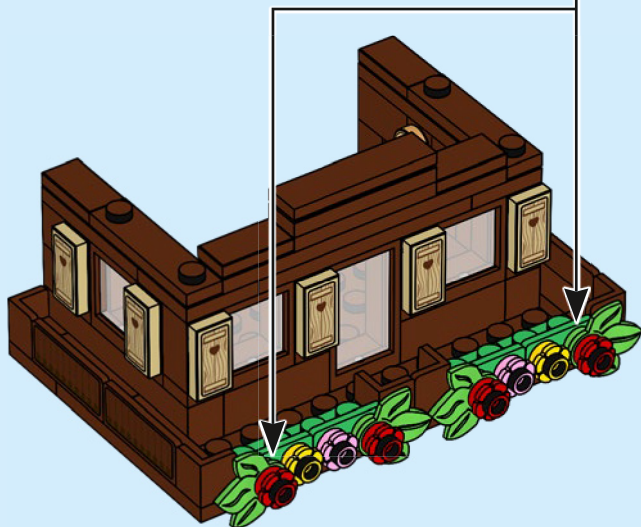
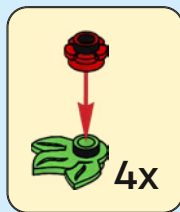



1x



2x

56





1x



2x

57

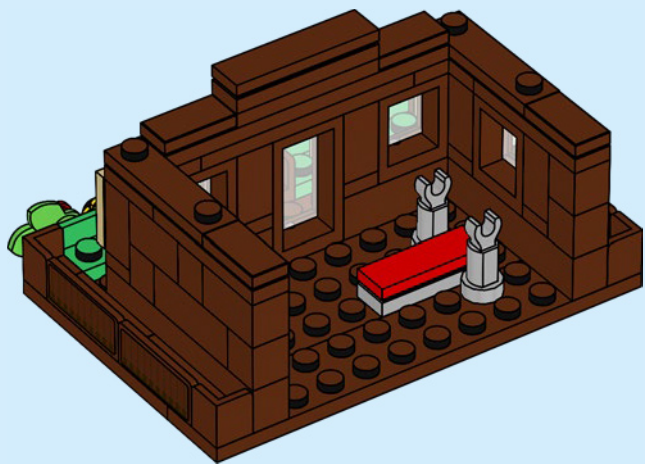



58

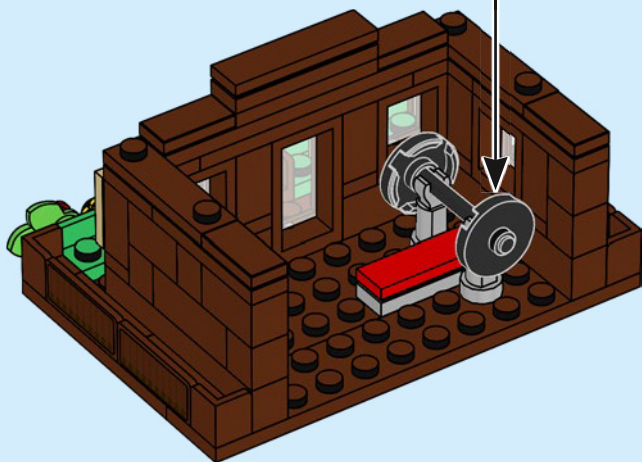
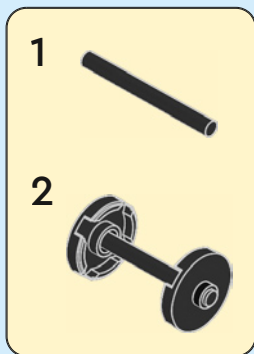



2x



2x



2x

59

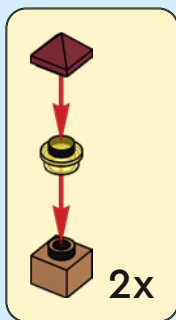

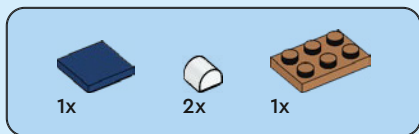

60

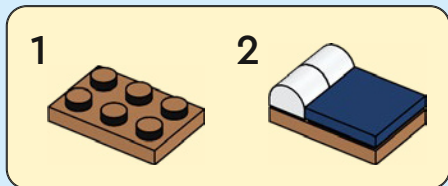

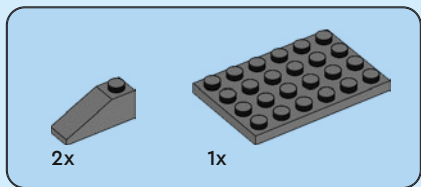
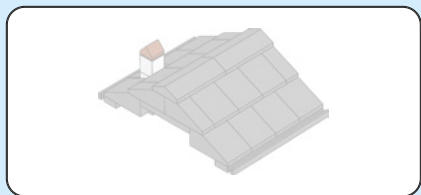

61

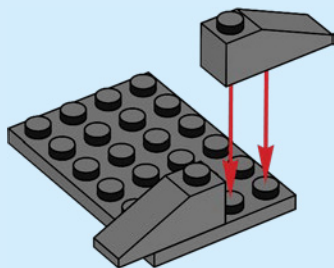

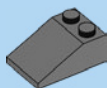

6x

62

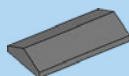
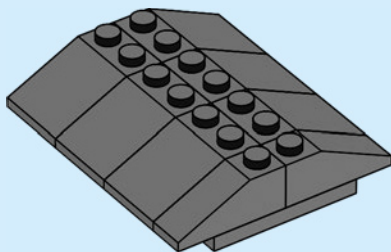

2x

63

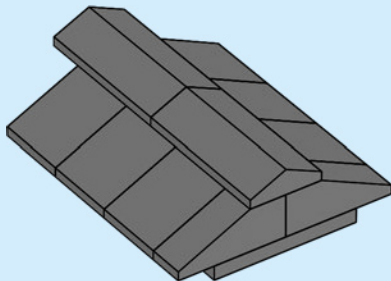

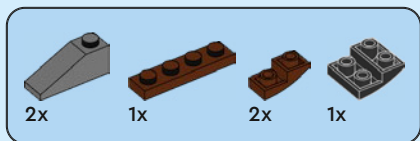

64

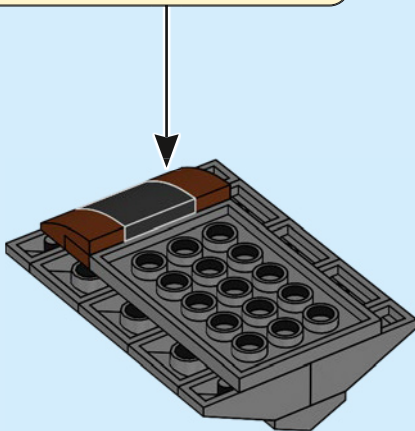
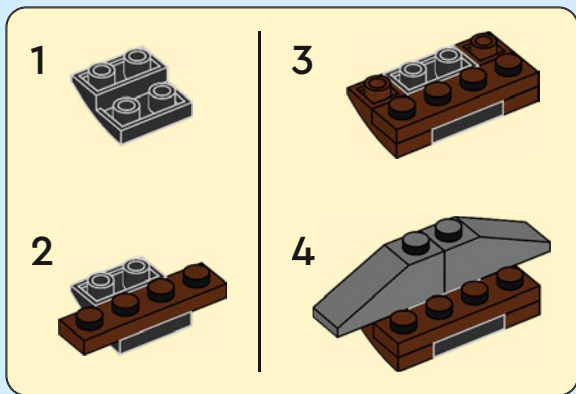

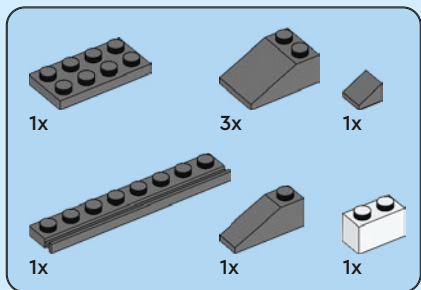
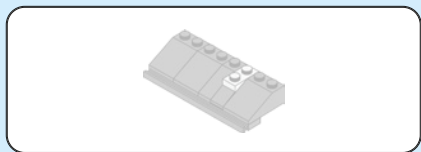

65

1

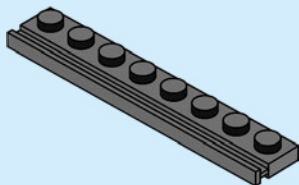

2

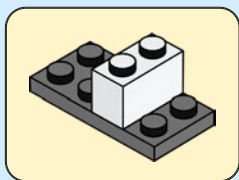
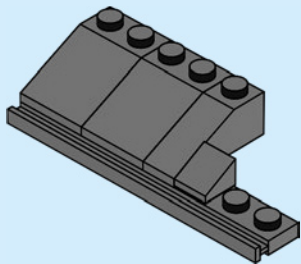

3

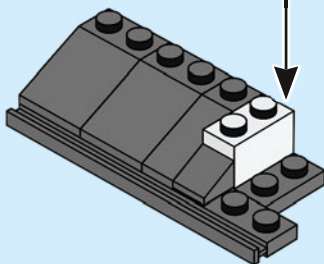

4

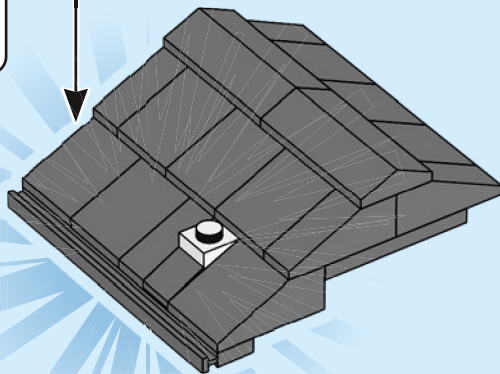
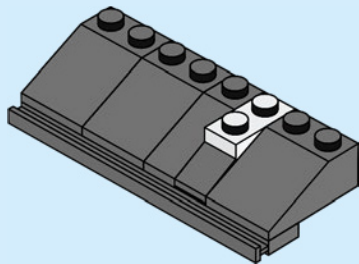

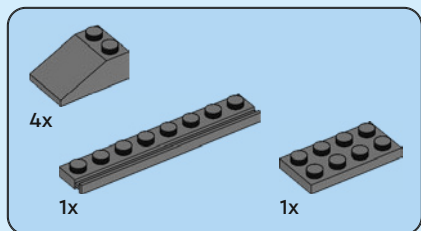

66

1

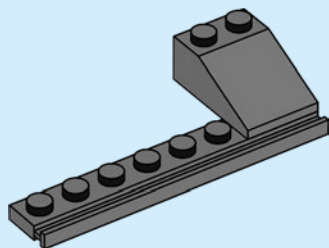

2

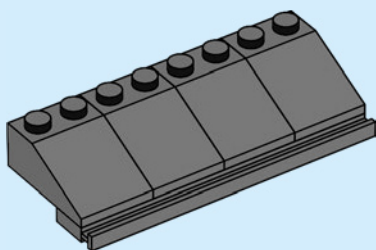



3

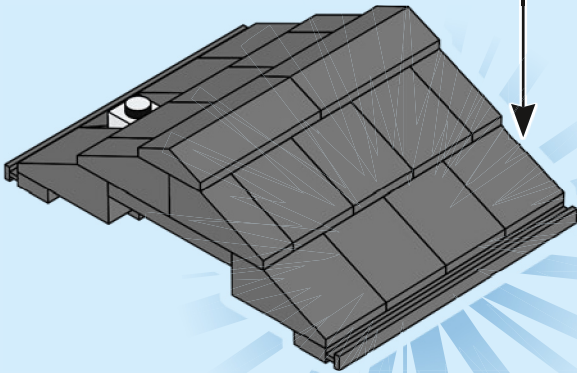
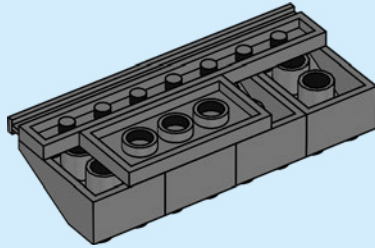



1x



1x

67

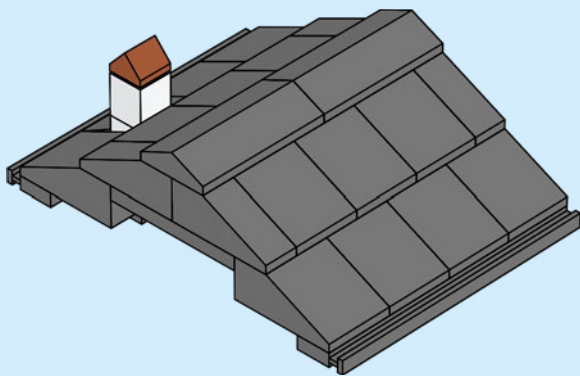

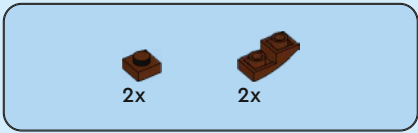

68

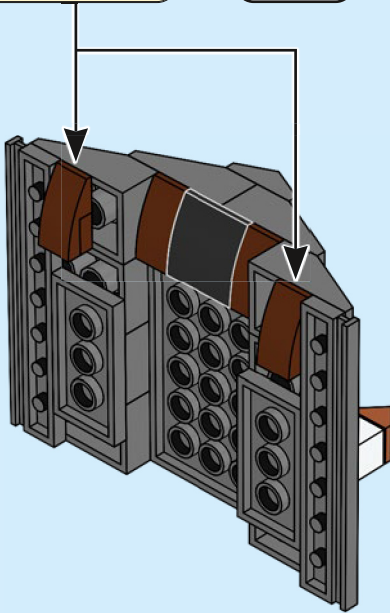
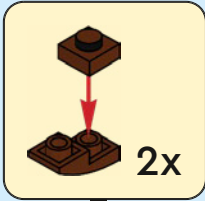

69



70





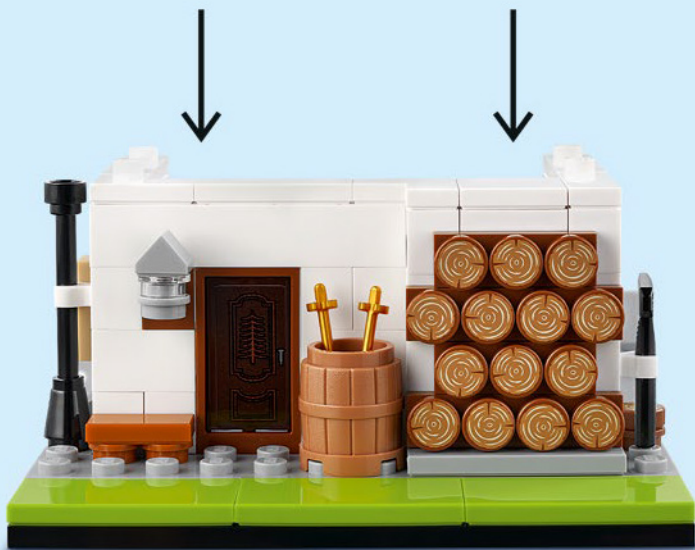



9x
300501

2x
6218841

2x
302401

2x
6258135

2x
6321349

2x
302301

9x
300401

1x
6058177

2x
6058329



3x
235701



1x
306801

2x
4558168

2x
6249091

4x
362201

2x
301001

2x
300901

1x
4612603

2x
6146221

8x
4114026

4x
6206148

1x
4533742

3x
6212989

1x
4529236

1x
6284070

2x
6195325



1x
300426



1x
6211476

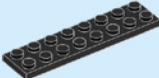

1x
383526

1x
6116604

1x
395726

4x
303426

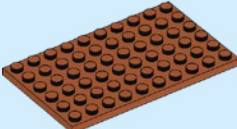
2x
4514845

1x
6263971

2x
6315782

1x
6374150

2x
6361813

1x
4614158

1x
4205004

2x
6398466

2x
6240216

2x
6299813

1x
6338182

1x
6357747

4x
6099243

4x
6182261

8x
4221744

4x
4211242

1x
6182435

1x
6139435

4x
6382102

4x
4211151

2x
4211149

4x
6172922

2x
6058084

2x
4211257

6x
6201911

4x
6316282

3x
4211220

2x
4211152

7x
4211190

1x
4211194

2x
6257604

2x
4211193

1x
4221590

1x
4216945

1x
4225700

1x
4264669

15x
6285623

1x
4216581

2x
6062574

6x
4645400

1x
6253436

1x
6227897

3x
6093859

4x
4211398

1x
4211429

1x
4211356

2x
4211438

1x
4211360

2x
6355025

2x
6258831

1x
4211503

2x
6212501

4x
6387434

2x
6097861

2x
6194729

1x
6395795

2x
6058221



7x
4504378



3x
4210719



2x
6069164



1x
6309059



5x
4211045



13x
4211106



2x
4211065



2x
6189120



1x
4211115



2x
4210967



2x
6383946



1x
6365629



1x
6187006



1x
6334099



1x
6240030



1x
6252258



4x
6254552



1x
6244904



2x
6292254



1x
6372427



 [LEGO.com/service](https://www.lego.com/service)

YOU COULD

WIN



Scan this QR code or go to **LEGO.COM/PRODUCTFEEDBACK** and give us your short feedback about this LEGO® set for a chance to win a cool LEGO prize.

Terms and Conditions apply*

EN: YOU COULD WIN. Terms and Conditions apply* **DE: Du könntest GEWINNEN.** Es gelten die Teilnahmebedingungen* **FR: Tu pourrais GAGNER.** Des conditions s'appliquent* **IT: Potresti VINCERE tu.** Termini e condizioni sono applicabili* **ES: Puedes GANAR.** Aplican términos y condiciones* **PT: Poderá GANHAR.** Aplicam-se termos e condições* **ZH: 轻松获奖. 条款和条件适用*** **PL: Szansa na WYGRANĄ.** Obowiązują warunki korzystania* **CS: Máte šanci VYHRÁT.** Platí všeobecné smluvní podmínky* **SK: Máte šancu VYHRAŤ.** Platia všeobecné zmluvné podmienky* **HU: TE IS NYERHETSZ.** Felhasználási feltételek érvényesek* **RO: Ai putea CÂȘTIGA.** Se aplică termenii și condiții* **BG: Можете да СПЕЧЕЛИТЕ.** Има определени правила и условия* **LV: Tu vari LAIMĒT.** Ir spēkā noteikumi un nosacījumi.* **ET: Sul on võimalus VÕITA.** Kehtivad tingimused* **LT: Jūs galite LAIMĖTI.** Taikomos sąlygos*

*[LEGO.com/productfeedback-terms](https://www.lego.com/productfeedback-terms)