



**BRICK  
HEADZ**

40672



[LEGO.com/brickheadz](https://www.lego.com/brickheadz)



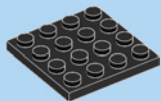

1x

1

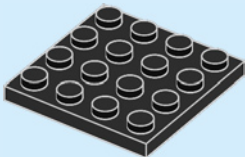



2x

2

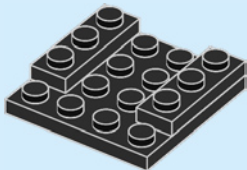



1x



1x



1x

3

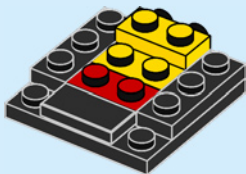



1x



1x

4

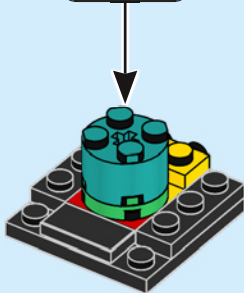
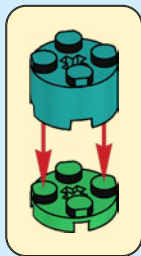



1x



1x

5

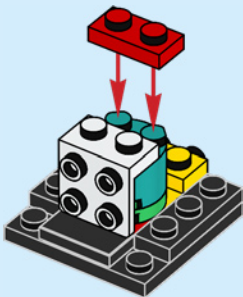



1x



1x



1x

# 6

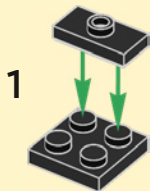

2

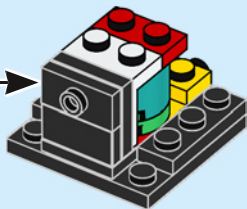
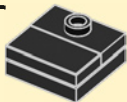





4x

7

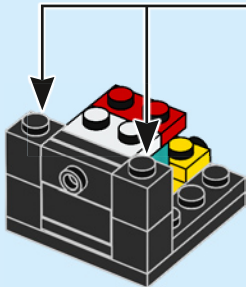

2x



2x

8

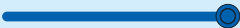
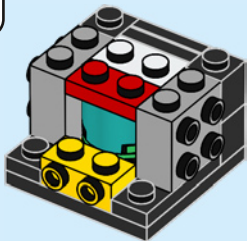



1x



2x



2x

9

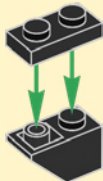

2x

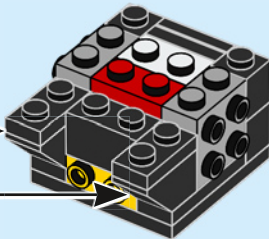



2x

10

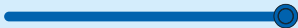
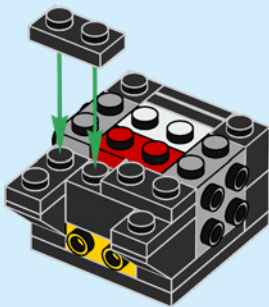

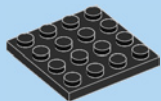

1x

11

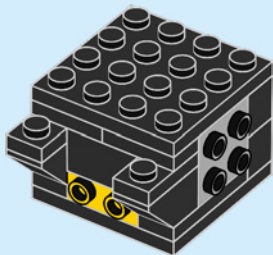



2x



2x



2x

# 12

1

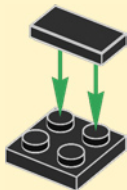

2



2x

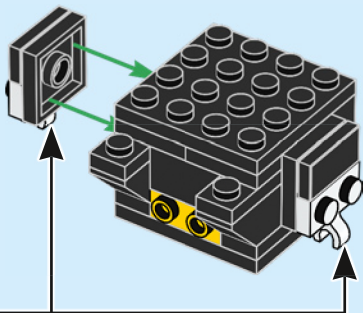



1x

13

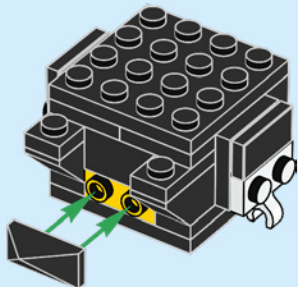



1x



1x

14

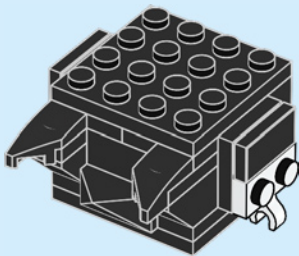





4x

15

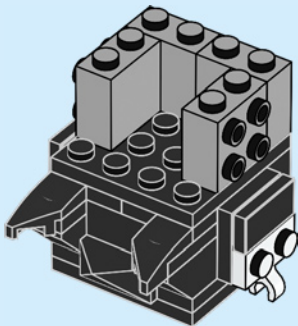



1x



2x



1x

# 16

1

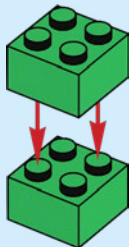

2

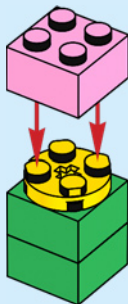

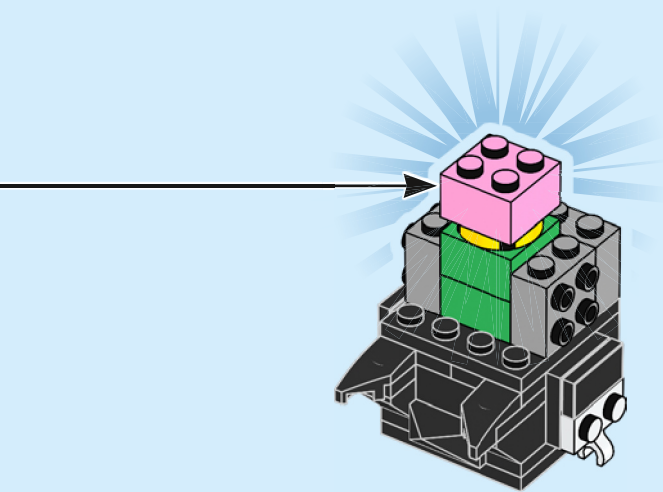



2x

17

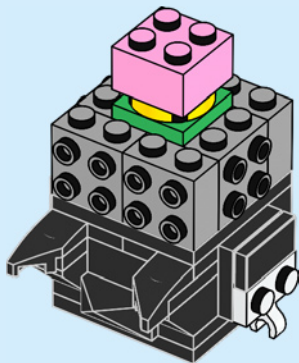



6x

18

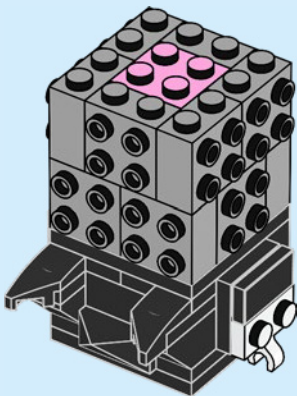

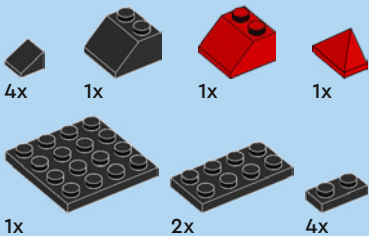

19

1

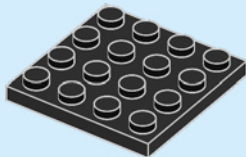

2

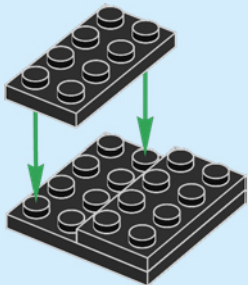

3

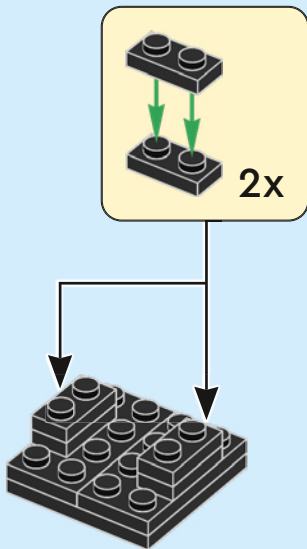

4

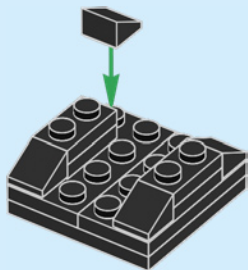

5

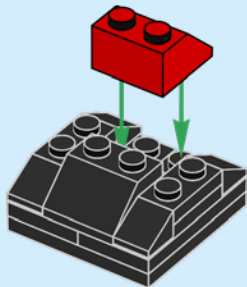



6

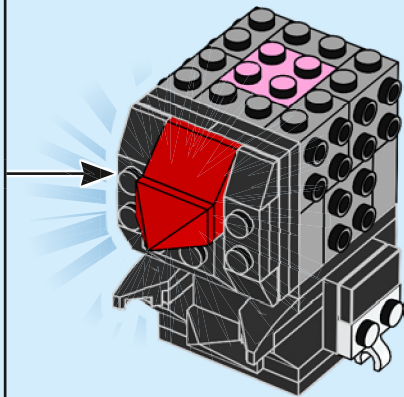
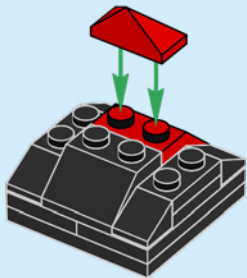



2x



2x



2x

# 20

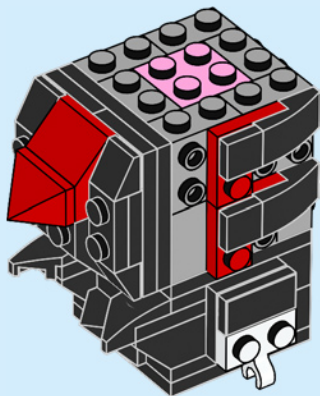

1



2



2x



2x

21

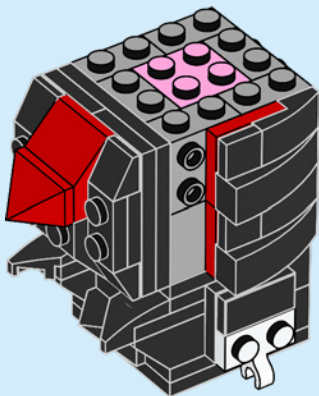

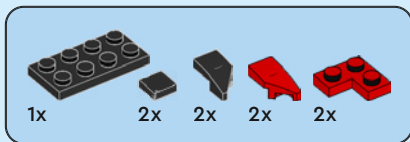

# 22

1

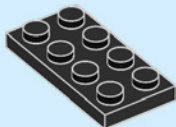

2

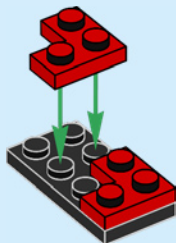

3

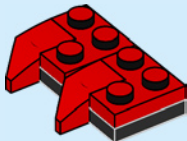

4

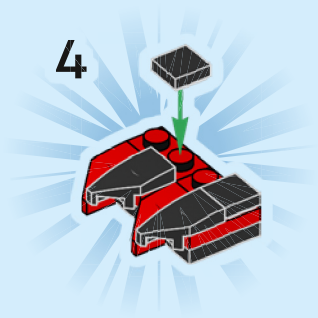

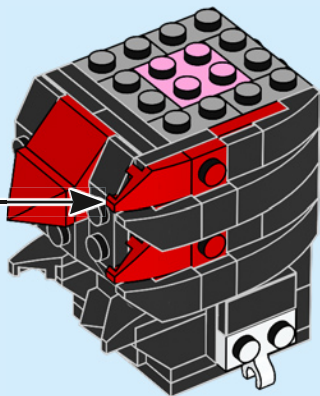

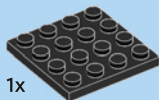

1x

23

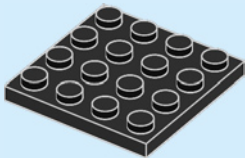



1x



2x



2x

# 24

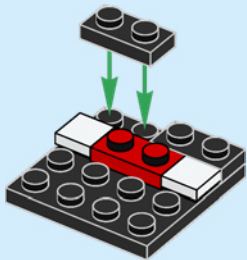





2x



1x

25

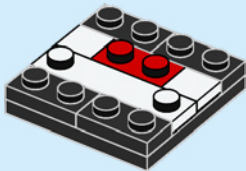



2x



1x

# 26

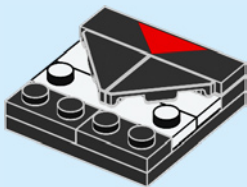



1x



2x



1x



2x

# 27

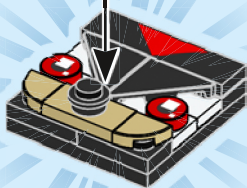
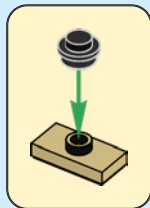

28

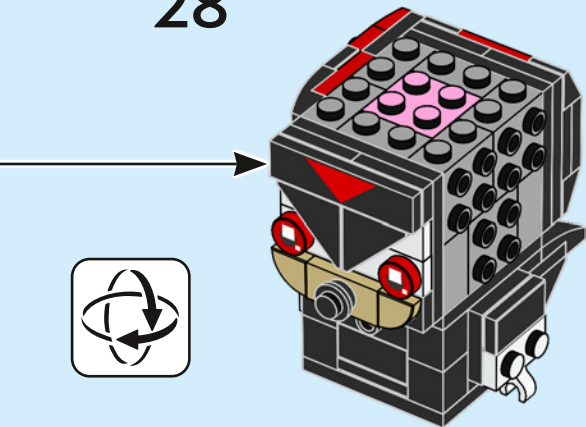



1x

29

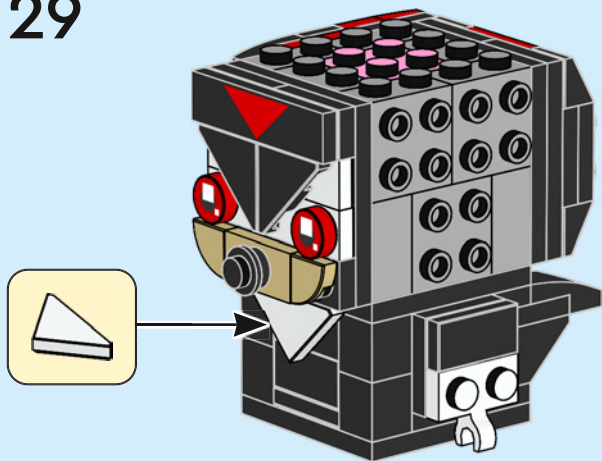

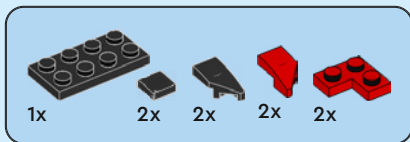

# 30

1

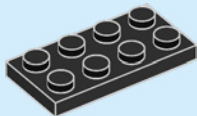

2

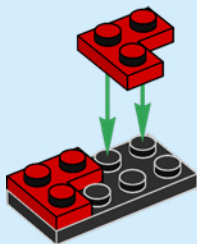

3

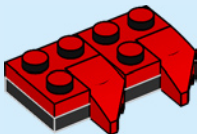

4

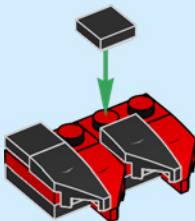

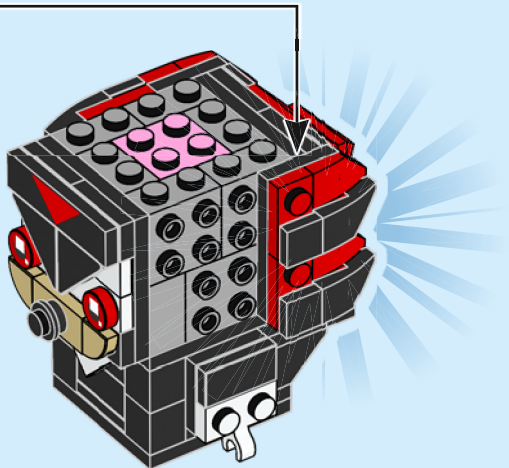





2x



2x



2x

# 31

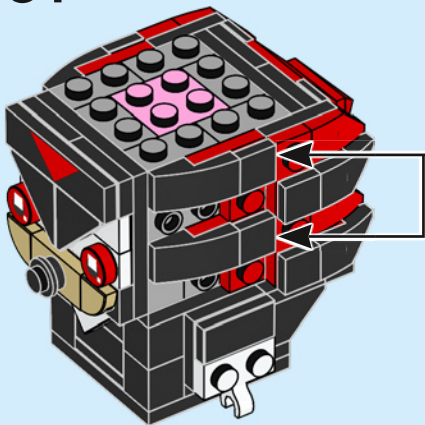

1



2

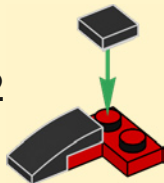

2x



2x

32

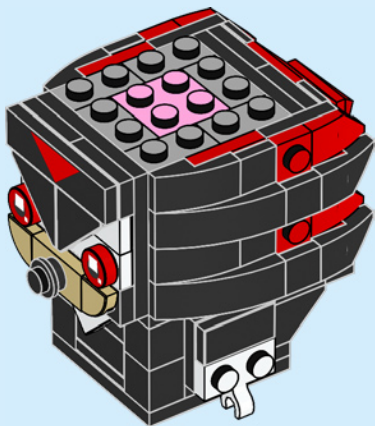

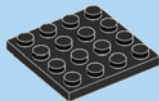

1x

33

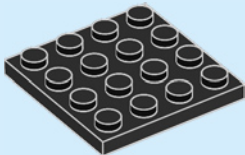



2x



2x



1x



1x

# 34

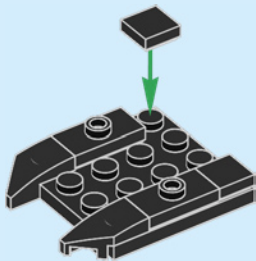



1x



1x



1x



1x

# 35

1

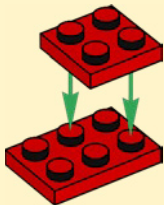

2

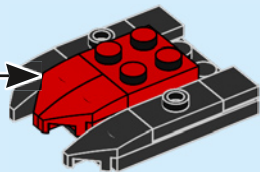
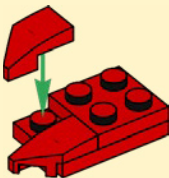

36

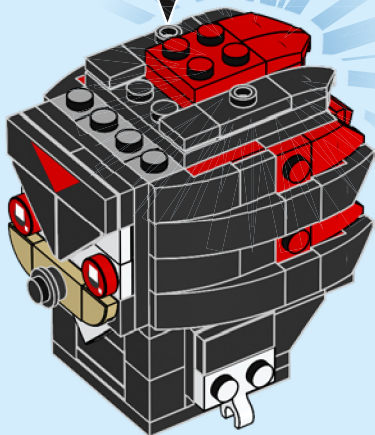



2x



1x



1x

# 37

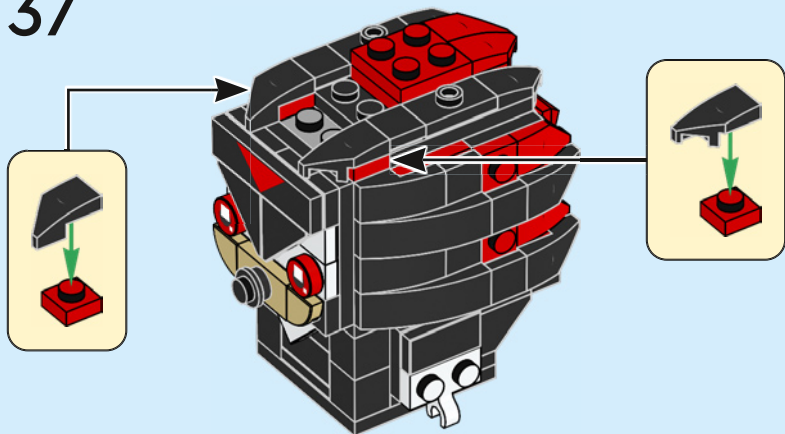



1x

38

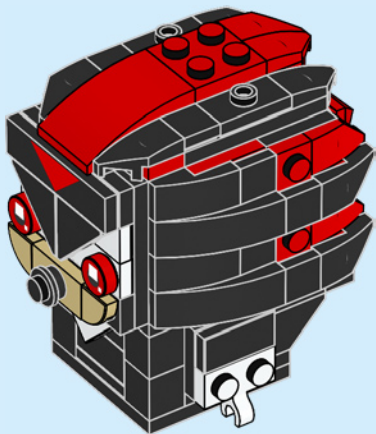





1x



1x



1x

# 39

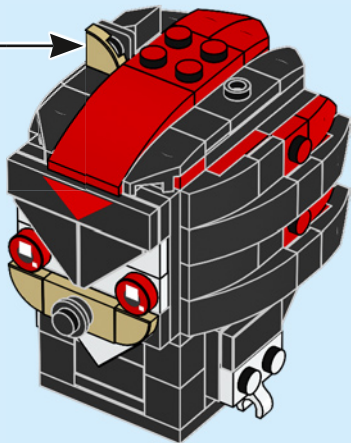
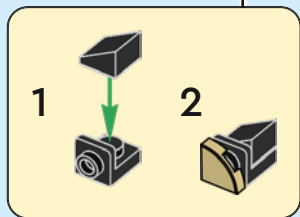



1x



1x



1x

# 40

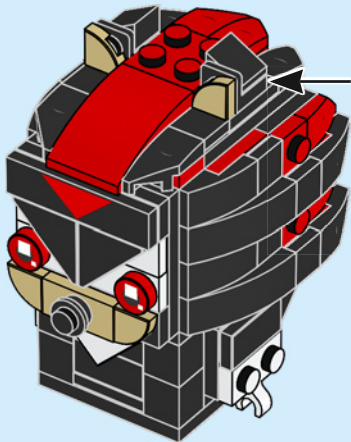

1



2



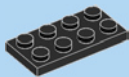

1x

41

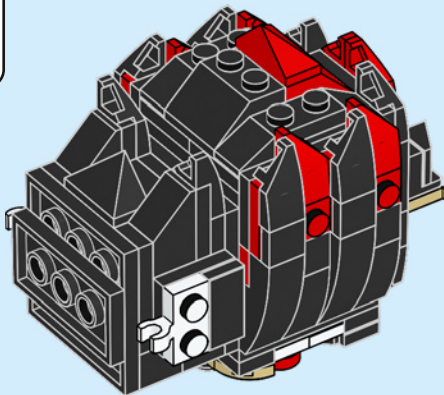



2x



2x



2x



2x



4x

42

1



2

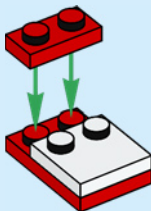

3

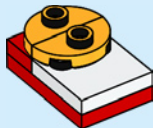

2x

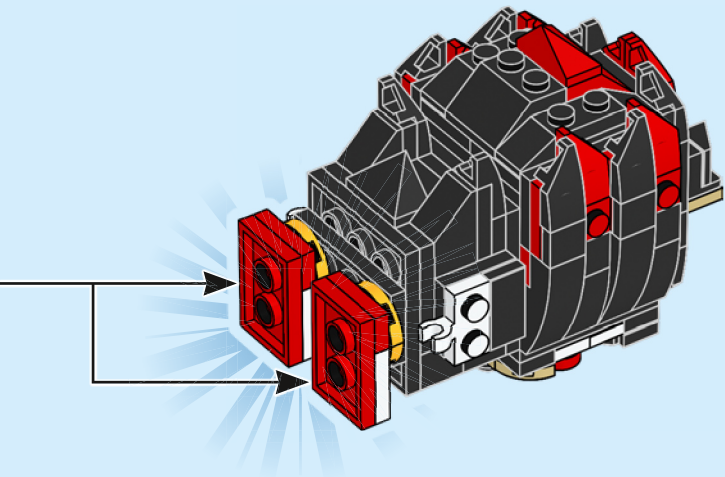

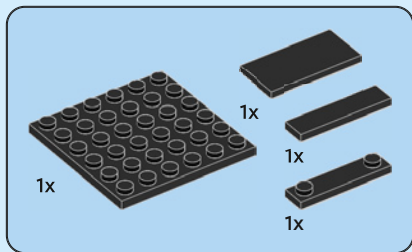

# 43

1

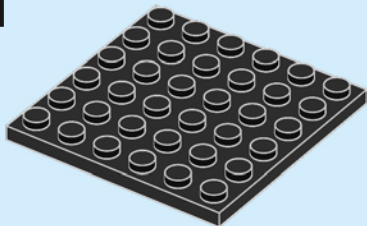

2

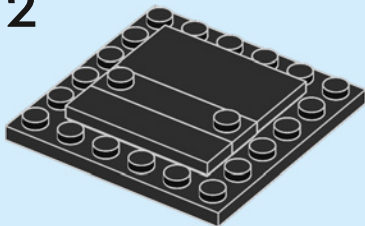

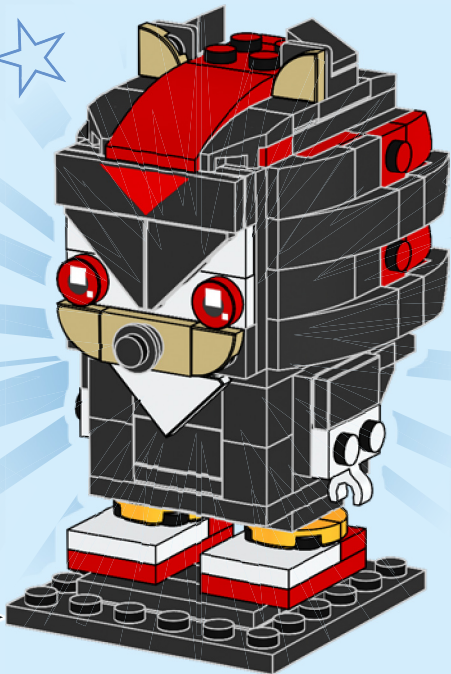



# BRICK HEADZ



**SONIC**<sup>TM</sup>  
THE HEDGEHOG

MILES "TAILS" PROWER 40628

**214**

SONIC THE HEDGEHOG<sup>TM</sup> 40627

**213**





9x  
6177505



19x  
302421



2x  
300521



9x  
6177507



1x  
4651524



1x  
6075074



14x  
302321



10x  
6092565



1x  
6313120



4x  
306921



9x  
6029946



2x  
6351892



3x  
302221



12x  
242021



1x  
303921



1x  
4515365



4x  
4251162



2x  
6471276



3x  
302121



1x  
6132210



5x  
371021



1x  
243121



2x  
301021



1x  
4613174



3x  
302021

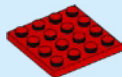

4x  
4243814



1x  
6469455



1x  
403224

  
4x  
307001

  
4x  
6314487

  
2x  
302401

  
1x  
403201

  
4x  
6313115

  
1x  
302301

  
1x  
6117940

  
1x  
6217875

  
2x  
6218822

  
2x  
6249091

  
2x  
6254045

  
2x  
614126

  
6x  
4504382

  
10x  
307026

  
4x  
300526

  
5x  
6181720

  
2x  
6234695

  
5x  
6181713

  
1x  
6051508

  
3x  
6092585

  
12x  
302326

  
4x  
306926

  
1x  
300426

  
4x  
6047276

  
2x  
366526

  
2x  
6214807

  
3x  
302226

  
1x  
303926

  
2x  
362326

  
4x  
4251161

  
1x  
6471095



2x  
243126



2x  
4560182



5x  
302026

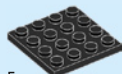

5x  
4243819

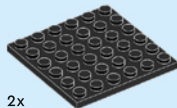

2x  
395826



1x  
6290502



2x  
4141089



2x  
6092599



2x  
6343326



4x  
6470884



6x  
6145570



2x  
6092587



2x  
4211396



28x  
6123809



2x  
4550359



2x  
6212064



2x  
6471274



1x  
403228



2x  
300328



[LEGO.com/service](https://www.LEGO.com/service)

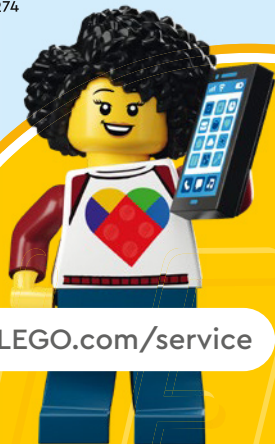



LEGO and the LEGO logo are trademarks of the/son des marques de commerce du/son marcas registradas de LEGO Group. ©2024 The LEGO Group.

©SEGA. All rights reserved. SEGA is registered in the U.S. Patent and Trademark Office. SEGA and SONIC THE HEDGEHOG are either registered trademarks or trademarks of SEGA CORPORATION.

6502902