



**BRICK
HEADZ**

40752







1x

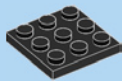

1x

1

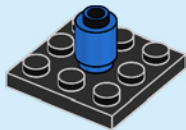

1x

2





2x

3

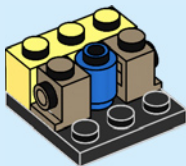

3x

4

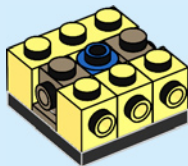



1x

5

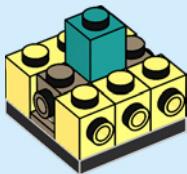

2x



1x

6

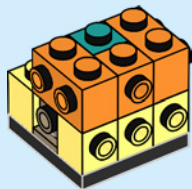



3x

7

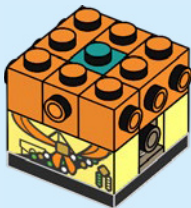

2x

8

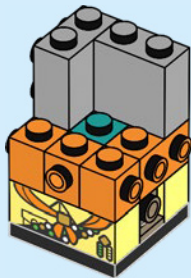



1x



1x



1x

9

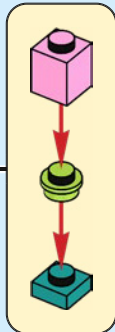
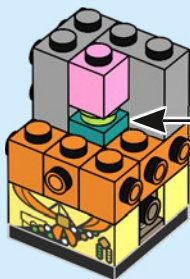

2x

10





11

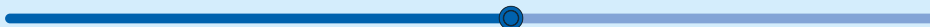
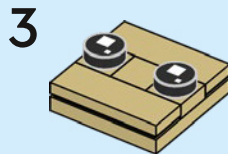
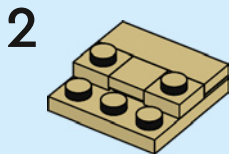
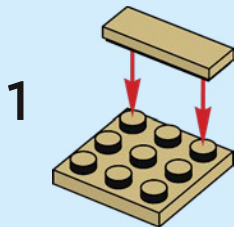

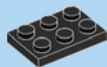

2x

12

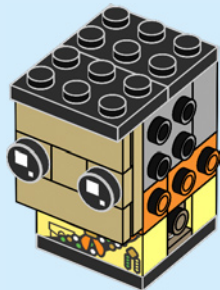
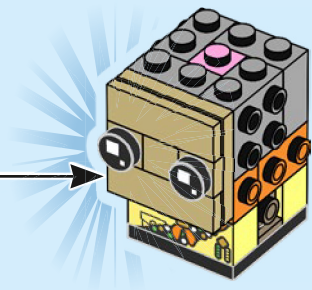



1x

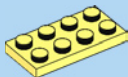

1x

13

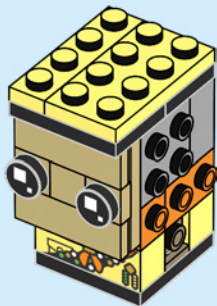

3x

14

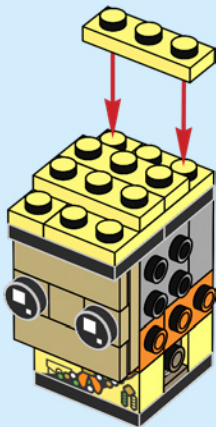



2x



1x

15

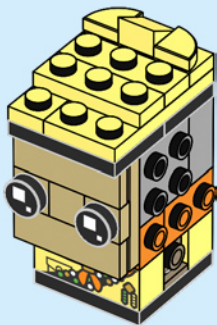

2x



2x

16

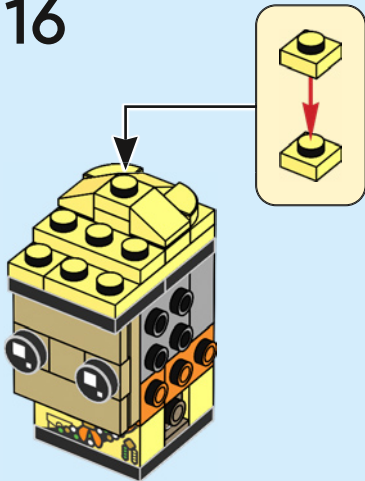



2x



1x

17

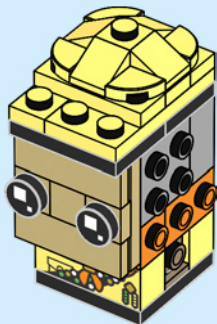

1x



1x



1x

18

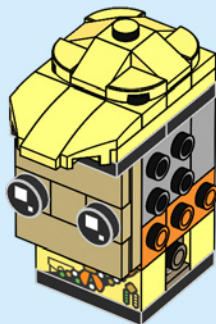





1x



1x

19

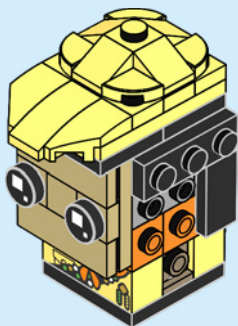

1x



1x

20

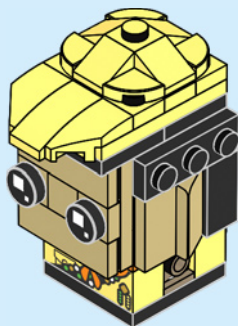



1x



1x

21

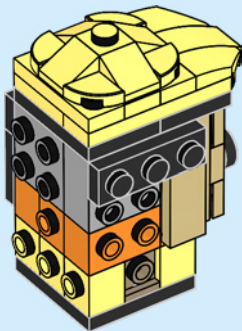

1x



1x

22

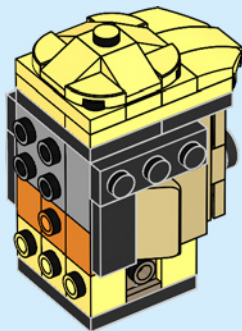

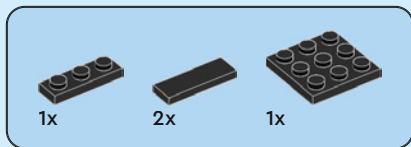

23

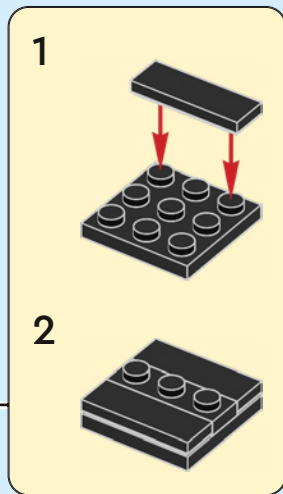
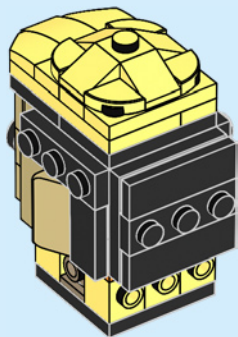



2x



2x



2x

24

1

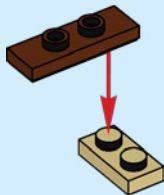

2

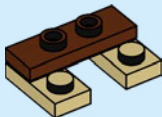

3



4

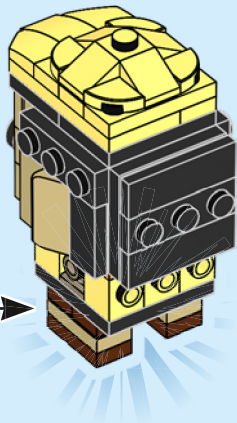
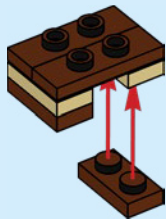



1x



2x



1x

25

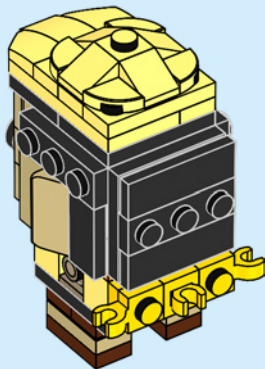

1

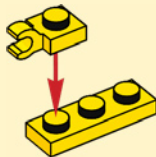

2

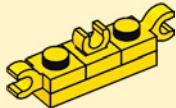

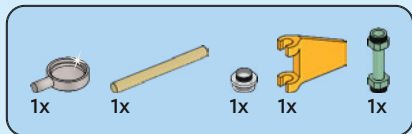

26

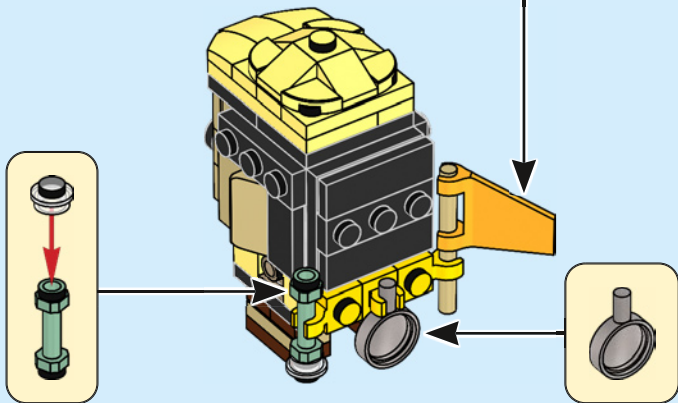
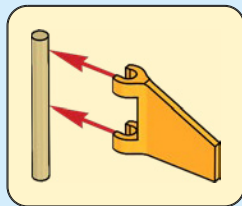



2x



2x

27

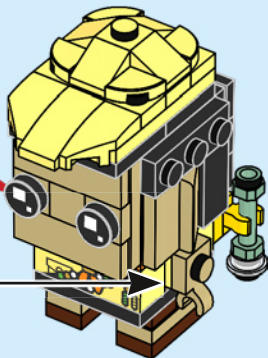
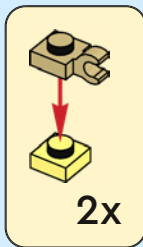

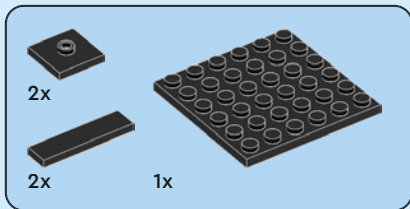

28

1

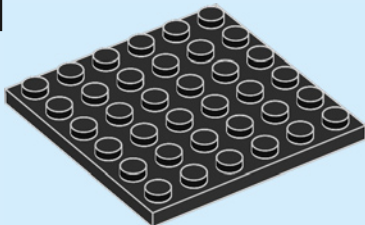

2

