



# STAR WARS

MINI BUILDING SET

4487

SLAVE I™

MINI

Jedi Starfighter™

4193297



**STAR  
WARS™**

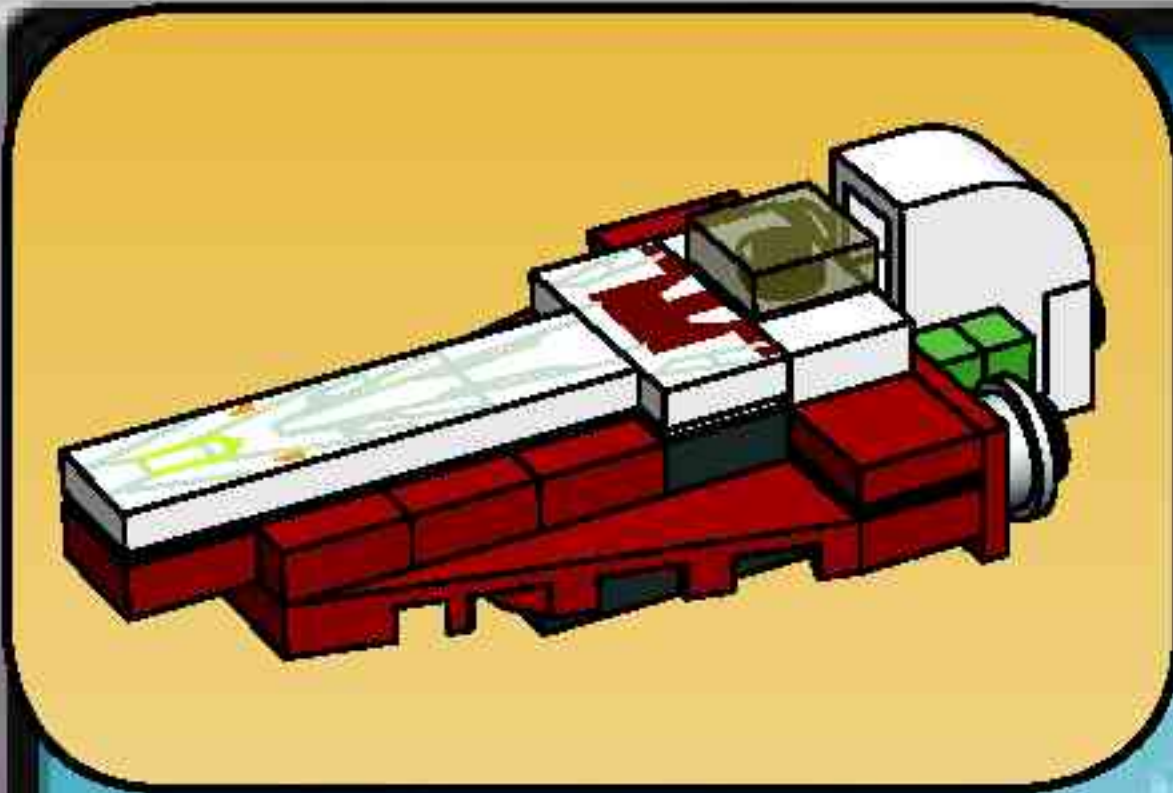

1

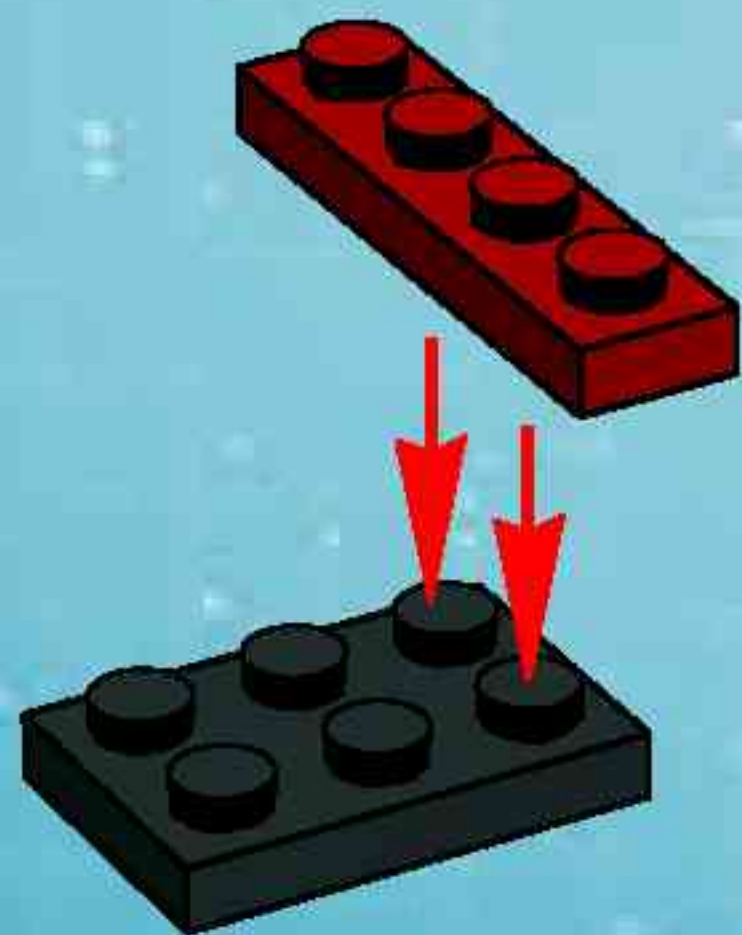

2

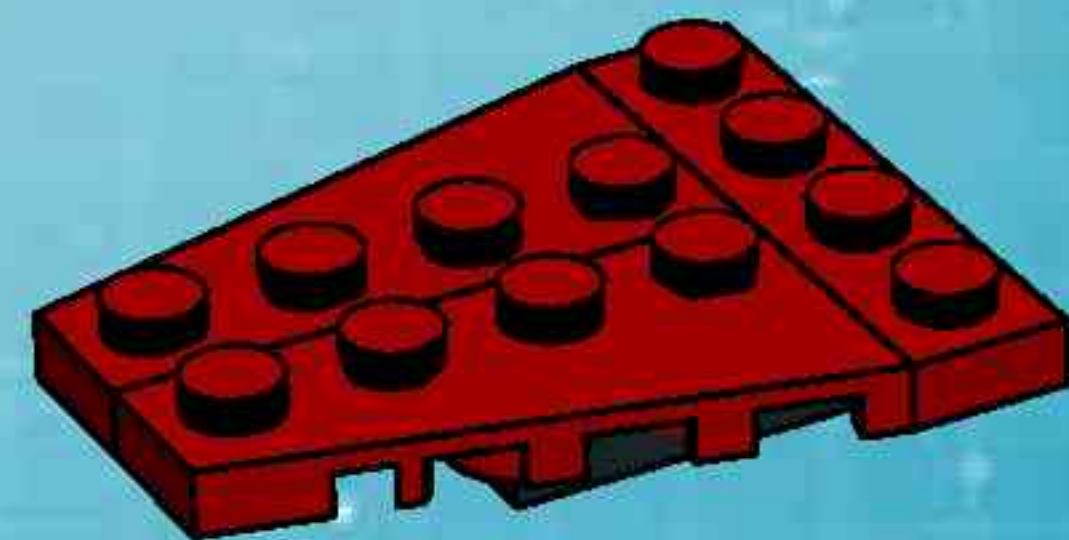

1

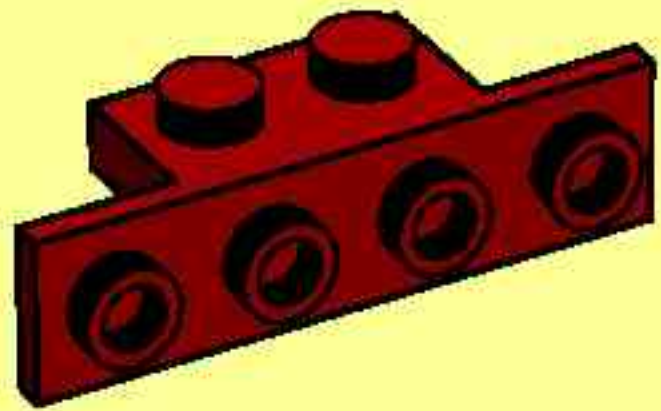

2

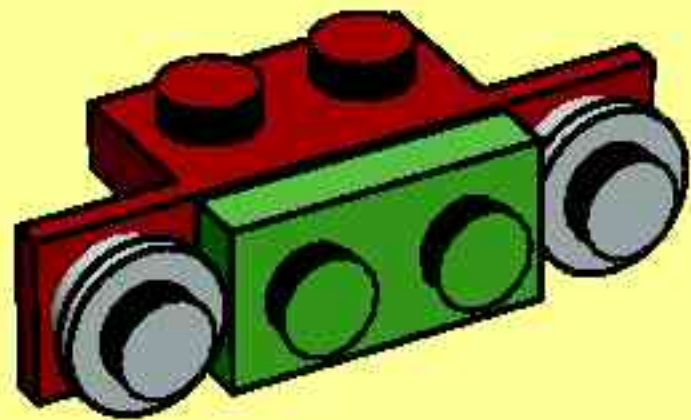

3

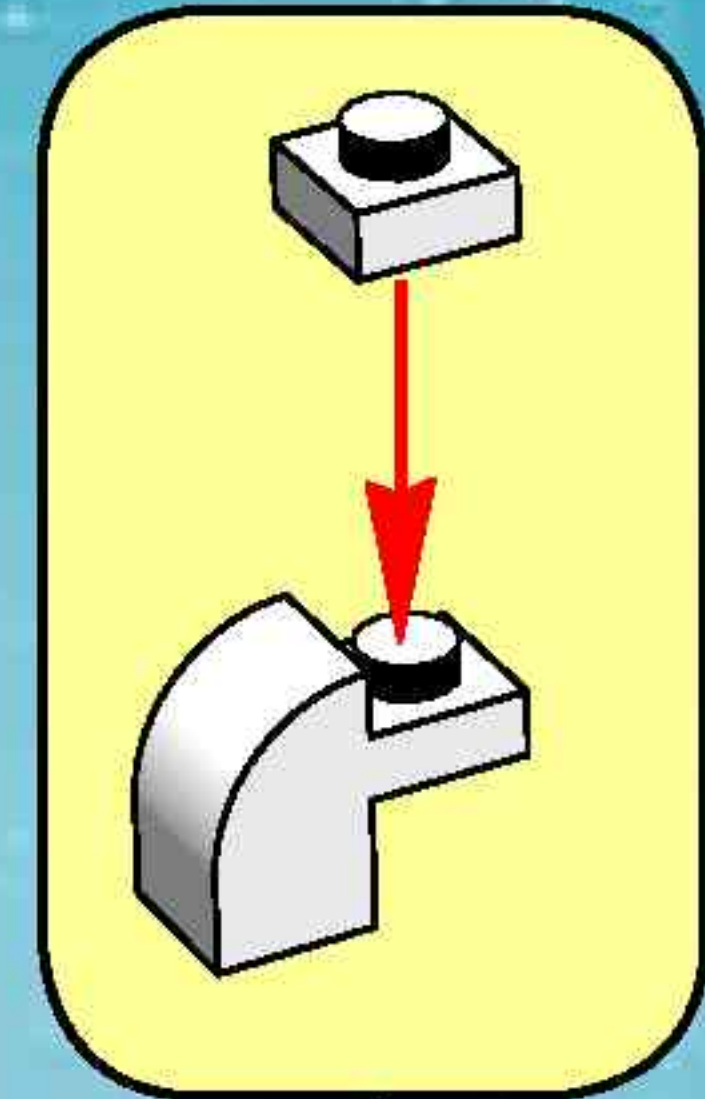
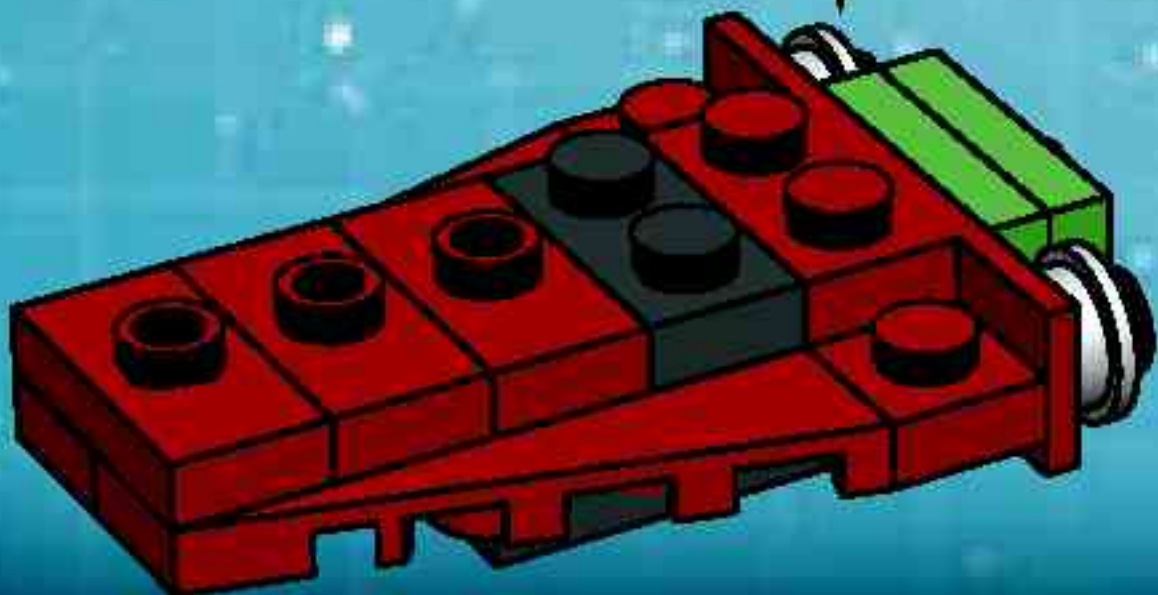
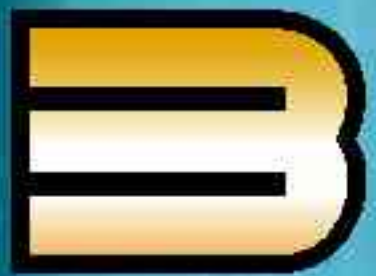
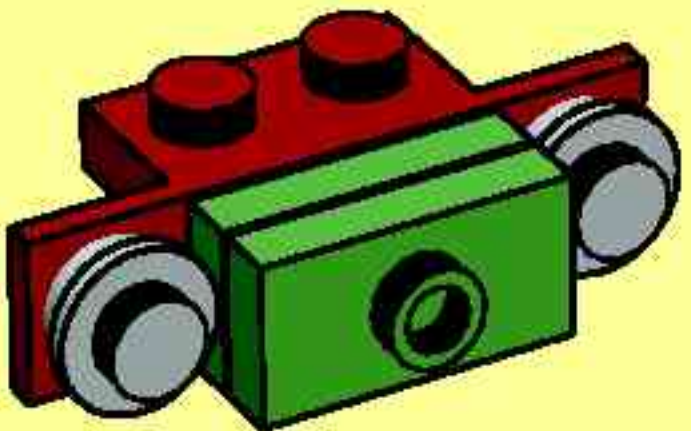

4

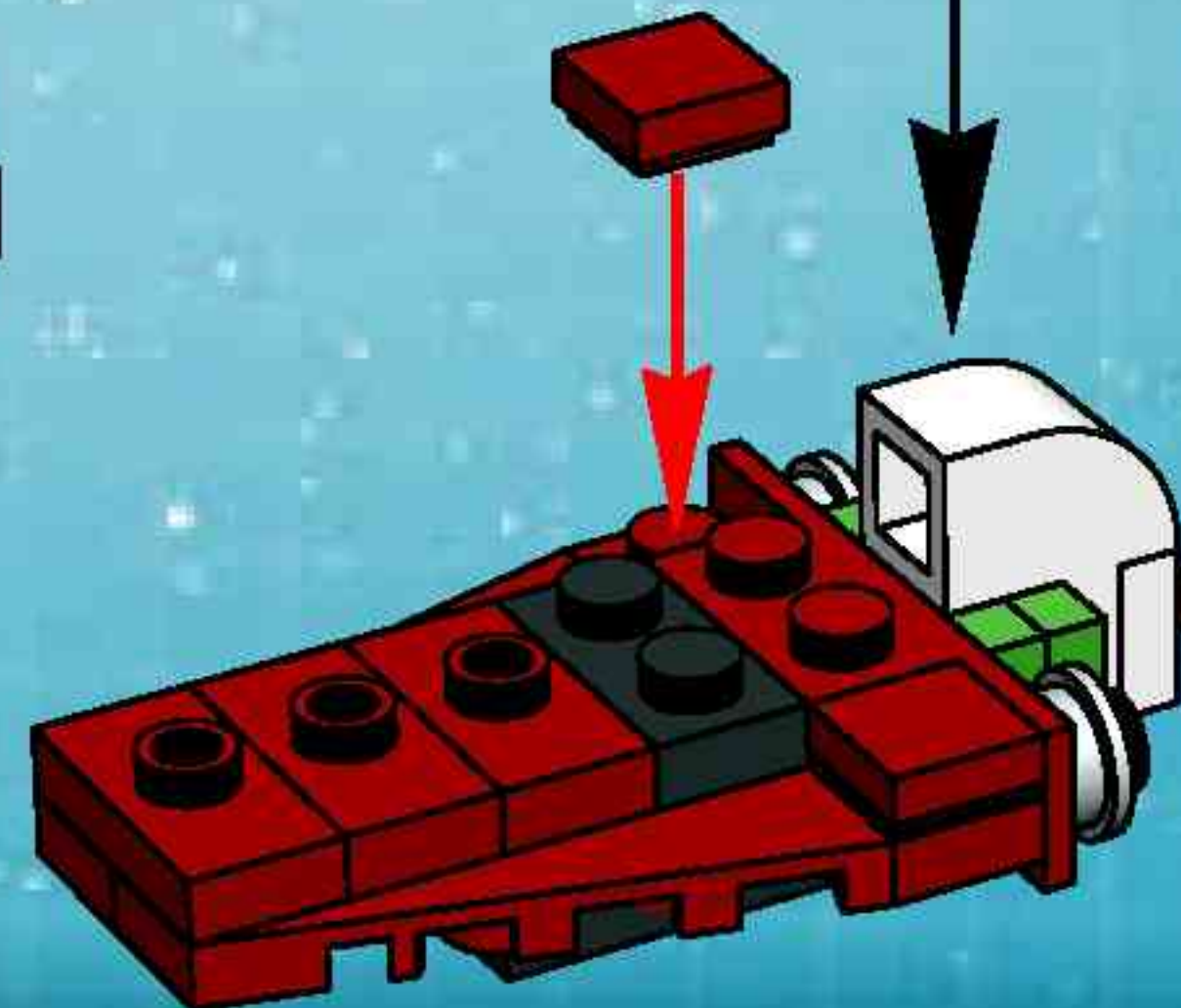

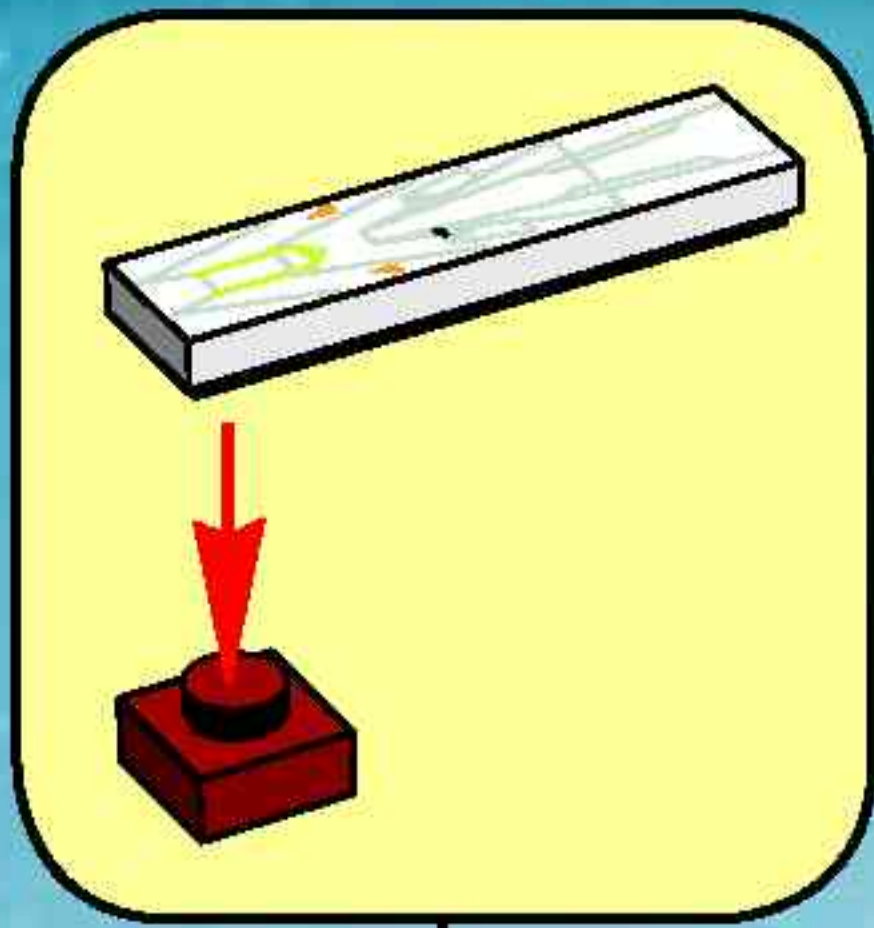

5

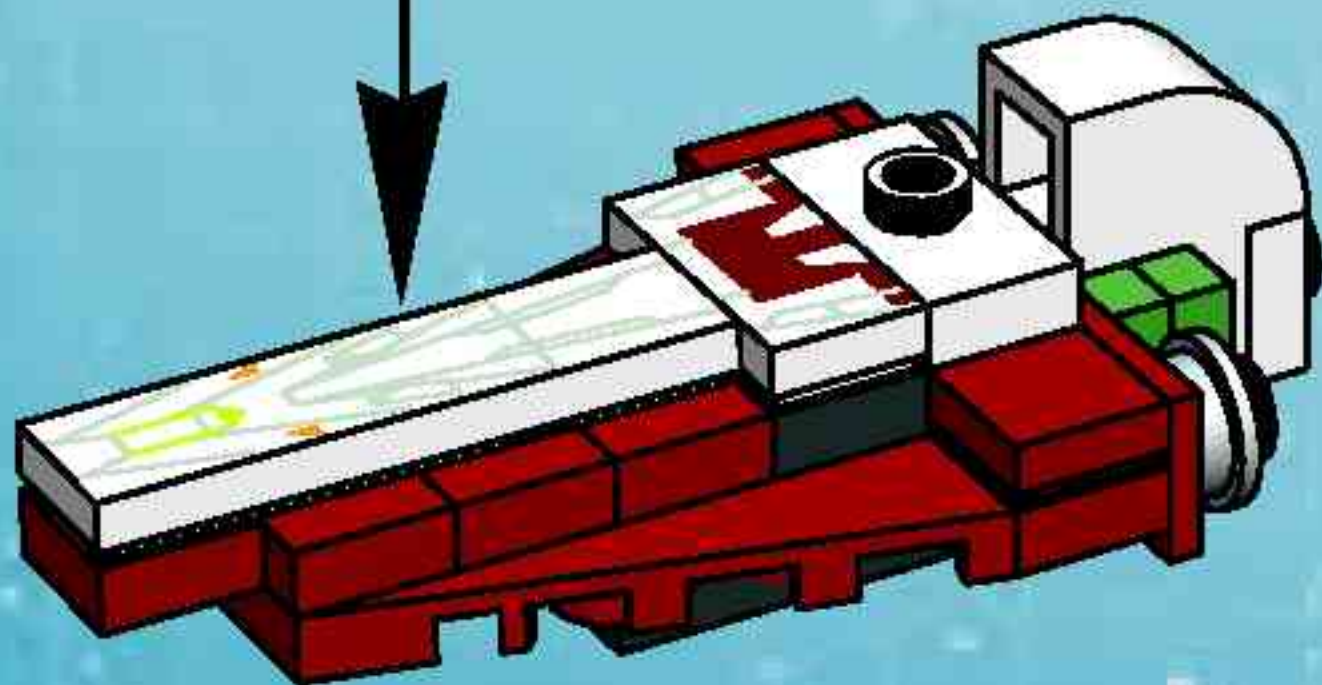

6

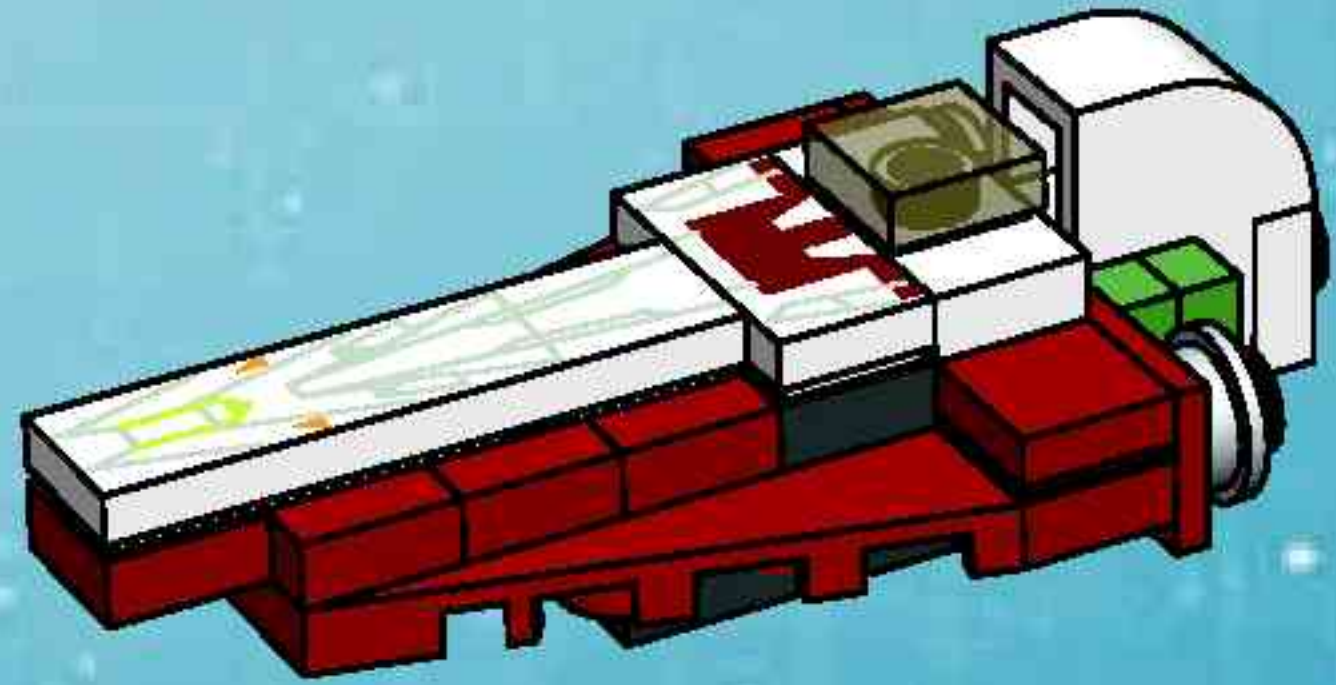

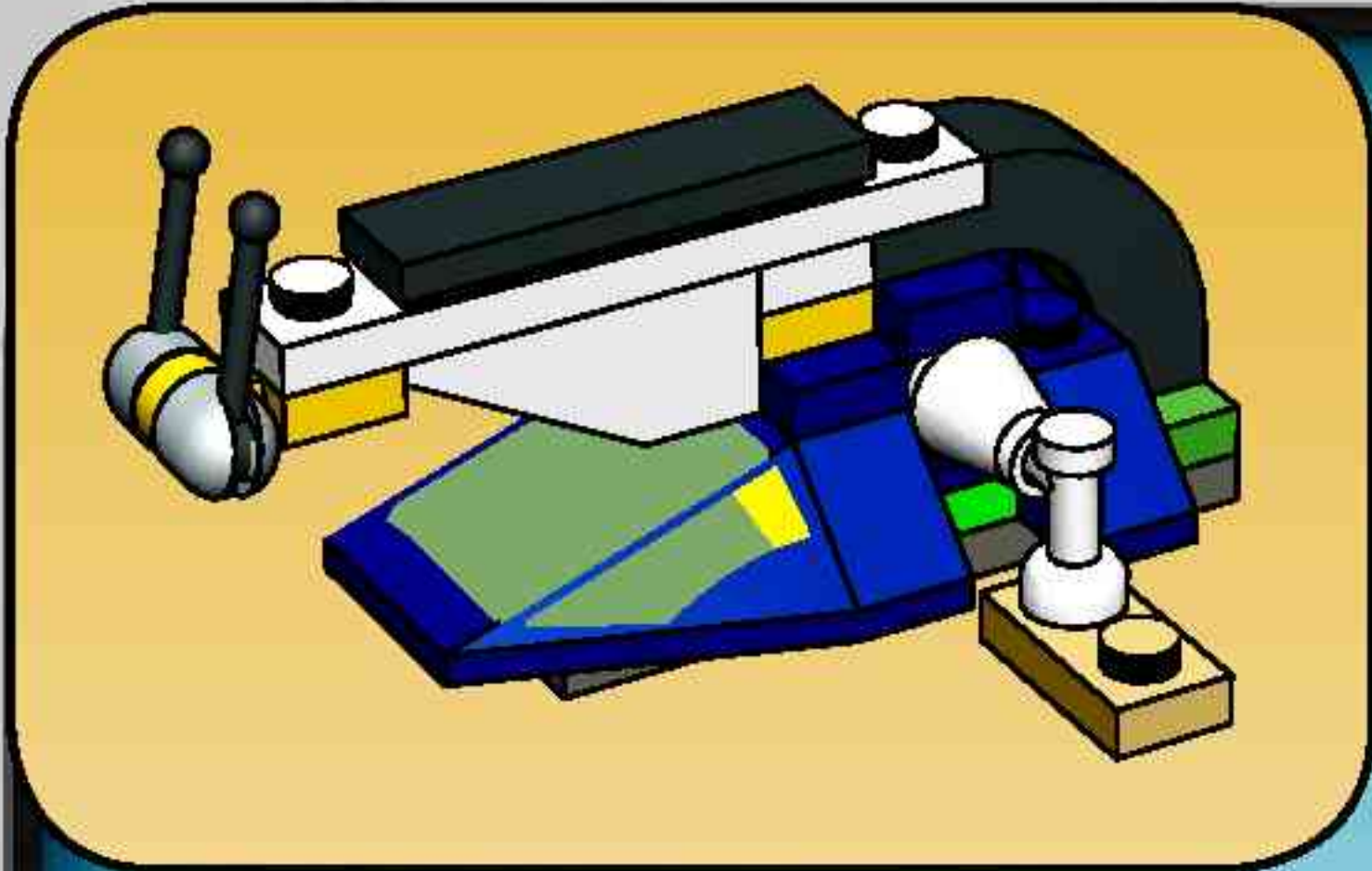

1

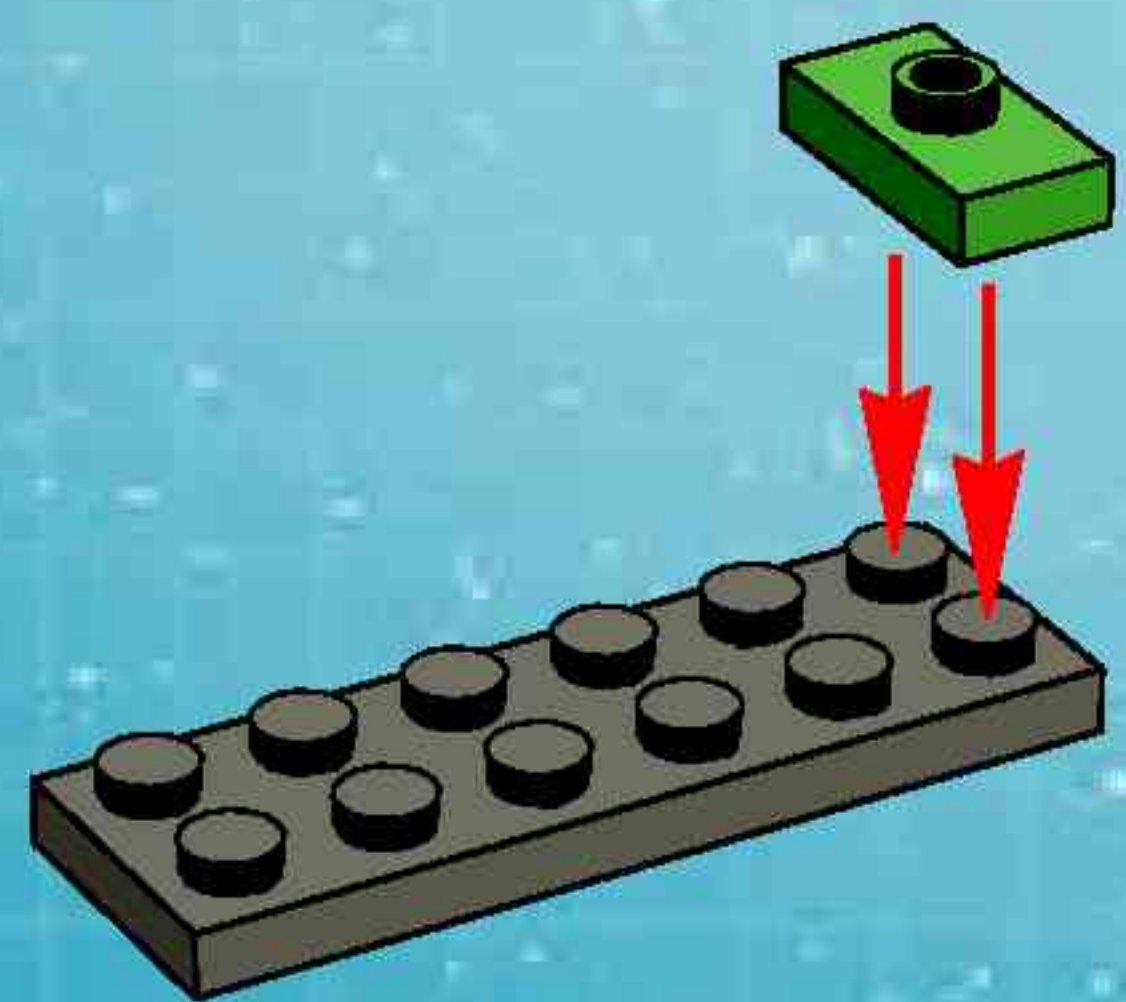

2

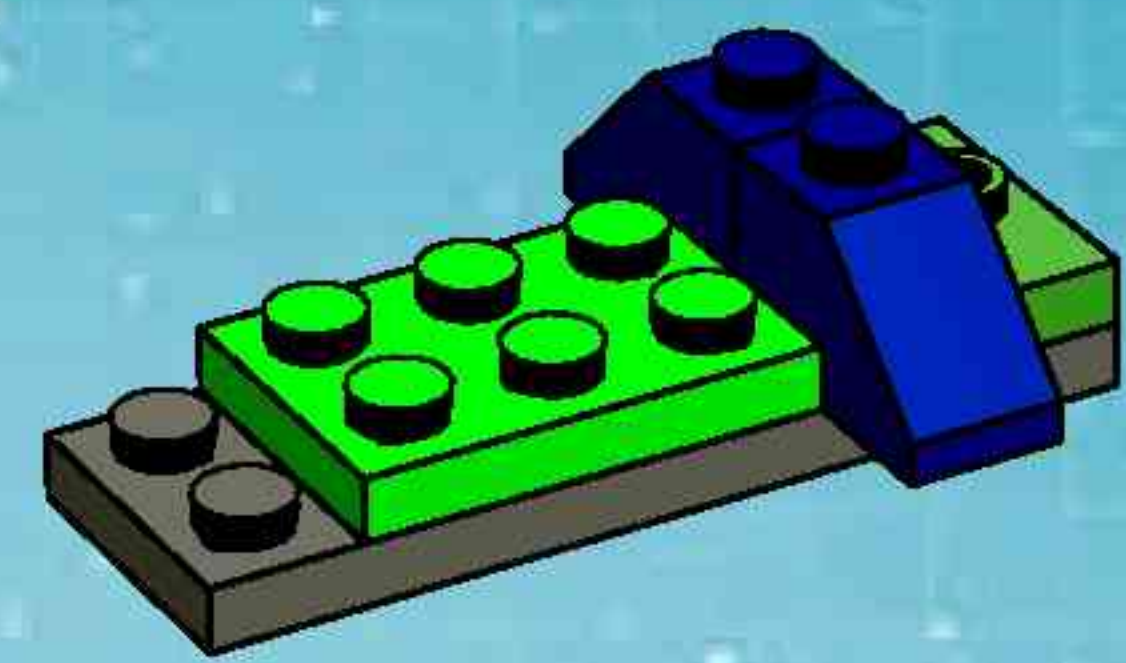

3

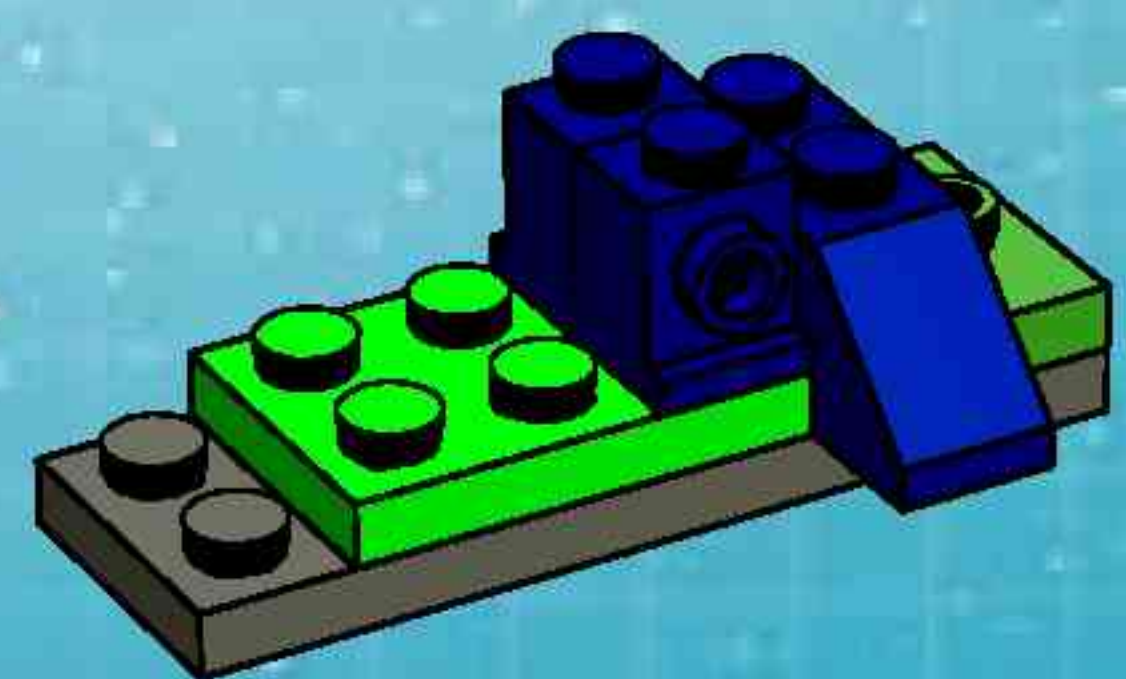

4



5



6



7

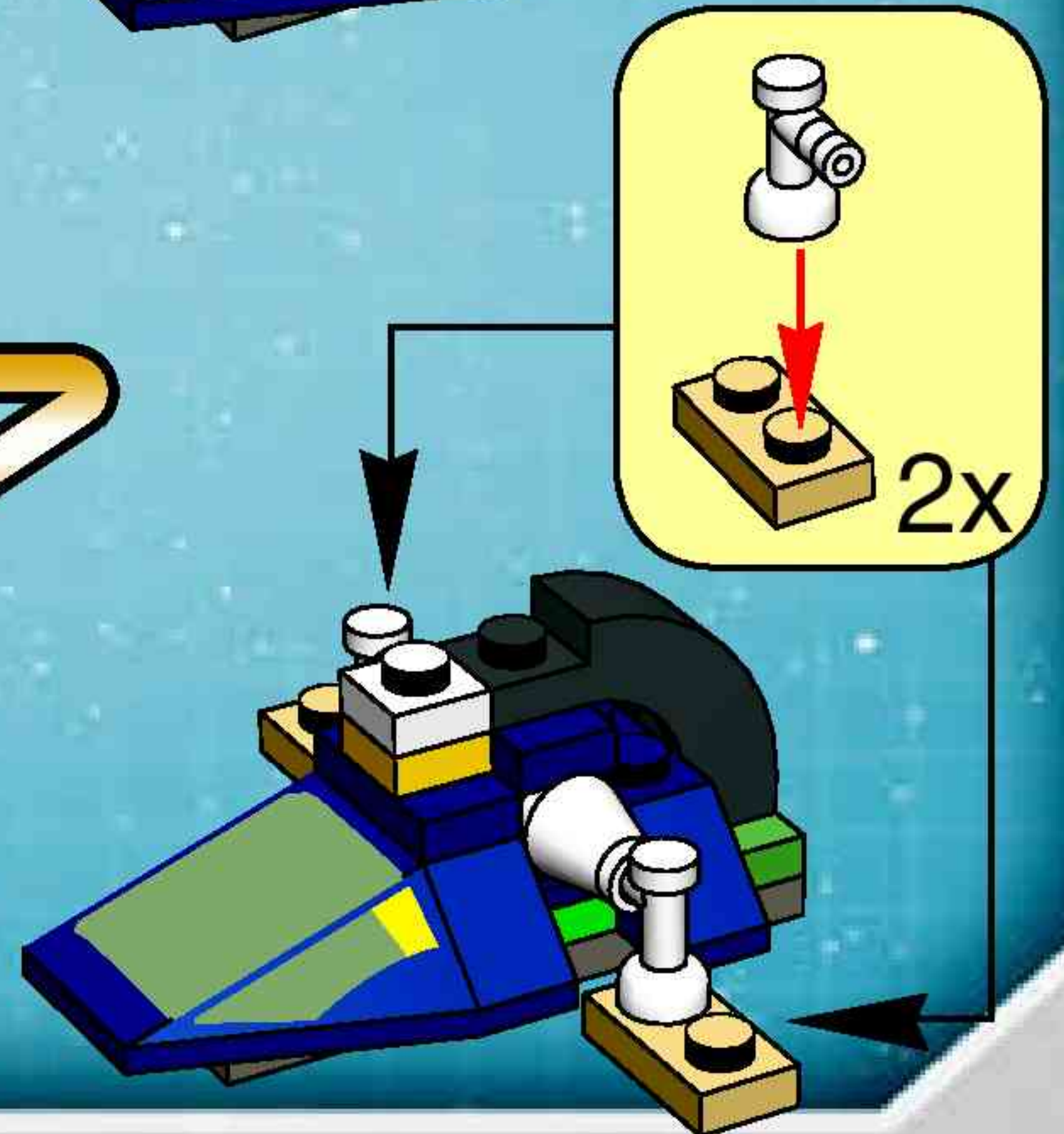

1

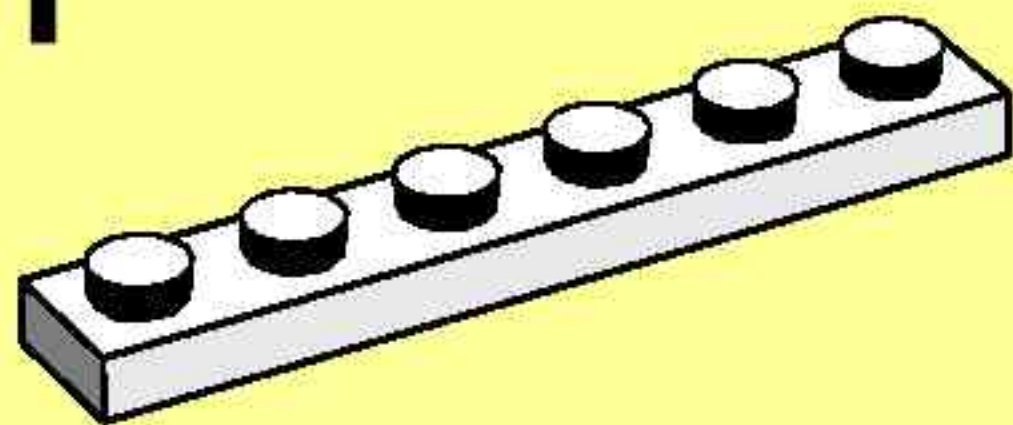

3

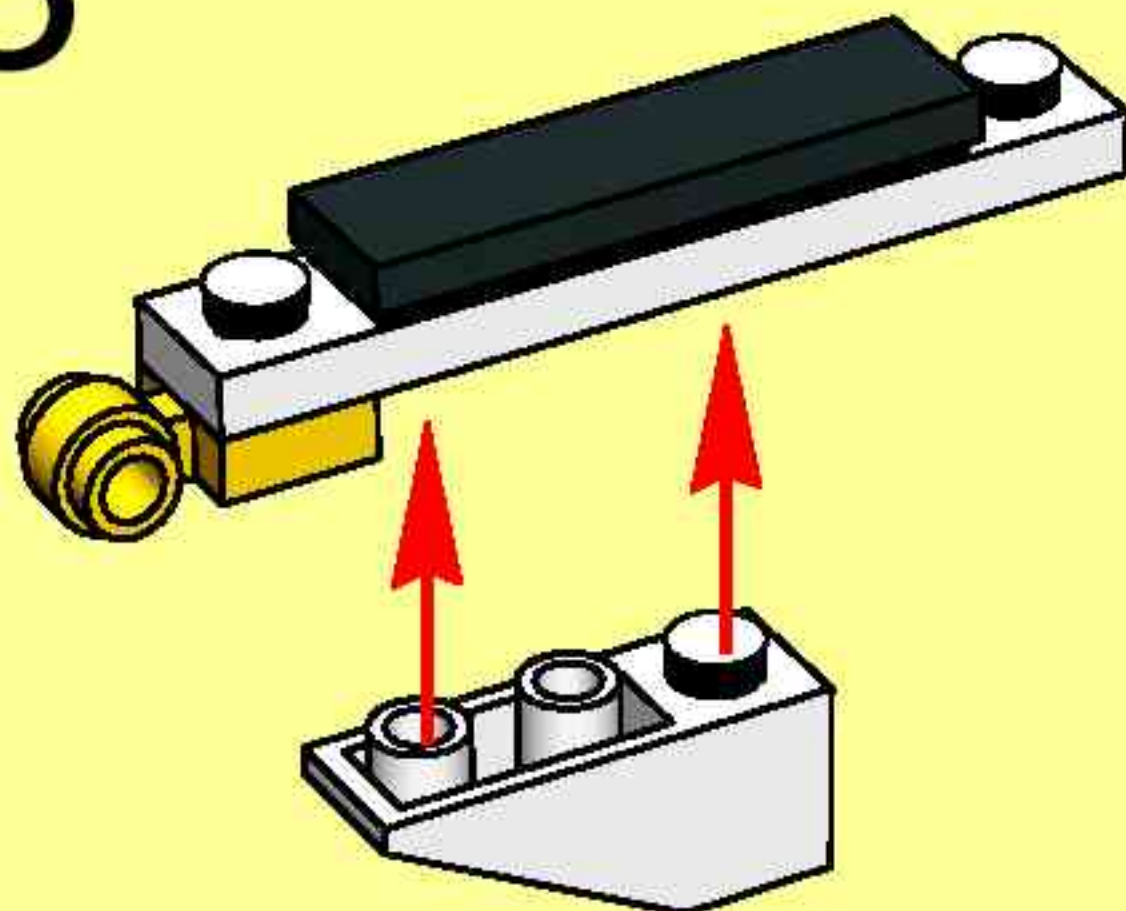

4

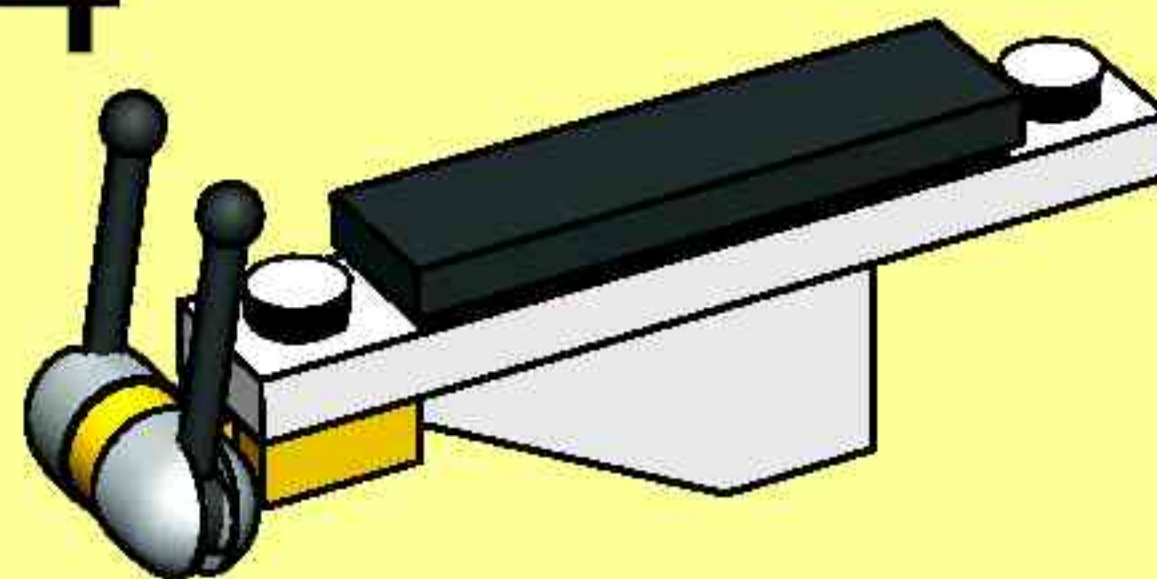

2

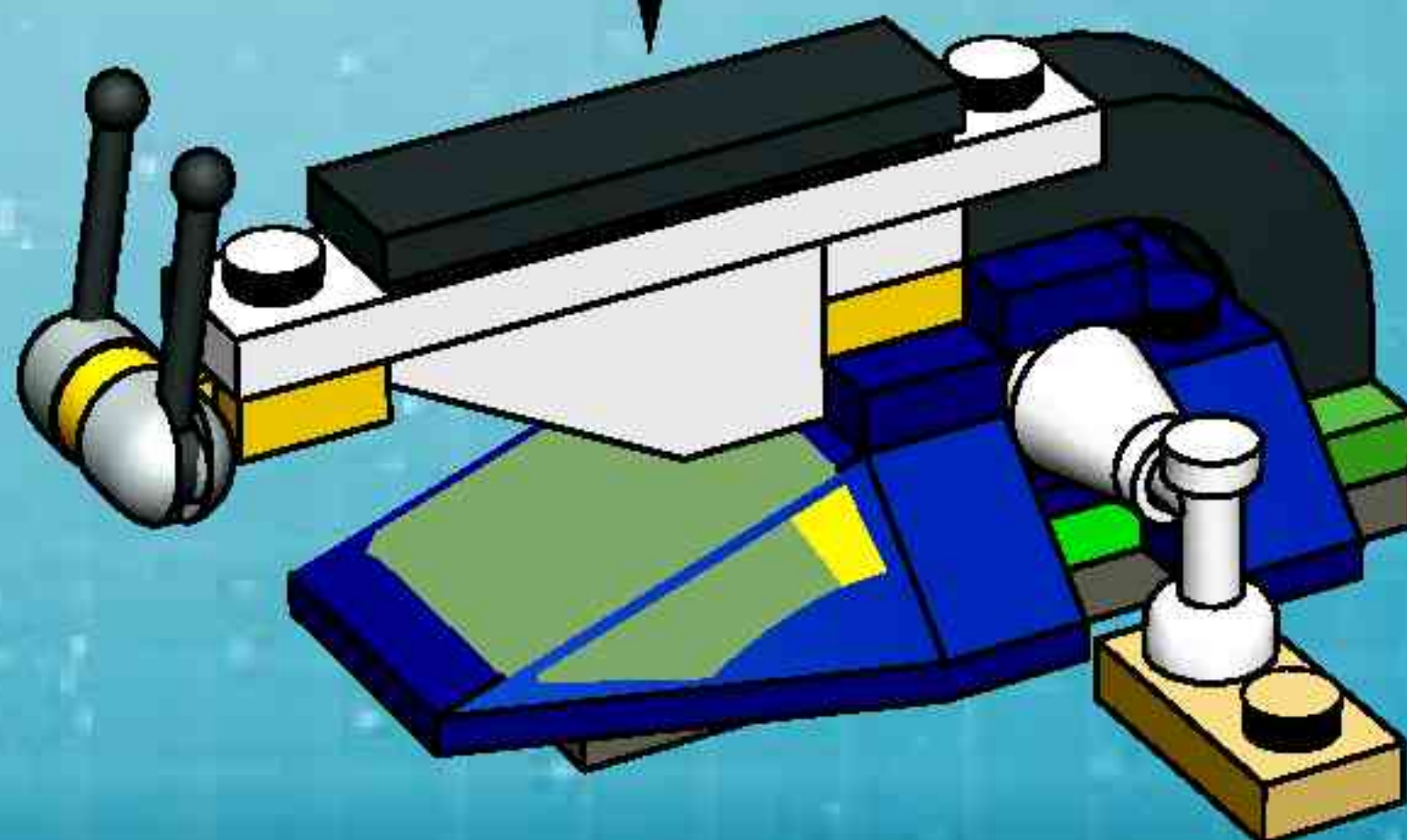
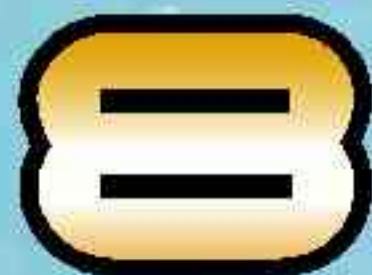
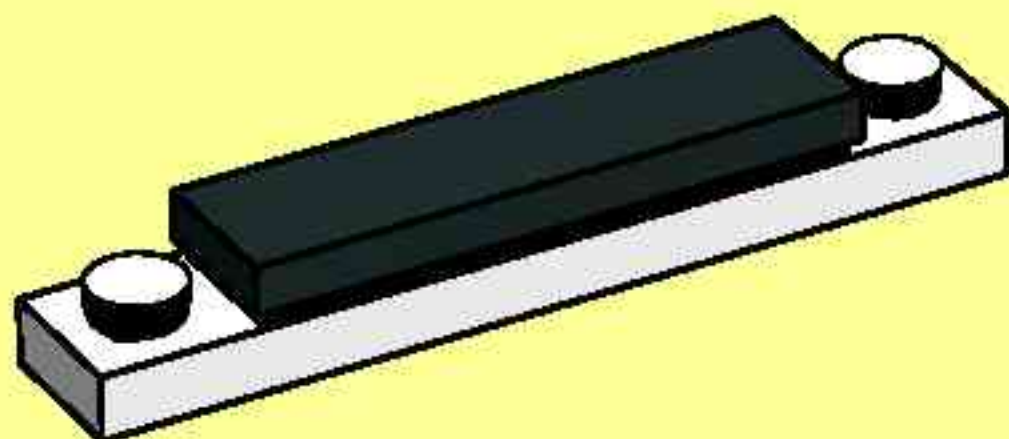





# STAR WARS

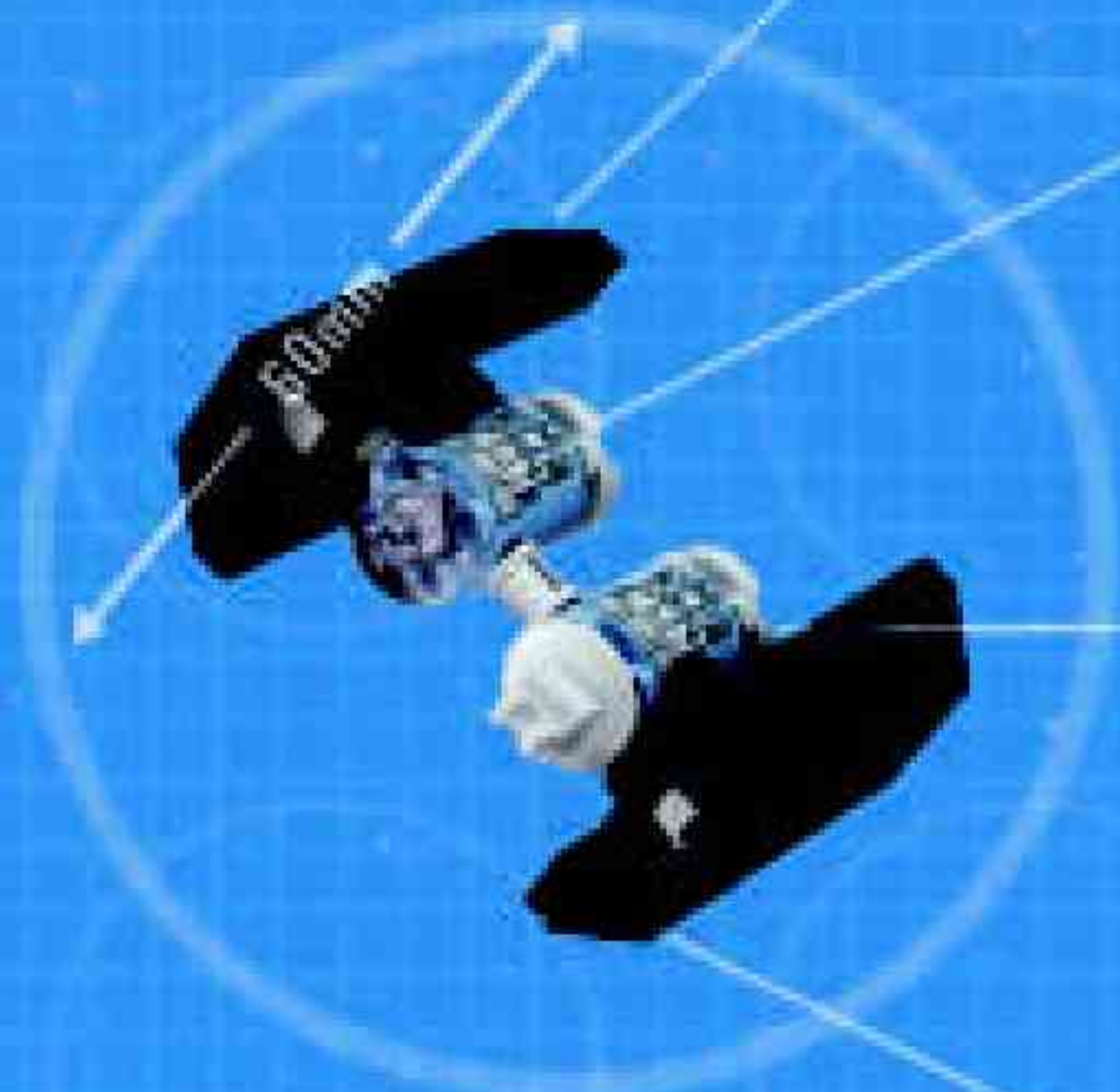

4484



4486



4487



4485



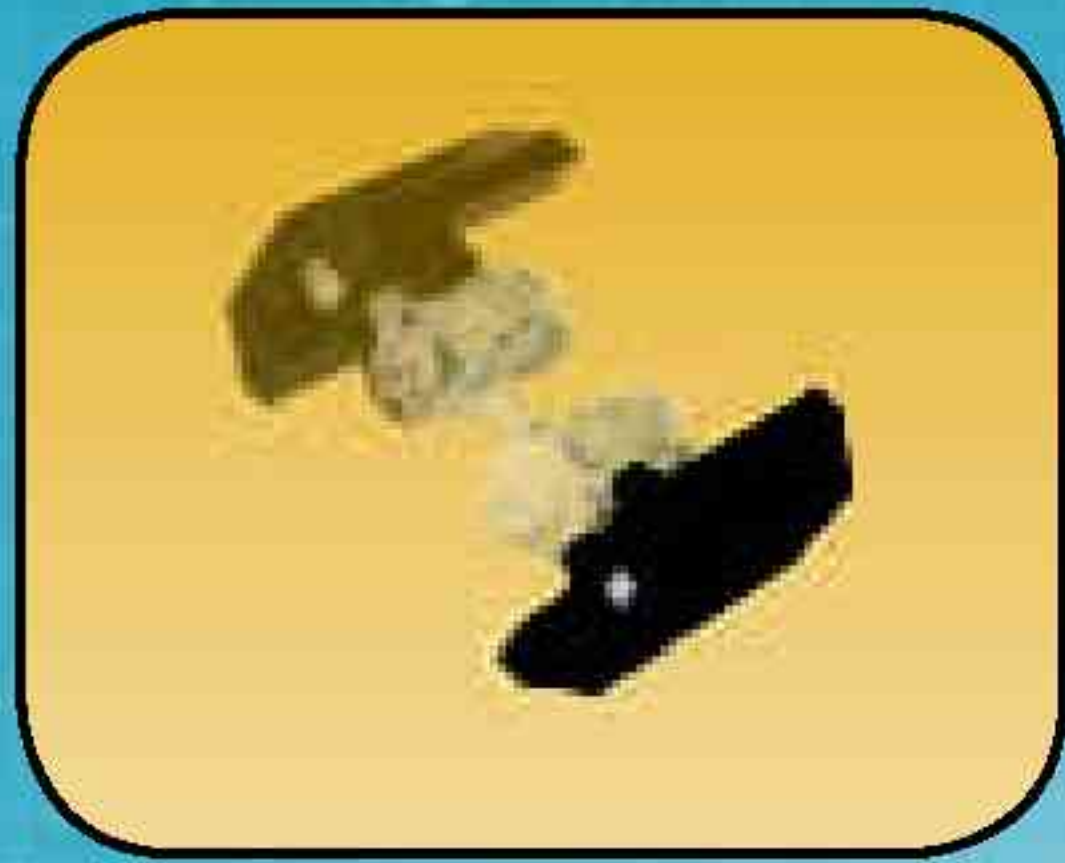

1

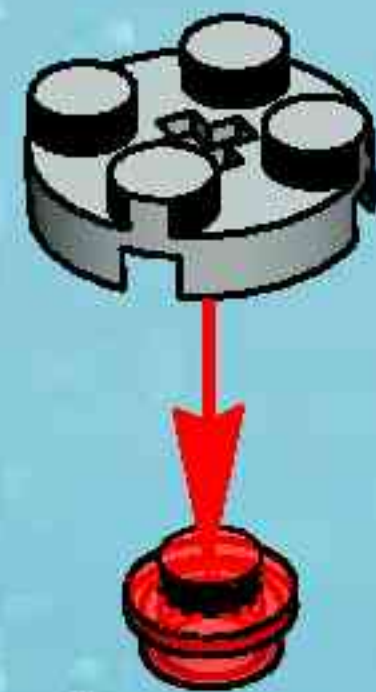

2



3

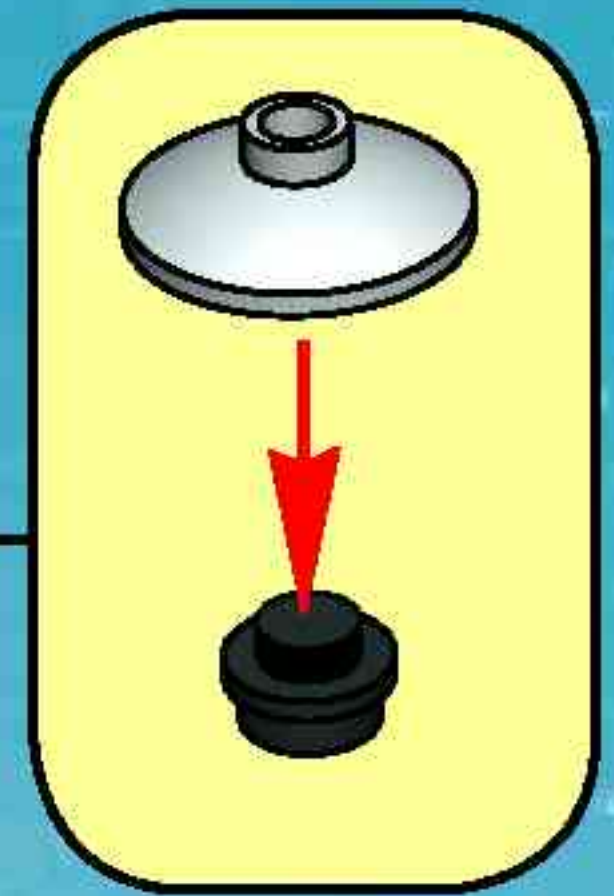

4



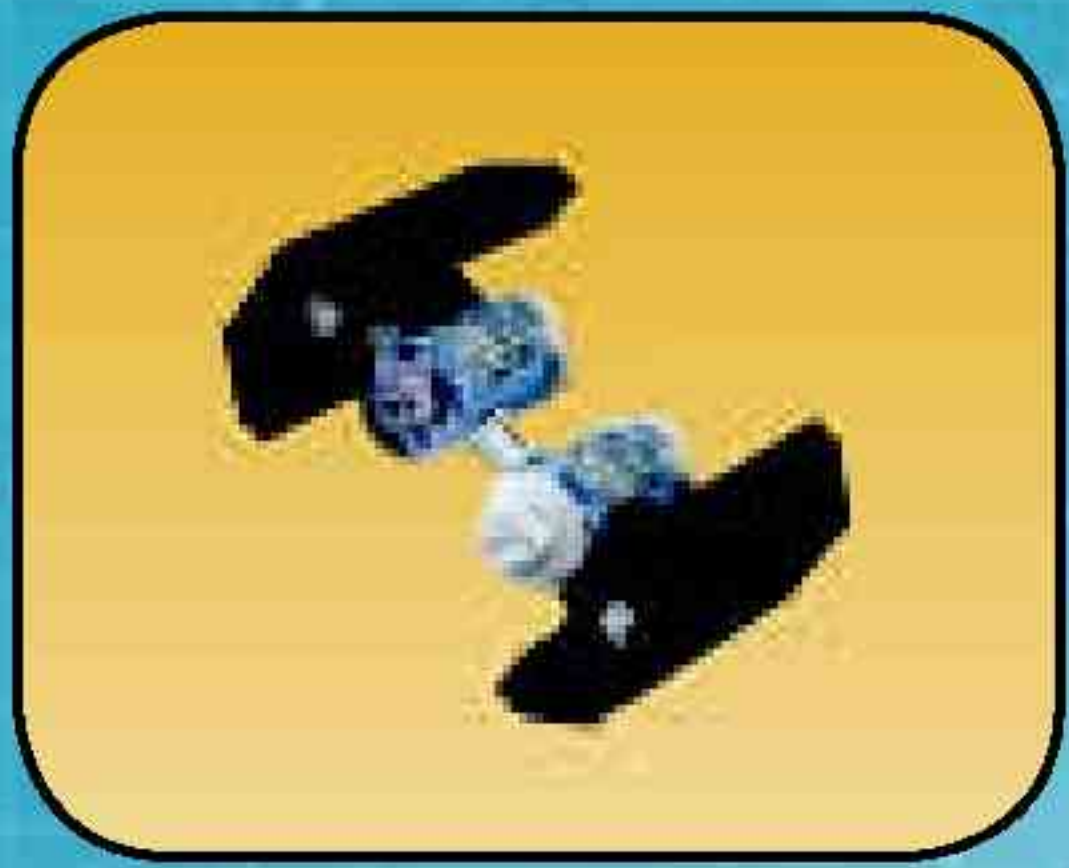

1

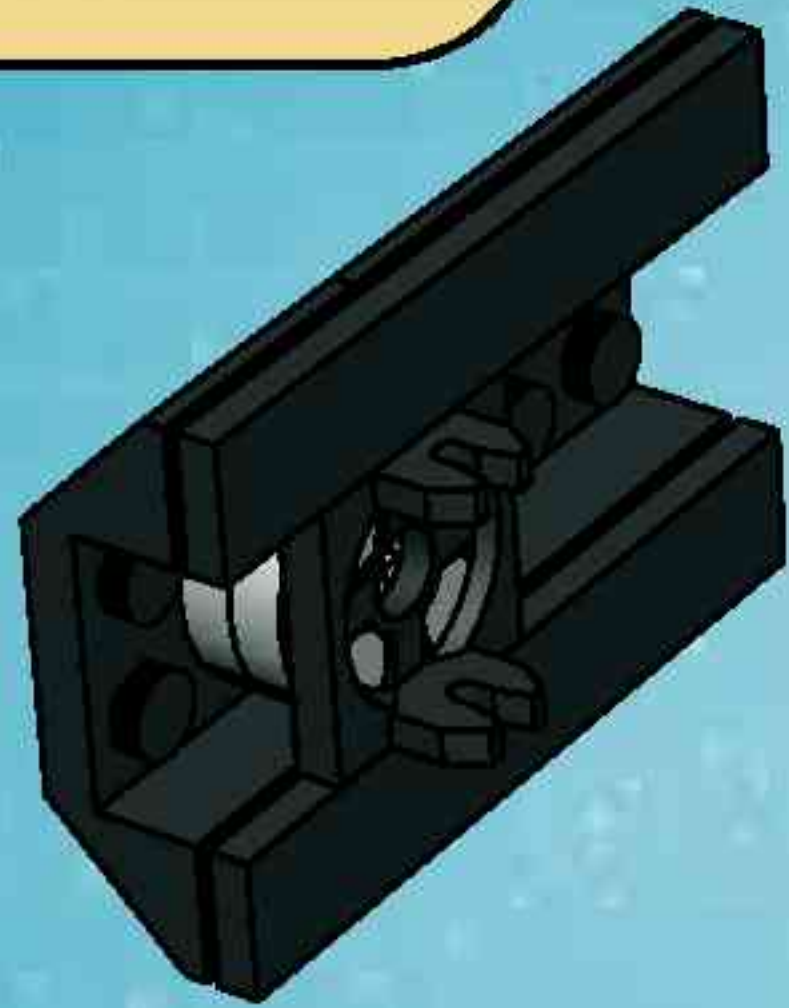

2

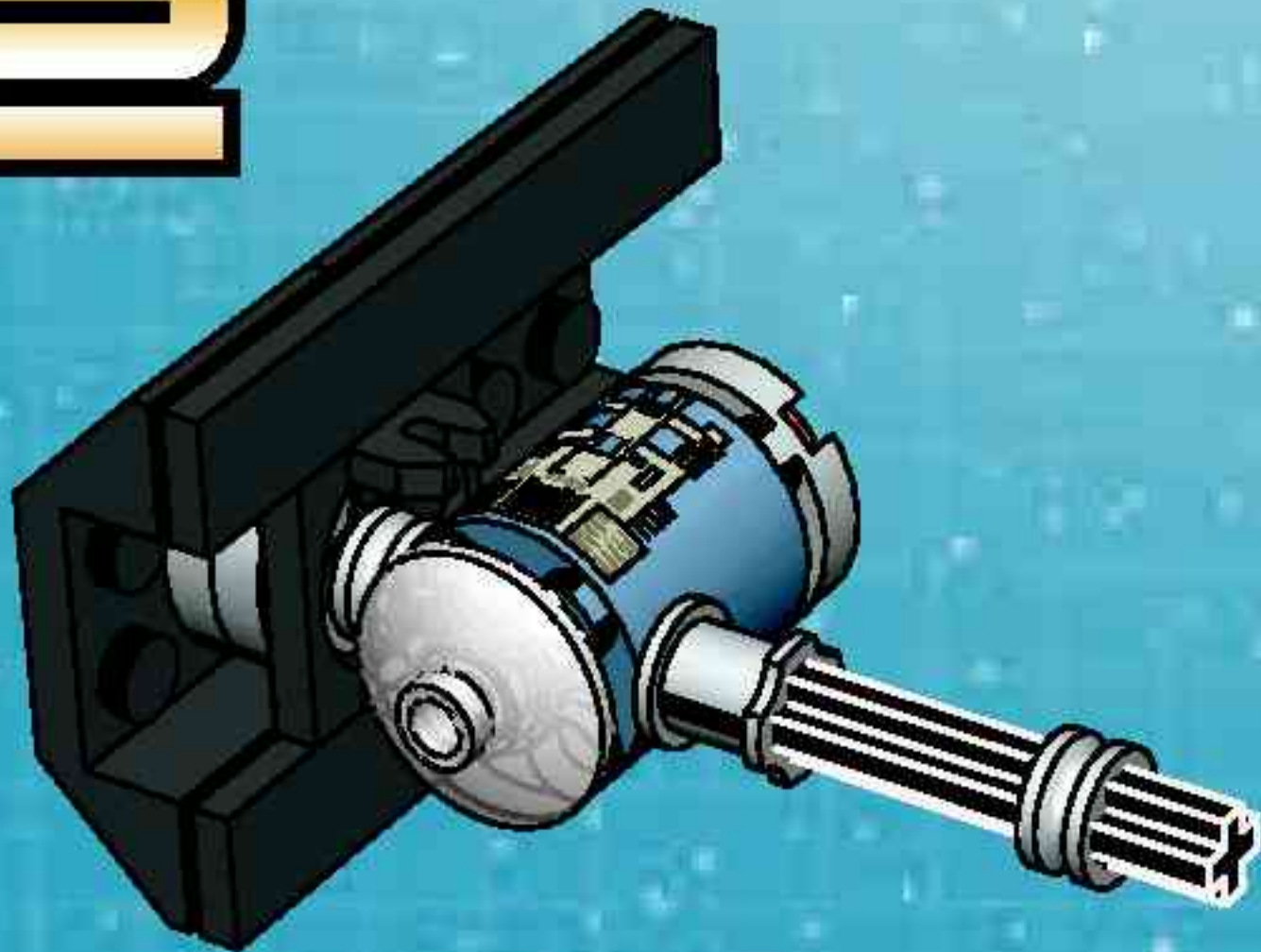

3

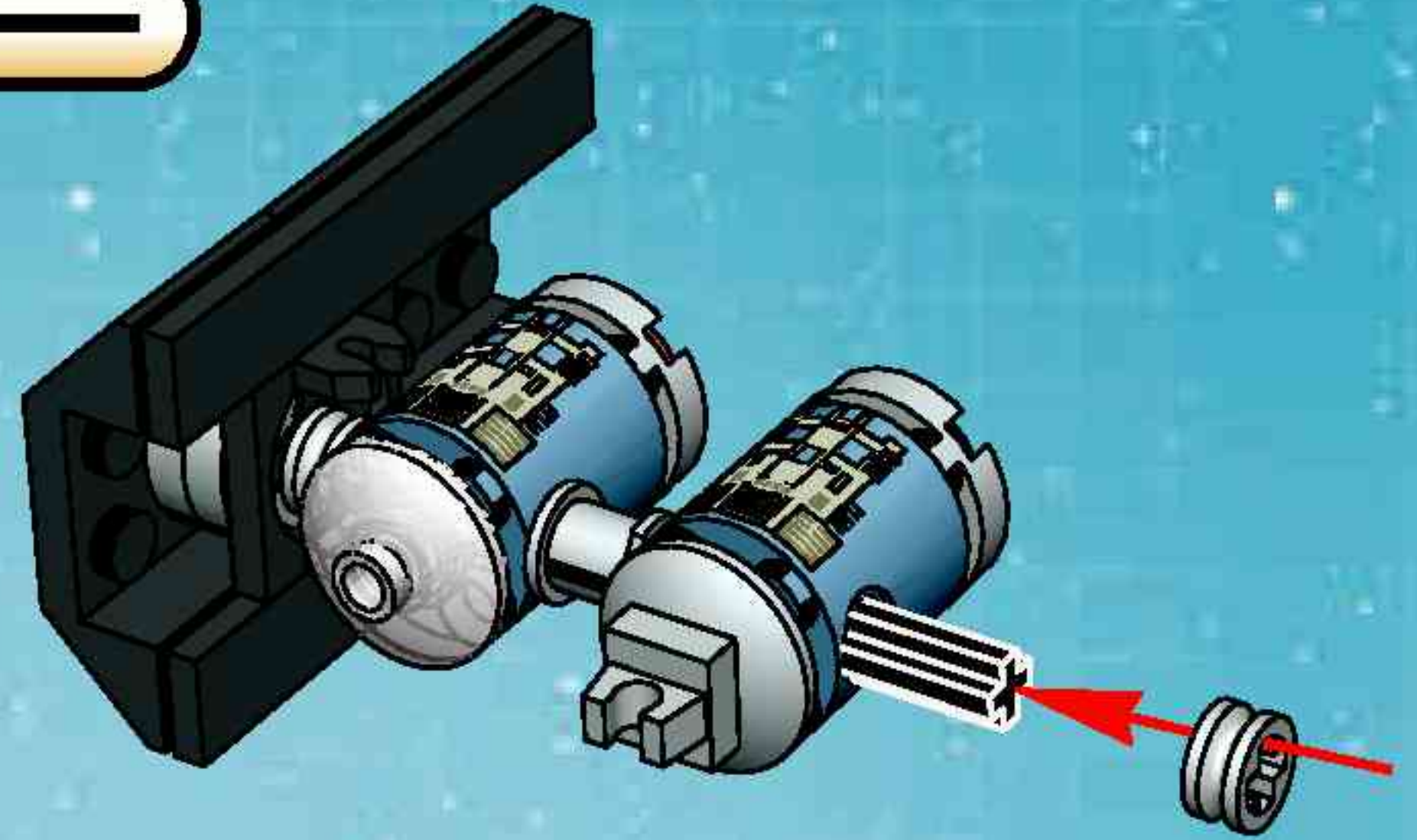

4

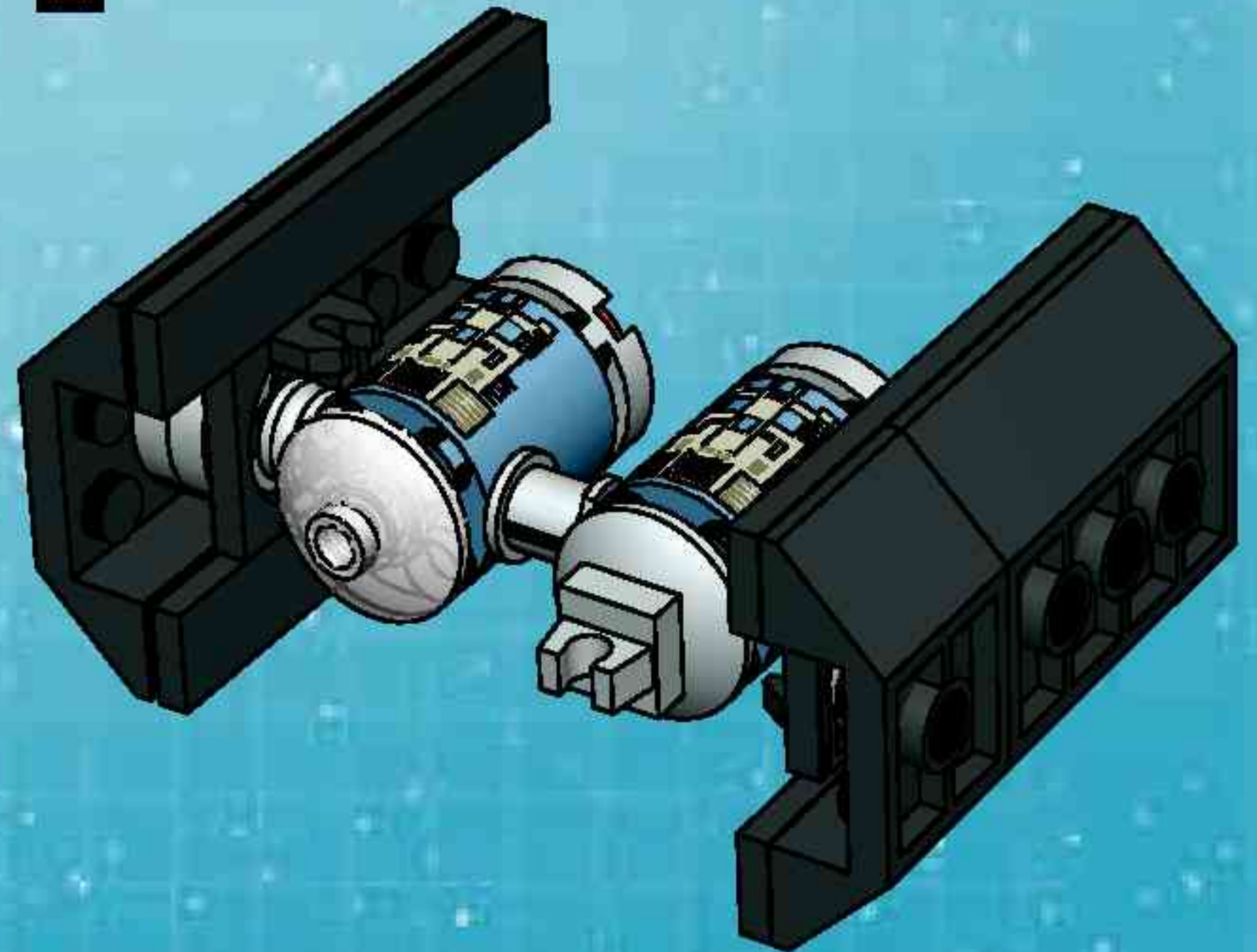



LEGO, the LEGO logo and the minifigure are trademarks of the LEGO Group.  
© 2003 The LEGO Group.

© 2003 Lucasfilm Ltd. & TM. All rights reserved. Used under authorization.