

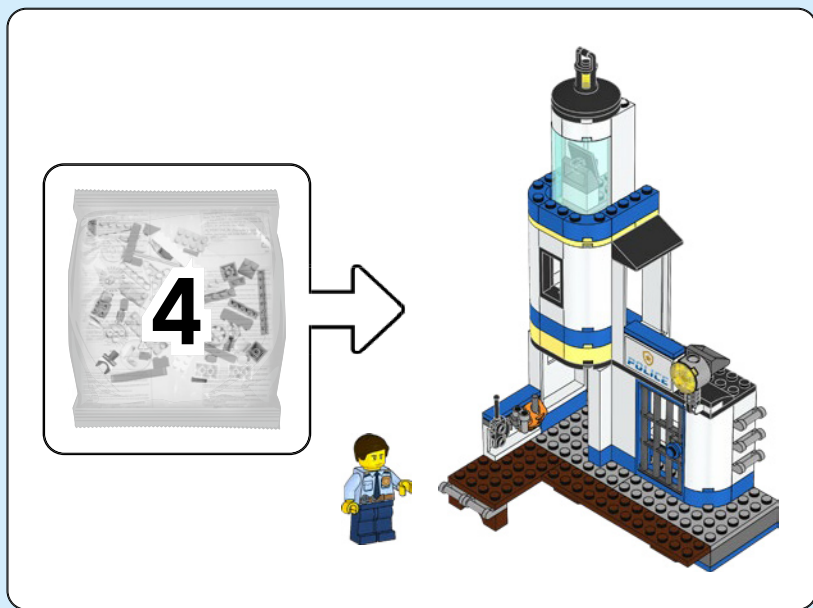

CITY

60308





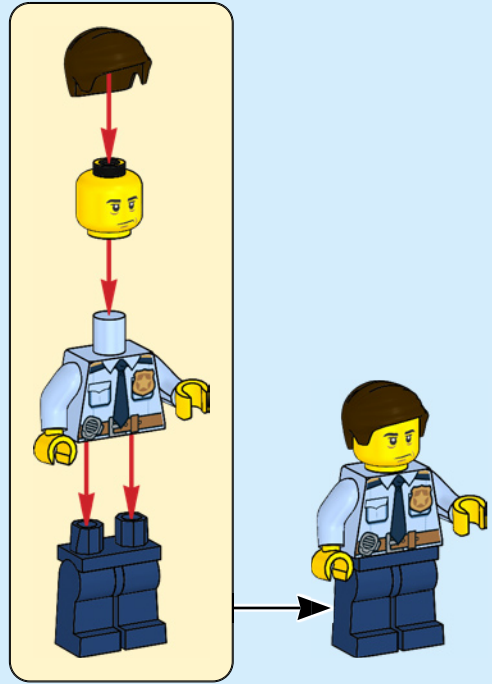

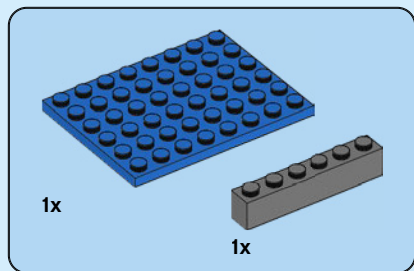

1

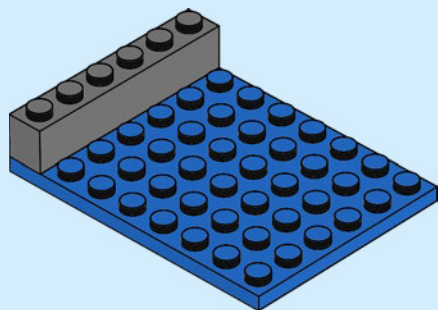

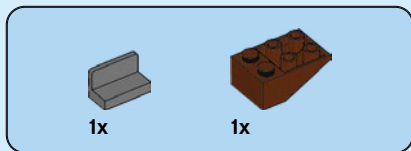

2

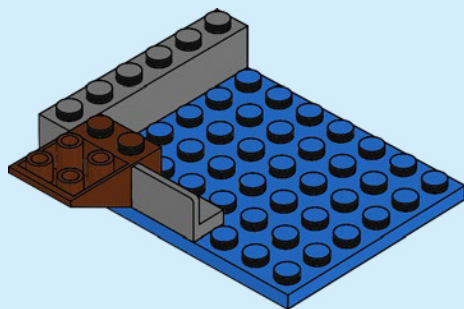



1x

3

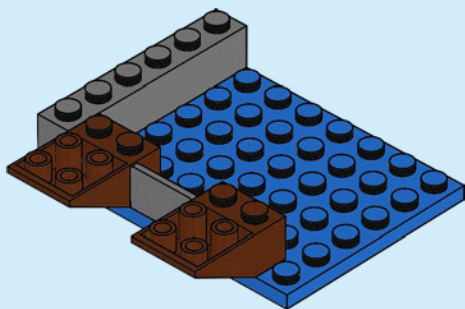

6

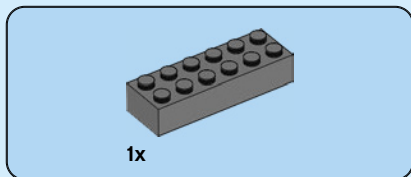

4

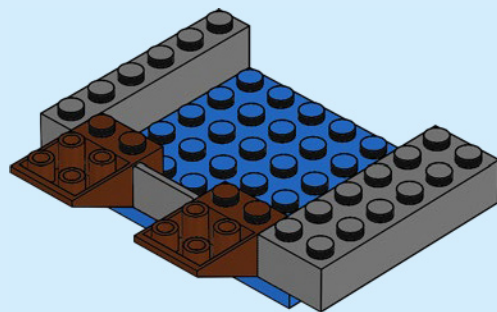

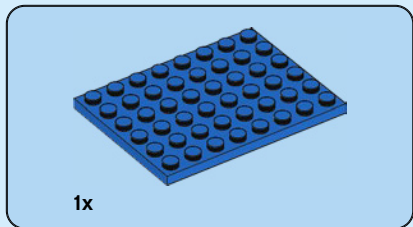

5

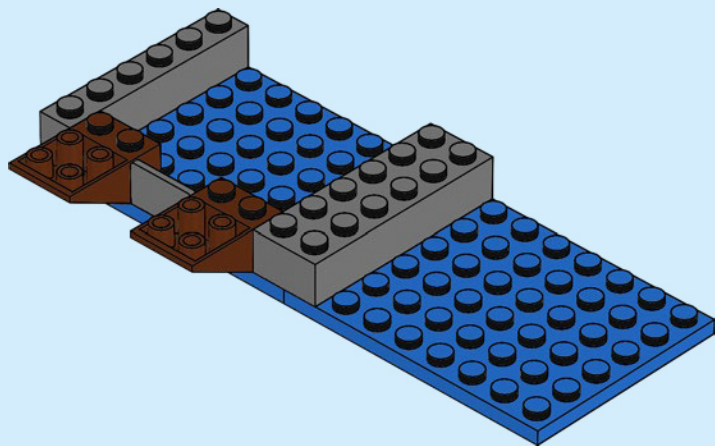

8



2x

6

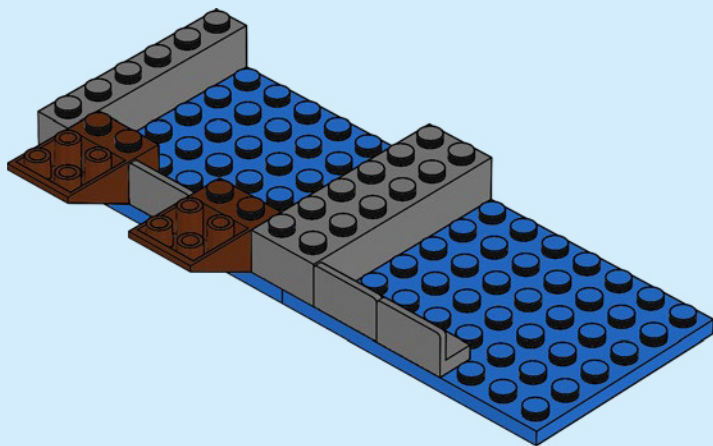

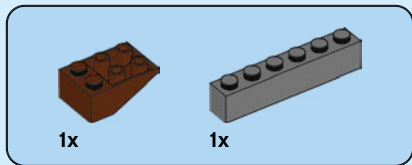

7

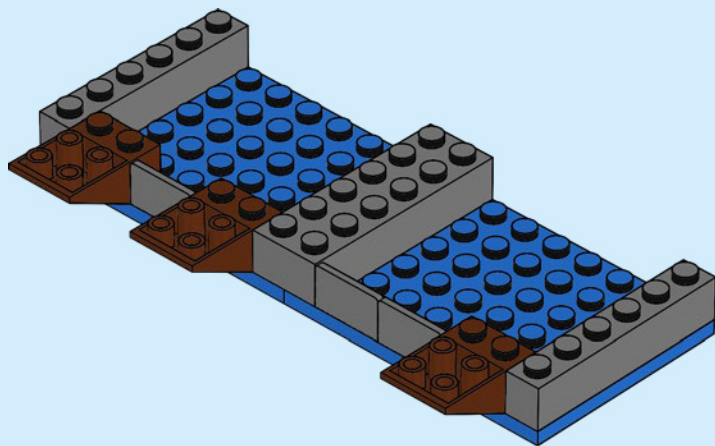

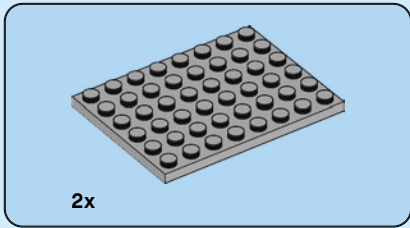

8

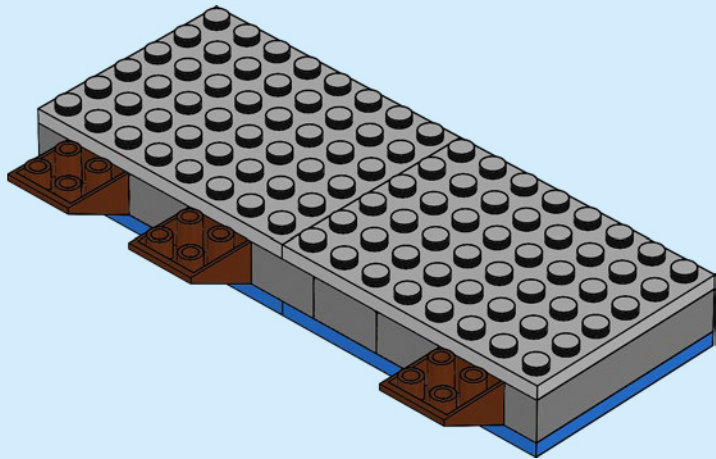

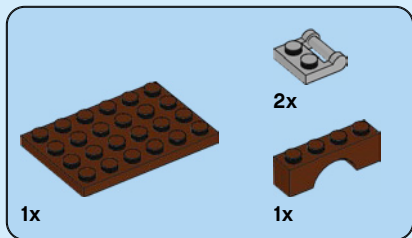

9

1

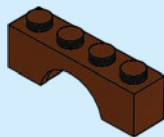

2

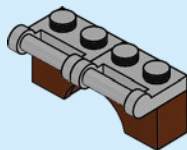

3

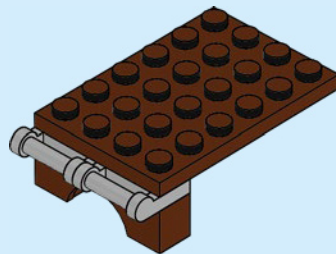

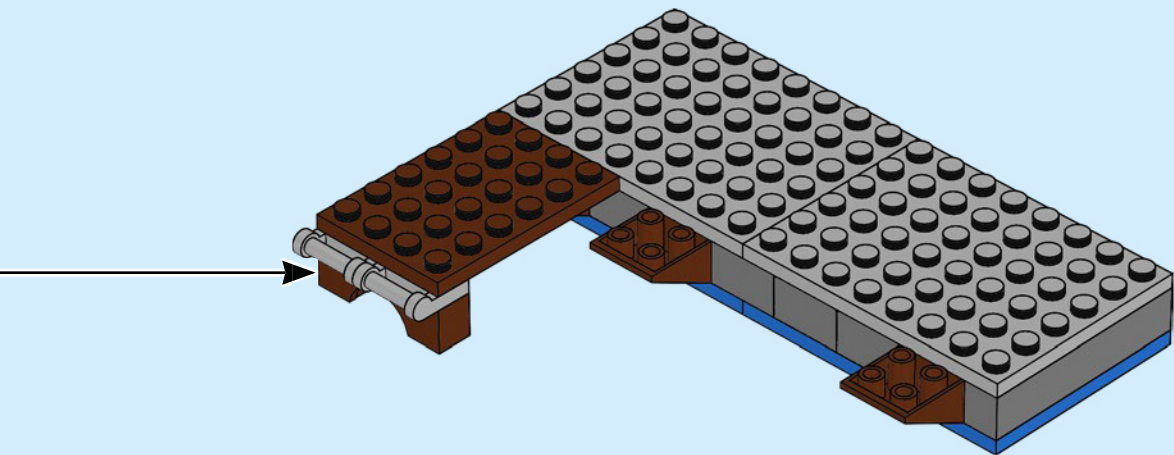

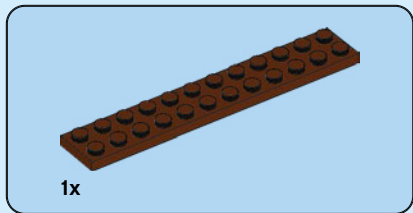

10

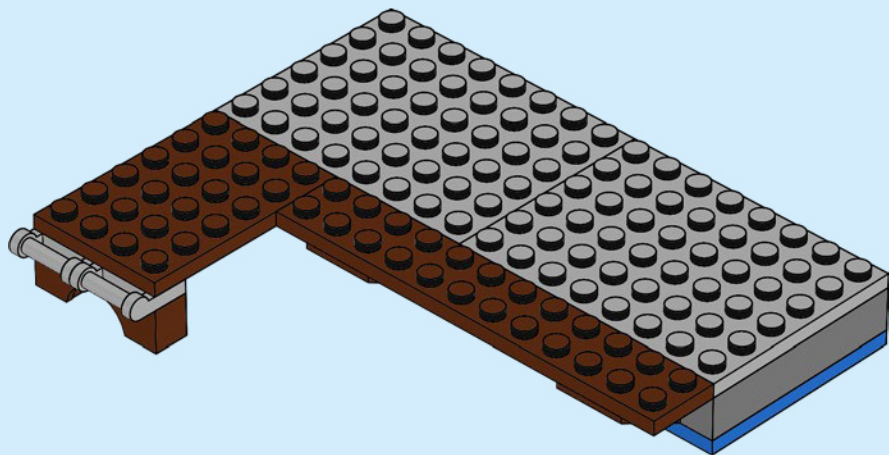

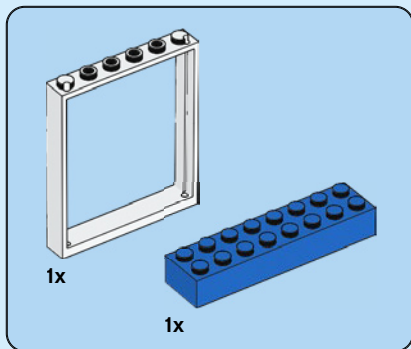

11

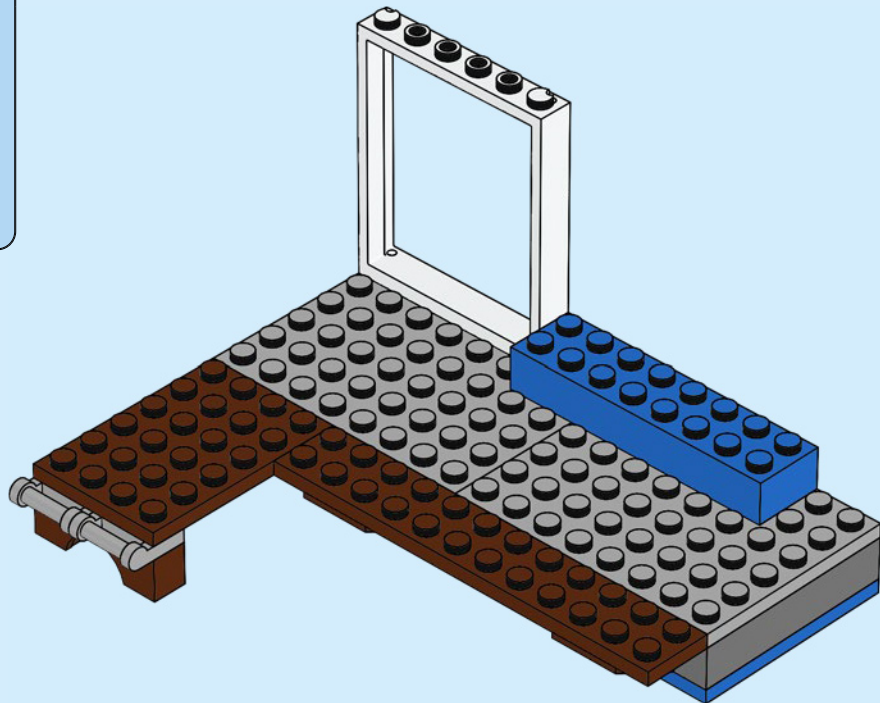

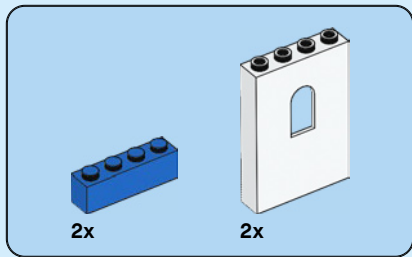

12

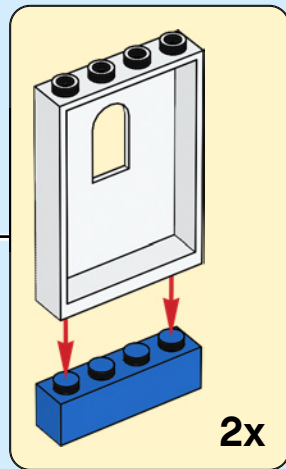
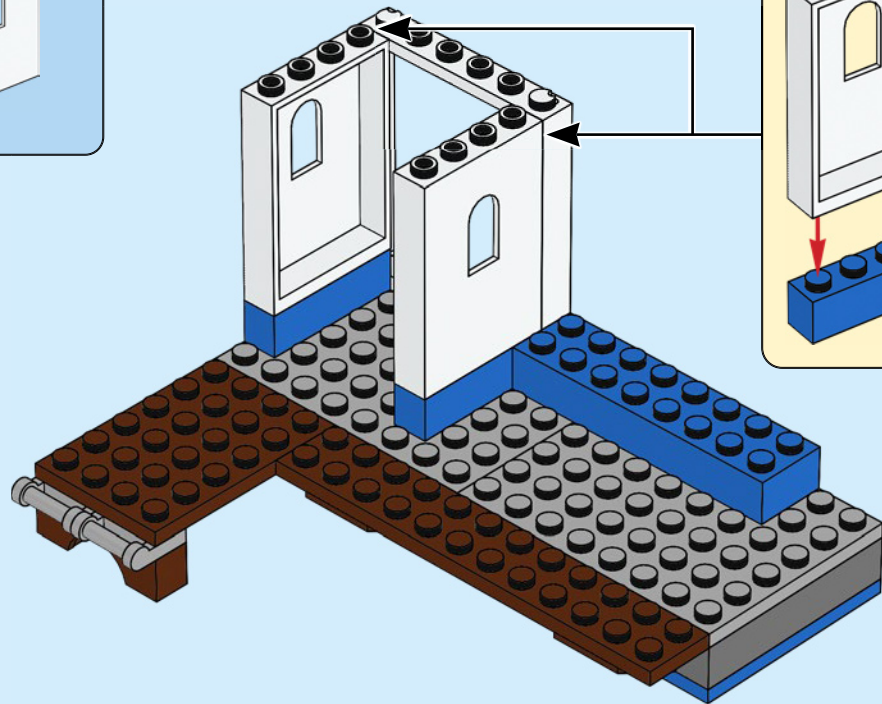

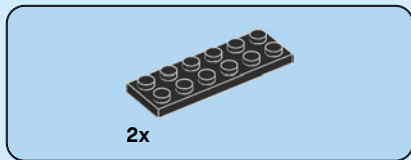

13

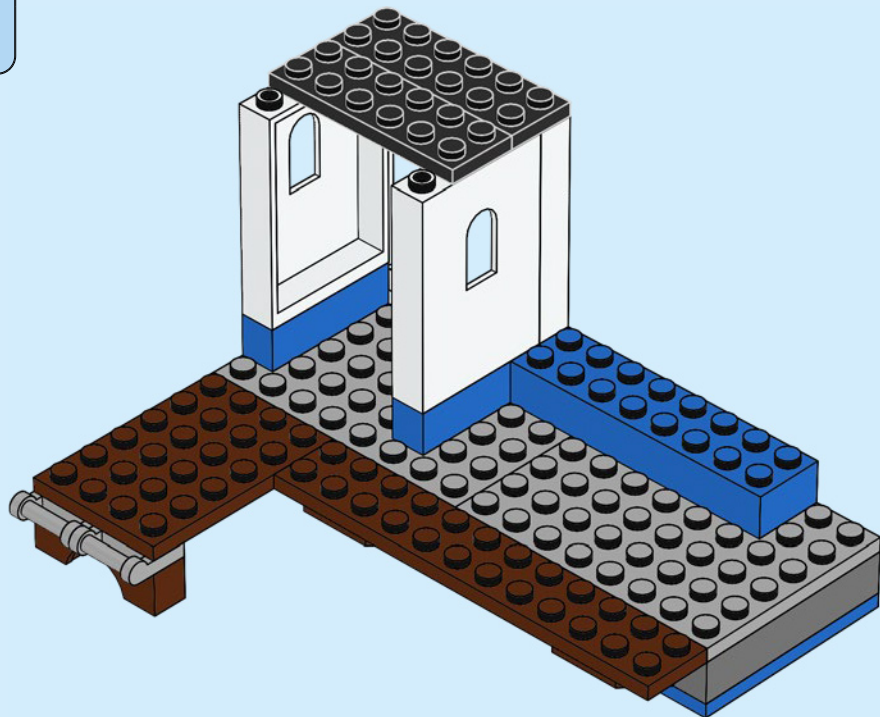

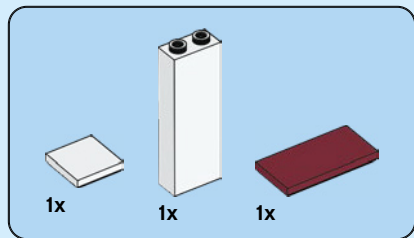

14

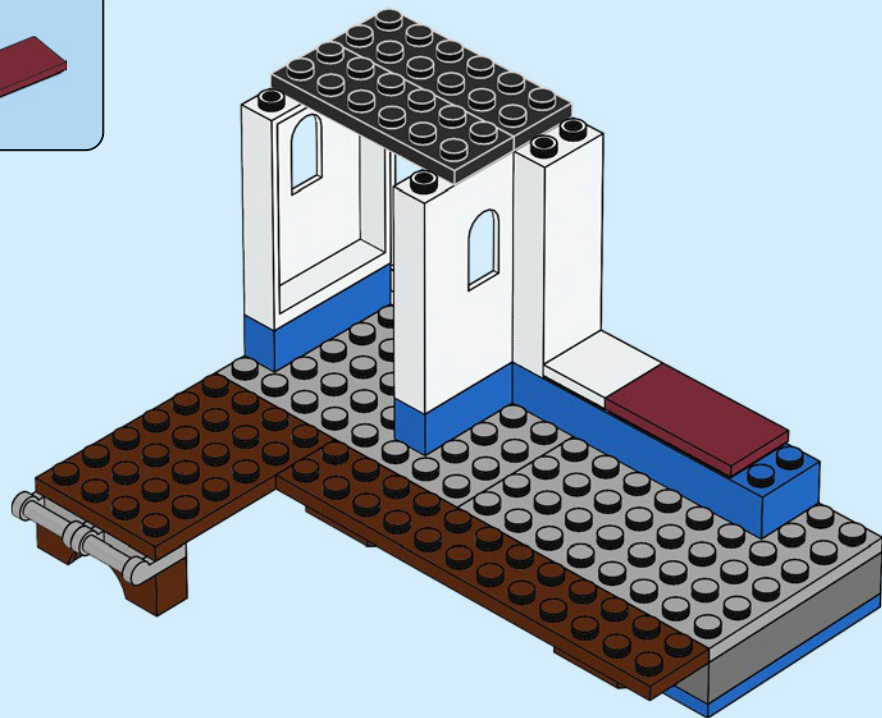



3x



4x

15

1

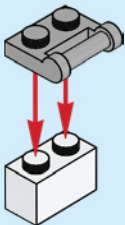

2

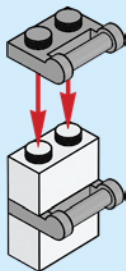

3

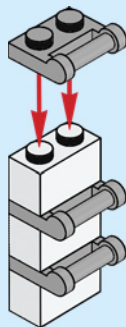

4

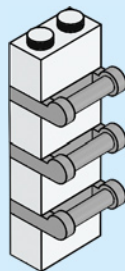

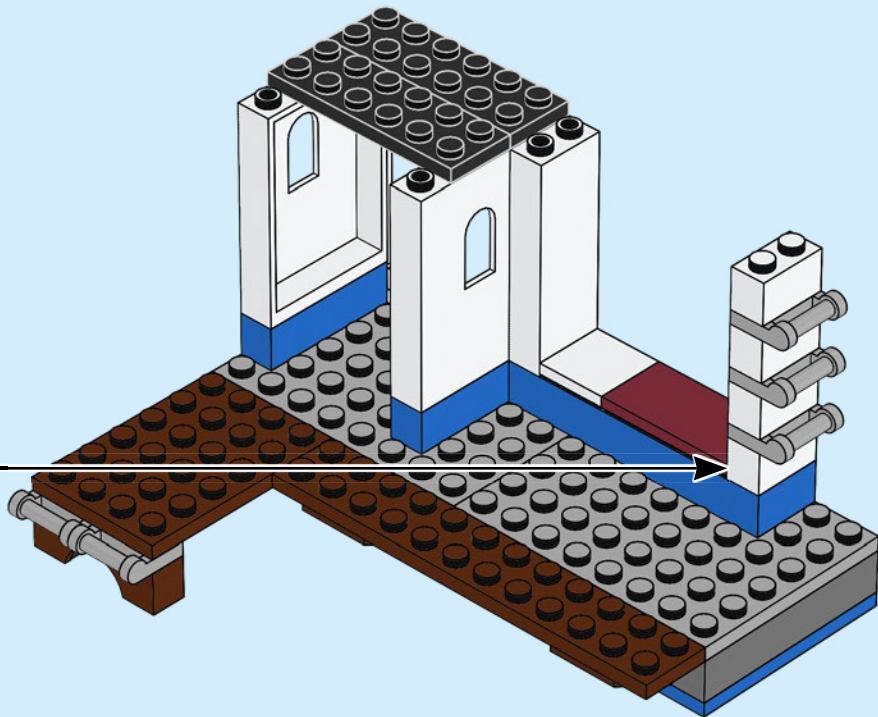

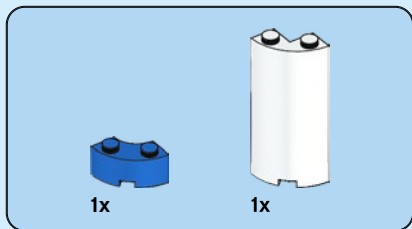

16

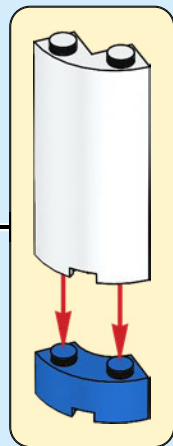

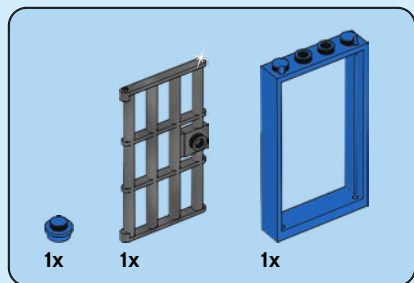

17

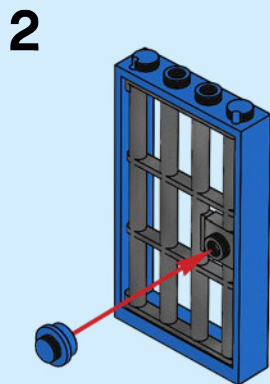
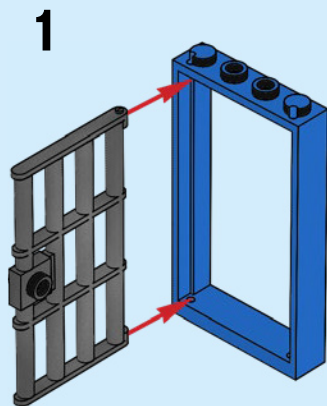

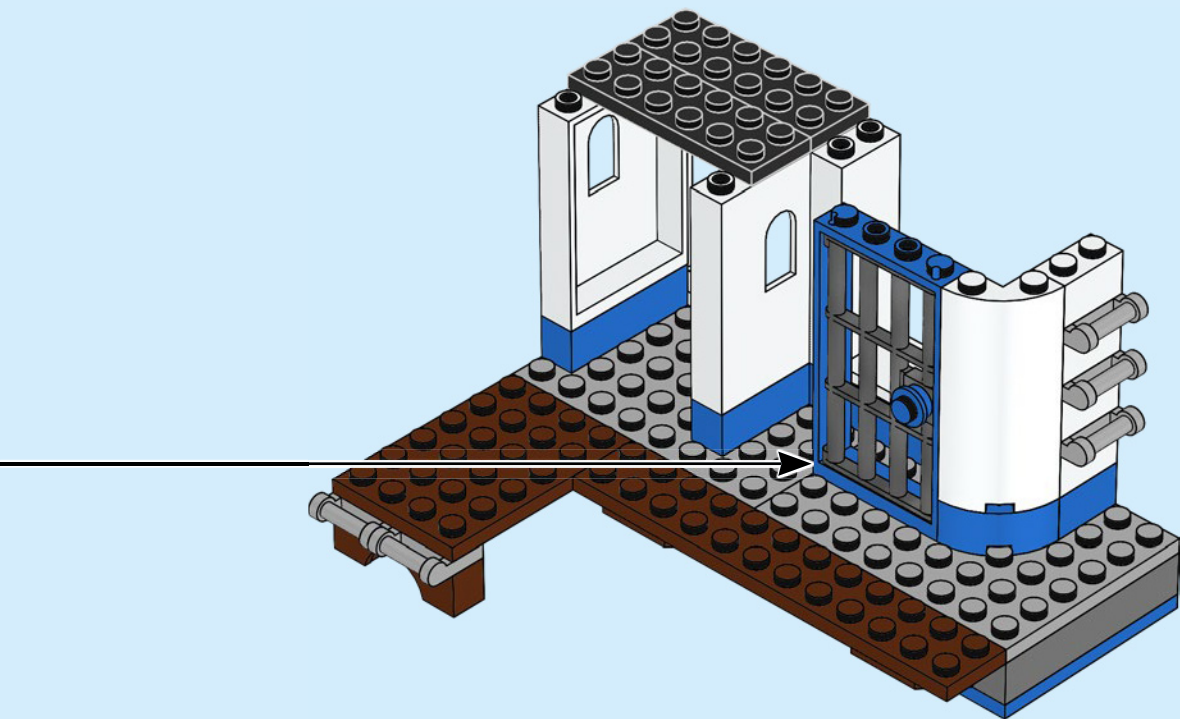

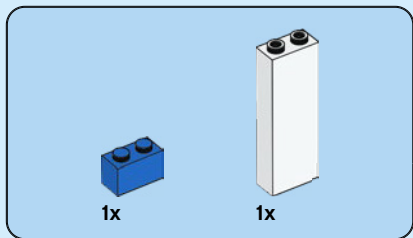

18

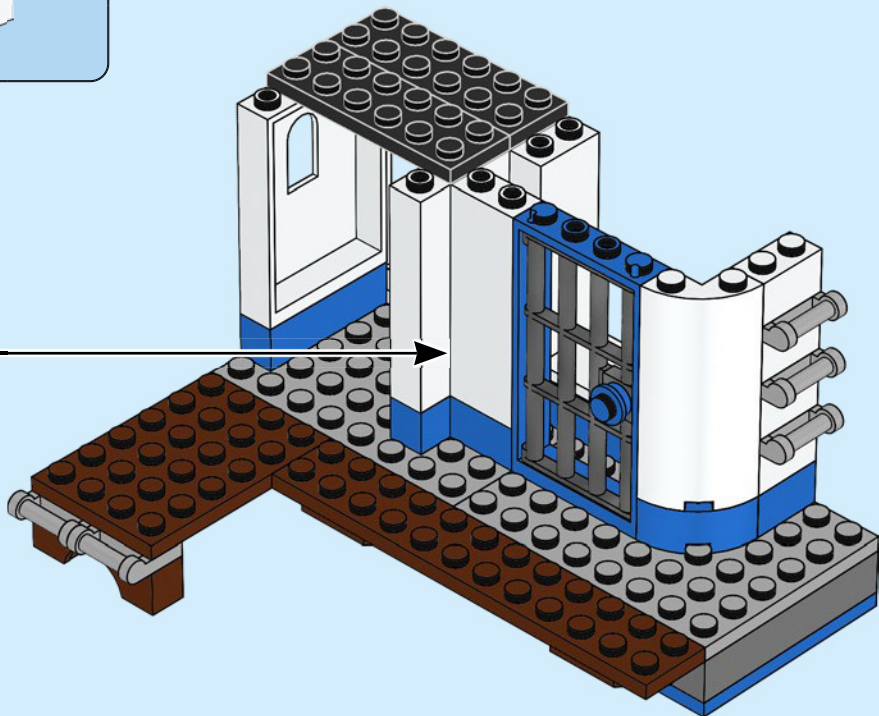
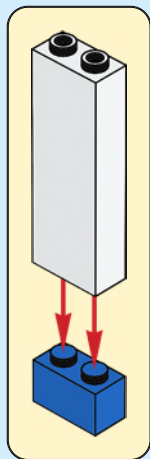

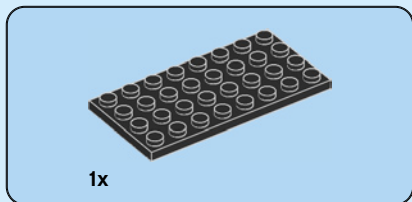

19

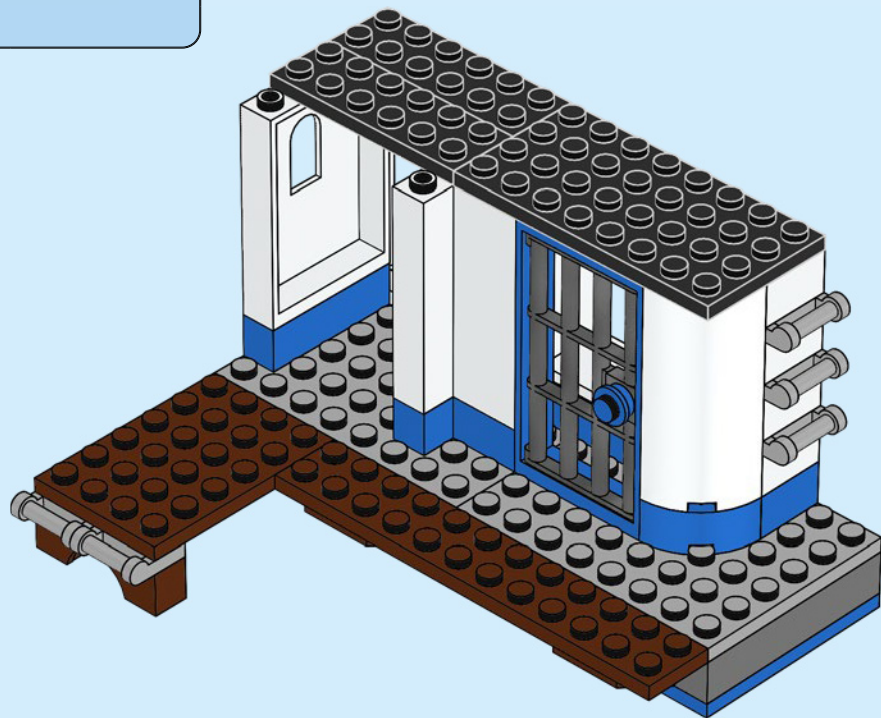

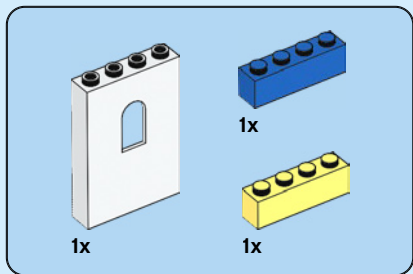

20

1

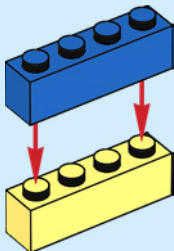

2

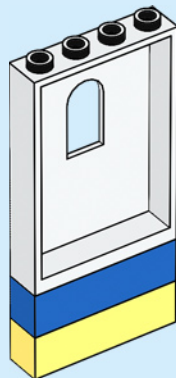

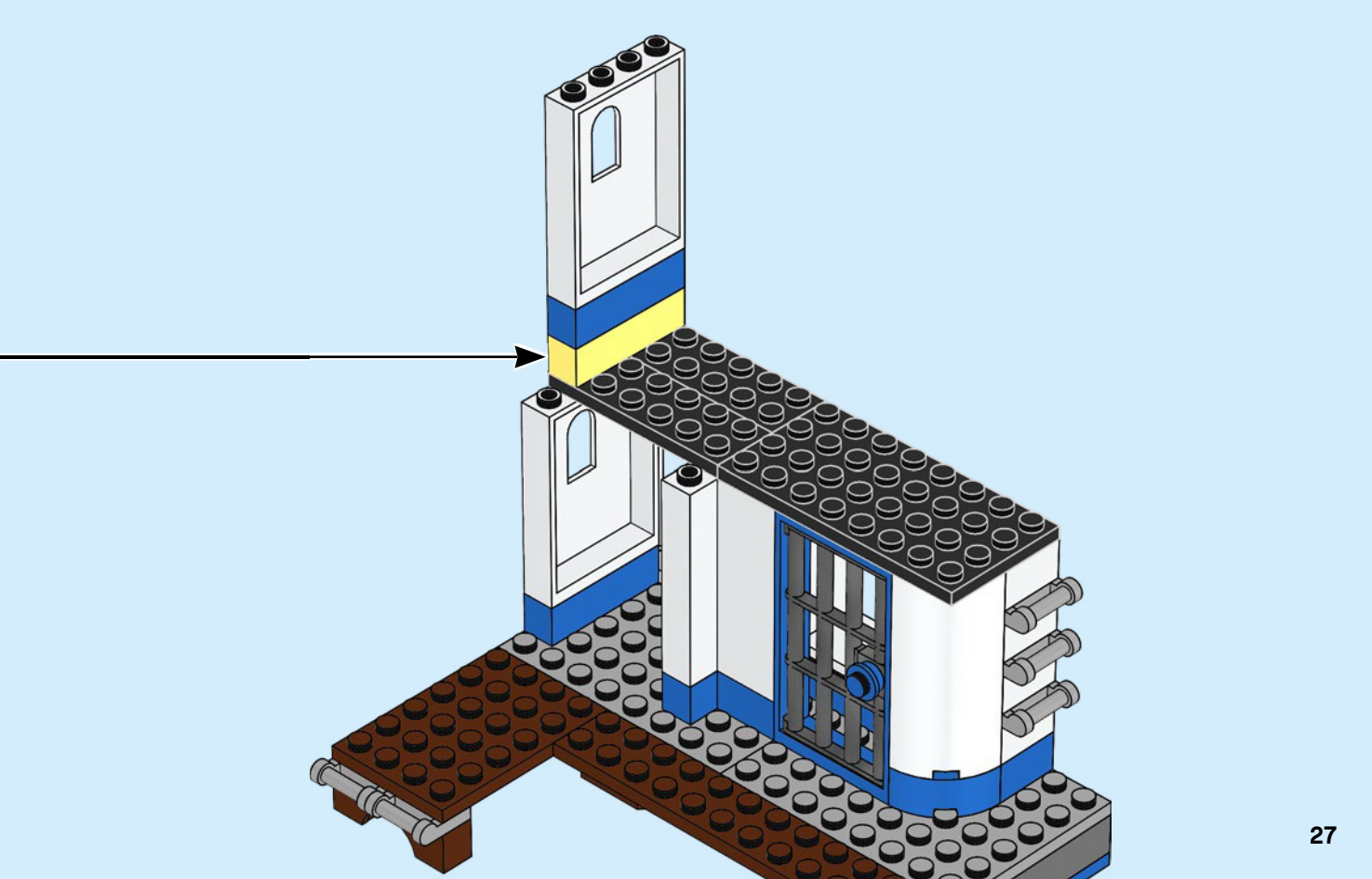



1x

21

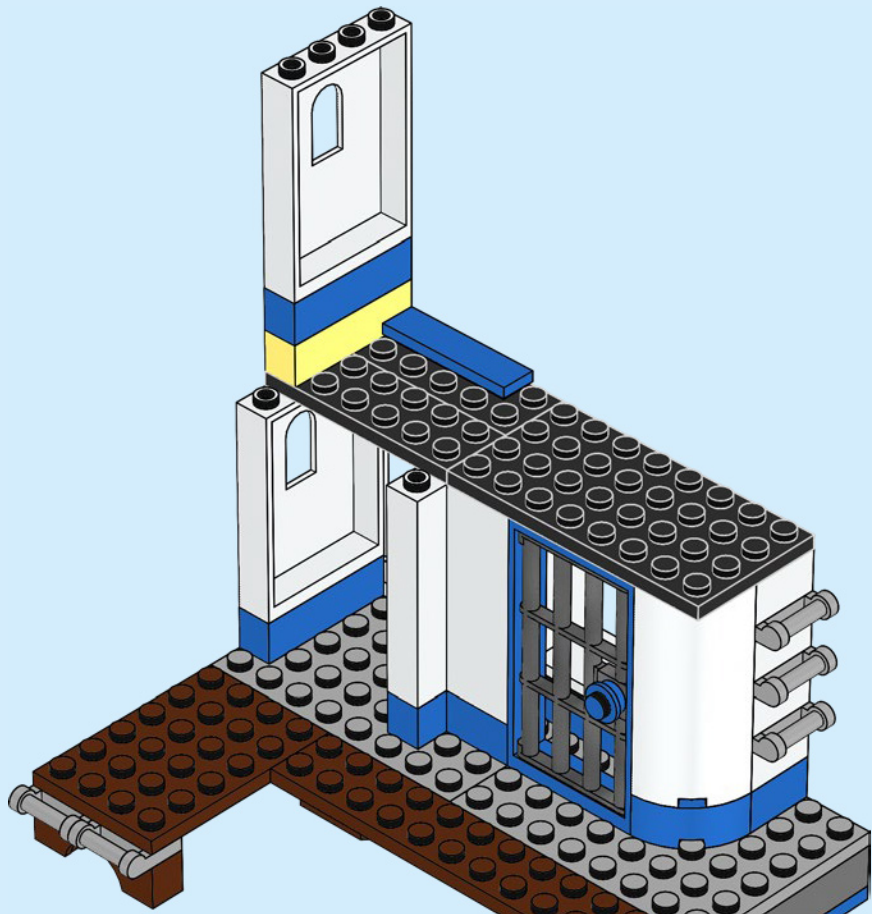

28

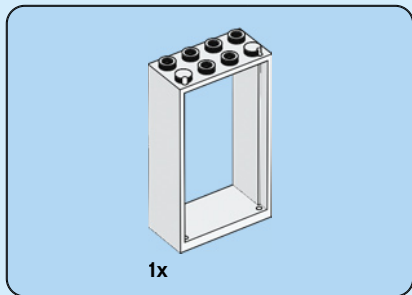

22

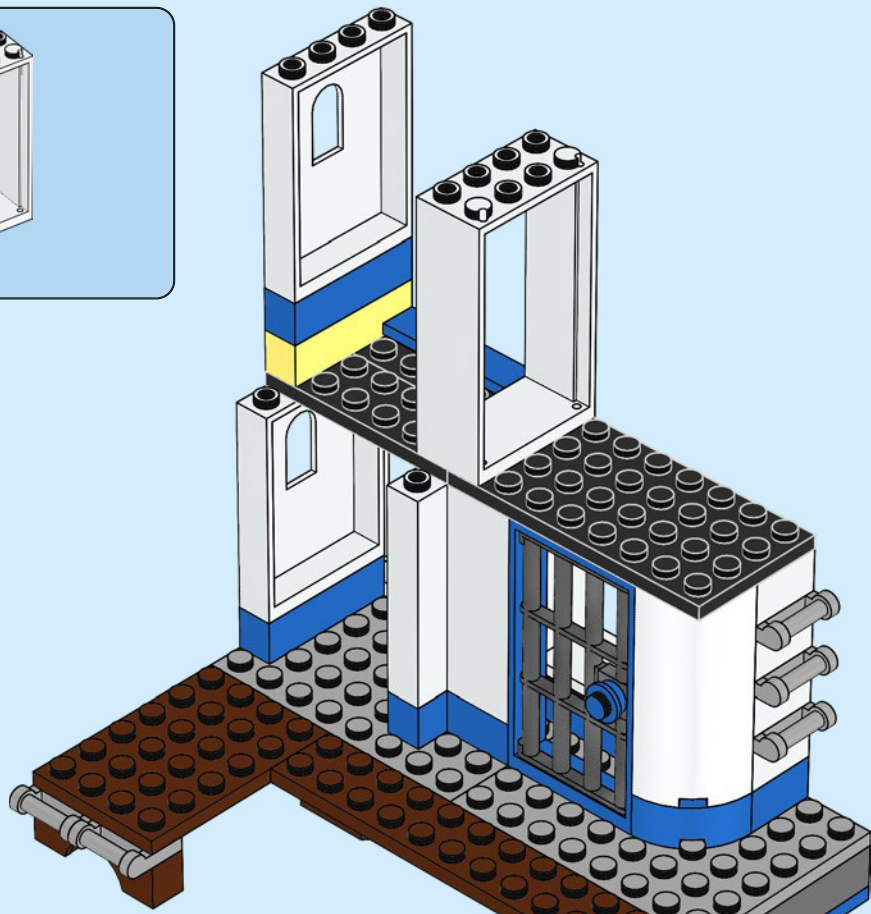

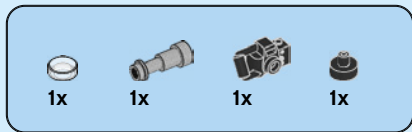

23

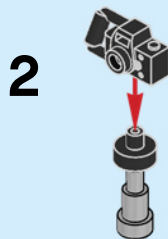
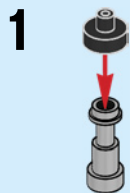

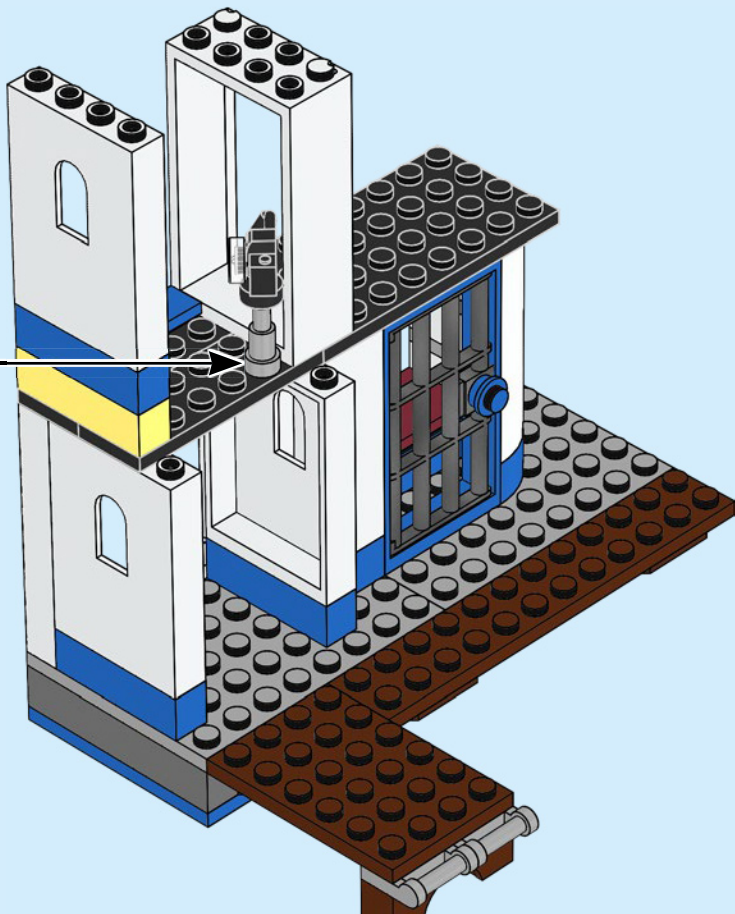

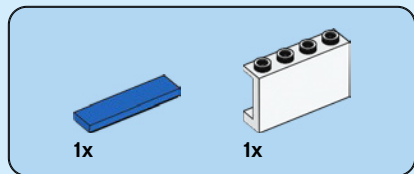

24

1

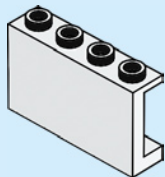

2

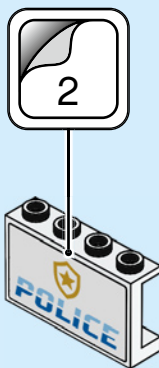

3



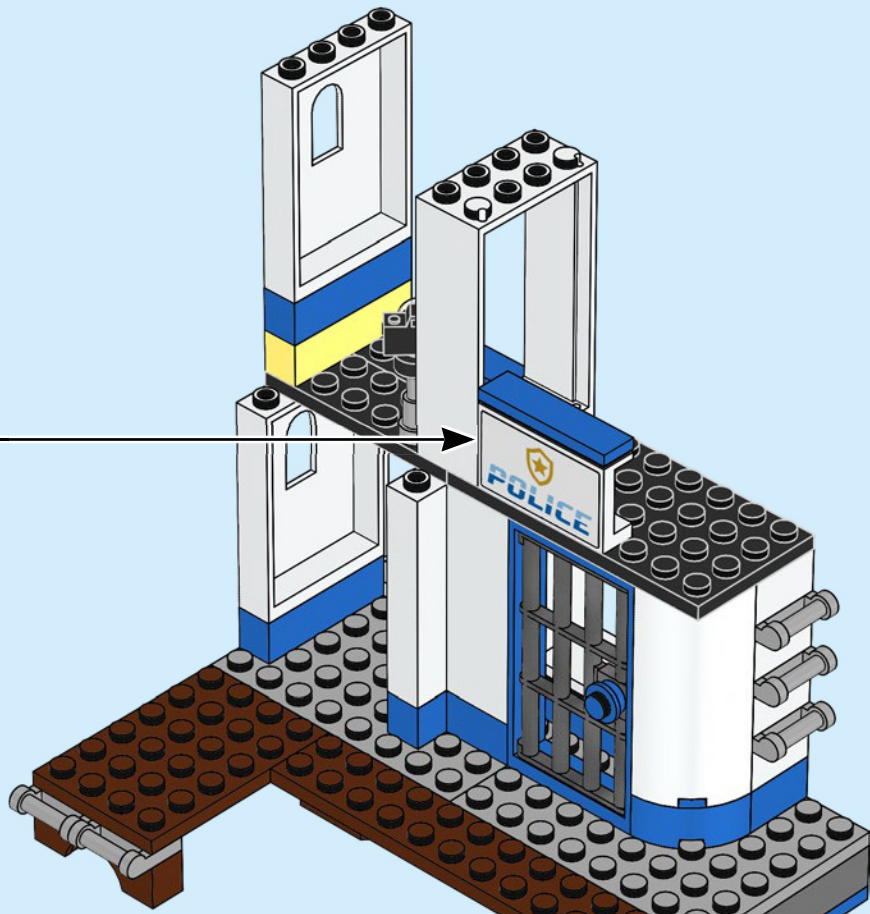
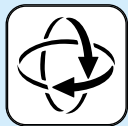



1x



1x

25

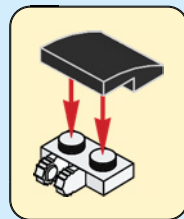

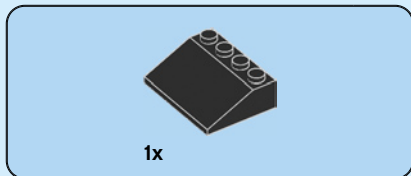

26



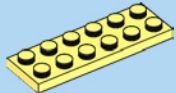

2x

27

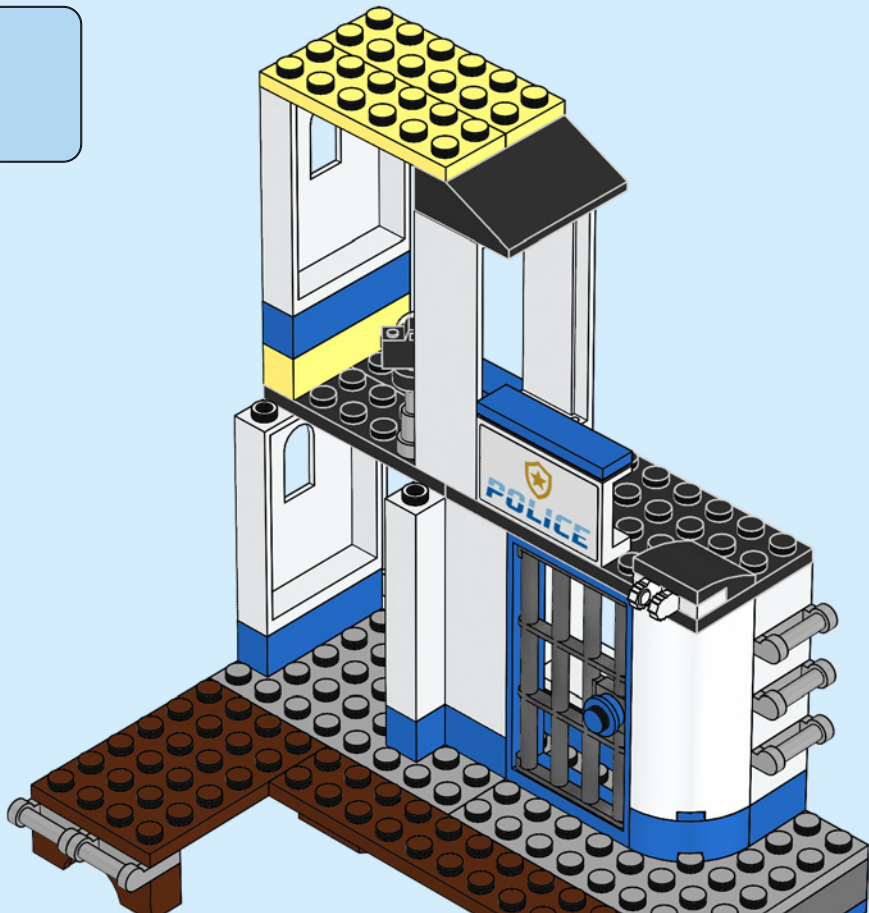

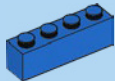

2x

28

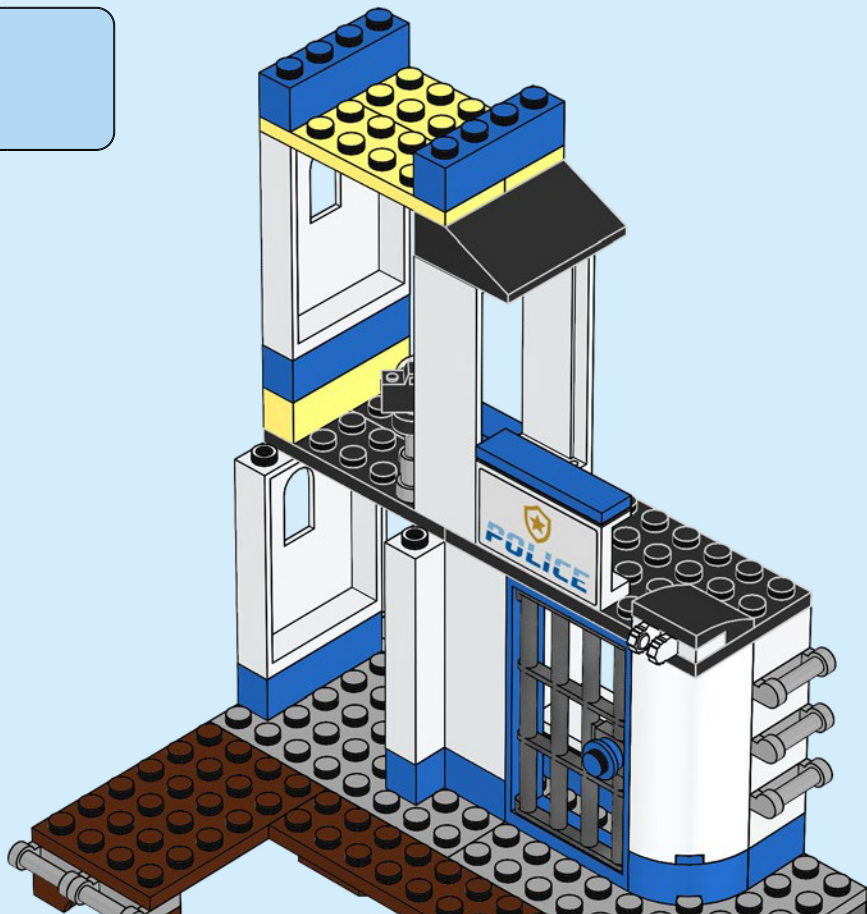



2x

29

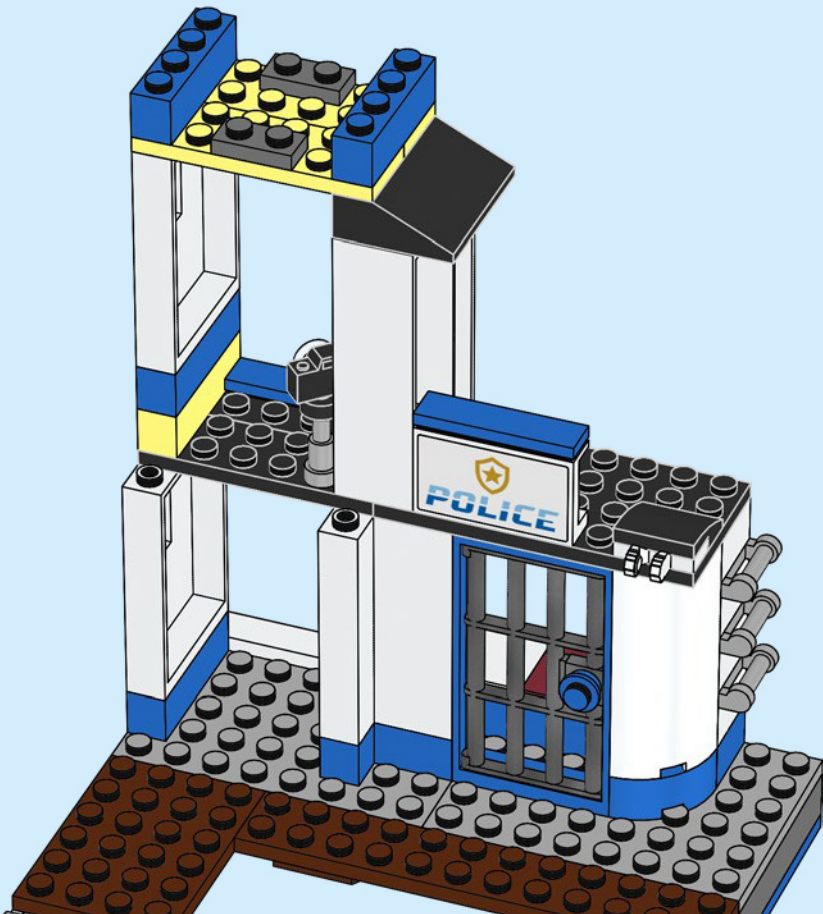

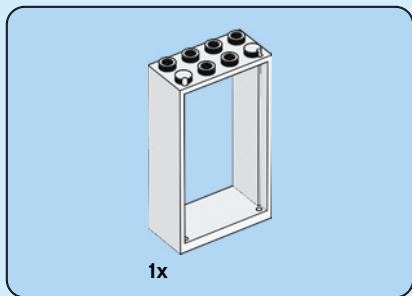

30

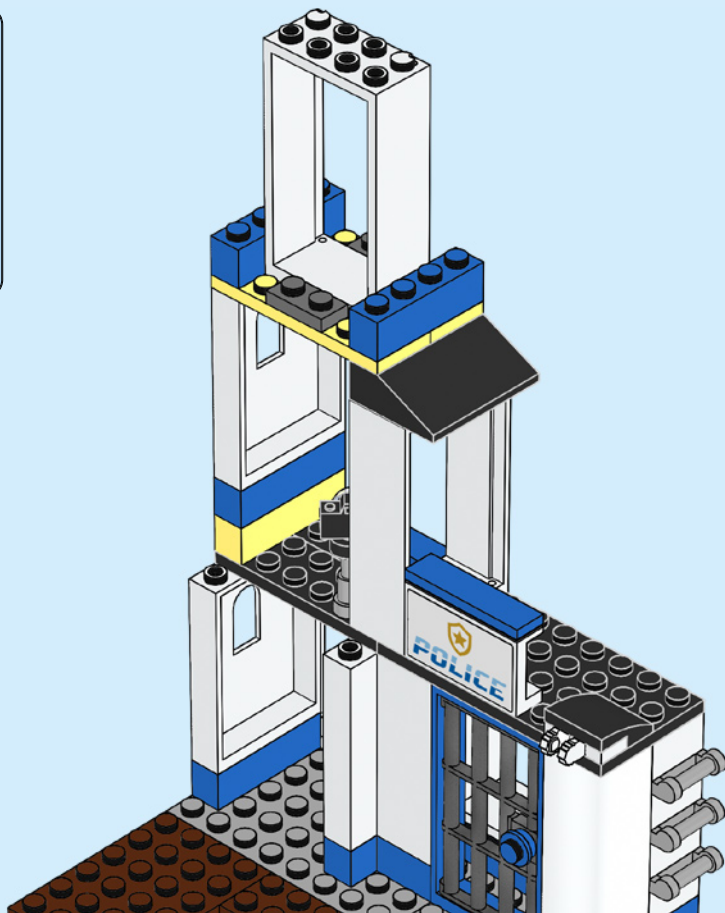

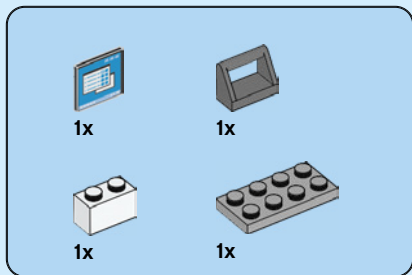

31

1

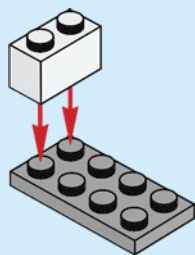

2

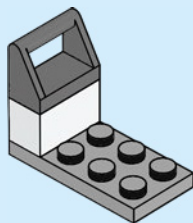

3



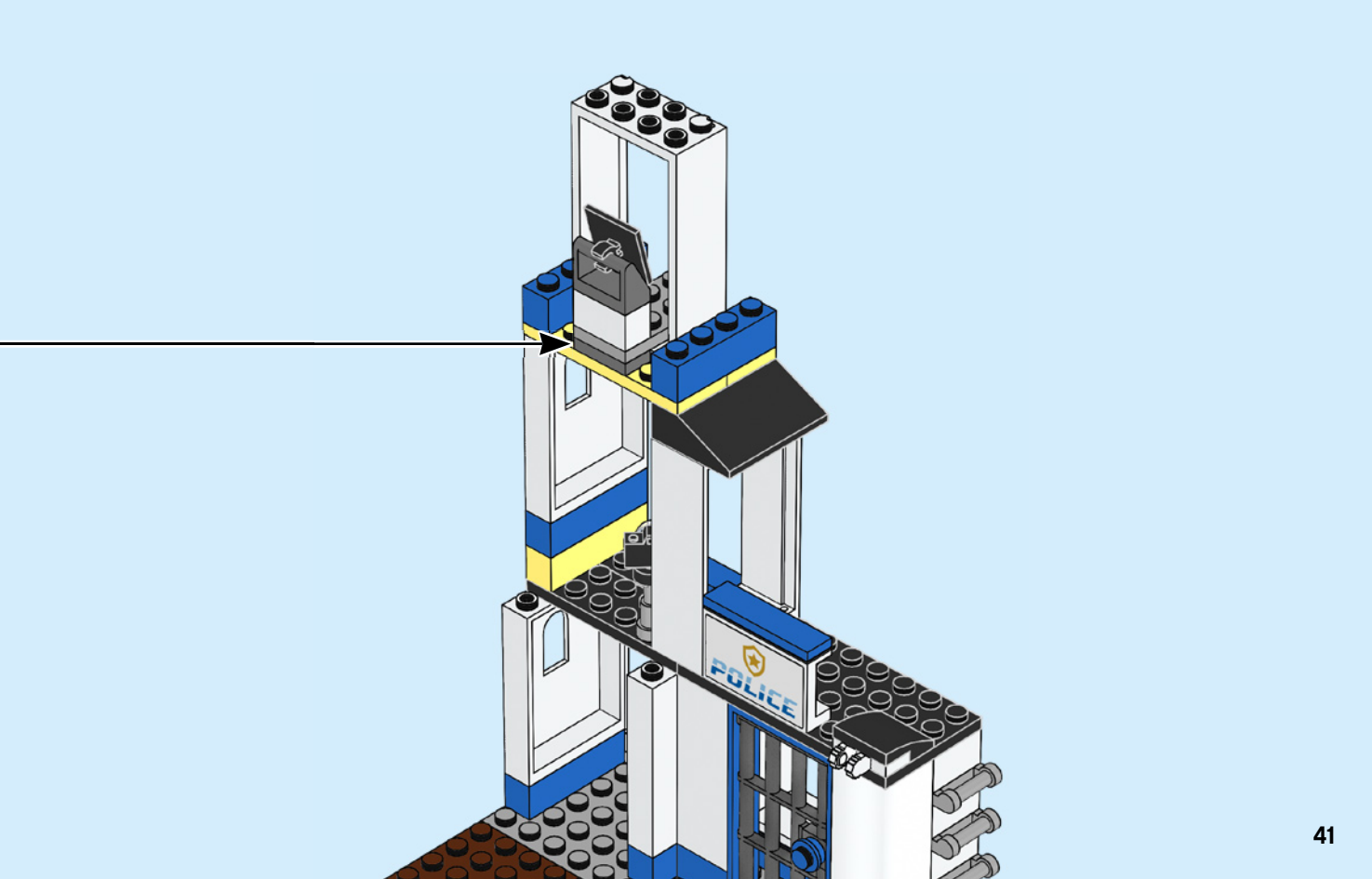

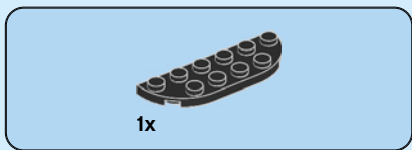
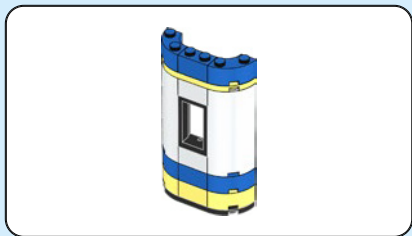

1x

32

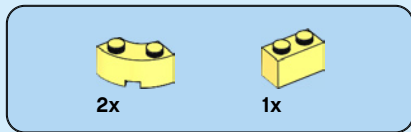

2x

1x

33

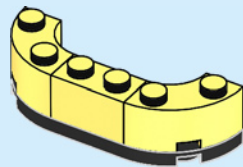

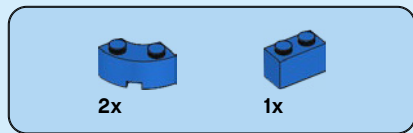

34

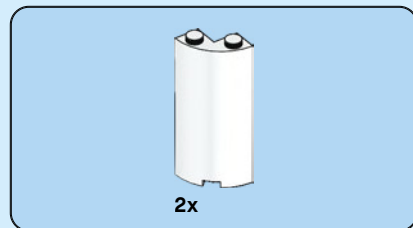
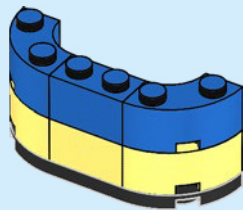

35

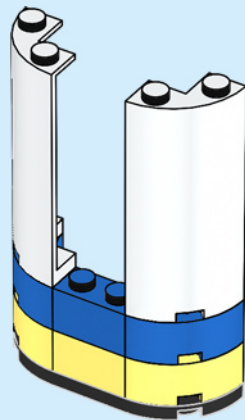

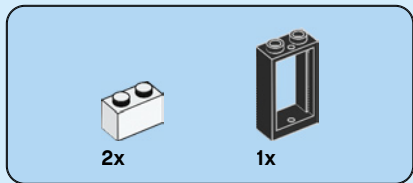

36

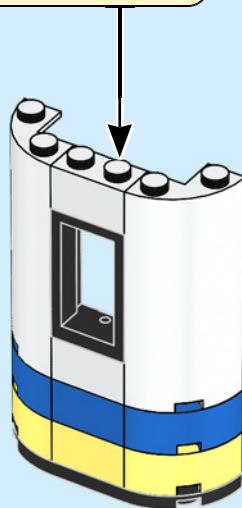
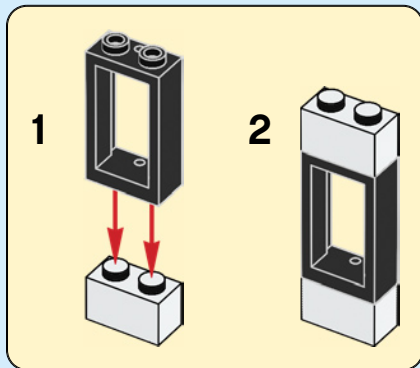

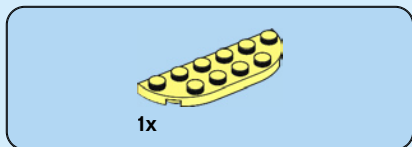

37

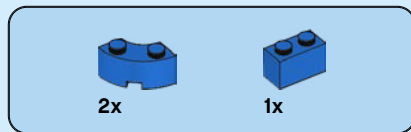
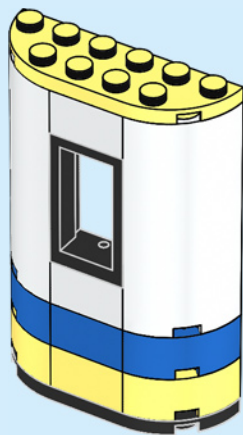

38

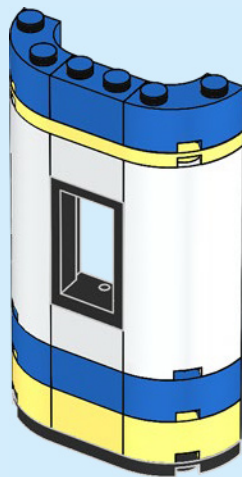

39

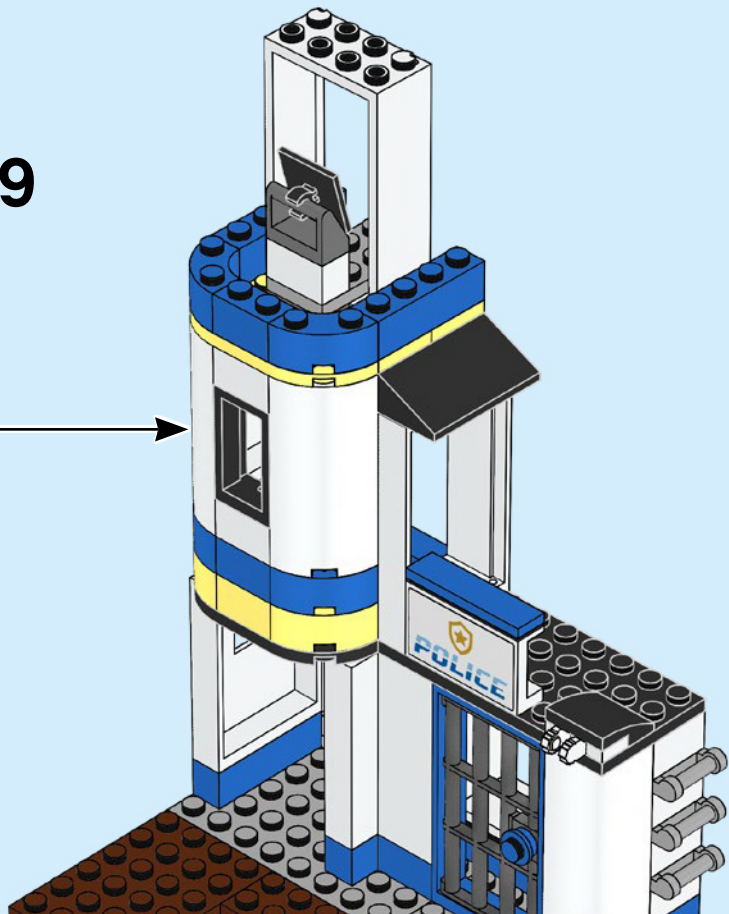

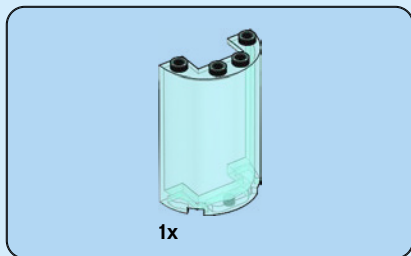

40

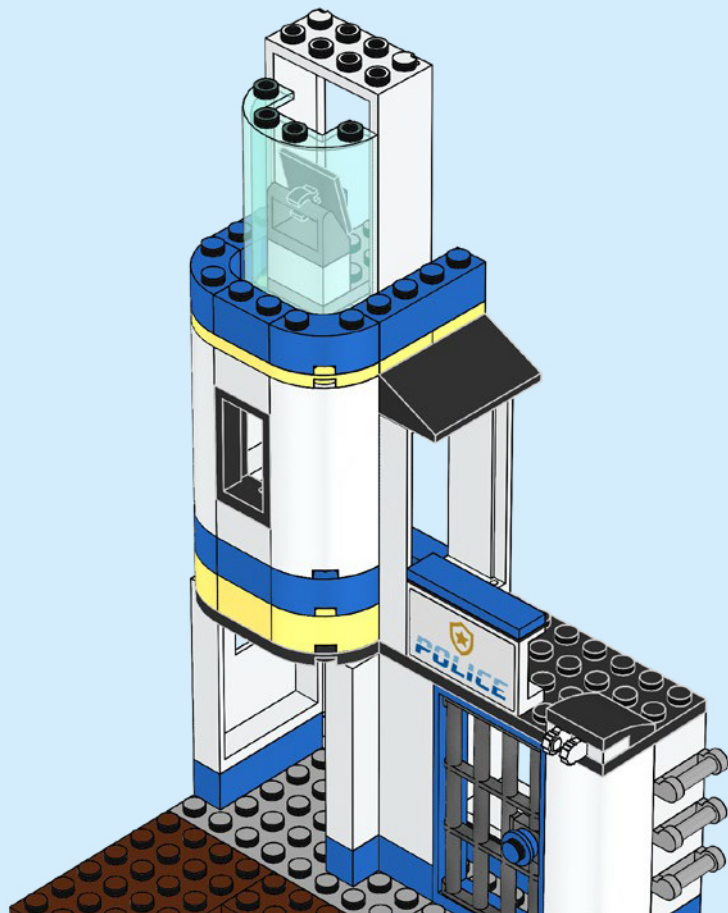



2x

41



48

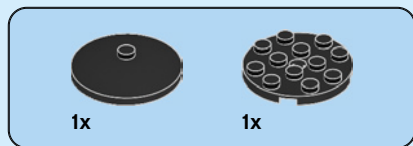

42

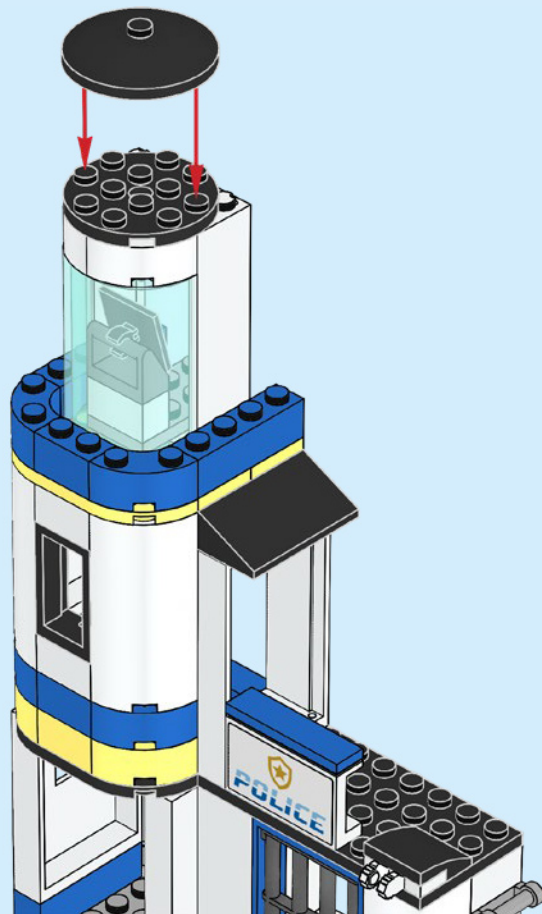



1x



1x

43

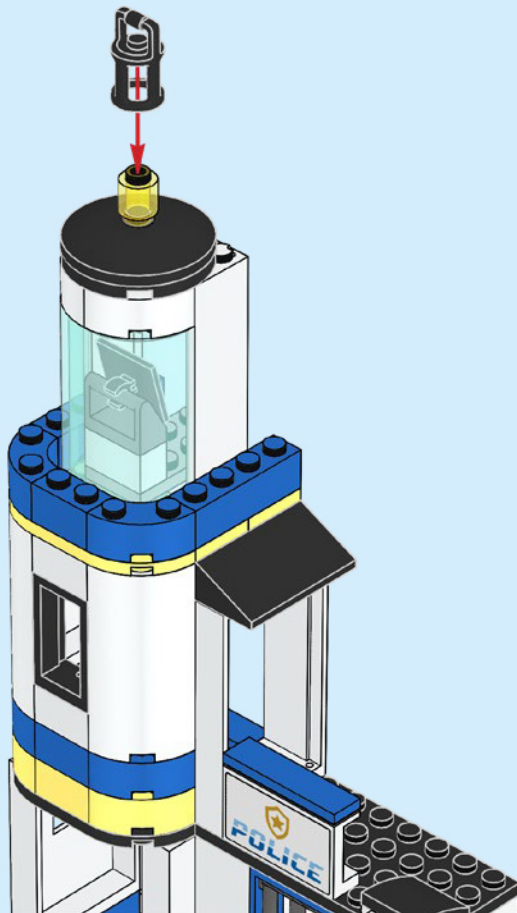

50



1x

1x

44

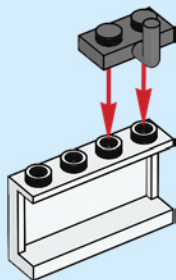

2x

45

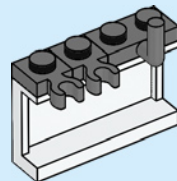



1x

46

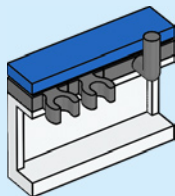

52



1x



1x



1x

47

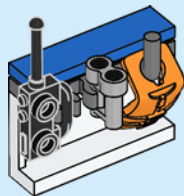

48

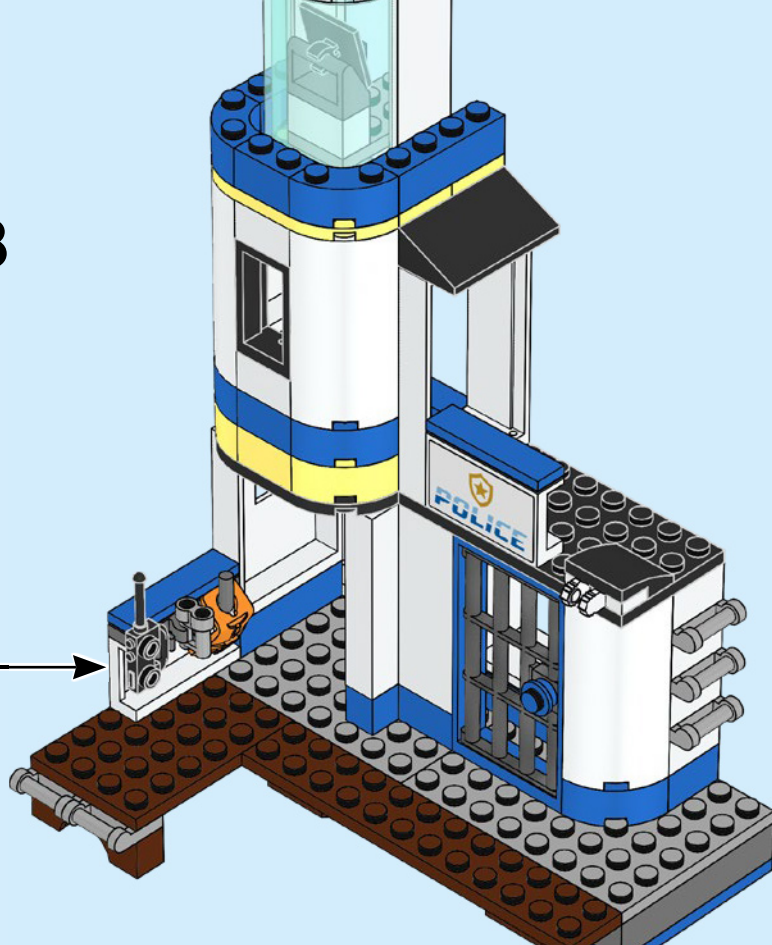

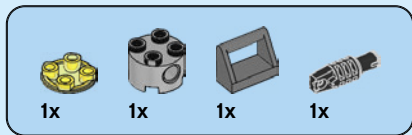

49

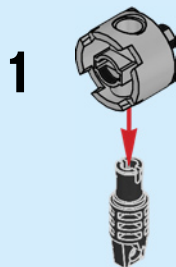

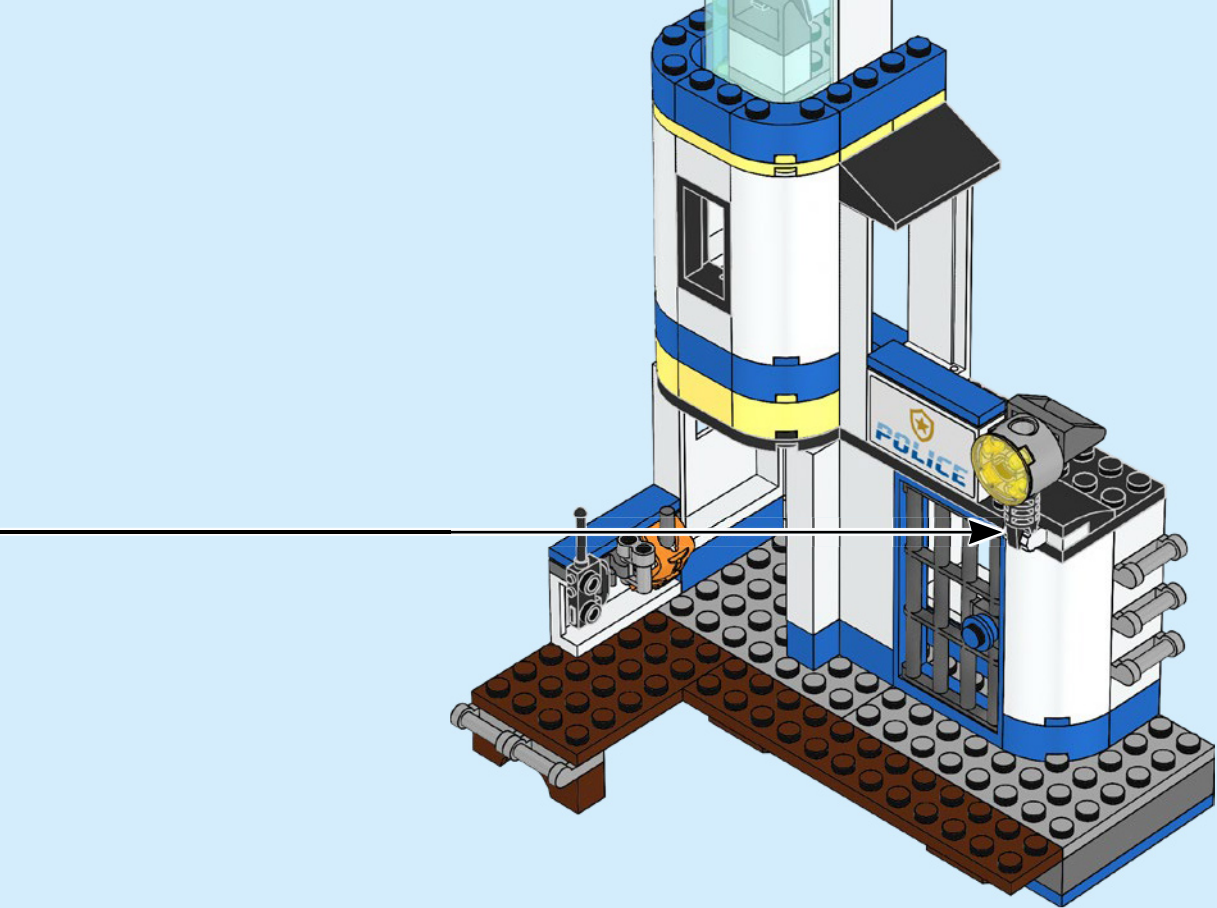

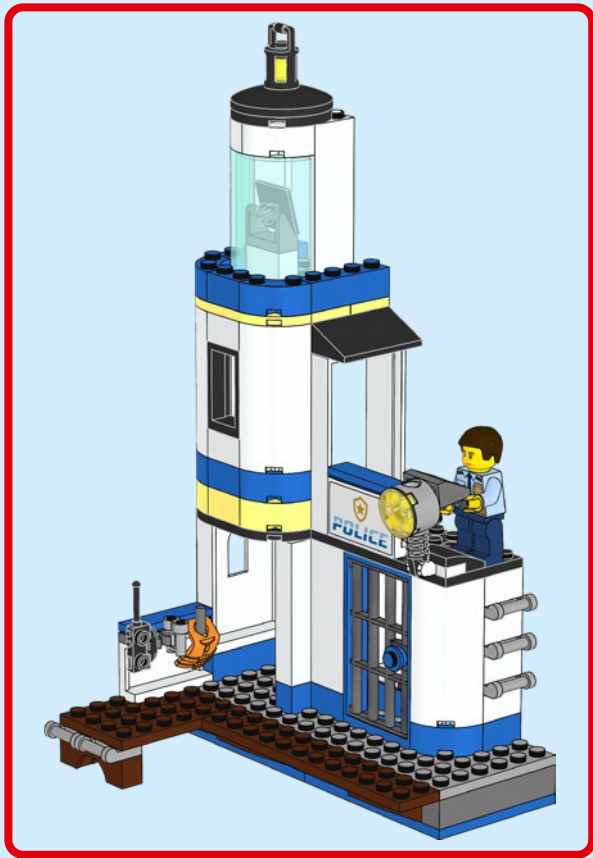



CITY

ADVENTURES

City Abenteuer
Aventuras en City
City Aventuras
City kalandok
City piedzīvojumi
乐高城市大冒险

Aus der erfolgreichen TV-Serie!
Vu dans la série télévisée à succès !
Dalla divertentissima serie TV!
¡De la popular serie de la tele!
Da série de sucesso da TV!
A népszerű TV-sorozatból!
No populārā TV seriāla!
源自热门动画片!



FROM THE HIT
TV SERIES!

CITY ADVENTURES

AVENTURAS CITY



VITO

60242



**SAM
GRIZZLED**

60243



**SNAKE
RATTLER**

60243 • 60276



**ROOKY
PARTNUR**

60244



**FRANKIE
LUPELLI**

60244 • 60277



**TOM
BENNETT**

60245



**BIG
BETTY**

60245



WHEELER

60246



**DAISY
KABOOM**

60246



**CLARA
THE CRIMINAL**

60276



**GRACIE
GOODHART**

60277



**DUKE
DETAIN**

60242 • 60246 • 60276



**FREYA
MCLOUD**

60248 • 60280



CLEMMONS

60247 • 60281



BOB

60282



FELDMAN

60282



**TREAD
OCTANE**

60258



**HARL
HUBBS**

60258 • 60266



**SHIRLEY
KEEPER**

60292



MADISON

60292



CITY

