



# CITY

60308



**WARNING:** CHOKING HAZARD.  
Toy contains small parts and a small ball.  
Not for children under 3 years.

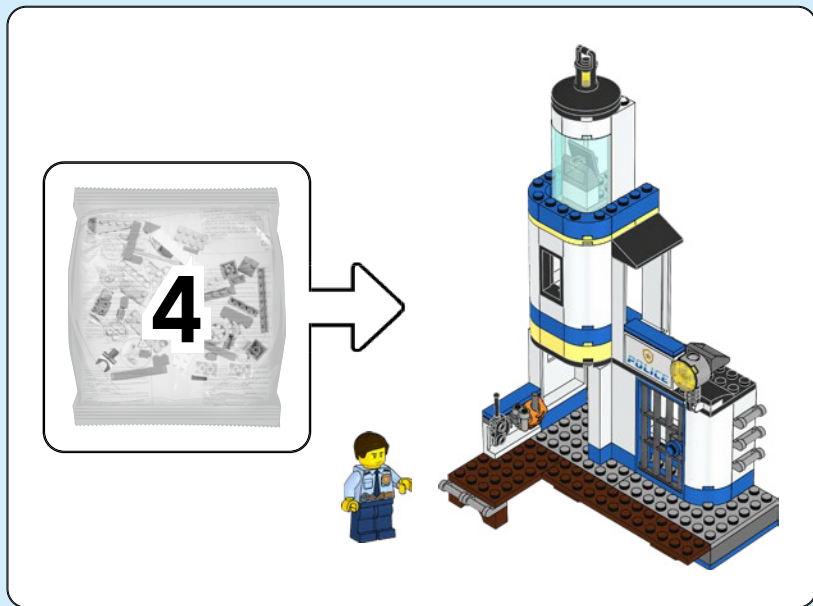



**AVERTISSEMENT :**

**RISQUE D'ÉTOUFFEMENT.**

Le jouet contient des petites pièces ainsi qu'une petite boule.

Il ne convient pas aux enfants de moins de 3 ans.



**ADVERTENCIA:**

**PELIGRO DE ASFIXIA.**

Juguete que contiene partes pequeñas y una pelota pequeña.

No recomendado para niños menores de 3 años.

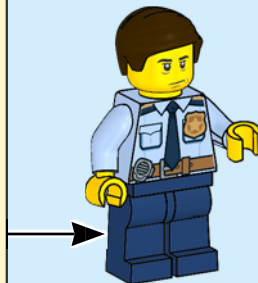
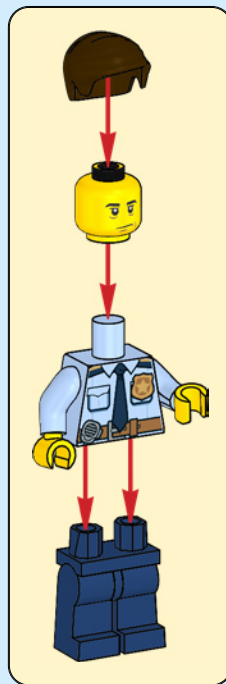

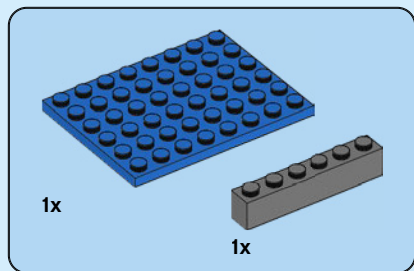

1

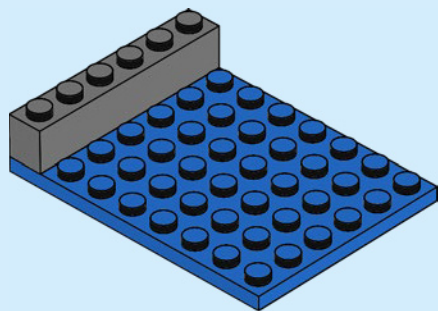



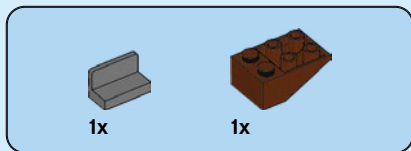

2

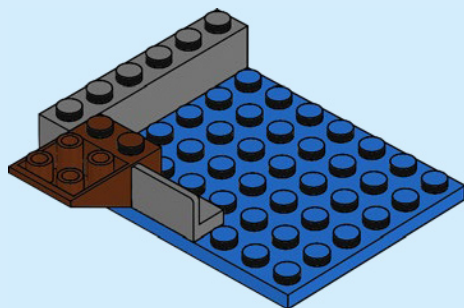



1x

3

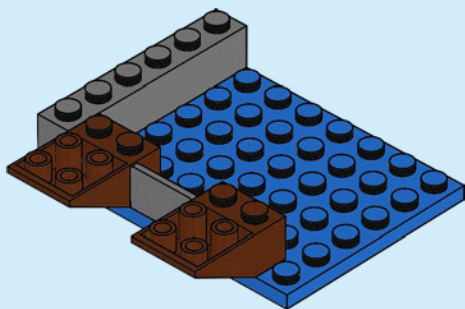

6

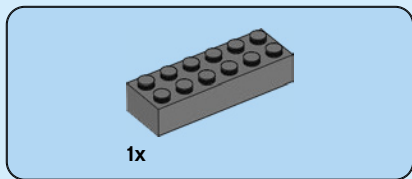

4

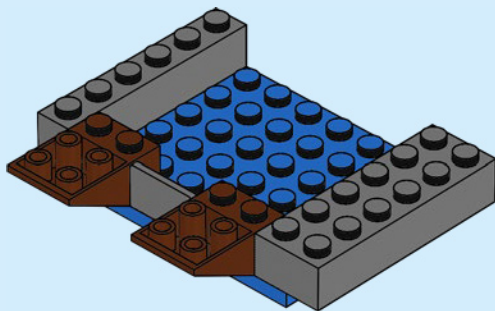

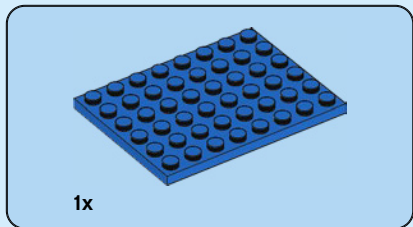

5

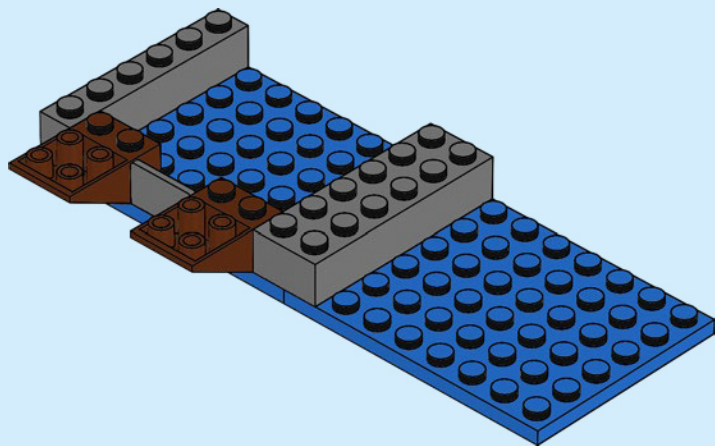

8



2x

6

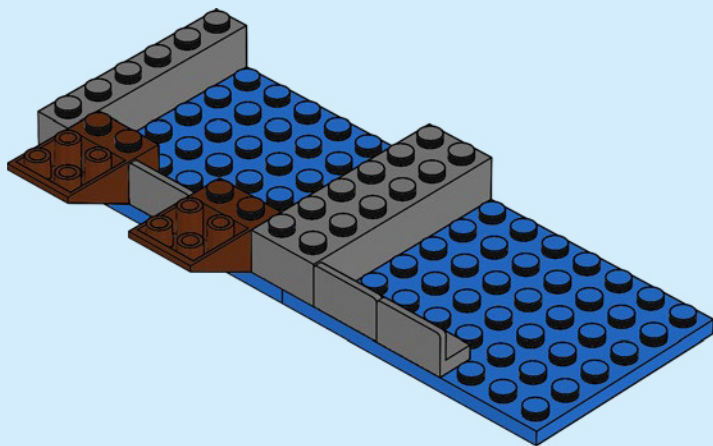

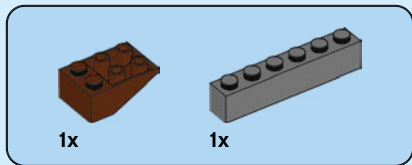

7

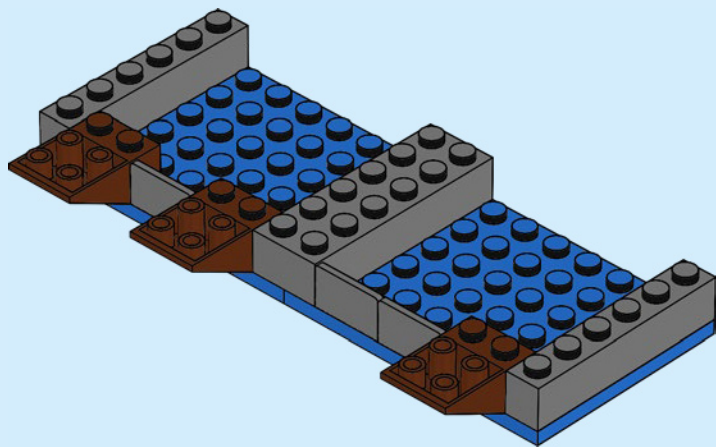

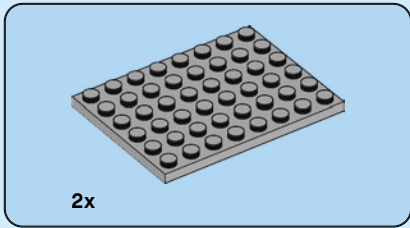

8

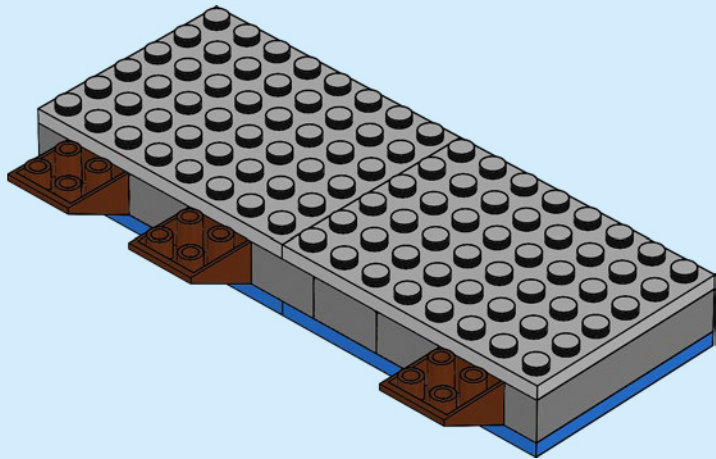

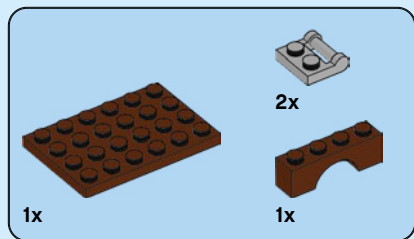

9

1

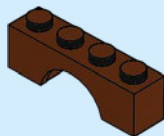

2

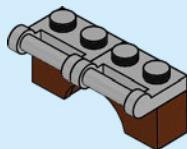

3

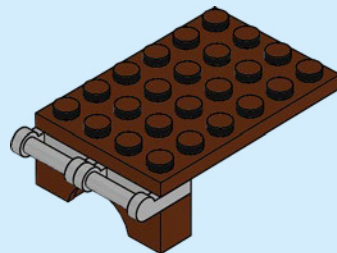



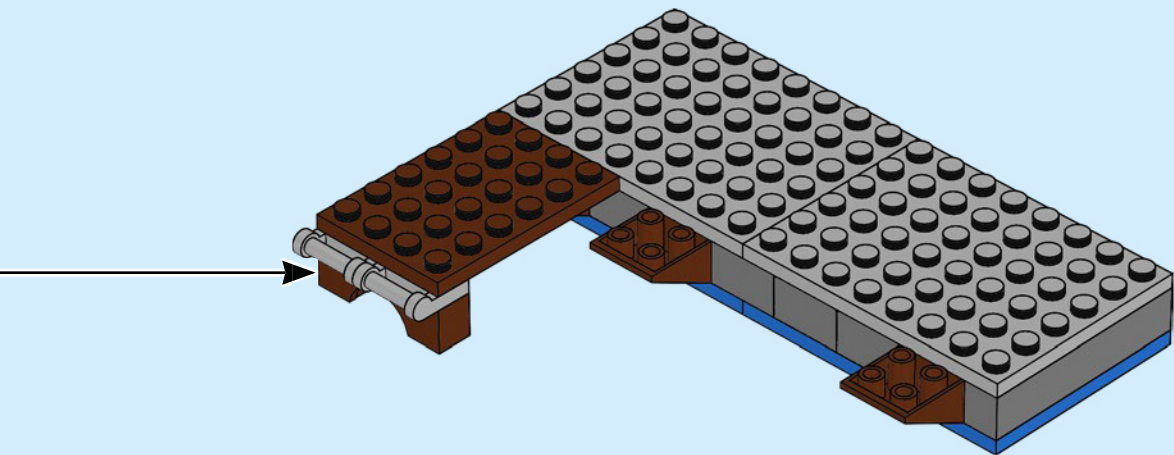

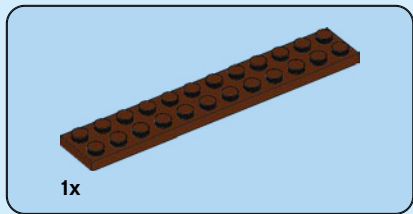

10

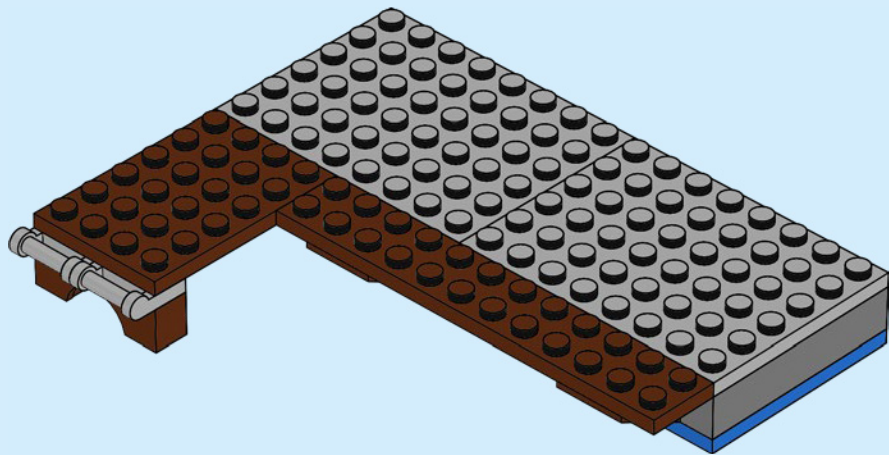

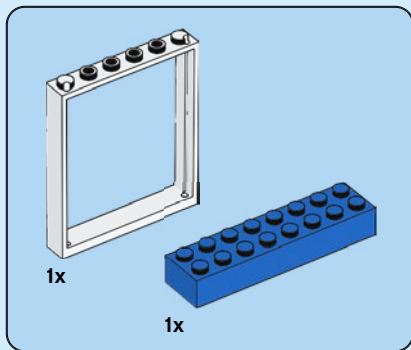

11

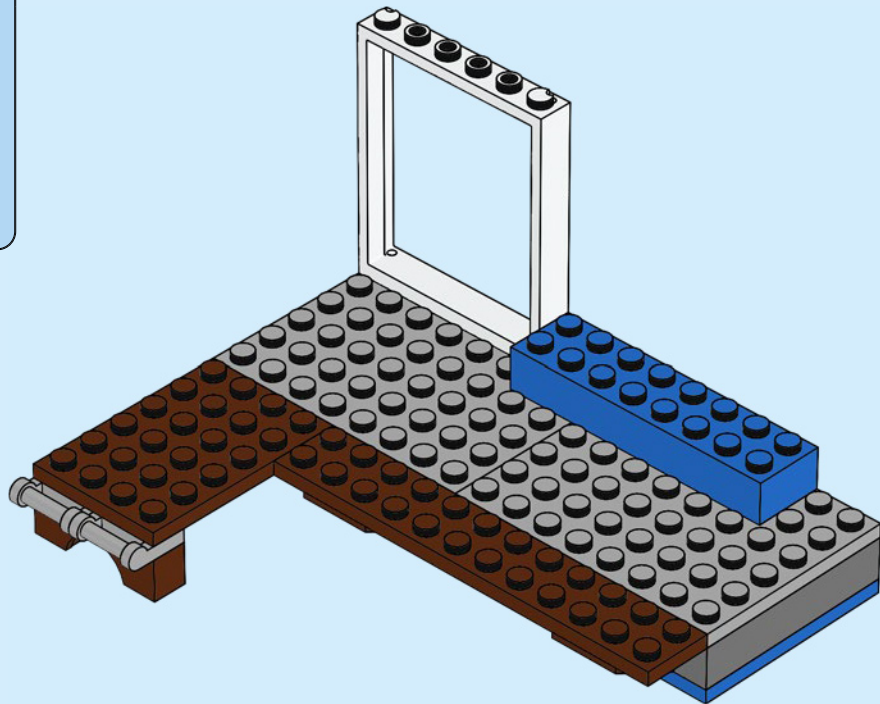

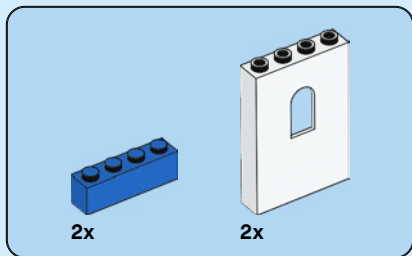

12

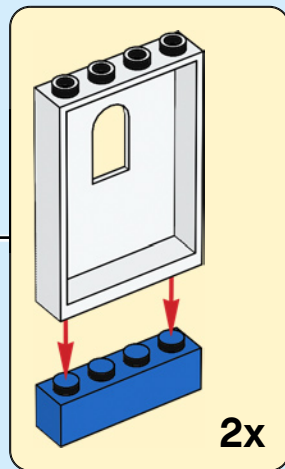
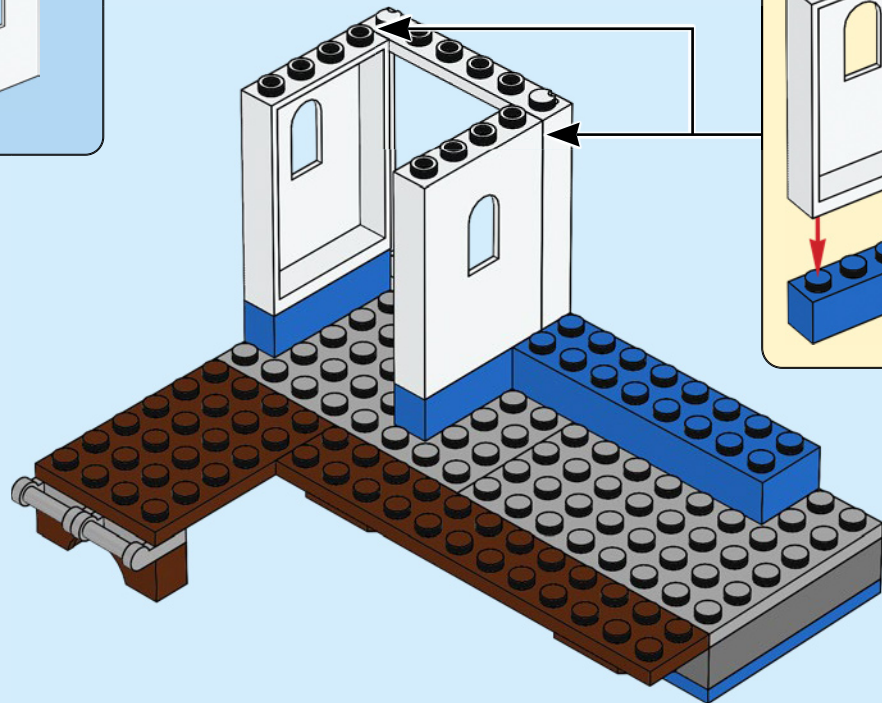

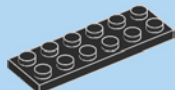

2x

13

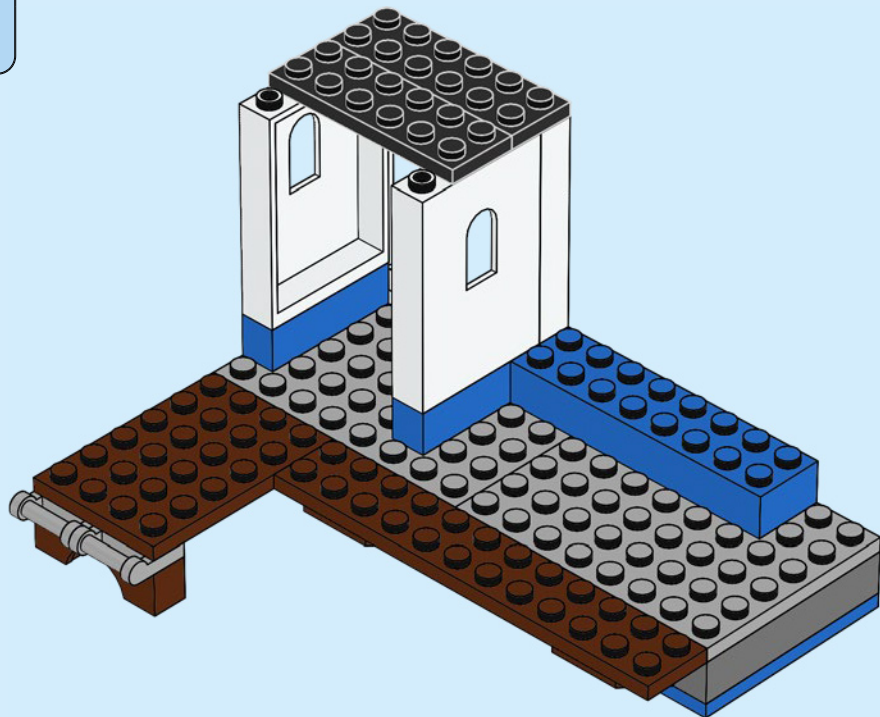

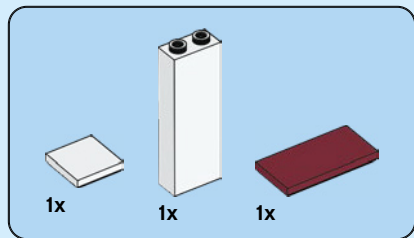

14

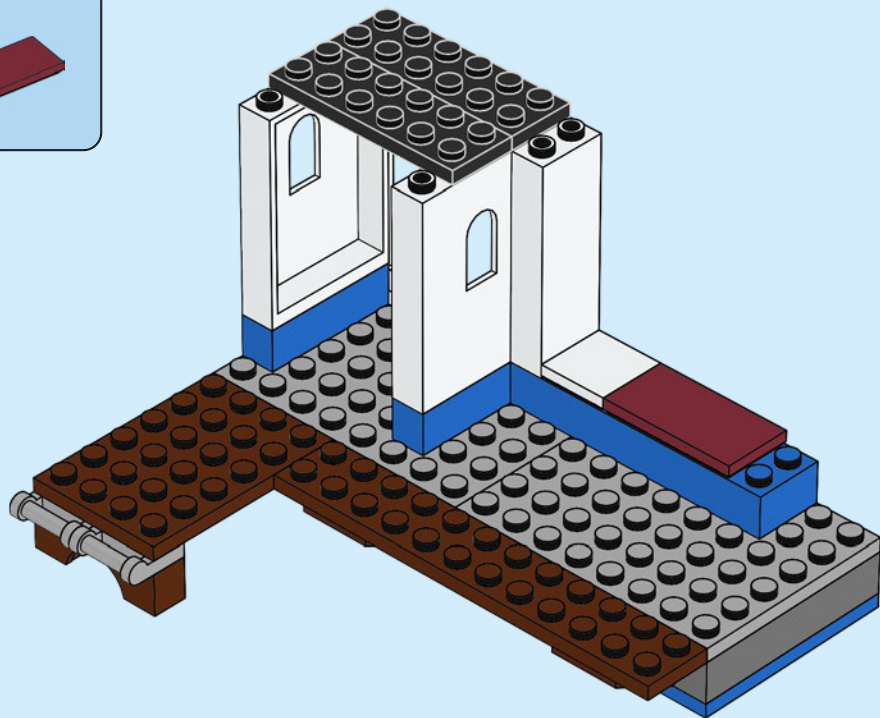



3x



4x

# 15

1

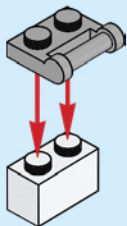

2

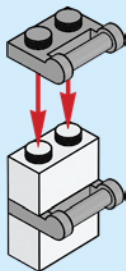

3

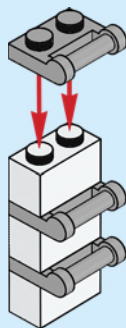

4

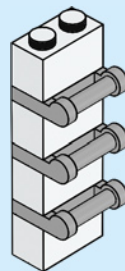

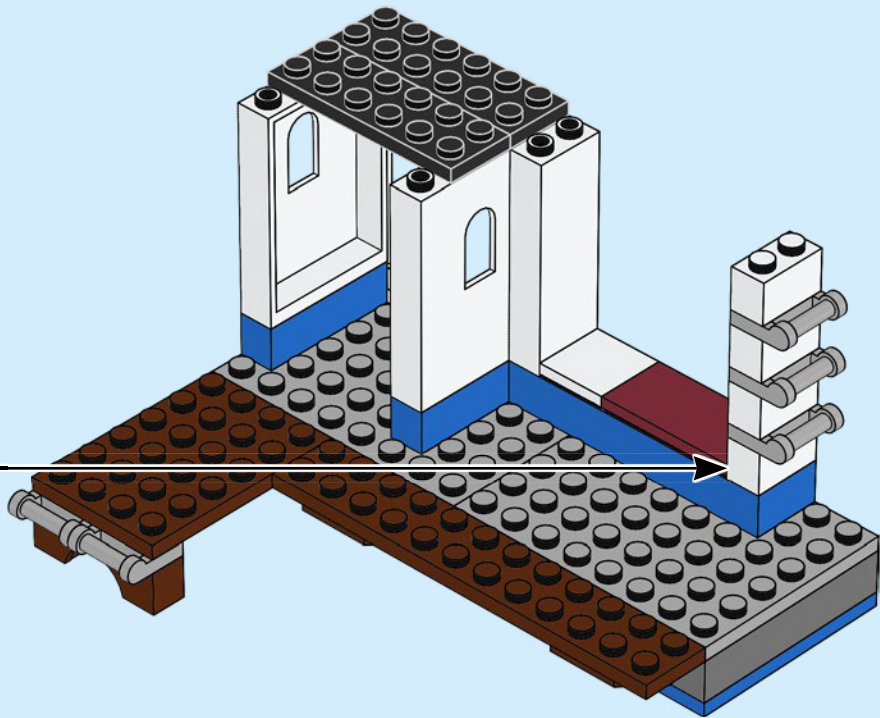





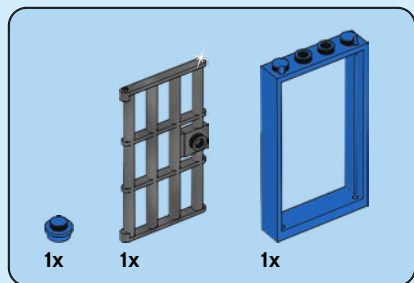

17

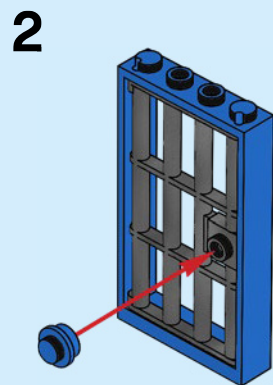
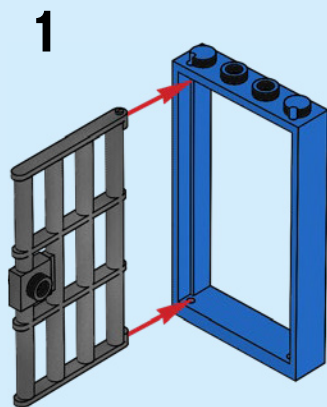

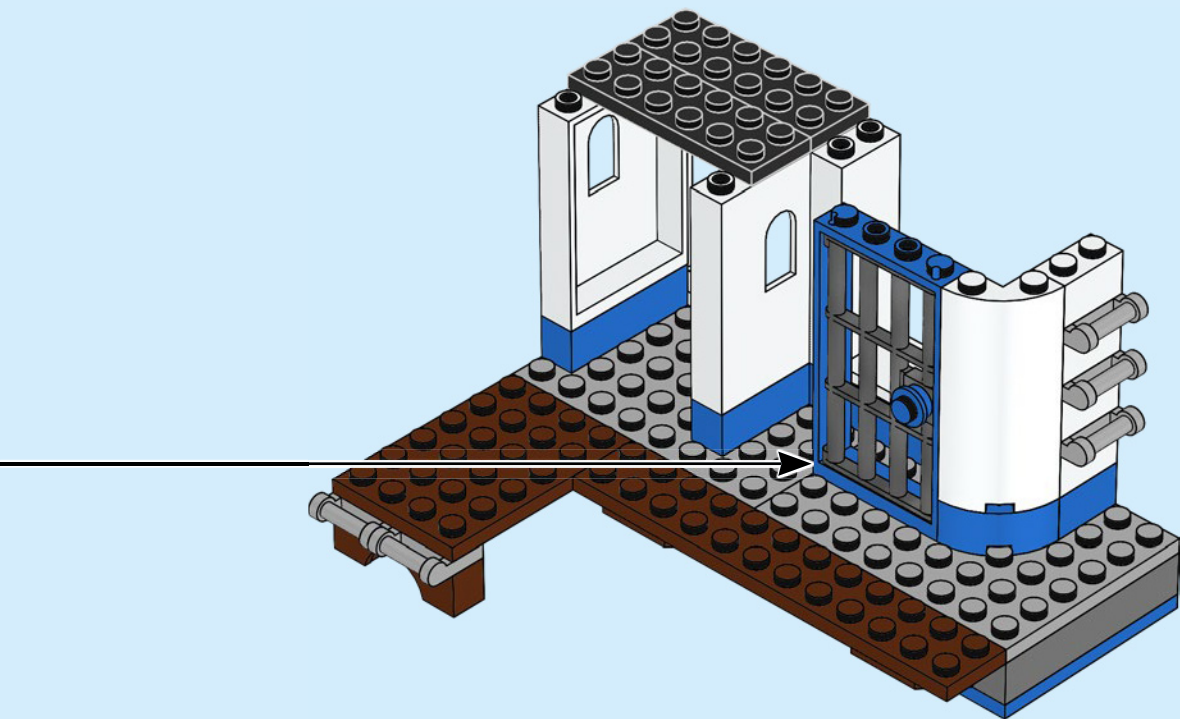

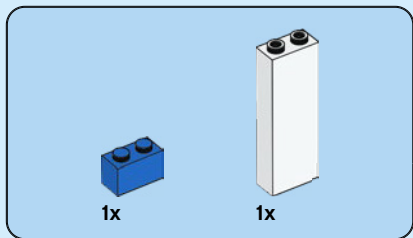

18

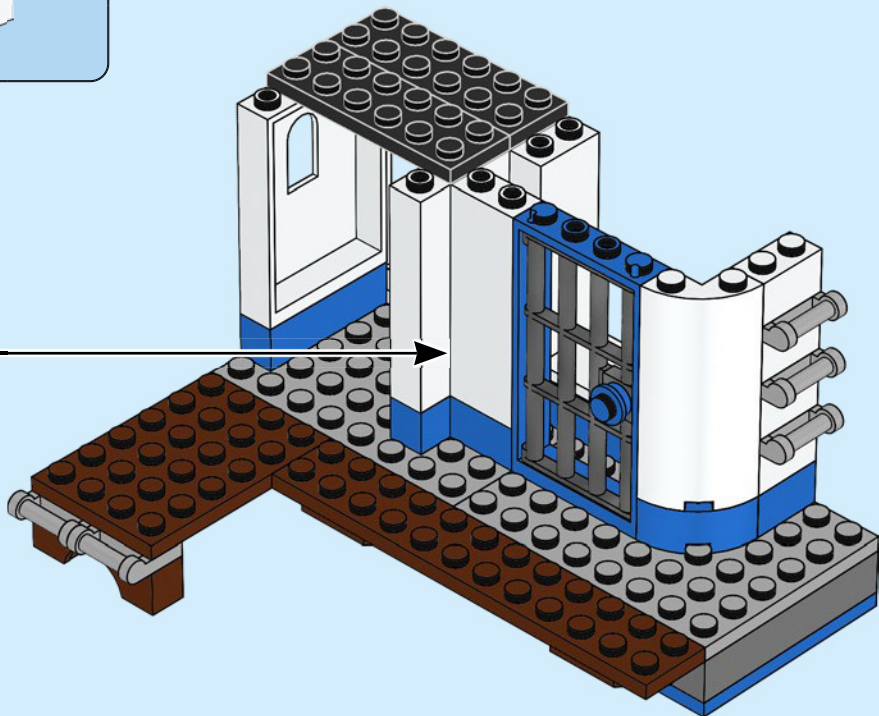
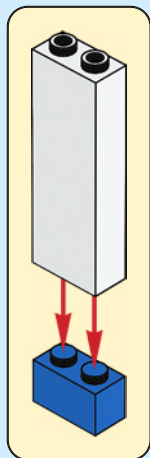

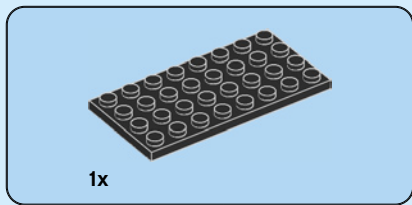

19



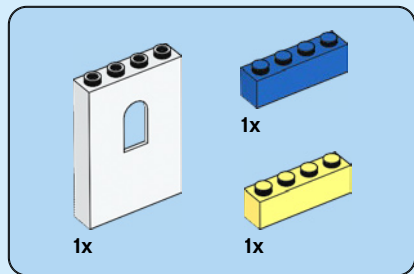

20

1

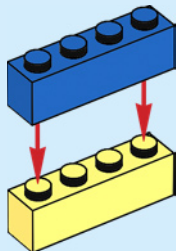

2

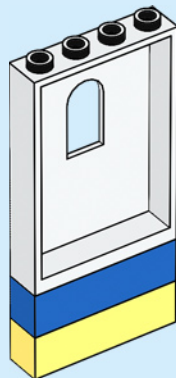

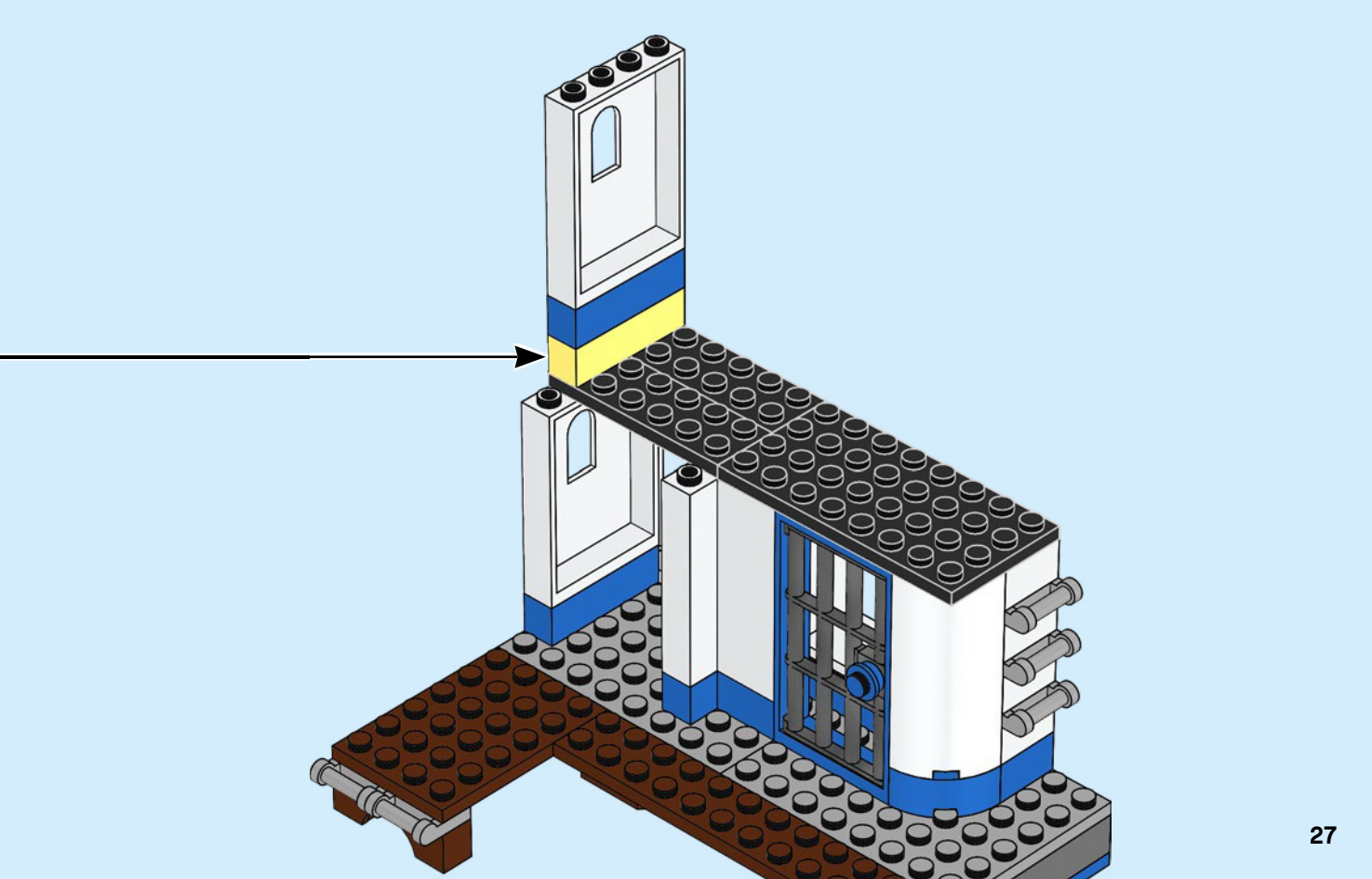







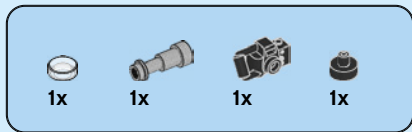

23

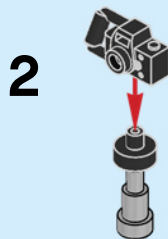
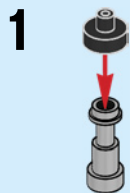

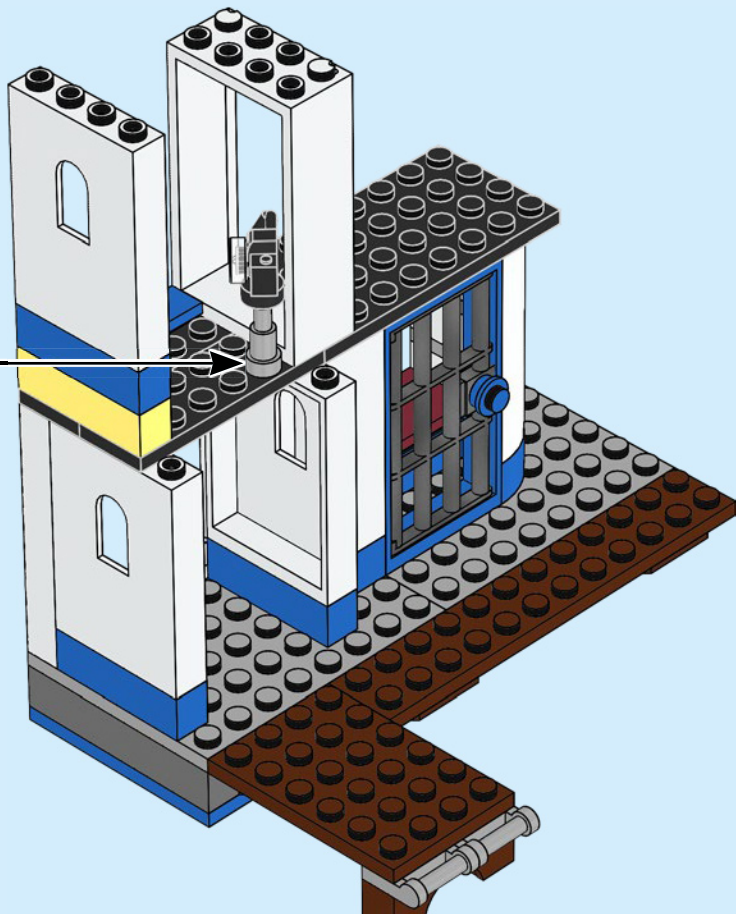

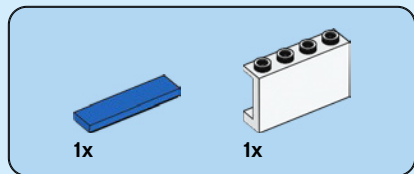

24

1

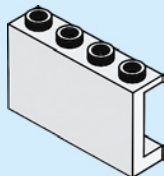

2

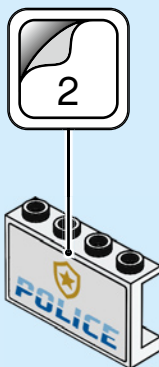

3



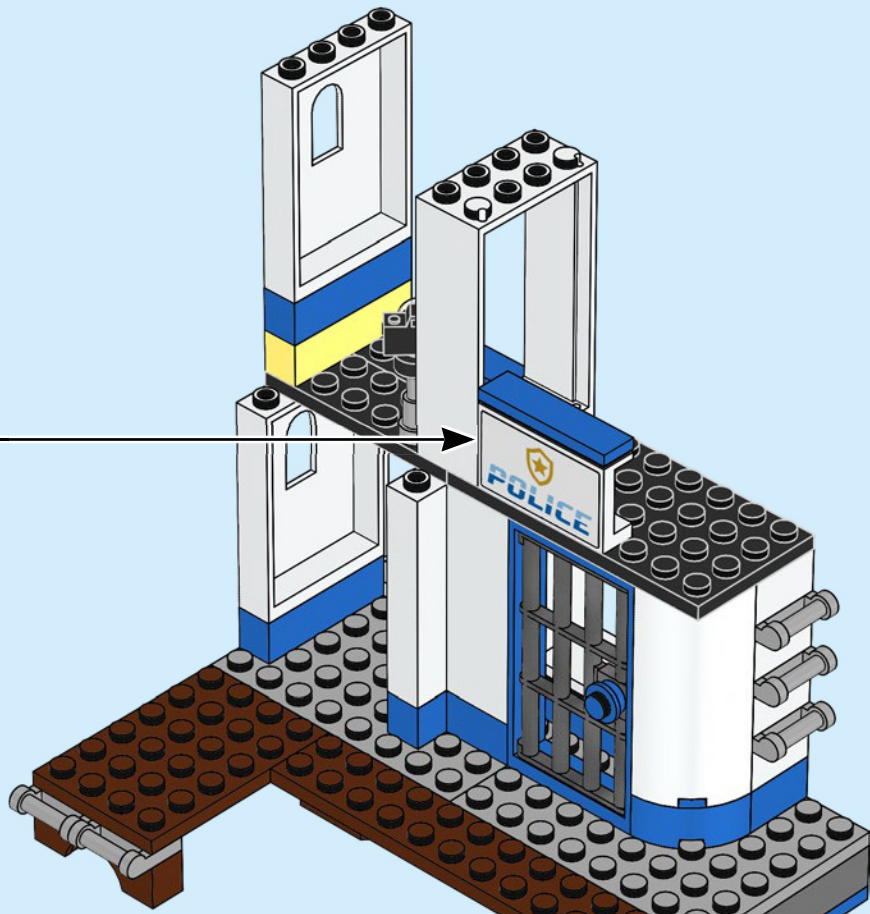
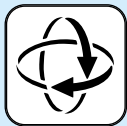



1x



1x

25

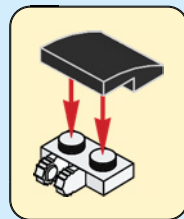

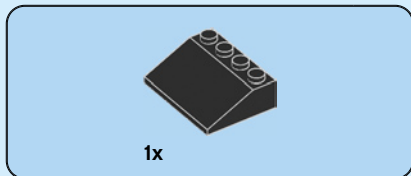

26



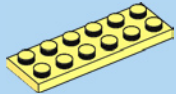

2x

27

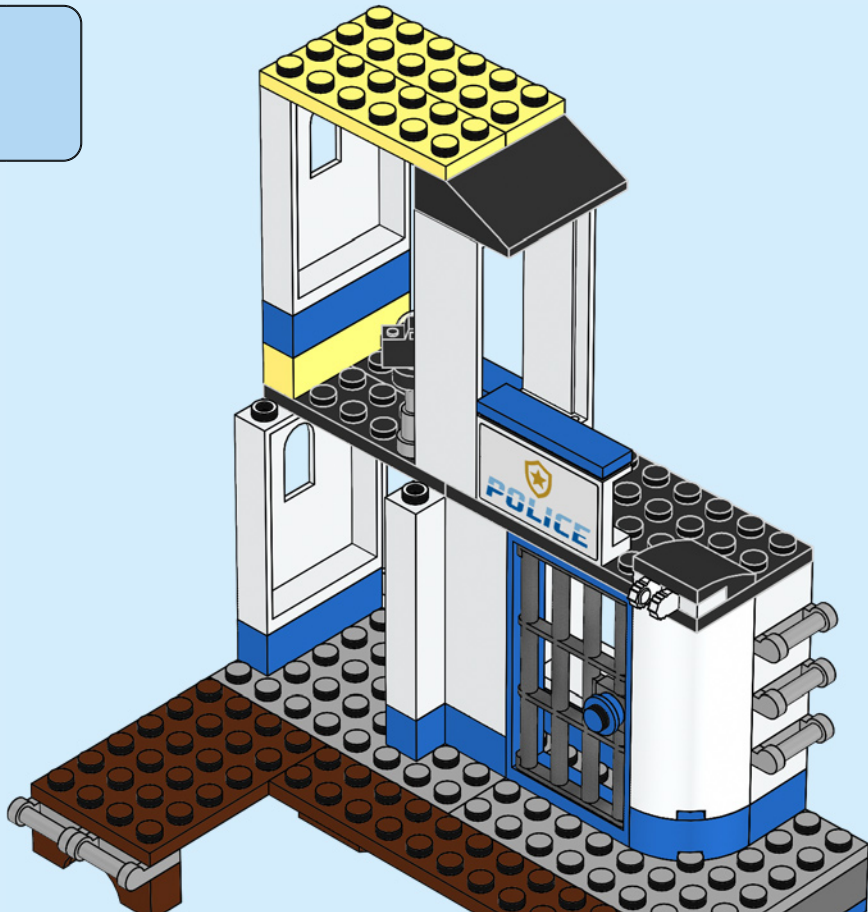



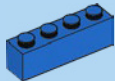

2x

28

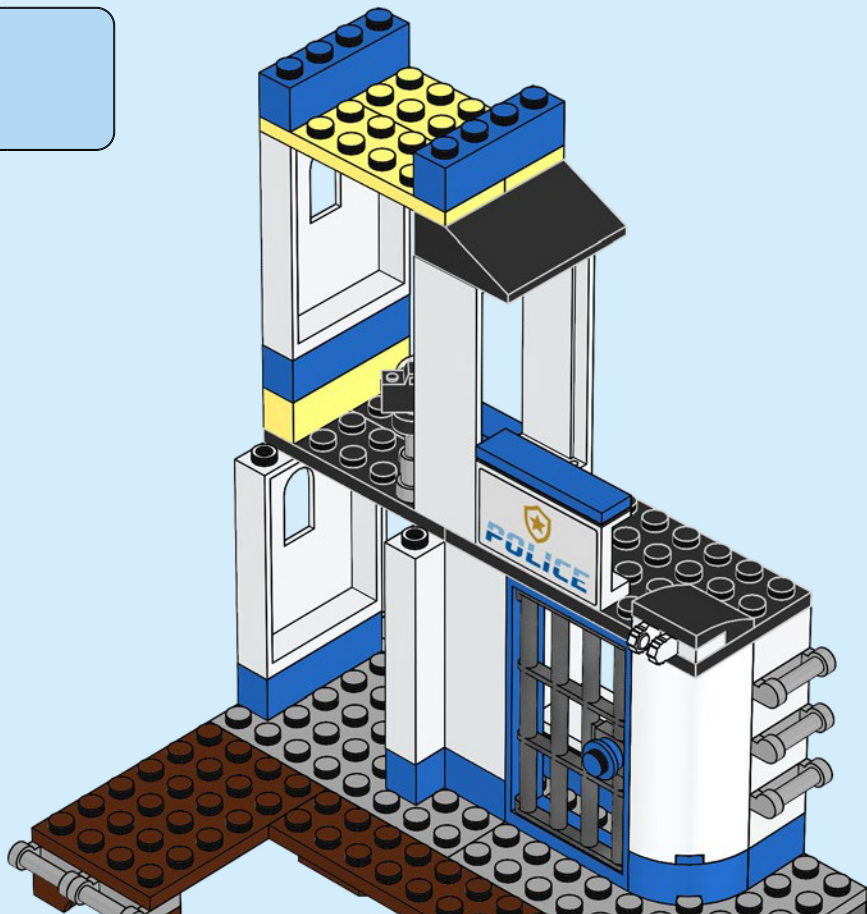



2x

29

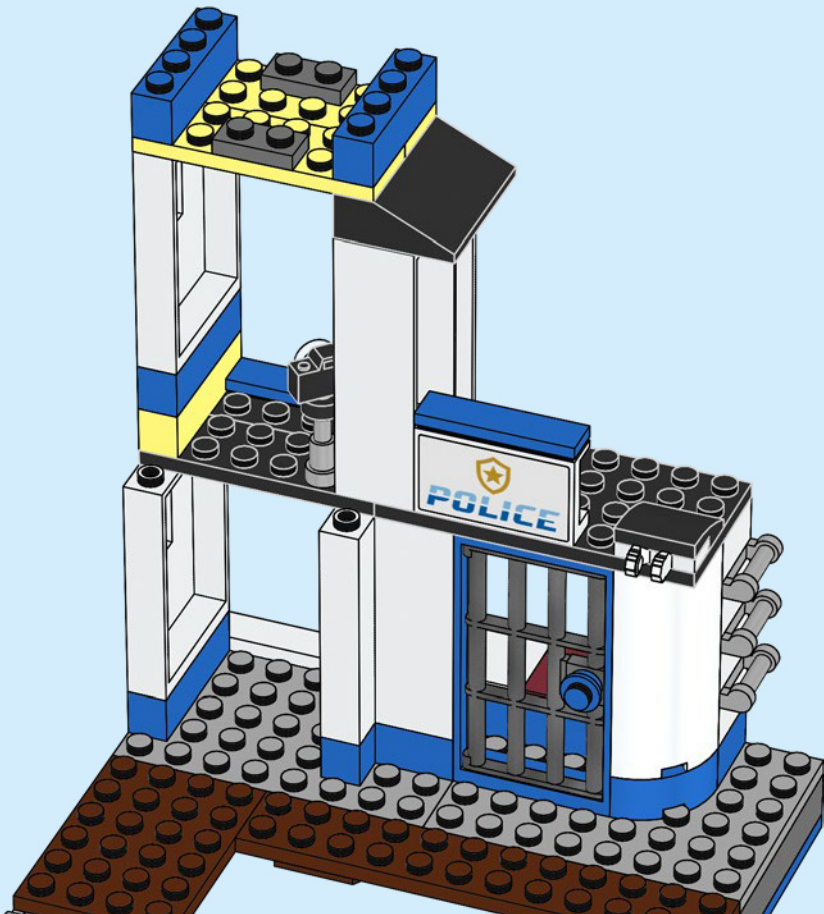

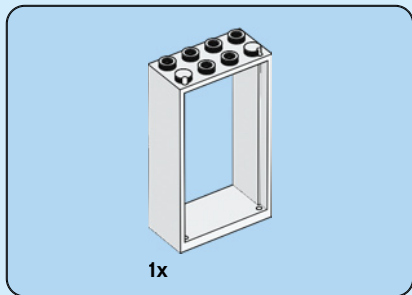

30

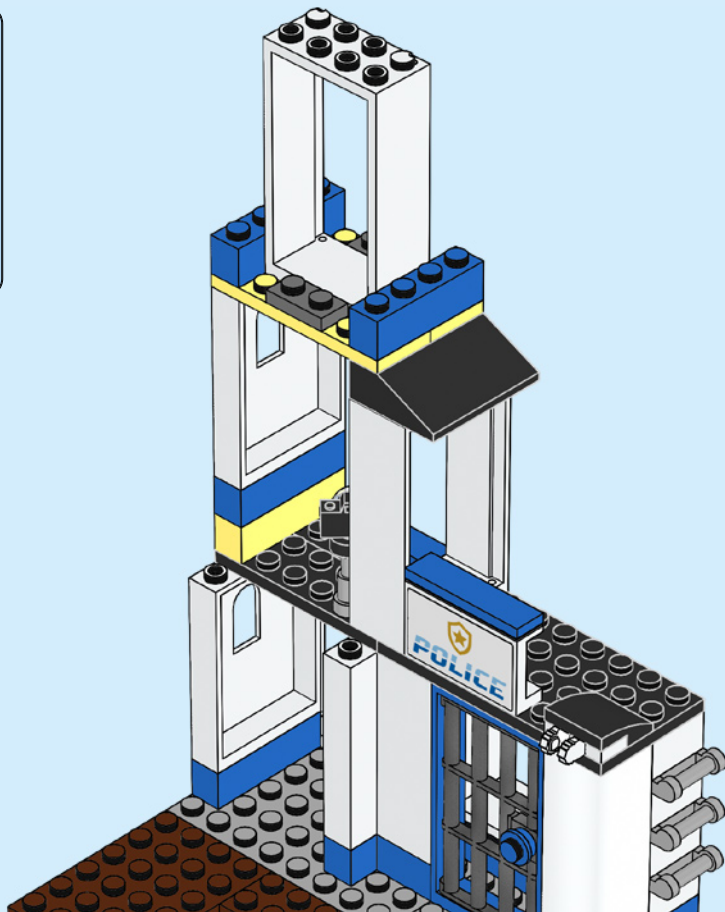

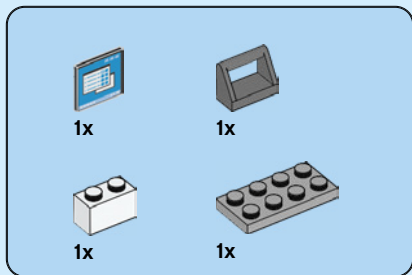

# 31

## 1

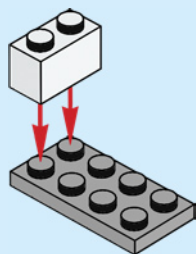

## 2

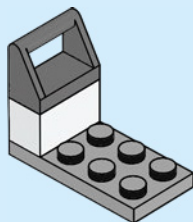

## 3



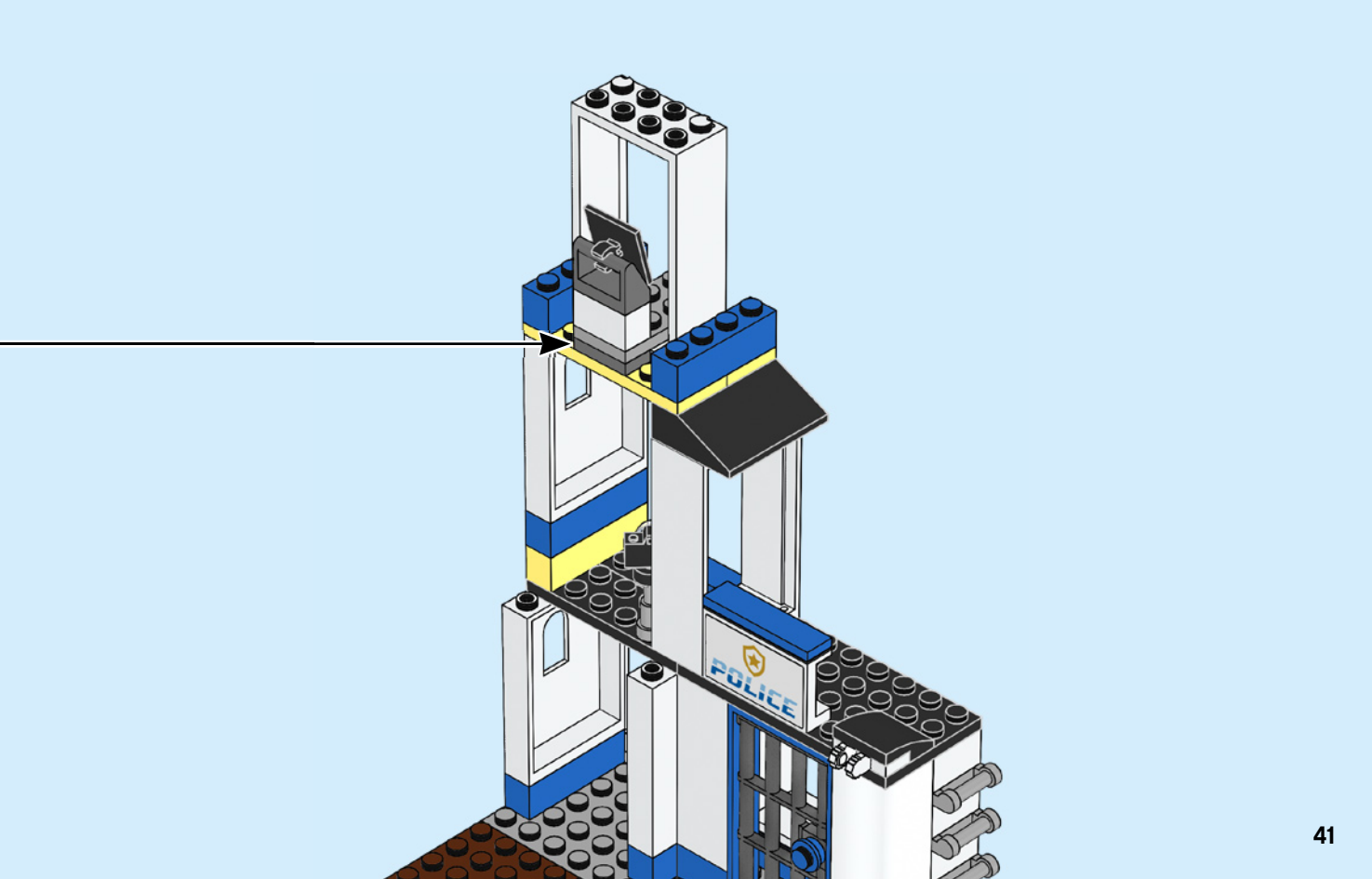

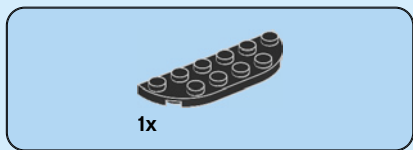
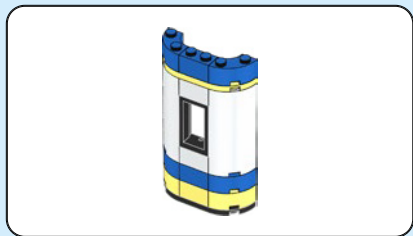

1x

**32**

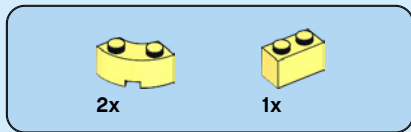

2x

1x

**33**

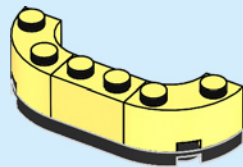

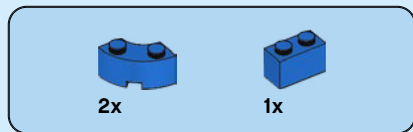

34

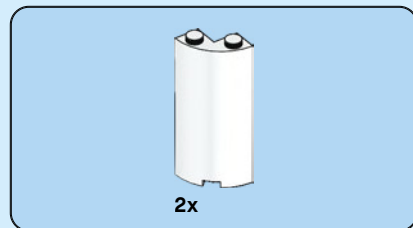
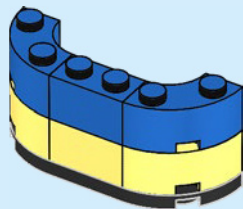

35

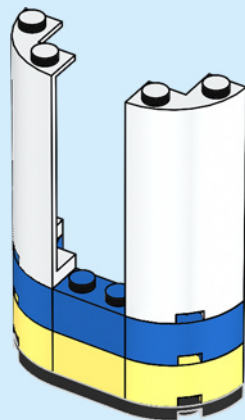

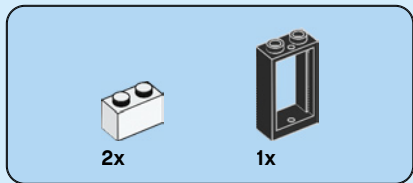

36

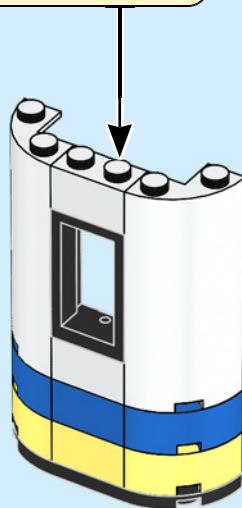
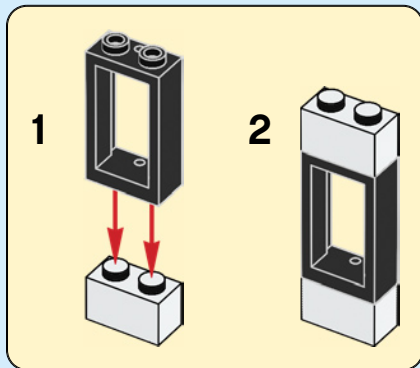



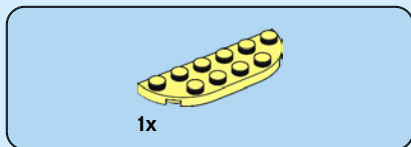

37

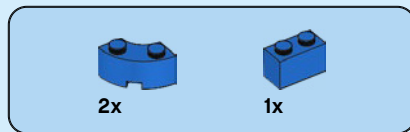
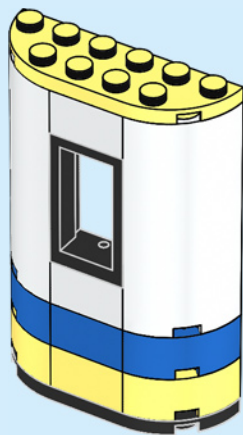

38

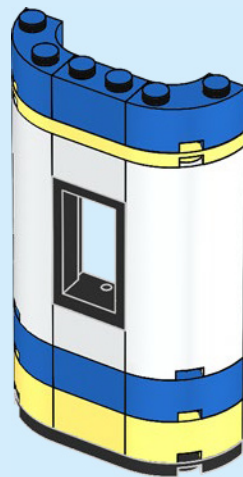

39

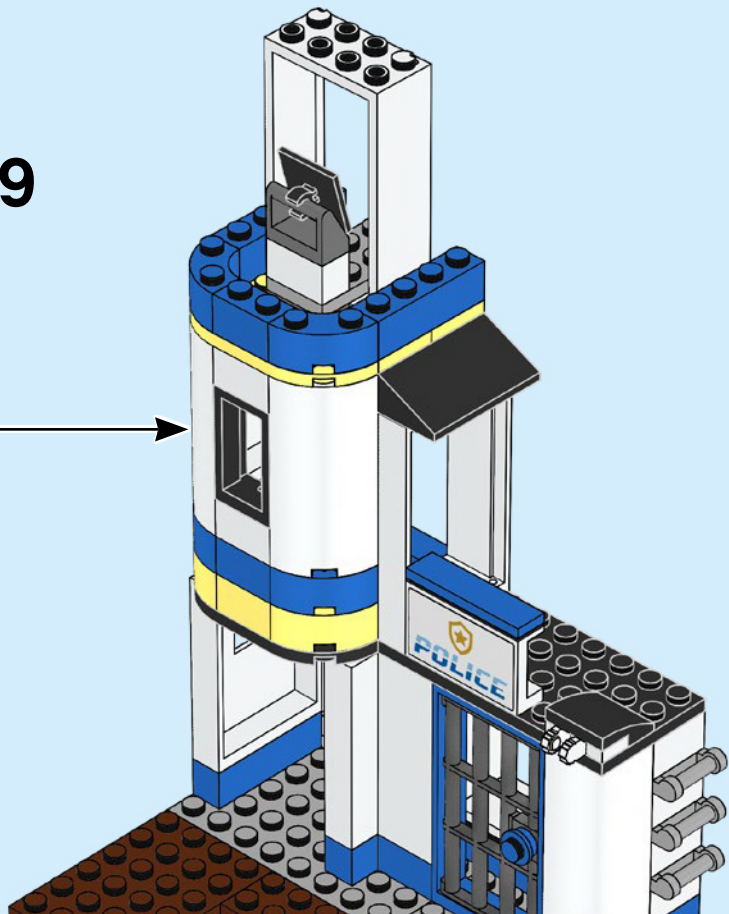

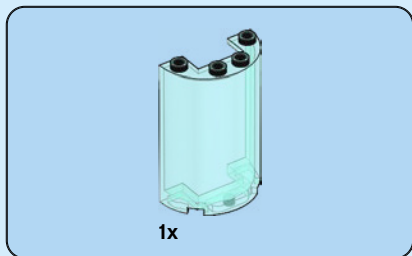

40

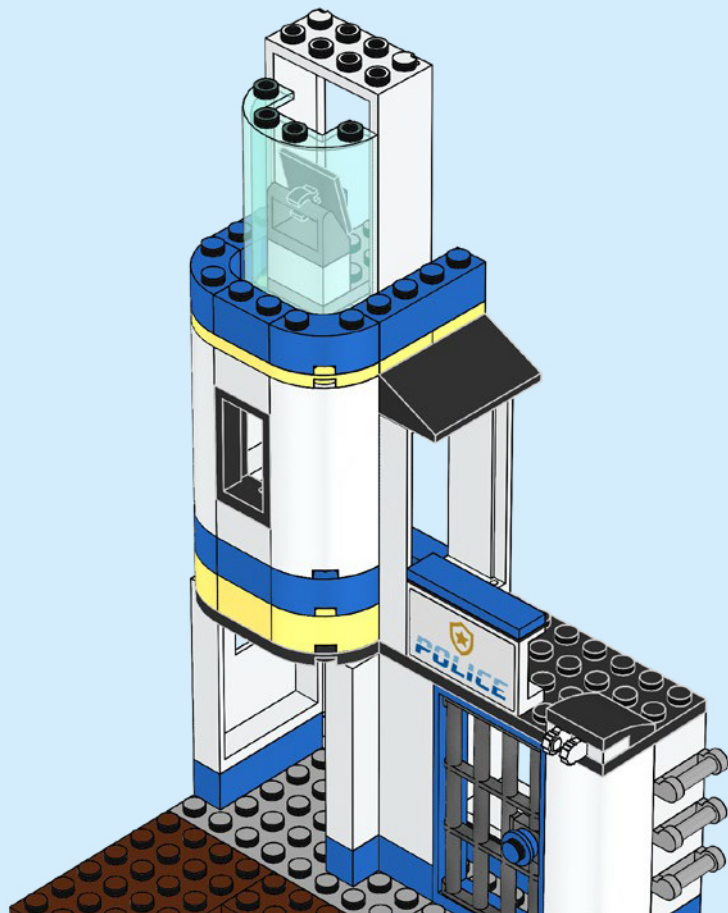



2x

41

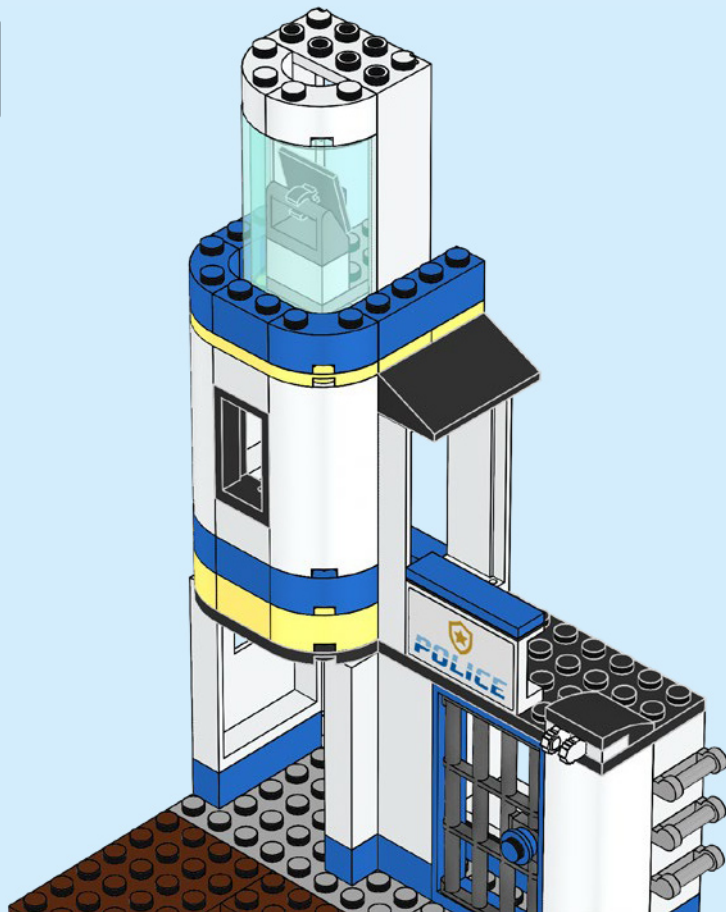

48

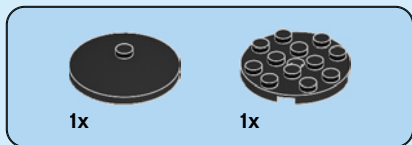

42

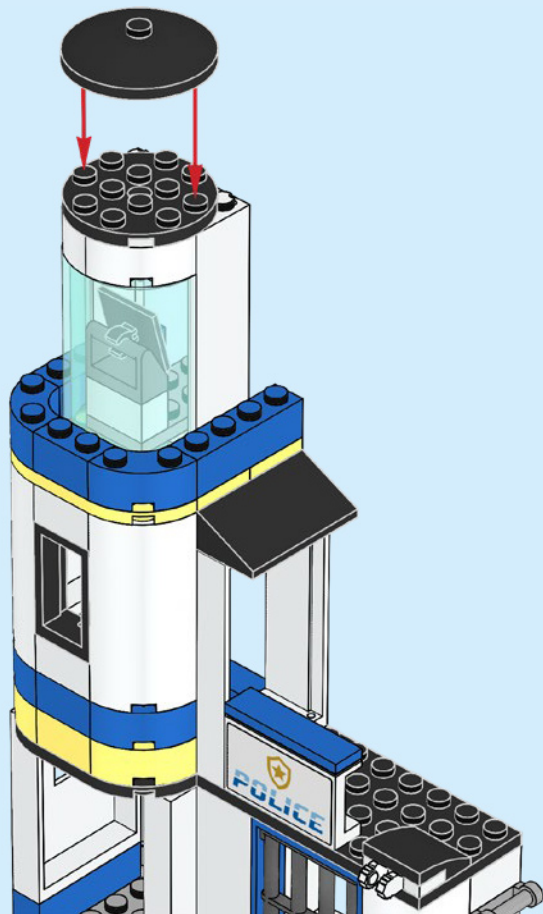



1x



1x

43

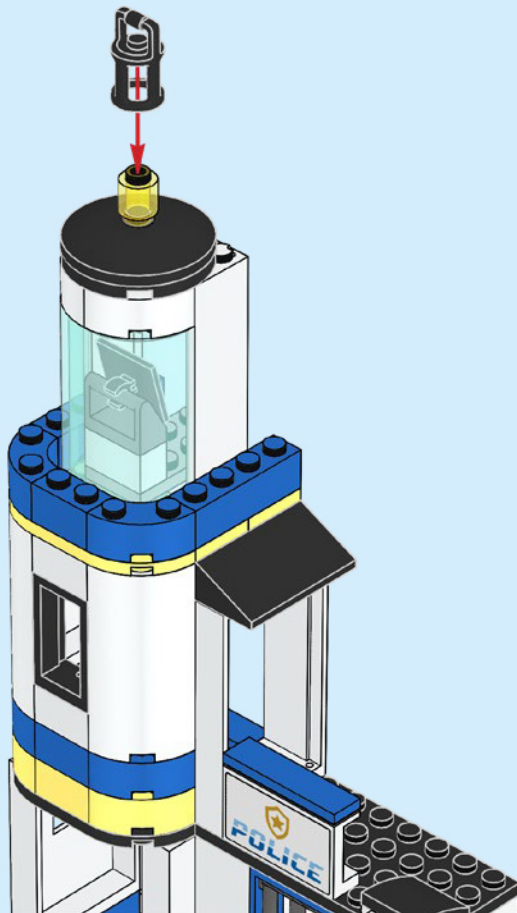

50



1x

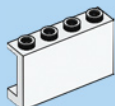

1x

# 44

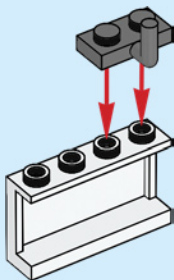

2x

# 45

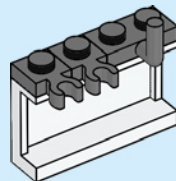



1x

46

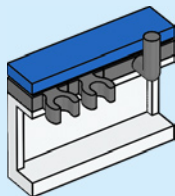

52



1x



1x



1x

47

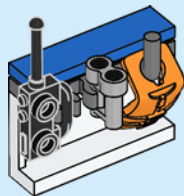



48

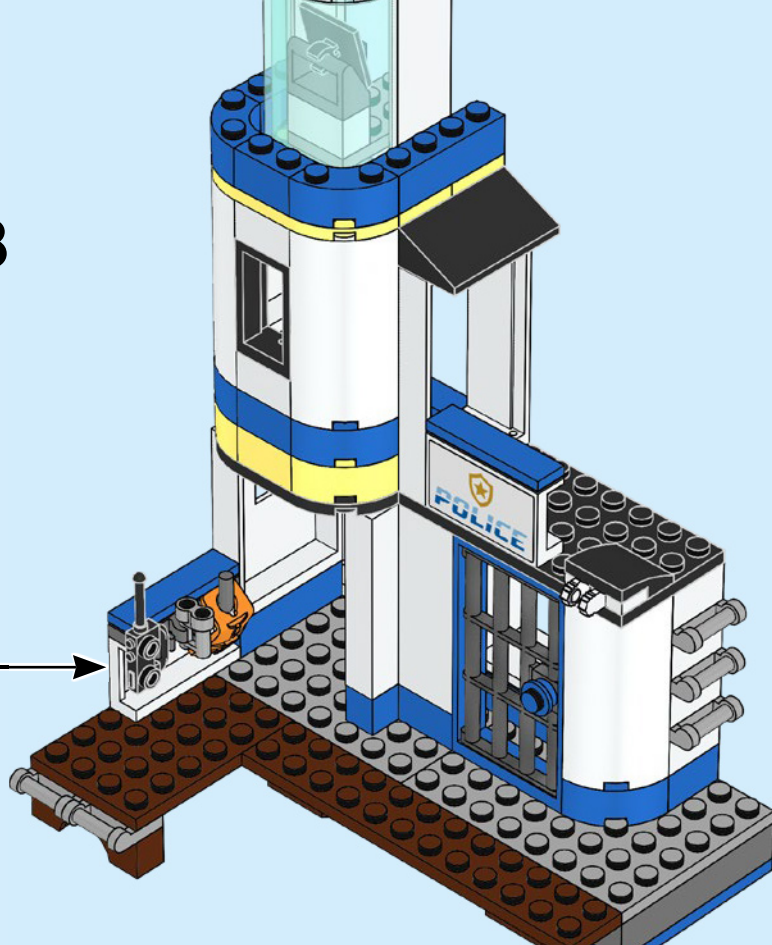

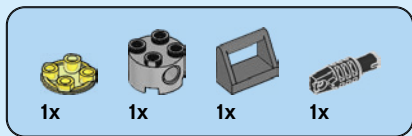

49

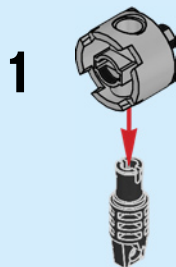

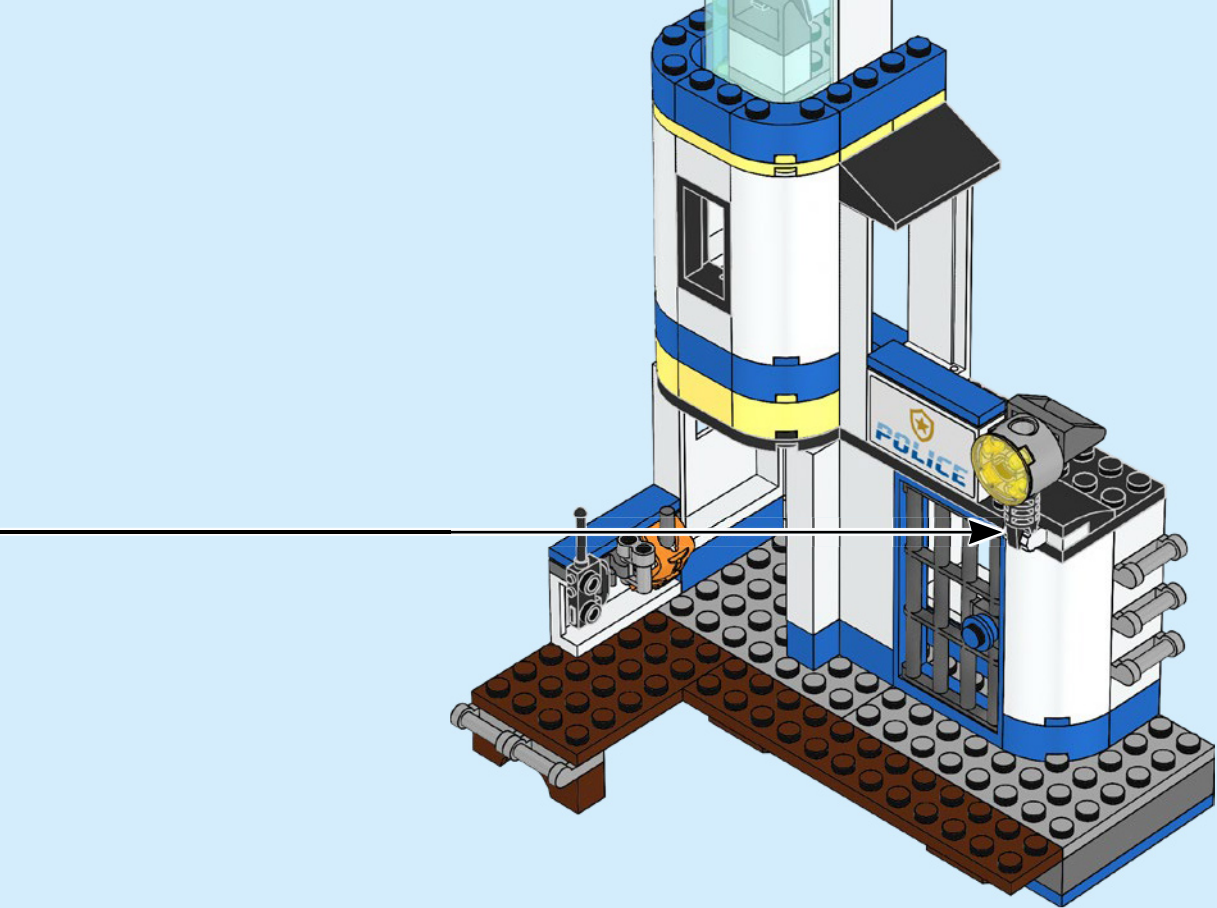

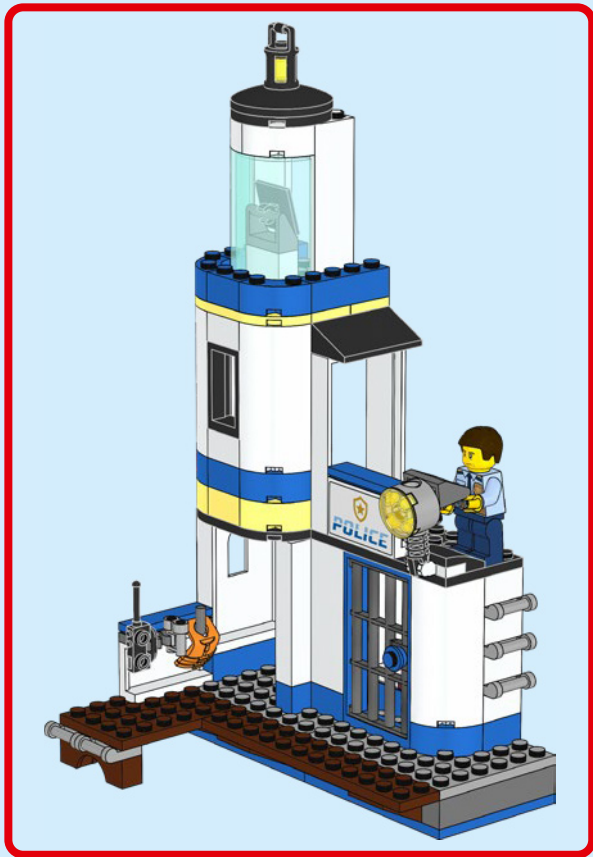





**CITY**  
ADVENTURES

AVENTURAS  
**CITY**



FROM THE HIT  
TV SERIES!

DE LA SÉRIE TÉLÉ  
À SUCCÈS !

¡DE LA POPULAR  
SERIE DE LA TELE!



# CITY ADVENTURES

# AVENTURAS CITY



VITO

60242



SAM  
GRIZZLED

60243



SNAKE  
RATTLER

60243 • 60276



ROOKY  
PARTNUR

60244



FRANKIE  
LUPELLI

60244 • 60277



TOM  
BENNETT

60245



BIG  
BETTY

60245



WHEELER

60246



DAISY  
KABOOM

60246



CLARA  
THE CRIMINAL

60276



GRACIE  
GOODHART

60277



DUKE  
DETAIN

60242 • 60246 • 60276



FREYA  
MCLOUD

60248 • 60280



CLEMMONS

60247 • 60281



BOB

60282



FELDMAN

60282



TREAD  
OCTANE

60258



HARL  
HUBBS

60258 • 60266



SHIRLEY  
KEEPER

60292



MADISON

60292





# CITY

