







CITY

60376





 **FR**  
**DONNEZ**  
OU  
**RECYCLEZ**

 OU  OU   
ASSOCIATION MAGASIN DÉCHÈTERIE

Adresses sur [quefairedemesdechets.fr](http://quefairedemesdechets.fr)



[LEGO.com/sustainable-packaging](https://LEGO.com/sustainable-packaging)



# BUILDER



Apple and the Apple logo are trademarks of Apple Inc., registered in the U.S. and other countries and regions. App Store is a service mark of Apple Inc. Google Play and the Google Play logo are trademarks of Google LLC. Tencent and the Tencent logo are trademarks of Tencent Inc.

🔍 [LEGO.com/devicecheck](https://LEGO.com/devicecheck)

**EN** Ask parents' permission before going online | **DE** Eltern um Erlaubnis bitten, bevor du online gehst | **FR** Demande l'autorisation d'un parent avant d'aller en ligne | **IT** Chiedi il permesso ai tuoi genitori prima di andare online | **ES** Pídeles permiso a tus papás antes de conectarte a Internet | **PT** Peça autorização aos pais antes de acederes online | **ZH** 上网前应先征得父母的同意 | **PL** Poproś rodziców o zgodę, zanim wejdiesz do Internetu | **CS** Než půjdeš na internet, požádej rodiče o svolení | **SK** Skôr než pôjdeš na internet, vypýtaj si povolenie od rodičov | **HU** Kérj szülői engedélyt, mielőtt online csatlakoznál! | **RO** Cere permisiunea părinților înainte de a te conecta online | **BG** Поискайте разрешение от родител, преди да влезете онлайн | **LV** Pirms došanās tiešsaistē palūdz atļauju vecākiem | **ET** Enne Interneti kasutamist küsi vanematelt luba | **LT** Prieš prisijungdami prie interneto, atsiklauskite tėvų







1

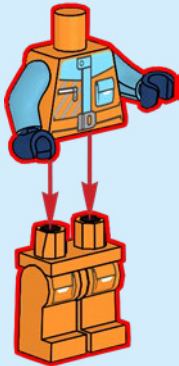

2

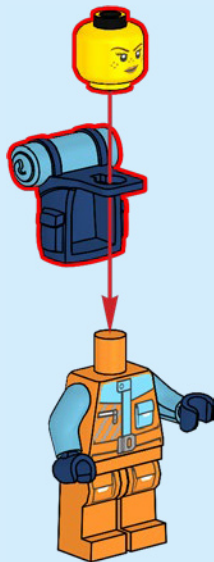

3

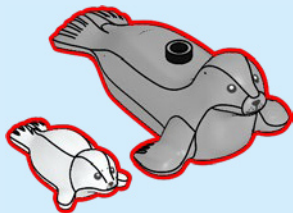
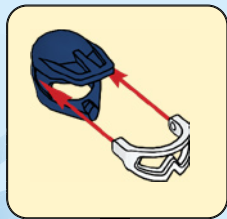

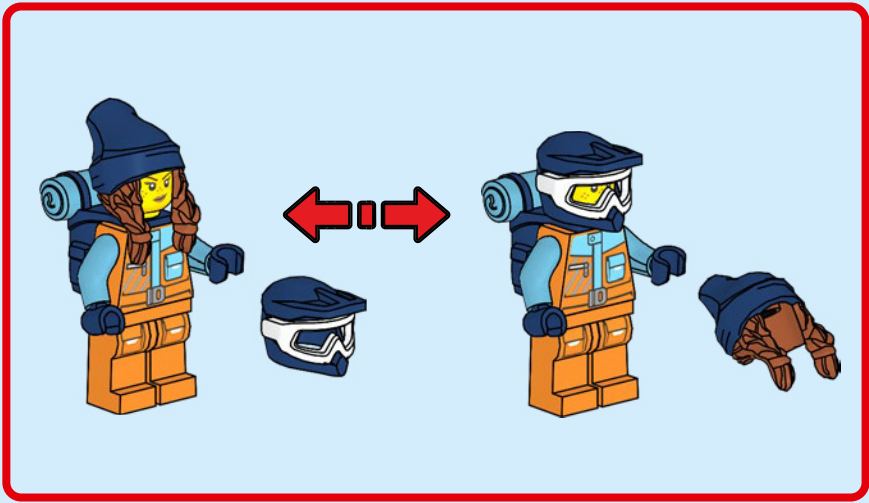



1



8



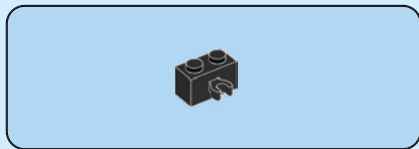

2

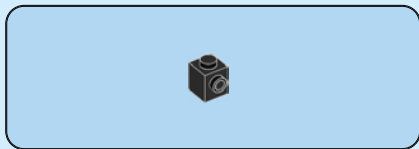
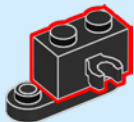

3

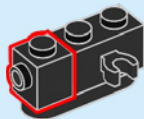

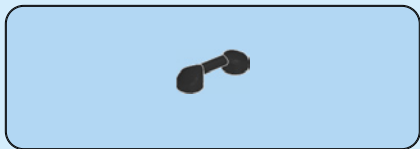

4



10





5

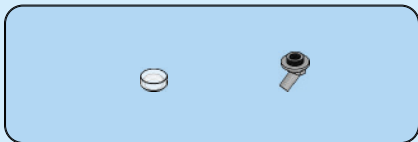
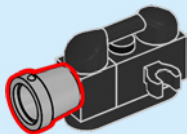

6

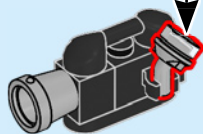
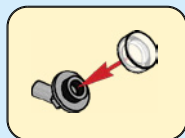

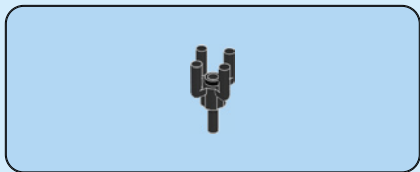

7

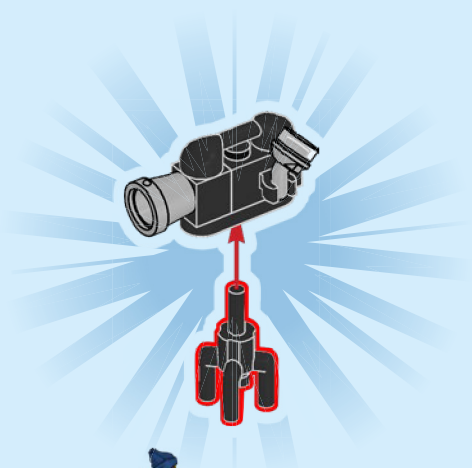



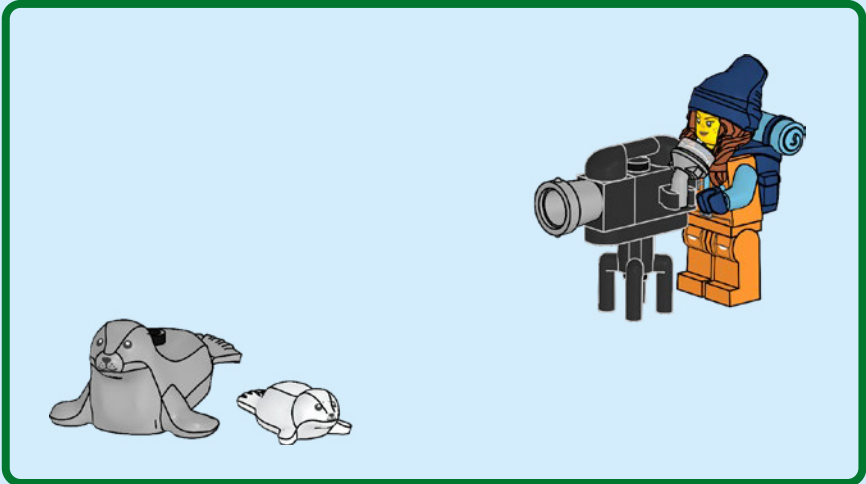

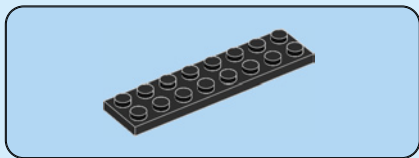
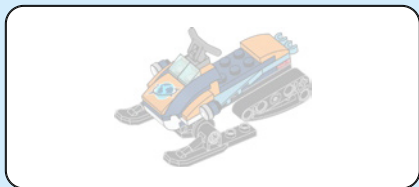

1

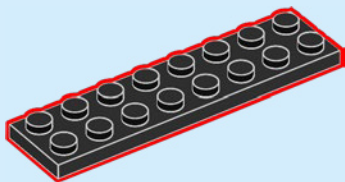

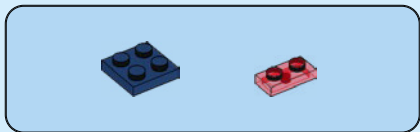

2

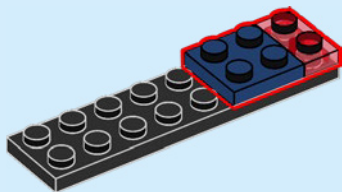

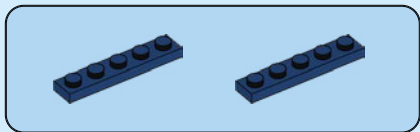

3

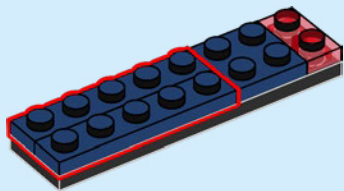

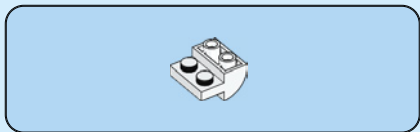

4

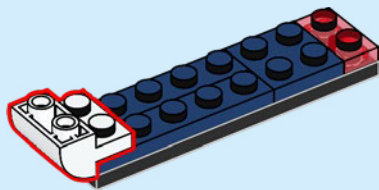

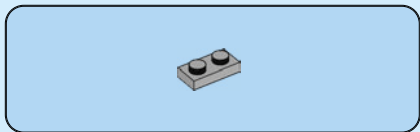

5

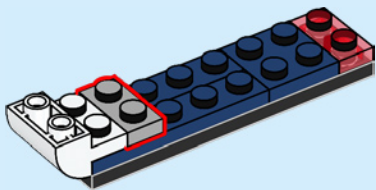



6

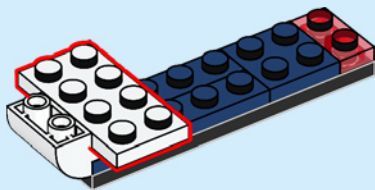



7

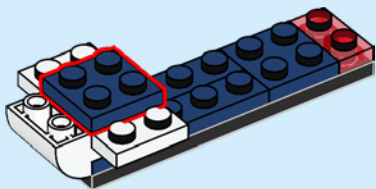



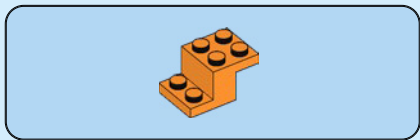

8

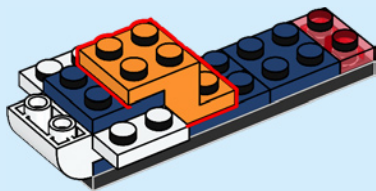

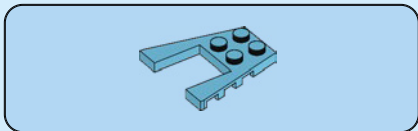

9

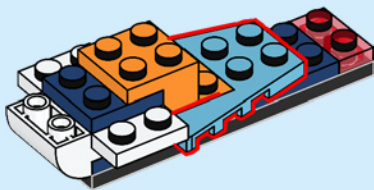

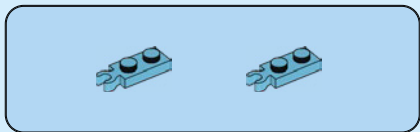

10

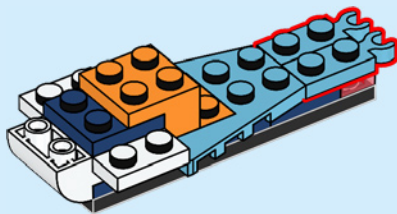



11

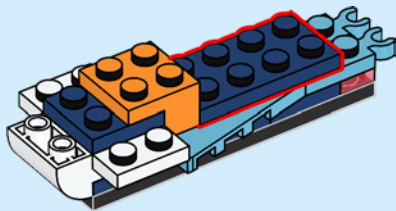

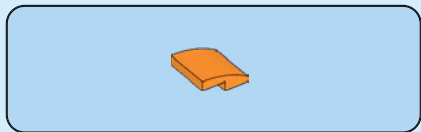

12

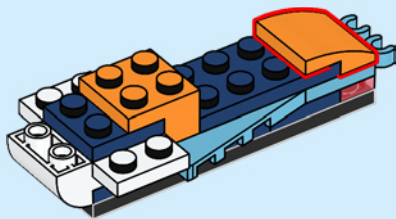

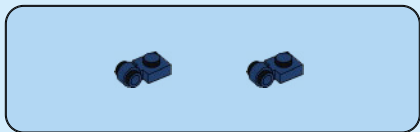

13

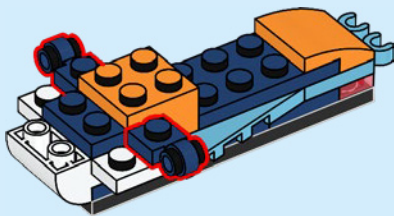

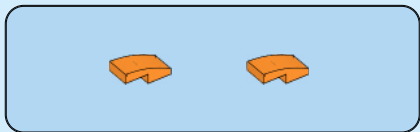

14

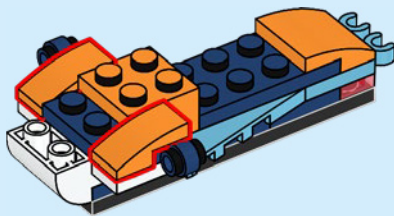

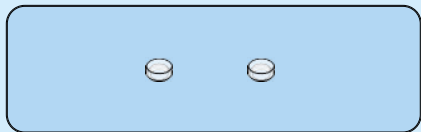

15

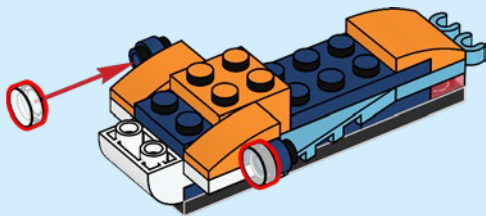



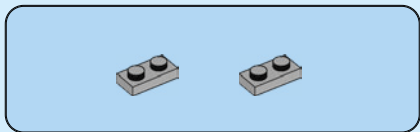

16

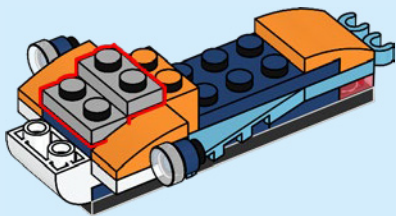

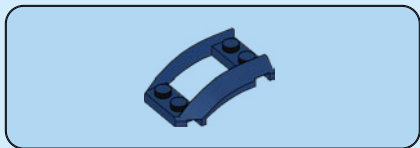

17

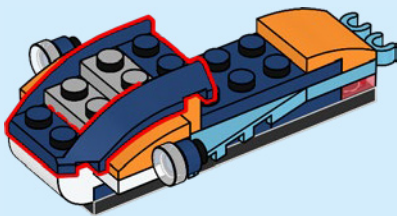



18

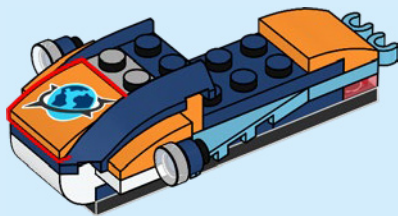

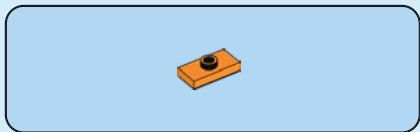

19

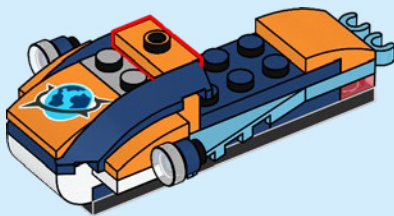

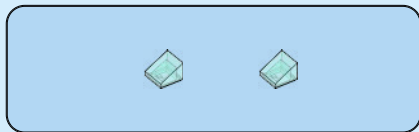

20

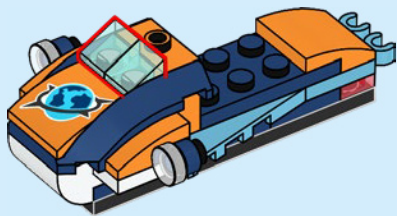

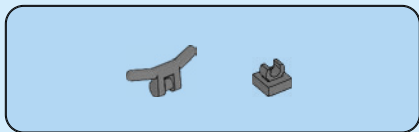

21

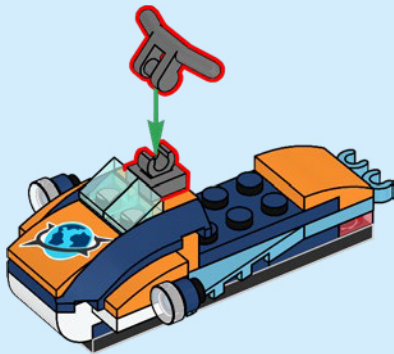

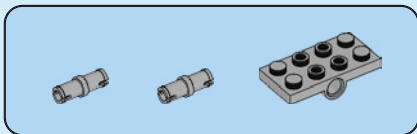

22

1



2

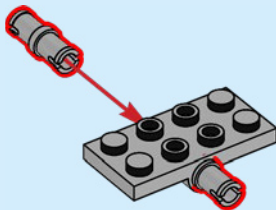

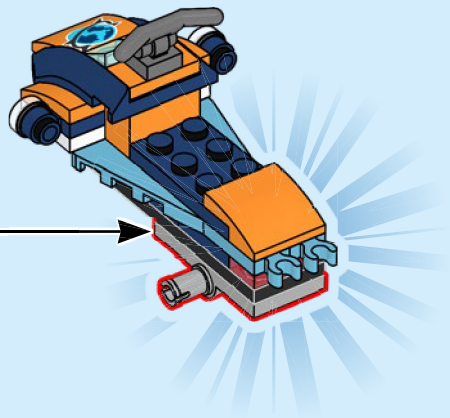



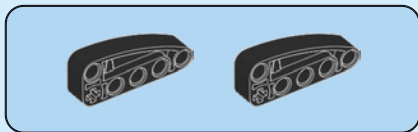

23

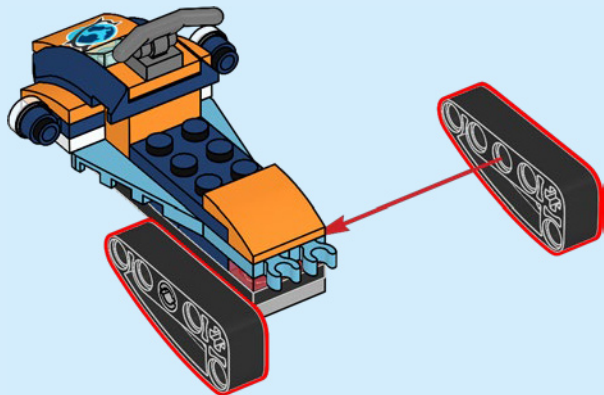



24

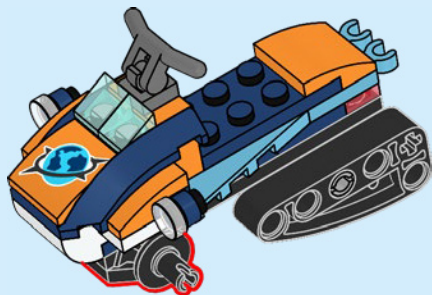

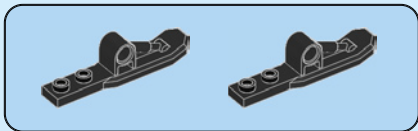

25

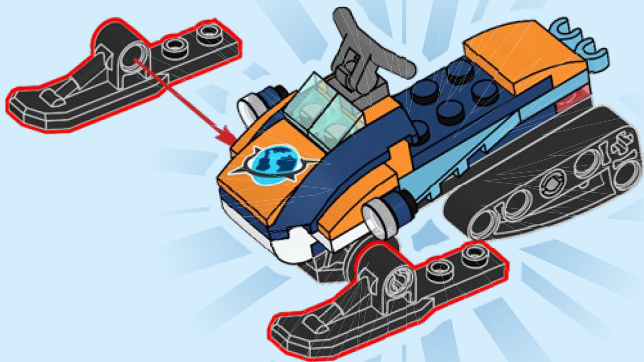



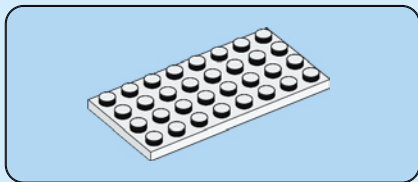
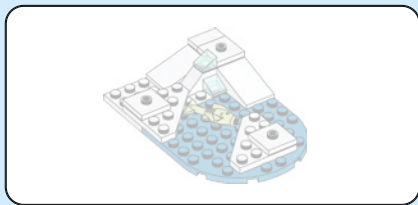

1

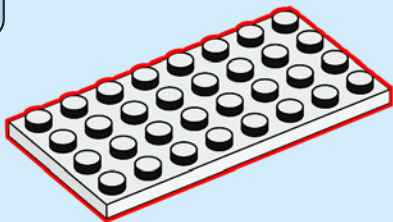

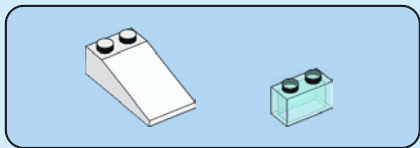

2

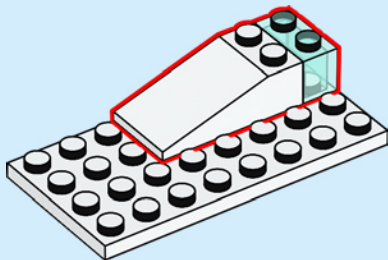

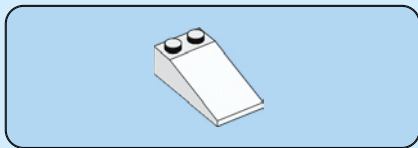

3

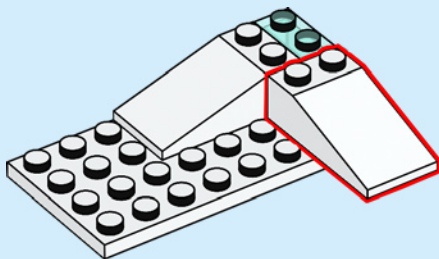

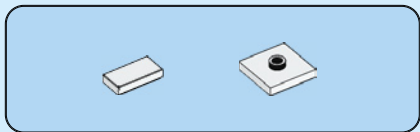

4

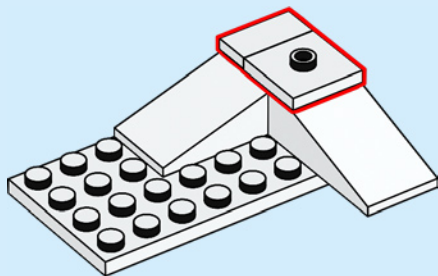





5

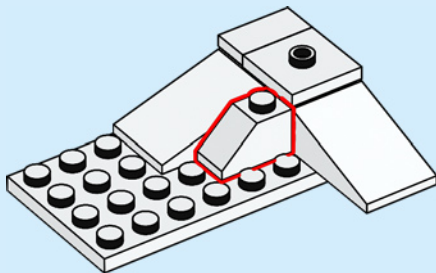



6

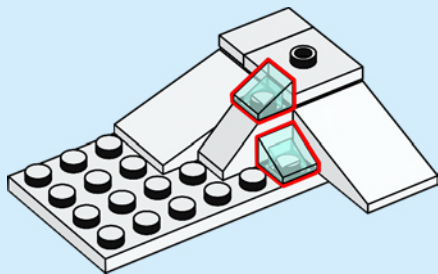

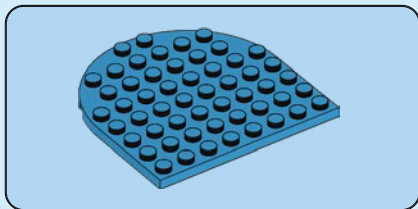

7

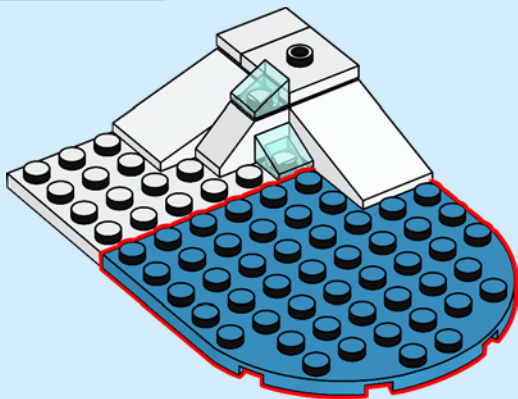

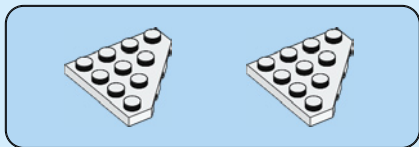

8

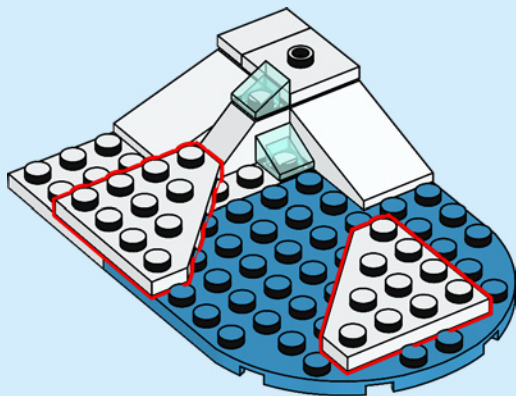

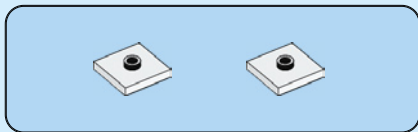

9

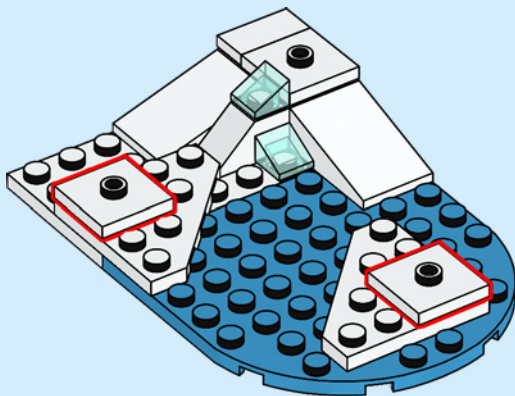



10

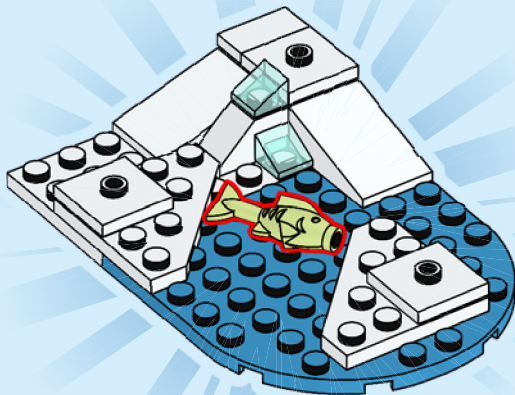

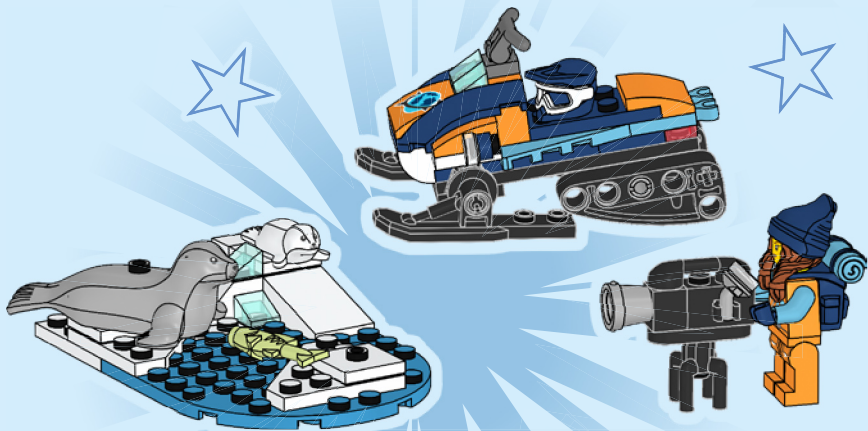



# CITY

60380



60362



60366



60364







# CITY

60368





1x  
4121932



2x  
4143000



1x  
6400127



1x  
306901



3x  
6126046



1x  
302001



1x  
6170703



1x  
6434764



2x  
4160215

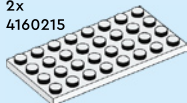

1x  
303501



1x  
4532220



1x  
4558954



1x  
6330197



1x  
6428168



1x  
6151289



2x  
6441237



1x  
6354604



2x  
6407066



1x  
303426



1x  
6395400



2x  
6055069



1x  
6434762



1x  
6067913



1x  
6092599



1x  
6434761



1x  
6440858



2x  
6037890



1x  
4667595



2x  
6384913



1x  
6442128



1x  
6251249



1x  
6443405



2x  
6328107



1x  
6207255



1x  
6223923



1x  
6291414



3x  
4211398



1x  
6176242

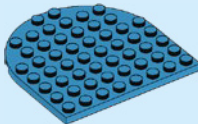

1x  
6304883



1x  
6240212



1x  
6057487



1x  
6326748



2x  
4211807



1x  
6434763



1x  
6244910



4x  
6245277



1x  
6344022



1x  
4261908



3x  
6274738



2x  
6441239

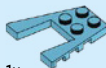

1x  
6345627



[LEGO.com/service](https://www.lego.com/service)

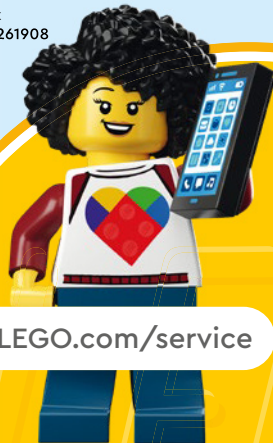

YOU COULD

WIN



Scan this QR code or go to  
**LEGO.COM/PRODUCTFEEDBACK** and give us  
your short feedback about this LEGO® set  
for a chance to win a cool LEGO prize.

Terms and Conditions apply\*

**EN: YOU COULD WIN.** Terms and Conditions apply\* **DE: Du könntest GEWINNEN.** Es gelten die Teilnahmebedingungen\* **FR: Tu pourrais GAGNER.** Des conditions s'appliquent\* **IT: Potresti VINCERE tu.** Termini e condizioni sono applicabili\* **ES: Puedes GANAR.** Aplican términos y condiciones\* **PT: Poderá GANHAR.** Aplicam-se termos e condições\* **ZH: 轻松获奖.** 条款和条件适用\* **PL: Szansa na WYGRANĄ.** Obowiązują warunki korzystania\* **CS: Máte šanci VYHRÁT.** Platí všeobecné smluvní podmínky\* **SK: Máte šancu VYHRÁT.** Platia všeobecné zmluvné podmienky\* **HU: TE IS NYERHETSZ.** Felhasználási feltételek érvényesek\* **RO: Ai putea CÂȘTIGA.** Se aplică termenii și condiții\* **BG: Можете да СПЕЧЕЛИТЕ.** Има определени правила и условия\* **LV: Tu vari LAIMĒT.** Ir spēkā noteikumi un nosacījumi.\* **ET: Sul on võimalus VÕITA.** Kehtivad tingimused\* **LT: Jūs galite LAIMĖTI.** Taikomos sąlygos\*

\*[LEGO.com/productfeedback-terms](https://www.lego.com/productfeedback-terms)

LEGO and the LEGO logo are trademarks of the LEGO Group. ©2023 The LEGO Group.

6500729