

The LEGO logo is displayed in its characteristic white font with a black outline, set against a red square background.

BIONICLE®

70784



WARNING: CHOKING HAZARD.
Toy contains small parts and a small ball.
Not for children under 3 years.



LEGO.com/bionicle



⚠️ AVERTISSEMENT : RISQUE D'ÉTOUFFEMENT.
Le jouet contient des petites pièces ainsi qu'une petite boule.
Il ne convient pas aux enfants de moins de 3 ans.

⚠️ ADVERTENCIA: PELIGRO DE ASFIXIA.
Juguete que contiene partes pequeñas y una pelota pequeña.
No recomendado para niños menores de 3 años.



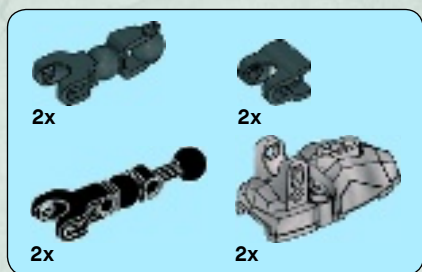

1



2



2x

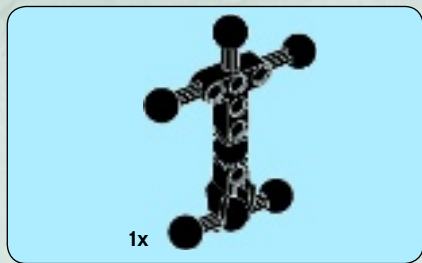

2

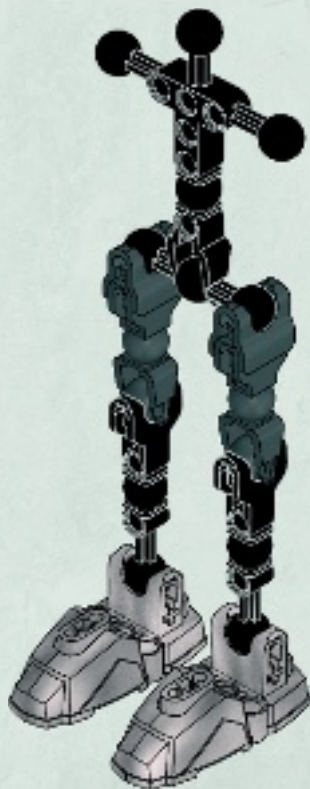

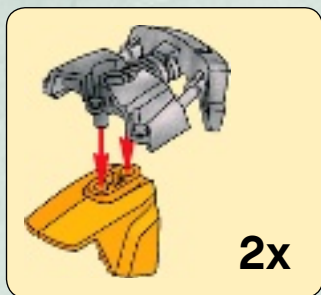
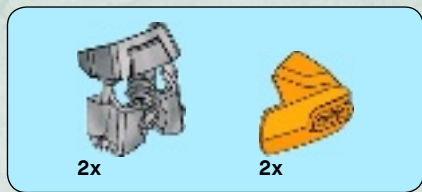

3

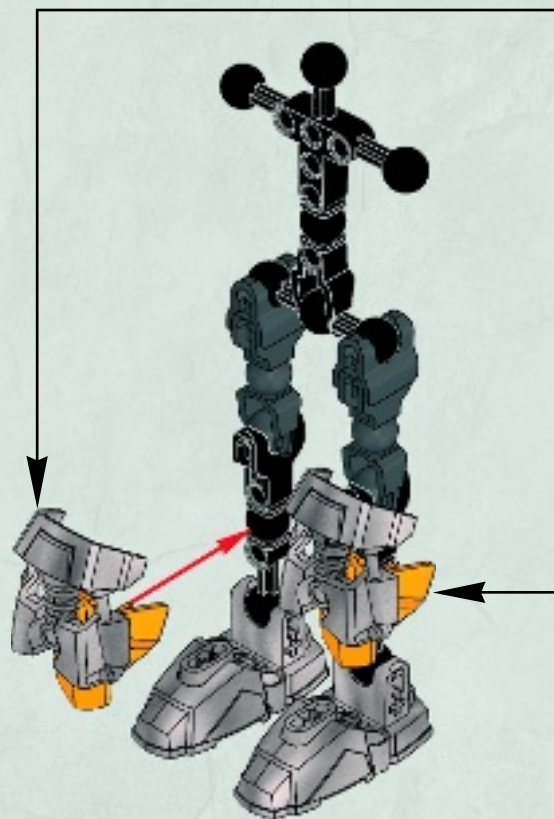



2x

4





1x



2x

5



1x

6



8

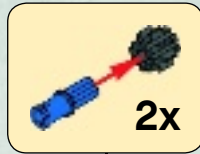

7

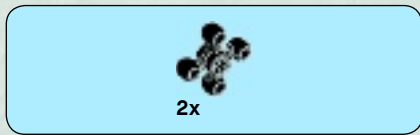
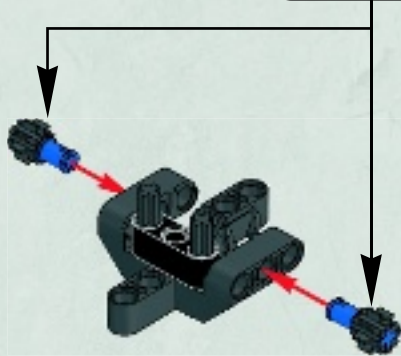

8



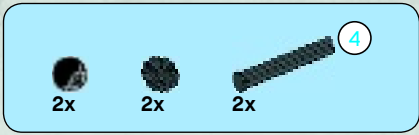

9

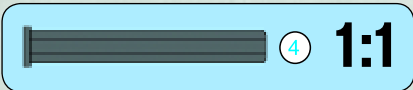
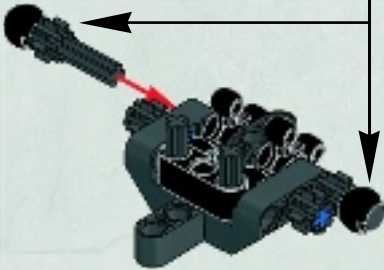
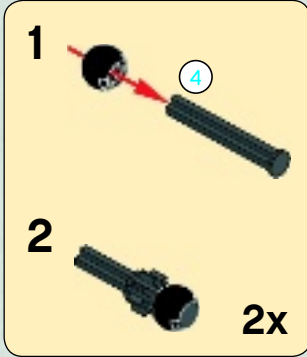

10



2x

10



1x



1x

4

11

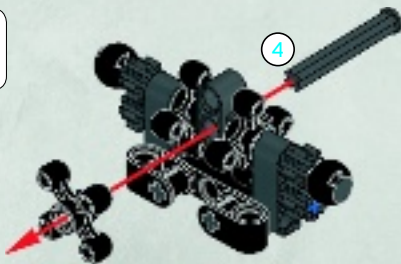

4



1x



2x

12

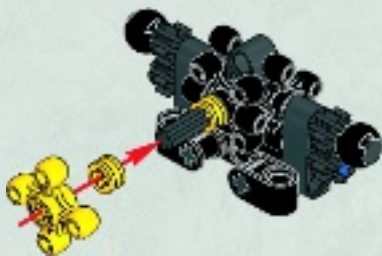

1x



1x

13

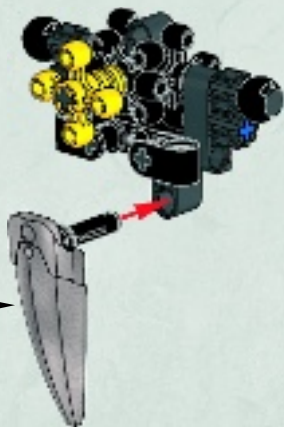
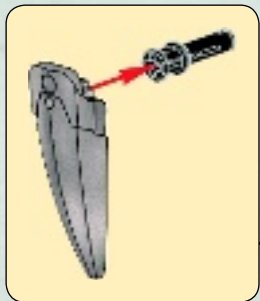



14

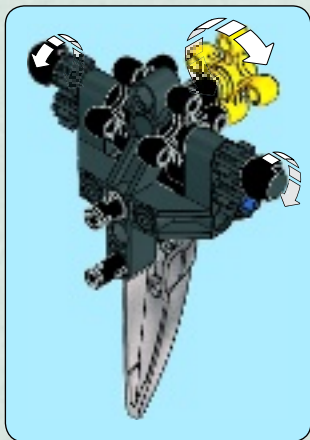

15



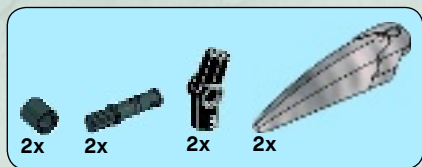

16

1



2



2x

17



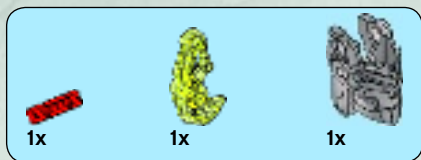

18

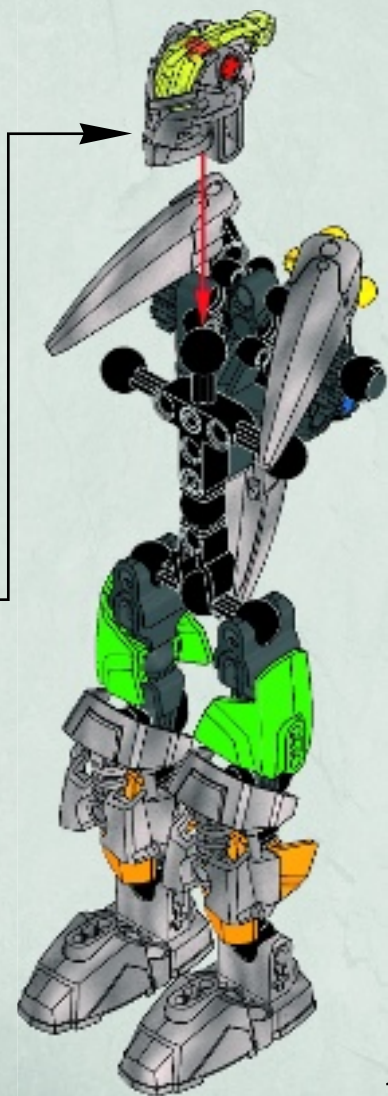
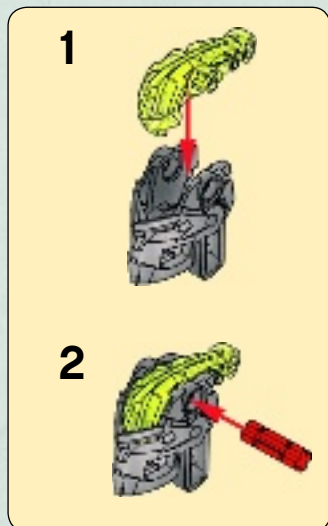

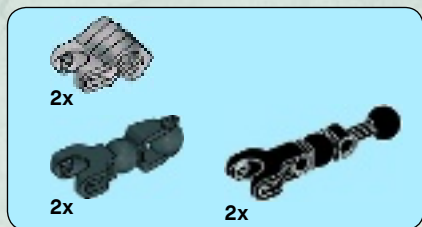

19

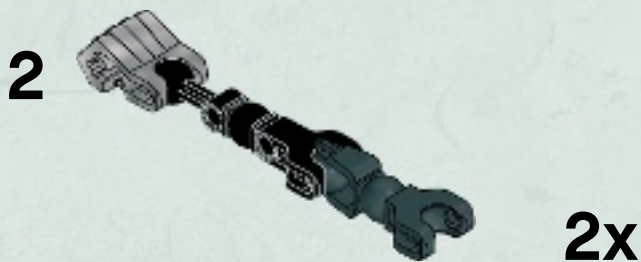
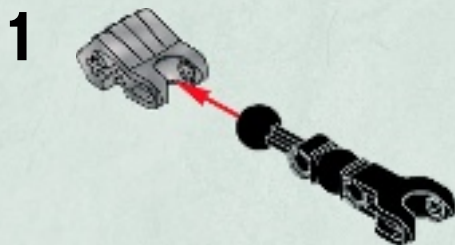

20





2x

21





2x



2x

22



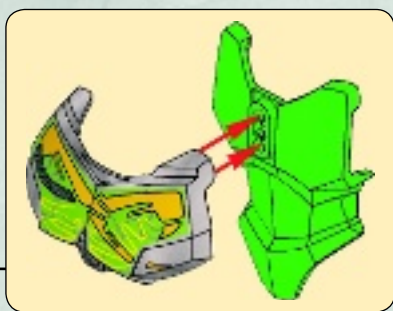
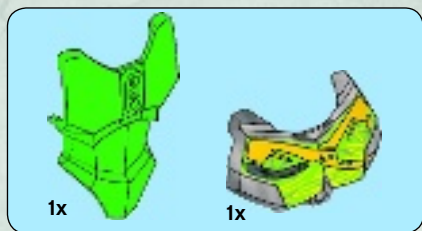

23

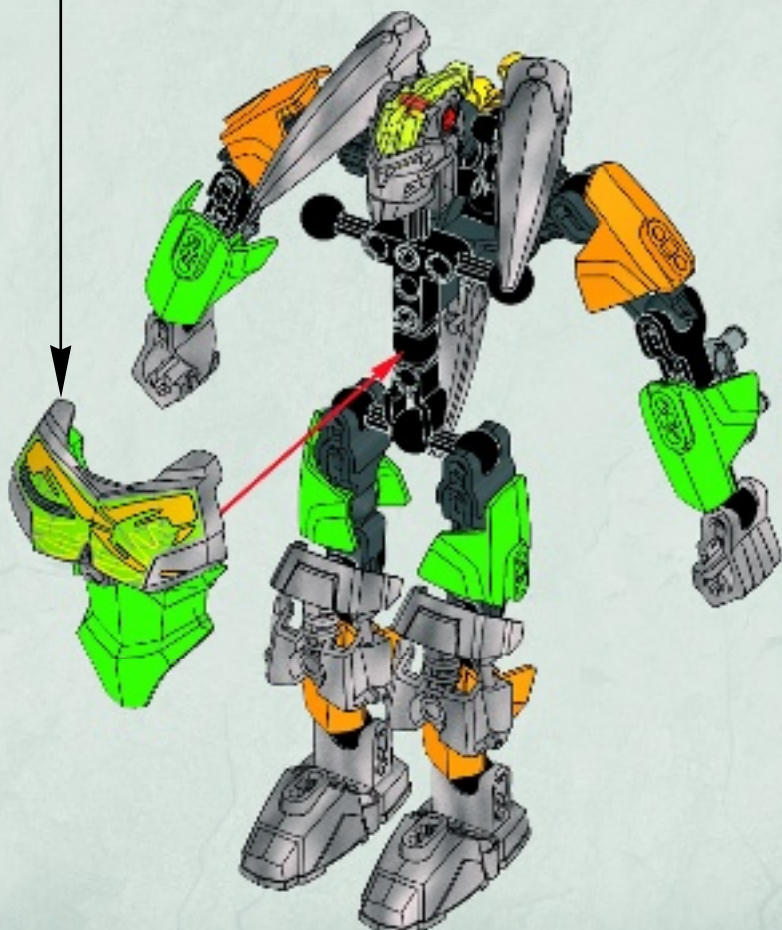

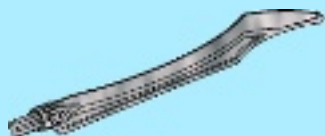

2x

24



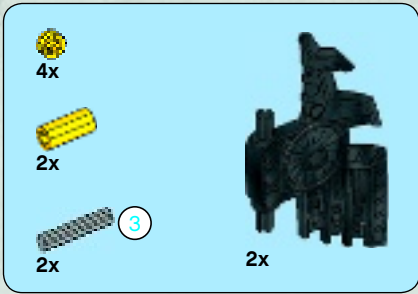

25

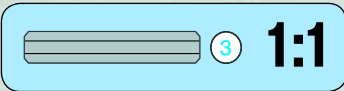
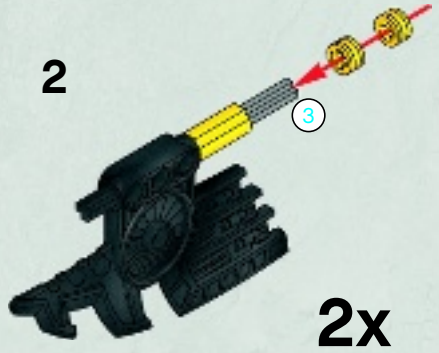

26



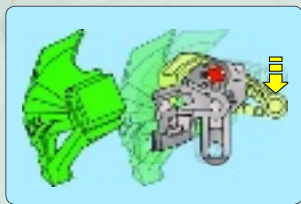
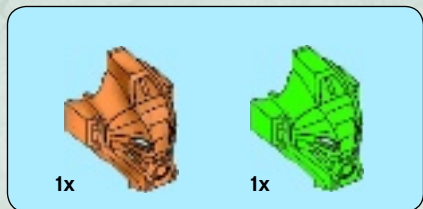

27





1



2



3



2x
4206482

6x
4239601

2x
4519010

1x
4203493



1x
4121715



1x
4142822

2x
4173668

2x
4286267

1x
4589953

4x
4593553

2x
4107082



1x
4140801

3x
4248204

1x
6102750

4x
6108829

1x
6102856

1x
6102639

4x
6102853

1x
4142865

2x
4225033

2x
4211815



2x
6100030

1x
6102645

2x
6106472

4x
4622903



4x
6015356

3x
6083620



4x
6012451

1x
6102752

1x
6106709

4x
6106738

2x
6104152

2x
4619077

2x
4632585

1x
6102606

3x
6102809

2x
6102789

1x
6103763

2x
6016238



Customer Service

Kundenservice

Service Consommateurs

Servicio Al Consumidor

LEGO.com/service or dial



00800 5346 5555 :

1-800-422-5346 :



70786



70788

70785



70787

70784

70789



70778



70784

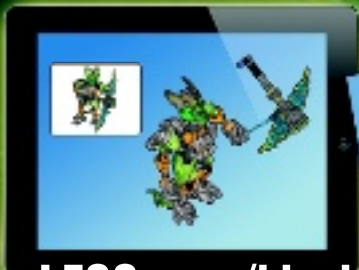

LEGO.com/bionicle/bi



Download App
Télécharger l'application
Descarga la App



LEGO.com/bionicle



Apple, the Apple logo, iPad, iPhone and iPod touch are trademarks of Apple Inc., registered in the U.S. and other countries. App Store is a service mark of Apple Inc.
Apple, le logo Apple, iPad, iPhone et iPod touch sont des marques de commerce d'Apple Inc., déposées aux États-Unis et dans d'autres pays. App Store est une marque de service d'Apple Inc.

Apple, el logotipo de Apple, iPad, iPhone e iPod touch son marcas comerciales de Apple Inc., registradas en EE. UU. y otros países. App Store es una marca de servicio de Apple Inc.
Google Play is a trademark of Google Inc.
Google Play est une marque de commerce de Google Inc.
Google Play es una marca comercial de Google Inc.

Power up

Plus de puissance

Máximo poder

