



DIMENSIONS™

71253



FANTASTIC
BEASTS
AND WHERE
TO FIND THEM

PLAY THE COMPLETE MOVIE

LEGO DIMENSIONS Videogame software © 2016 TT Games Ltd. Produced by TT Games under license from the LEGO Group. LEGO, the LEGO logo, NINJAGO, the NINJAGO logo, DIMENSIONS, the DIMENSIONS logo, the Brick and Knob configurations and the Minifigure are trademarks and/or copyrights of the LEGO Group. ©2016 The LEGO Group. Ghostbusters™ & © 2016 CPIL. All Rights Reserved. A-Team™ & © 2016 Twentieth Century Fox Film Corporation. All Rights Reserved. ADVENTURE TIME and all related characters and elements are trademarks of and © Cartoon Network. (s16). TM, ® & ©2016 Paramount Pictures. All Rights Reserved. ©2016 Warner Bros Entertainment Inc. All Rights Reserved. Harry Potter and Fantastic Beasts Publishing Rights © JKR. (s16). © SEGA. All rights reserved. GREMLINS © &™ WBIEI (s16).™ & © Universal Studios. E.T. THE EXTRA TERRESTRIAL is a trademark and copyright of Universal Studios. Licensed by Universal Studios Licensing LLC. All DC characters and related indicia™ & © DC Comics.™ & © WBIEI. (s16). All other trademarks and copyrights are the property of their respective owners. All rights reserved.

Logiciel de jeu vidéo LEGO DIMENSIONS © 2016 TT Games Ltd. Produit par TT Games avec l'autorisation de LEGO Group. LEGO, le logo LEGO, NINJAGO, le logo NINJAGO, DIMENSIONS, le logo DIMENSIONS, les configurations de la Brique et du Bouton, ainsi que le Minifigure sont des marques de commerce ou des droits d'auteur de LEGO Group. ©2016 The LEGO Group. Ghostbusters^{MC} et © 2016 CPIL. Tous droits réservés. A-Team^{MC} et © 2016 Twentieth Century Fox Film Corporation. Tous droits réservés. ADVENTURE TIME et tous personnages et éléments associés sont des marques de commerce et droits d'auteur de Cartoon Network. (s16). ^{MC}, ® et ©2016 Paramount Pictures. Tous droits réservés. ©2016 Warner Bros Entertainment Inc. Tous droits réservés. Droits d'édition sur Harry Potter et Les Animaux fantastiques © JKR. (s16). © SEGA. Tous droits réservés. GREMLINS © et ^{MC} WBIEI (s16). ^{MC} et © Universal Studios. E.T. L'EXTRA-TERRESTRE est une marque de commerce d'Universal Studios, qui en détient également les droits d'auteur. Autorisé par Universal Studios Licensing LLC. Tous les personnages DC et indices associés sont des marques de commerce et © de DC Comics. ^{MC} et © WBIEI. (s16). Toutes les autres marques de commerce et droits d'auteur sont la propriété de leurs propriétaires respectifs. Tous droits réservés.

LEGO DIMENSIONS Videogame software © 2016 TT Games Ltd. Producido por TT Games con licencia de LEGO Group. LEGO, el logotipo de LEGO, NINJAGO, el logotipo de NINJAGO, DIMENSIONS, el logotipo de DIMENSIONS, las configuraciones Brick y Knob y la Minifigura son marcas de fábrica y/o derechos de autor de LEGO Group. ©2016 The LEGO Group. Ghostbusters es™ y © 2016 de CPIL. Todos los derechos reservados. A-Team es™ y © 2016 de Twentieth Century Fox Film Corporation. Todos los derechos reservados. ADVENTURE TIME y todos los personajes y elementos relacionados son marcas registradas y © de Cartoon Network. (s16).™ es® y © de 2016 Paramount Pictures. Todos los derechos reservados. ©2016 Warner Bros Entertainment Inc. Todos los derechos reservados. Harry Potter y Animales Fantásticos Derechos de publicación © JKR. (s16). © SEGA. Todos los derechos reservados. GREMLINS es © y™ de WBIEI (s16).™ y © de Universal Studios. E.T. THE EXTRA TERRESTRIAL es una marca registrada y los derechos de autor son de Universal Studios. Con licencia de Universal Studios Licensing LLC. Todos los personajes y elementos relacionados de DC son™ y © de DC Comics.™ y © de WBIEI. (s16). Todas las marcas comerciales y los derechos de autor son propiedad de sus respectivos titulares. Todos los derechos reservados.



WB GAMES LOGO, WBIEI LOGO, WB SHIELD:™ & © Warner Bros. Entertainment Inc.
LOGO WB GAMES, LOGO WBIEI, BOUCLIER WB :^{MC} et © de Warner Bros. Entertainment Inc.
LOGOTIPO de WB GAMES, LOGOTIPO de WBIEI, ESCUDO de WB:™ & © Warner Bros. Entertainment Inc.
(s16)

THE LEGO MOVIE © The LEGO Group & WBIEI.
LE FILM LEGO © The LEGO Group et WBIEI.
LA GRAN AVENTURA LEGO © The LEGO Group & WBIEI.

© New Line.™ & © SZC lic. to WBIEI.
© New Line. ^{MC} et © SZC lic. à WBIEI.
© New Line.™ & © SZC con licencia de WBIEI.
(s16)



All DC characters and related indicia™ & © DC Comics.™ & © WBIEI.
Todos los personajes DC et toutes les marques associées ^{MC} et © DC Comics. ^{MC} et © WBIEI.
Todos los personajes de DC e indicios relacionados™ & © DC Comics.™ & © WBIEI.
(s16)

JOUEZ LE FILM EN ENTIER JUEGA LA PELÍCULA COMPLETA

This device complies with part 15 of the FCC Rules. Operation is subject to the following two conditions:

(1) This device may not cause harmful interference, and (2) this device must accept any interference received, including interference that may cause undesired operation.

This device should be installed and operated with a minimum distance of 20 cm to your body.

NOTE: This equipment has been tested and found to comply with the limits for a Class B digital device, pursuant to part 15 of the FCC Rules. These limits are designed to provide reasonable protection against harmful interference in a residential installation. This equipment generates, uses and can radiate radio frequency energy and, if not installed and used in accordance with the instructions, may cause harmful interference to radio communications. However, there is no guarantee that interference will not occur in a particular installation. If this equipment does cause harmful interference to radio or television reception, which can be determined by turning the equipment off and on, the user is encouraged to try to correct the interference by one or more of the following measures:

- Reorient or relocate the receiving antenna.
- Increase the separation between the equipment and receiver.
- Connect the equipment into an outlet on a circuit different from that to which the receiver is connected.
- Consult the dealer or an experienced radio/TV technician for help.

Caution: changes or modifications not expressly approved by the party responsible for compliance could void the user's authority to operate the equipment.

This device complies with Industry Canada license-exempt RSS standard(s). Operation is subject to the following two conditions:

(1) this device may not cause interference, and (2) this device must accept any interference, including interference that may cause undesired operation of the device.

Le présent appareil est conforme aux CNR d'Industrie Canada applicables aux appareils radio exempts de licence. L'exploitation est autorisée aux deux conditions suivantes : (1) l'appareil ne doit pas produire de brouillage, et (2) l'utilisateur de l'appareil doit accepter tout brouillage radioélectrique subi, même si le brouillage est susceptible d'en compromettre le fonctionnement.



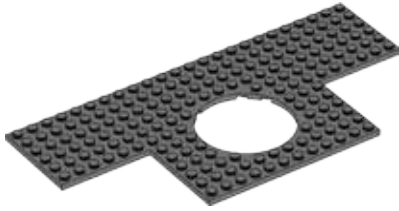

+

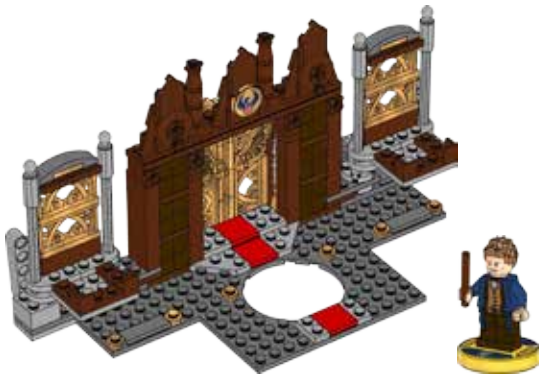

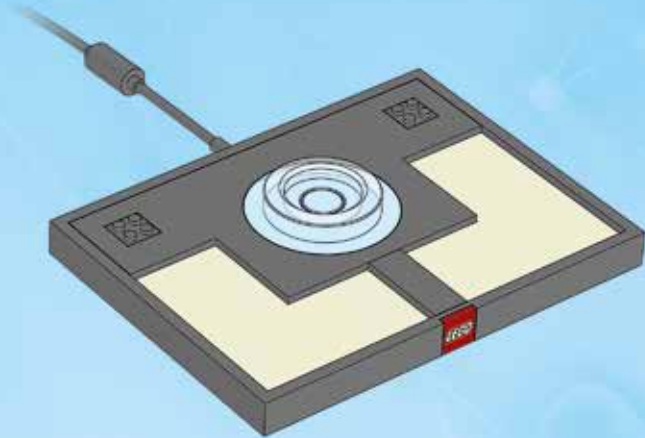

Download the latest game content to use this character

Télécharge le contenu le plus récent du jeu pour utiliser ce personnage

Descarga la última actualización de contenido para usar este personaje

**Start game
Commence le jeu
Iniciar juego**

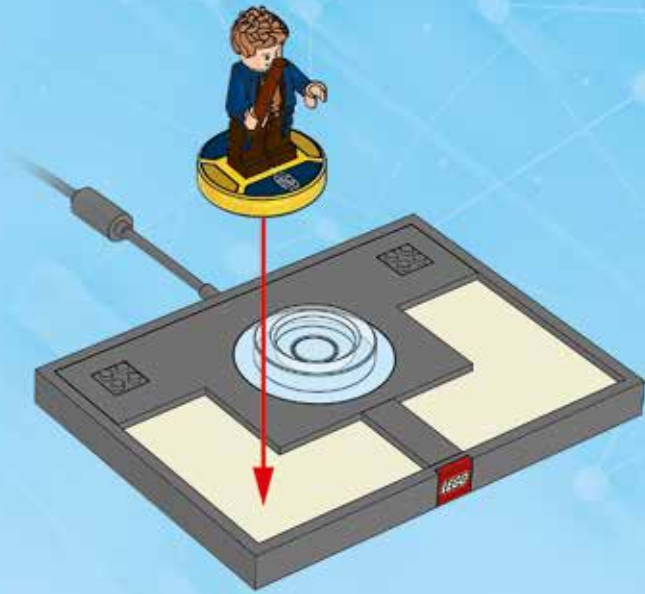



- **Building is part of playing the game**
- **La construction fait partie du déroulement du jeu**
- **Construir forma parte del juego**



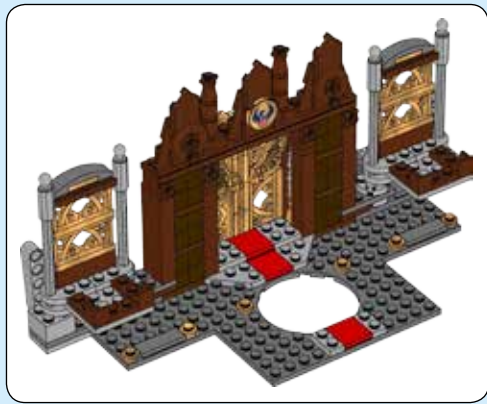

1

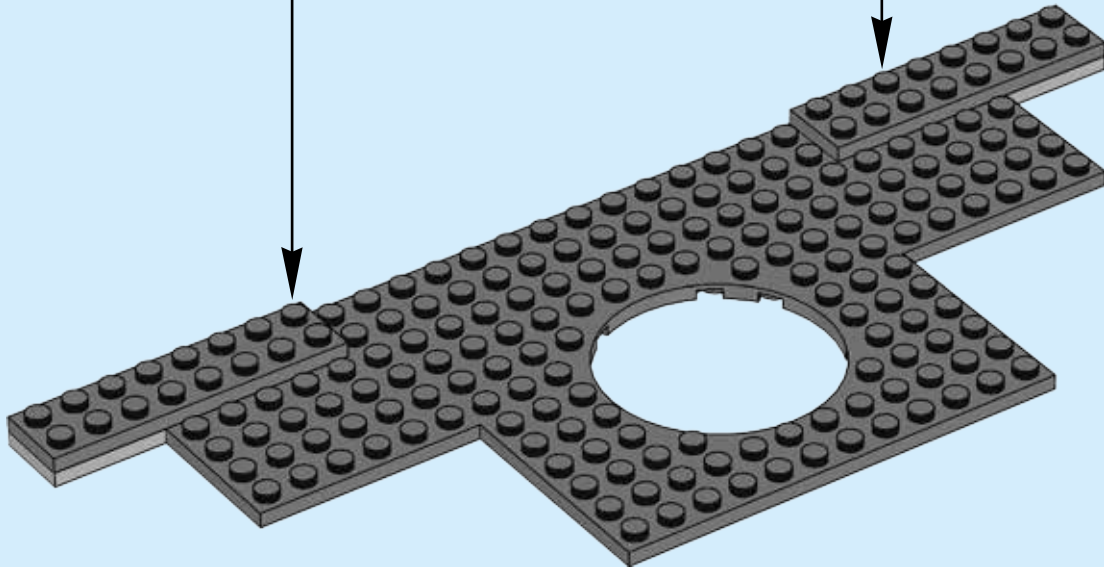
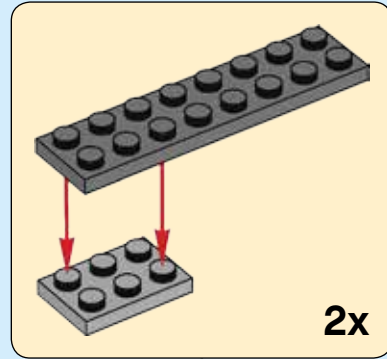

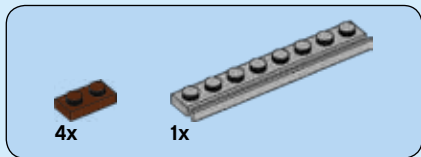

2

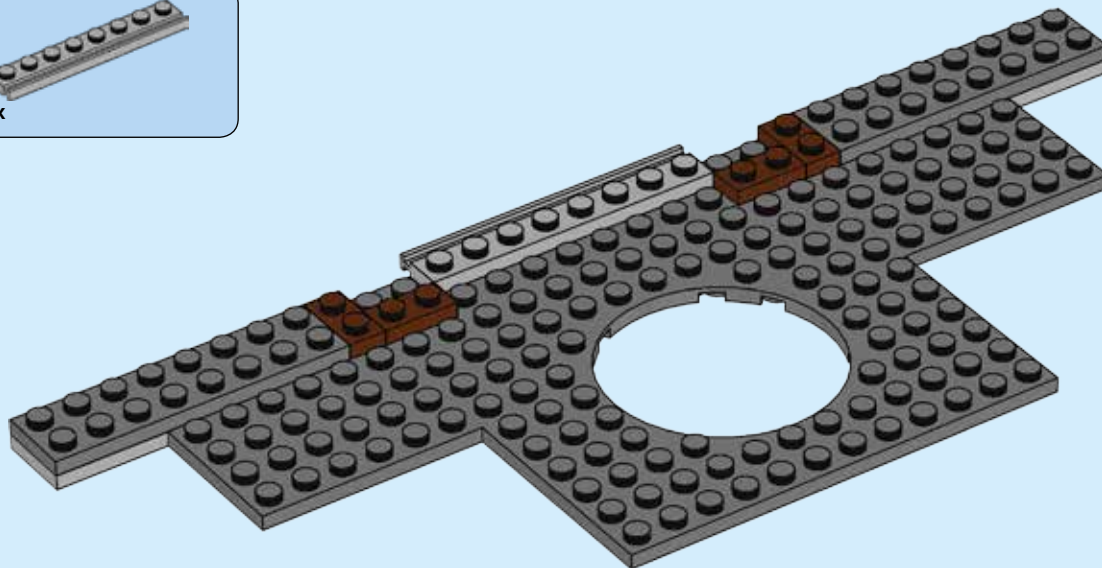

3

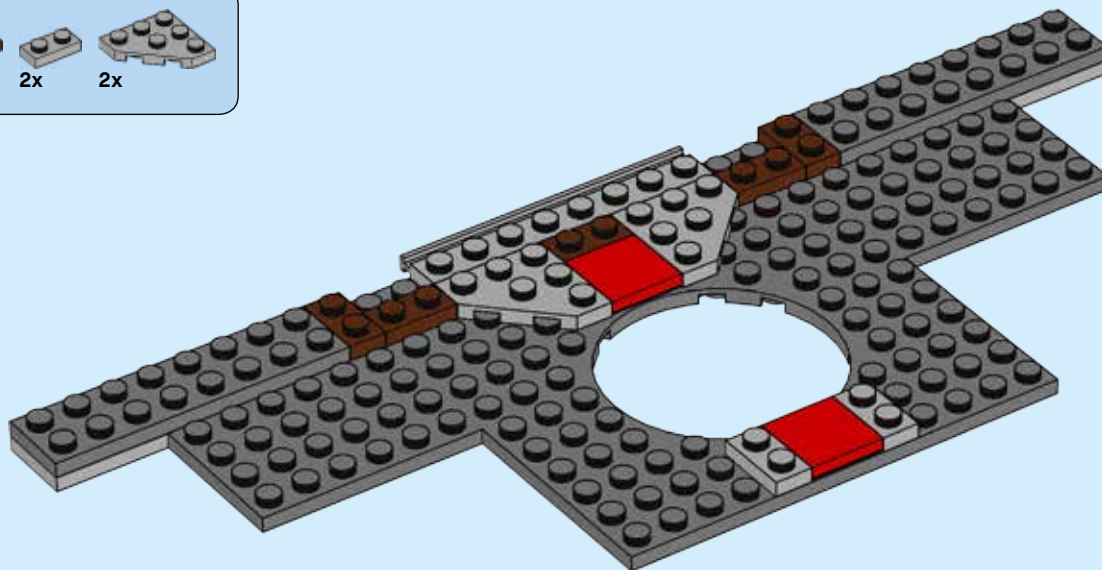



4

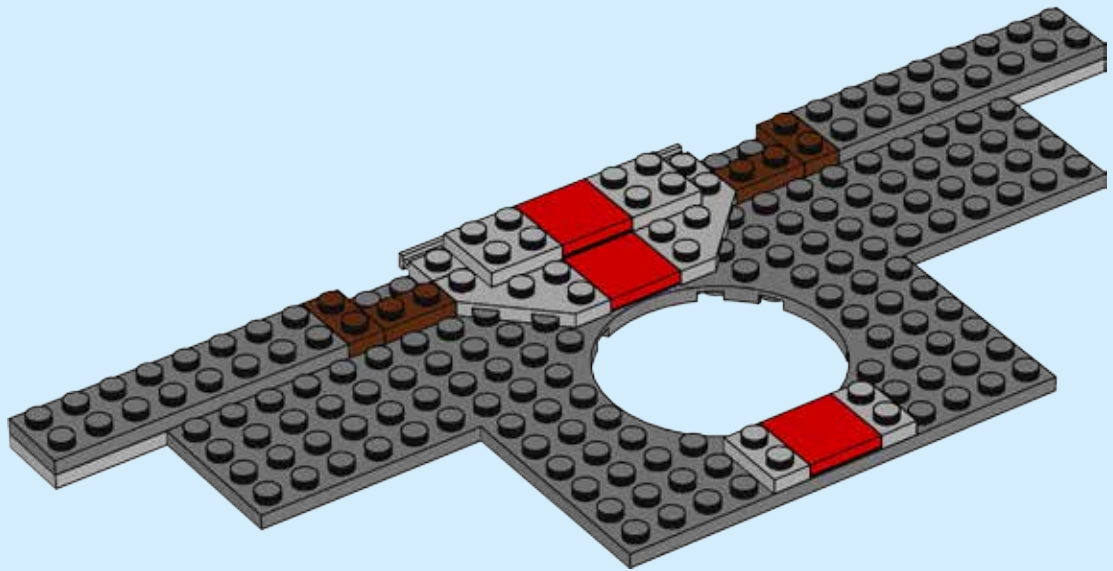



6x



2x

5

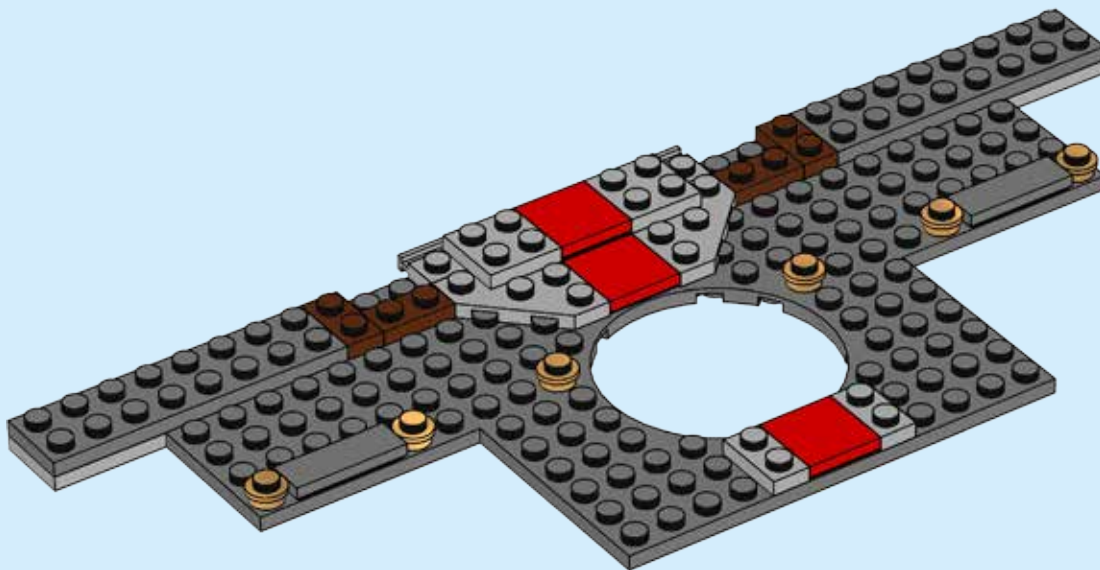

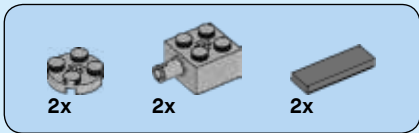

7

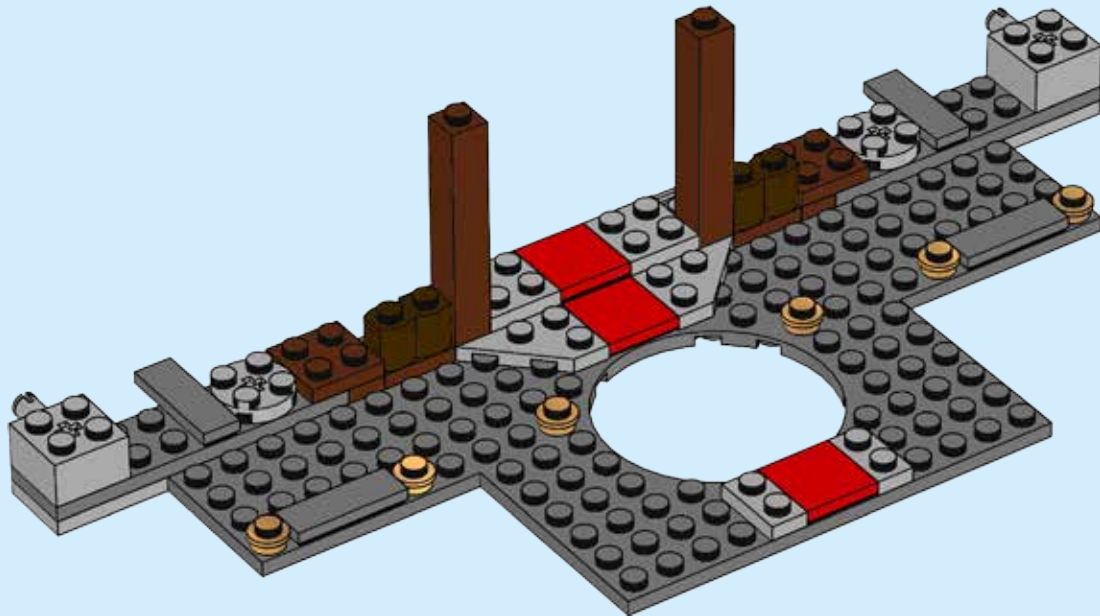

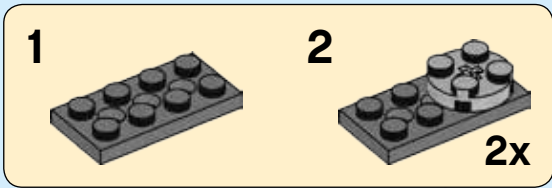
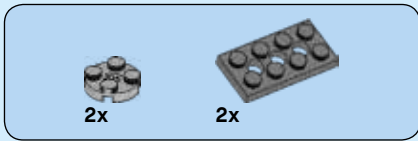

8

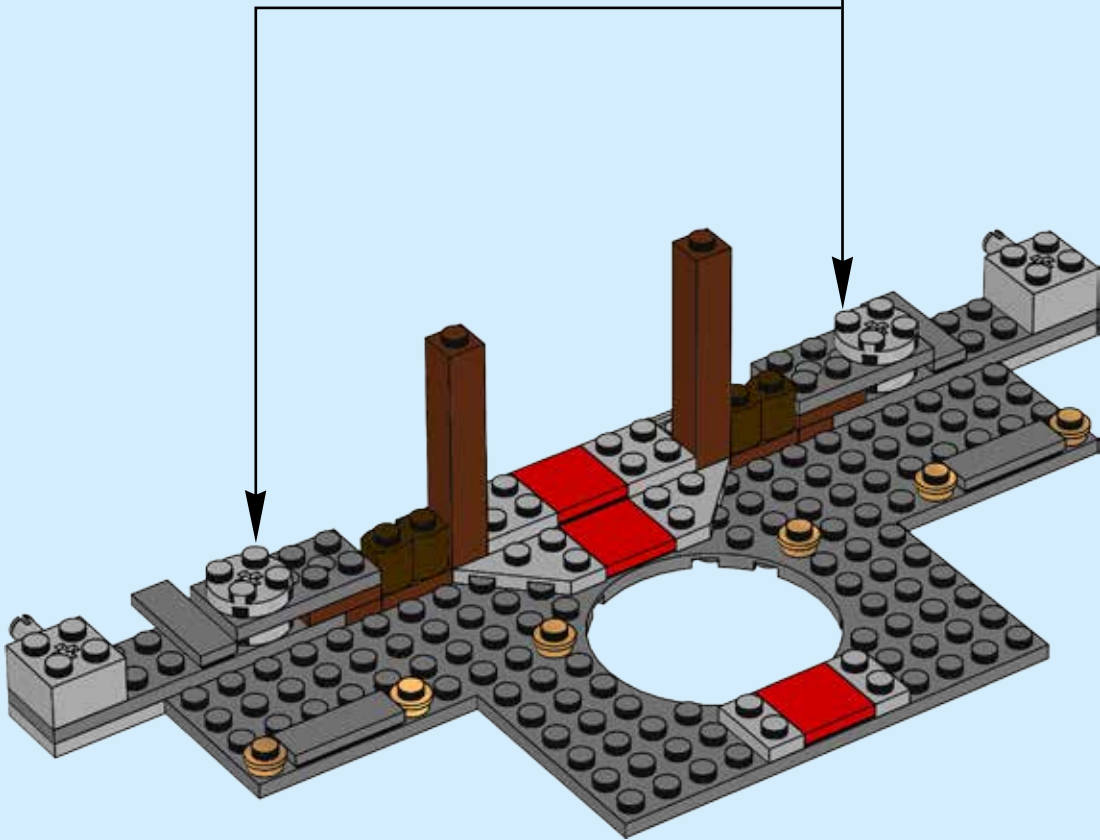



9

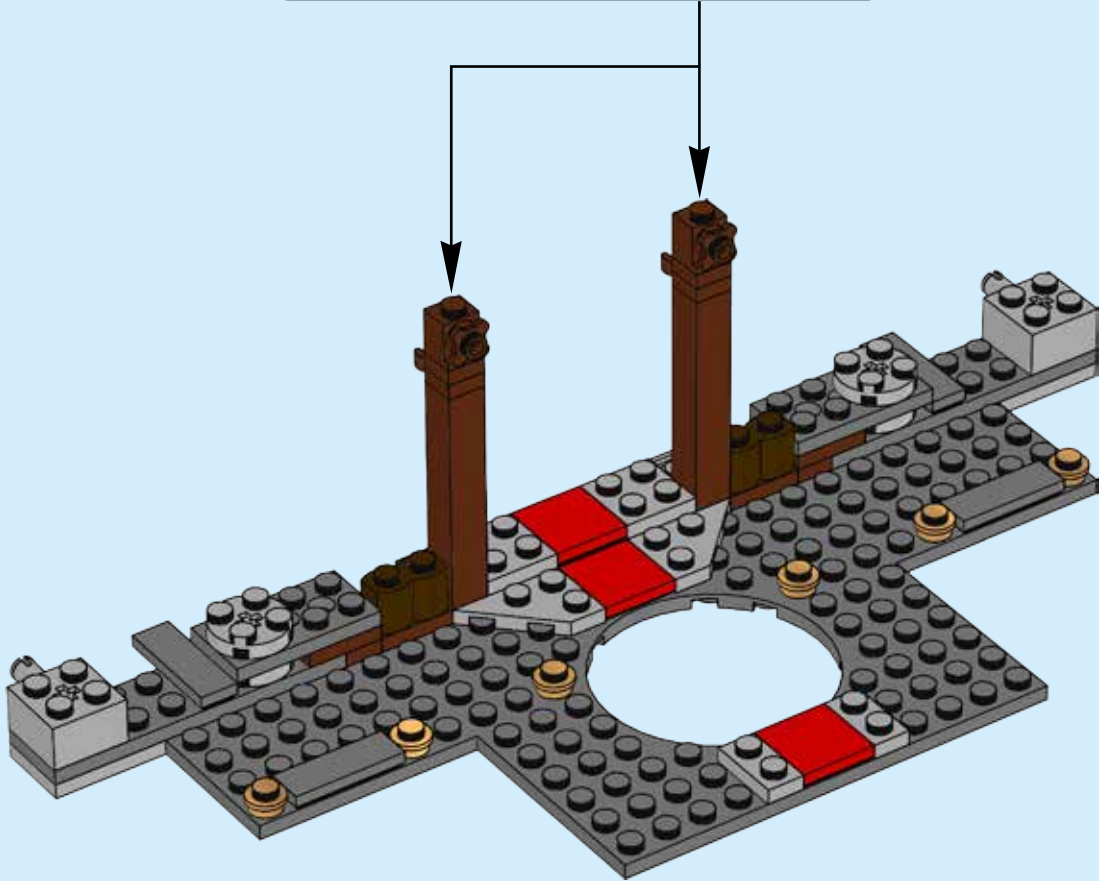
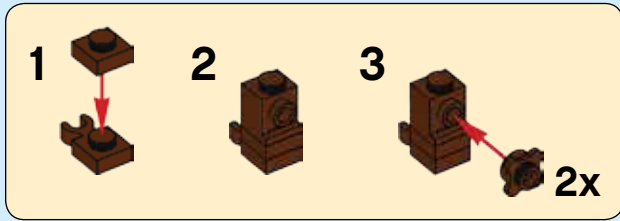



10

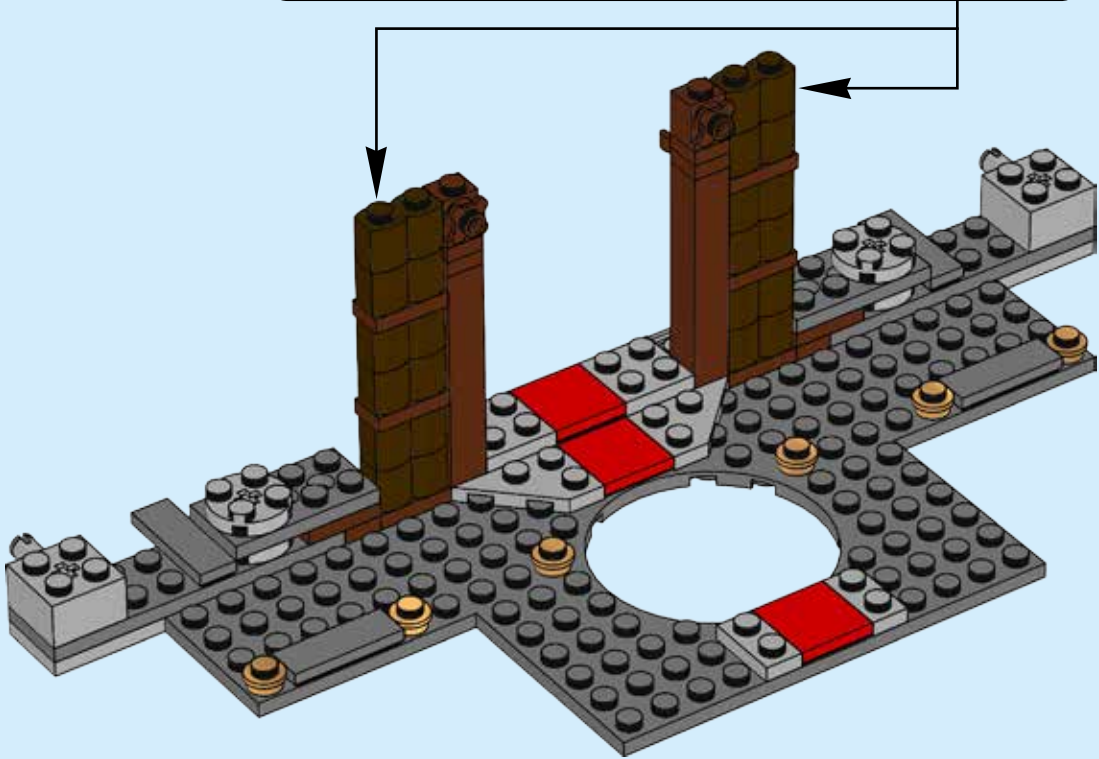
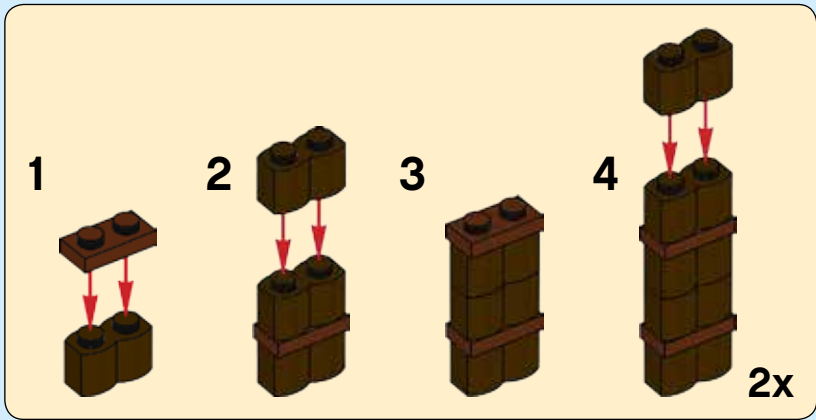

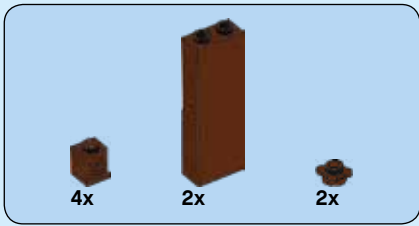

11

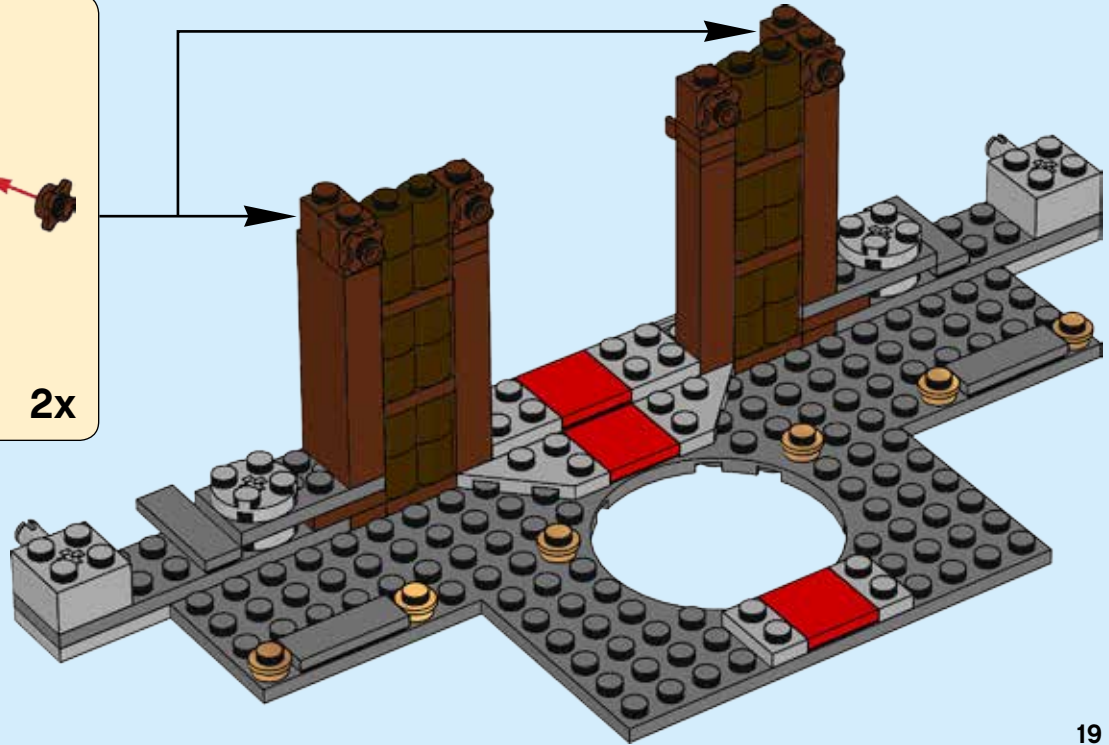
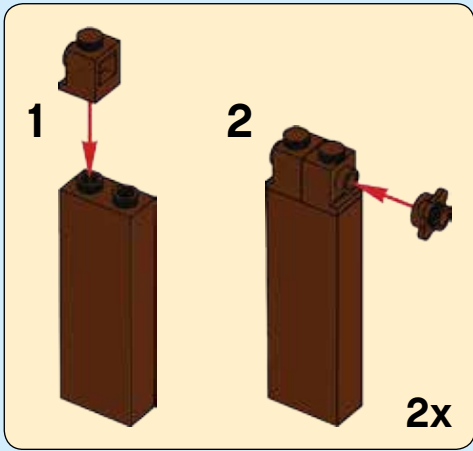

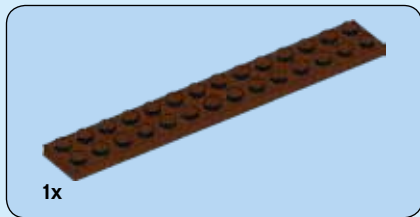

12

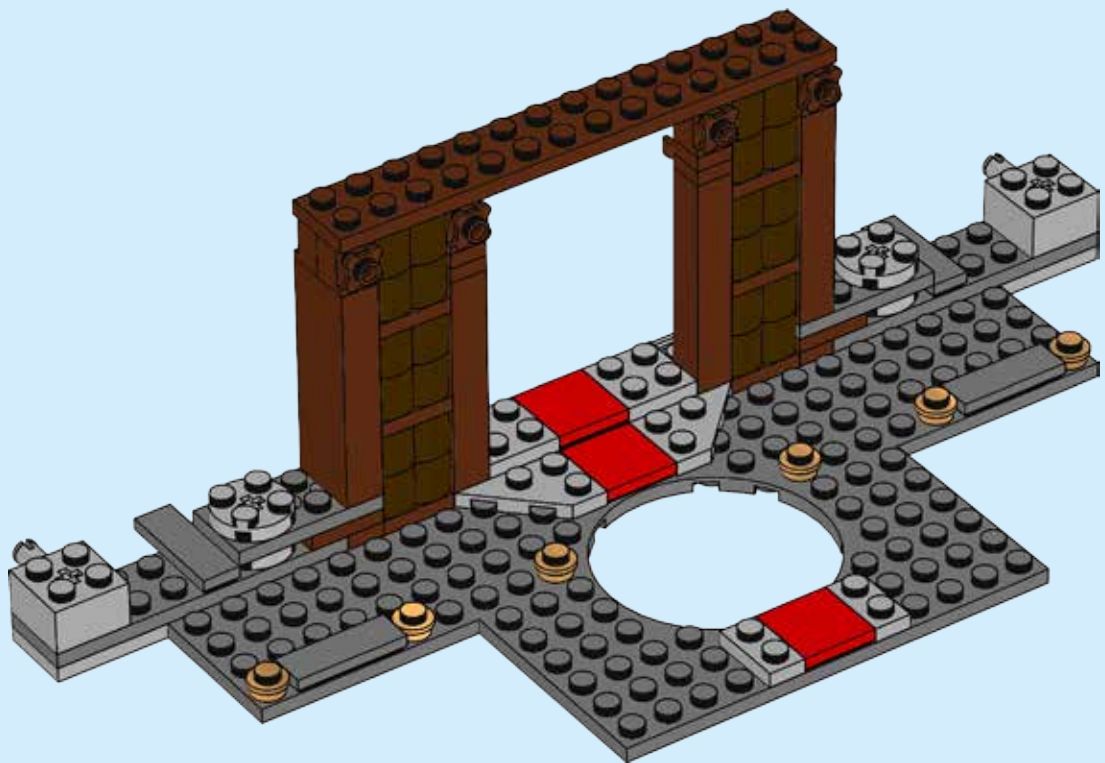

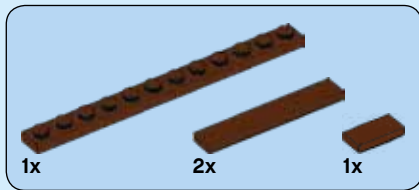

13

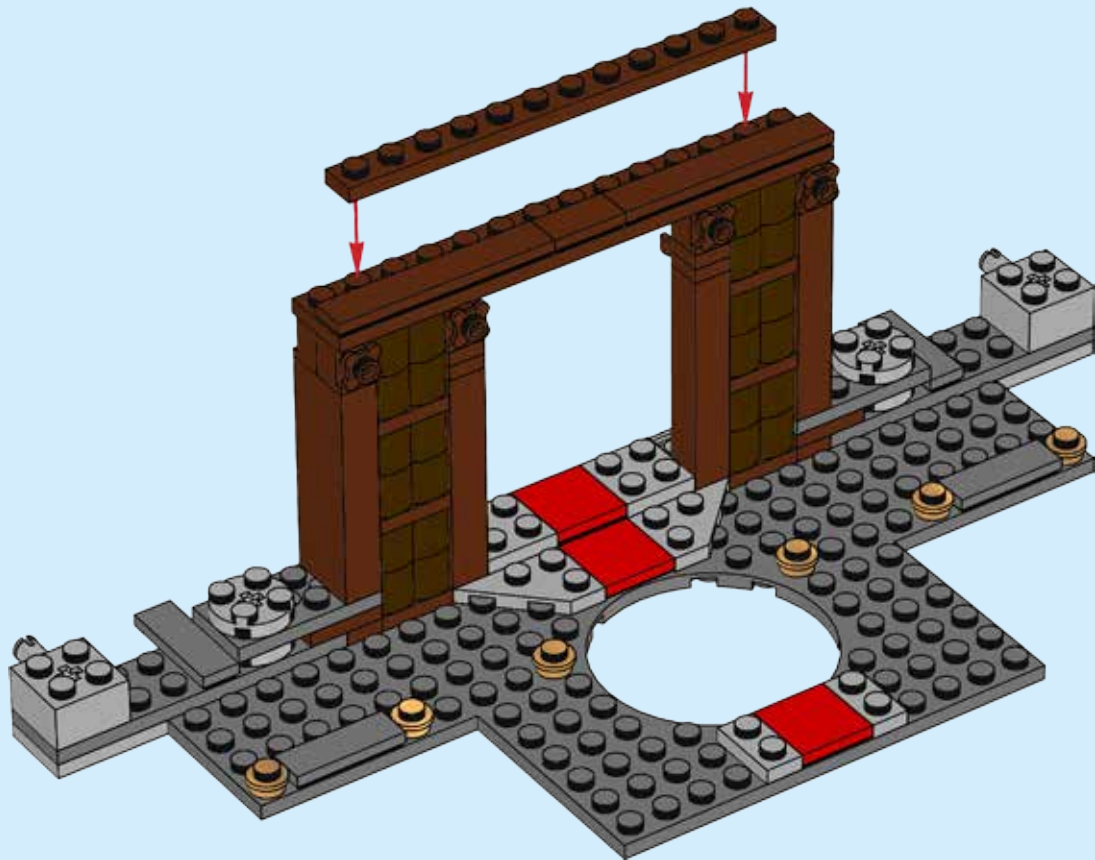

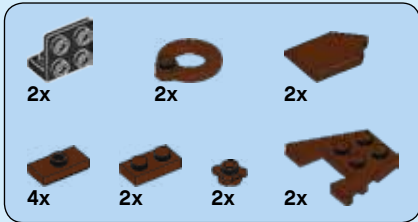

14

1

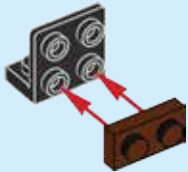

2



3



4



5



2x

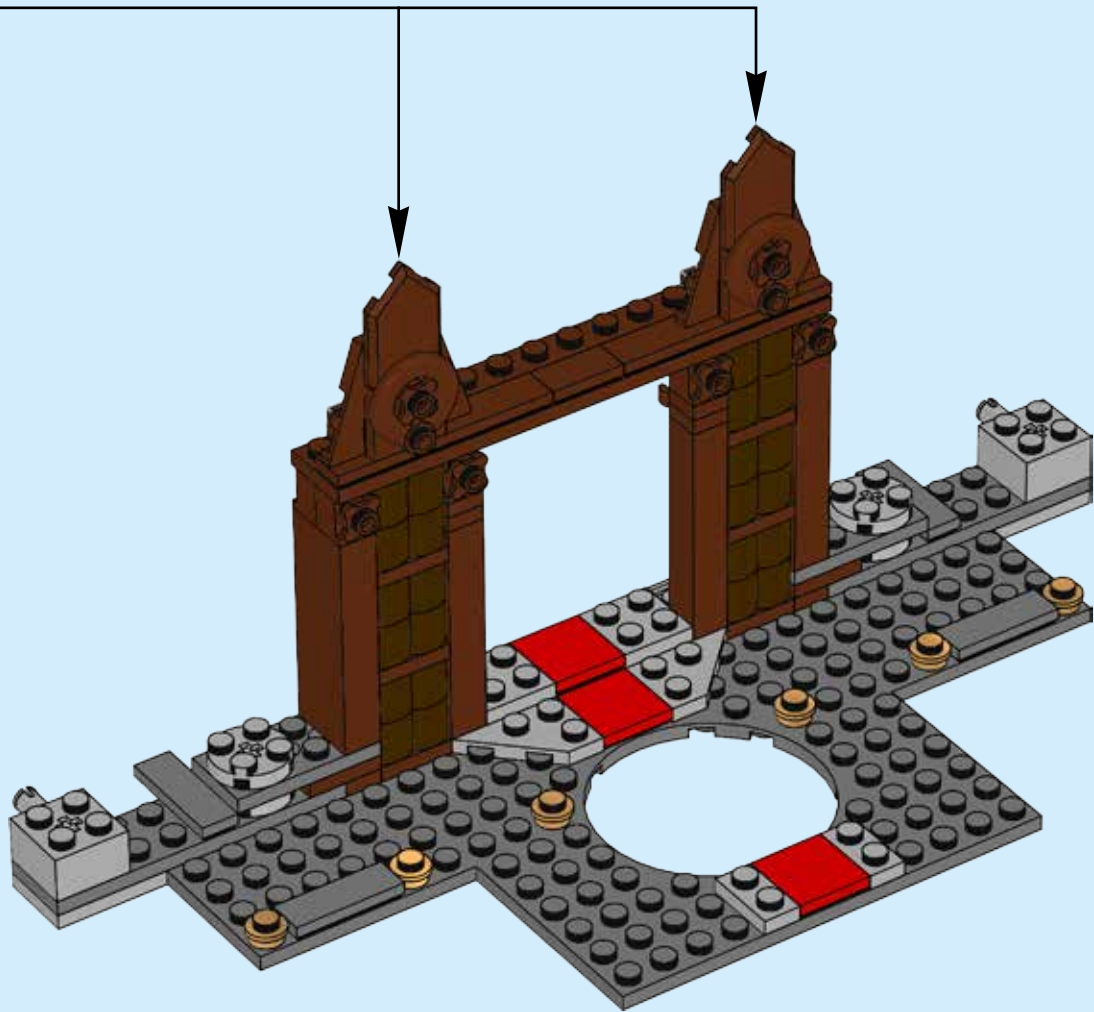

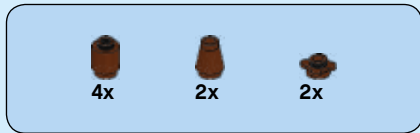

15

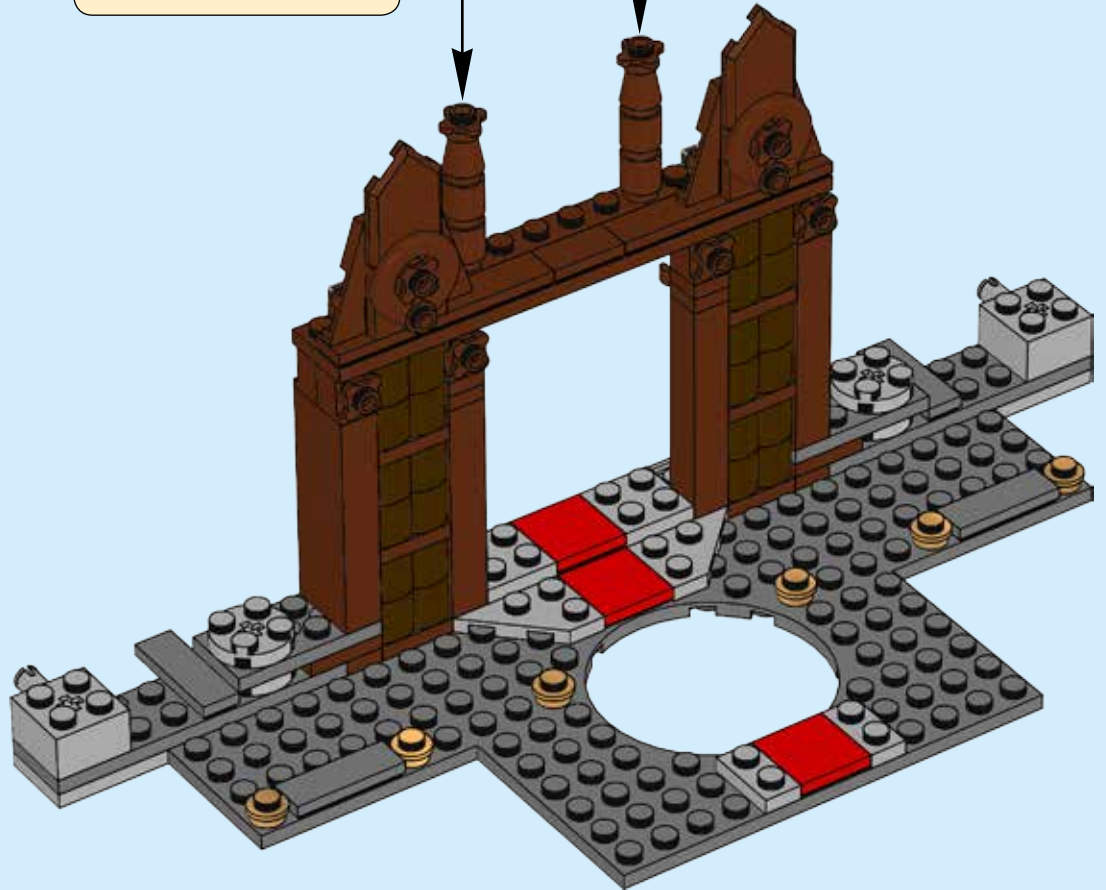
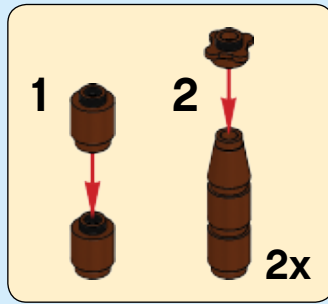



16

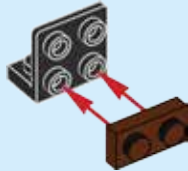

17



18



19





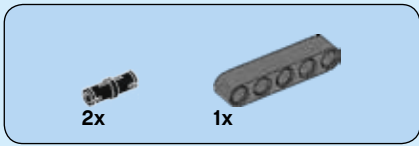

21

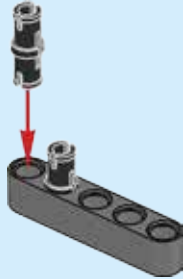

22

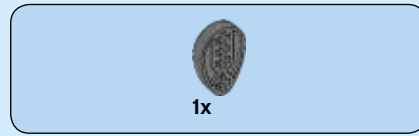
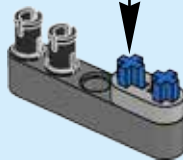
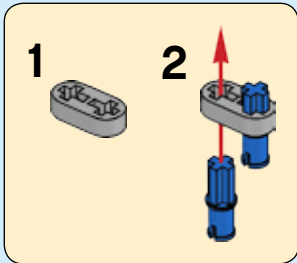

23

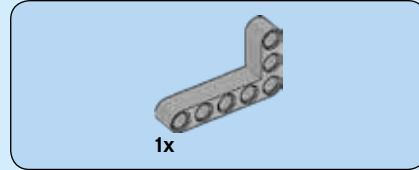
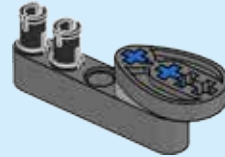

24

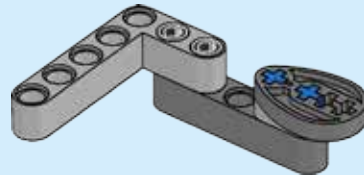

25

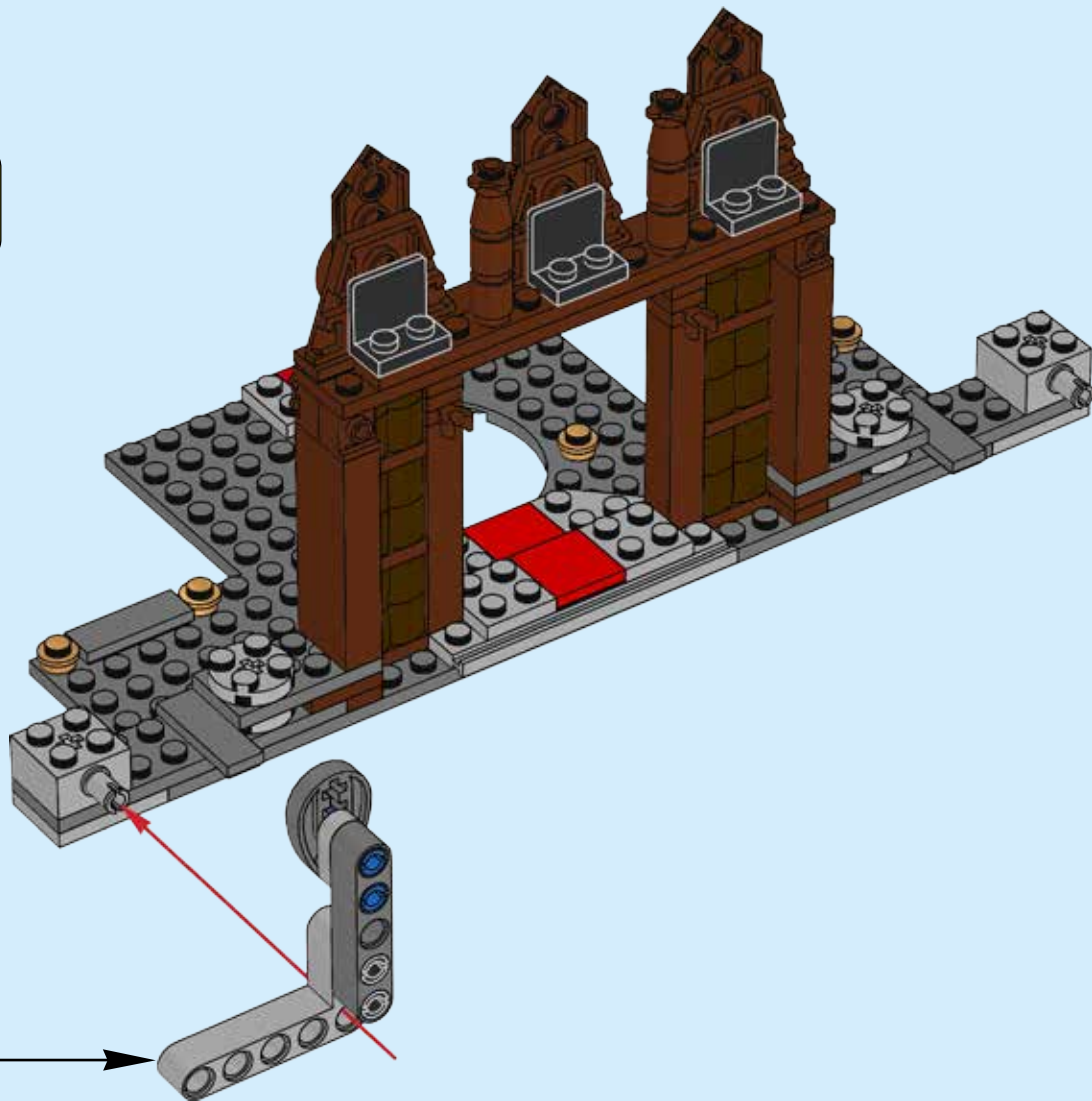
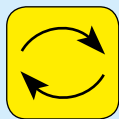

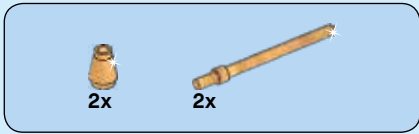

26

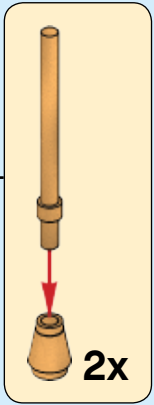
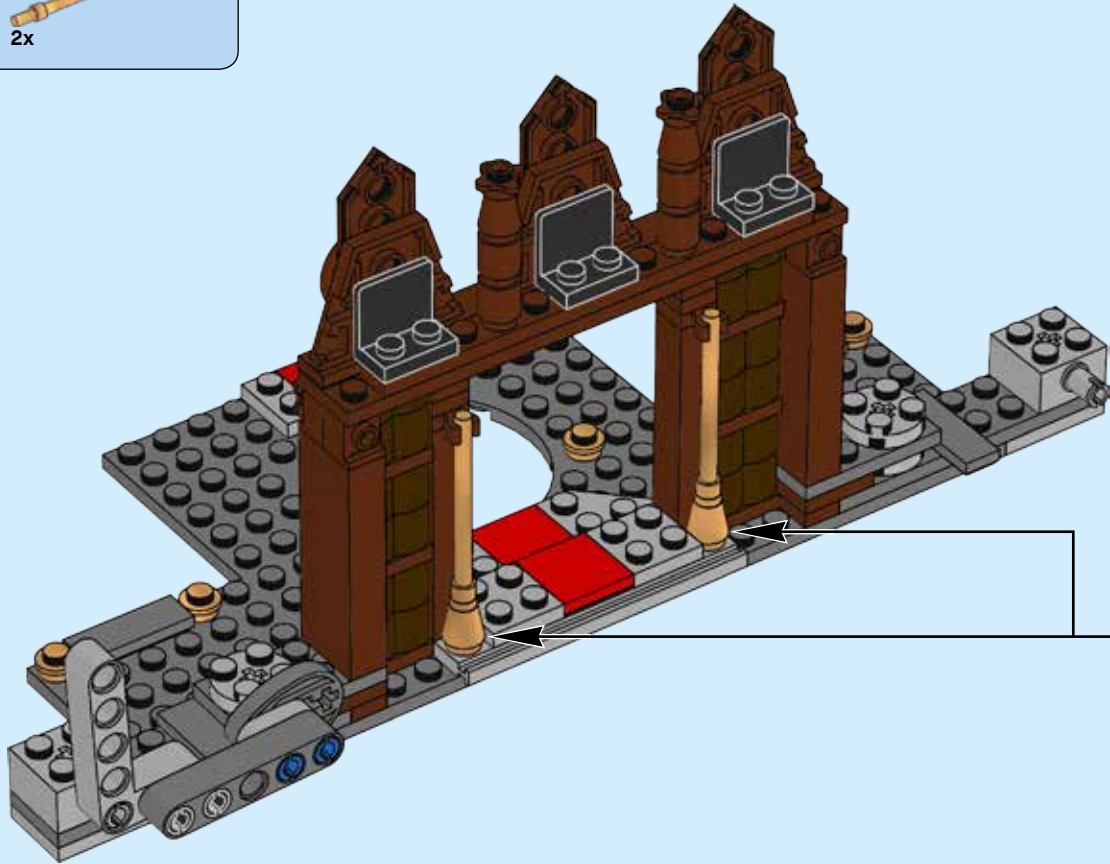

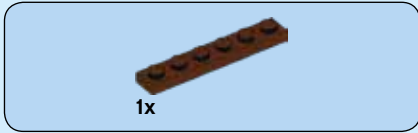

1x

27

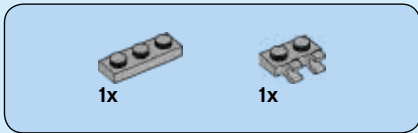

1x

1x

28

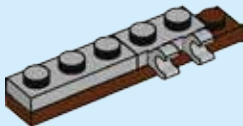

1x

1x

29

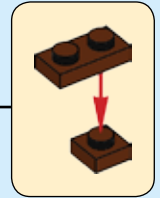

1x

1x

30

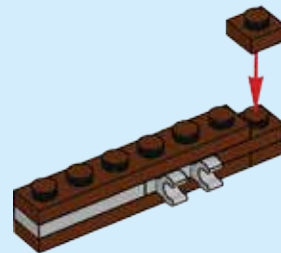



31

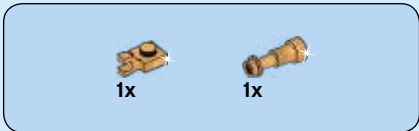
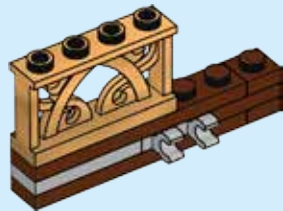

32

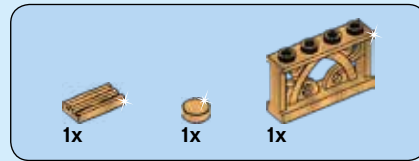
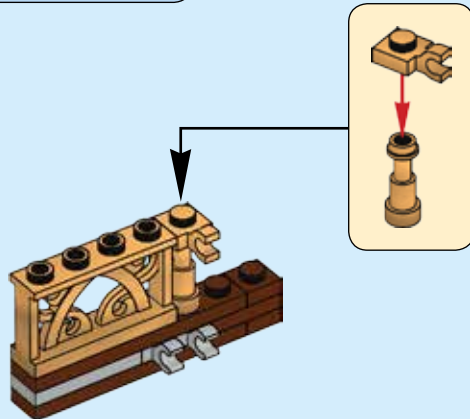

33

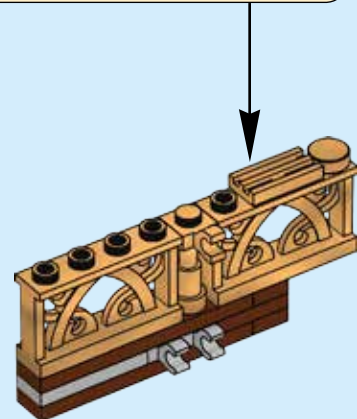
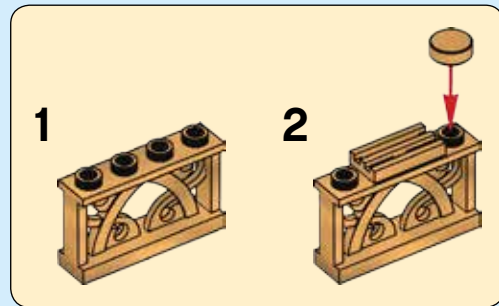



3x

34

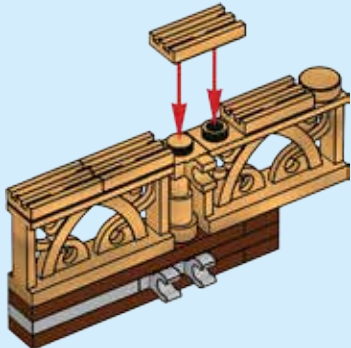

1x

35

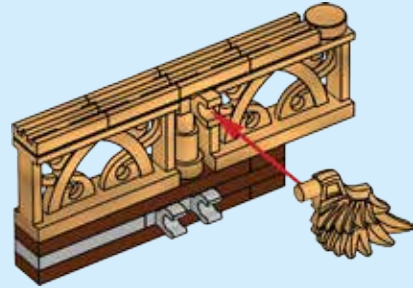

36



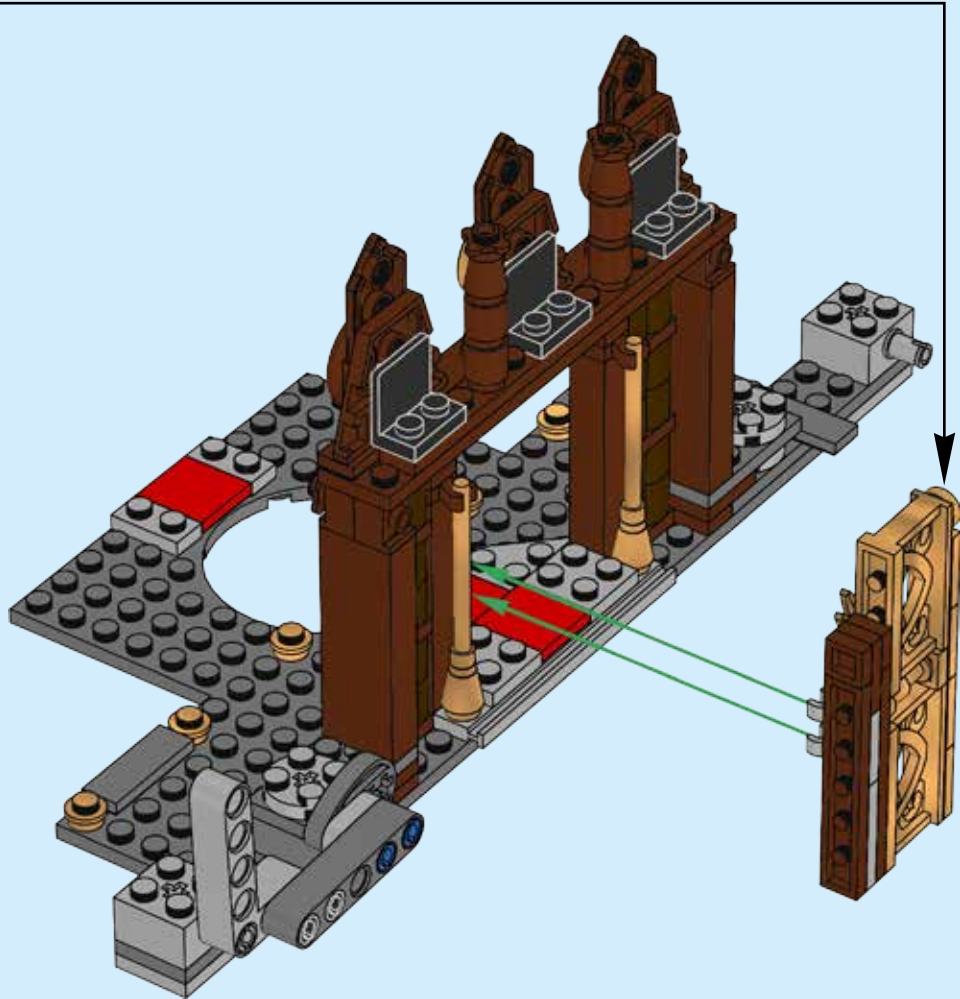



38

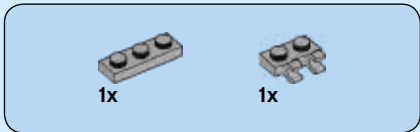

39

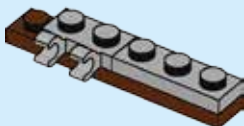

40

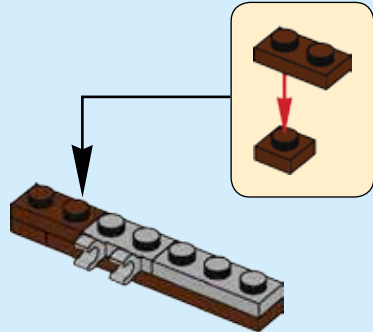

41

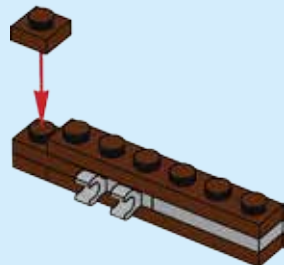

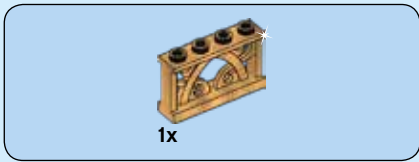

42

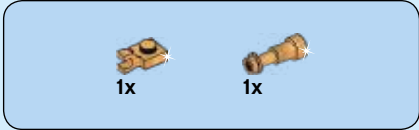
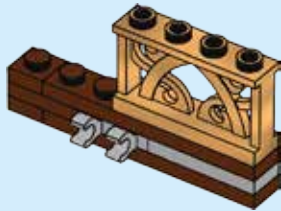

43

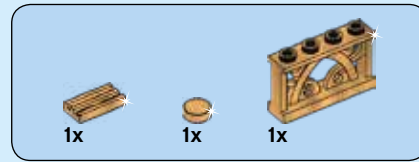
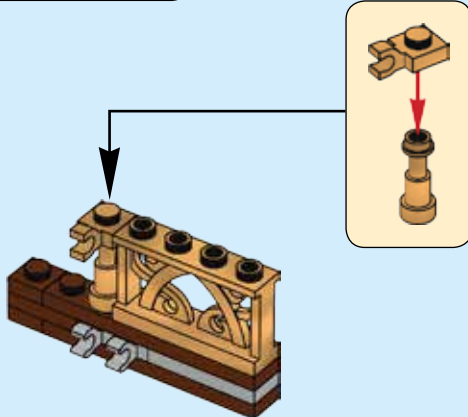

44

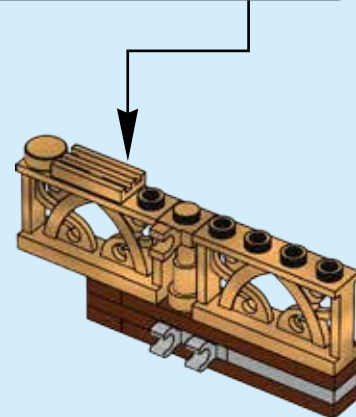
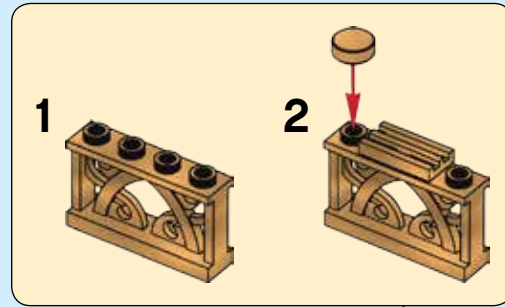



3x

45

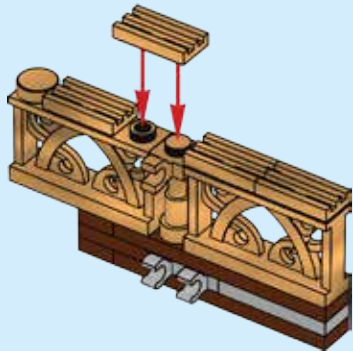

1x

46

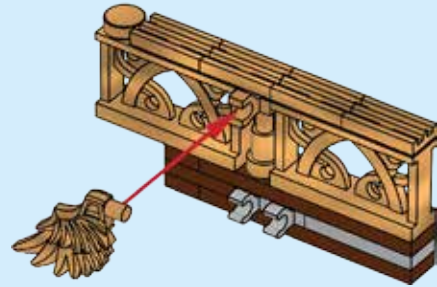

47

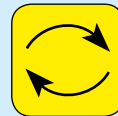

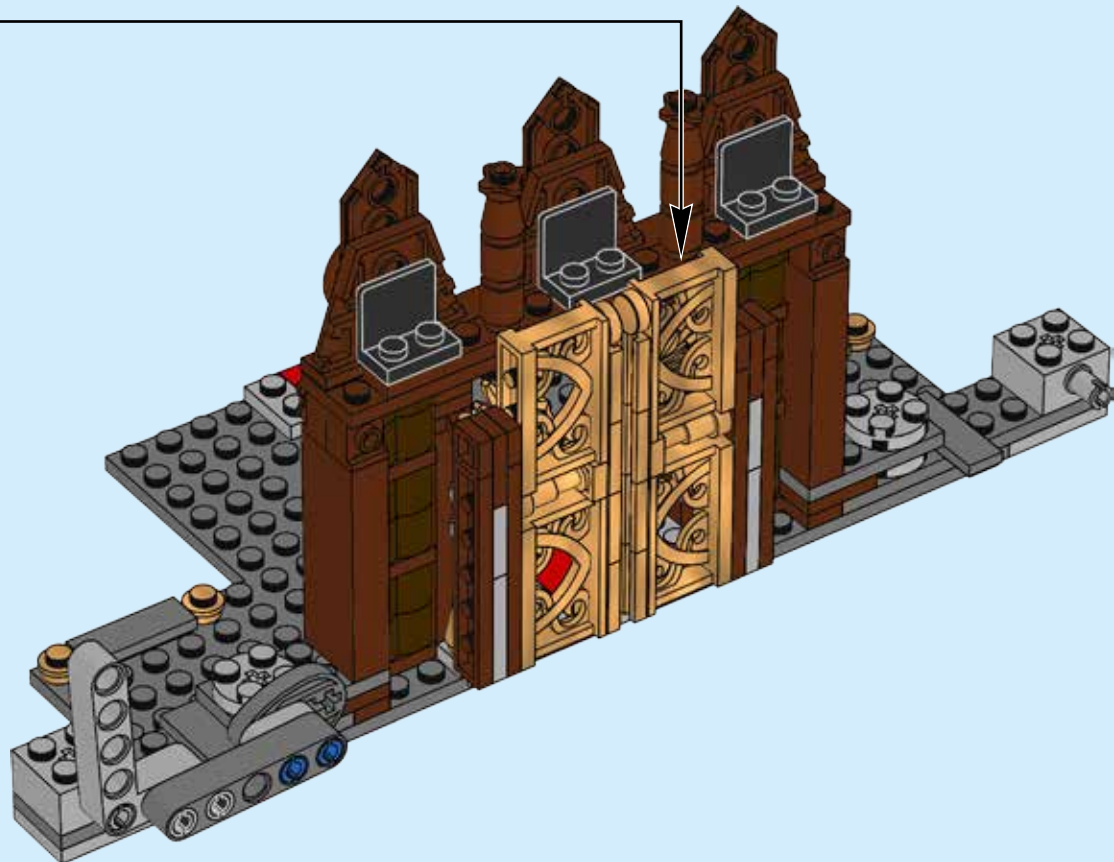

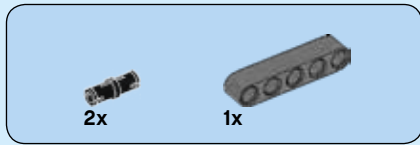

49

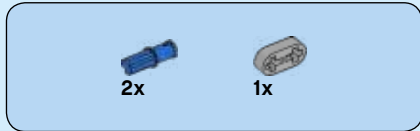
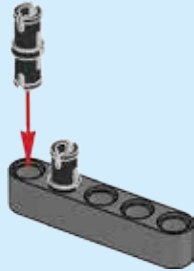

50

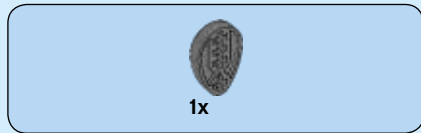
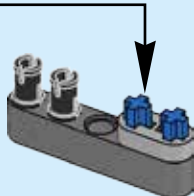
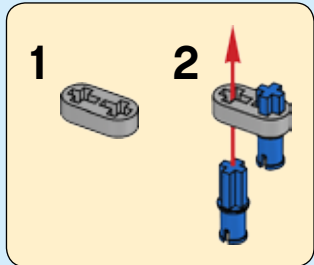

51

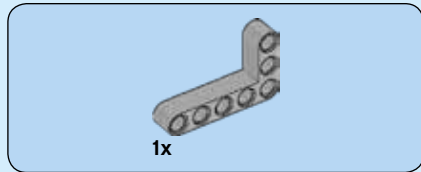
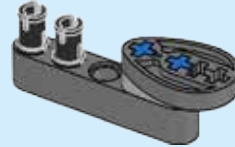

52

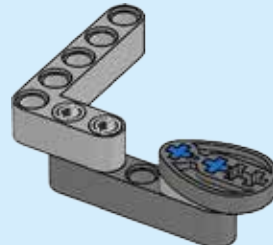

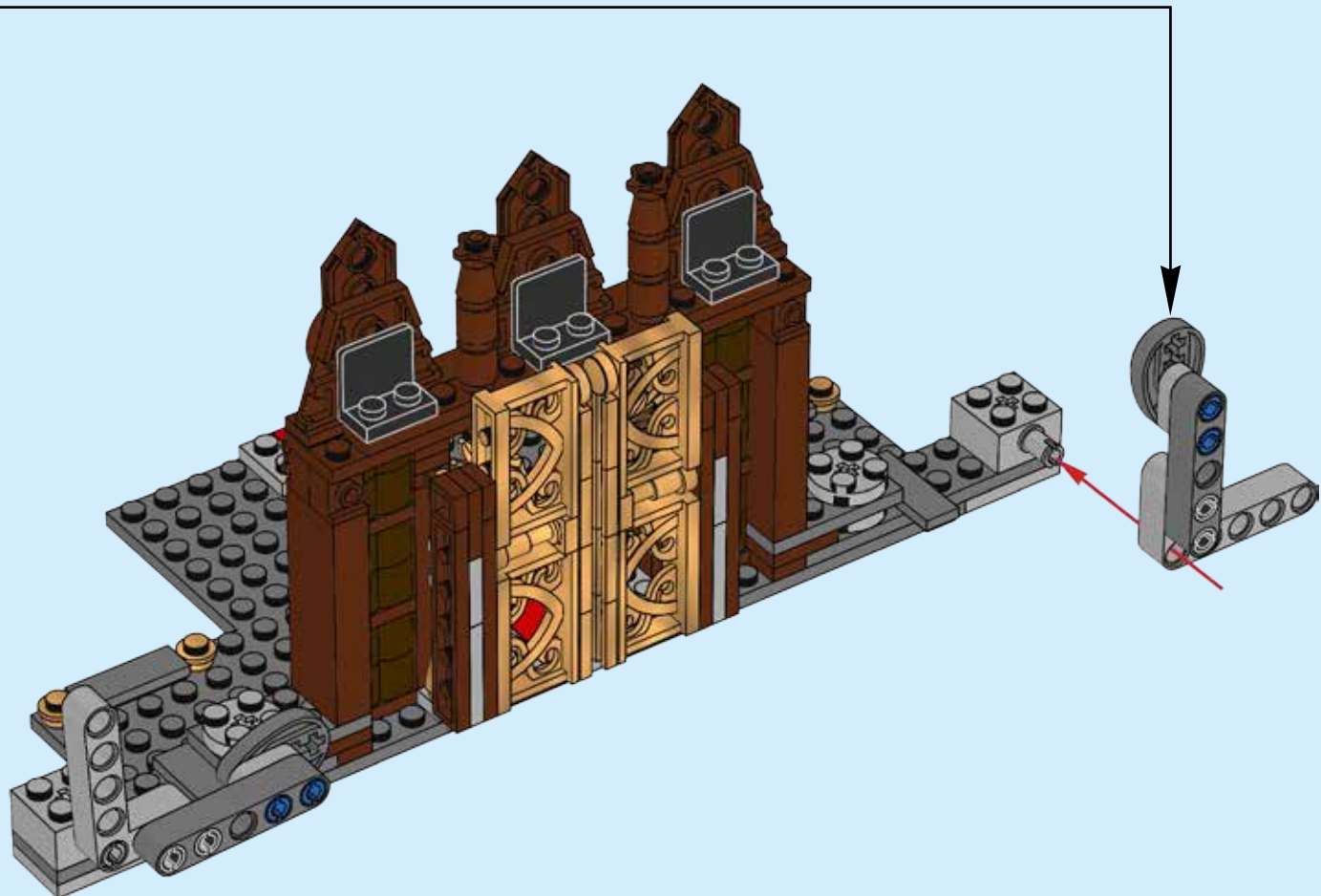

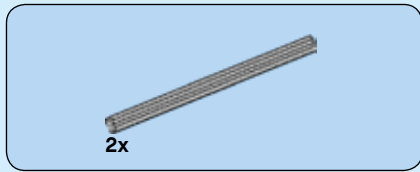

54



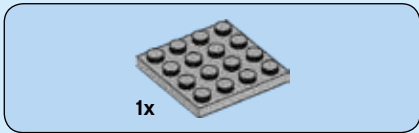

55

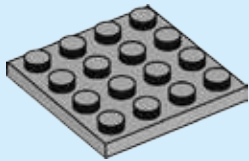

56



57

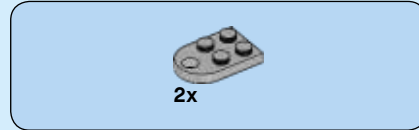

58

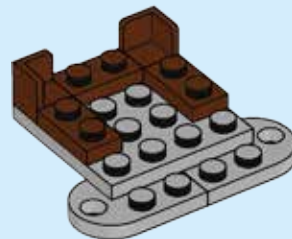



2x

59



2x

60

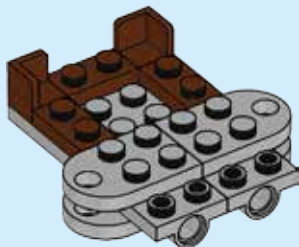

1x

61

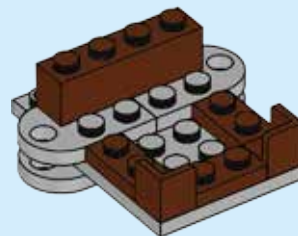

1x

62

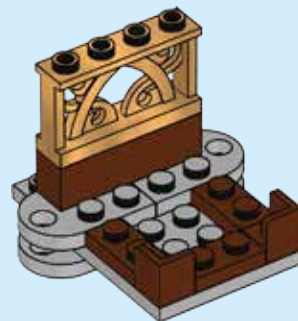

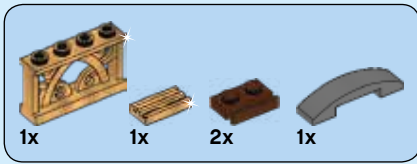

63

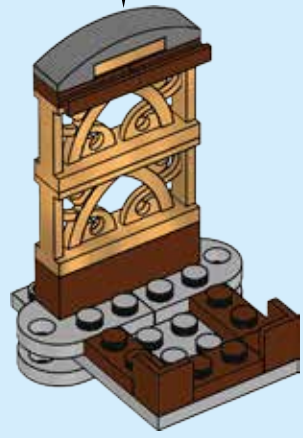
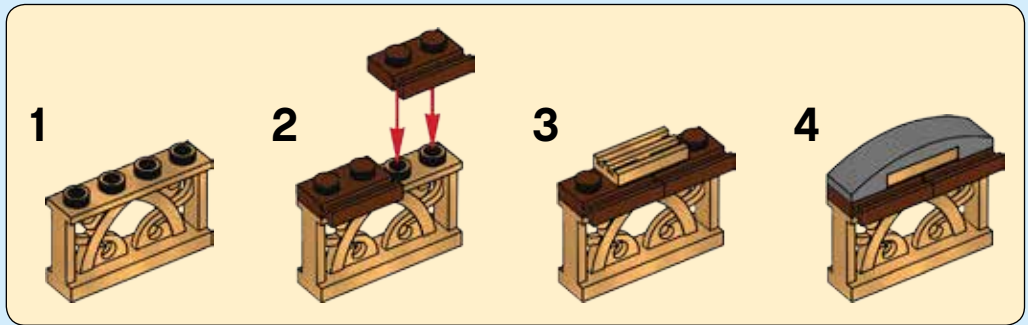

2x

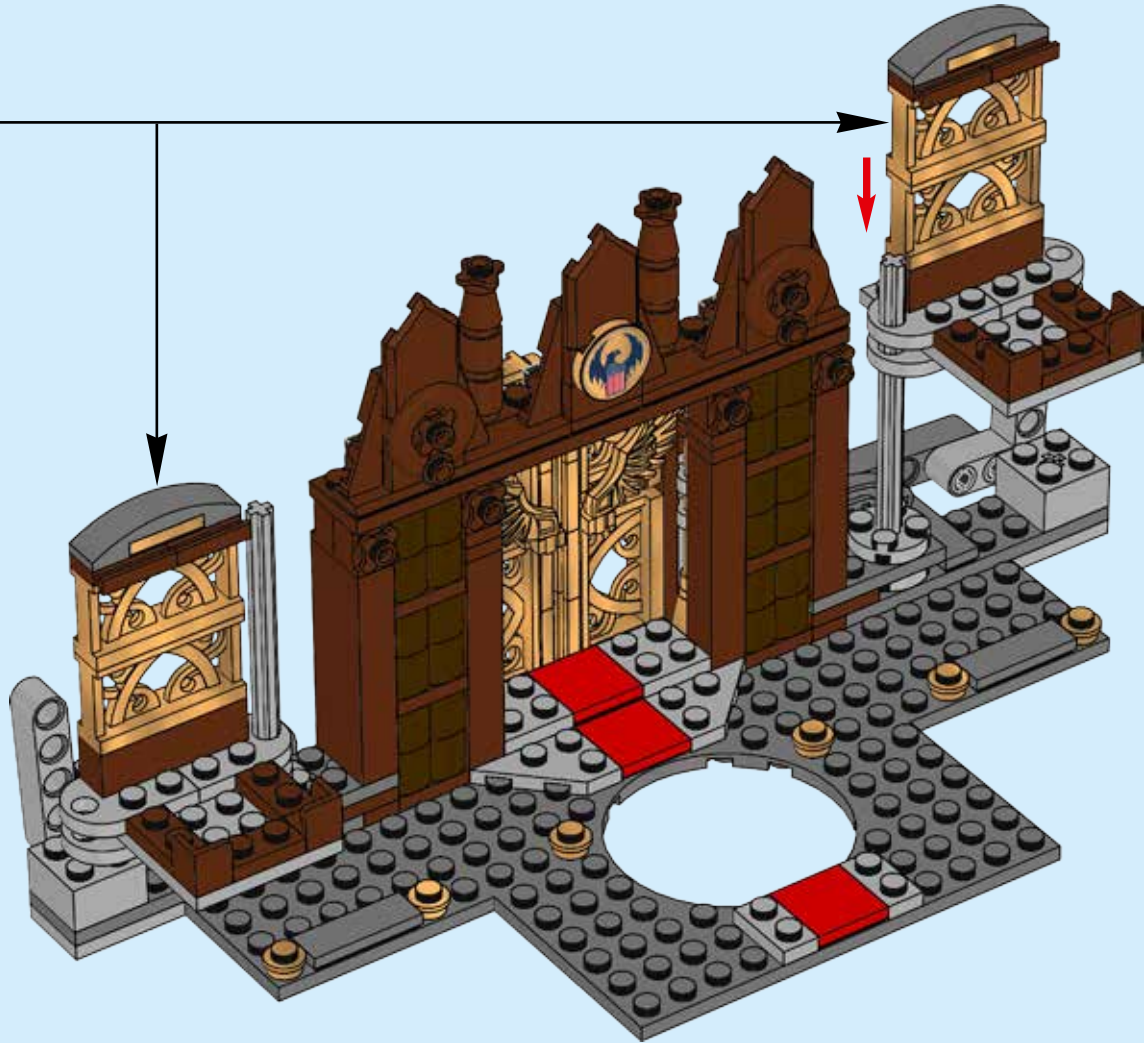

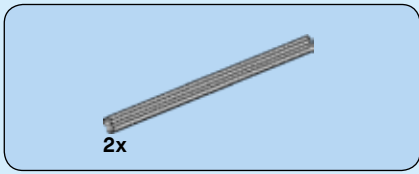

65

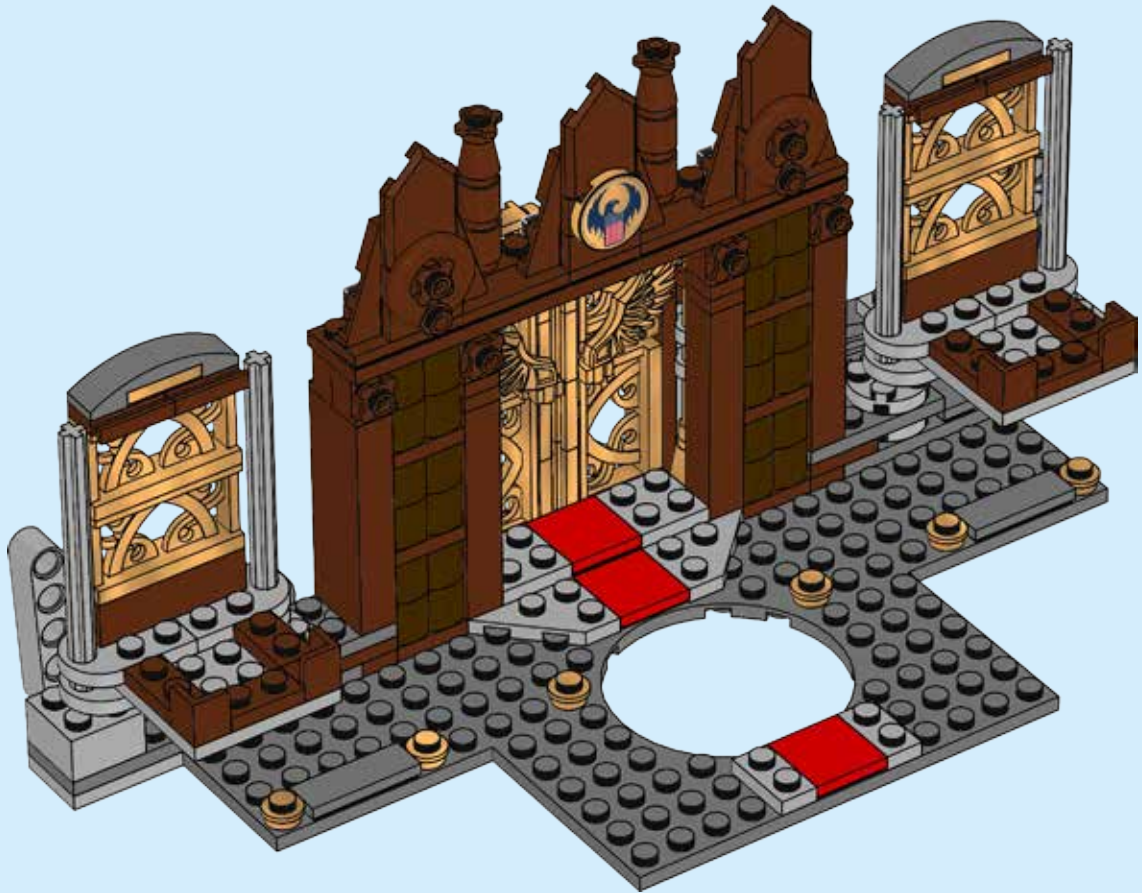

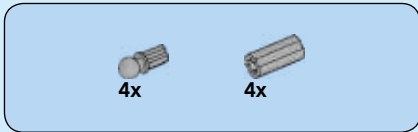

66

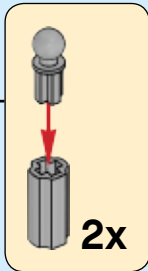
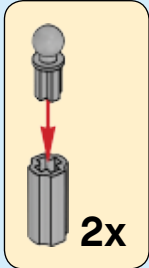

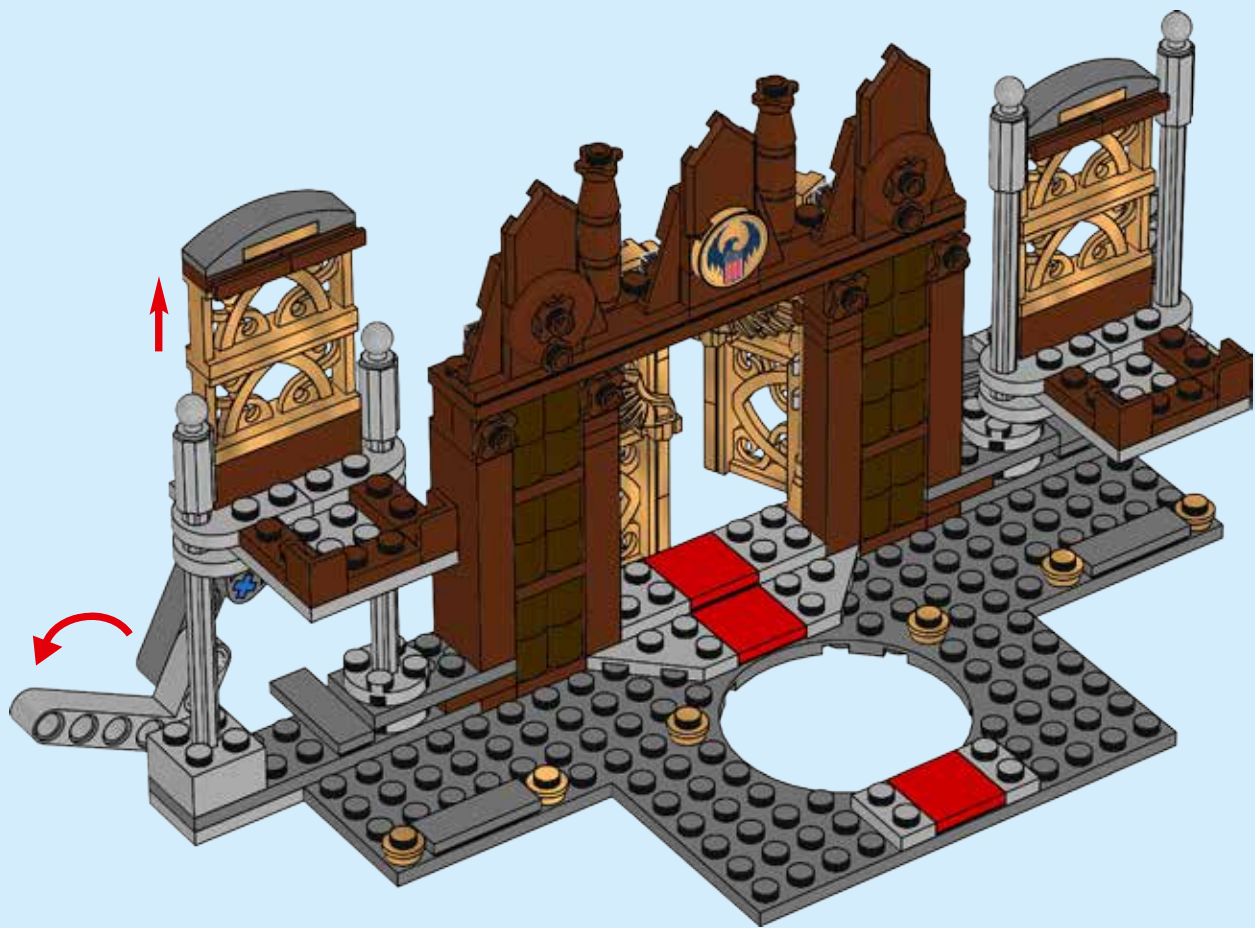

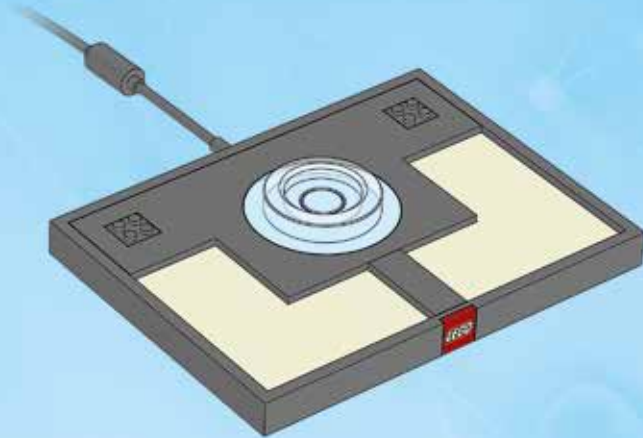

Download the latest game content to use this character

Télécharge le contenu le plus récent du jeu pour utiliser ce personnage

Descarga la última actualización de contenido para usar este personaje

**Start game
Commence le jeu
Iniciar juego**

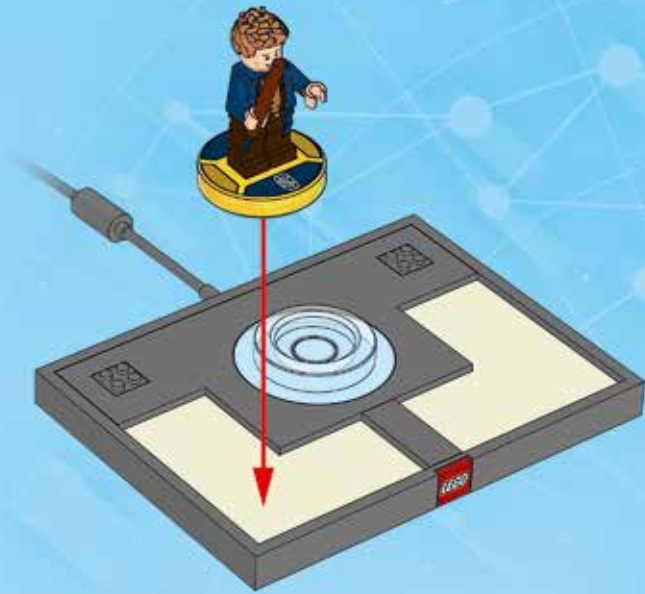



- **Building is part of playing the game**
- **La construction fait partie du déroulement du jeu**
- **Construir forma parte del juego**



DIMENSIONS™

FUN PACKS
ENSEMBLES AMUSANTS
PACKS DE DIVERSIÓN



71233



71236



71237



71239



71240



71241



71251



71257



71258



DIMENSIONS™

LEVEL PACKS
ENSEMBLES NIVEAUX
PACKS DE NIVELES



71245



71244



71248



DIMENSIONS

TEAM PACKS
ENSEMBLES ÉQUIPES
PACKS DE EQUIPOS

ADVENTURE TIME



71246



DIMENSIONS™

TEAM PACKS
ENSEMBLES ÉQUIPES
PACKS DE EQUIPOS

Harry Potter™



71247



DIMENSIONS

TEAM PACKS
ENSEMBLES ÉQUIPES
PACKS DE EQUIPOS

GREMLINS



71256

GHOSTBUSTERS™



71242



DIMENSIONS™

STORY PACKS
PACKS D'HISTOIRE
PAQUETES DE HISTORIA

FROM J.K. ROWLING'S
WIZARDING WORLD
**FANTASTIC
BEASTS**
AND WHERE
TO FIND THEM



71253



4x
6053077



2x
6020193



4x
6045988



4x
4211375



2x
6163332



1x
614126



3x
6000650



2x
4211429



2x
4211741



3x
6163191



2x
4558954



3x
306821



2x
4211529



4x
4211475



1x
611644



2x
307026



3x
306821



8x
4211419



1x
4657459



1x
6157593



2x
4517925



4x
4206482



2x
4211396



2x
4210759



2x
6079000



4x
4121715



4x
4512360



2x
4211361



4x
4568734



1x
6170143



2x
609126



2x
4211398



2x
4211713



2x
4648256



12x
4519970



2x
6047276



2x
4556157



1x
4211498



2x
4227398



1x
6163633



6x
302326



2x
4211397



1x
4211498



2x
4210686



1x
6162768



1x
6132731



2x
4243797



4x
4535768



2x
4210997



1x
6163938



1x
6163945



2x
4523160



1x
6164126



10x
4490599



2x
6092594



2x
4538126



2x
6097514



8x
6097234



2x
6081992



11x
4523159



2x
4529247



2x
4649422



4x
4211183



2x
4529242



8x
4623429



6x
4225469



4x
4645400



6x
4221744



2x
6066142



2x
4226966



2x
4277016



5x
6092590



20x
4211150



2x
4211151



2x
6132812



4x
4645103



1x
6075208



2x
4216695



3x
6163184



2x
4211225



3x
4649052



2x
4211204



4x
4221590



1x
6055145



1x
6004996

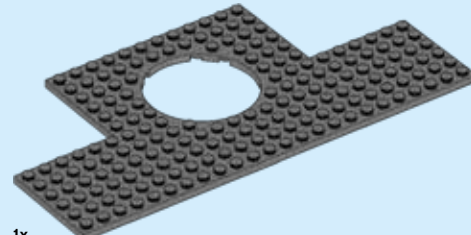

1x
6117642



Customer Service
Service Consommateurs
Servicio Al Consumidor
LEGO.com/DIMENSIONS/service

CHEAT CODES

GO TO LEGO.COM/DIMENSIONSfeedback AND
GIVE US YOUR SHORT **FEEDBACK** ABOUT THIS
LEGO® VIDEO GAME TO UNLOCK
AWESOME CHEAT CODES.



Terms & Conditions apply

LEGO.com/DIMENSIONSfeedback

GEHEIM-CODES

Geh auf LEGO.com/DIMENSIONSfeedback und verrate uns deine Meinung zu diesem LEGO® Videospiel, um tolle Geheim-Codes freizuschalten.

Es gelten die Nutzungsbedingungen.

COUPS DE POUCE

Rendez-vous sur LEGO.com/DIMENSIONSfeedback pour évaluer ce jeu vidéo LEGO® et débloquent de super coups de pouce !

Offre soumise à conditions.

CHEATCODES

Ga naar LEGO.com/DIMENSIONSfeedback, schrijf een kort commentaar op deze LEGO® video game en ontvang coole cheatcodes.

Er zijn algemene voorwaarden van toepassing.

CÓDIGOS DE TRUCOS

Visita LEGO.com/DIMENSIONSfeedback y envíanos una breve opinión sobre este videojuego LEGO® para desbloquear asombrosos códigos de trucos.

Sujeto a términos y condiciones.

LEGO and the LEGO logo are trademarks of the/son des marques de commerce du/son marcas registradas de LEGO Group. ©2016 The LEGO Group.