



# STAR WARS™

75387



Q LEGO® Builder



LEGO.com/sustainable-packaging



FR  
**DONNEZ**  
OU  
**RECYCLEZ**



ASSOCIATION

OU



MAGASIN

OU



DÉCHÈTERIE

Adresses sur [quefairedemesdechets.fr](http://quefairedemesdechets.fr)

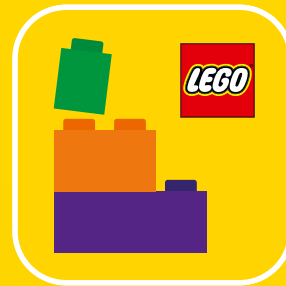

# BUILDER



Apple and the Apple logo are trademarks of Apple Inc., registered in the U.S. and other countries and regions. App Store is a service mark of Apple Inc. Google Play and the Google Play logo are trademarks of Google LLC. Tencent and the Tencent logo are trademarks of Tencent Inc.

LEGO.com/devicecheck

EN Ask parents' permission before going online | DE Eltern um Erlaubnis bitten, bevor du online gehst | FR Demande l'autorisation d'un parent avant d'aller en ligne | IT Chiedi il permesso ai tuoi genitori prima di andare online | ES Pídeles permiso a tus papás antes de conectarte a Internet | PT Peça autorização aos pais antes de acederes online | ZH 上网前应先征得父母的同意 | PL Poproś rodziców o zgodę, zanim wejdiesz do Internetu | CS Než půjdeš na internet, požádej rodiče o svolení | SK Skôr než pôjdeš na internet, vypýtaj si povolenie od rodičov | HU Kérj szülői engedélyt, mielőtt online csatlakoznál! | RO Cere permisiunea părinților înainte de a te conecta online | BG Поискайте разрешение от родител, преди да влезете онлайн | LV Pirms došanās tiešsaistē palūdz atļauju vecākiem | ET Enne Interneti kasutamist küsi vanematelt luba | LT Prieš prisijungdami prie interneto, atsklauskite tėvų

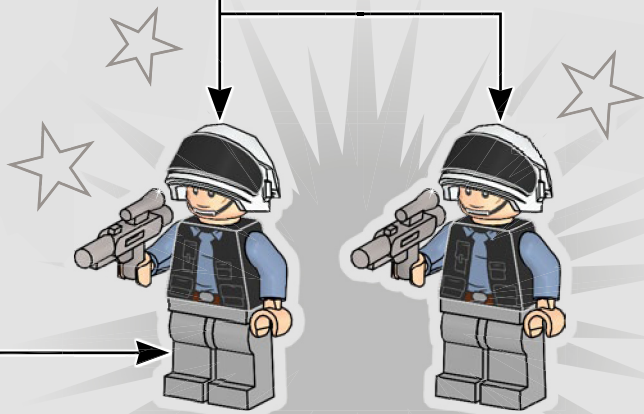
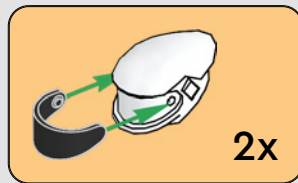
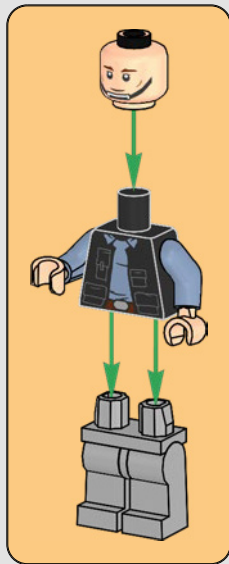

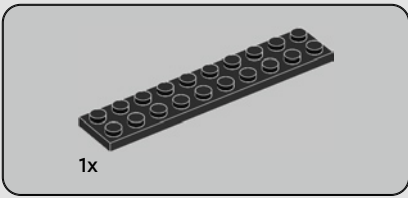

1

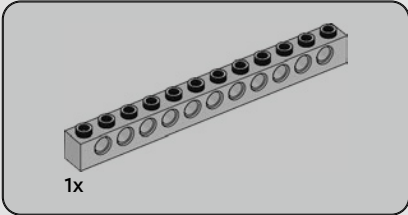
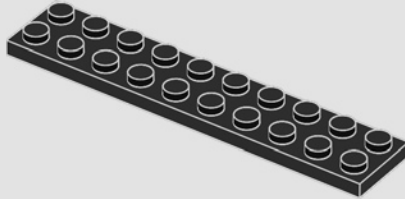

2

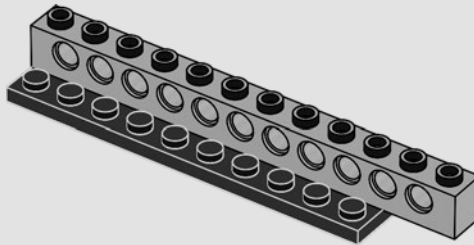

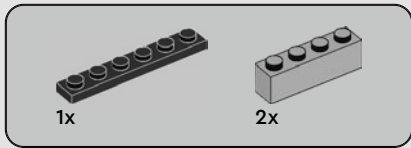

3

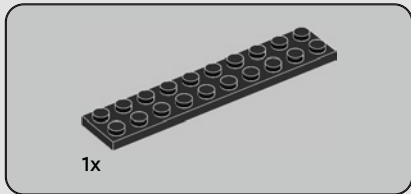
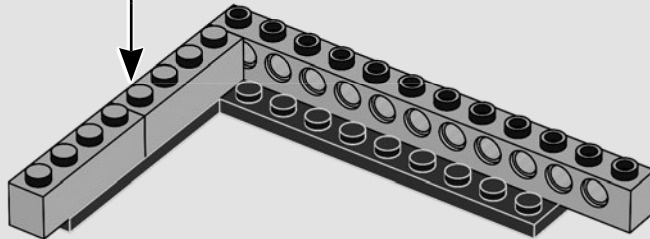
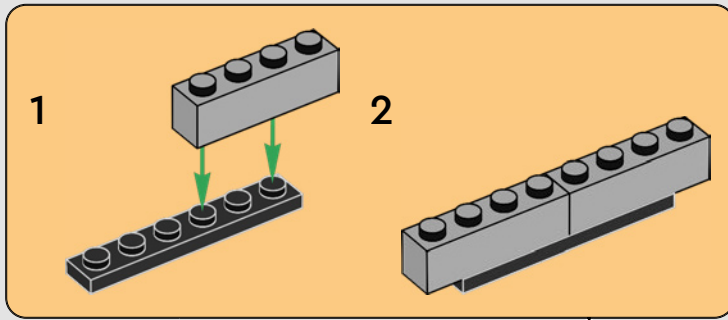

4

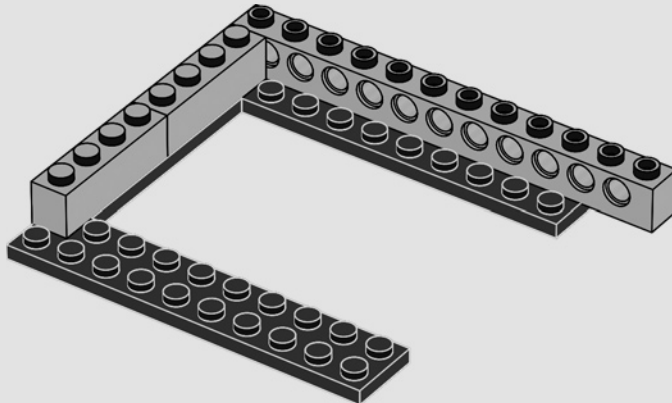

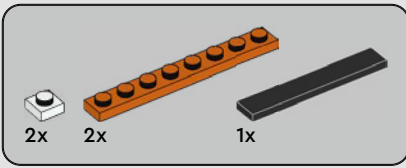

5

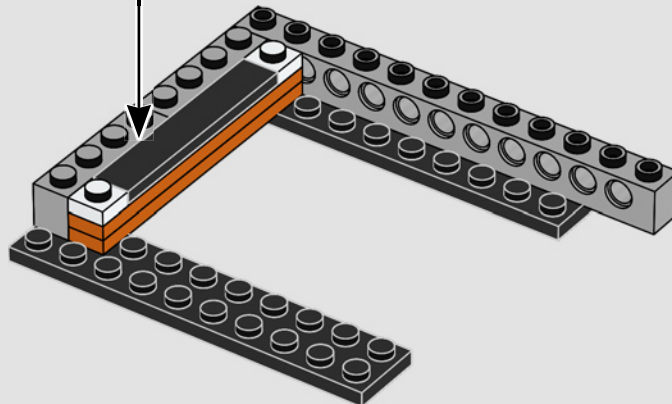
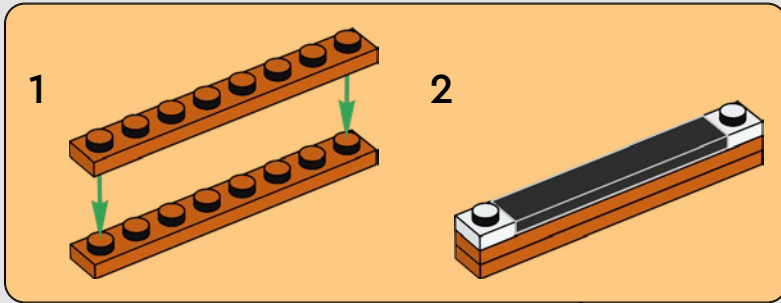

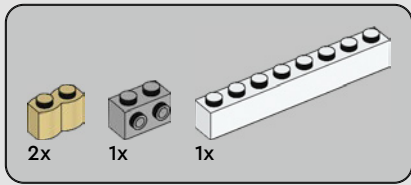

6

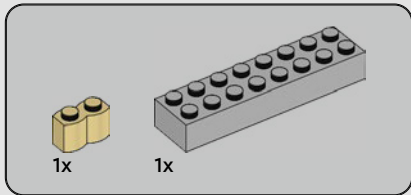
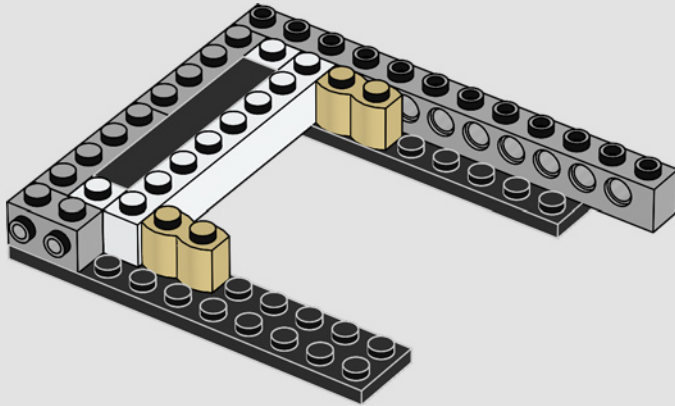

7

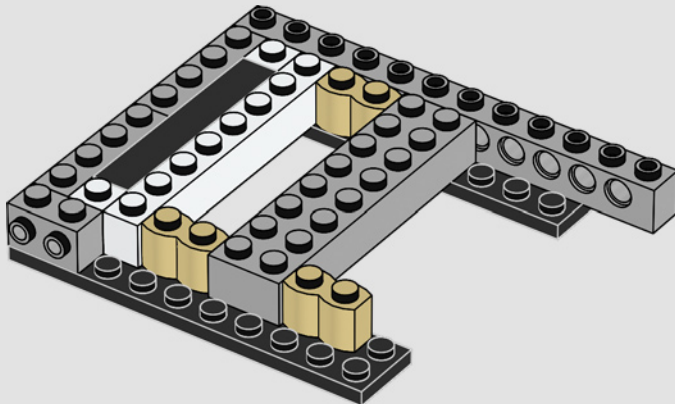



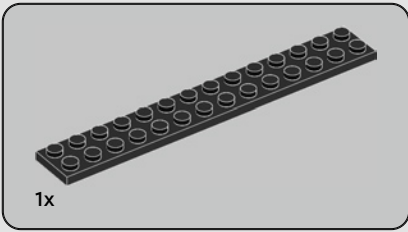

8

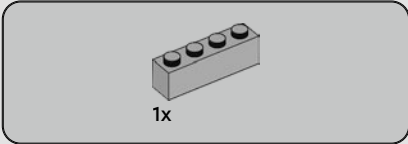
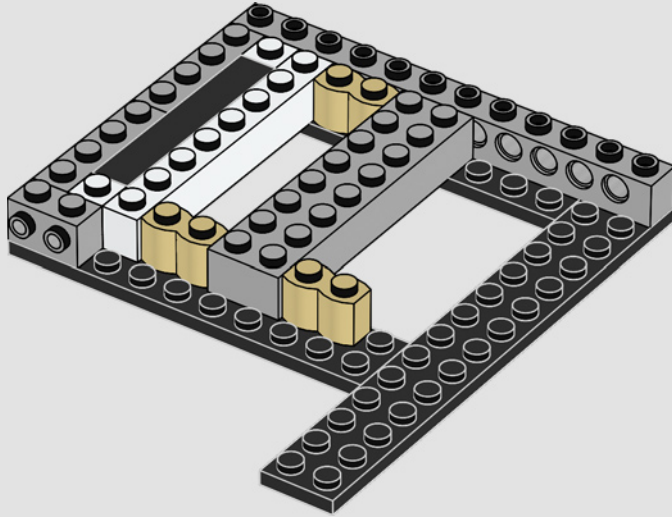

9

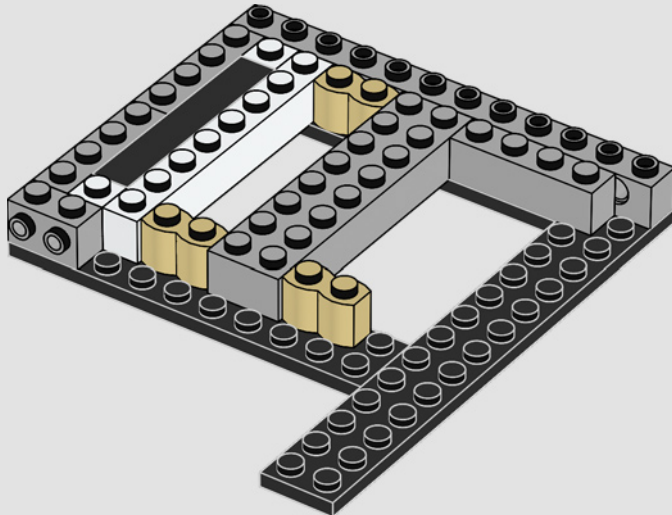

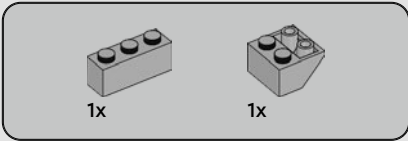

10

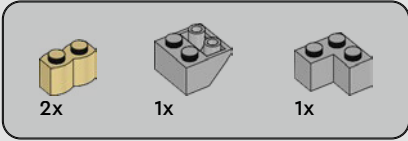
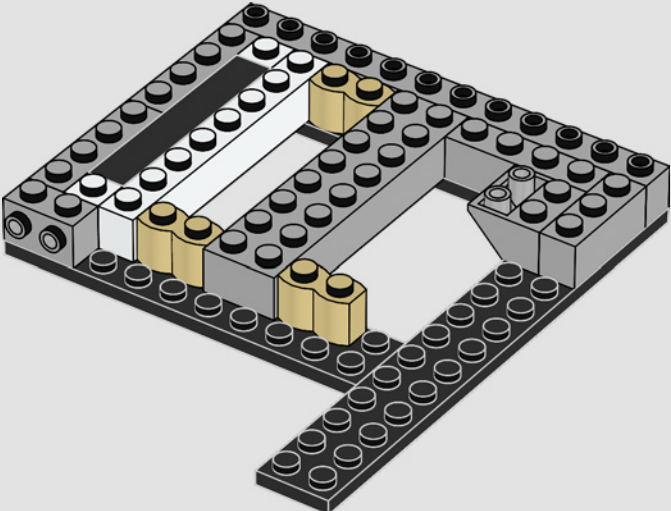

11

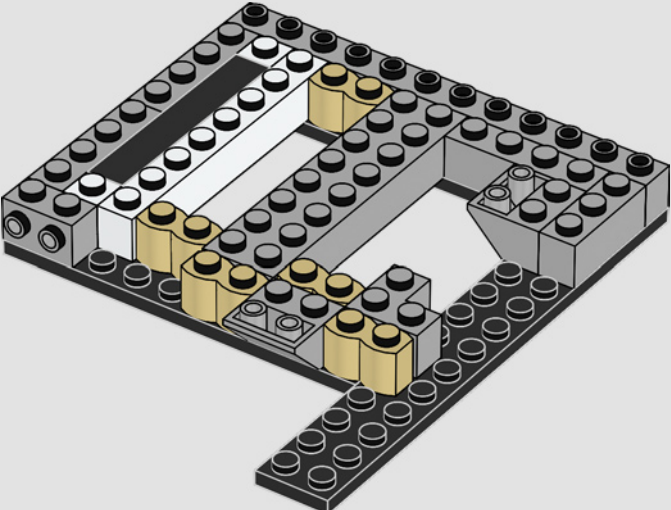

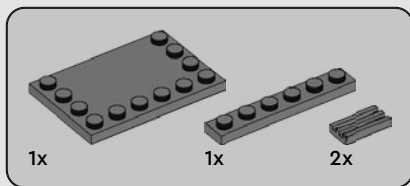

12

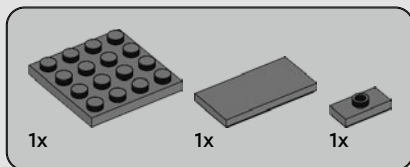
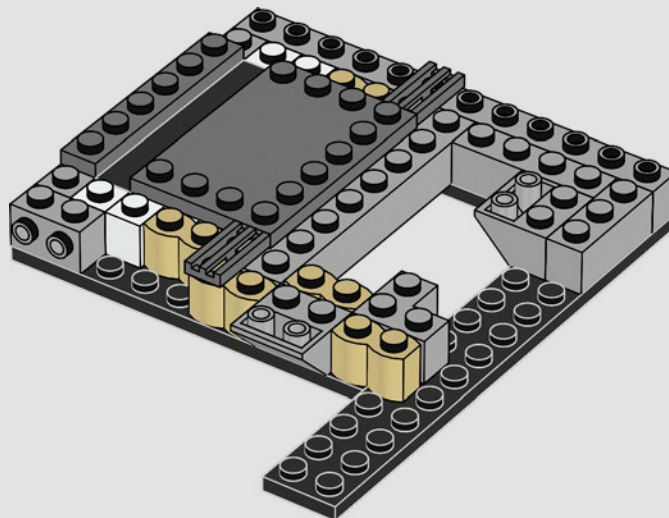

13

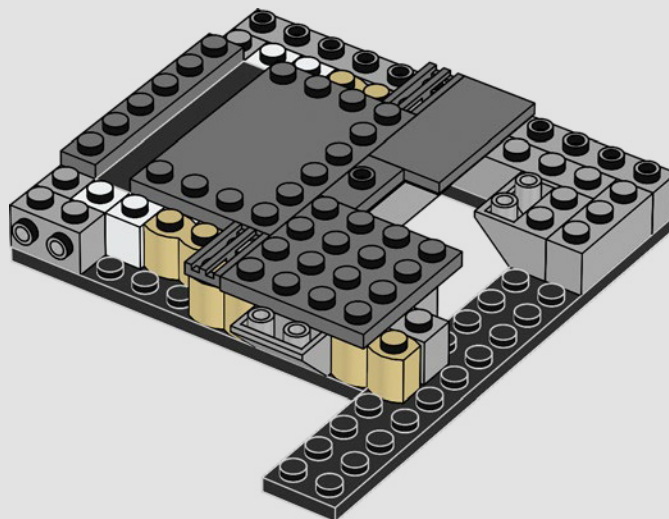

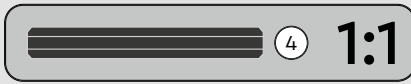
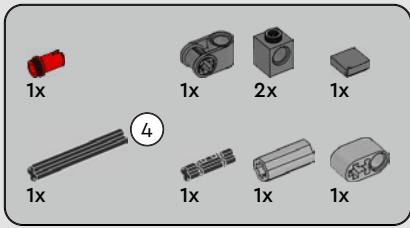

14

1

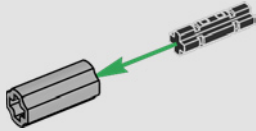

2

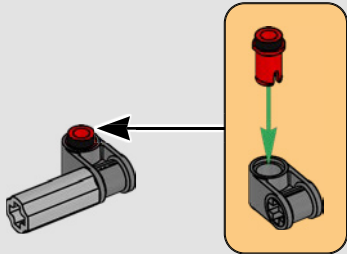

3

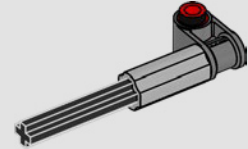

4

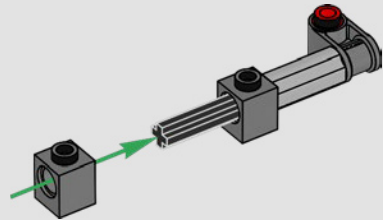

5

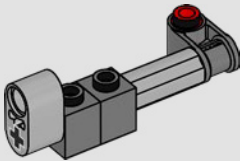

6

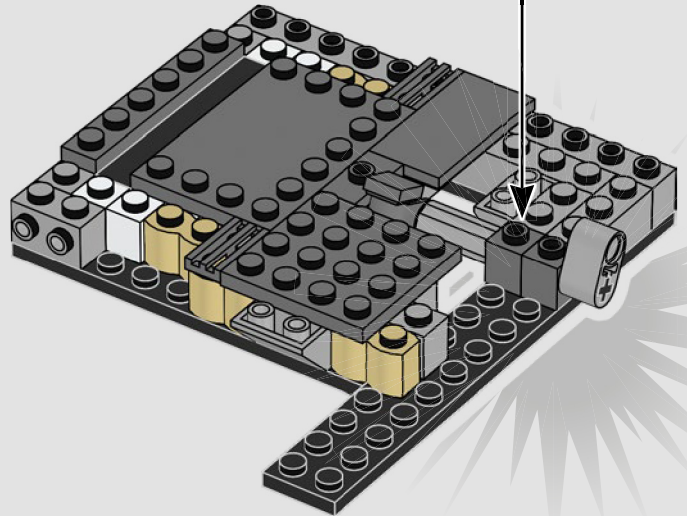
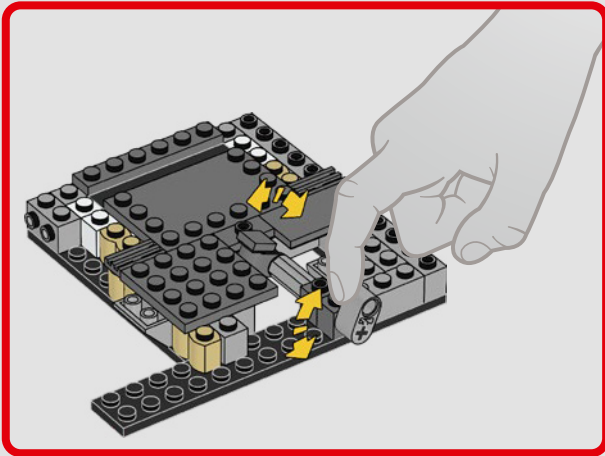
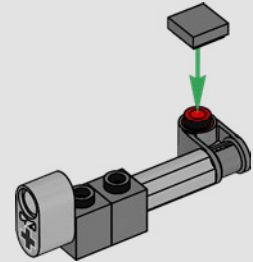

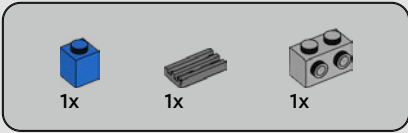

15

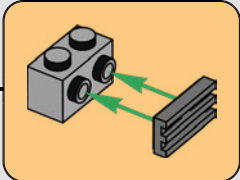
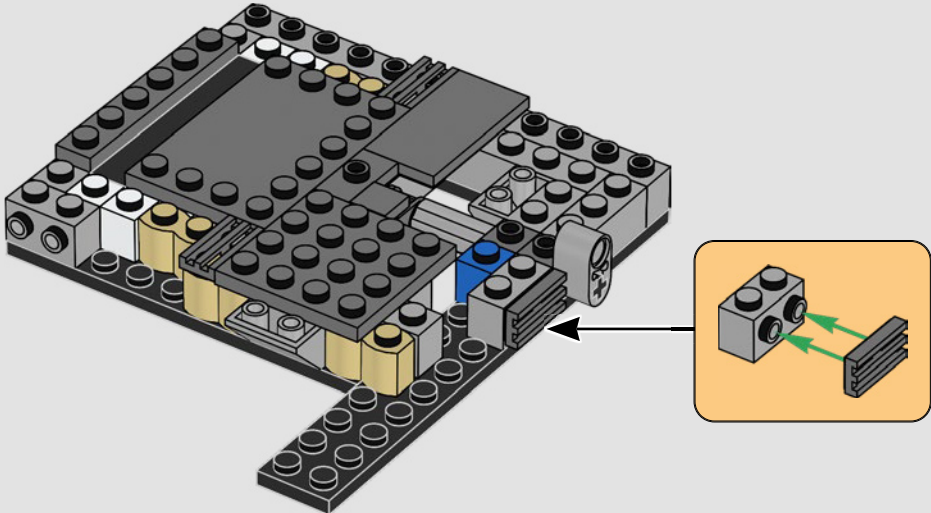

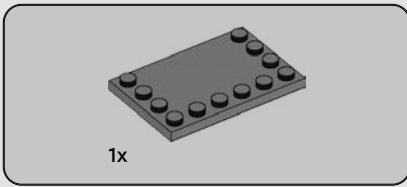

16

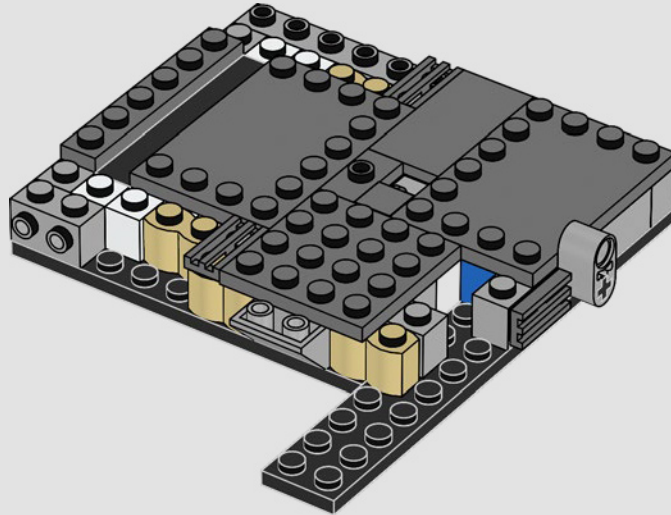

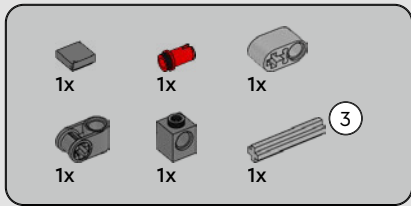

17

1



2

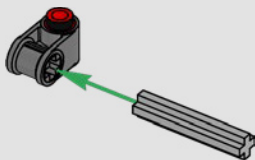

3

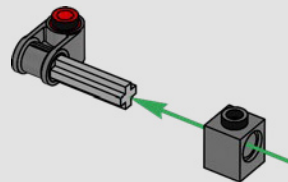

4

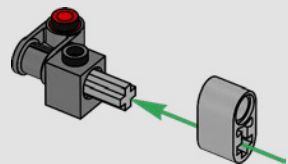

5

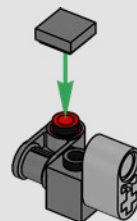



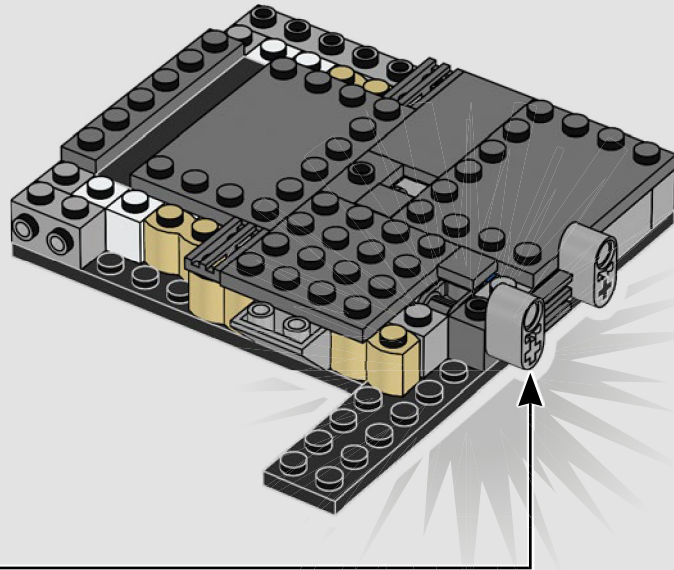
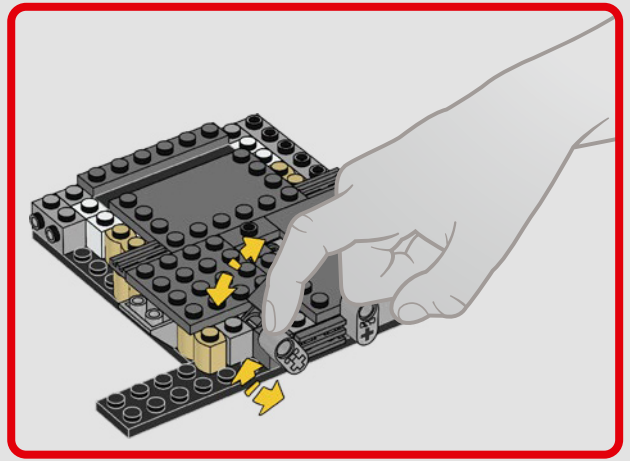

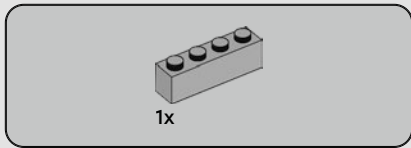

18

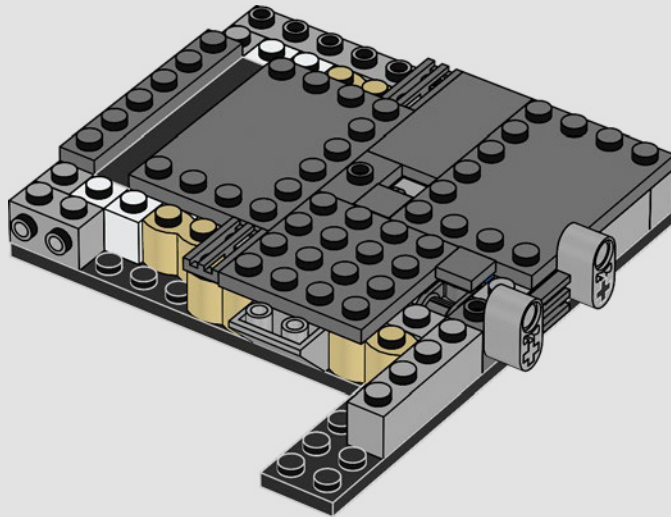

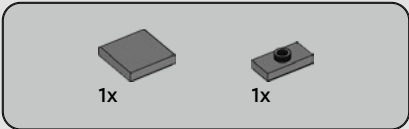

19

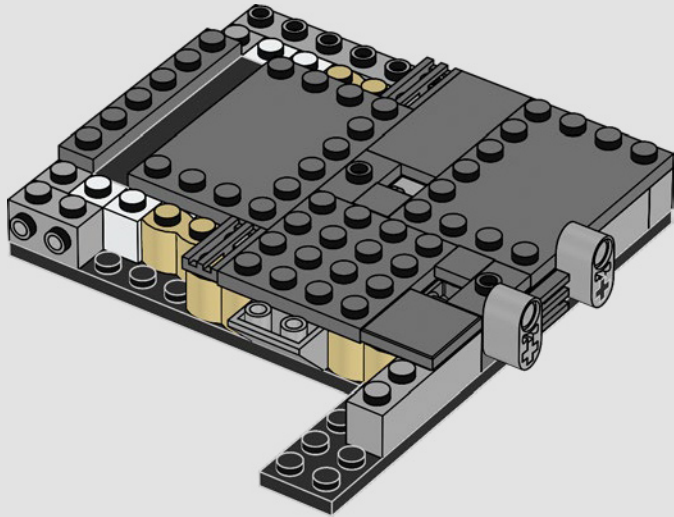

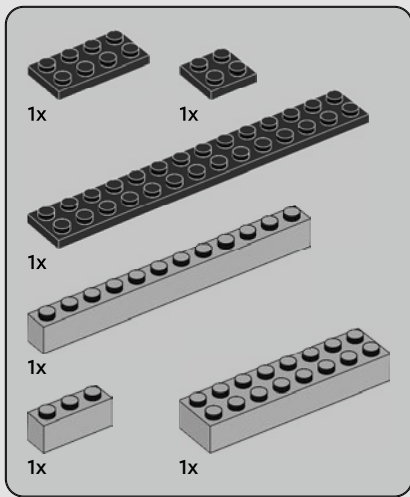

20

1

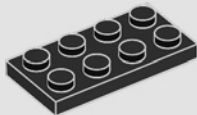

2

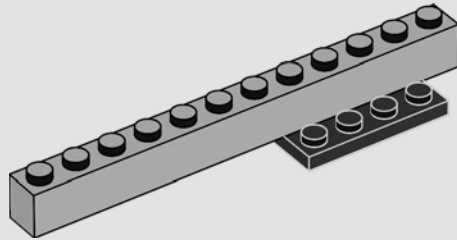

3

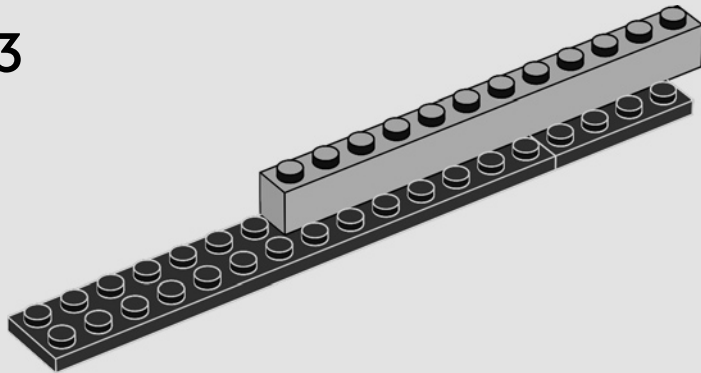

4

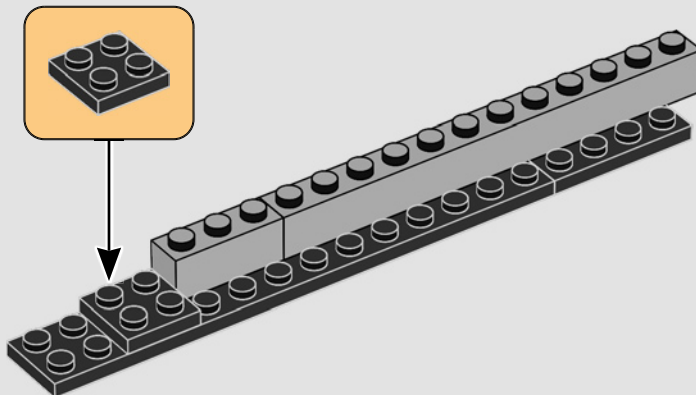

5

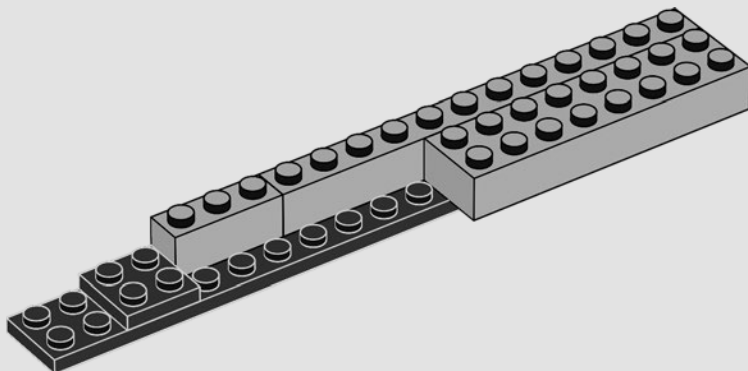

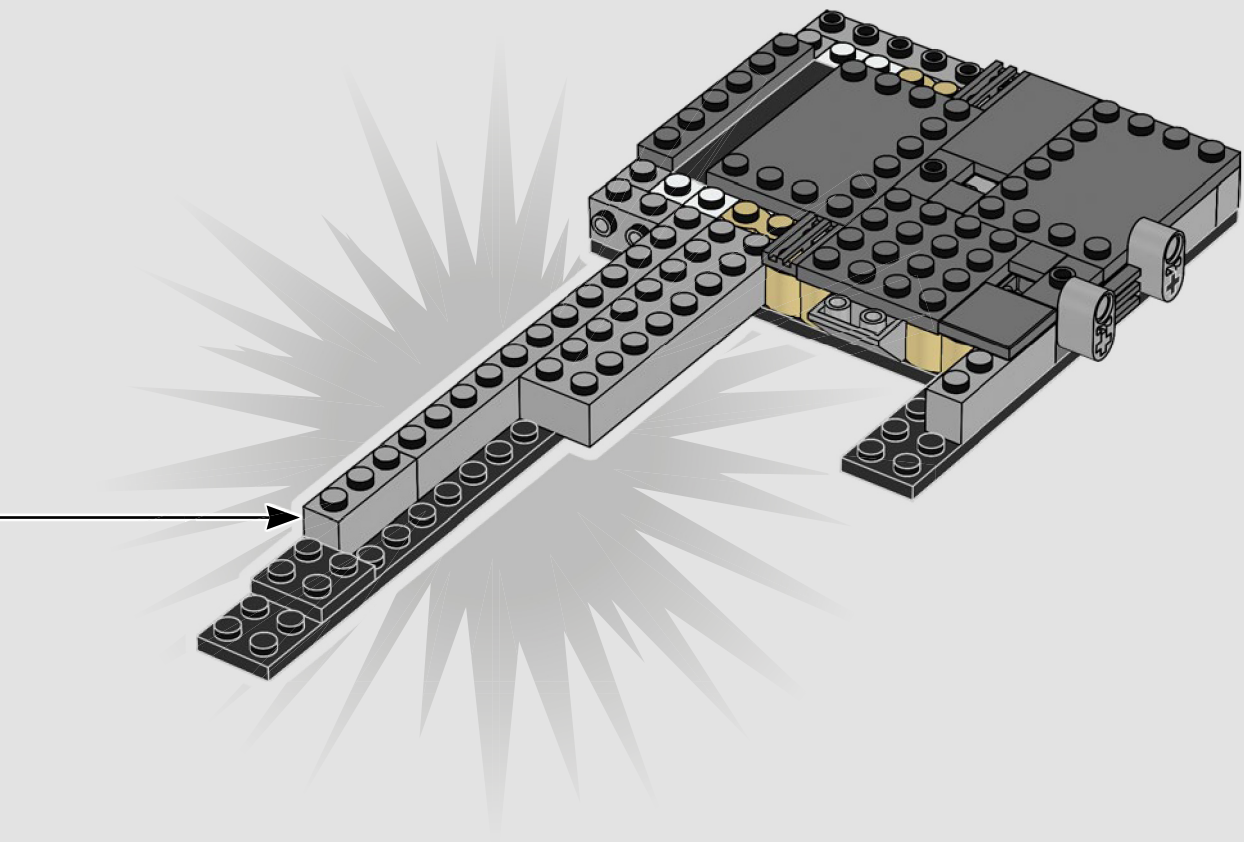

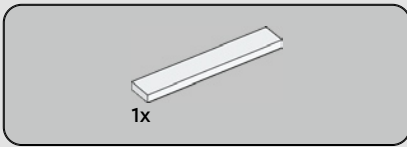

21

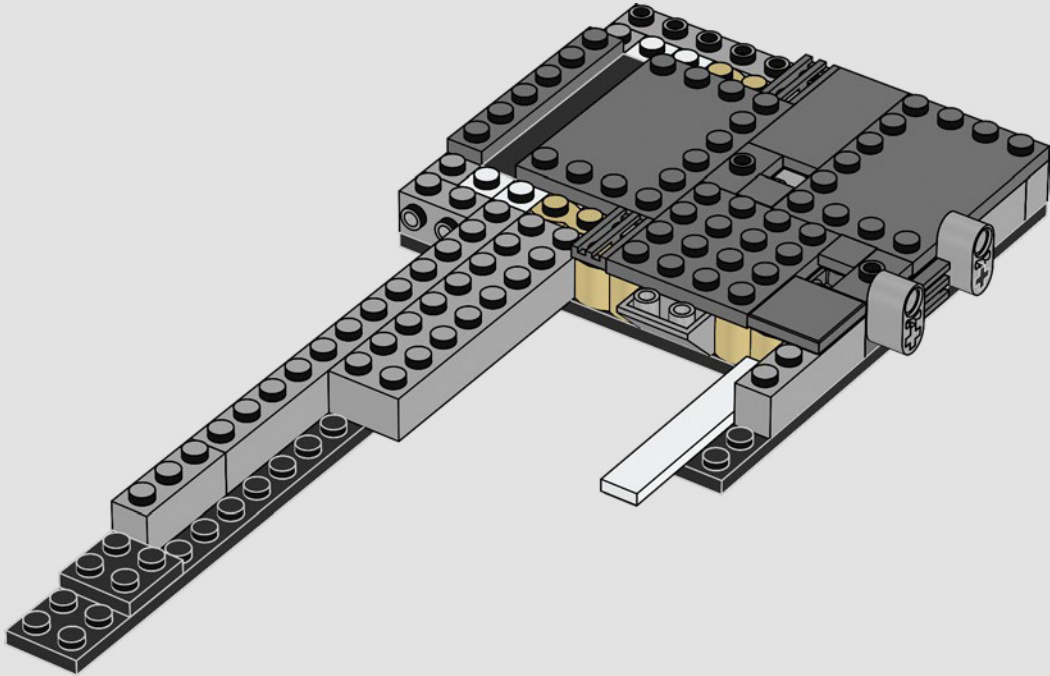

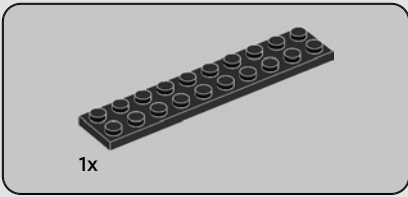

22

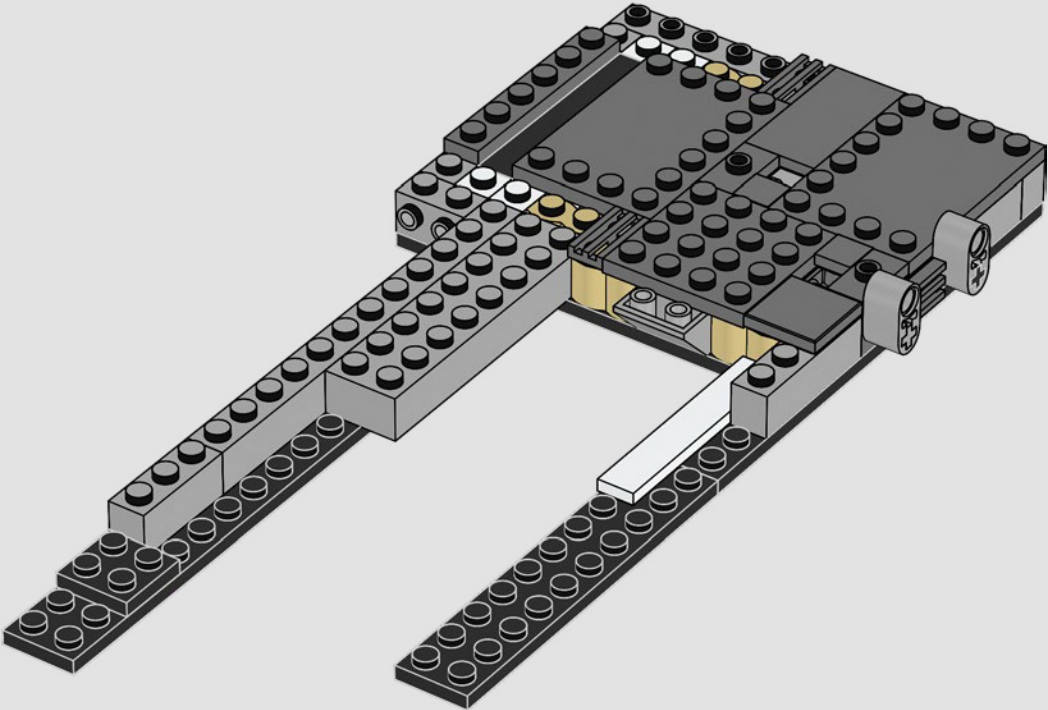



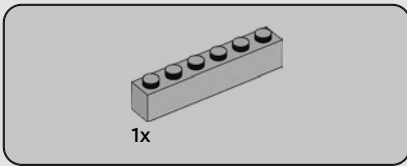

23

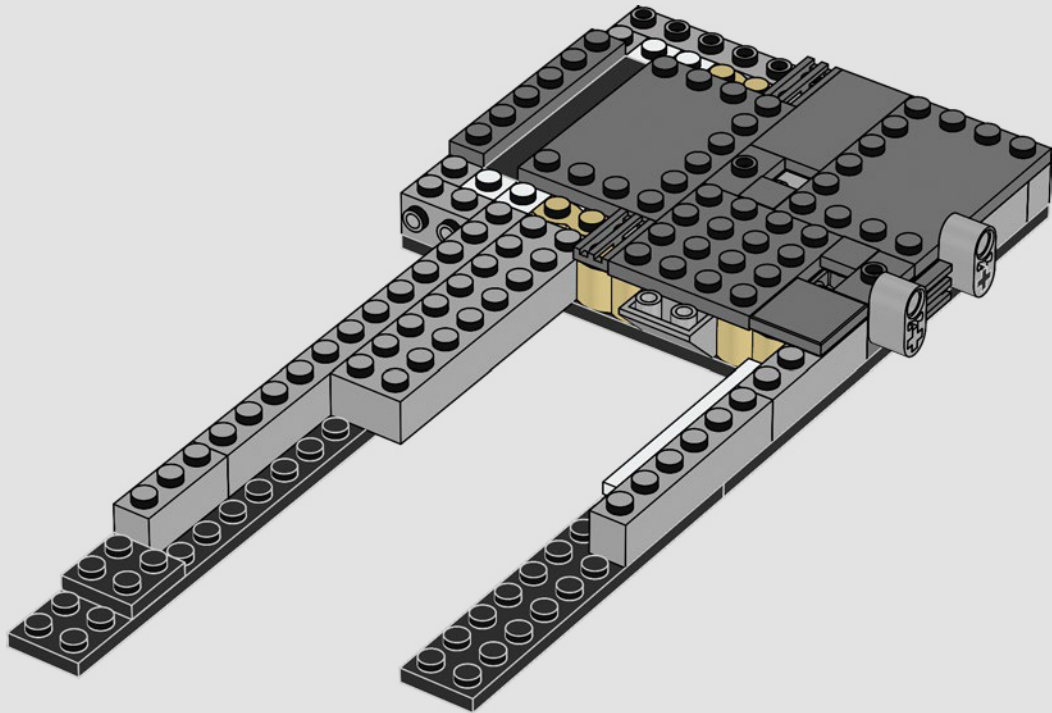

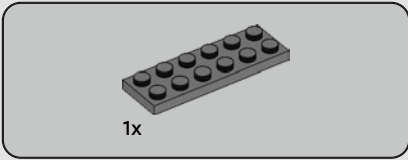

24

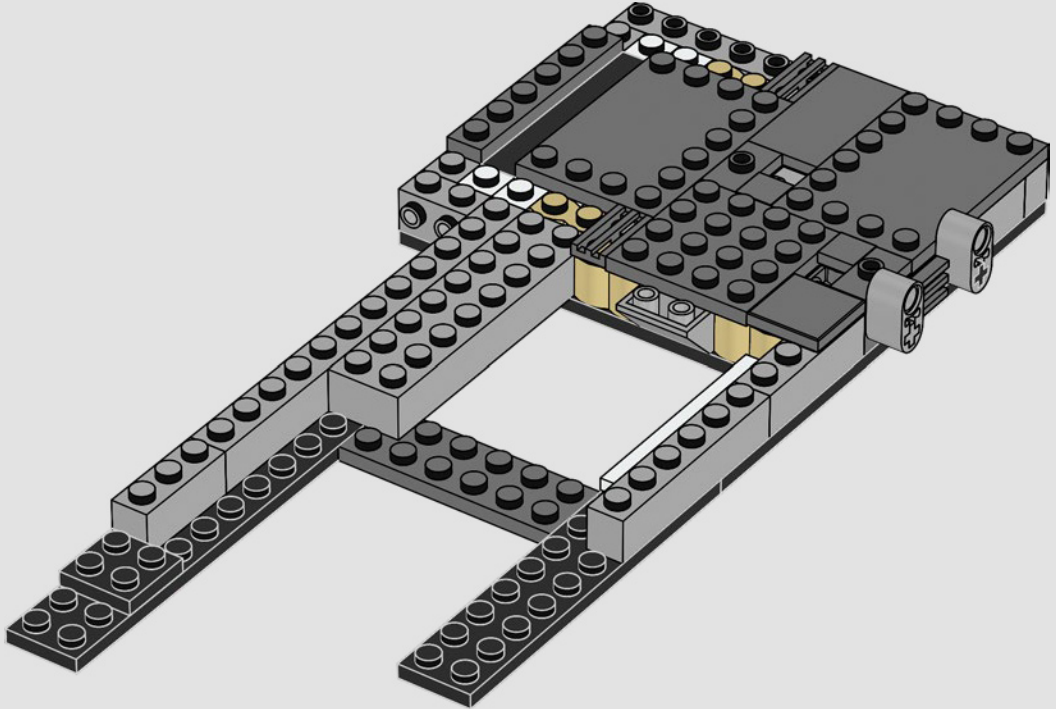



2x



1x

25

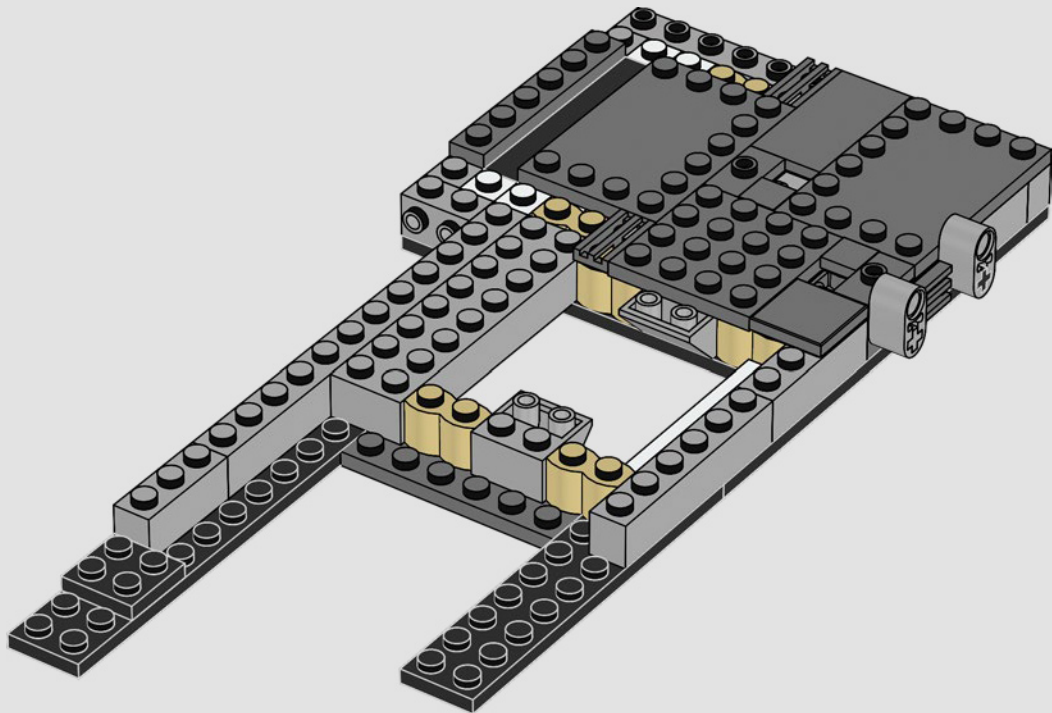

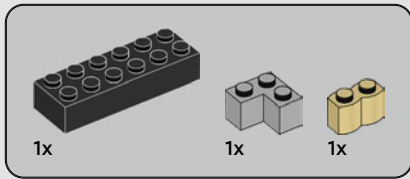

26

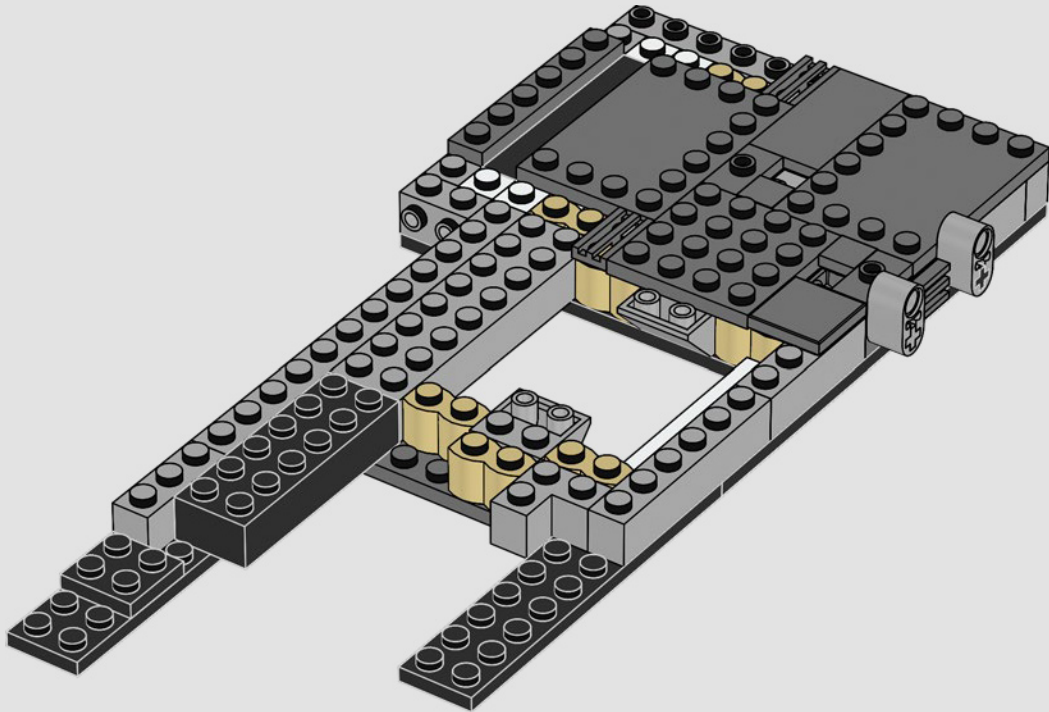

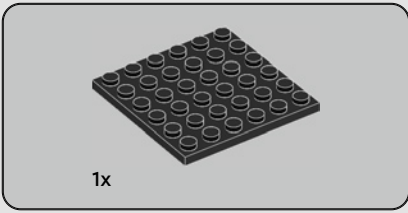

27

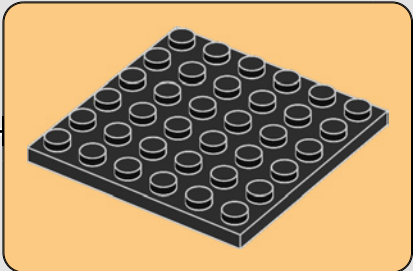
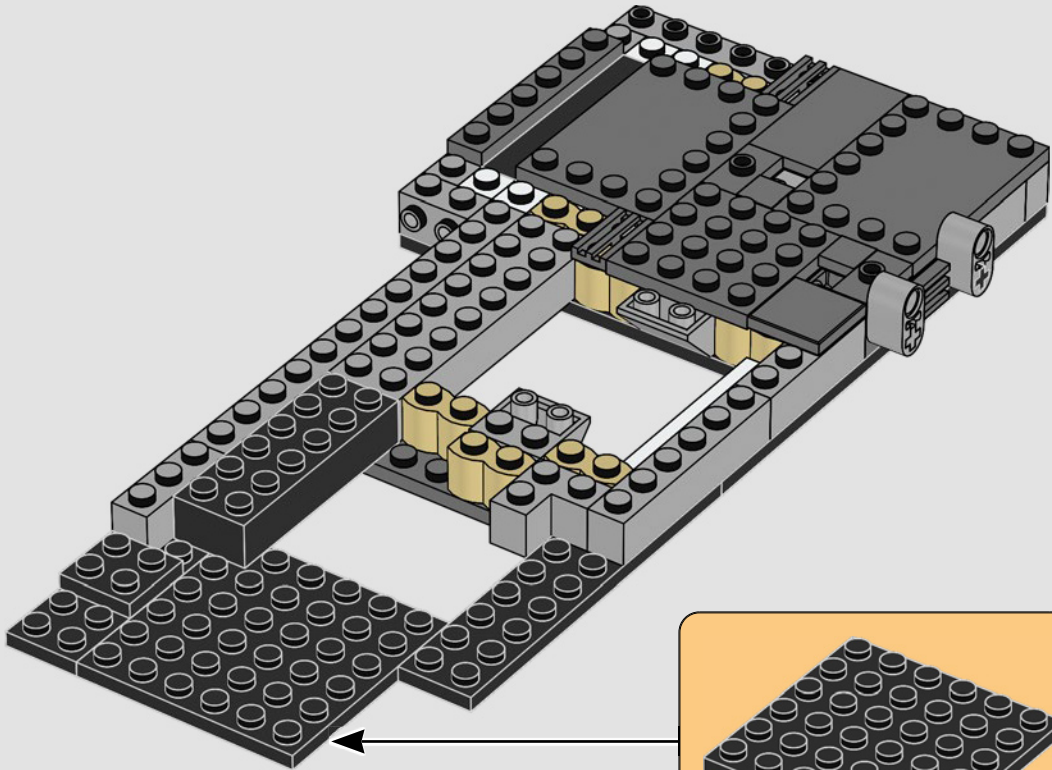

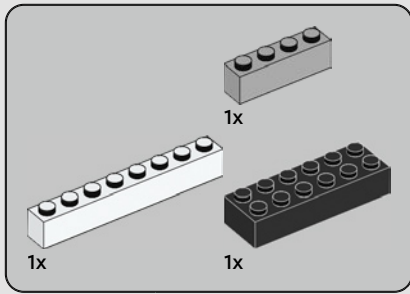

28

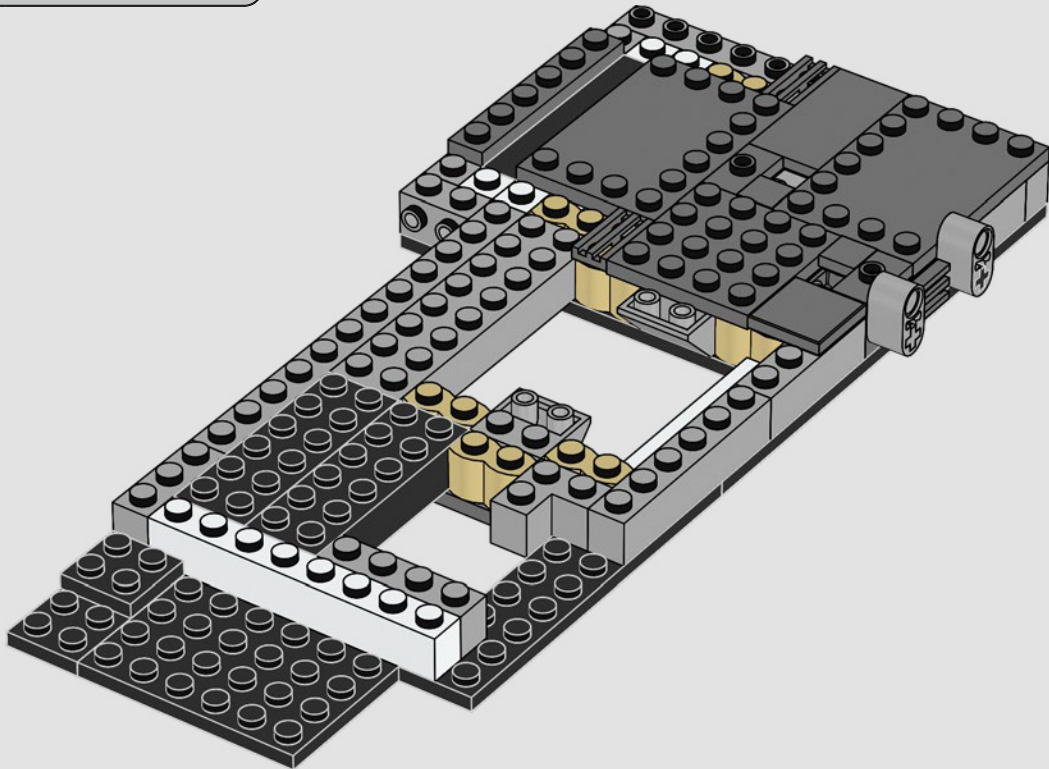

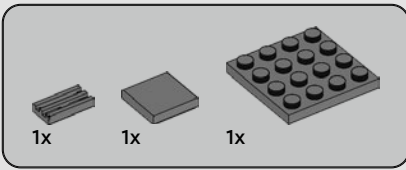

29

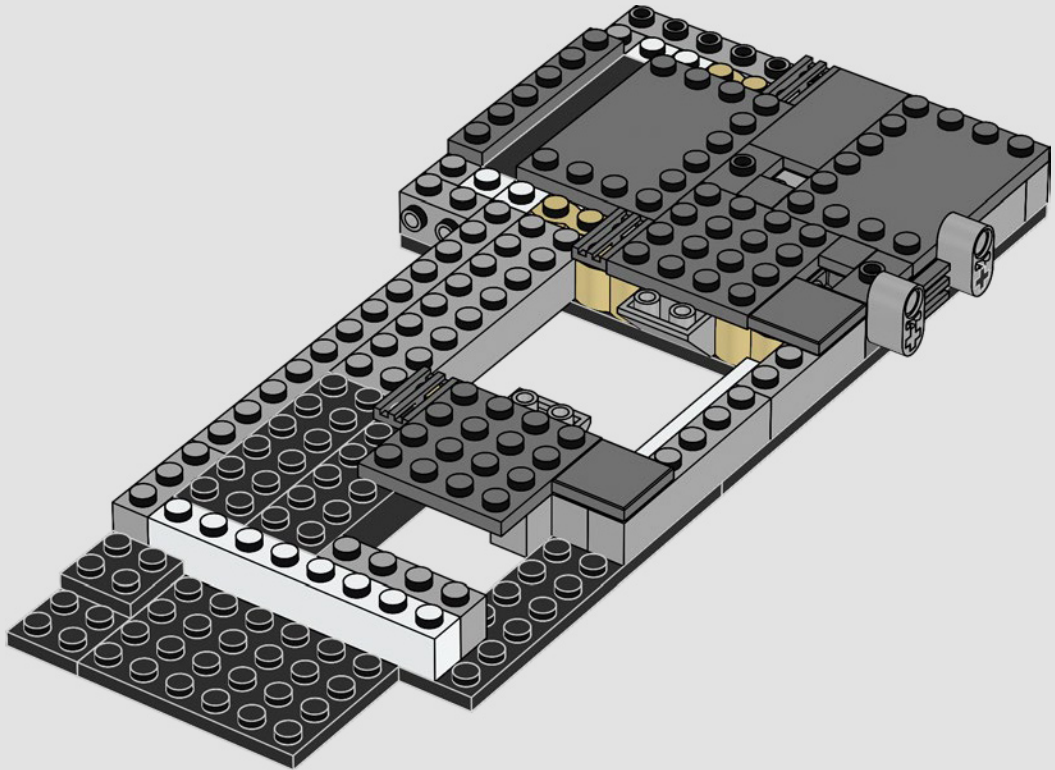

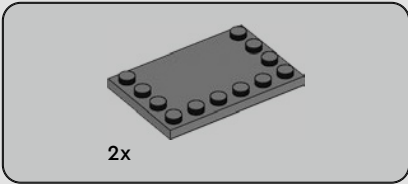

30

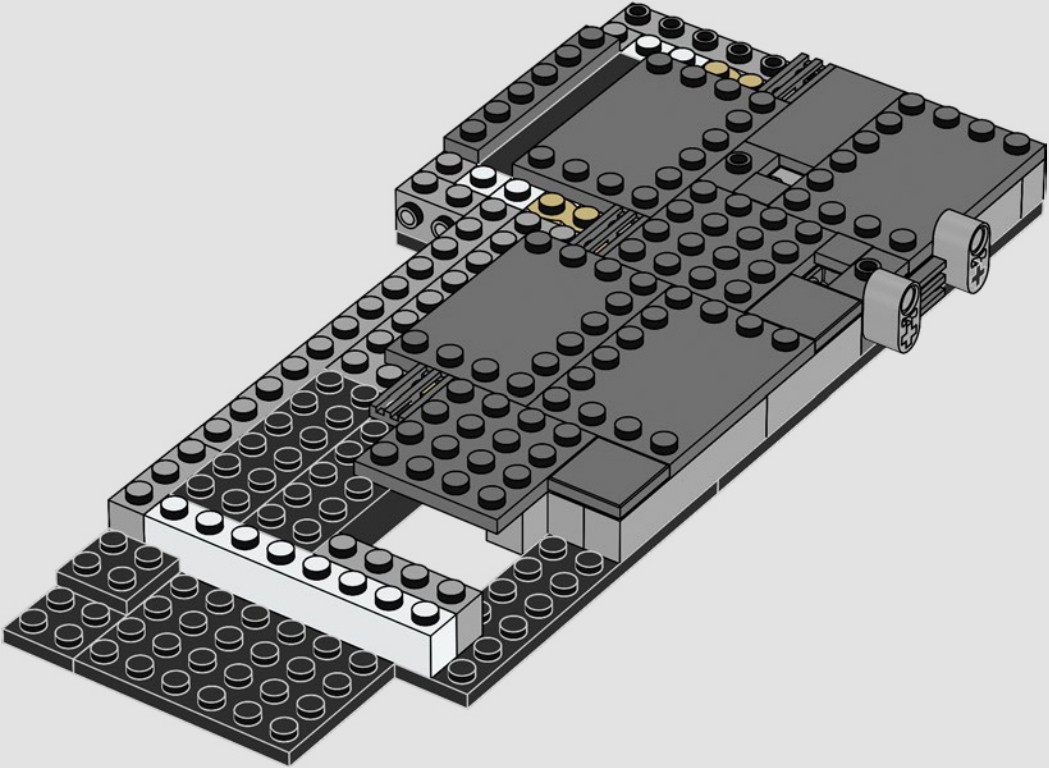



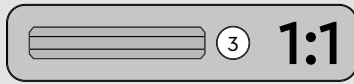
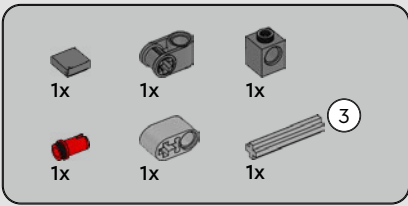

31

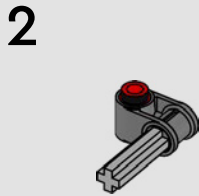
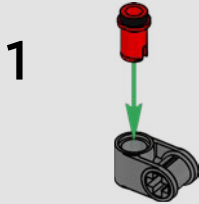

3

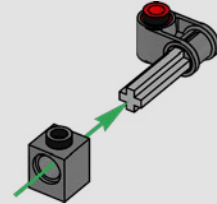

4

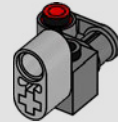

5

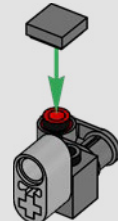

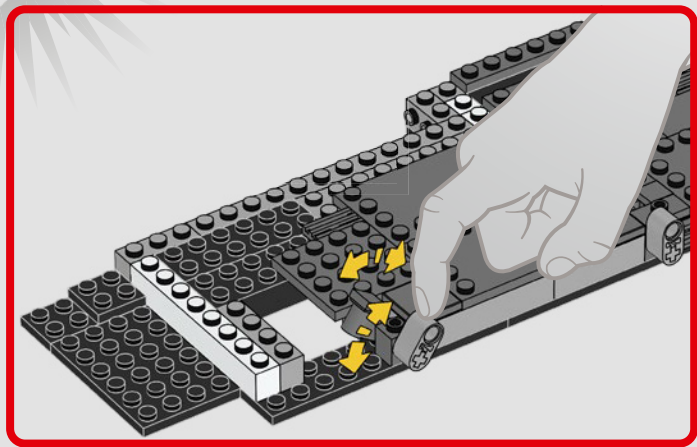
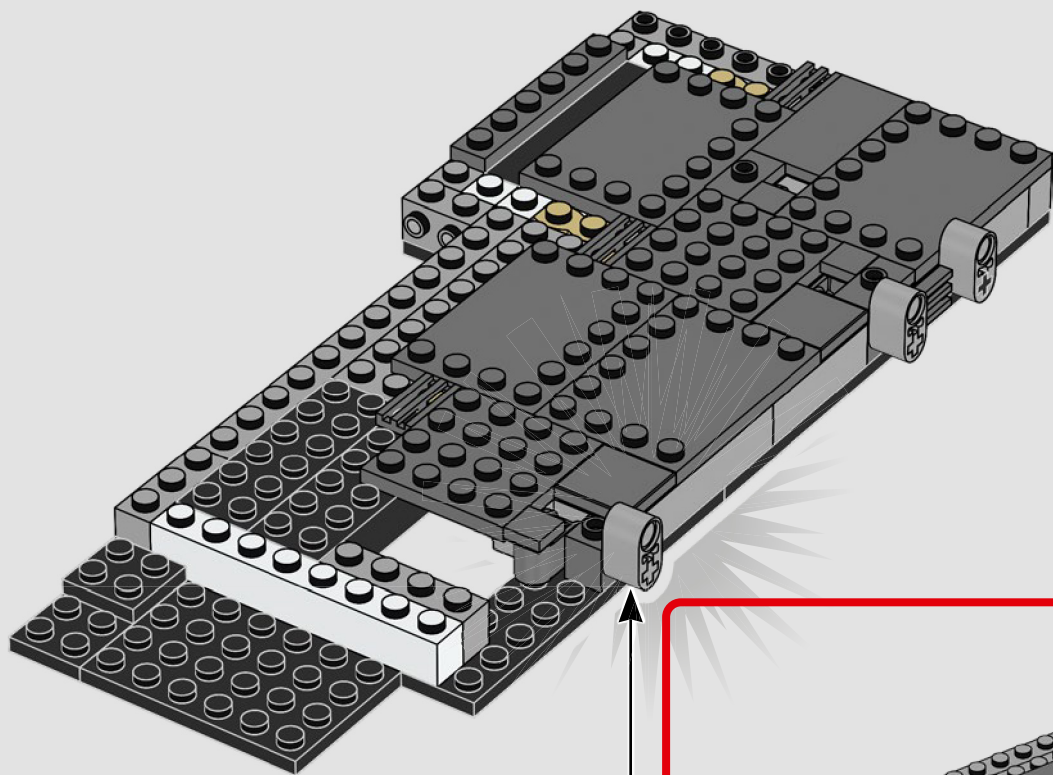

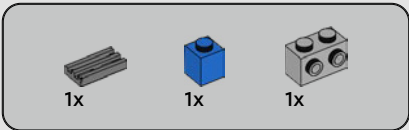

32

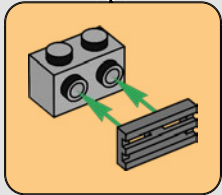
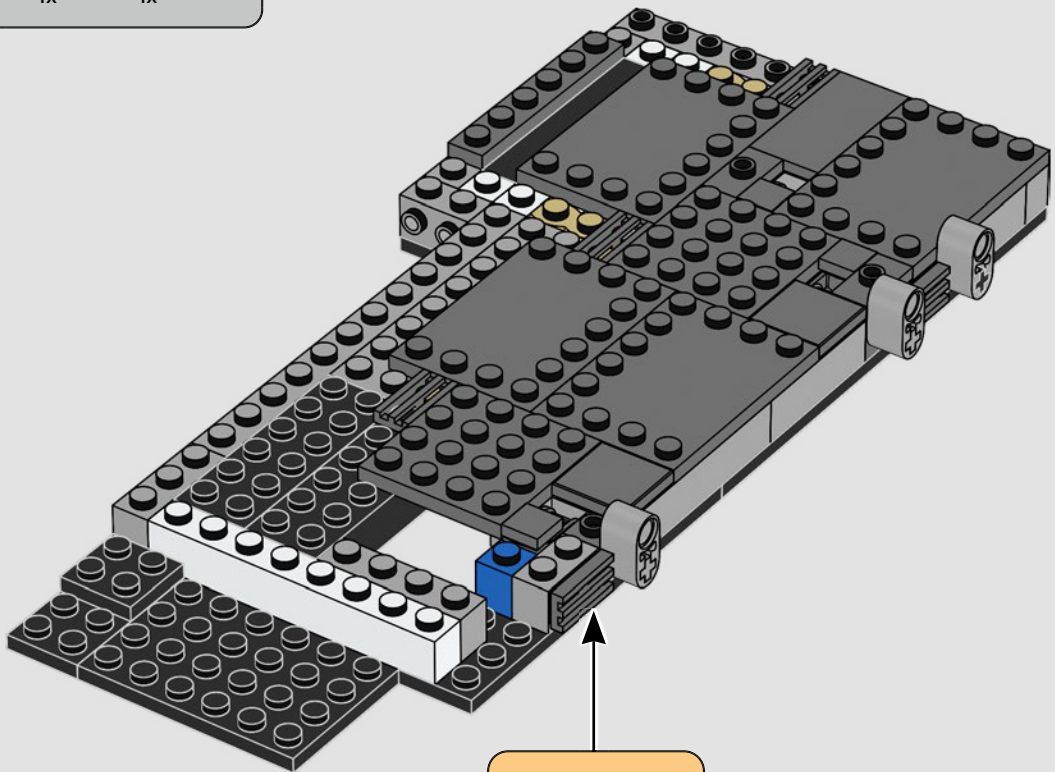

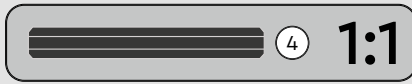
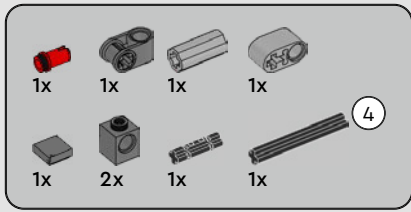

33

1

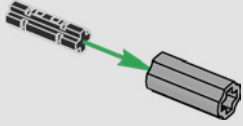

2

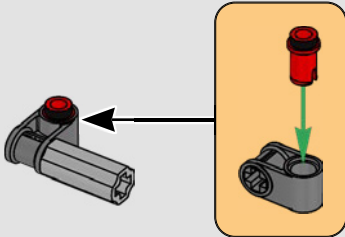

3

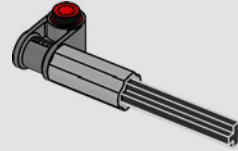

4

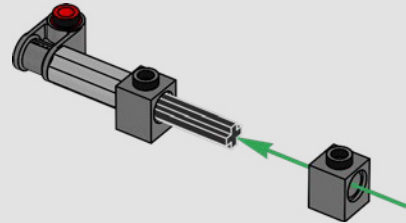

5

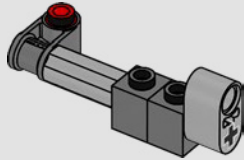

6

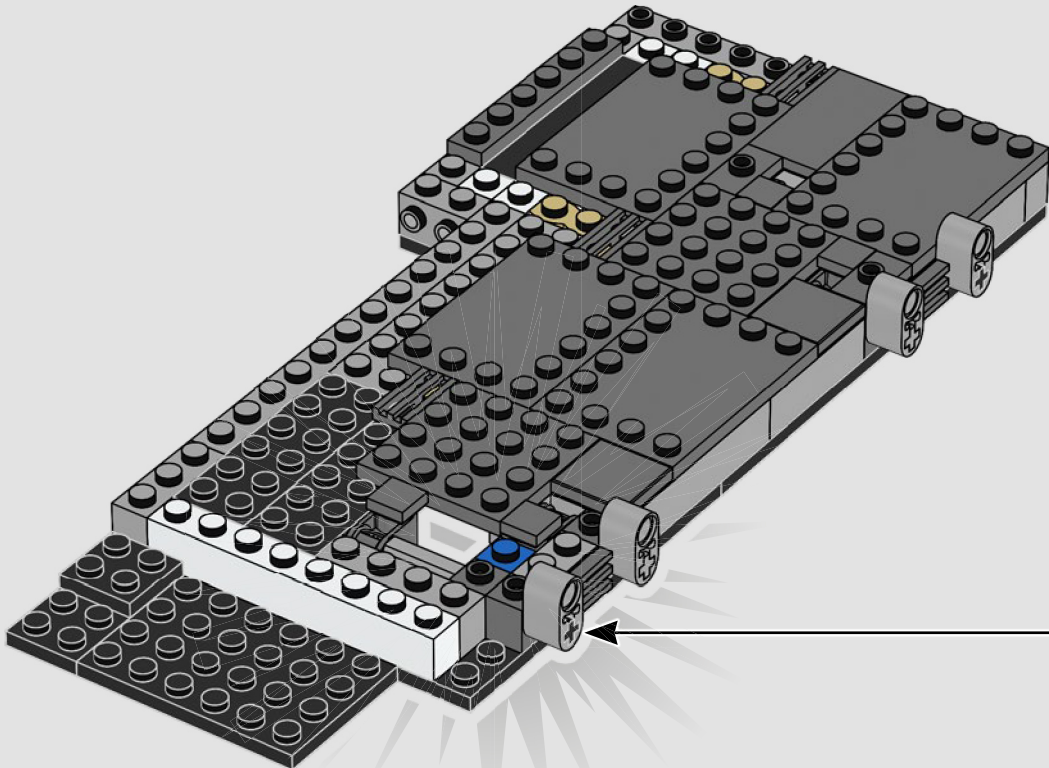
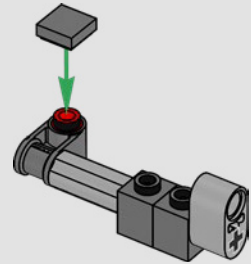

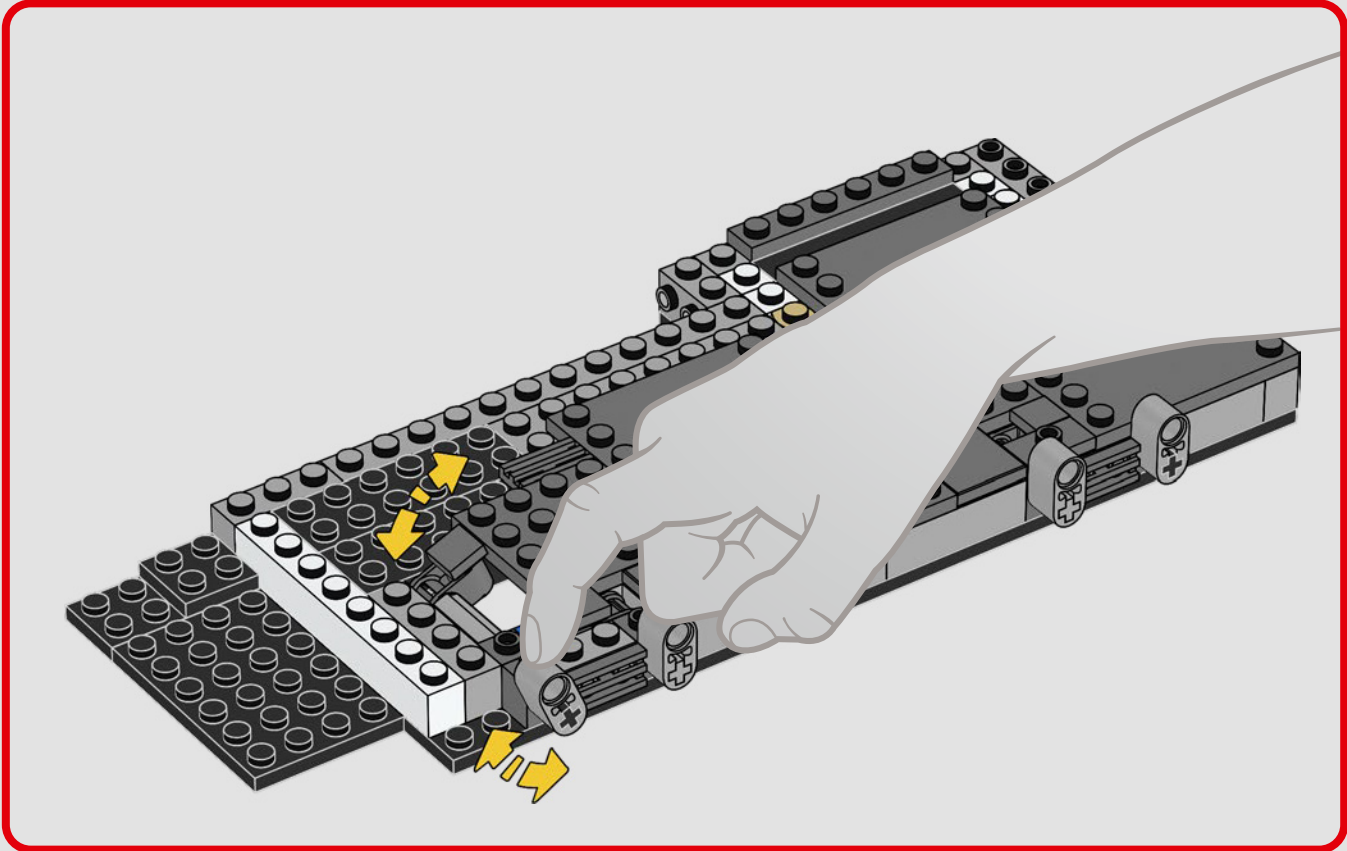

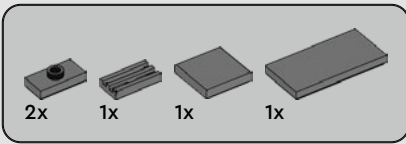

34

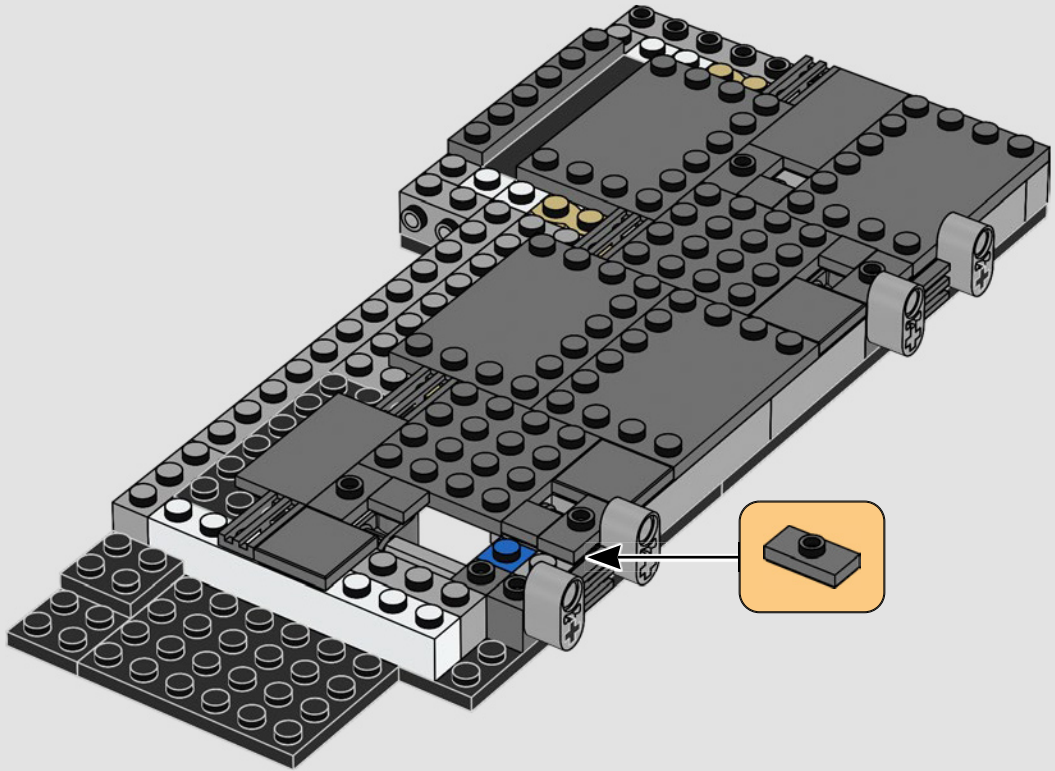

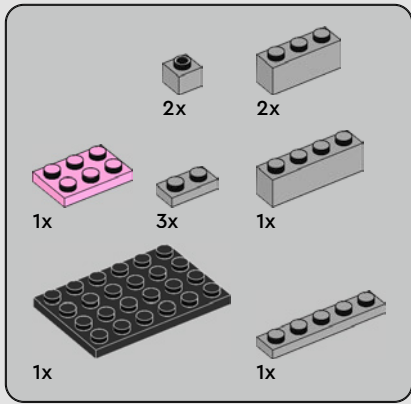

35

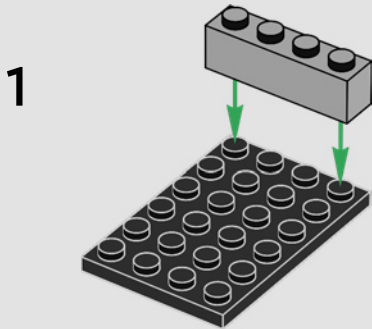

2

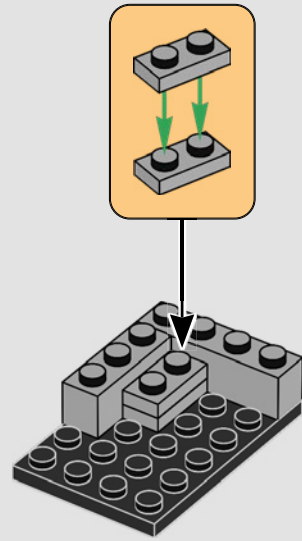

1

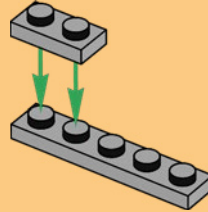

2

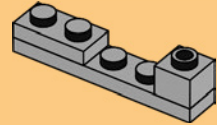

3

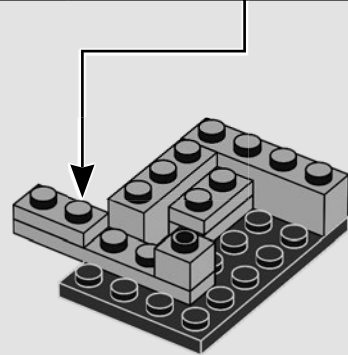



4

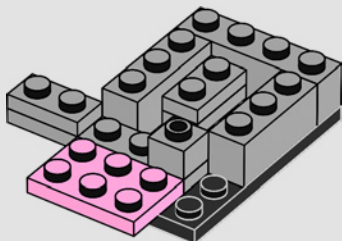

5

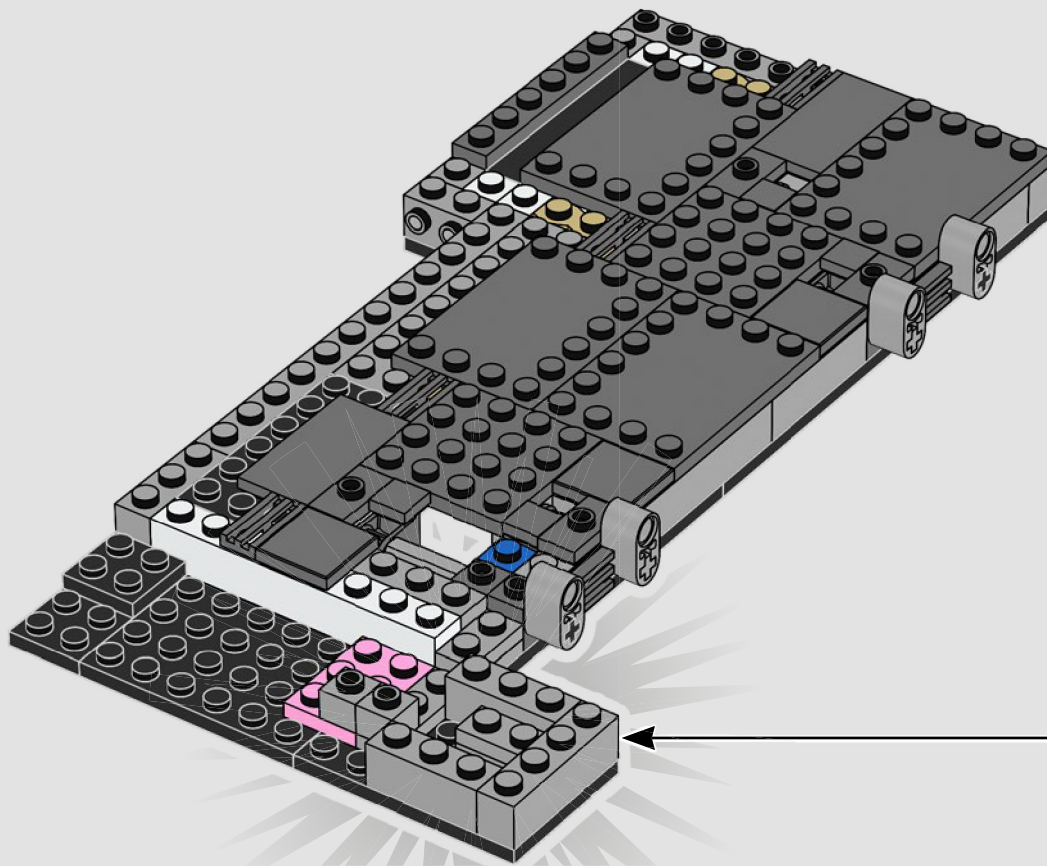
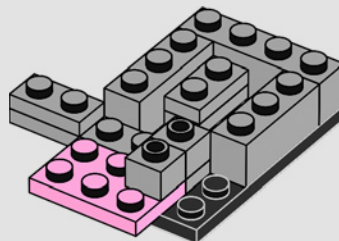

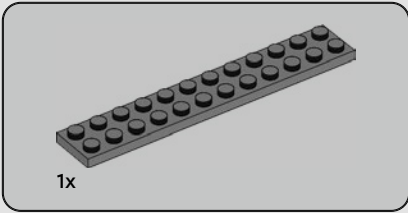

# 36

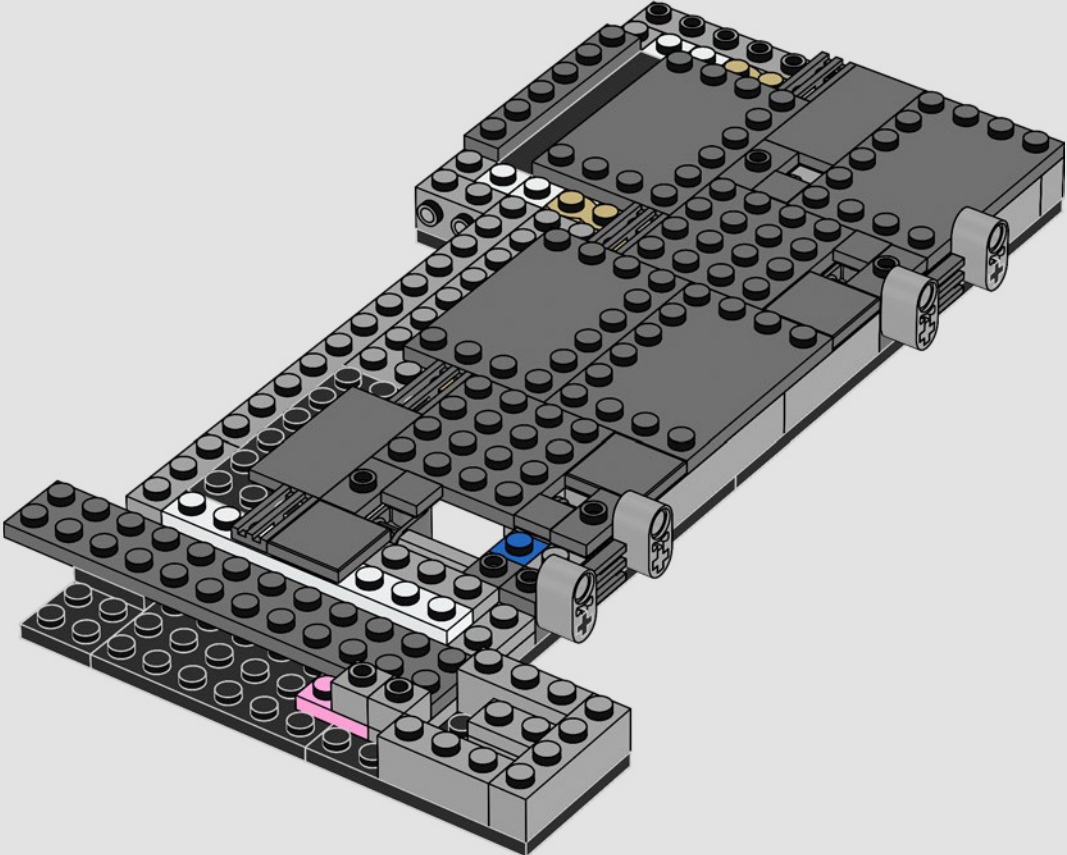

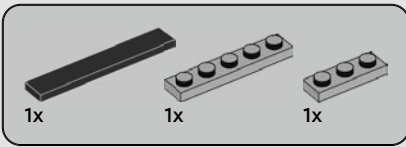

37

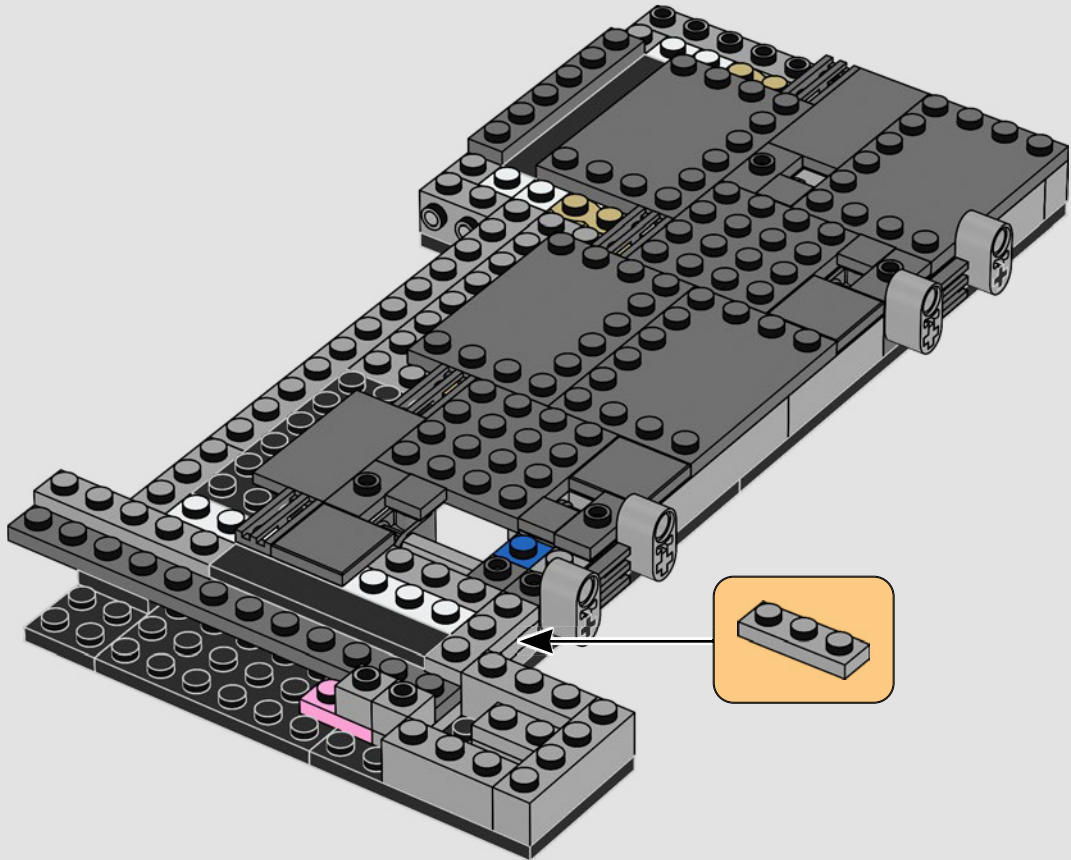

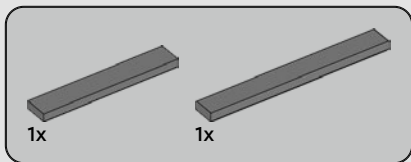

38

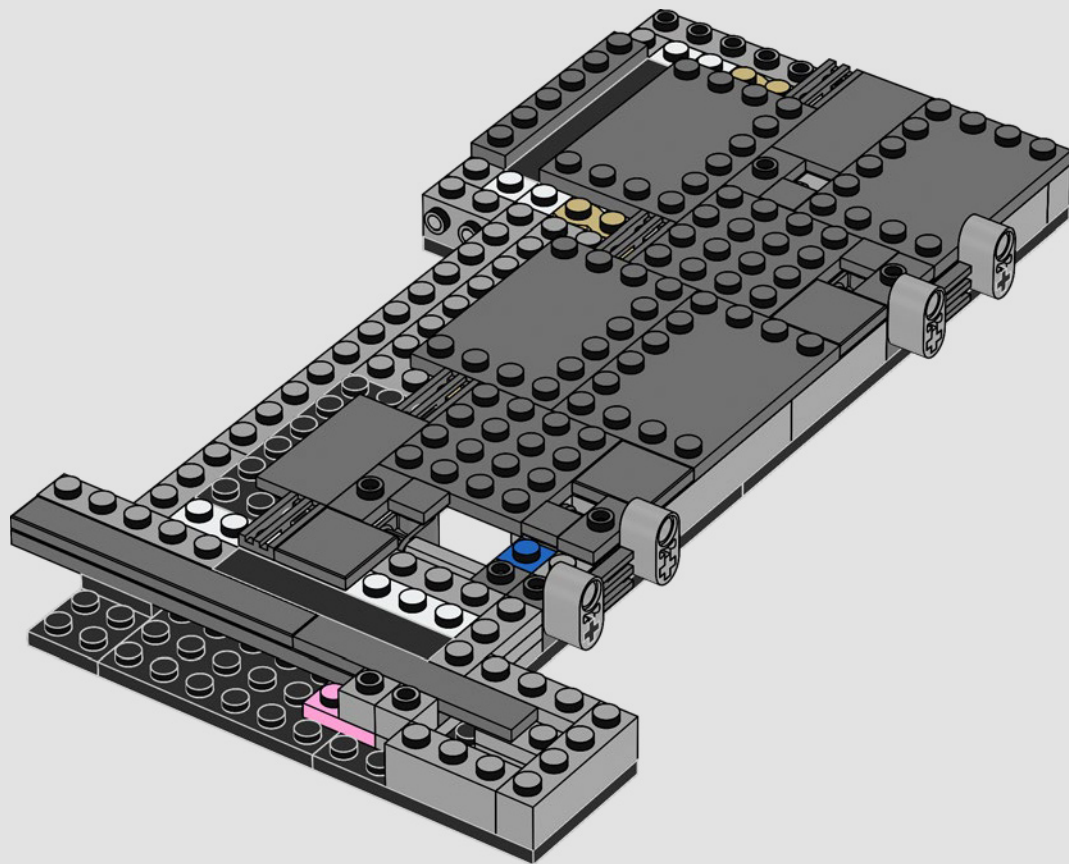

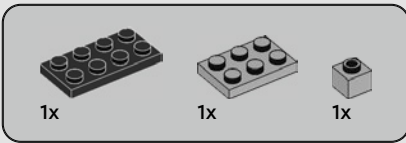

# 39

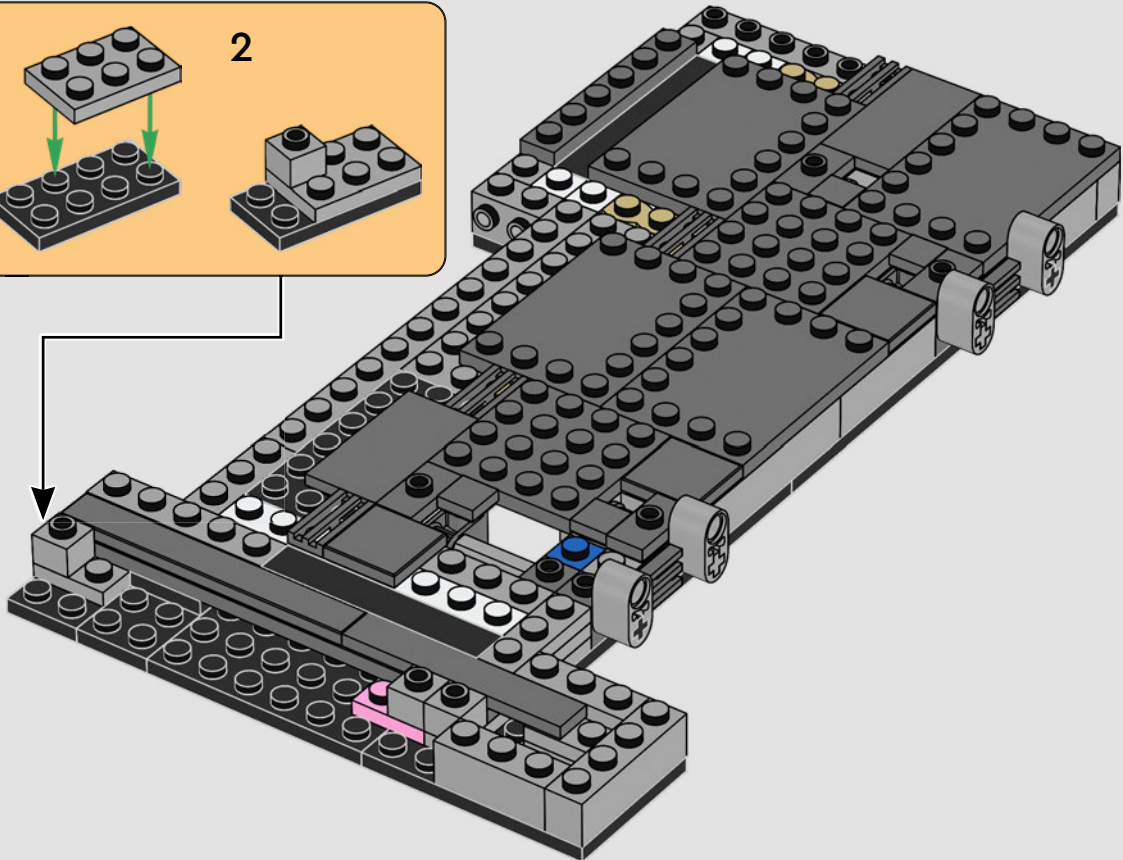
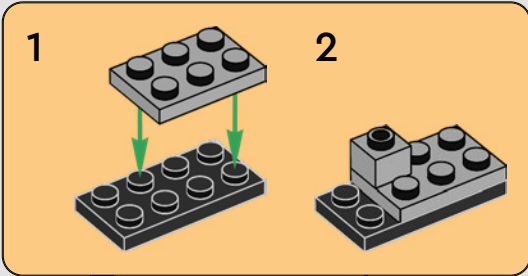

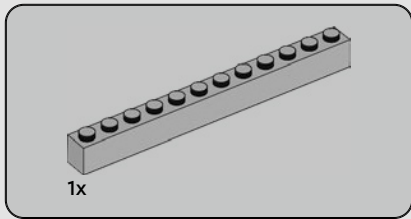

40

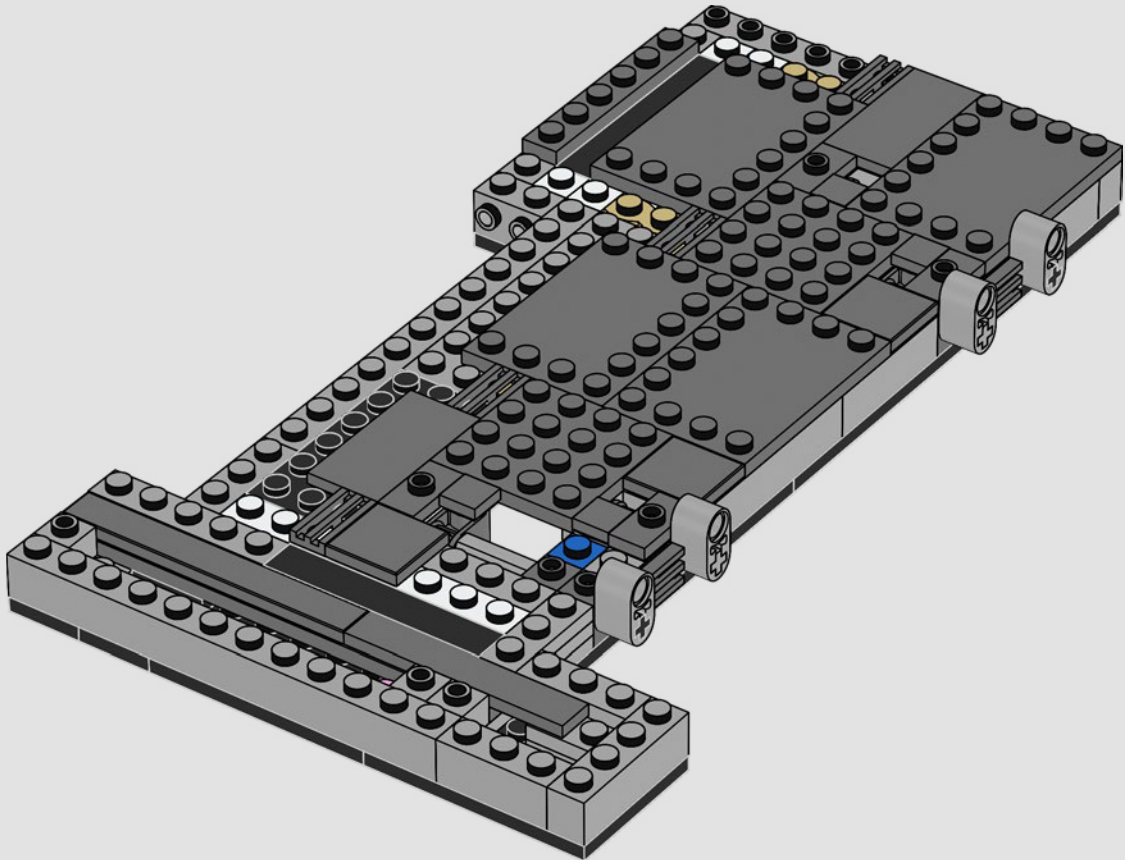

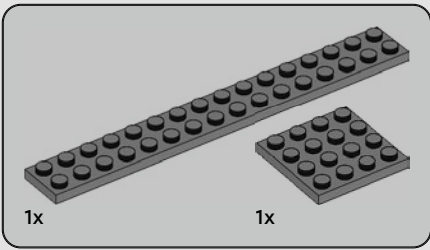

41

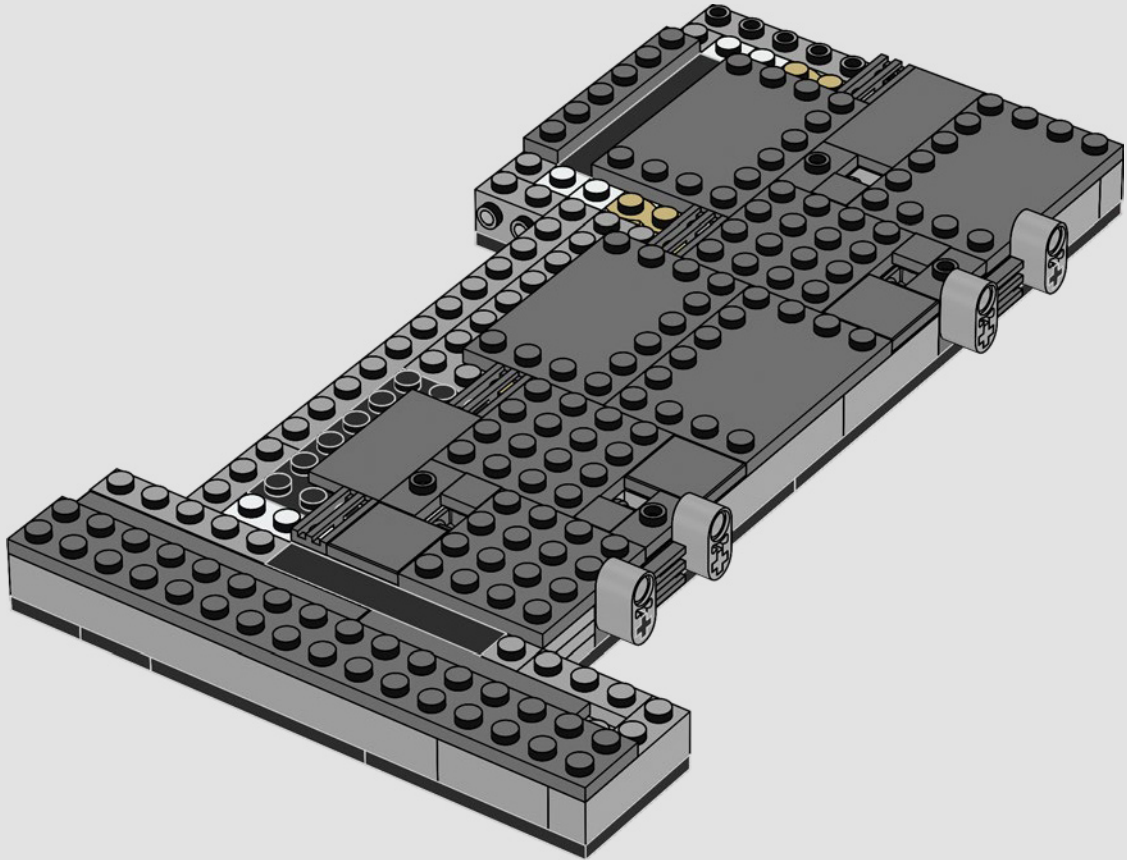



1x

42

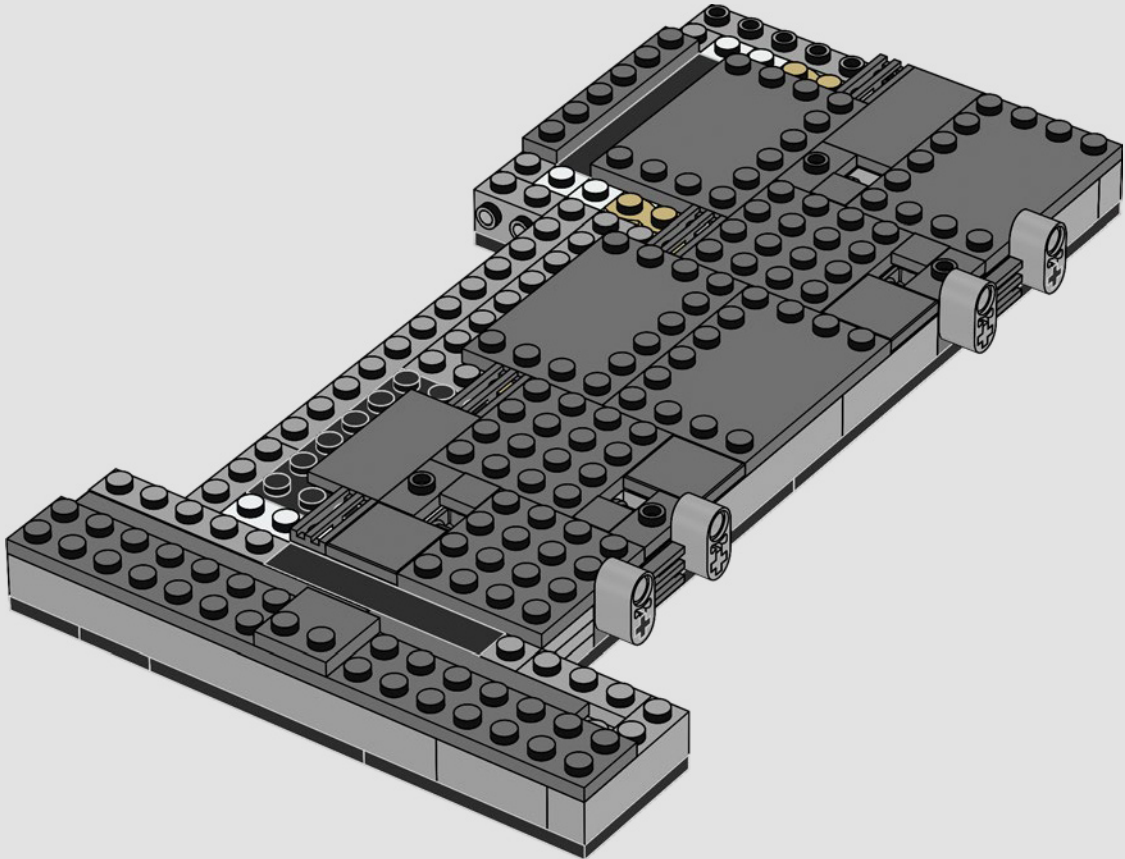



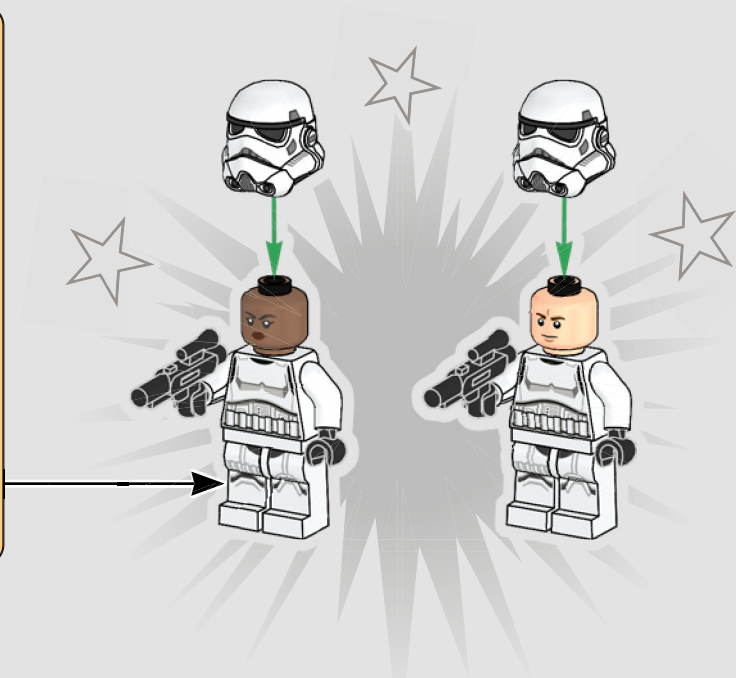
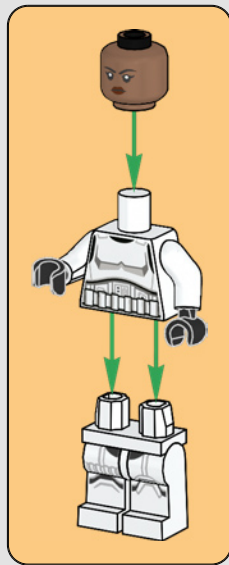

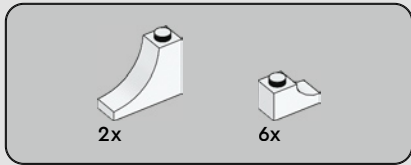

43

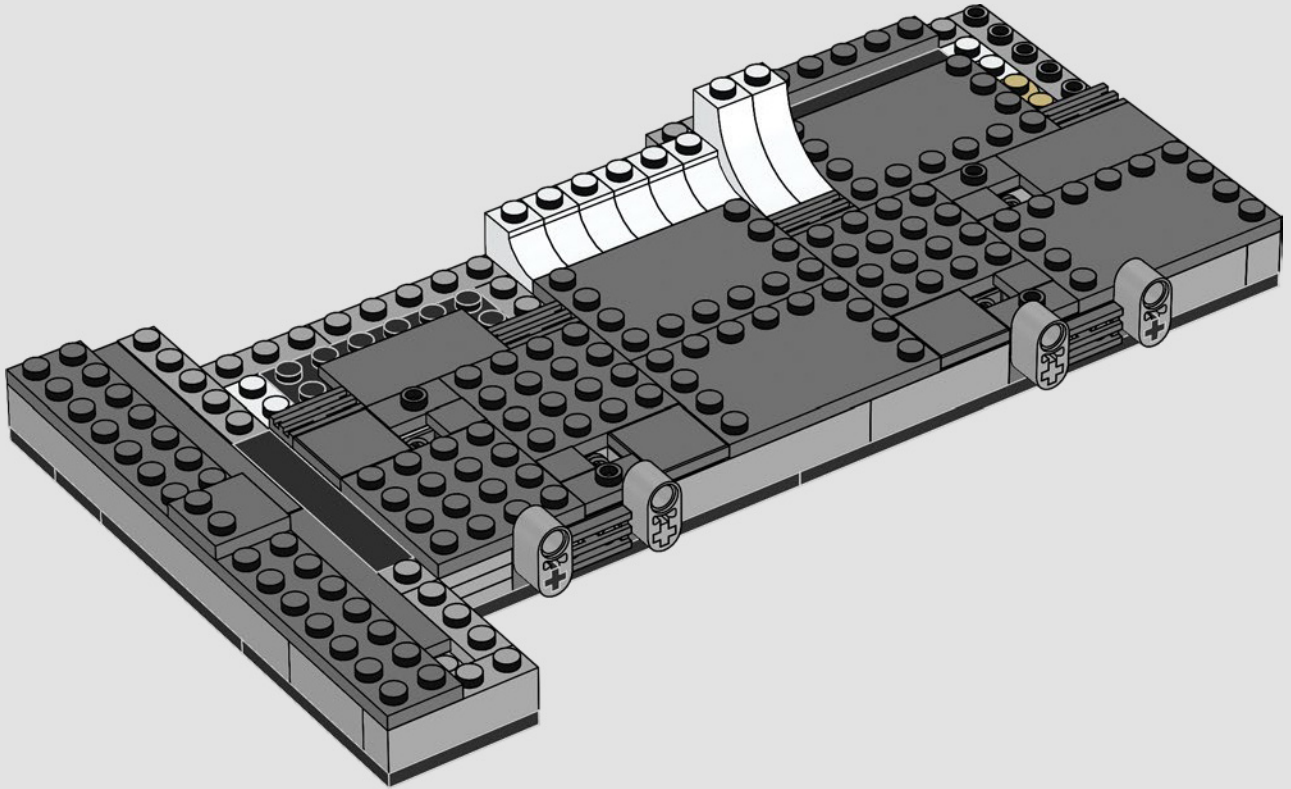

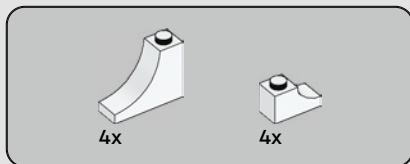

44

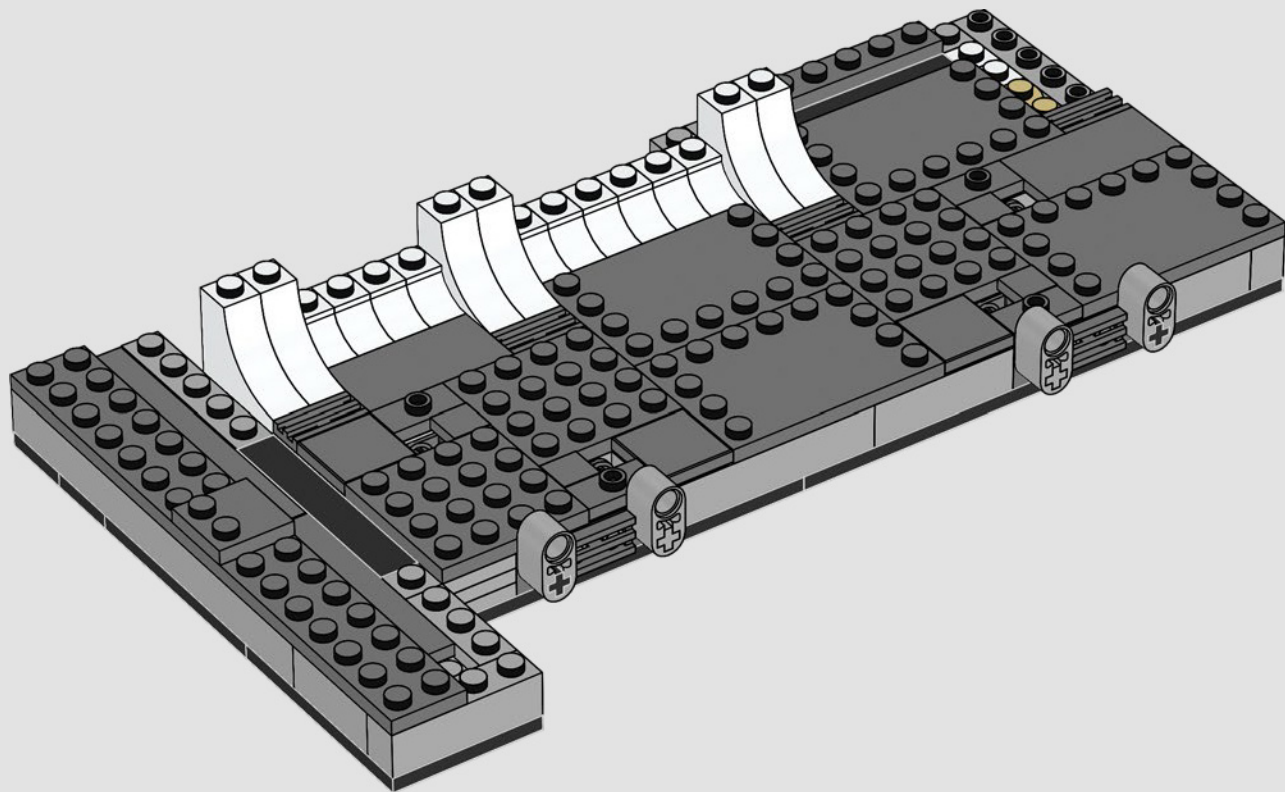

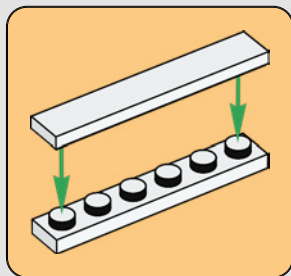
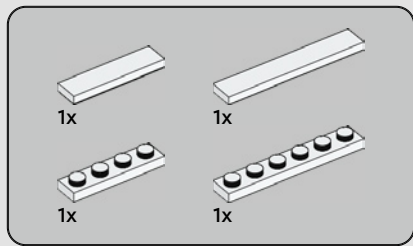

45

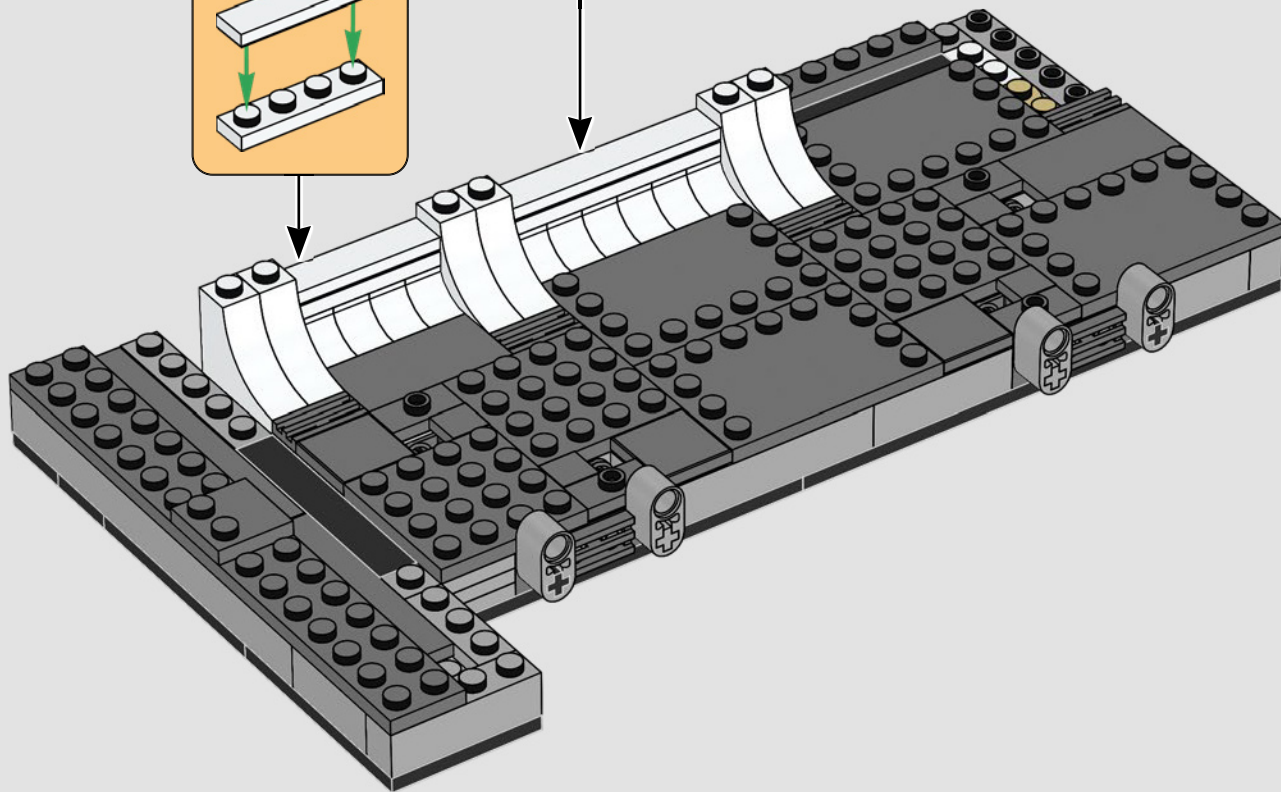
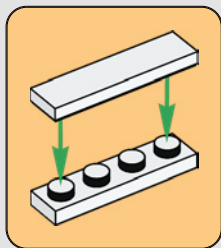

1x

1x

46

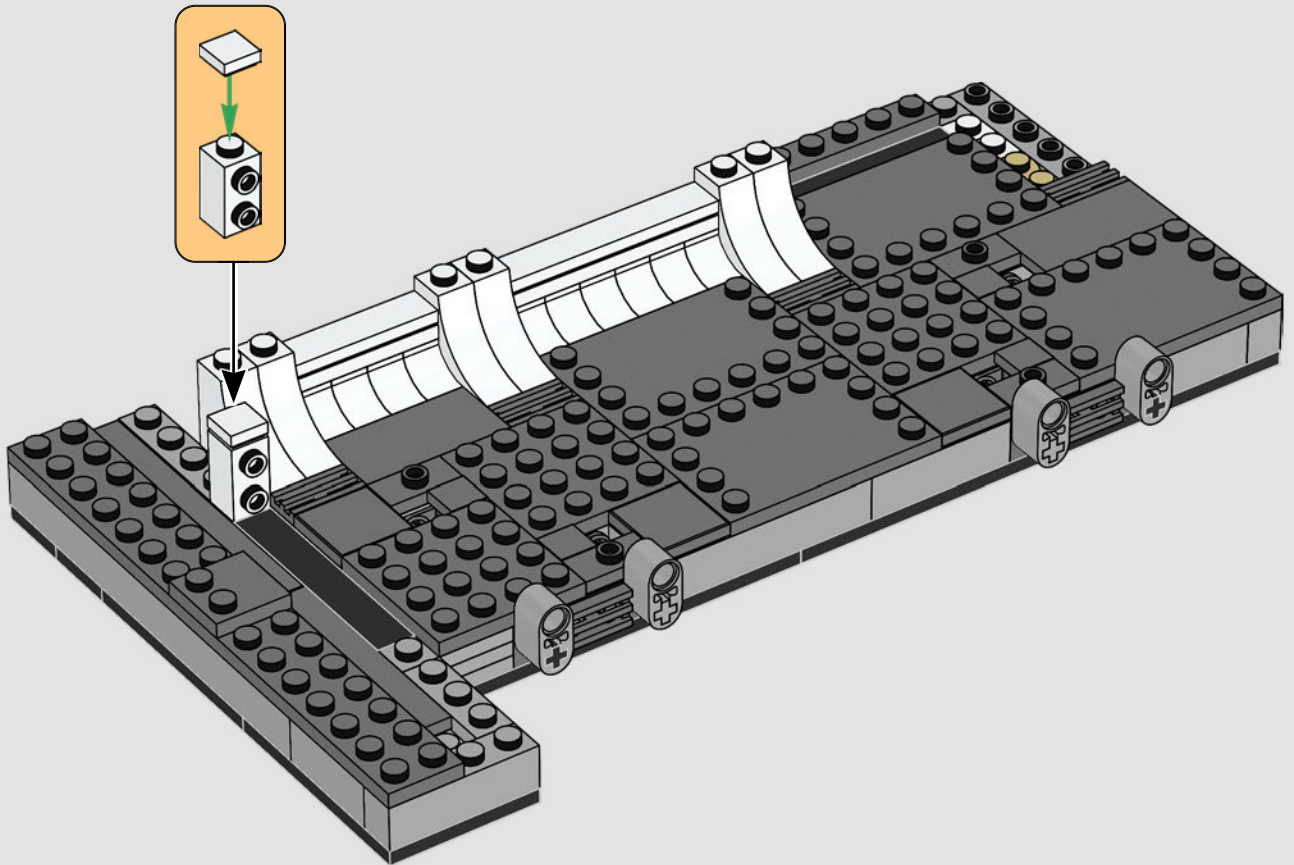

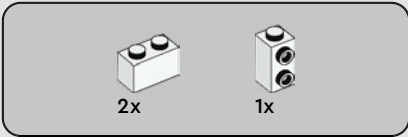

47

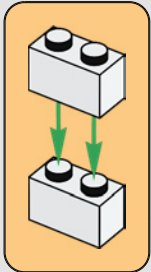
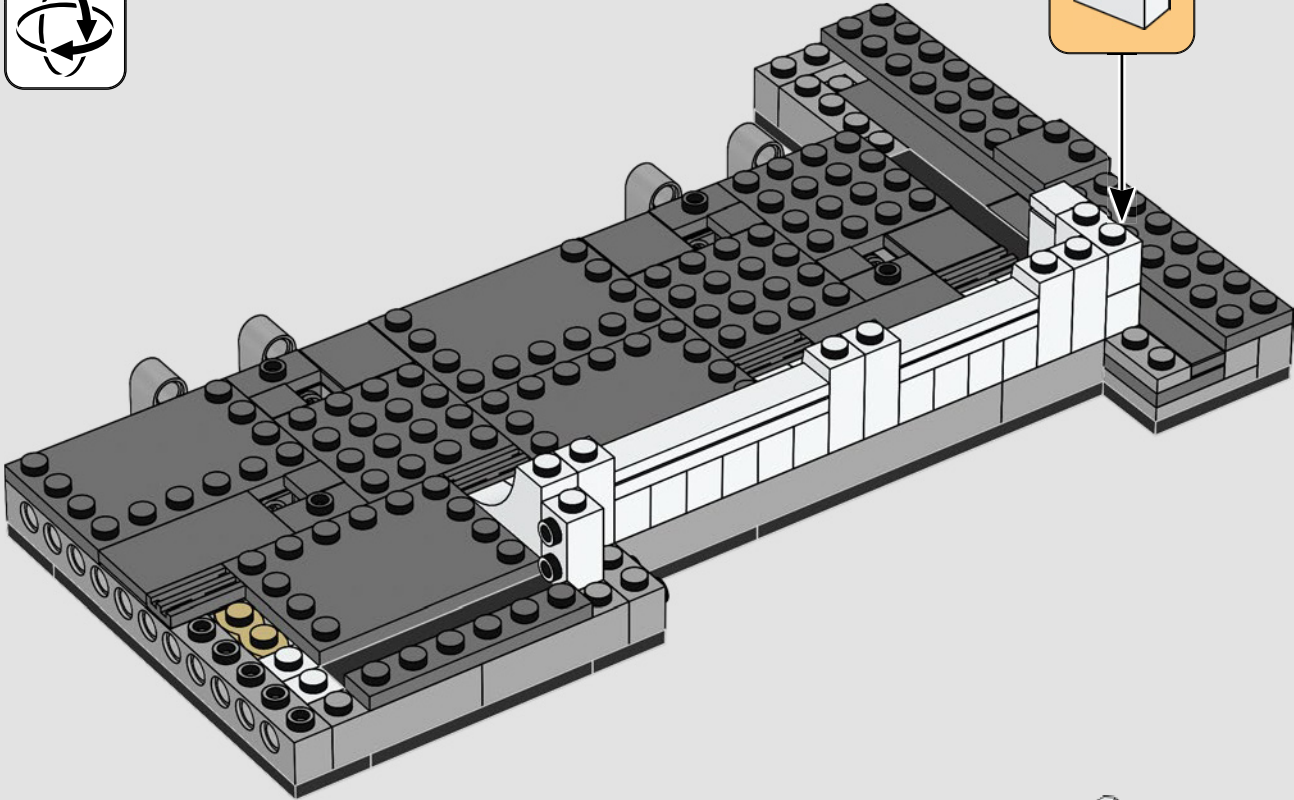



2x



1x

48

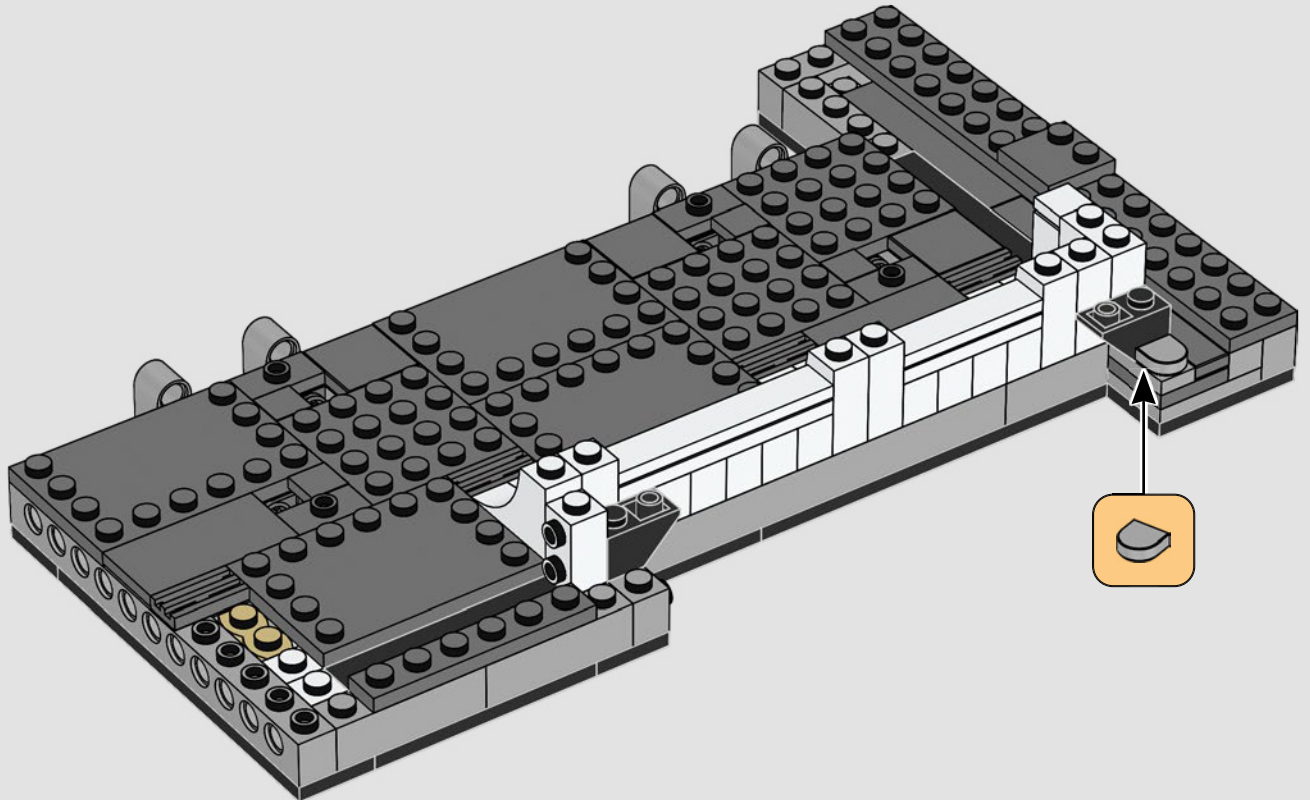

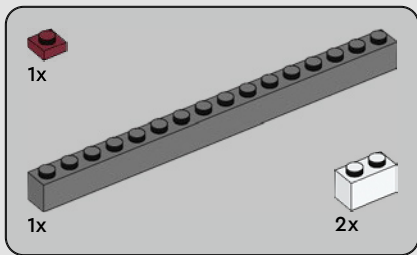

49

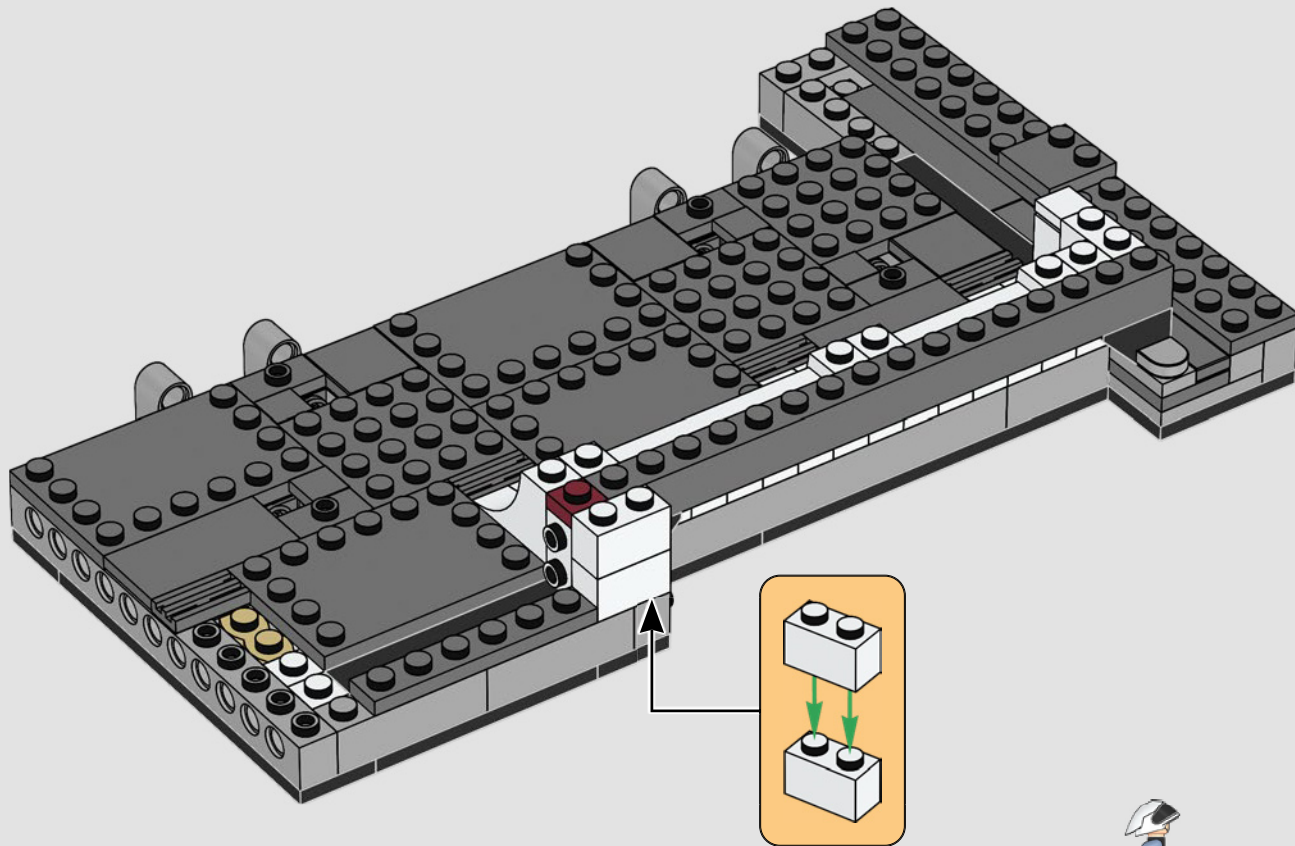



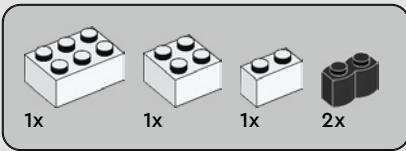

50

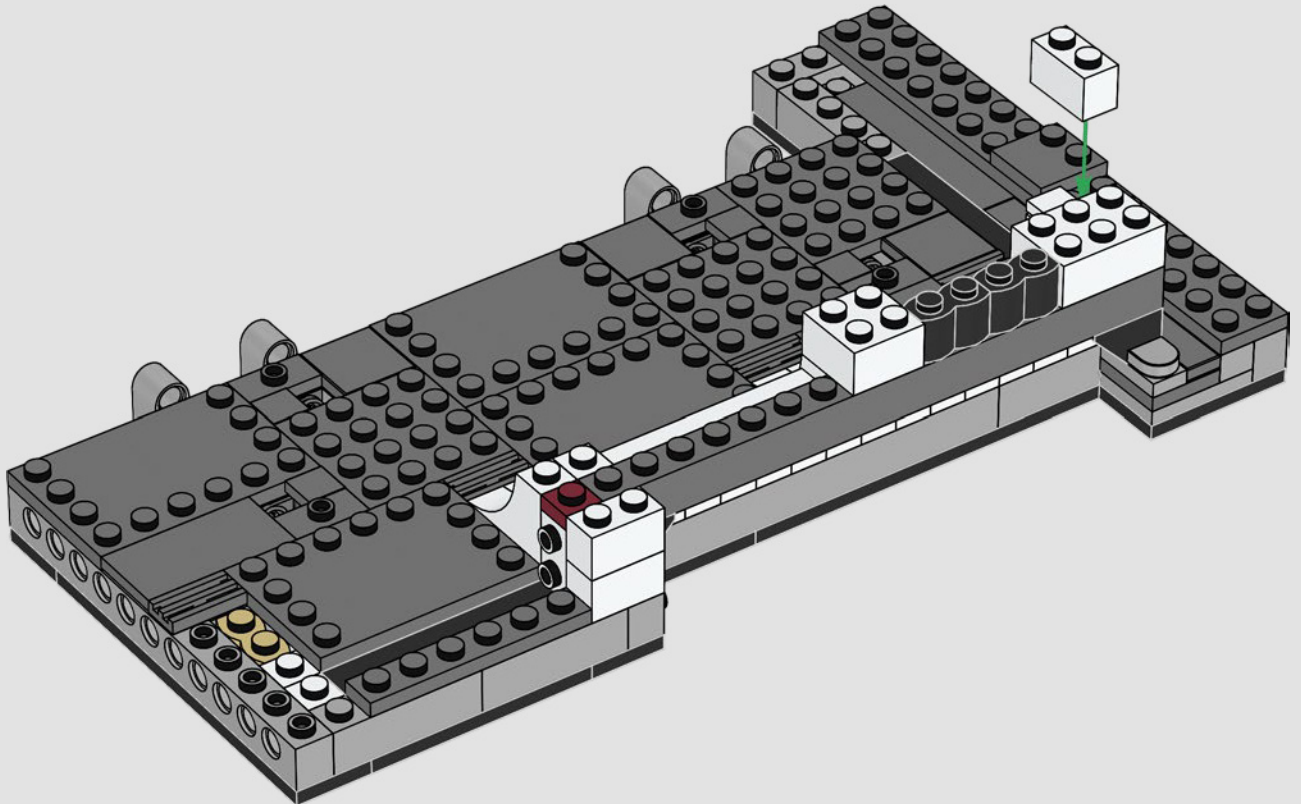

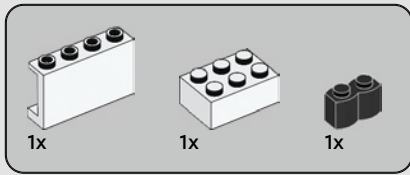

51

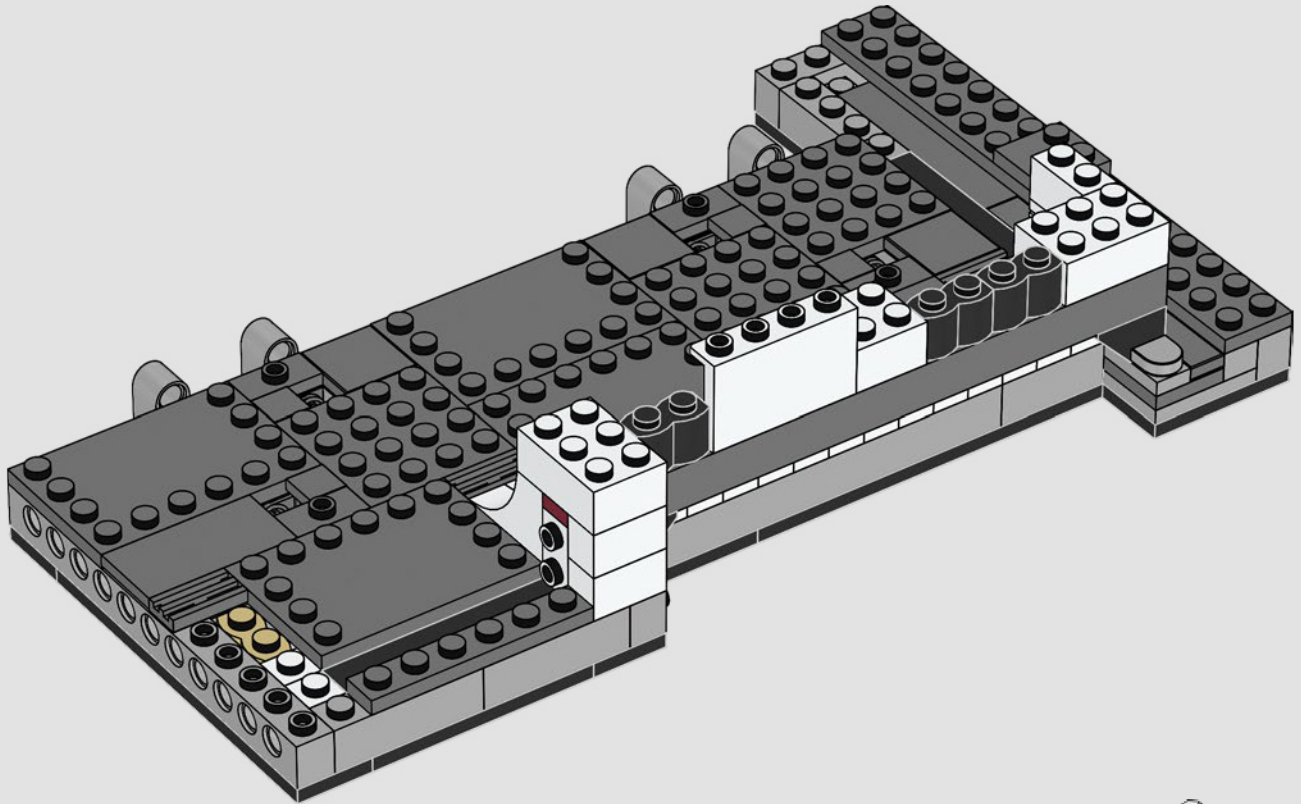

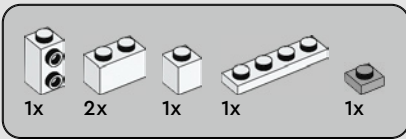

52

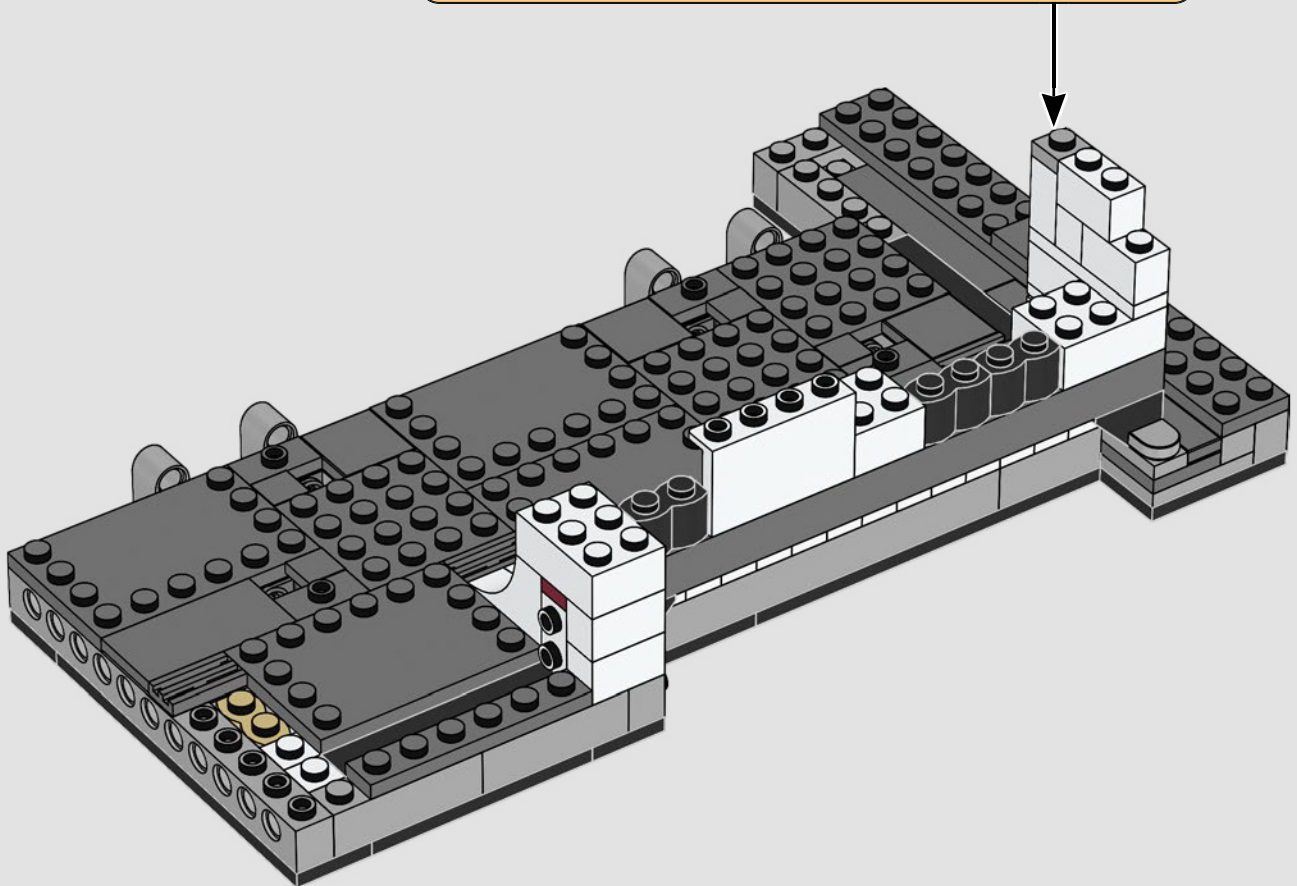
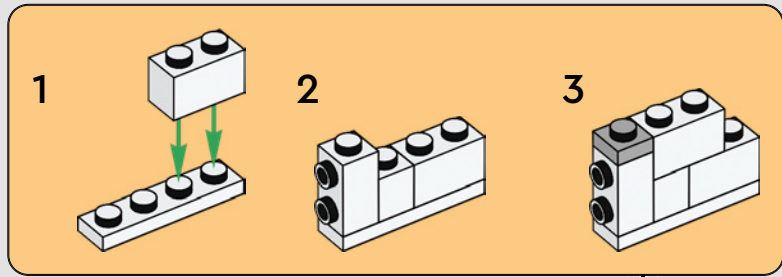

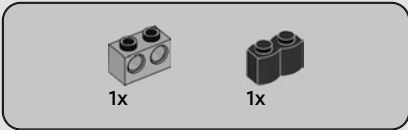

53

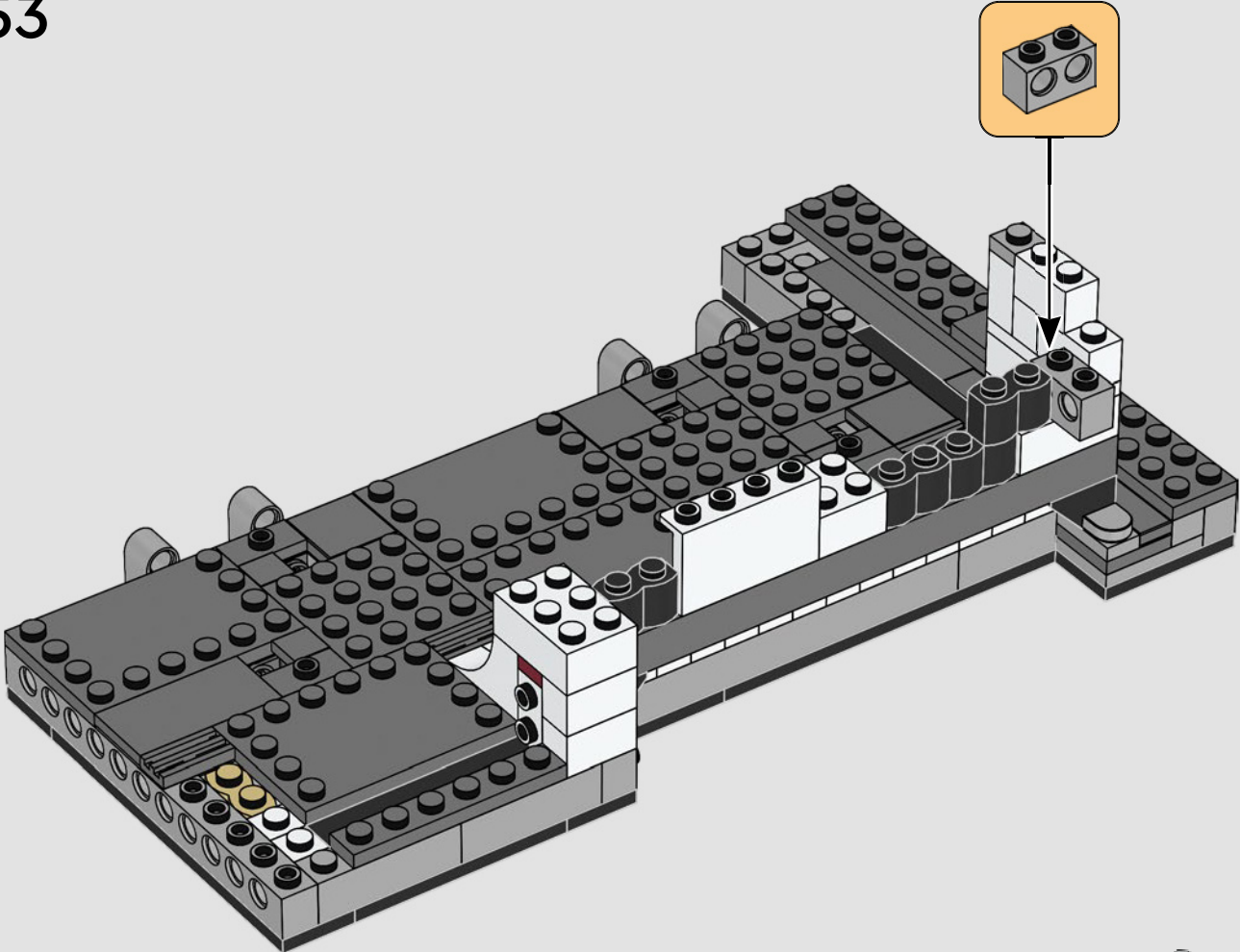

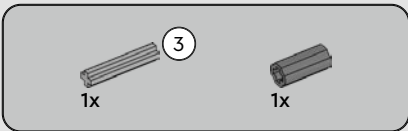

54

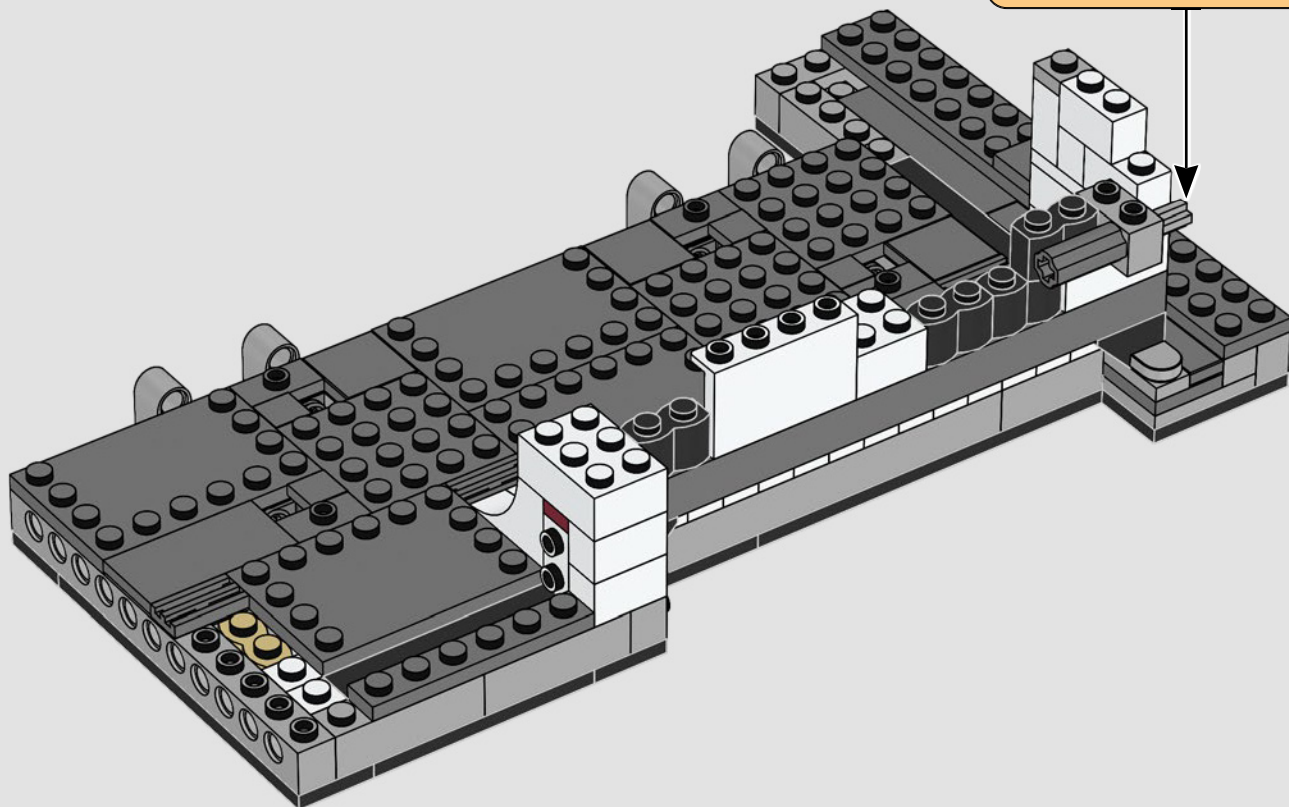
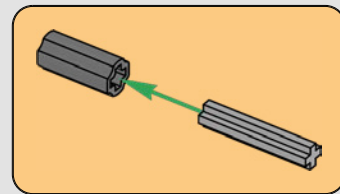

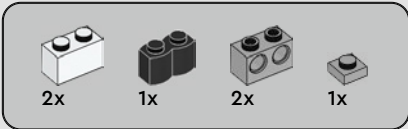

55

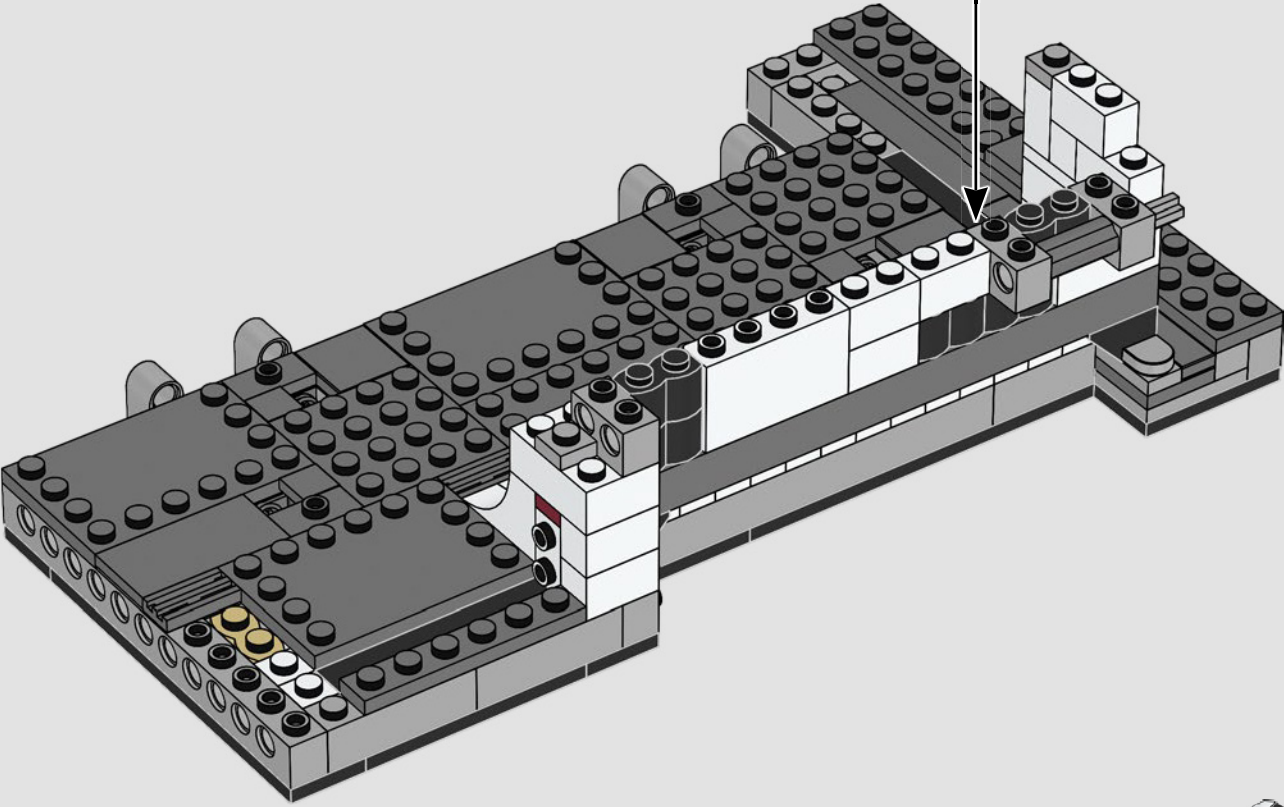



1x

56

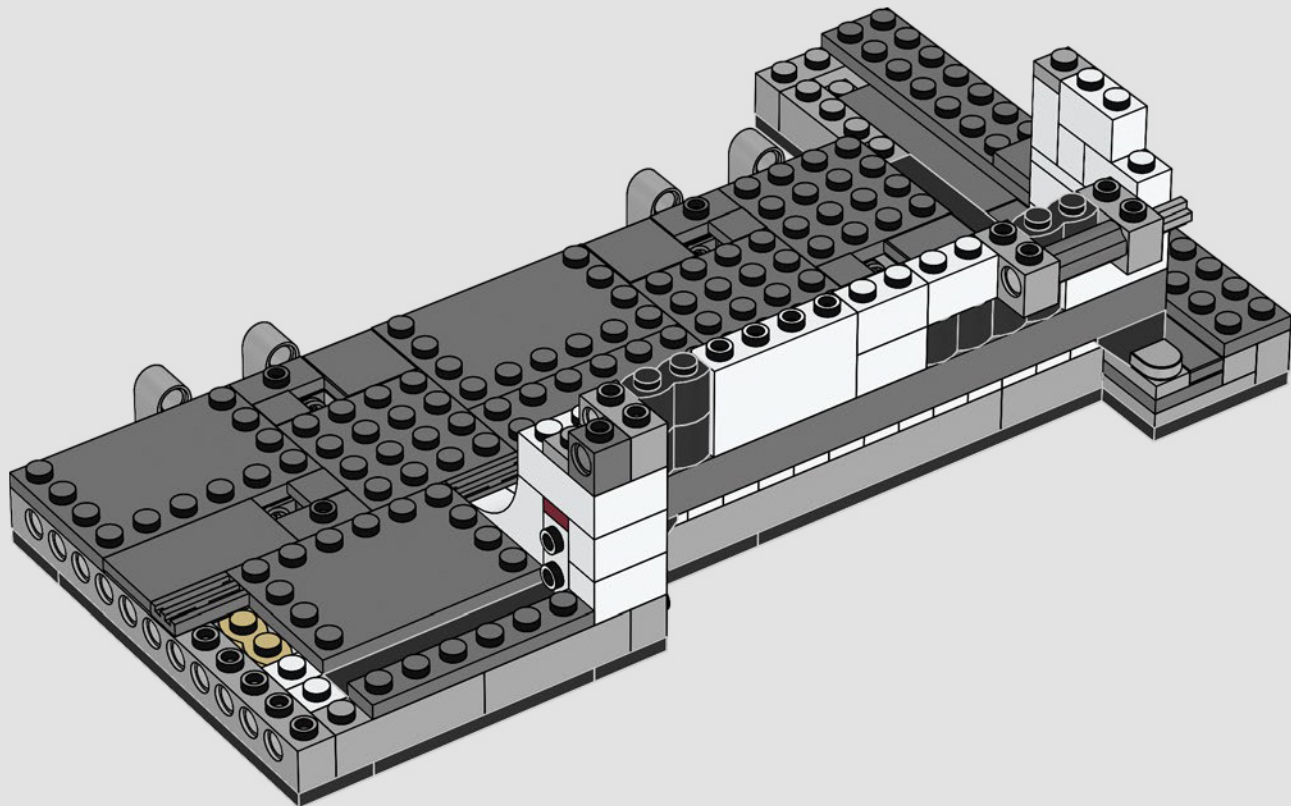



6x

57

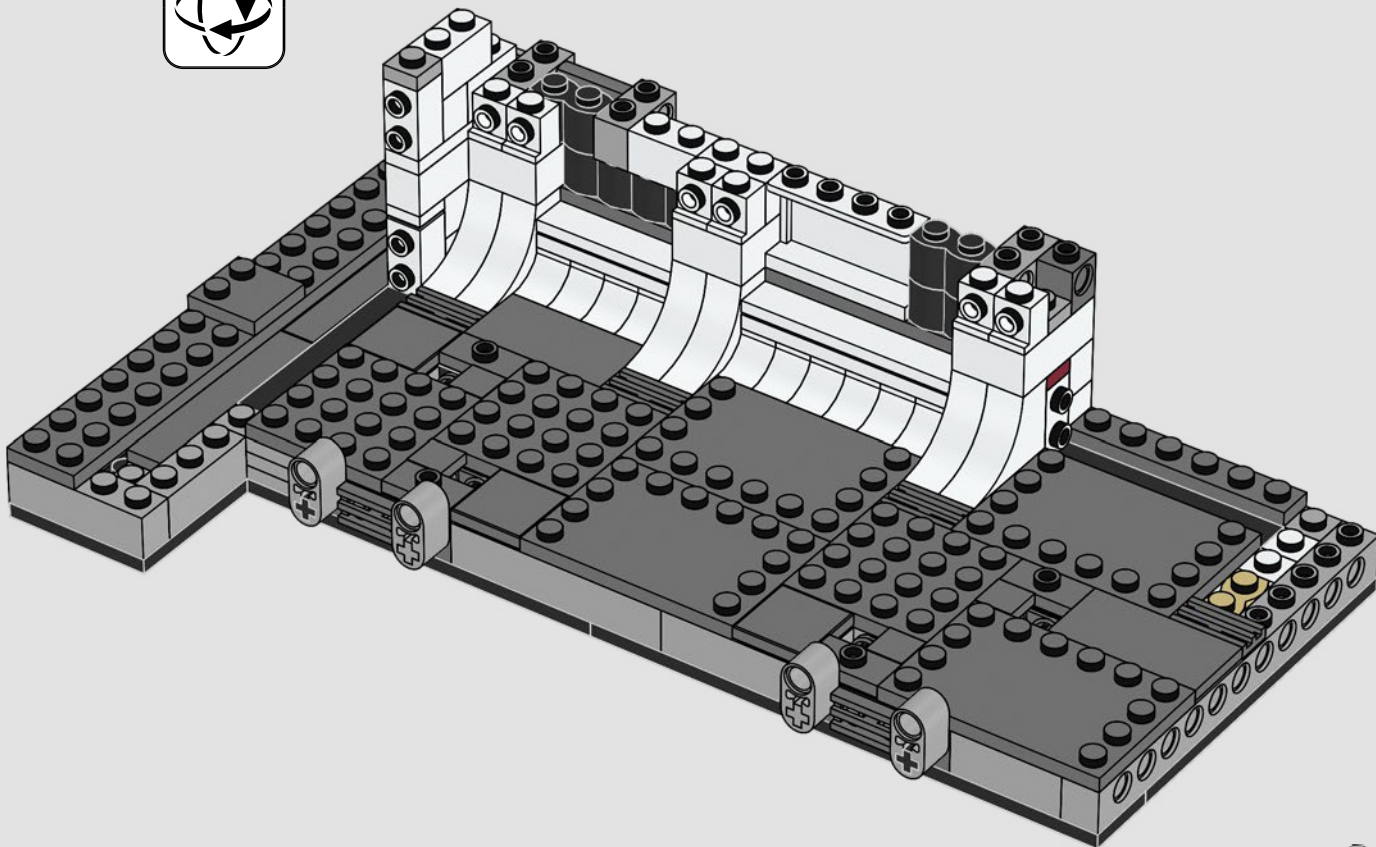



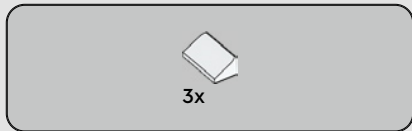

58

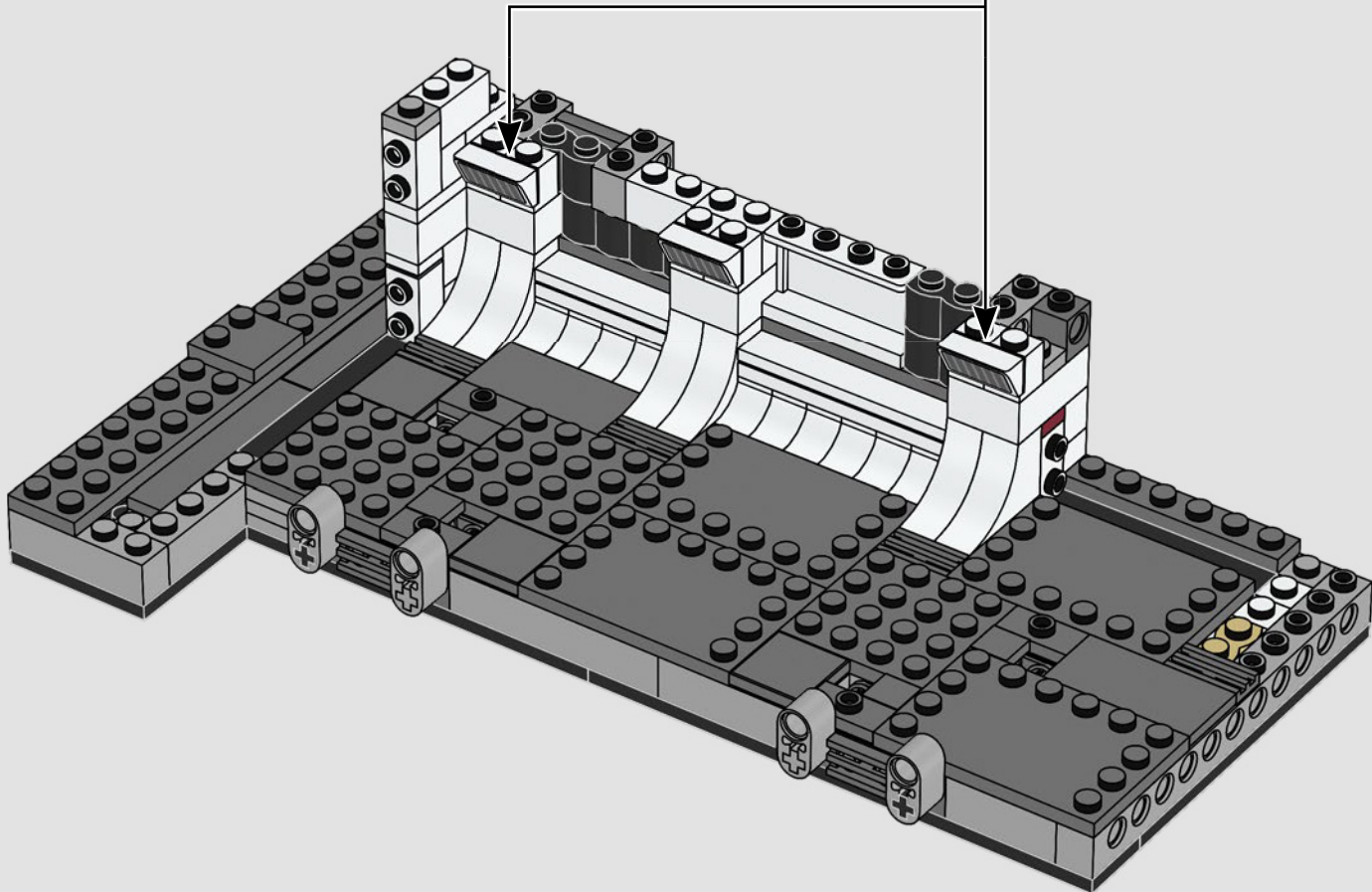
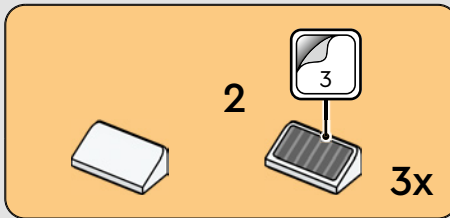

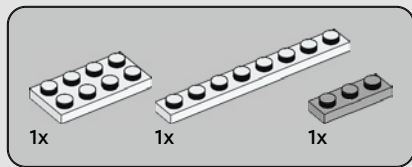

59

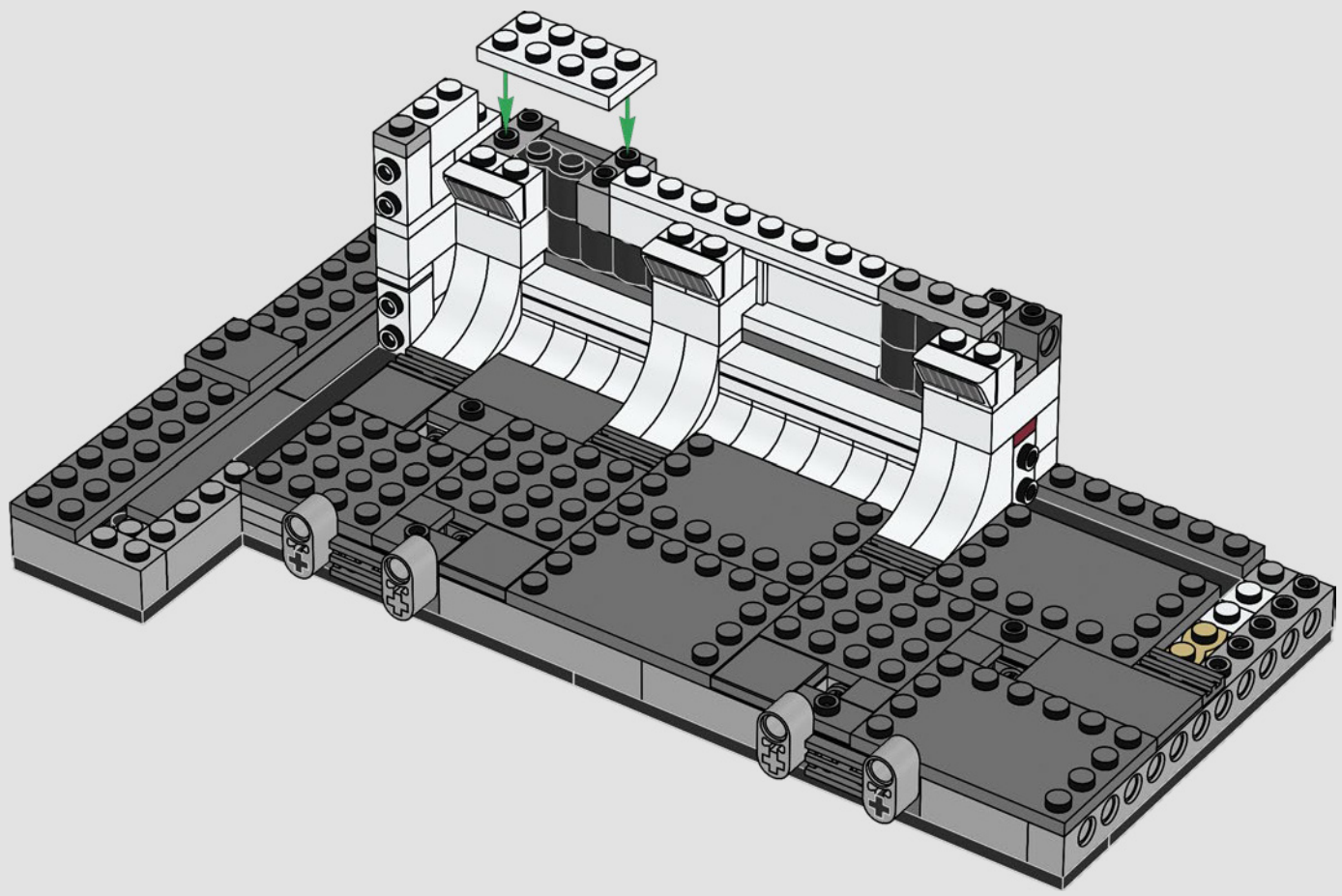

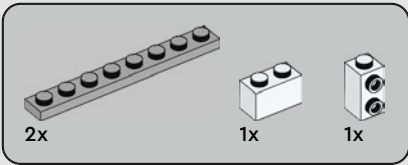

60

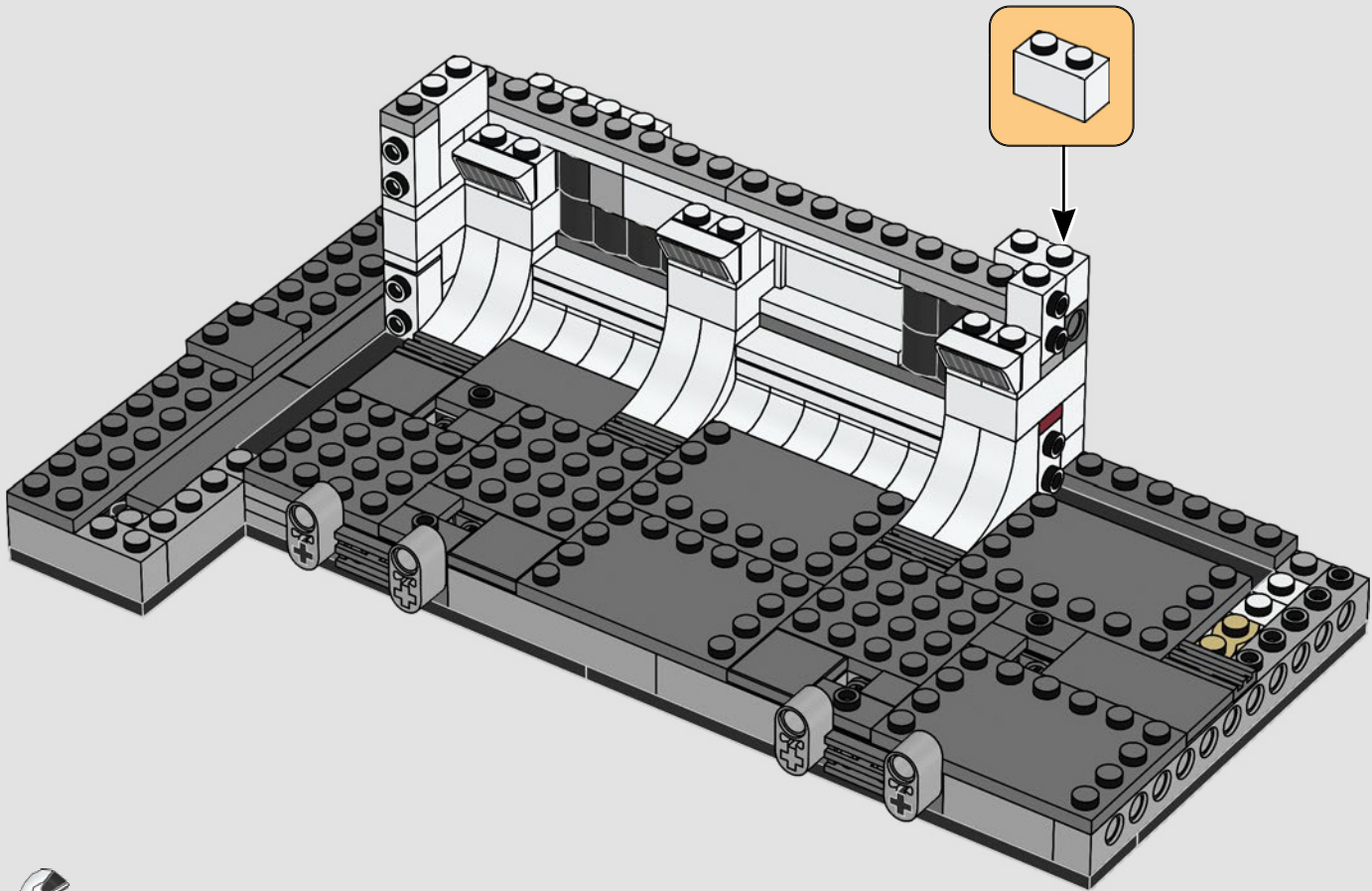

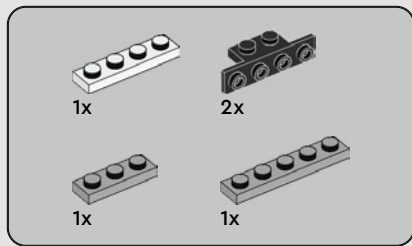

61

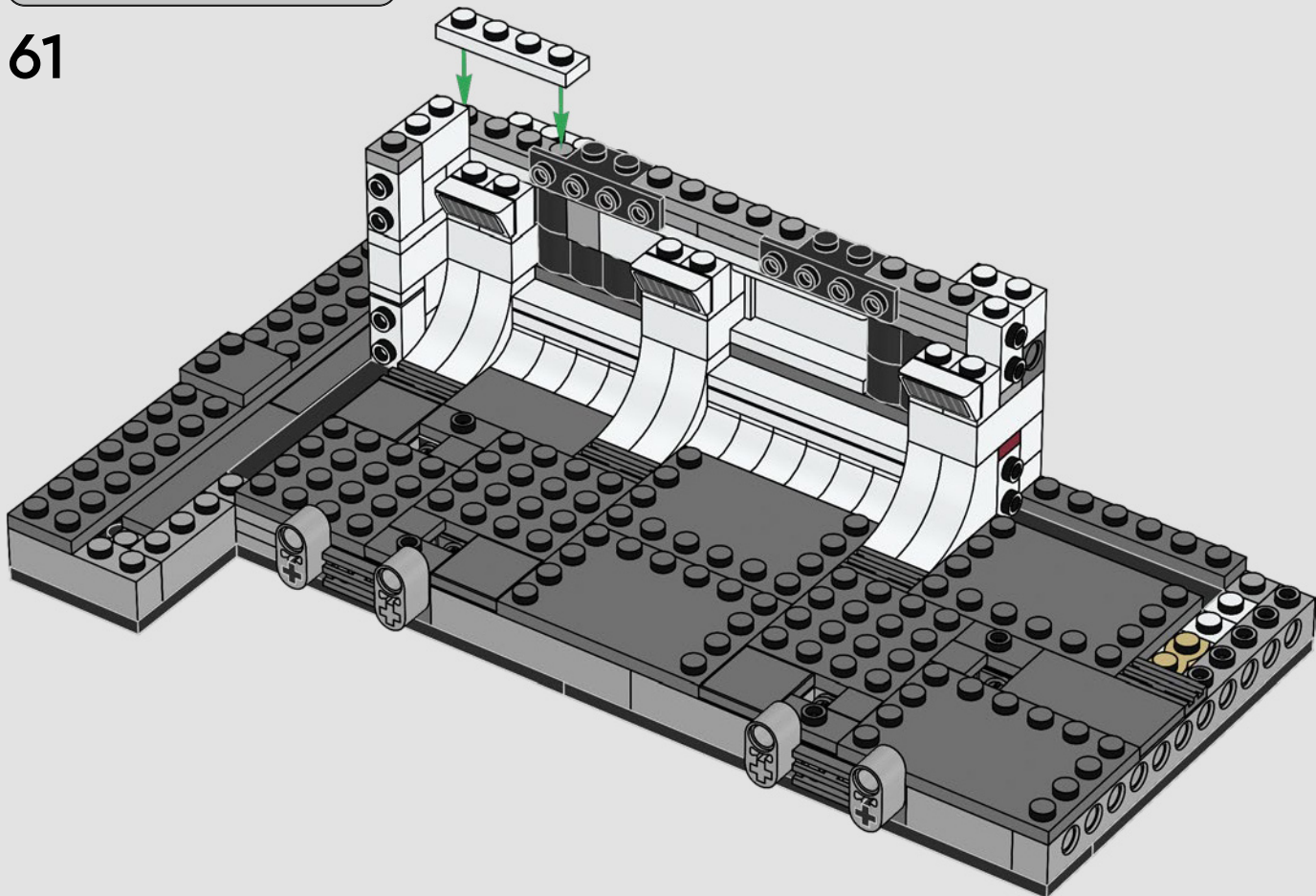

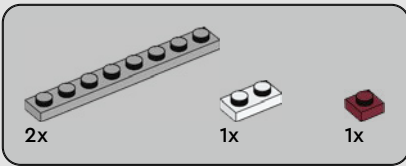

62

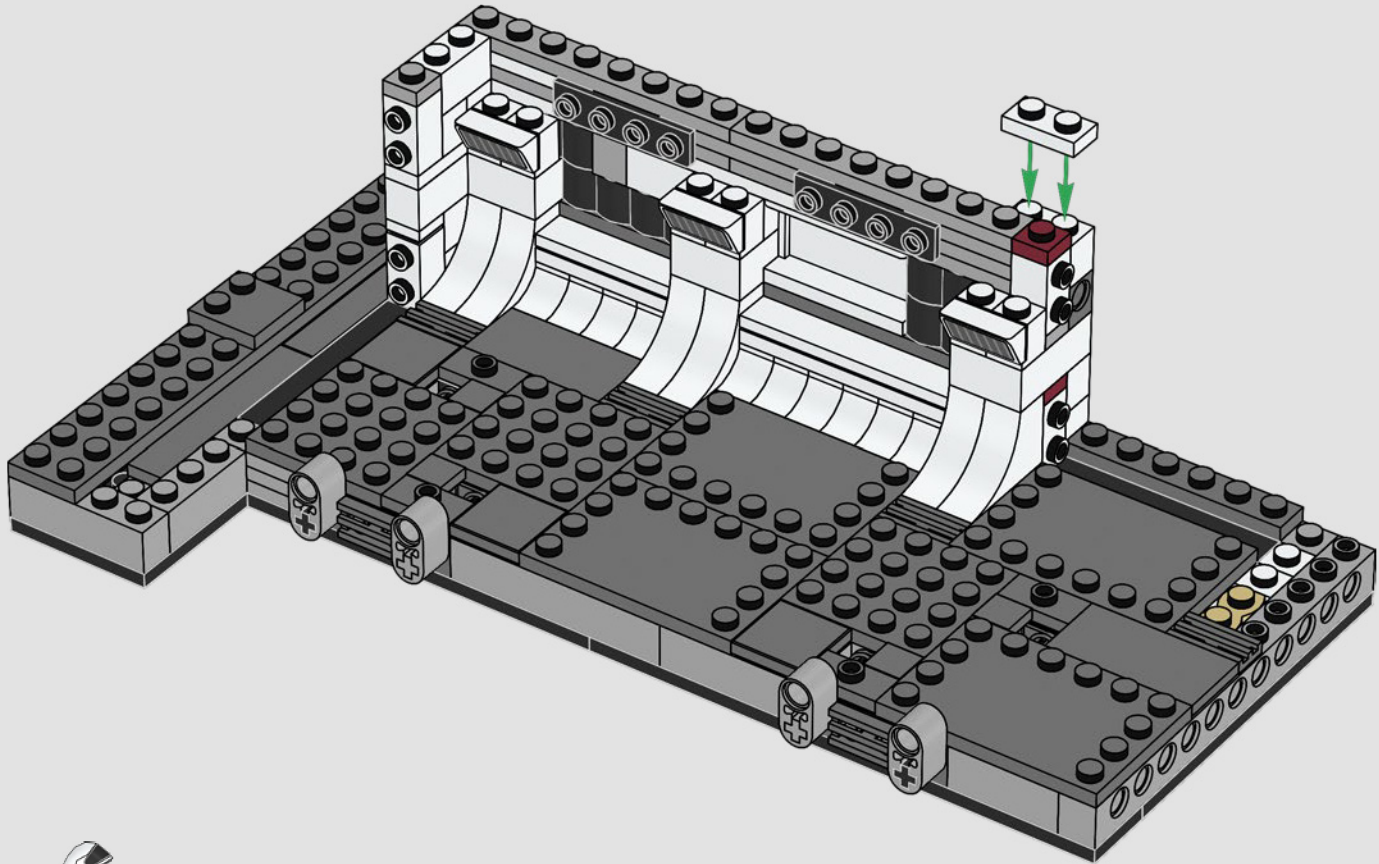

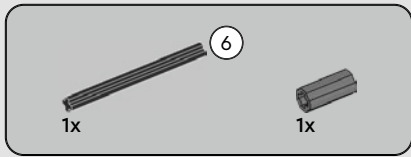

63

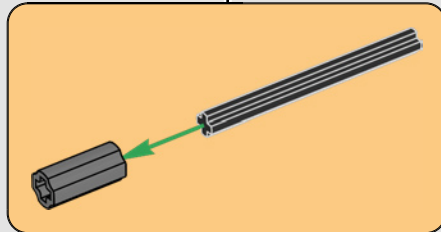
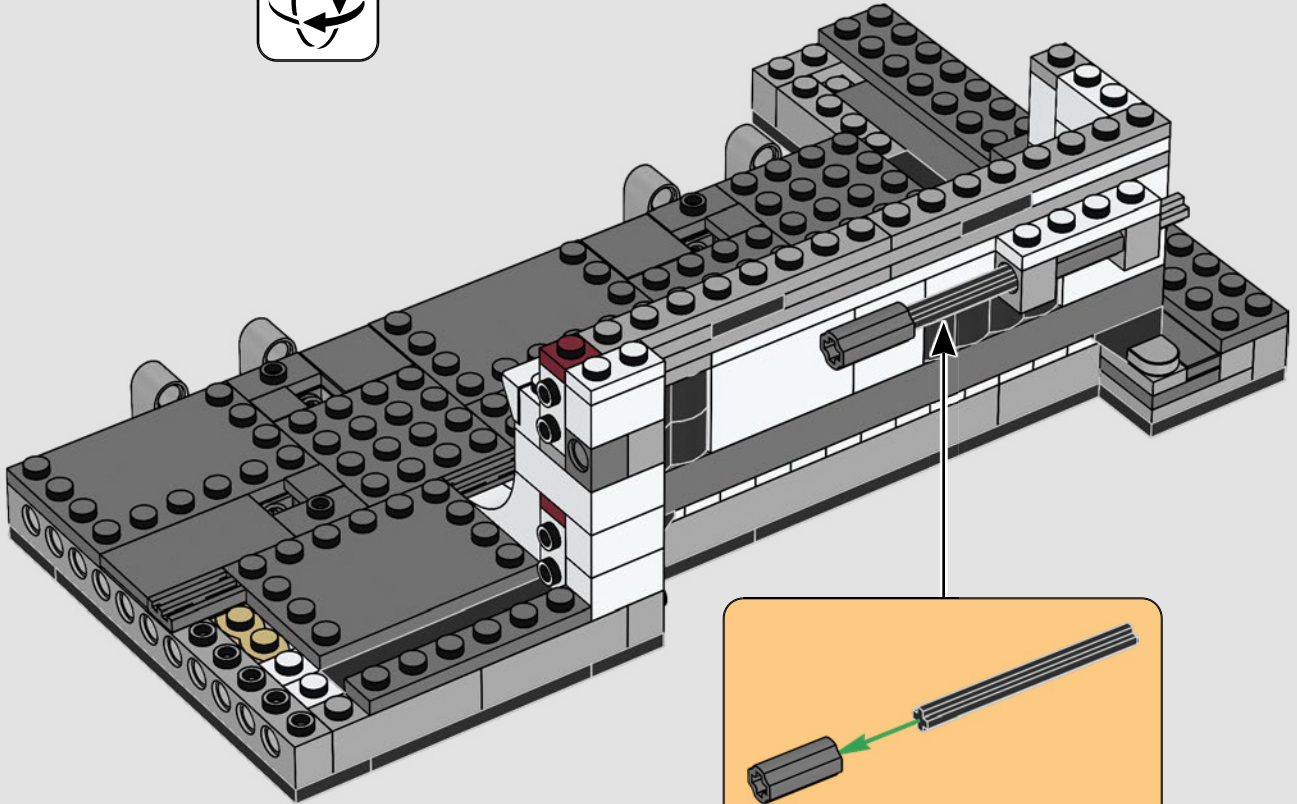

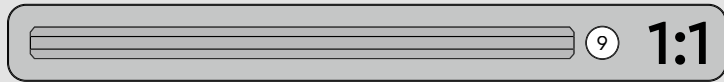
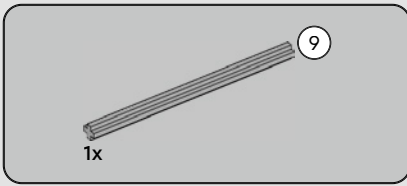

64

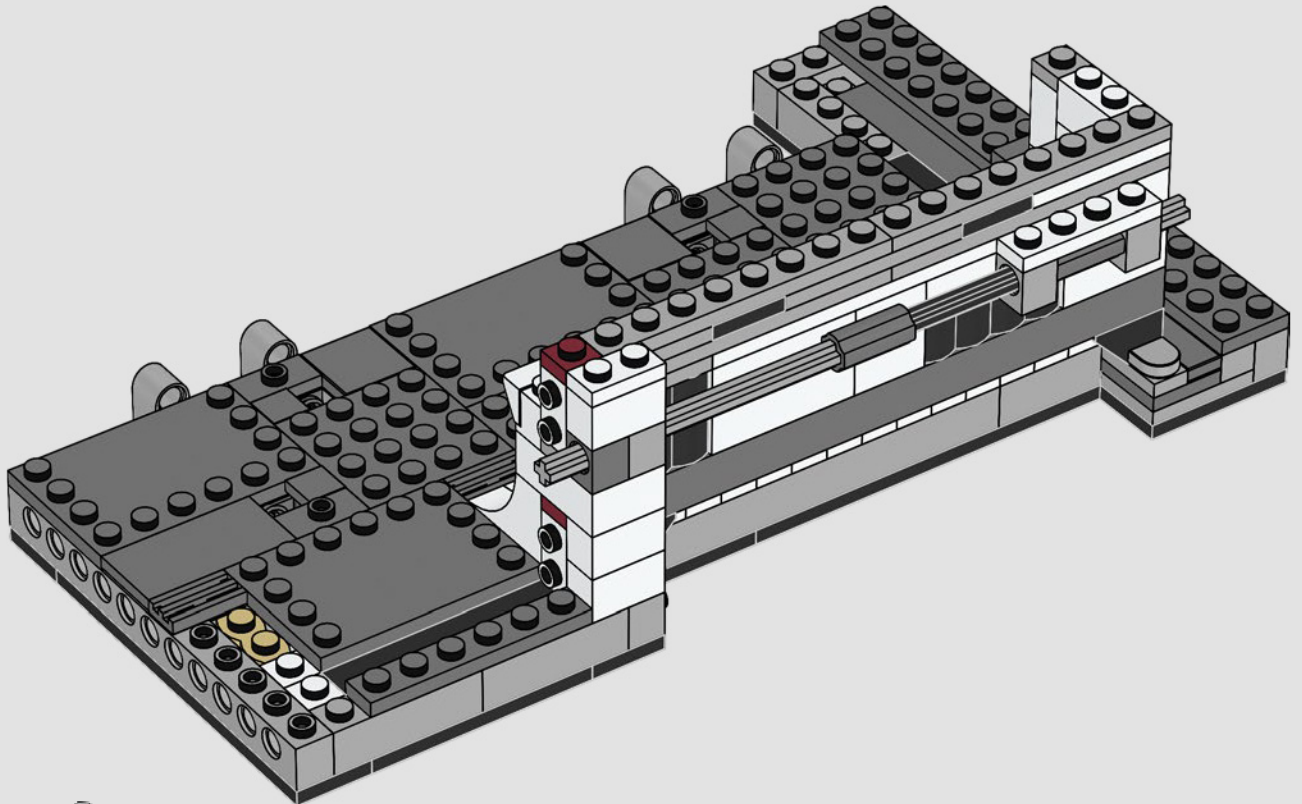

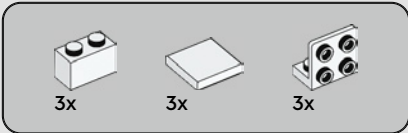

65

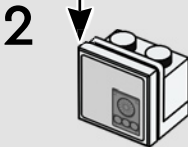
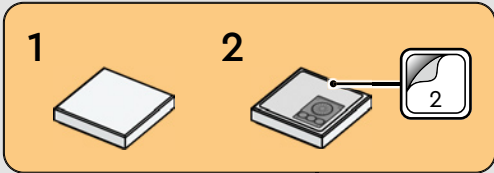
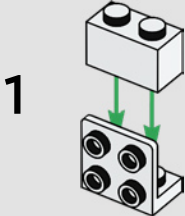

3x

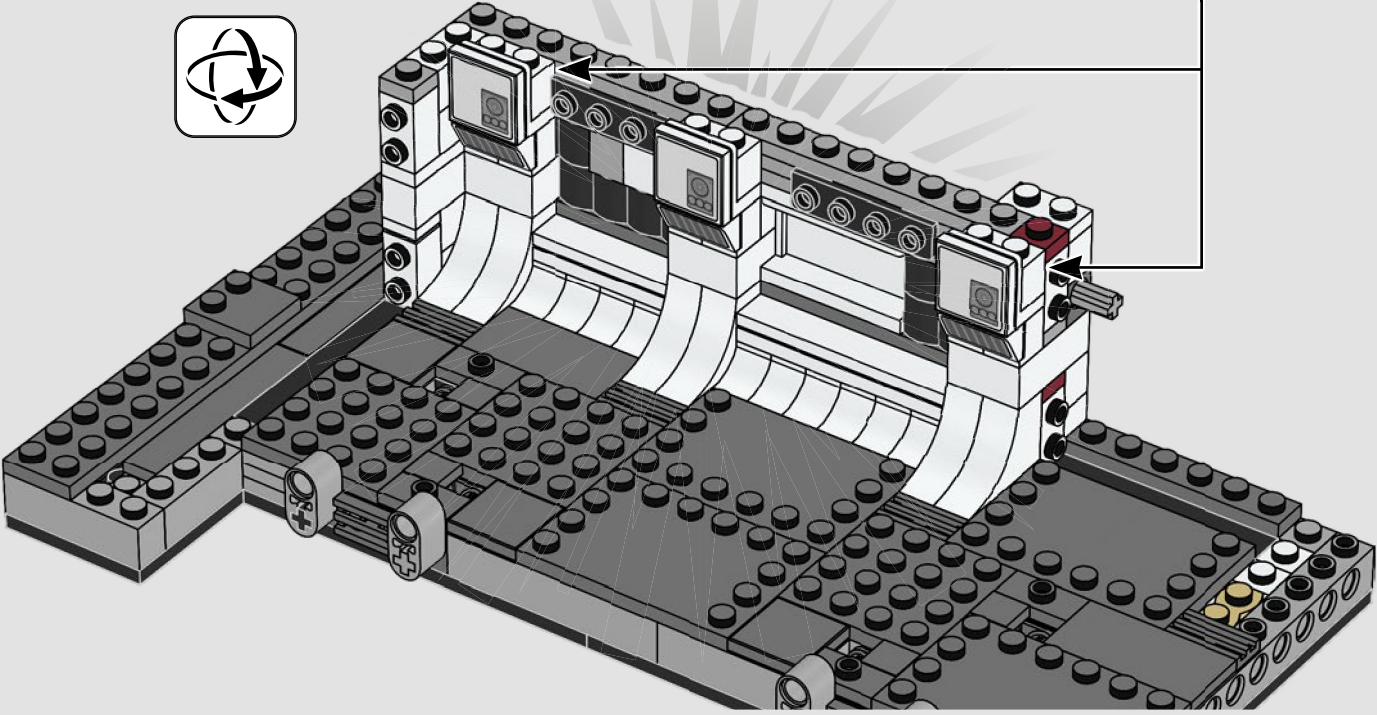



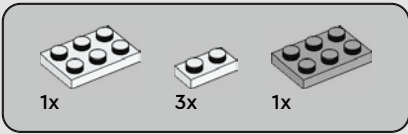

66

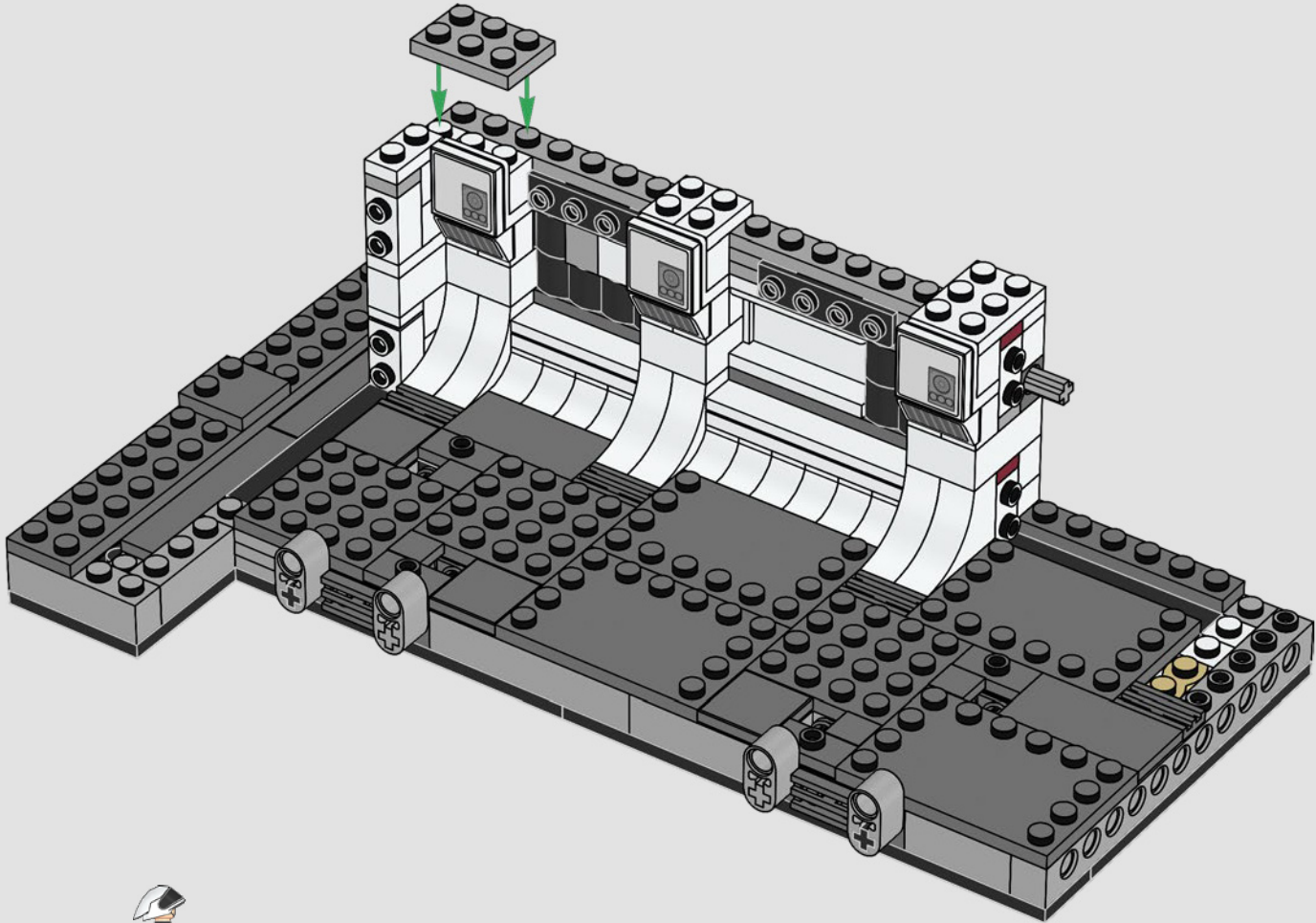

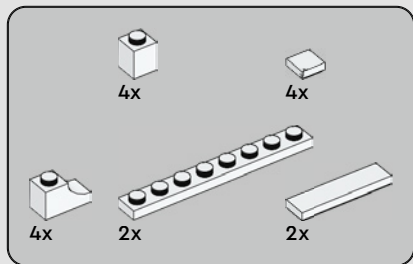

67

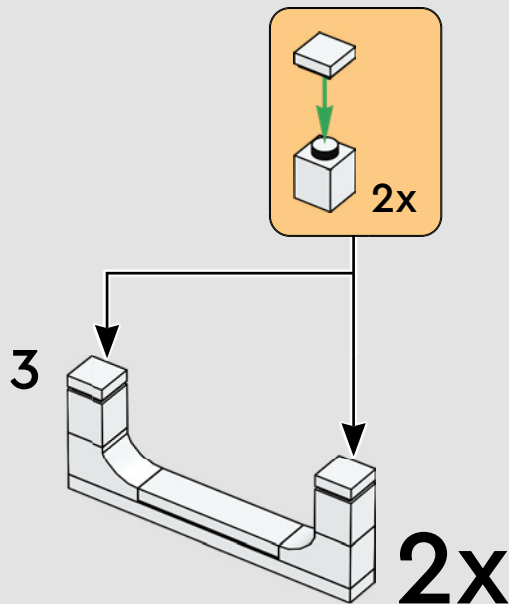
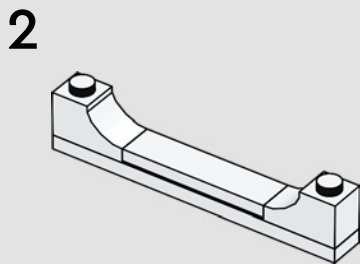
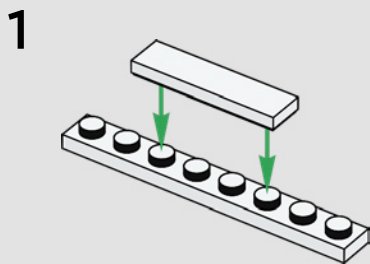

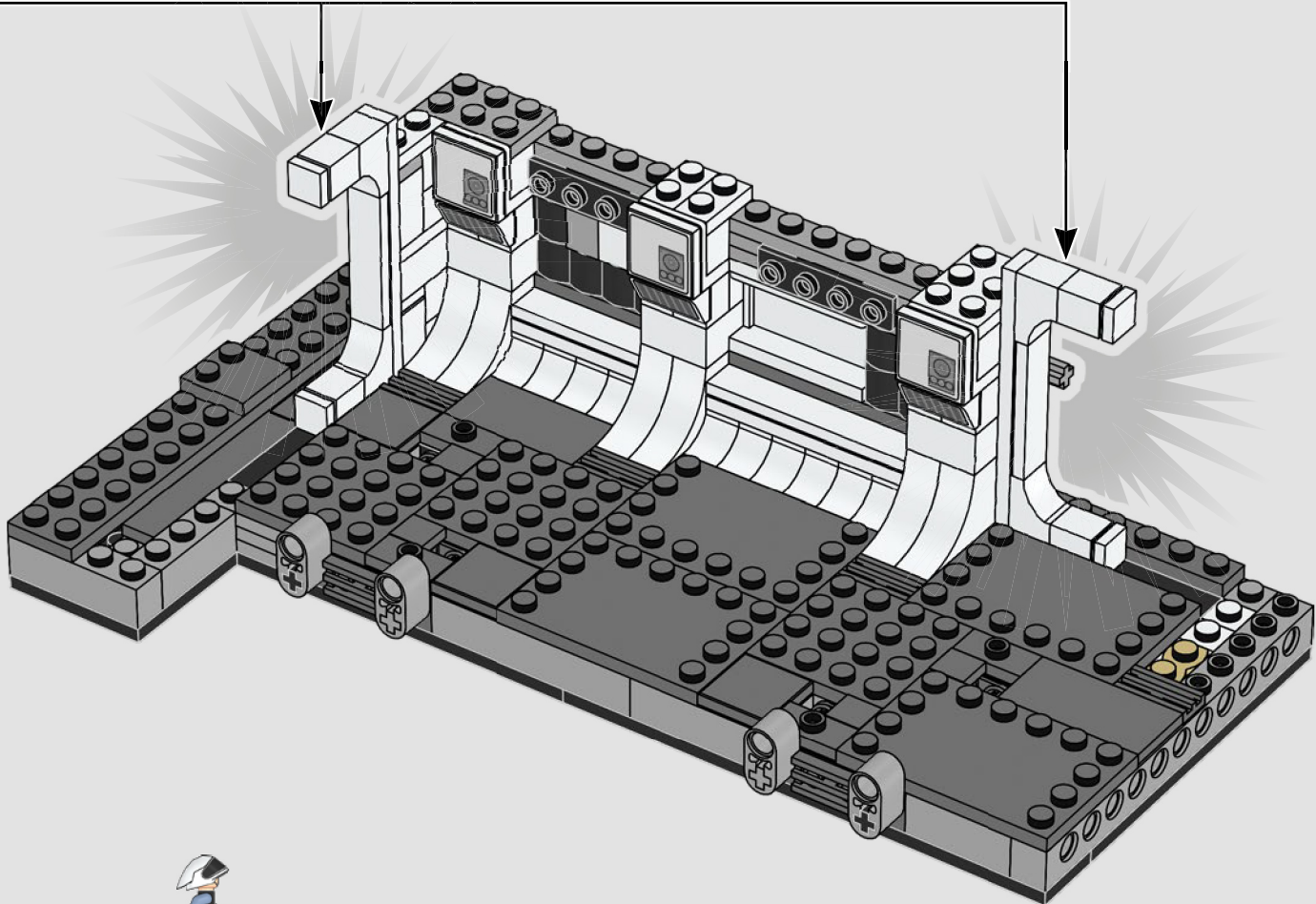

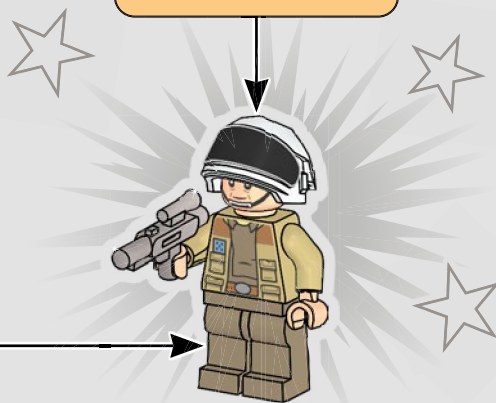
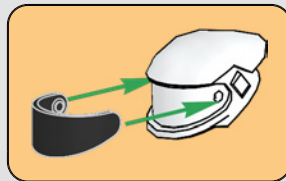
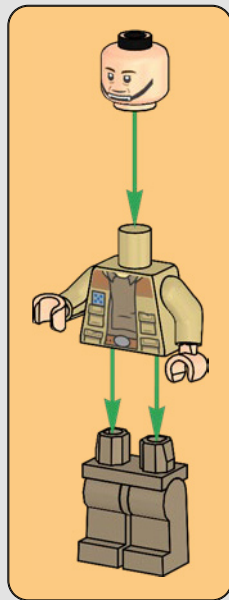

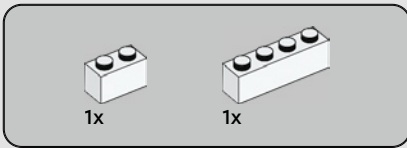

68

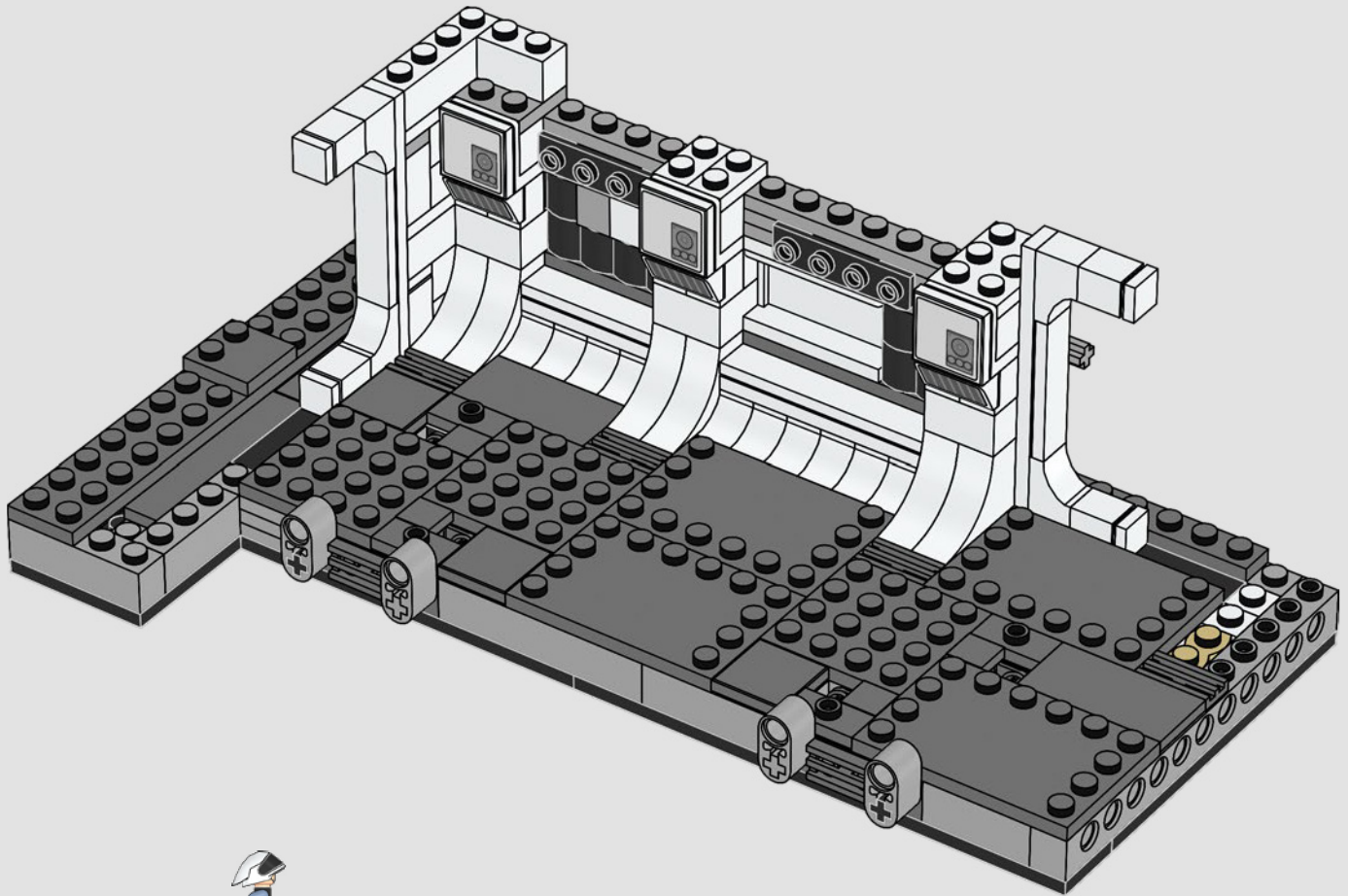

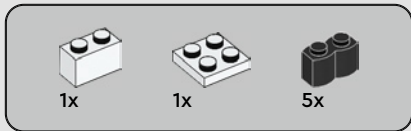

69

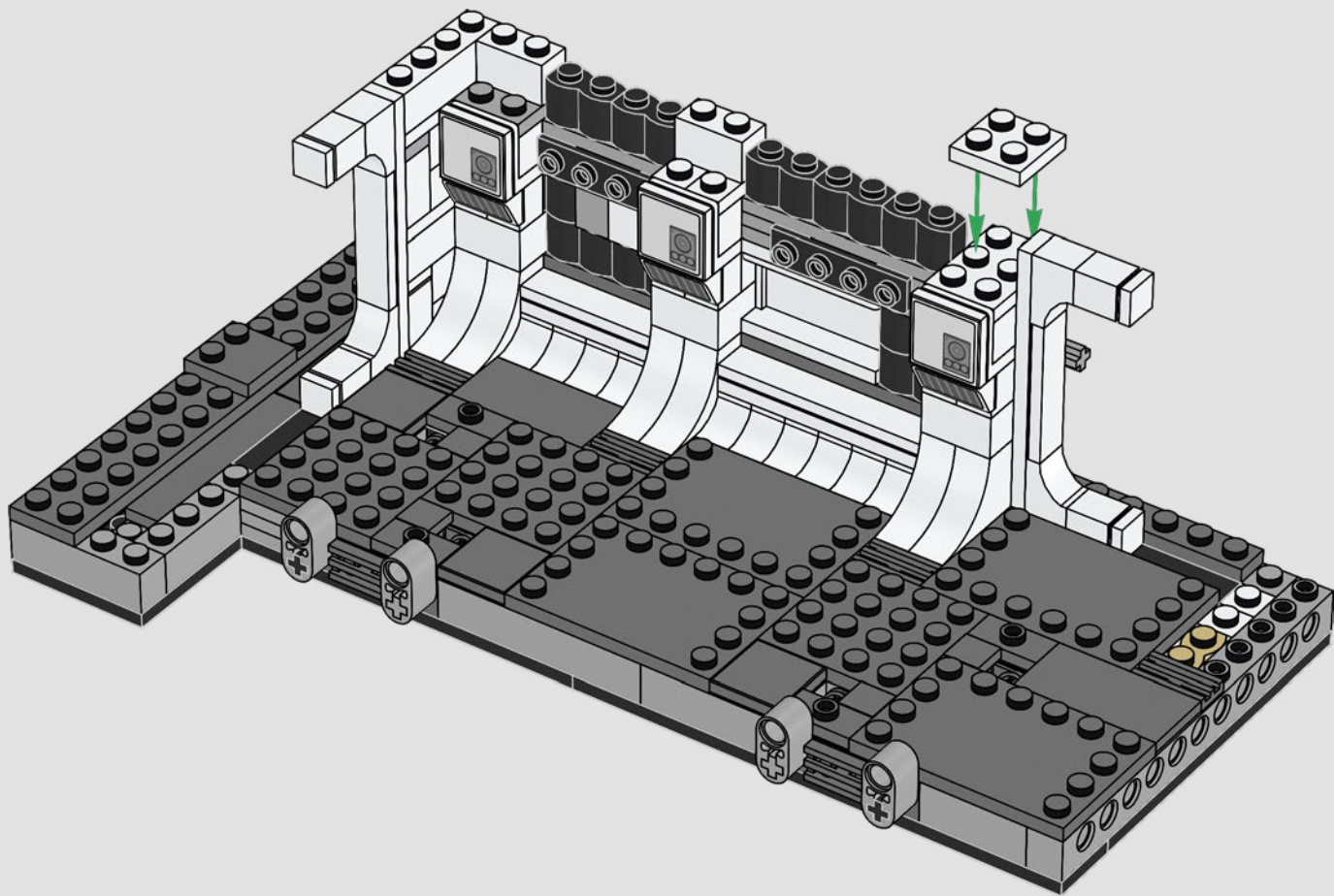

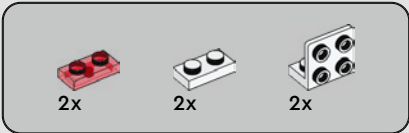

70

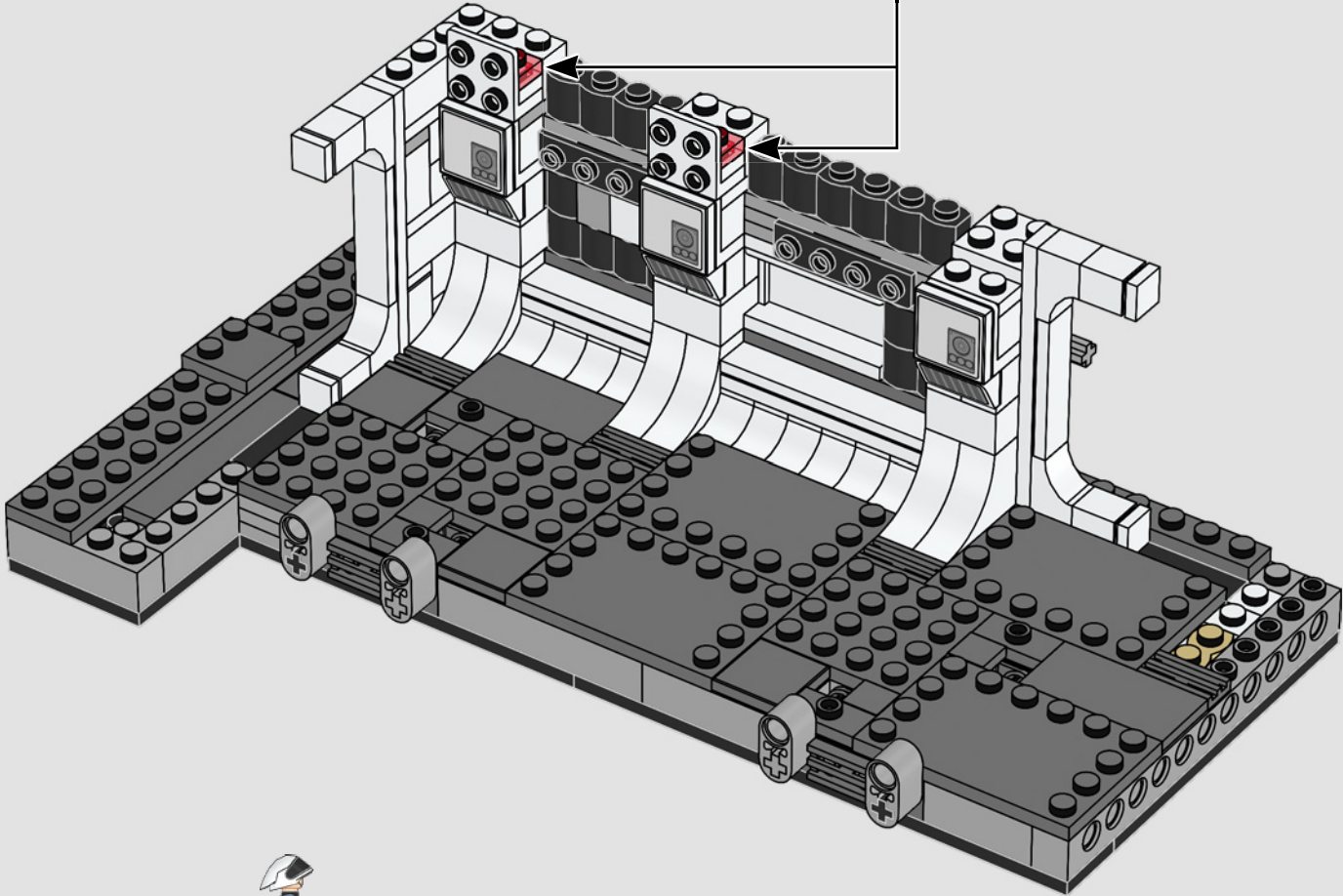
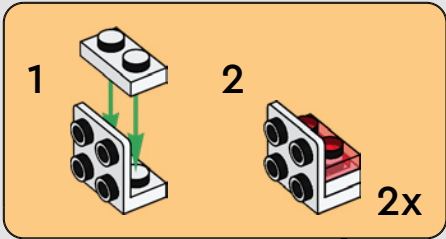



1x



1x

71

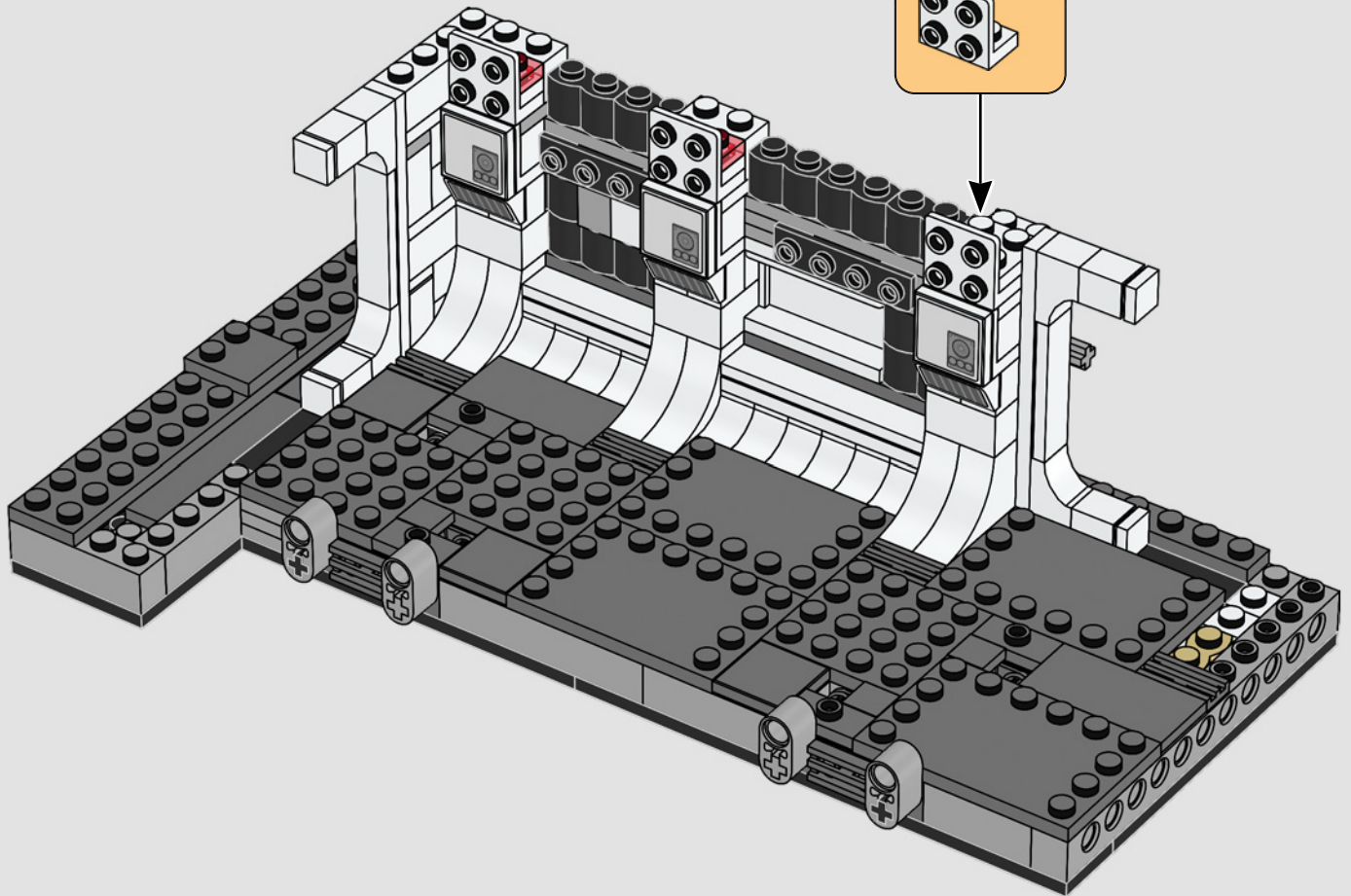
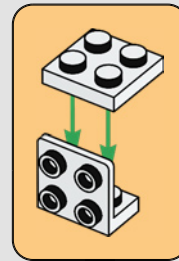



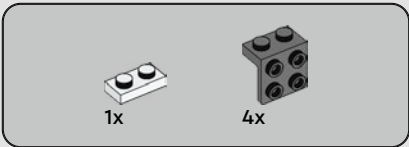

72

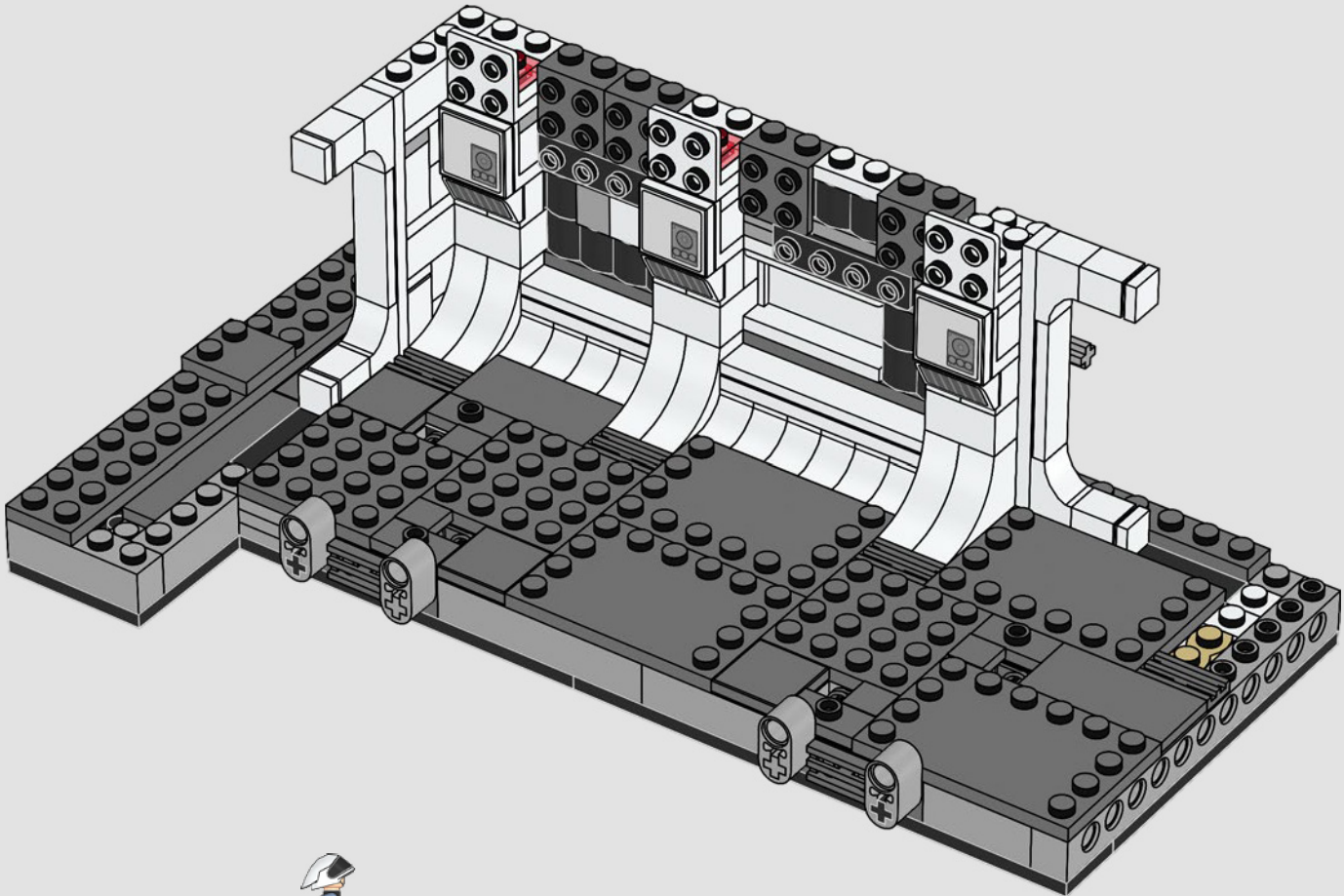

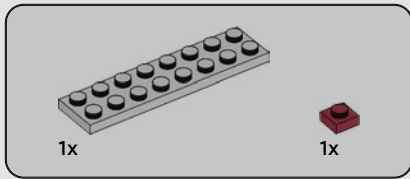

73

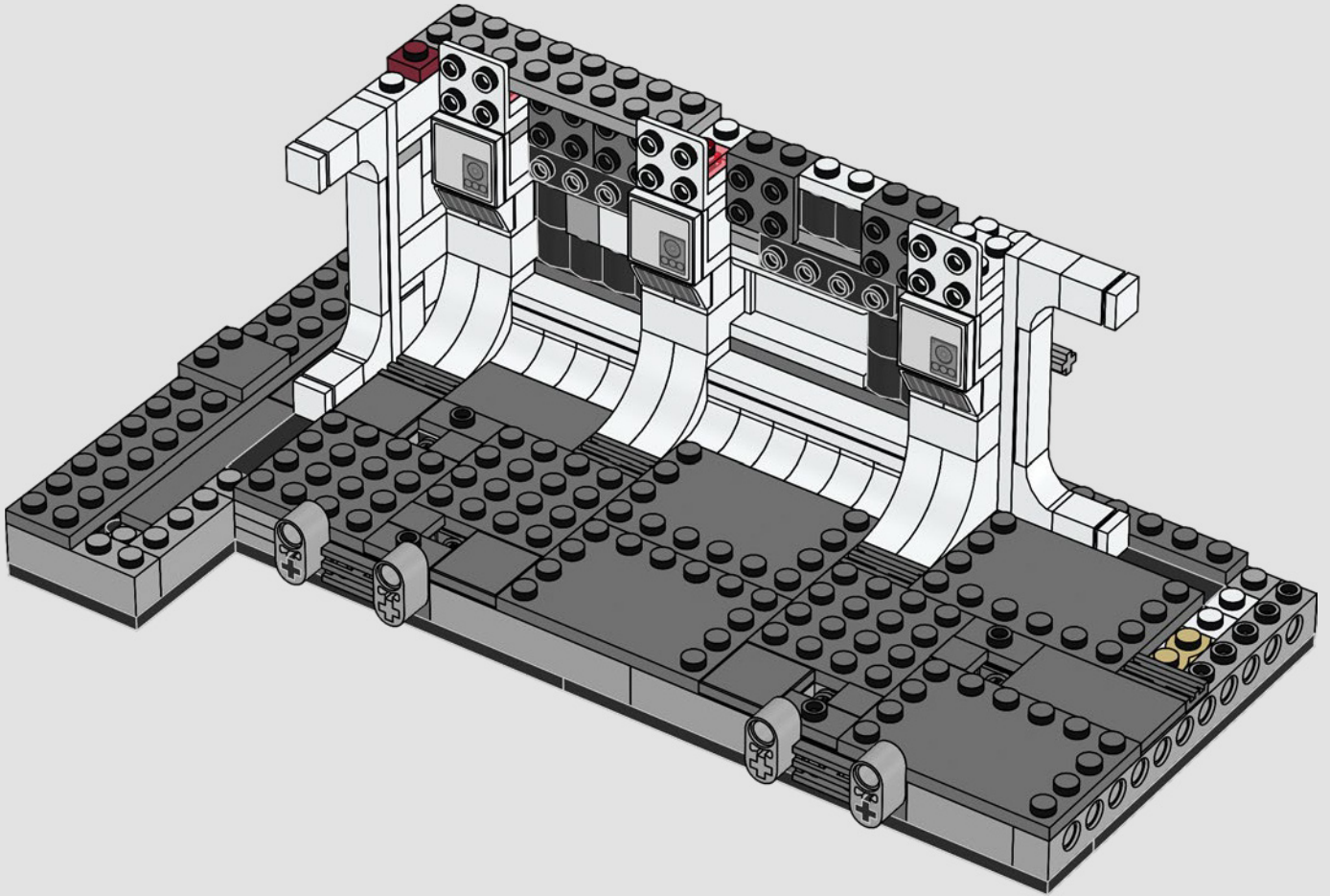

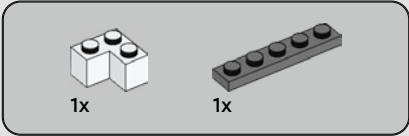
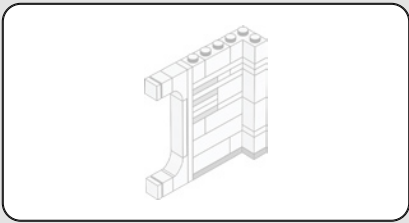

74

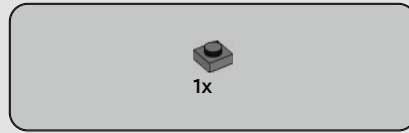
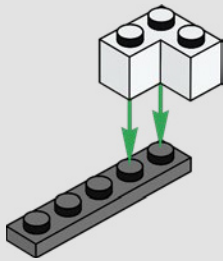

75

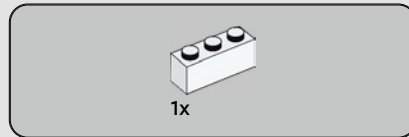
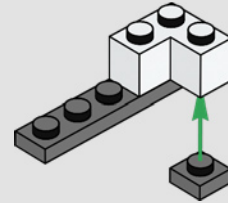

76

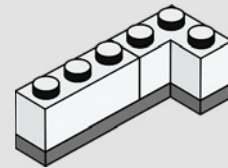

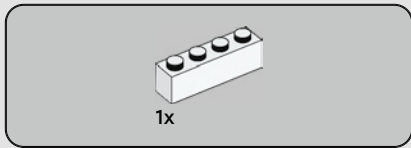

77

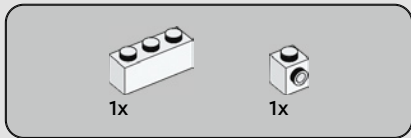
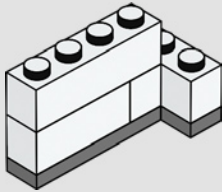

78

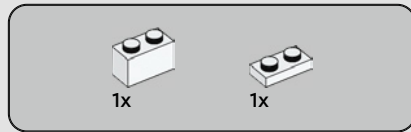
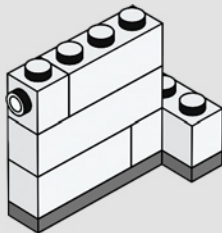

79

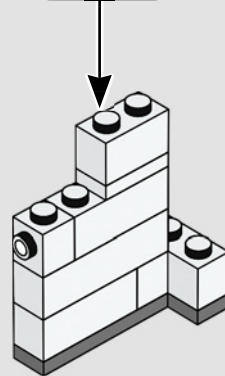
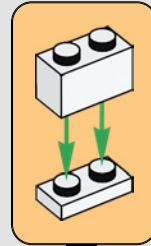



2x



2x

# 80

1

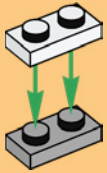

2

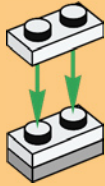

3

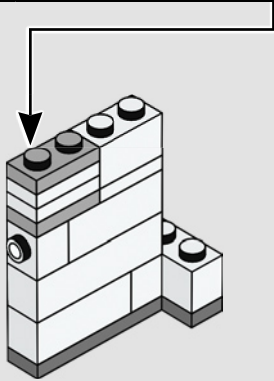

1x

# 81

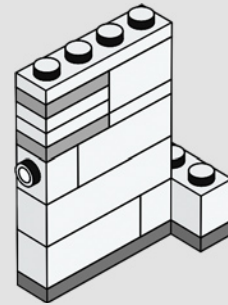

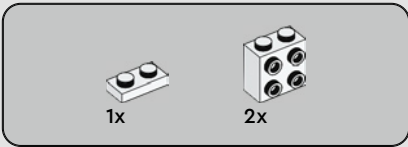

82

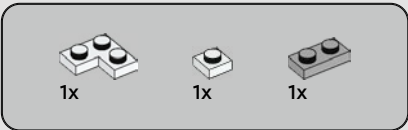
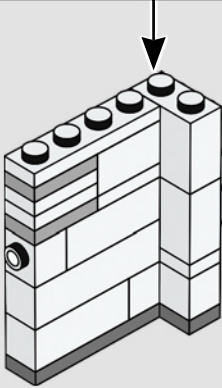
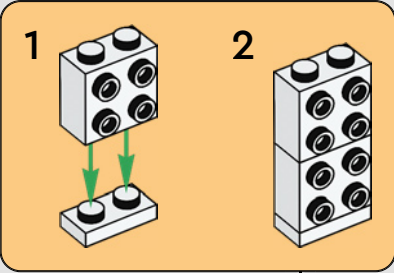

83

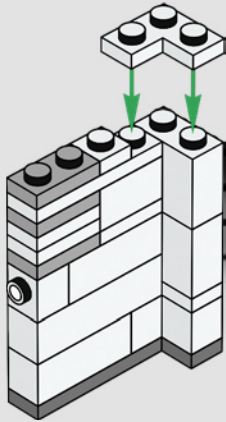

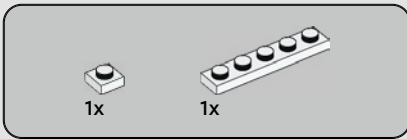

84

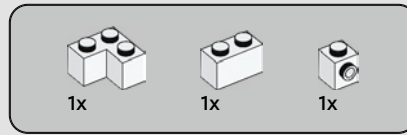
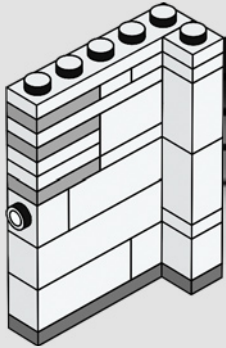

85

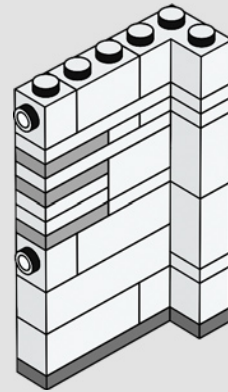

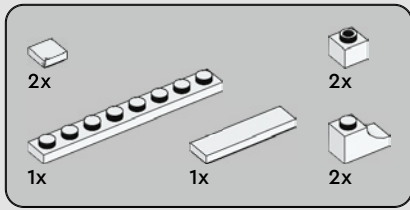

86

1

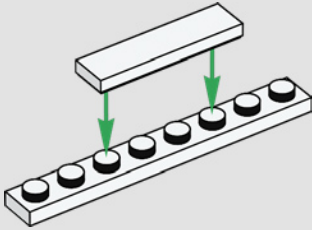

2

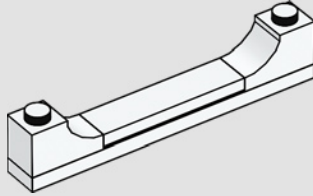

3

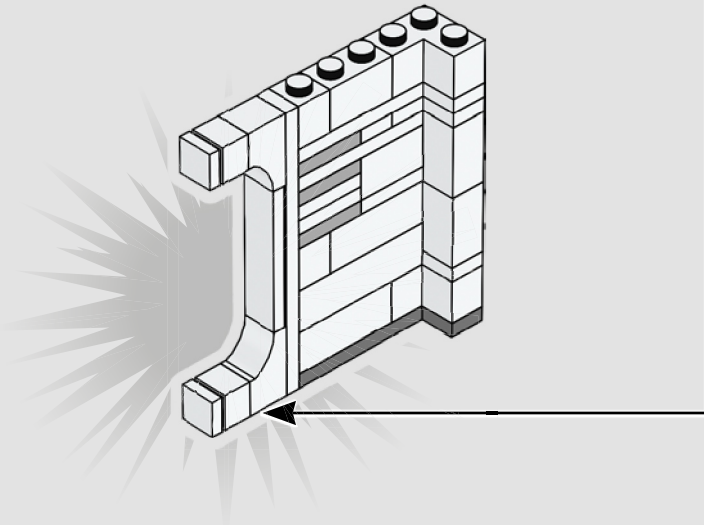
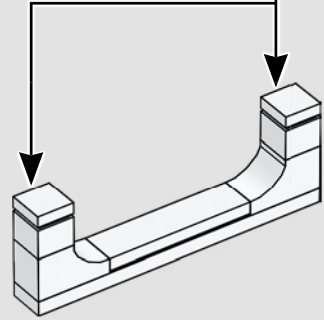



87

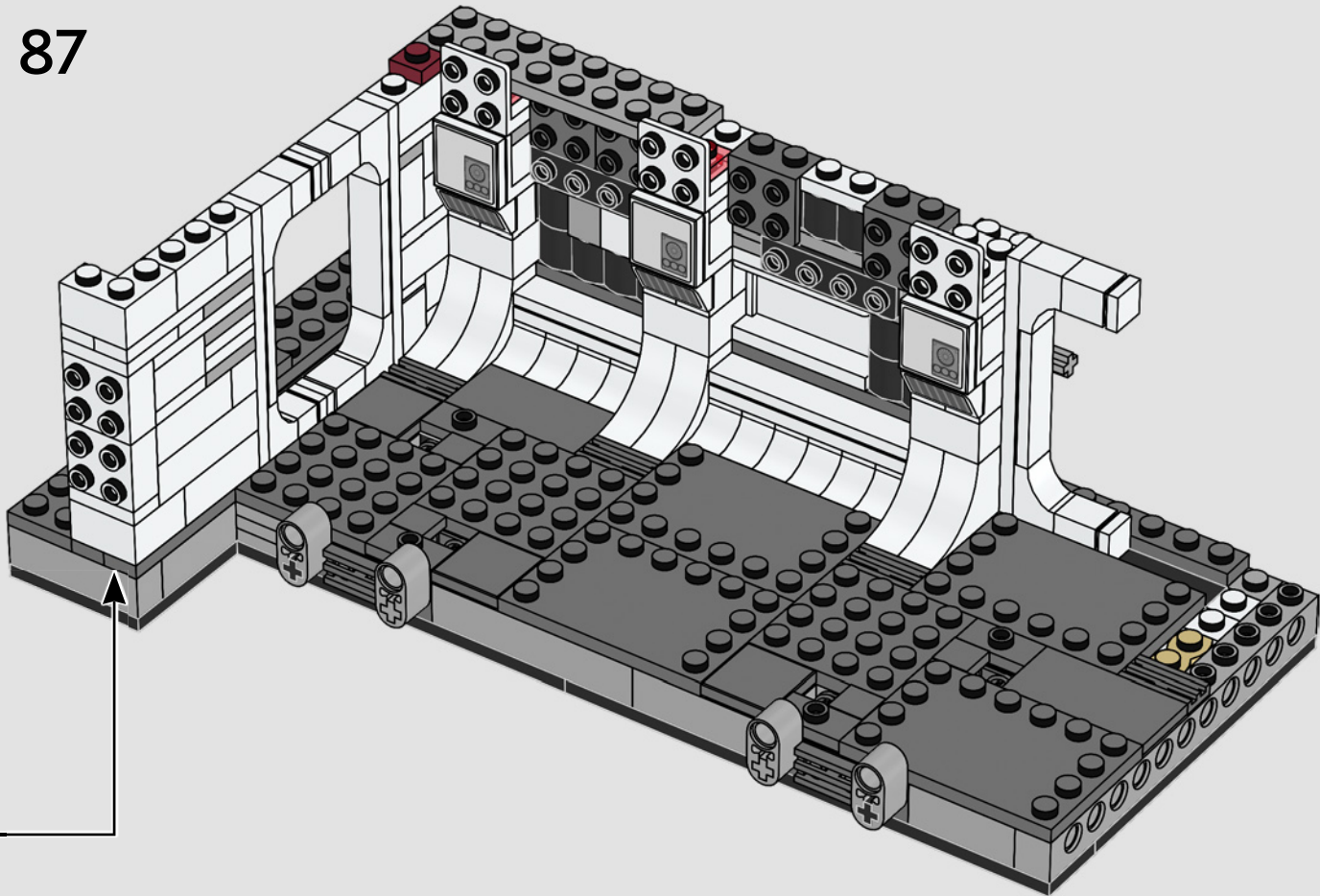

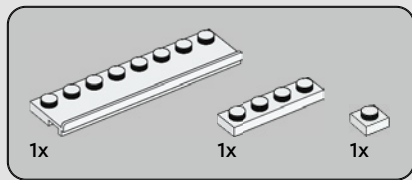

88

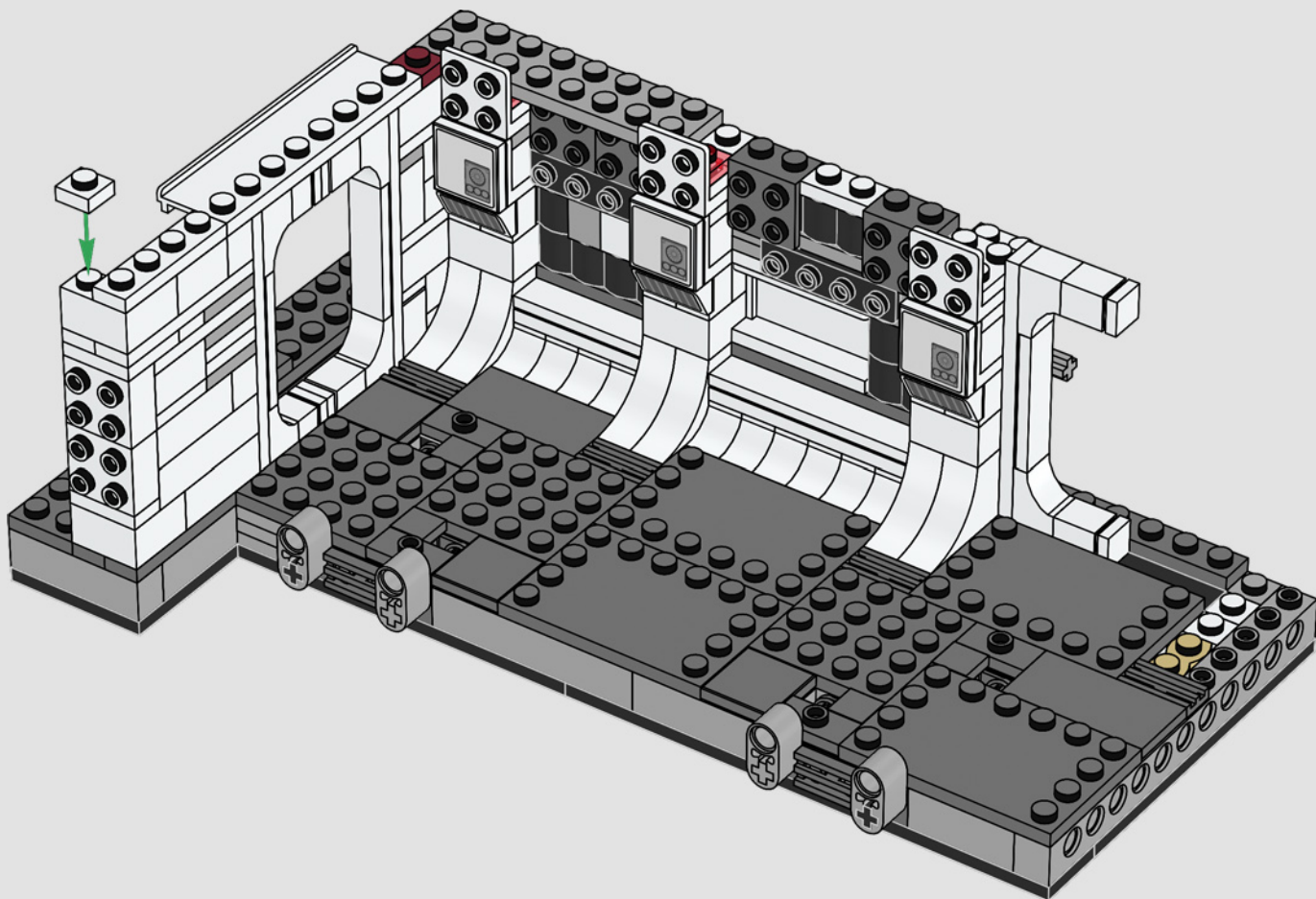

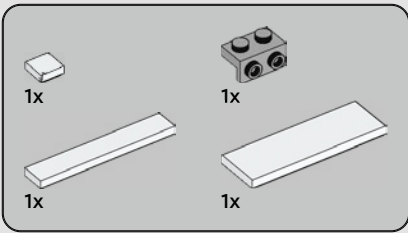

89

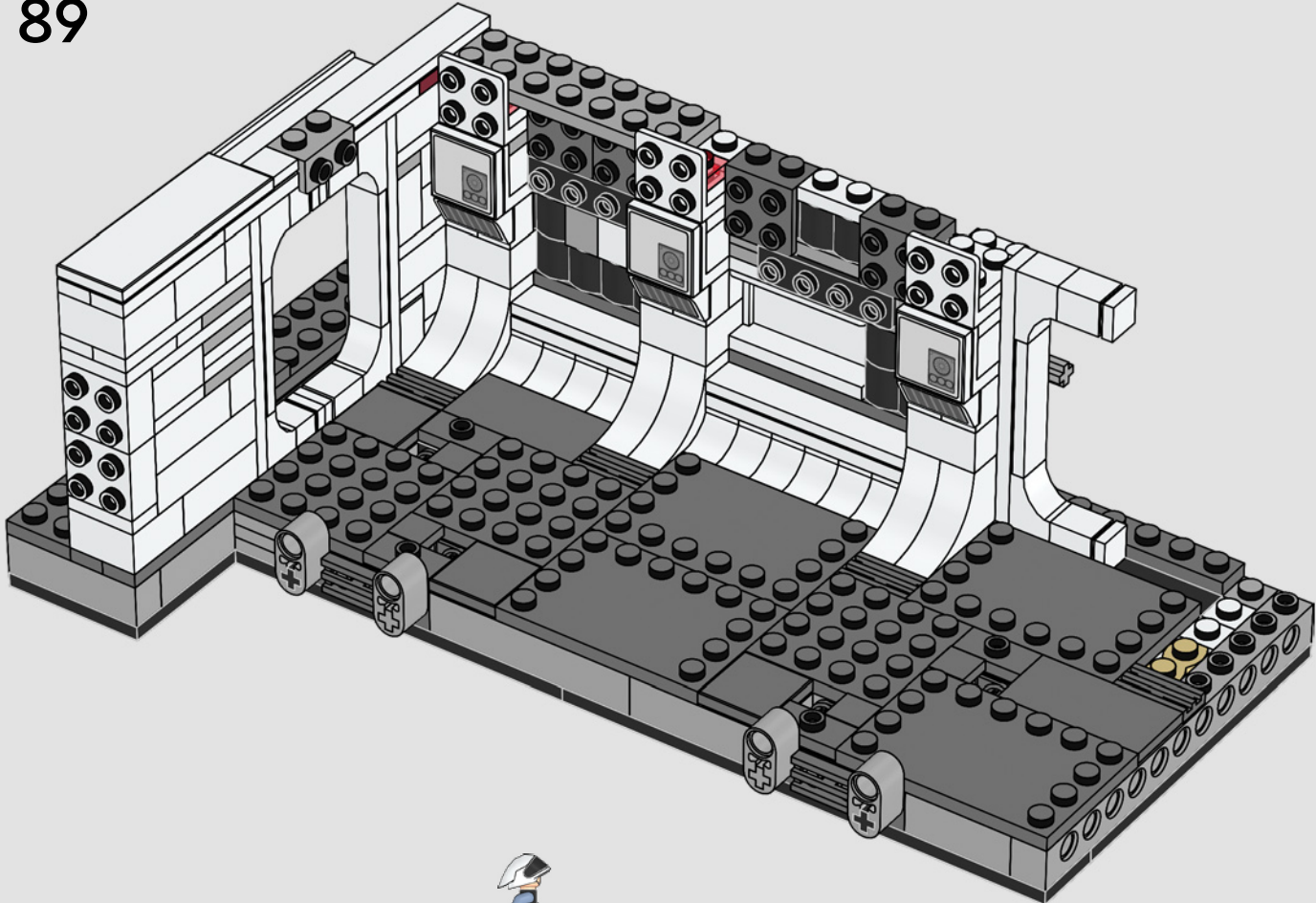

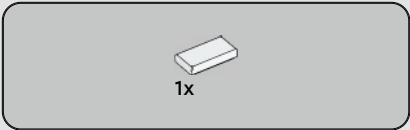

90

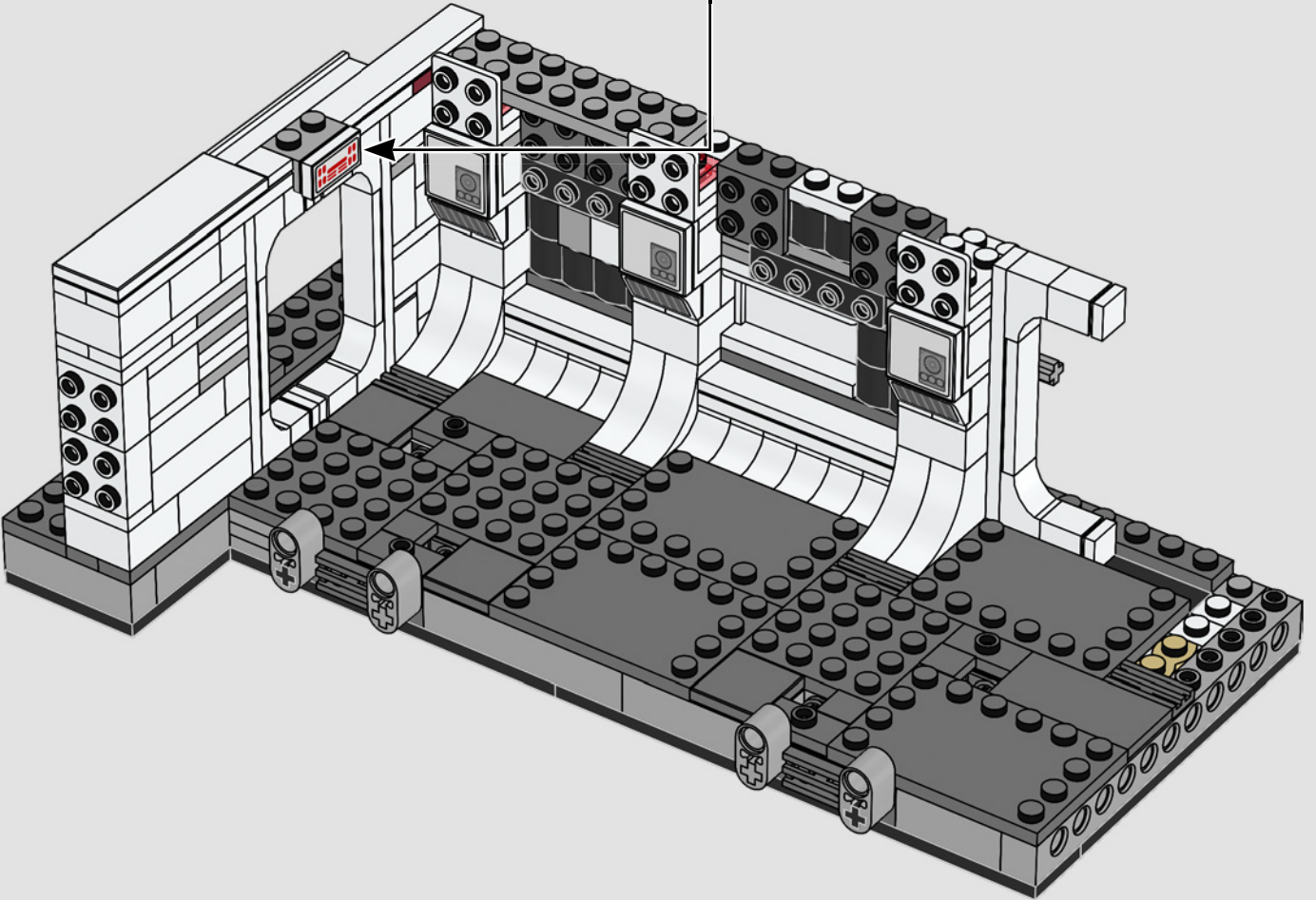
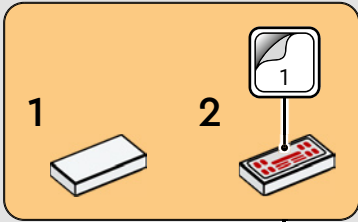



91

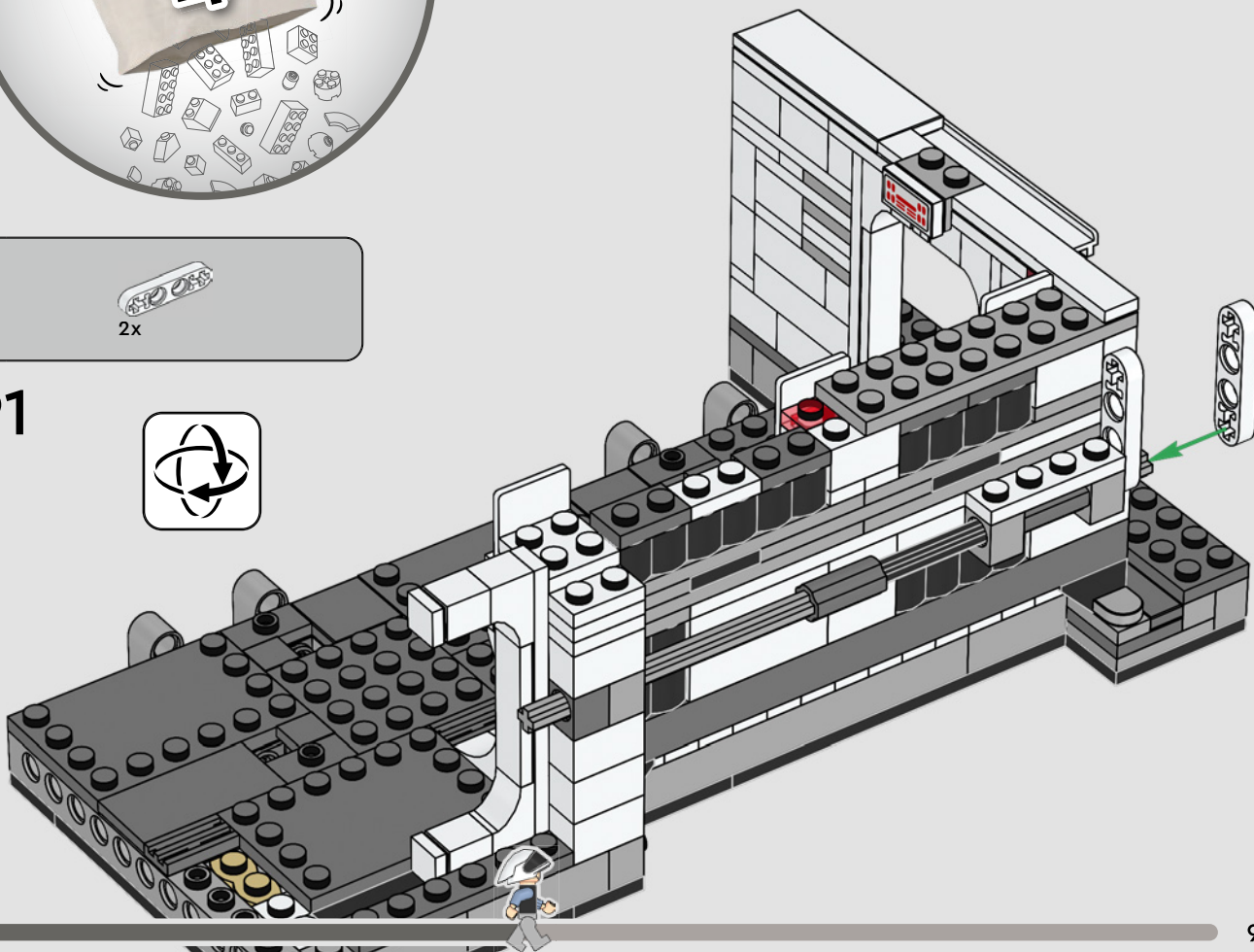

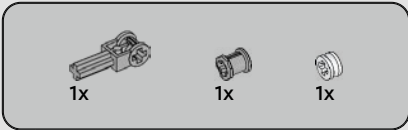

92

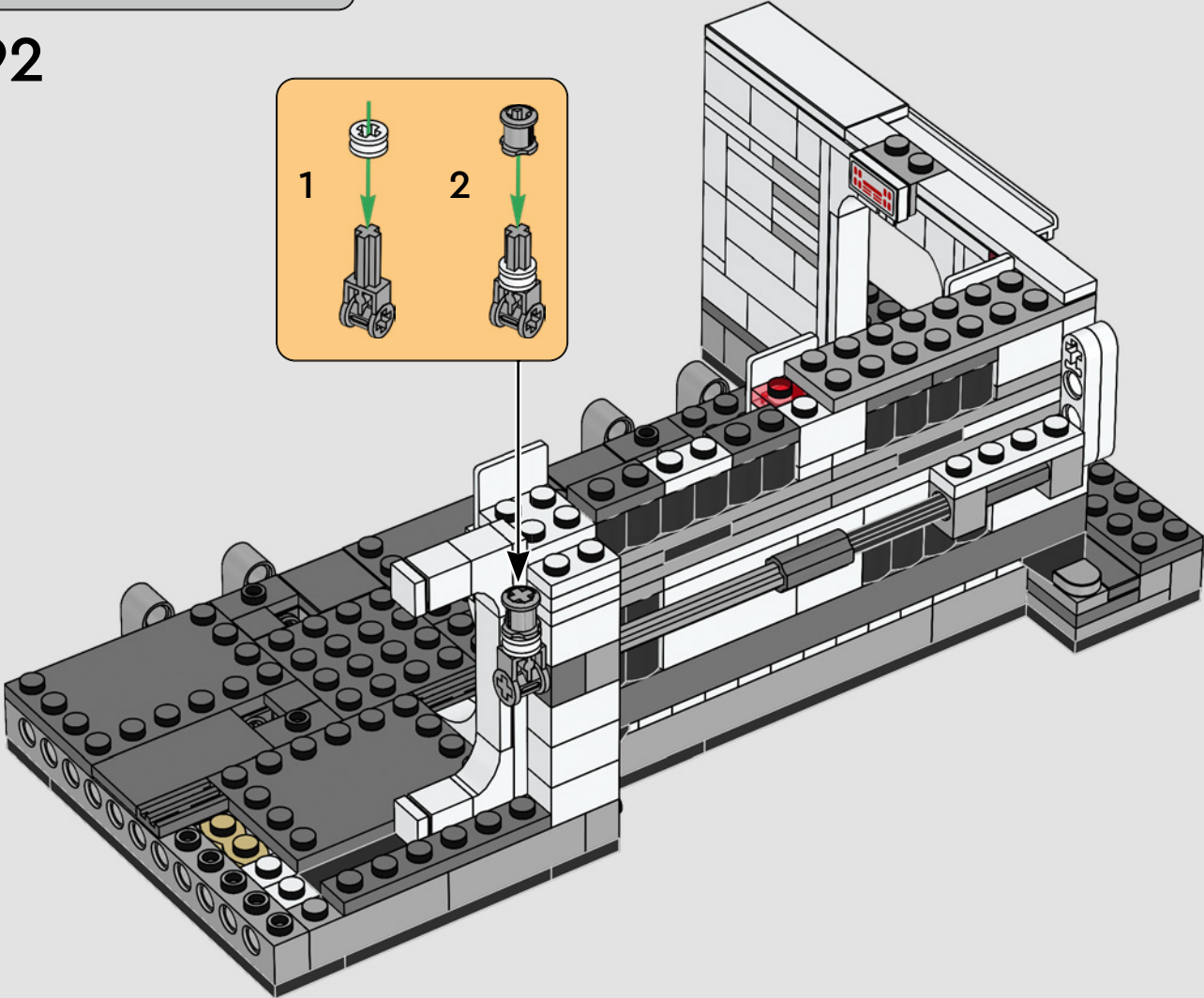
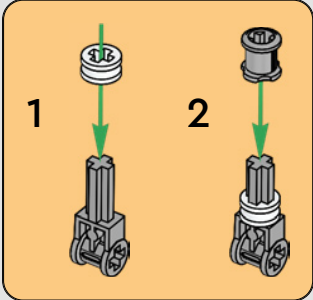

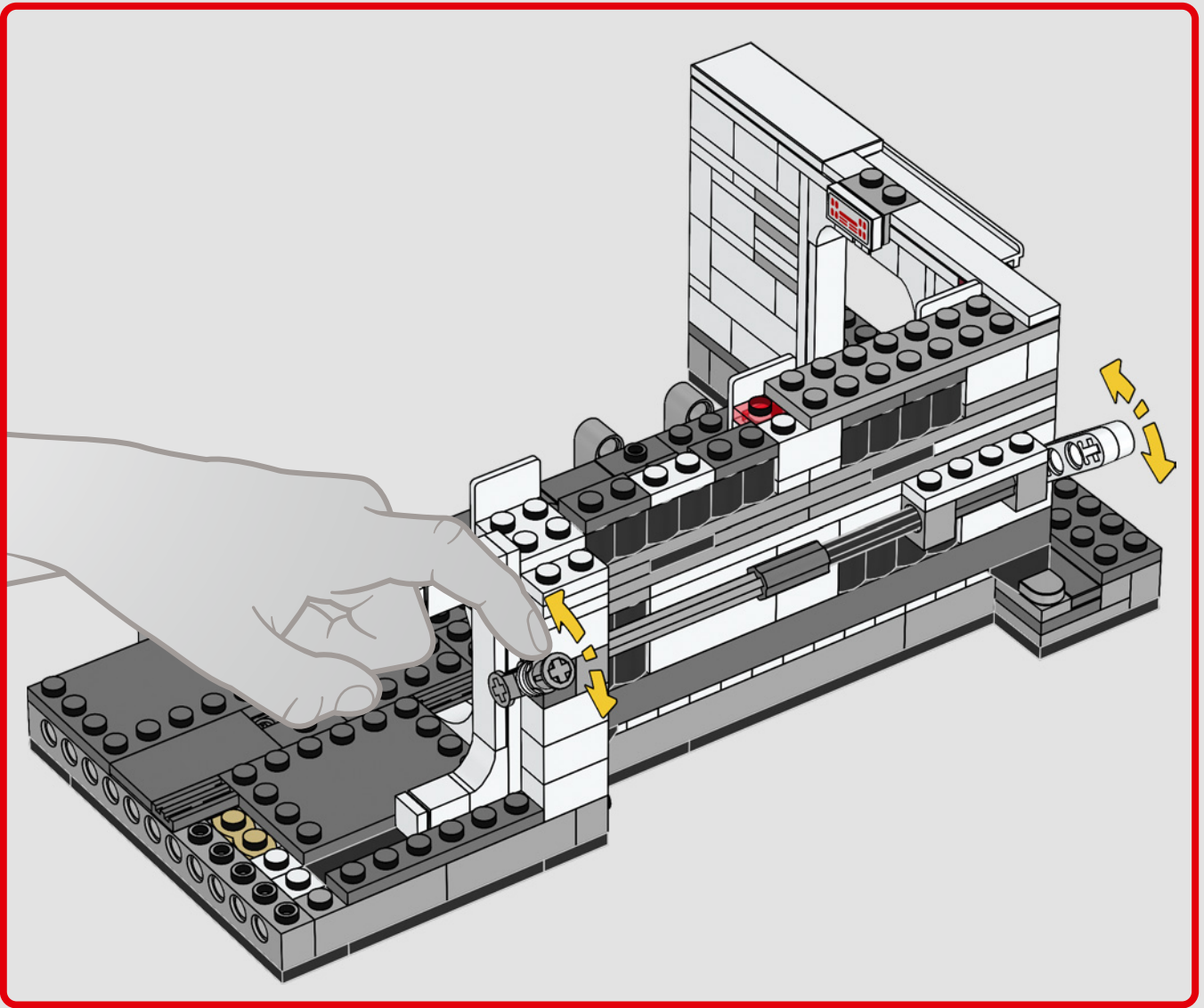

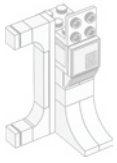

2x

93

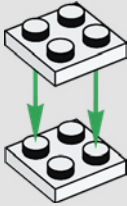

1x



1x



1x



1x

94

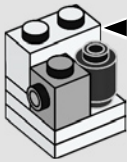
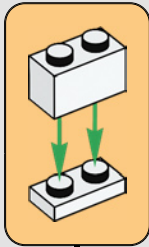

1x

95

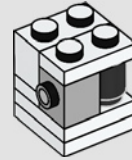

1x

96

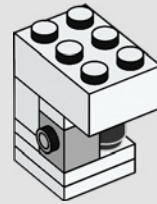



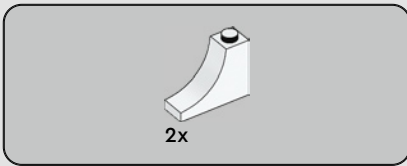

97

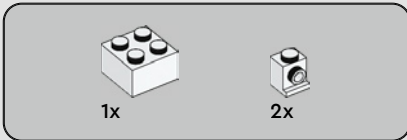
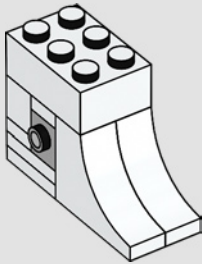

98

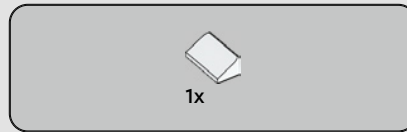
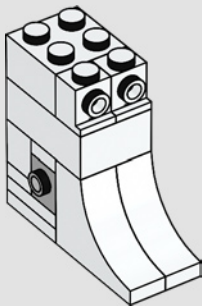

99

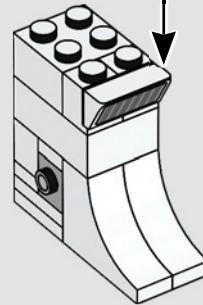
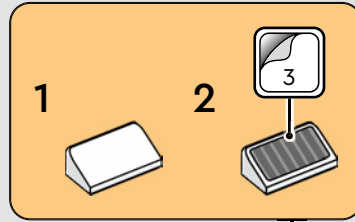

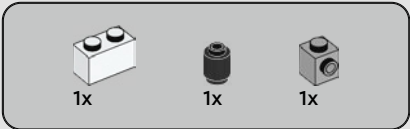

# 100

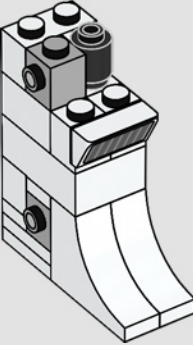

# 101

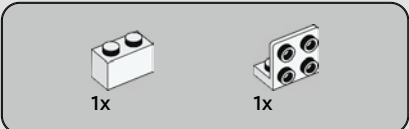
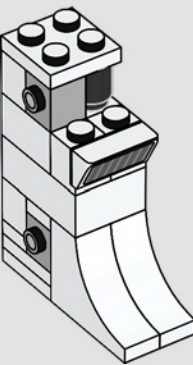

# 102

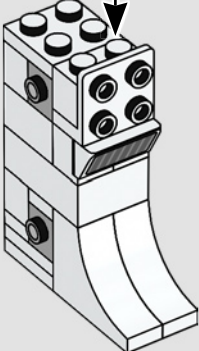
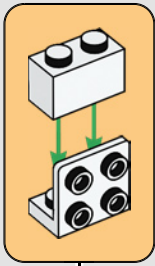

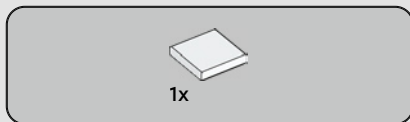

103

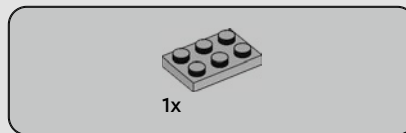
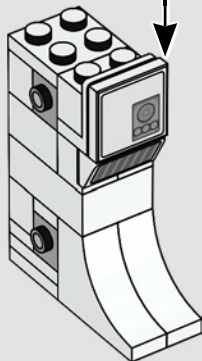
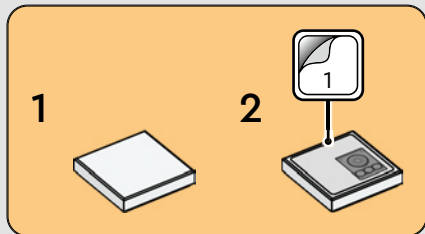

104

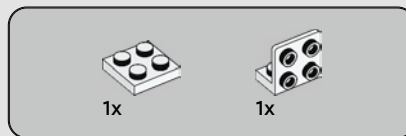
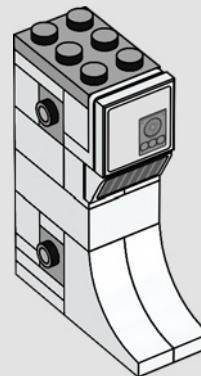

105

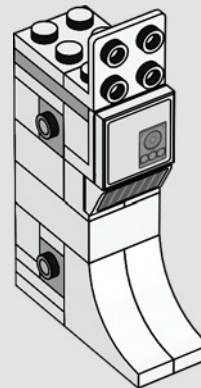

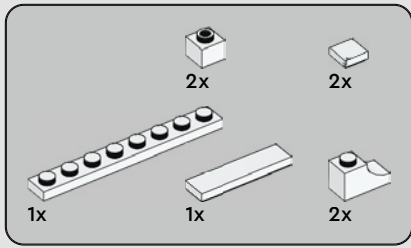

106

1

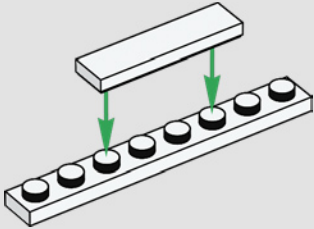

2

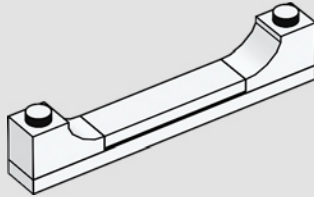

3

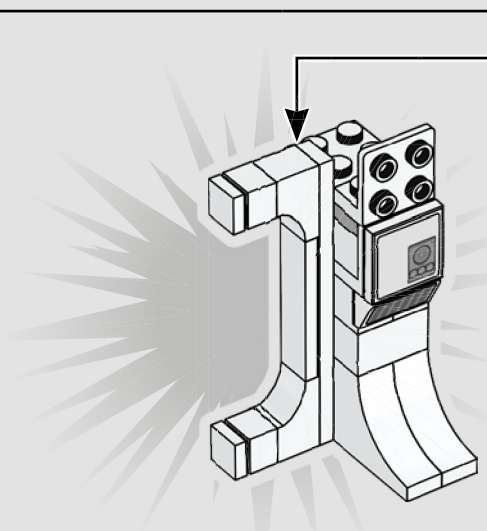
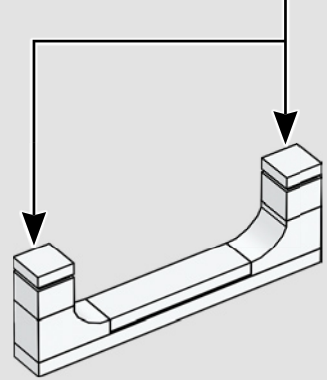

107

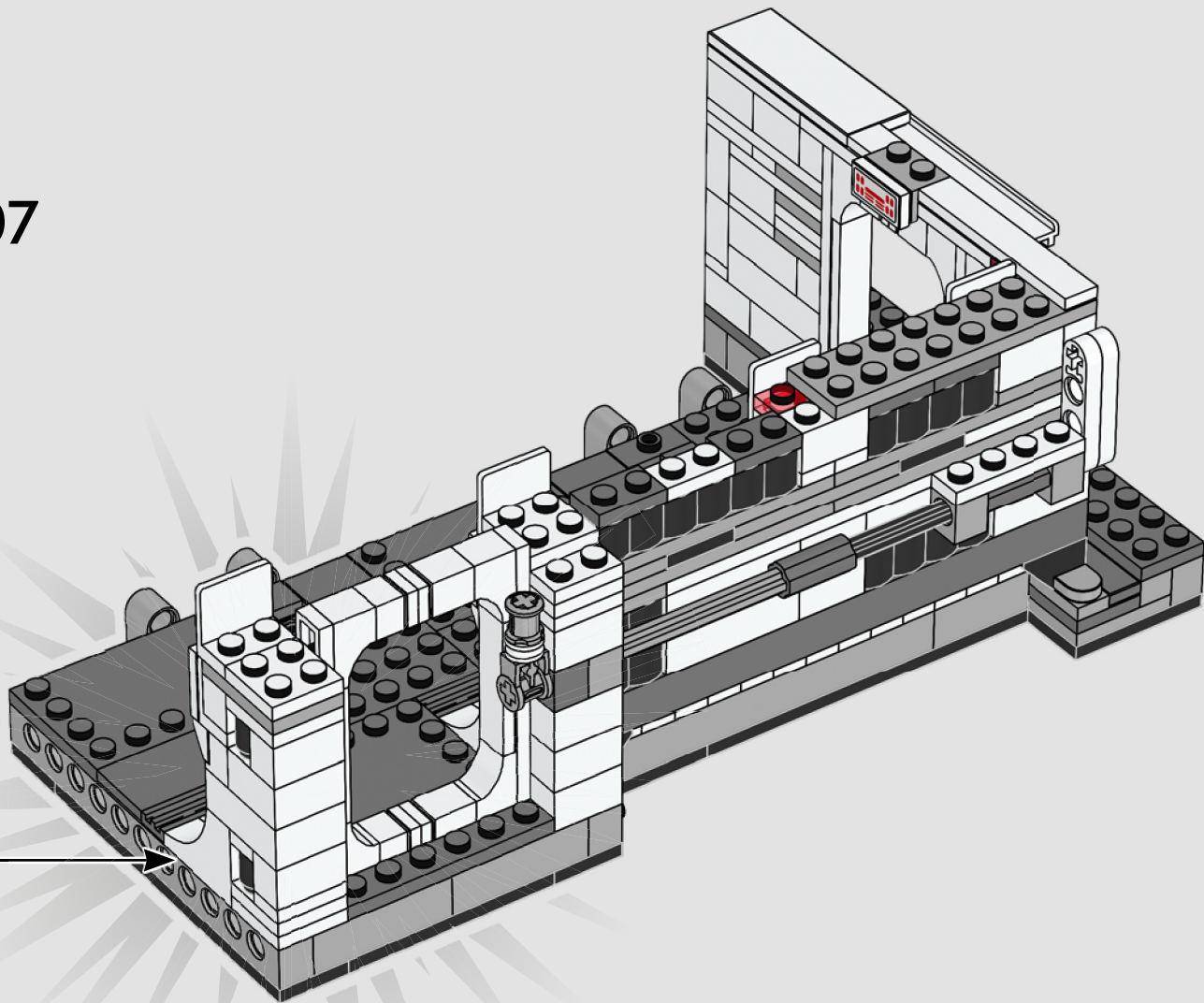

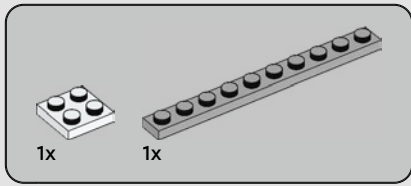

108

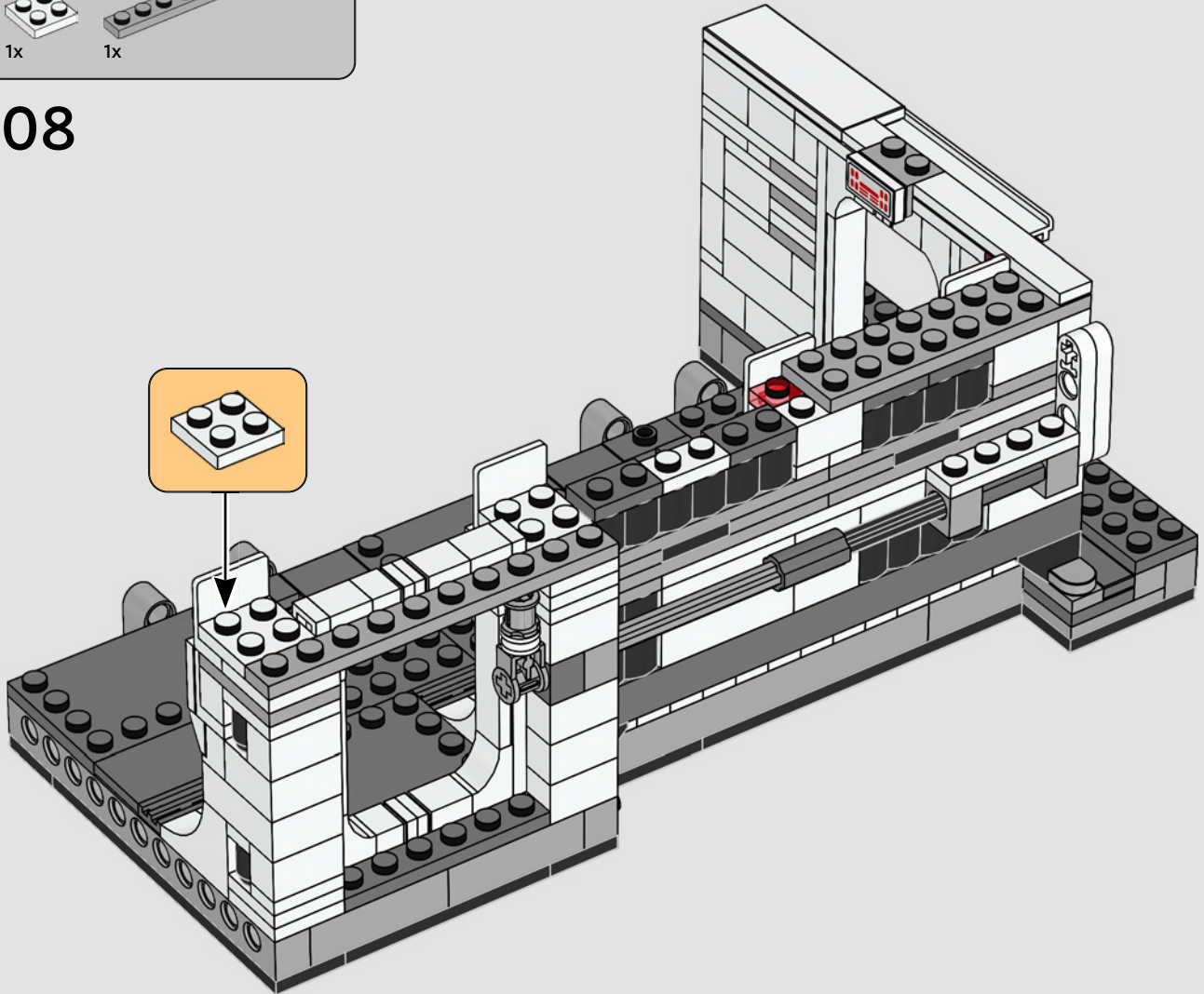

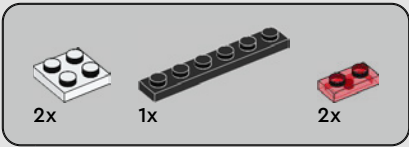

109

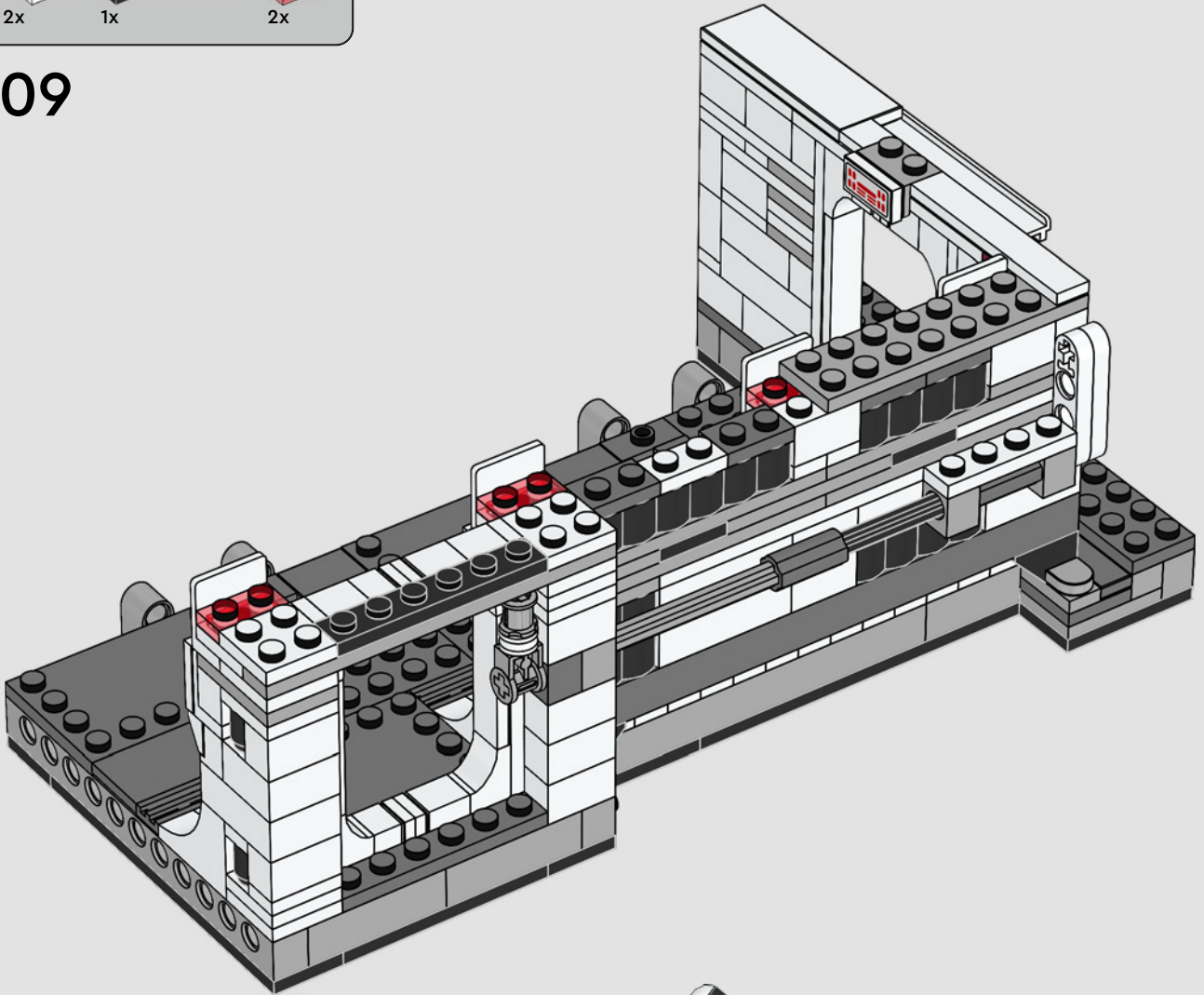

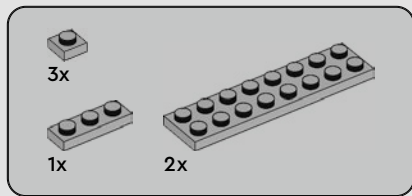

110

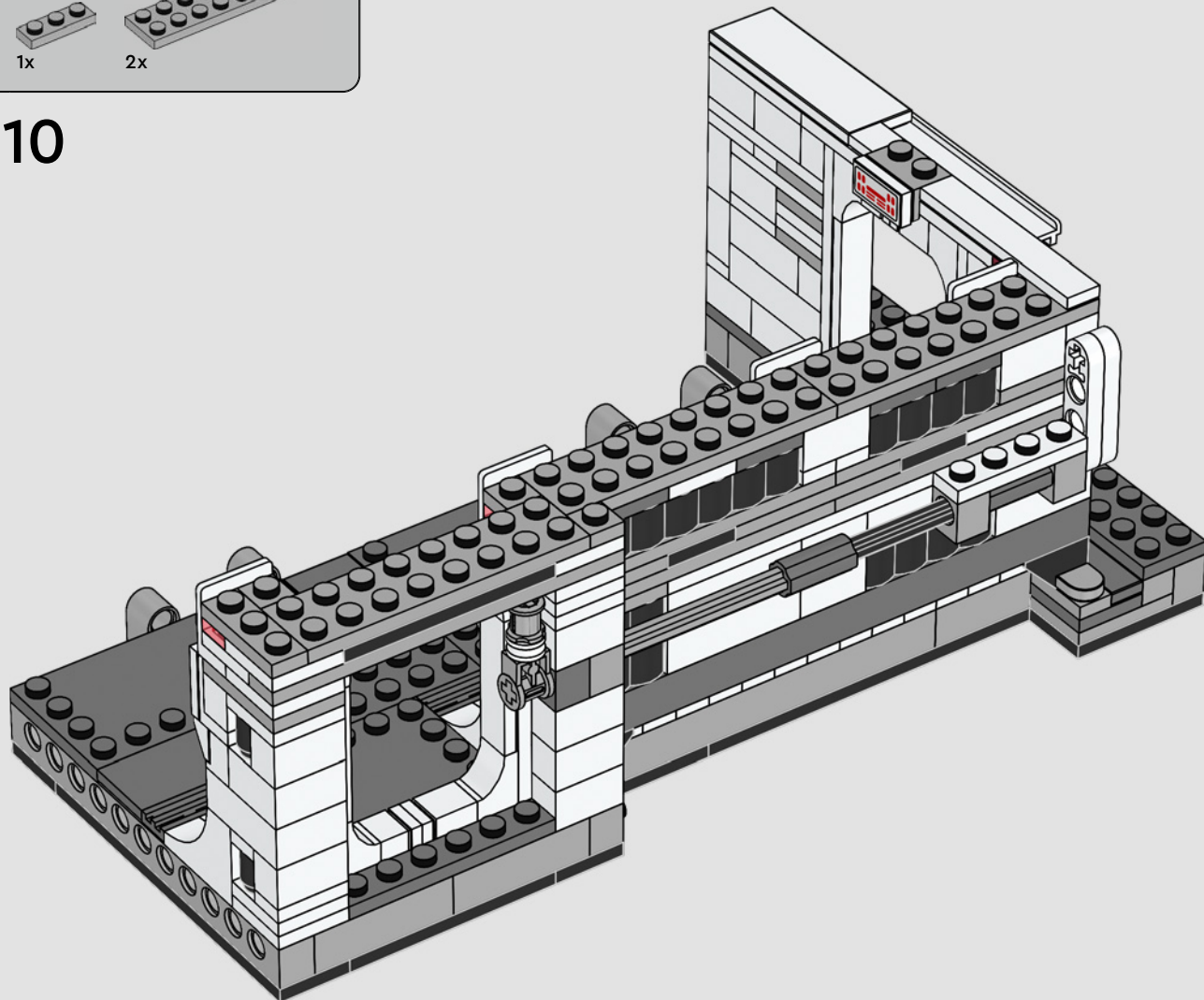



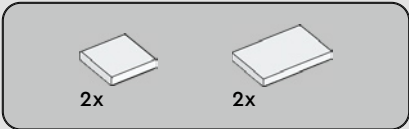

111

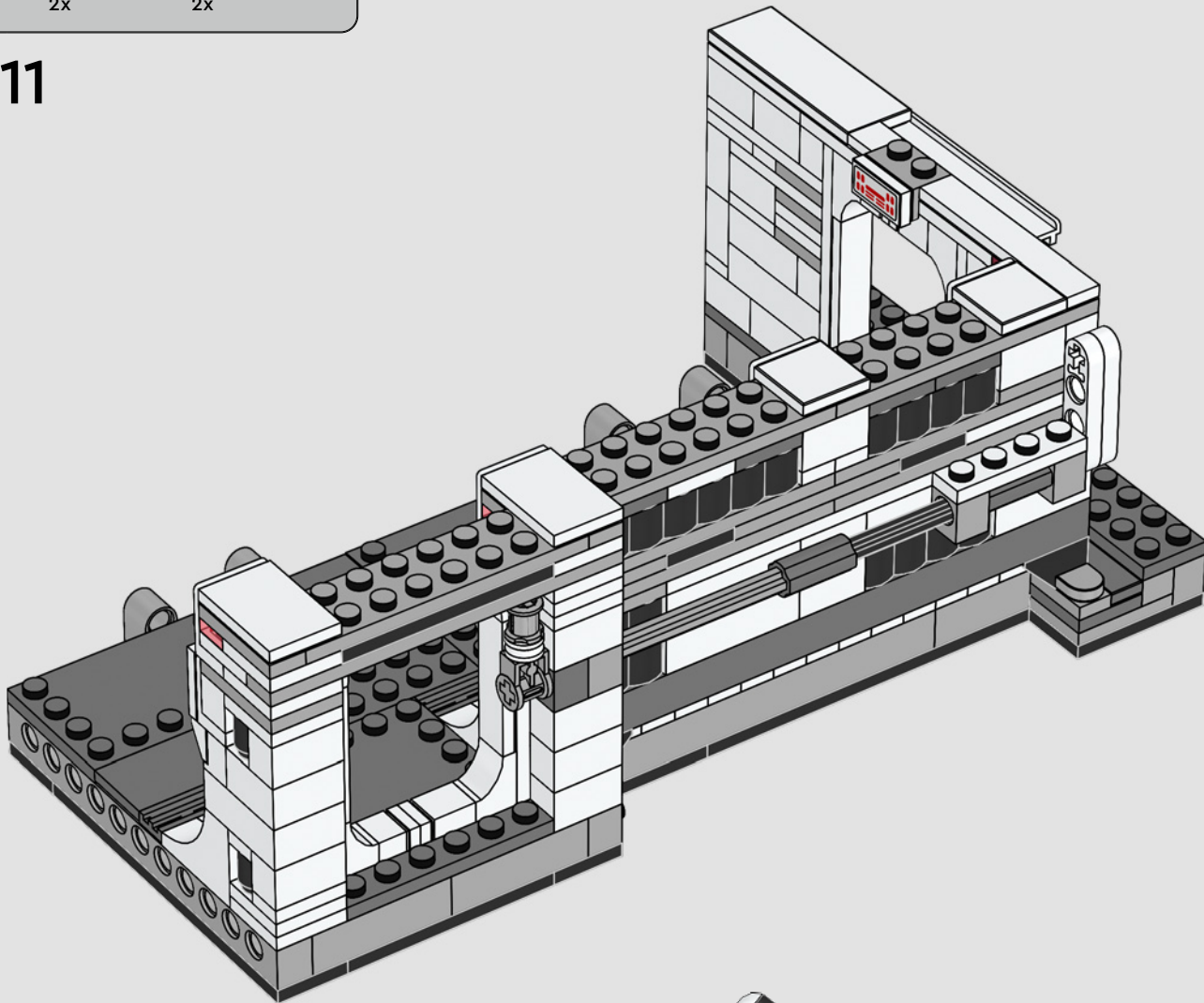

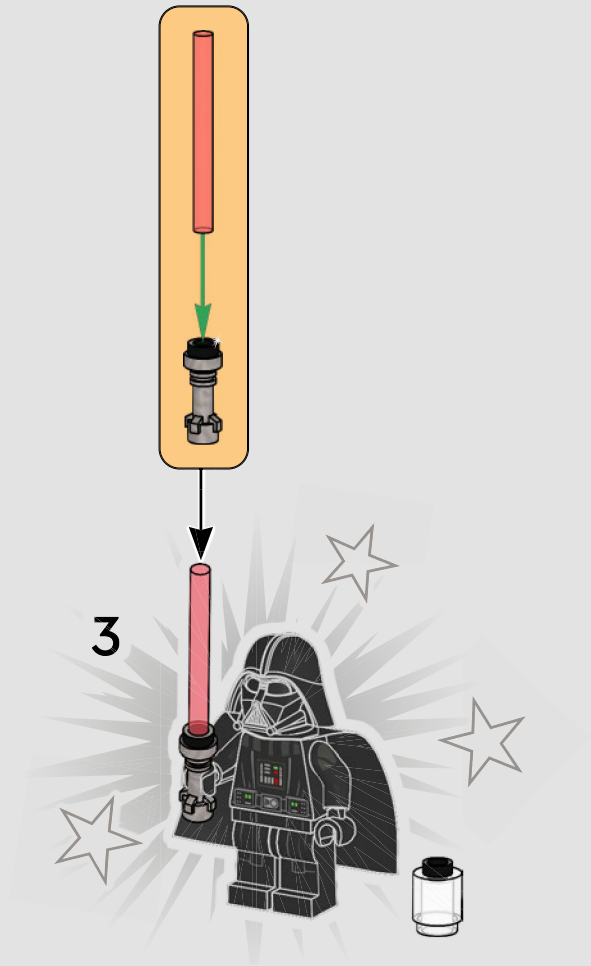
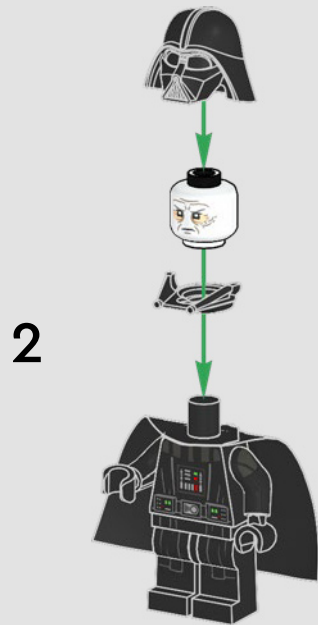
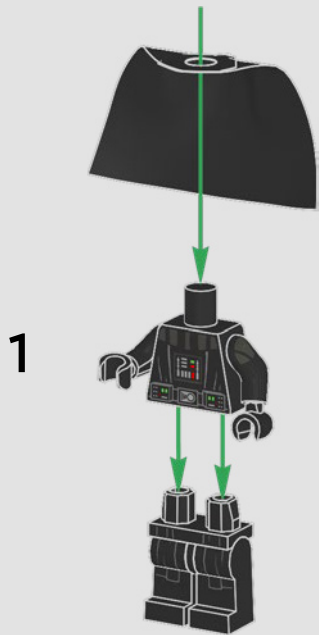

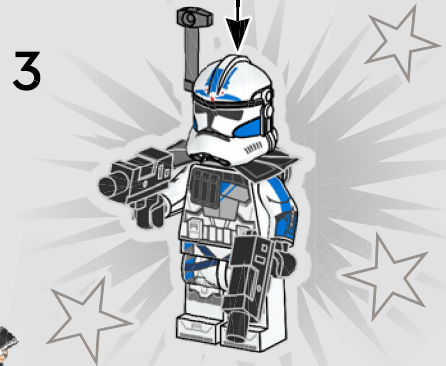
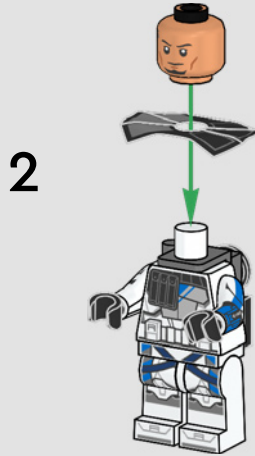
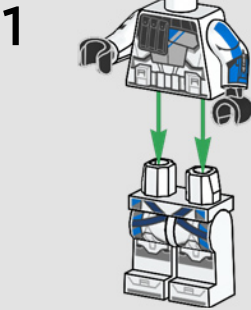
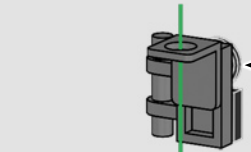
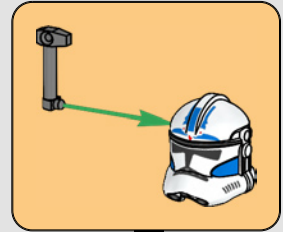
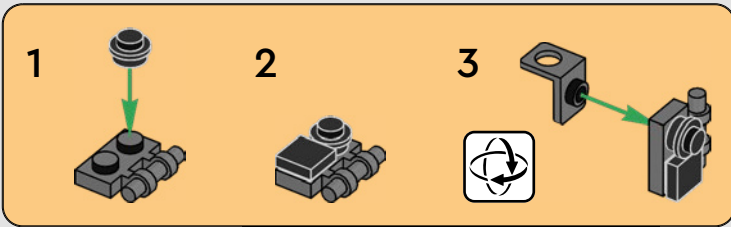
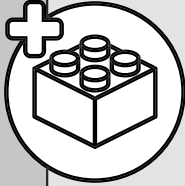
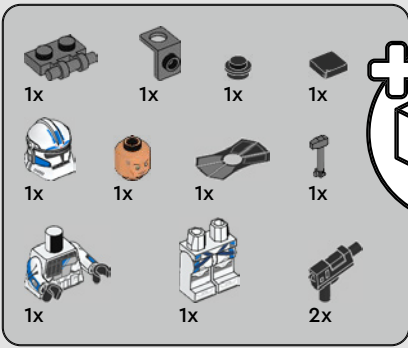

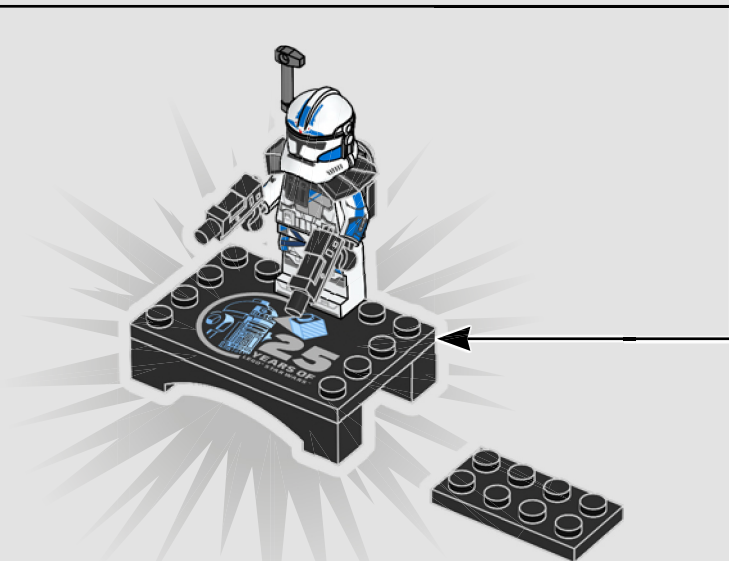
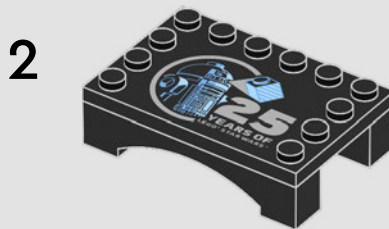
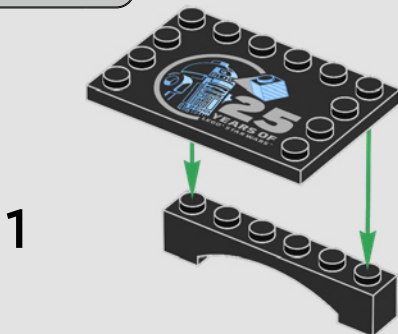
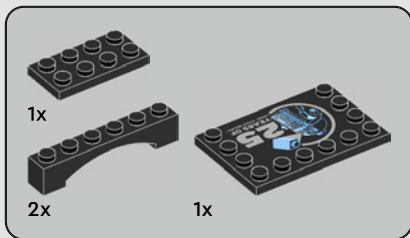

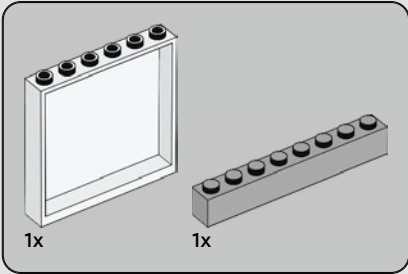
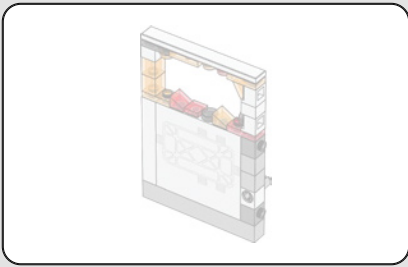

112

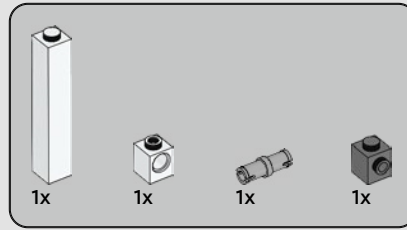
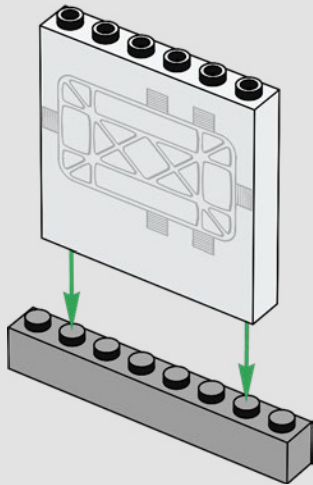

113

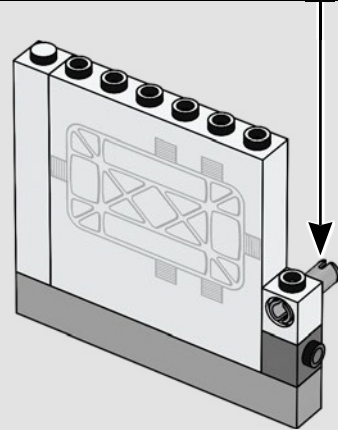
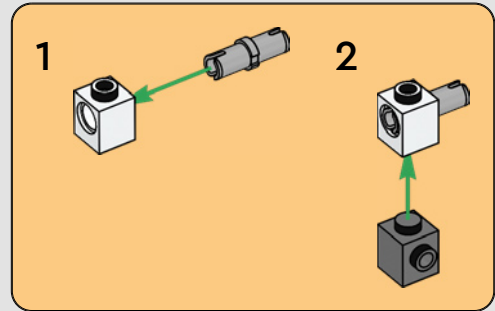

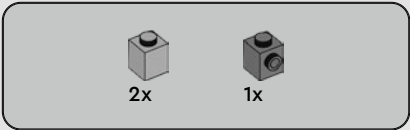

114

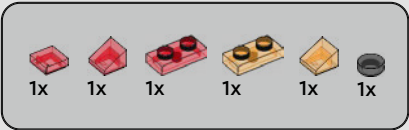
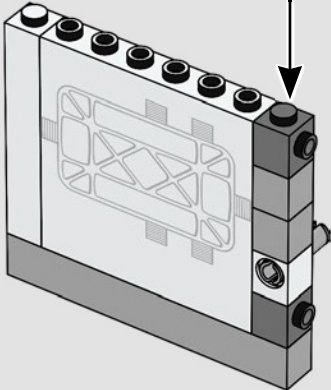
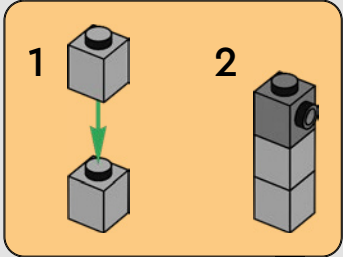

115

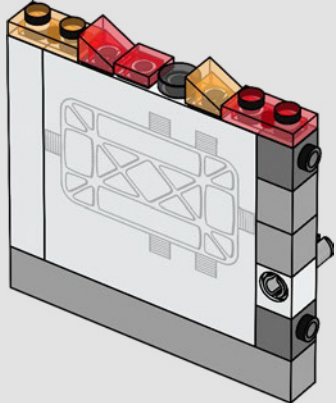



2x



2x

# 116

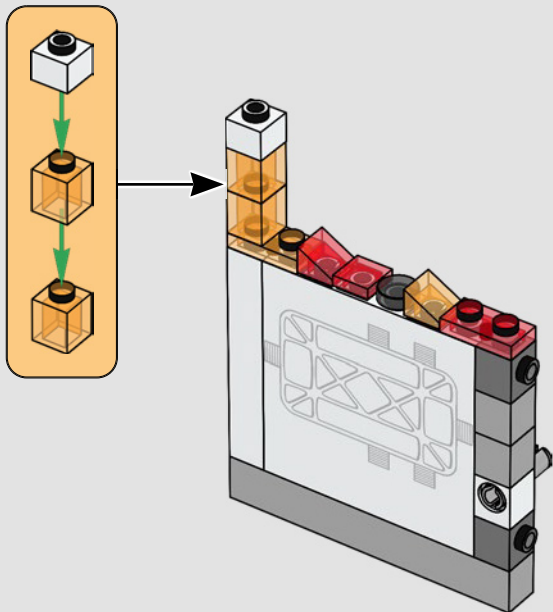

2x



1x



1x



1x

# 117

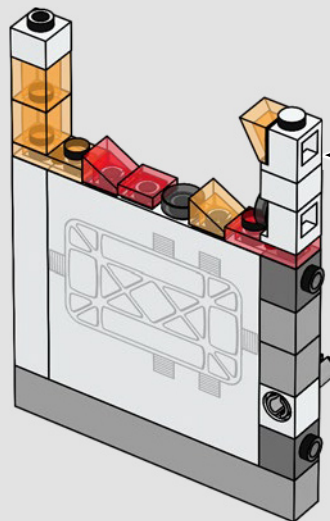
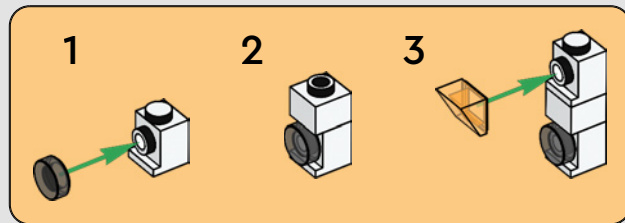

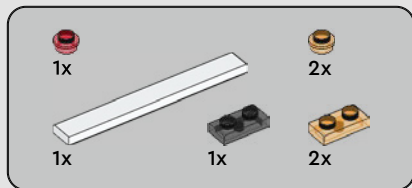

118

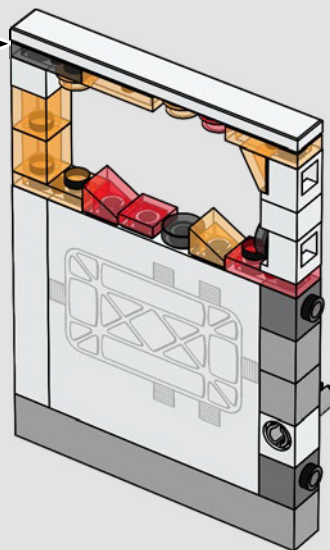
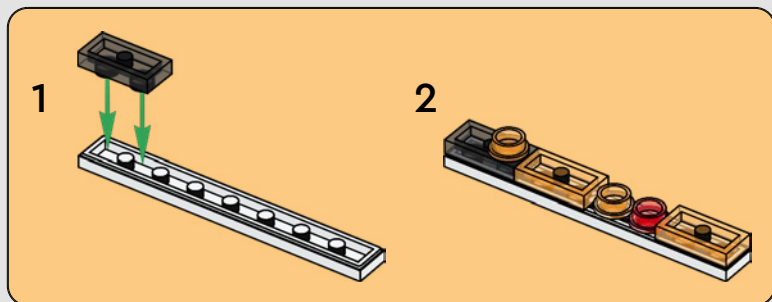



119

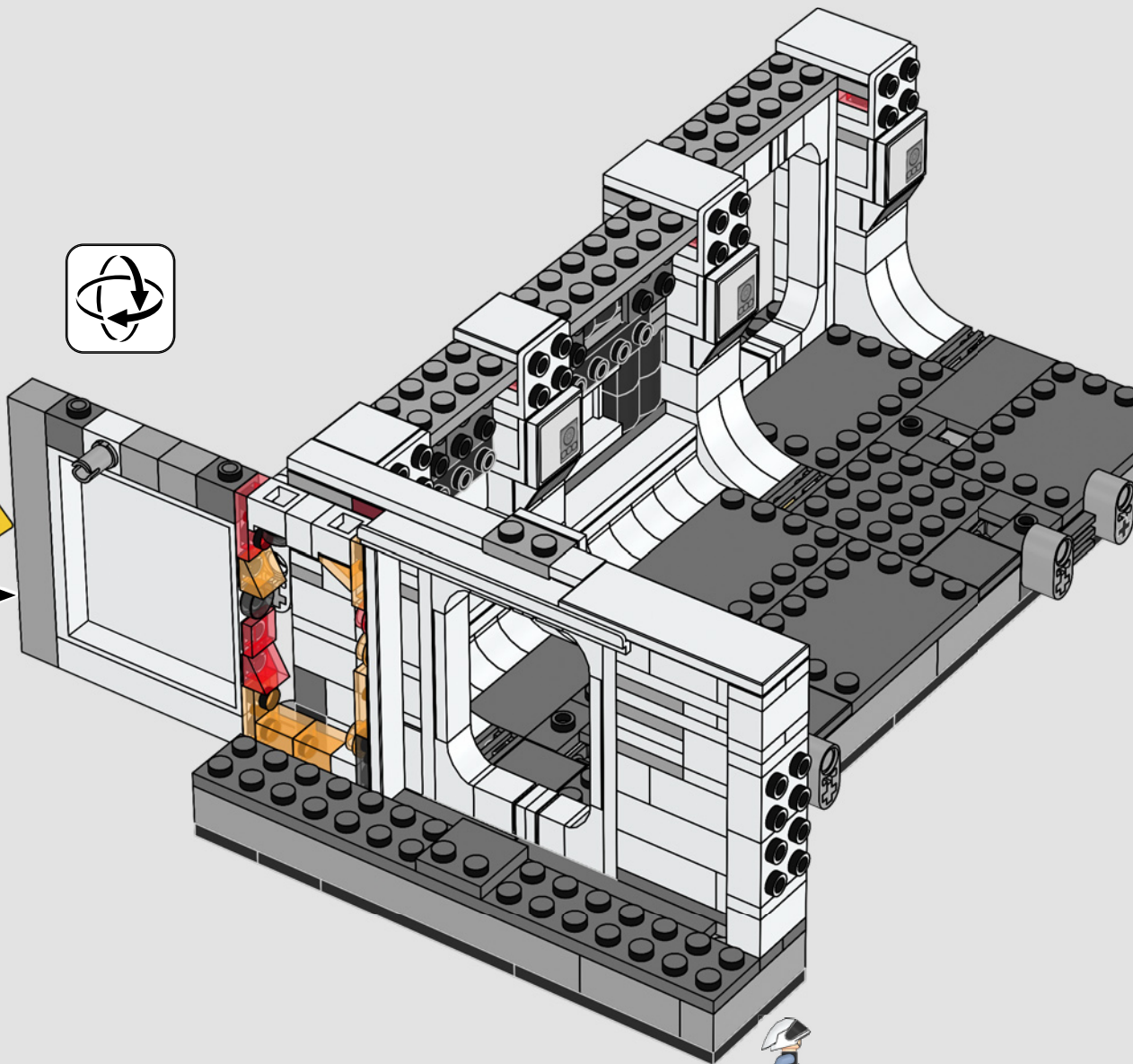

120

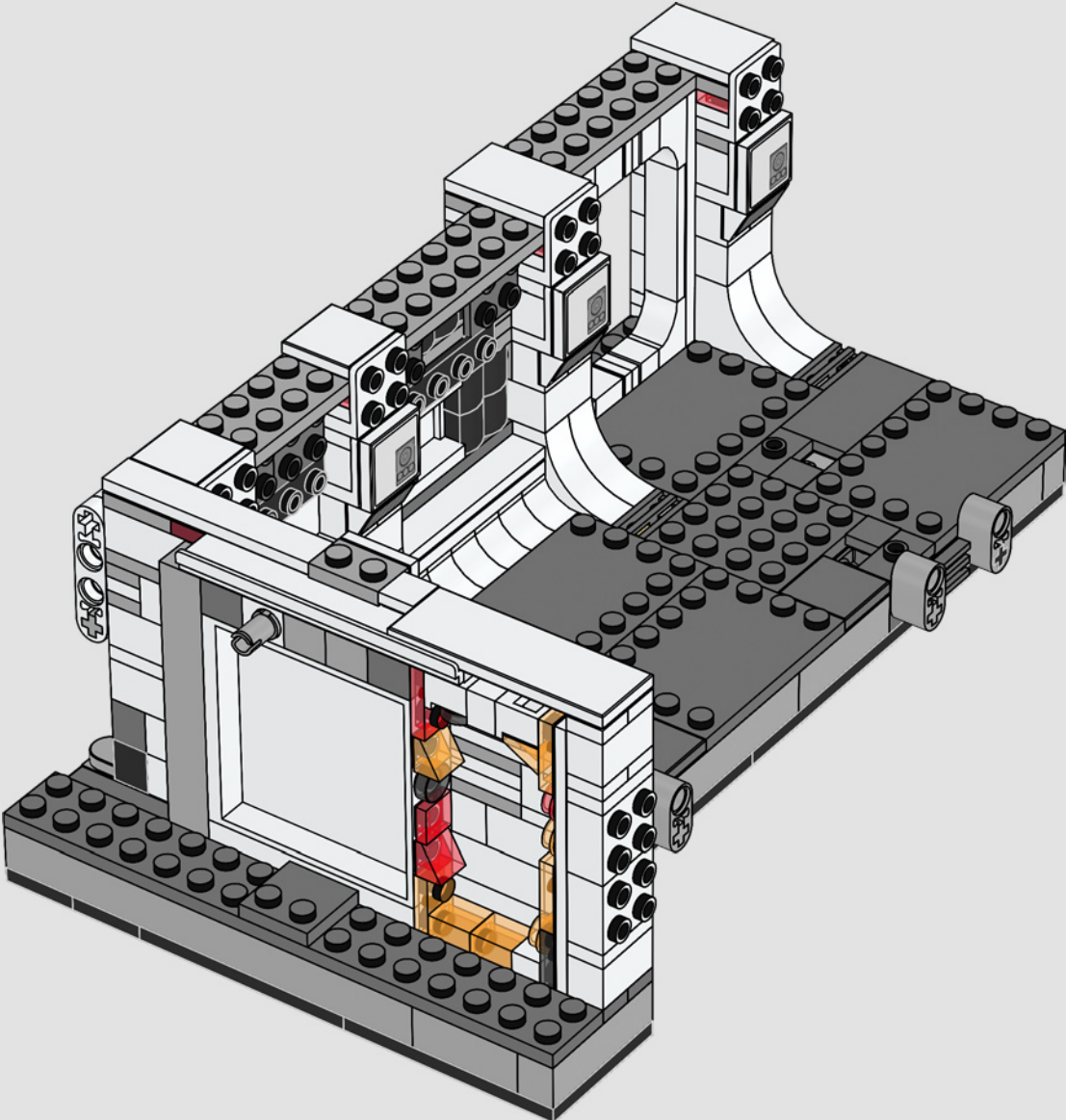

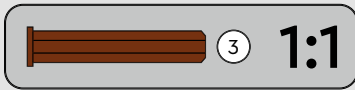
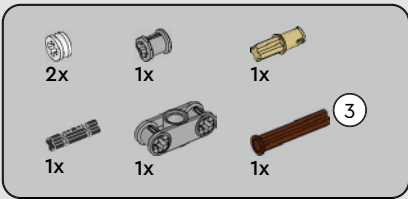

121

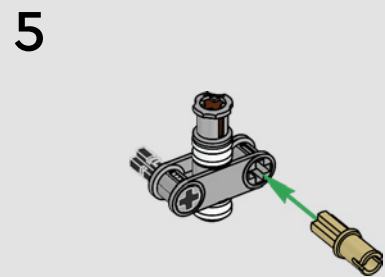
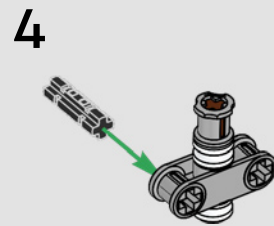
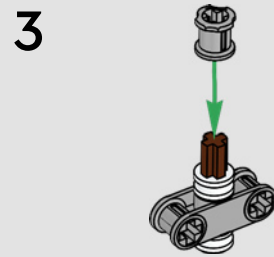
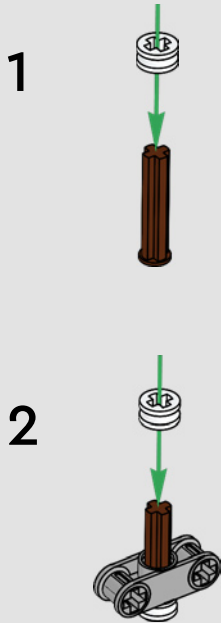

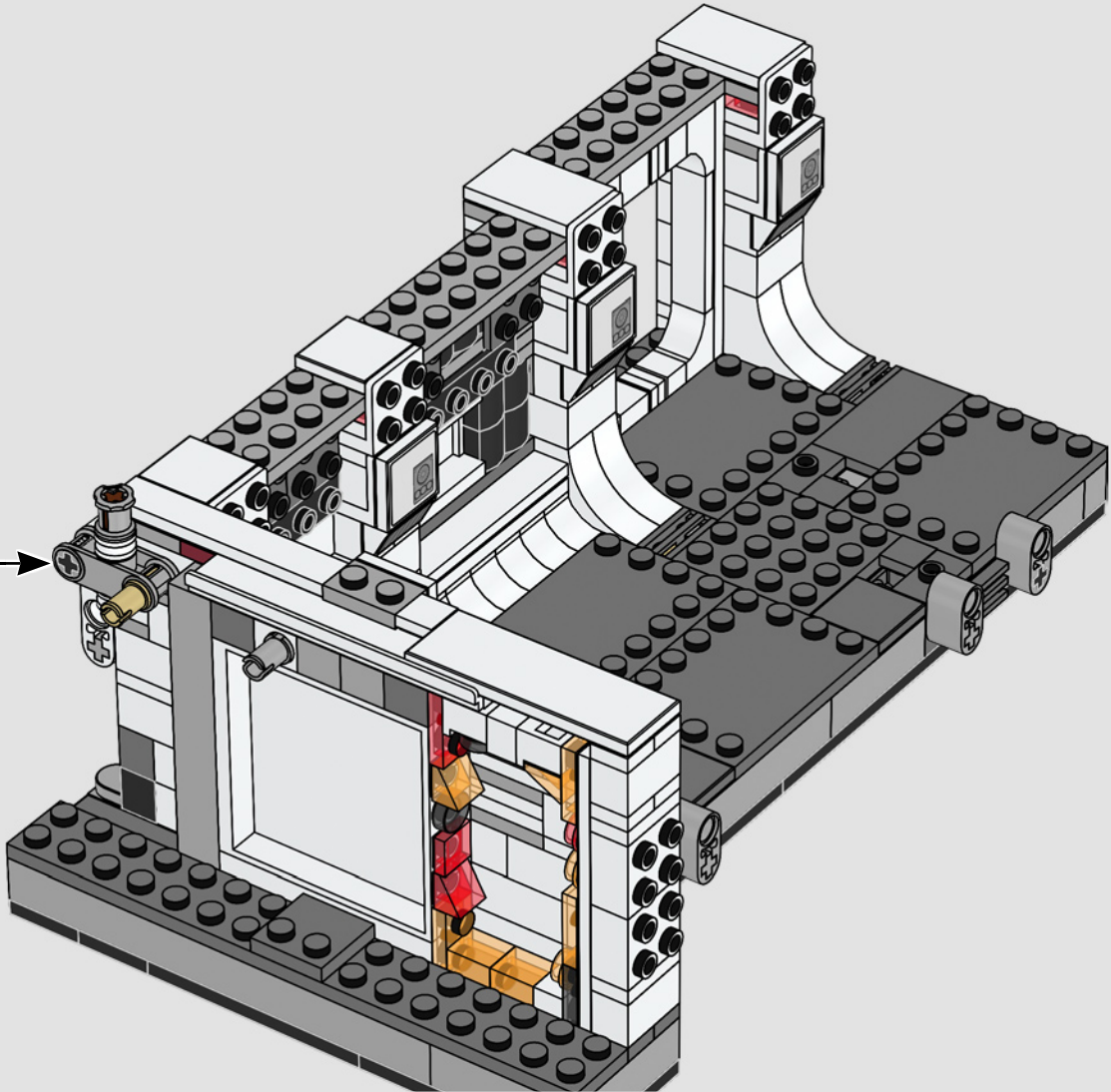

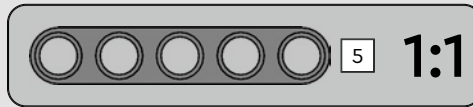
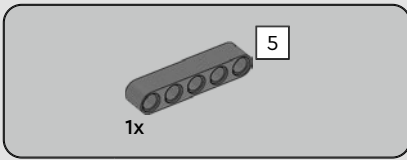

122

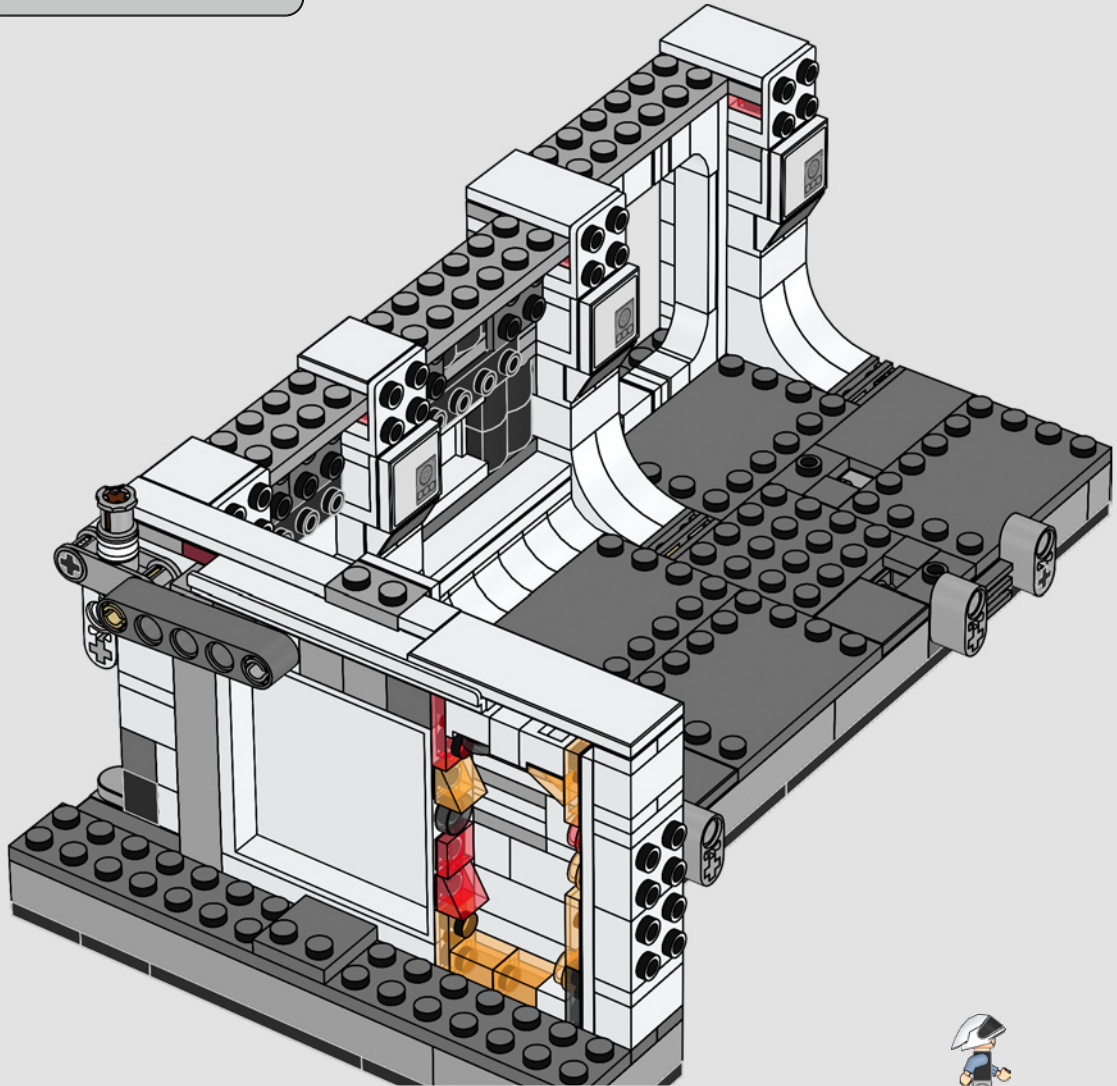

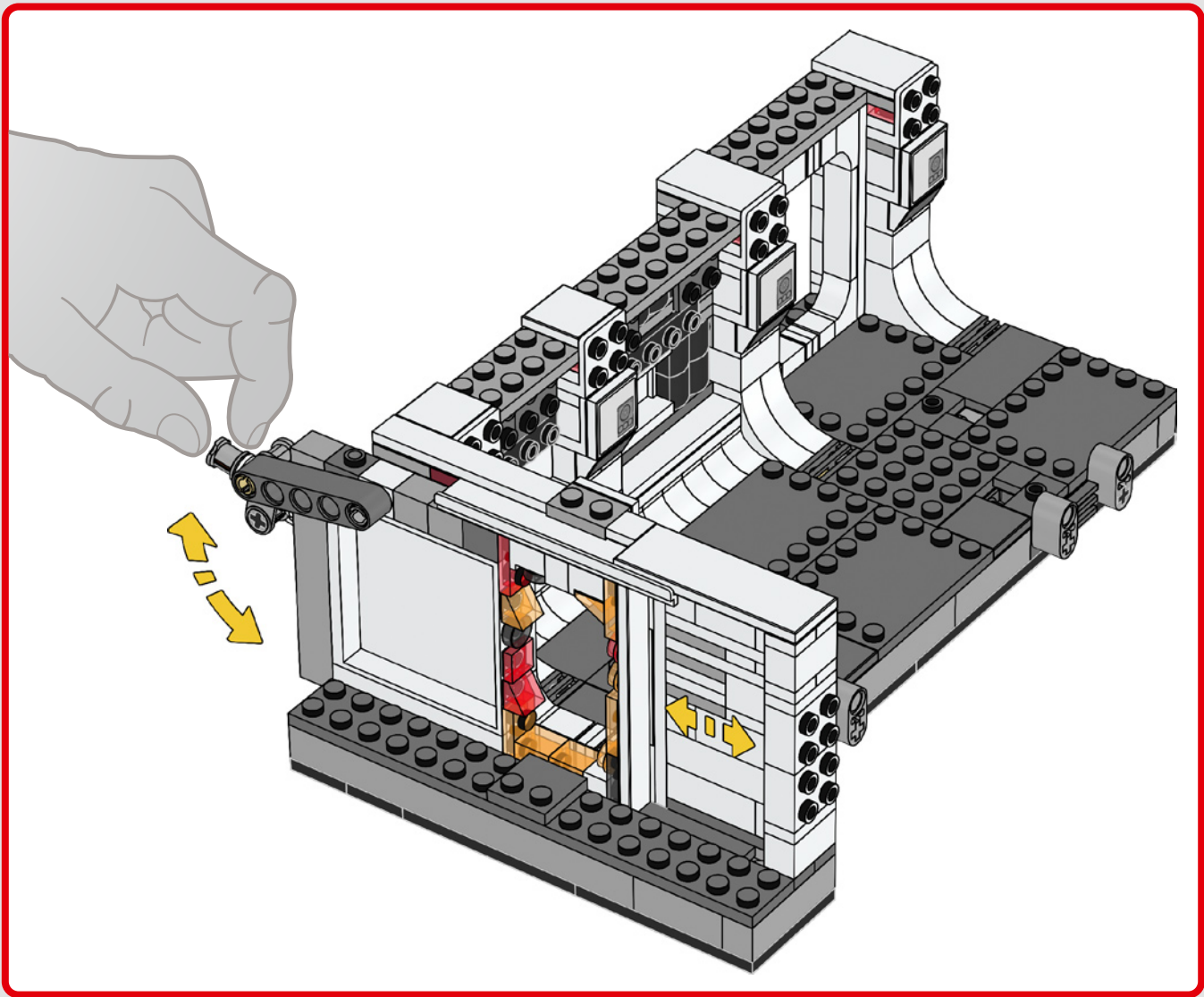

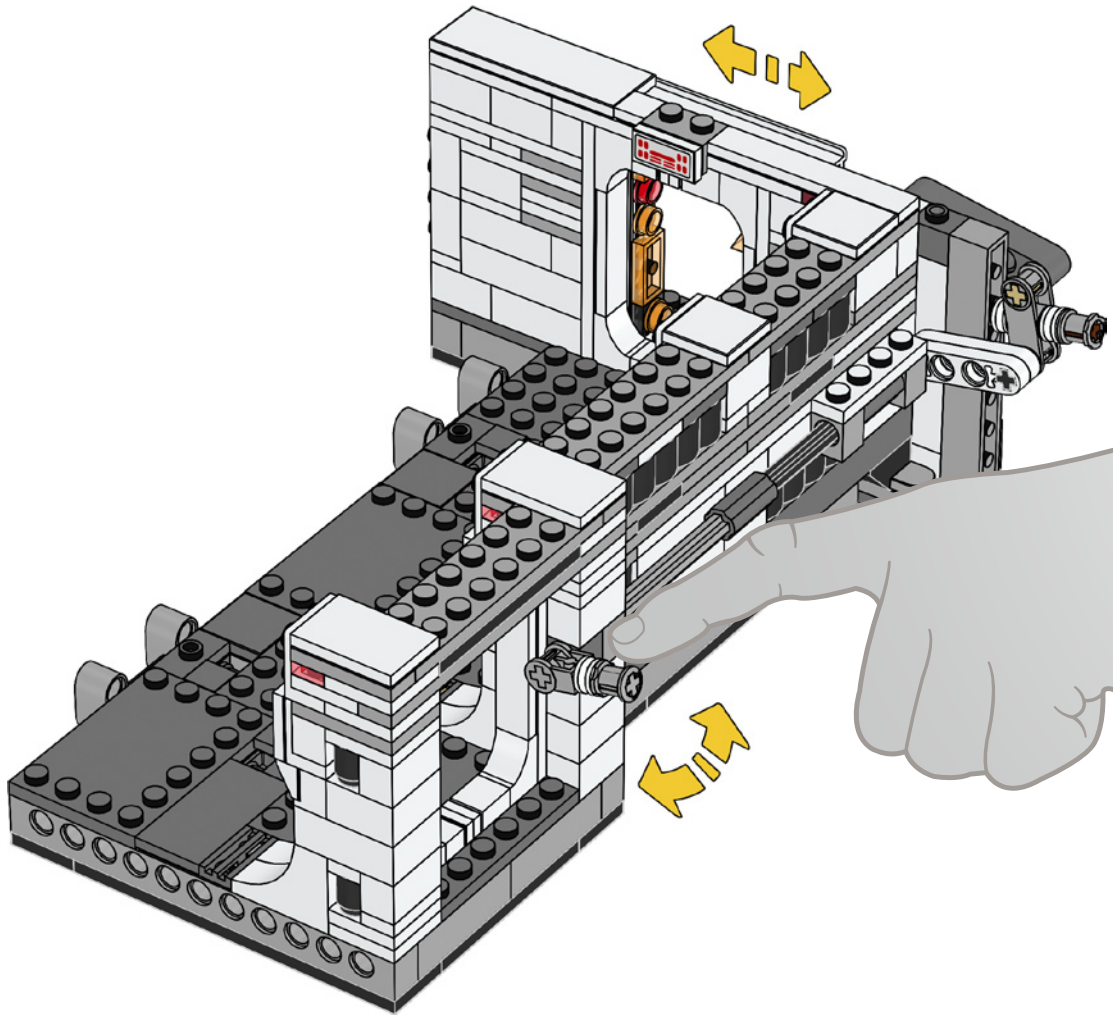

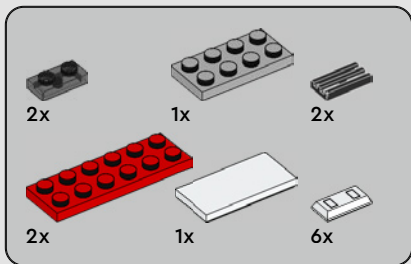

123

1

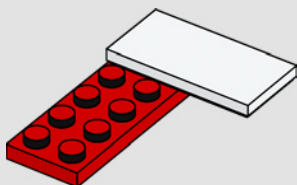

2

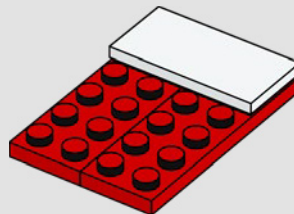

3

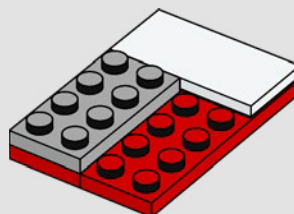



4

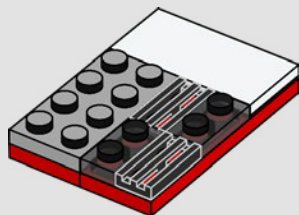

5

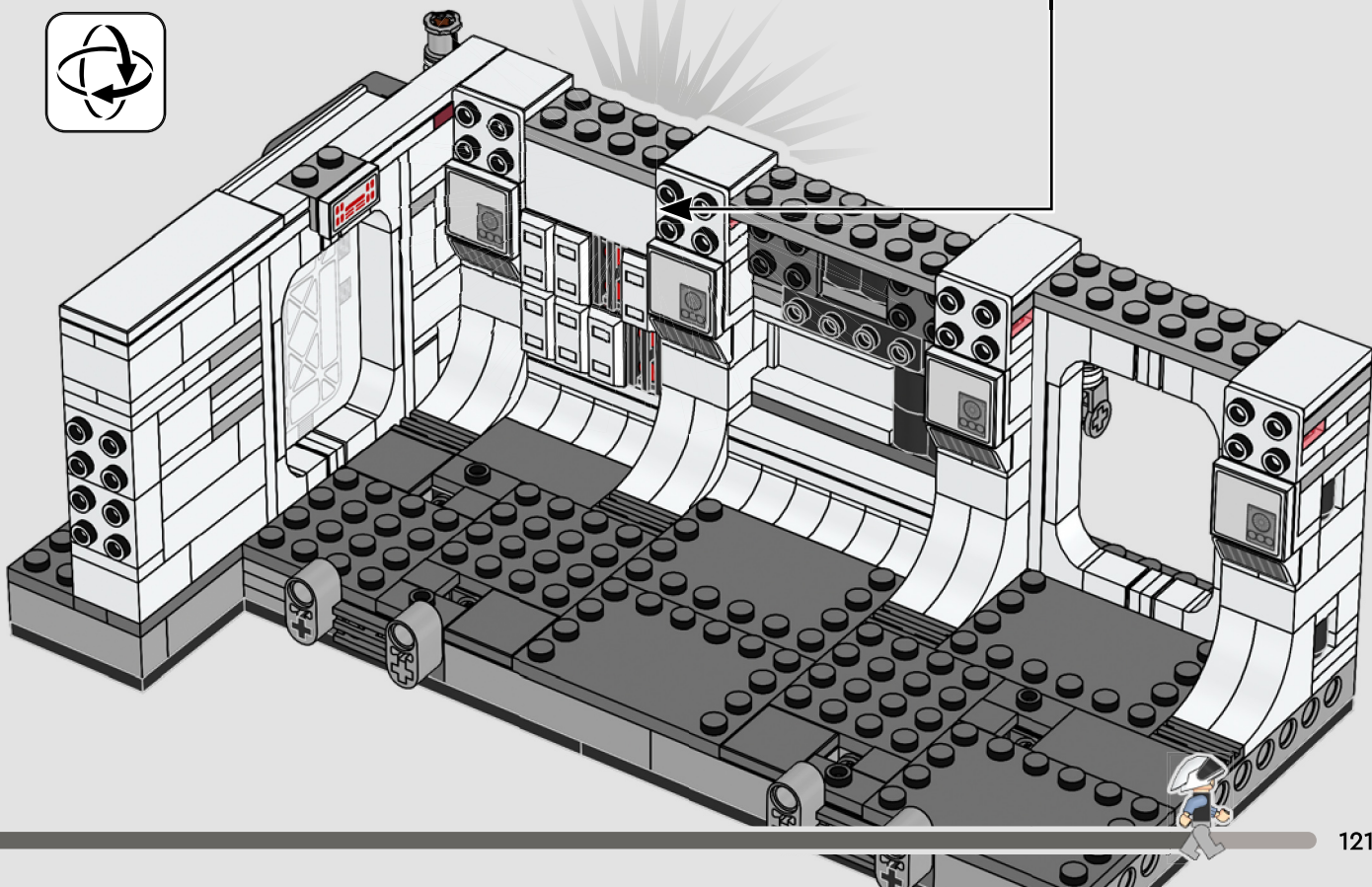
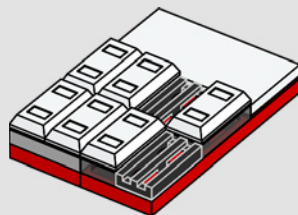

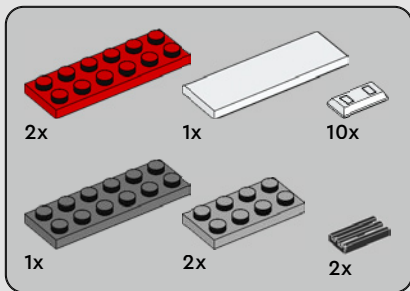

124

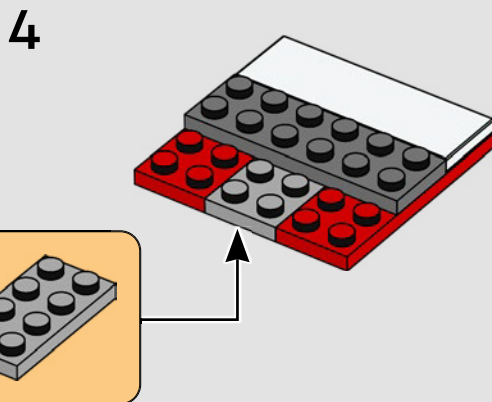
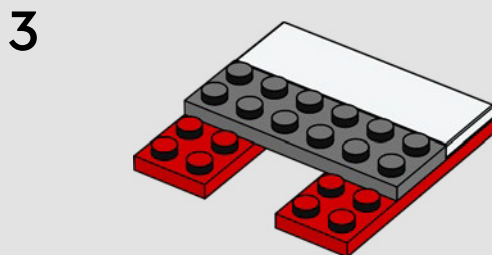
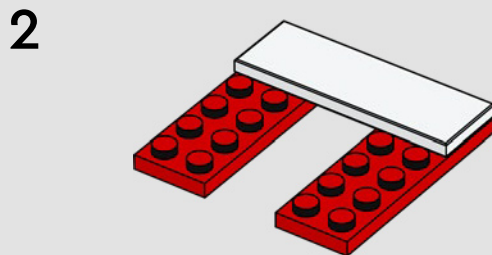
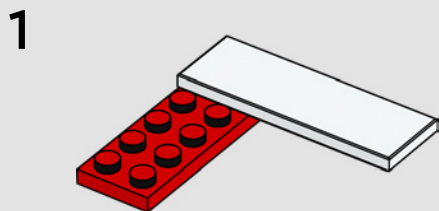

5



6

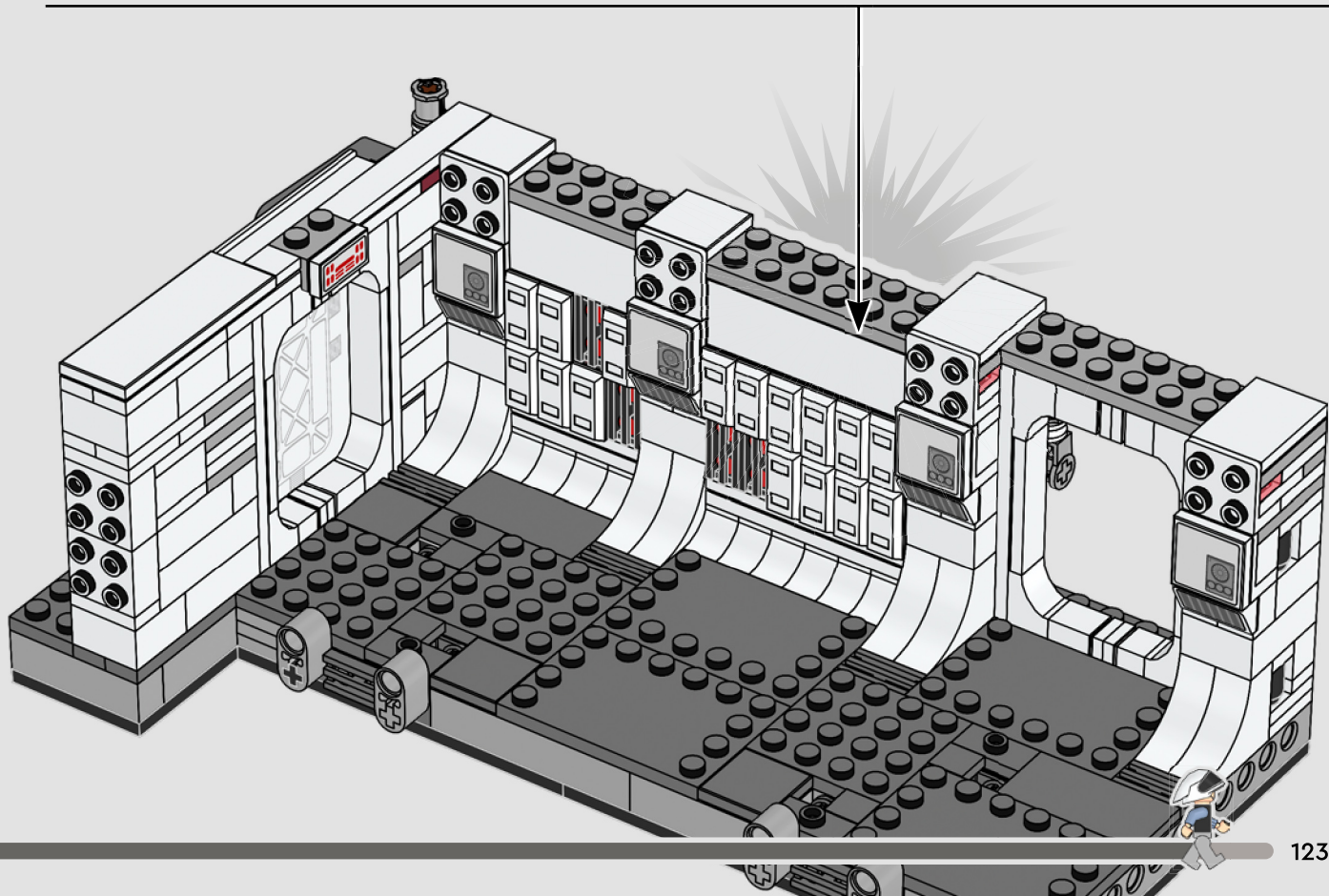
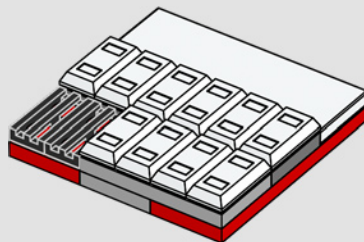

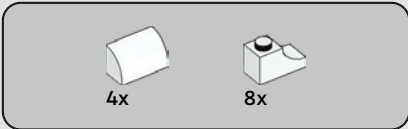

125

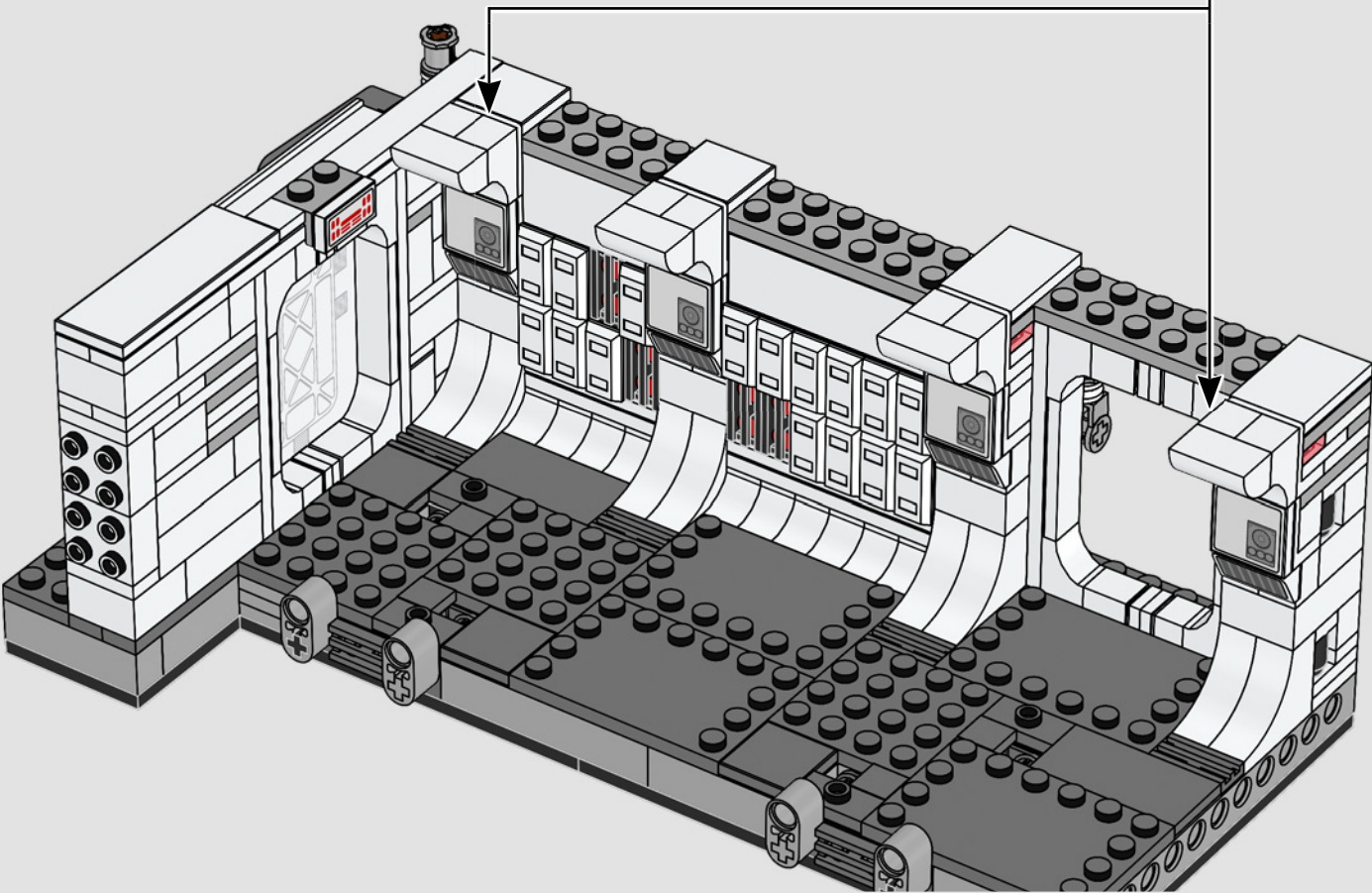
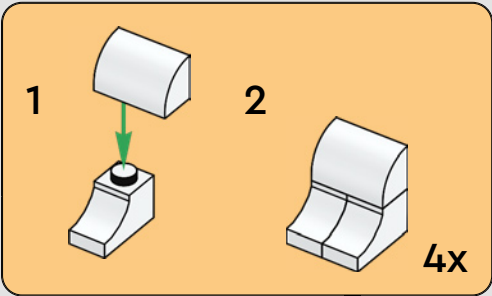



4x

# 126

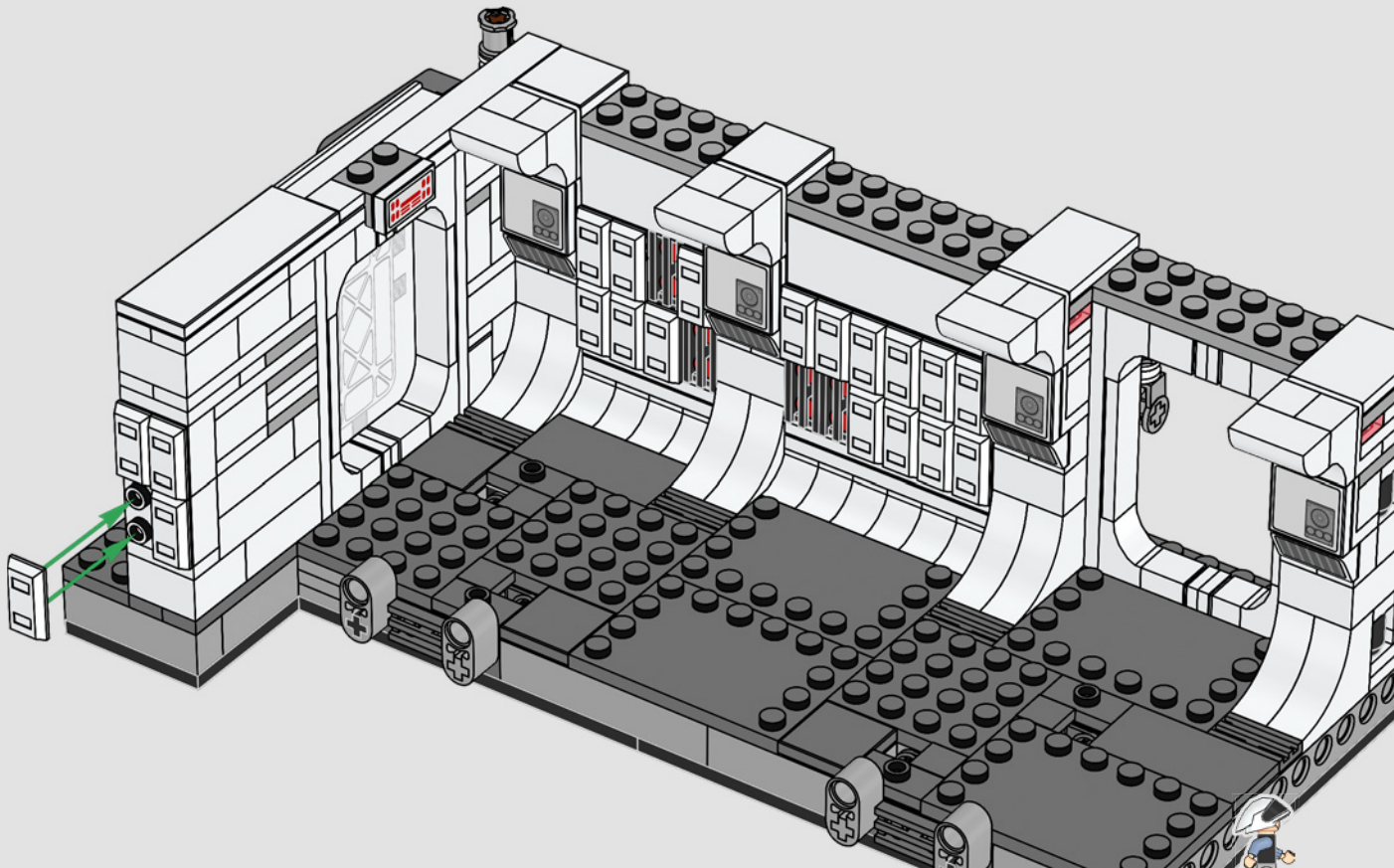

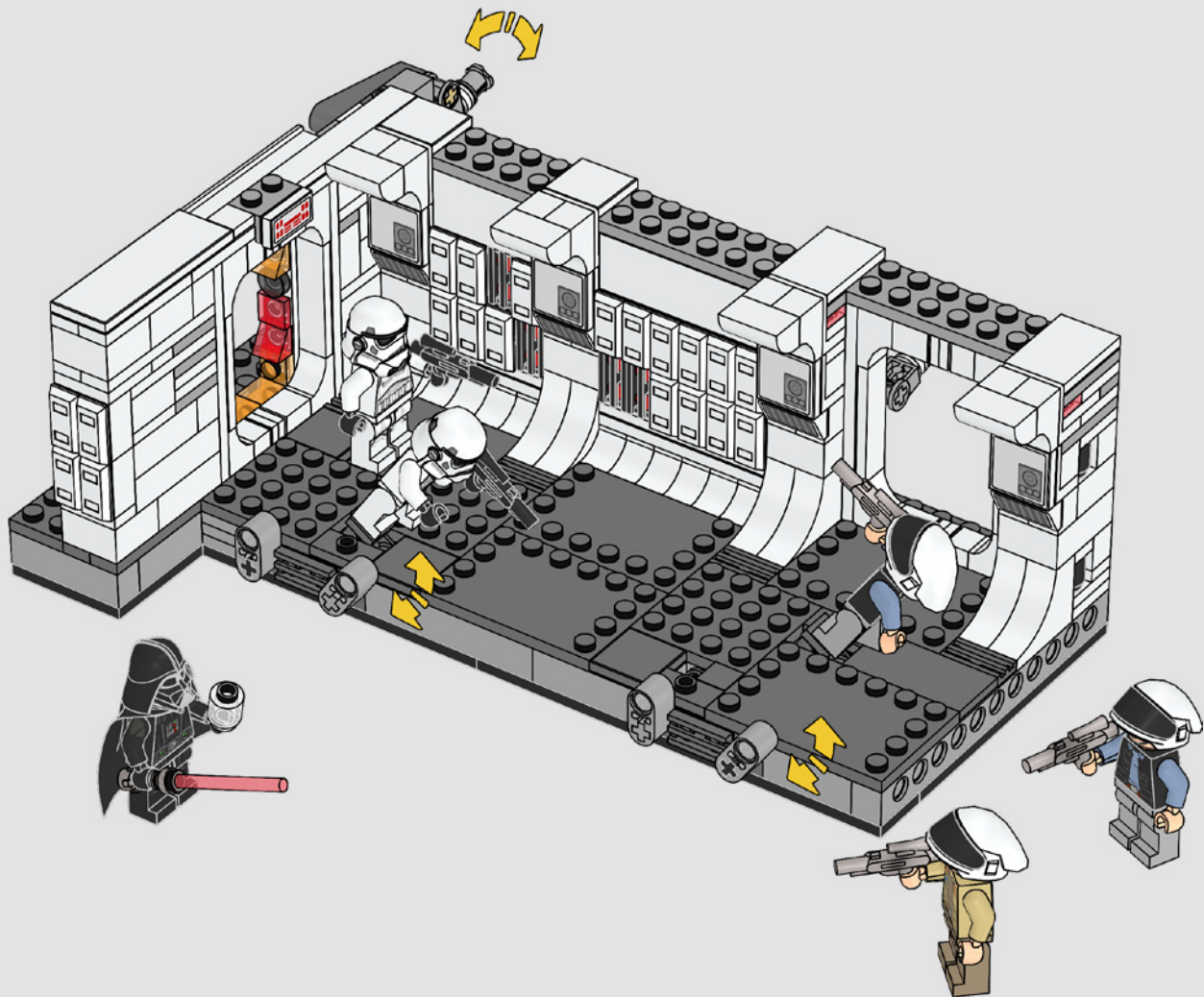

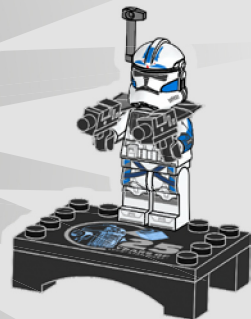
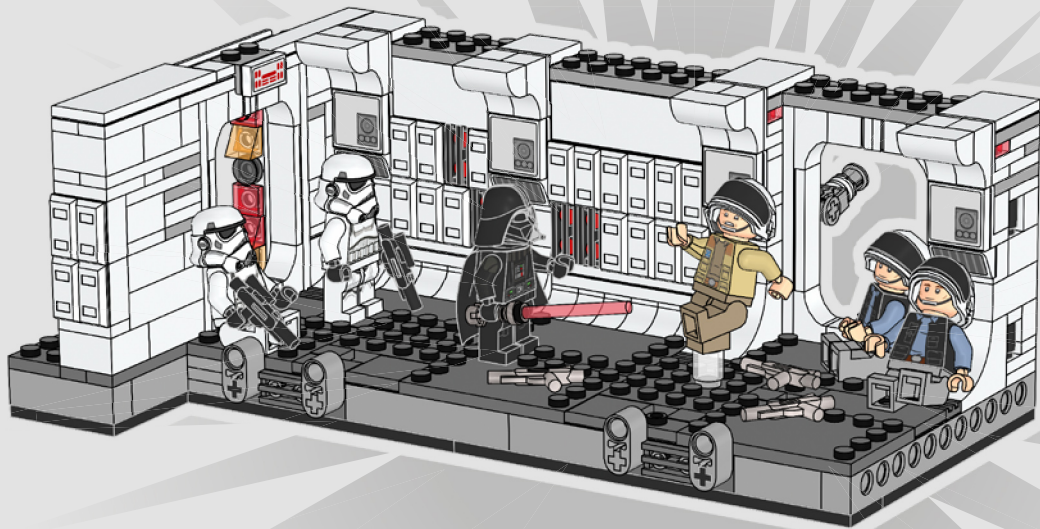



# STAR WARS™

## COMBINE SETS TO EXPAND PLAY!

Kombiniere Sets für noch mehr Spielspaß!

Combinez des sets pour agrandir le jeu !

Combina i set per tanto gioco in più!

¡Combina sets para jugar a lo grande!

Combine sets para expandir os seus momentos de diversão!

组合系列套装, 增强玩乐体验!

Łącz zestawy i baw się jeszcze lepiej!

Kombinujte stavebnice a rozšířte herní možnosti!

Kombinujte stavebnice a rozširujte herné možnosti!

A készletek egyesítésével bővítsd a játékot!

Combină seturi pentru a explora noi posibilități de joacă!

Комбинируйте комплекты за по-интригуваща игра!

Arvieno komplektus, lai paplašinātu rotaļas!

Kombineeri komplekte, et mängu laiendada!

Derinkite rinkinius ir išplėskite žaidimą!

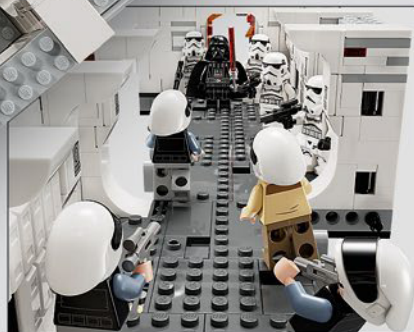

**2 x**  
**75387**





# STAR WARS™

Join the  
25<sup>th</sup> Anniversary at  
[LEGO.com/SW-25](http://LEGO.com/SW-25)



Join the 25<sup>th</sup> Anniversary at  
[LEGO.com/SW-25](http://LEGO.com/SW-25)  
Feiere mit uns das 25-jährige Jubiläum auf  
[LEGO.com/SW-25](http://LEGO.com/SW-25)  
Venez célébrer notre 25<sup>e</sup> anniversaire sur  
[LEGO.com/SW-25](http://LEGO.com/SW-25)  
Festeggia con noi il 25<sup>o</sup> anniversario su  
[LEGO.com/SW-25](http://LEGO.com/SW-25)  
Participa en el 25 aniversario en  
[LEGO.com/SW-25](http://LEGO.com/SW-25)  
Junte-se ao 25.º Aniversário em  
[LEGO.com/SW-25](http://LEGO.com/SW-25)  
访问 [LEGO.com/SW-25](http://LEGO.com/SW-25),  
参加 25 周年庆典  
Świętuj z nami 25. rocznicę na stronie  
[LEGO.com/SW-25](http://LEGO.com/SW-25)  
Oslavte s námi 25. výročí na  
[LEGO.com/SW-25](http://LEGO.com/SW-25)  
Oslávte s nami 25. výročie na  
[LEGO.com/SW-25](http://LEGO.com/SW-25)  
Csatlakozz a 25. évfordulóhoz a  
[LEGO.com/SW-25](http://LEGO.com/SW-25) oldalon!  
Alătură-te celei de-a 25-a aniversării pe  
[LEGO.com/SW-25](http://LEGO.com/SW-25)  
Присъединете се към 25тата годишнина на  
[LEGO.com/SW-25](http://LEGO.com/SW-25)  
Pievienojies 25. jubilejai vietnē  
[LEGO.com/SW-25](http://LEGO.com/SW-25)  
Liitu 25.th aastapäevaga aadressil  
[LEGO.com/SW-25](http://LEGO.com/SW-25)  
Švęskime 25-ąją sukaktį drauge svetainėje  
[LEGO.com/SW-25](http://LEGO.com/SW-25)

25 years of LEGO® Star Wars™  
25 Jahre LEGO® Star Wars™  
25 ans de LEGO® Star Wars™  
25 anni di LEGO® Star Wars™  
25 años de LEGO® Star Wars™  
25 anos de LEGO® Star Wars™  
乐高®星球大战™ 25 周年  
25 lat LEGO® Star Wars™

25 let LEGO® Star Wars™  
25 rokov LEGO® Star Wars™  
25 évnýi LEGO® Star Wars™  
25 de ani de LEGO® Star Wars™  
25 години LEGO® Star Wars™  
LEGO® Star Wars™ 25 gadi  
25 aastat LEGO® Star Wars™  
25 metal LEGO® Star Wars™



- 3x 6360263
- 1x 6405191
- 10x 307001
- 6x 6383985
- 2x 4558952
- 10x 407001
- 4x 6218841
- 5x 300501
- 5x 302401
- 1x 654101
- 1x 245301
- 1x 6472489
- 4x 4547489
- 2x 6252379
- 2x 6400106
- 1x 6482402
- 26x 6346616
- 20x 6210076
- 13x 302301
- 20x 300401
- 2x 6218823
- 1x 306901
- 4x 6248827
- 3x 6454140
- 8x 6097637
- 9x 302201
- 6x 306801
- 1x 242001
- 2x 235701
- 2x 300301
- 2x 362201
- 8x 6110019
- 1x 6482673
- 2x 6400101
- 2x 6360072
- 2x 6156667
- 3x 300201
- 1x 302101
- 2x 301001
- 5x 371001
- 5x 243101
- 1x 6079140
- 1x 4560178
- 1x 302001
- 1x 6350399
- 3x 663601
- 1x 366601
- 1x 6472488
- 2x 6332042
- 5x 346001
- 2x 300801
- 1x 416201
- 1x 4500878
- 1x 4666579
- 8x 4218749
- 1x 6482522
- 1x 6472490
- 2x 300523
- 4x 6378120
- 4x 379521
- 2x 6467485
- 5x 370626
- 2x 663626
- 2x 366626
- 2x 4620763
- 1x 6345789
- 2x 4181144
- 1x 6482401
- 1x 303226
- 1x 395826
- 3x 383226
- 2x 6001494
- 1x 6360031
- 3x 6252803
- 2x 6103643
- 2x 6279875
- 3x 4109810
- 1x 6308178
- 1x 6112160
- 4x 241226
- 2x 366526
- 2x 4498713
- 1x 6478189
- 3x 4539114
- 10x 4644456
- 1x 302226
- 1x 6310813
- 2x 6168620
- 2x 370526
- 2x 6457081
- 3x 302026
- 2x 306226
- 1x 614126
- 1x 307026
- 1x 6135494
- 1x 6102999
- 1x 4524098

7x  
4210639

4x  
4210848

1x  
4210719

2x  
4558955

1x  
6170811

4x  
6261374

2x  
4516546

4x  
6092572

6x  
4210631

4x  
6117972

1x  
4210660

1x  
6309059

3x  
4211055

2x  
4560184

1x  
4210686

5

1x  
6413109

1x  
4210651

1x  
4211056

3x  
4243831

2x  
4211002

1x  
4211008

4x  
6199511

1x  
6461466

1x  
4211067

1x  
4211067

1x  
4210783

1x  
4210796

3x  
4211395

3x  
6372029

1x  
4211393

4x  
4211425

1x  
4211392

3x  
4211406

2x  
6037399

1x  
4535768

1x  
4251149

2x  
4211522

1x  
4211860

9

6x  
4211398

3x  
6015344

3x  
4211541

1x  
4654582

3x  
6435857

2x  
4211349

3x  
4211815

1x  
4211536

1x  
6276969

4x  
4211429

4x  
4211428

3x  
4211396

6x  
4211394

1x  
6250597

2x  
6275844

2x  
4558953

5x  
4211399

3x  
6401023

2x  
4211389

1x  
4211807

4x  
6265089

2x  
4227657

2x  
4512360

2x  
6240227

2x  
6245265

2x  
6240550

3x  
6240217

1x  
6208450

1x  
6245252

1x  
6254248

5x  
6240212

1x  
6167284

1x  
6223655

2x  
6446337

3x  
6471727

2x  
6447199

1x  
6118815

1x  
6472486

1x  
6405179

3x  
6122722

1x  
6051389



 [LEGO.com/service](https://www.LEGO.com/service)

YOU COULD **WIN**

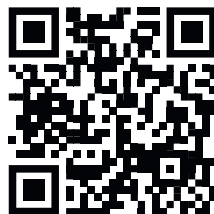

Scan this QR code or go to **LEGO.COM/PRODUCTFEEDBACK** and give us your short feedback about this LEGO® set for a chance to win a cool LEGO prize.

Terms and Conditions apply\*



**EN: YOU COULD WIN.** Terms and Conditions apply\* **DE: Du könntest GEWINNEN.** Es gelten die Teilnahmebedingungen\* **FR: Tu pourrais GAGNER.** Des conditions s'appliquent\* **IT: Potresti VINCERE tu.** Termini e condizioni sono applicabili\* **ES: Puedes GANAR.** Aplican términos y condiciones\* **PT: Poderá GANHAR.** Aplicam-se termos e condições\* **ZH: 轻松获奖. 条款和条件适用\*** **PL: Szansa na WYGRANĄ.** Obowiązują warunki korzystania\* **CS: Máte šanci VYHRÁT.** Platí všeobecné smluvní podmínky\* **SK: Máte šancu VYHRAŤ.** Platia všeobecné zmluvné podmienky\* **HU: TE IS NYERHETSZ.** Felhasználási feltételek érvényesek\* **RO: Ai putea CÂȘTIGA.** Se aplică termeni și condiții\* **BG: Можете да СПЕЧЕЛИТЕ.** Има определени правила и условия\* **LV: Tu vari LAIMĒT.** Ir spēkā noteikumi un nosacījumi.\* **ET: Sul on võimalus VÕITA.** Kehtivad tingimused\* **LT: Jūs galite LAIMĖTI.** Taikomos sąlygos\*

\*[LEGO.com/productfeedback-terms](https://www.lego.com/productfeedback-terms)

LEGO and the LEGO logo are trademarks of the LEGO Group. ©2024 The LEGO Group.

© & ™ Lucasfilm Ltd.

6516542