

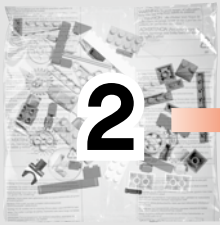

# SPEED CHAMPIONS

75882





2

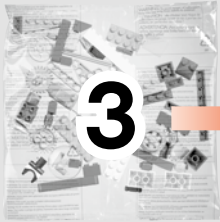
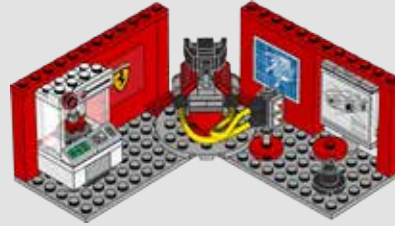

3

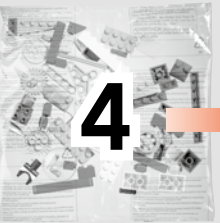
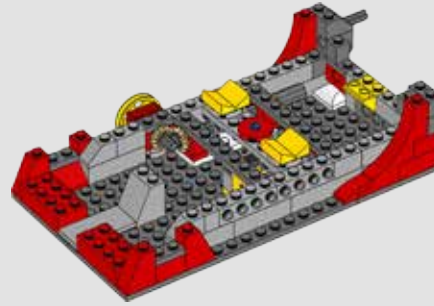

4

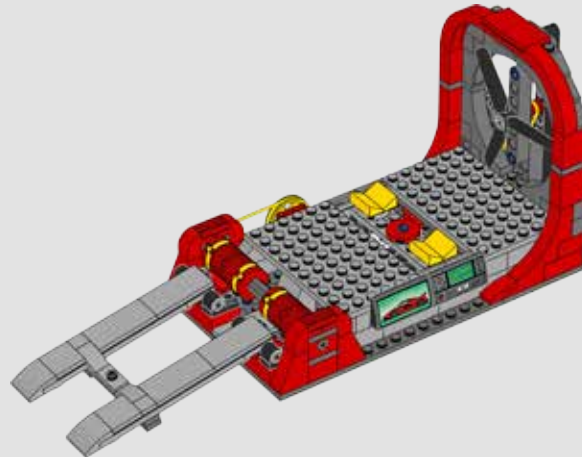

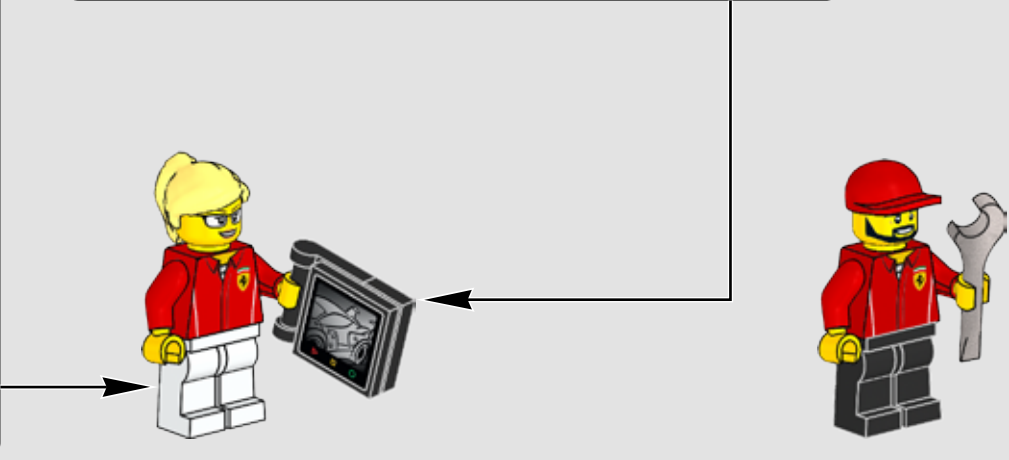
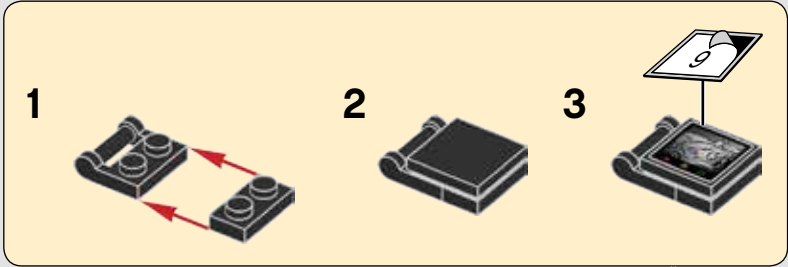
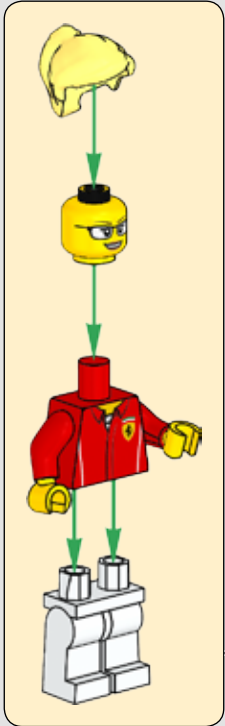
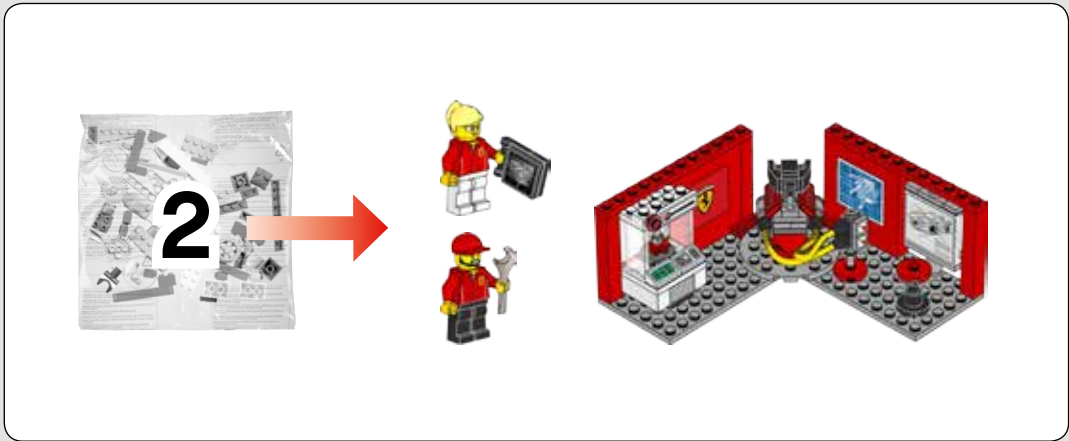

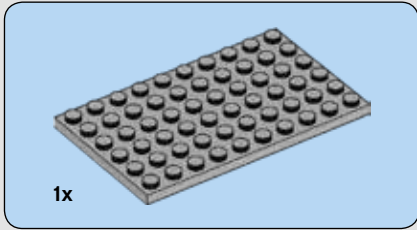
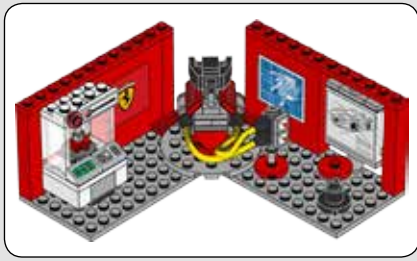

1x

1

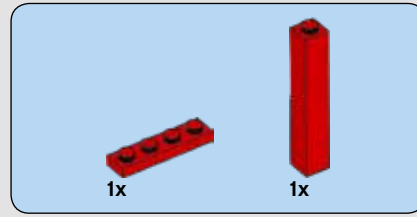
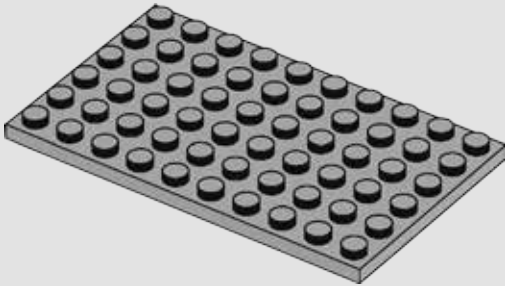

1x

1x

2

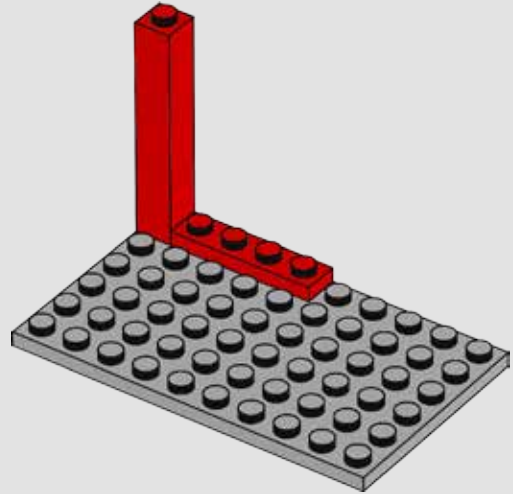

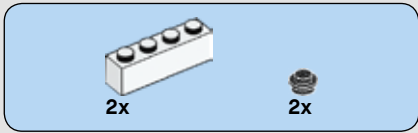

3

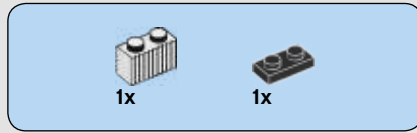
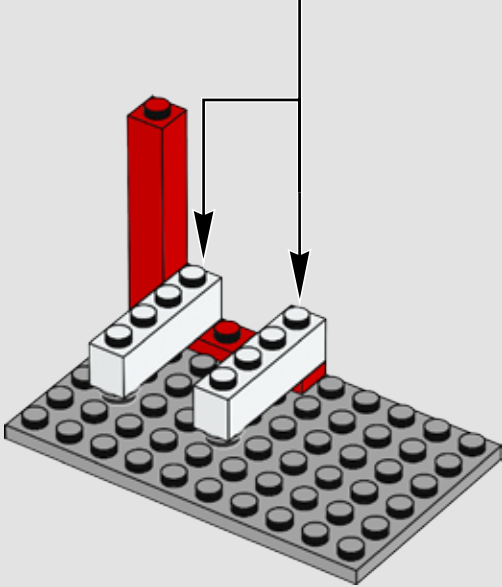
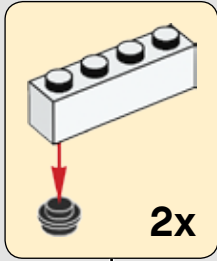

4

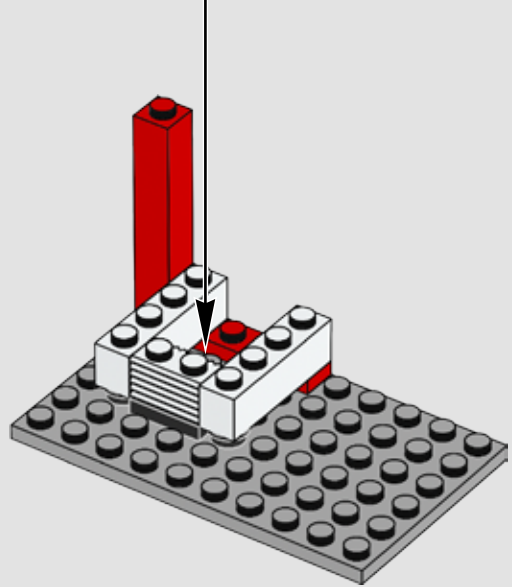
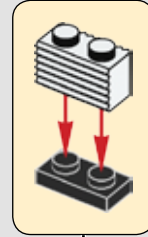

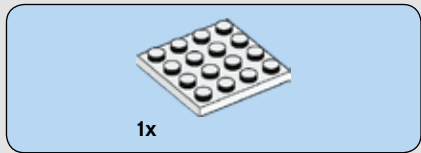

5

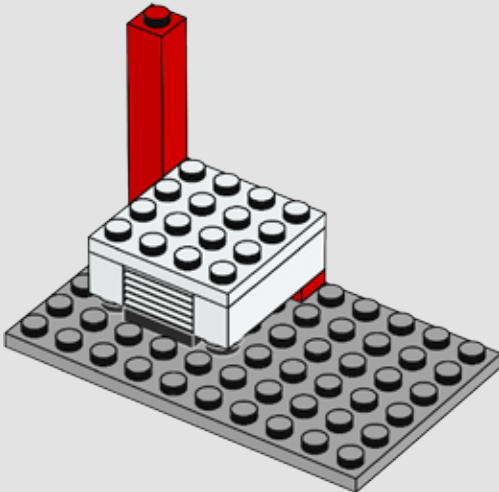

6

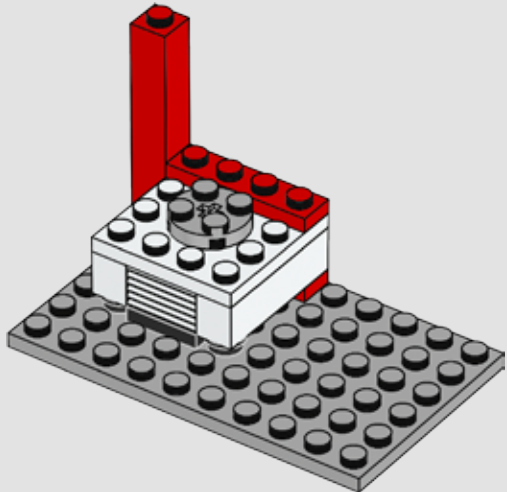

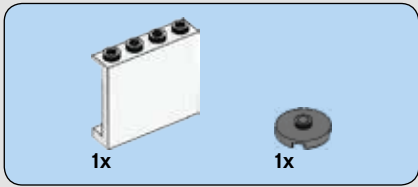

7

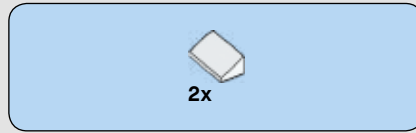
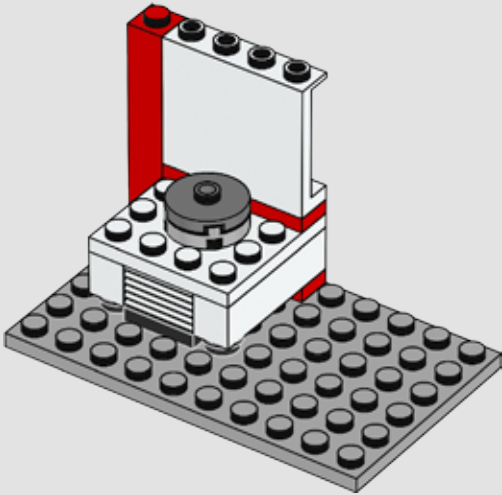

8

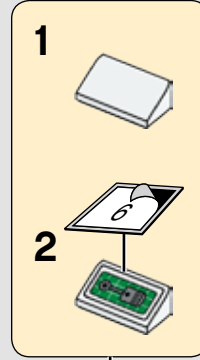

2

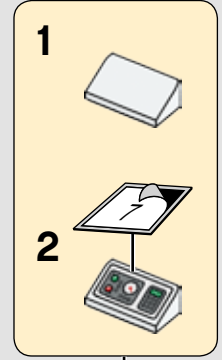
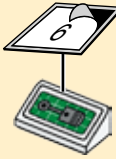

2

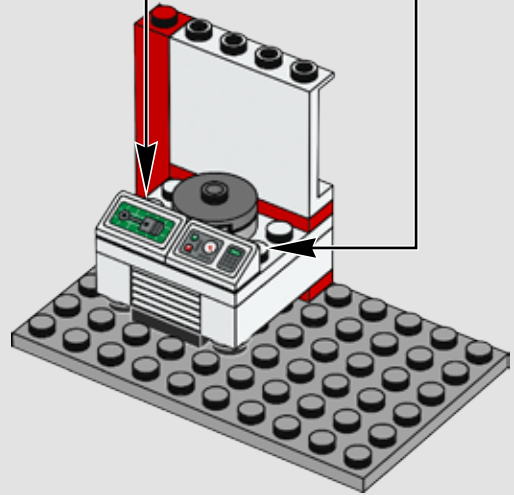

1x

9

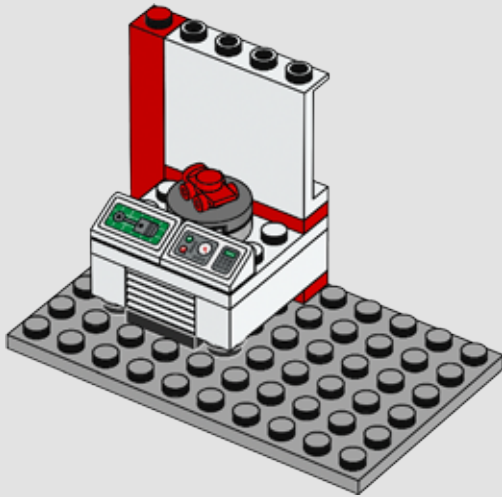

2x

10

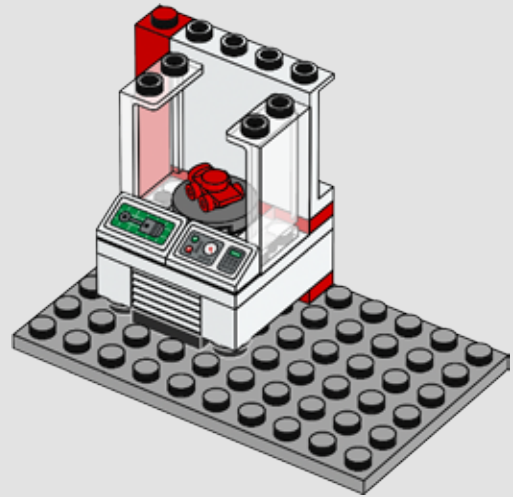



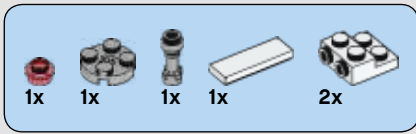

11

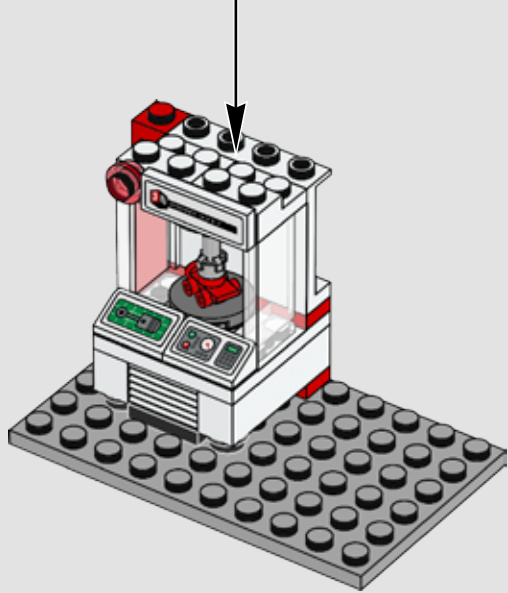
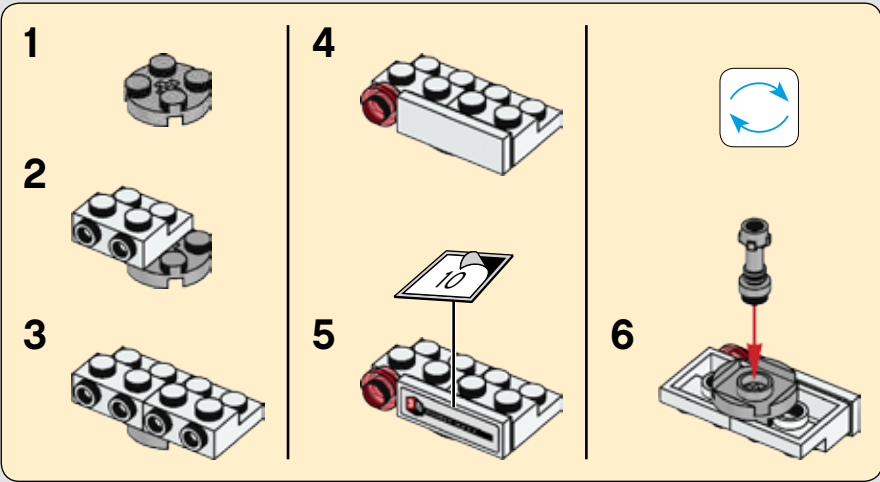

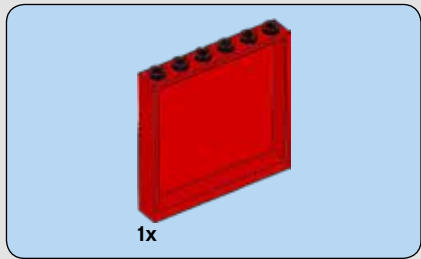

12

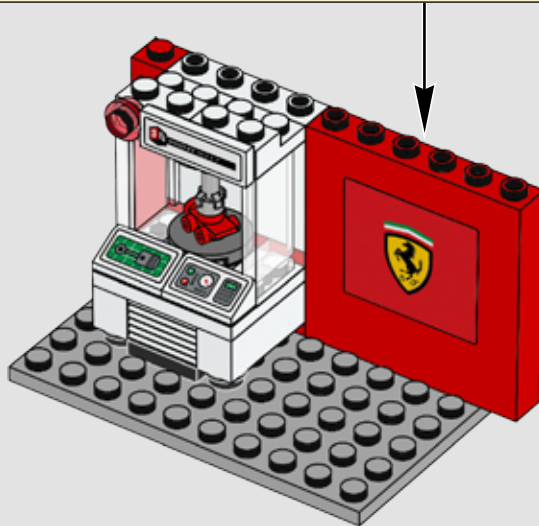
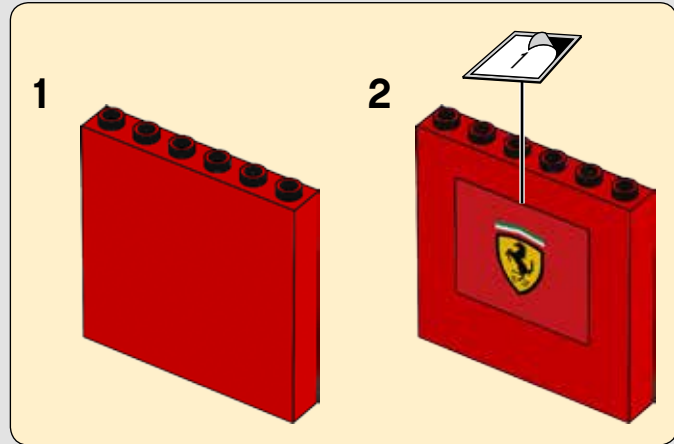

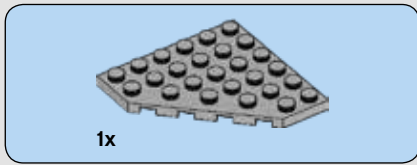

13

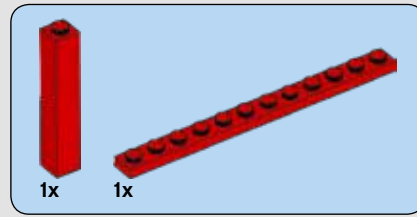
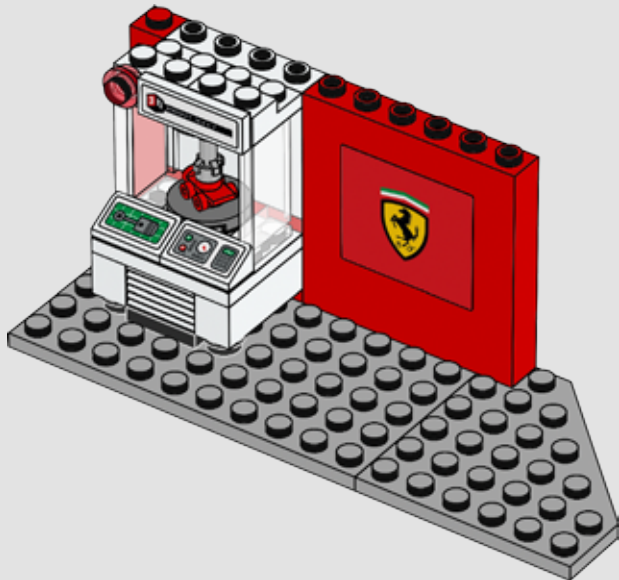

14

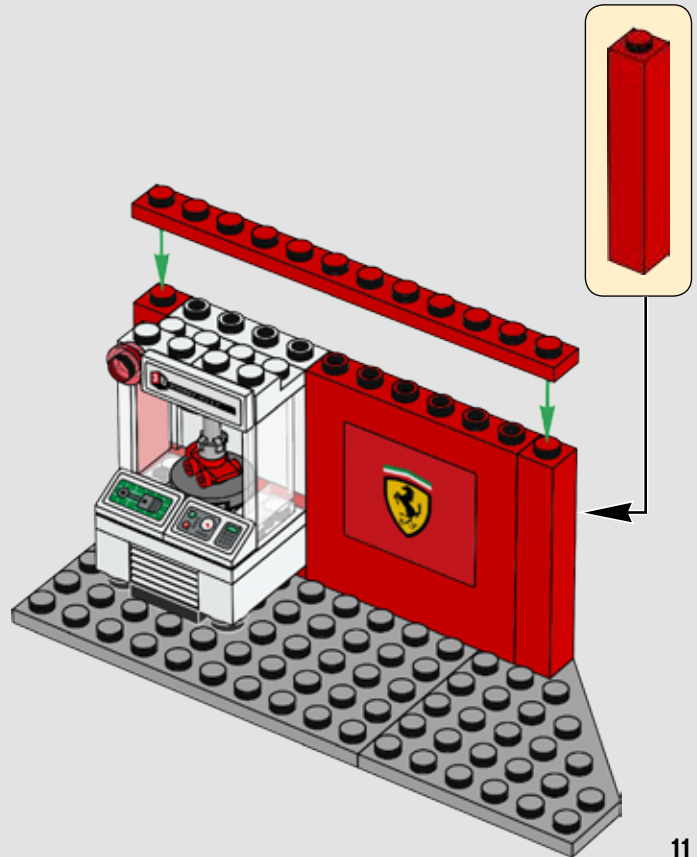

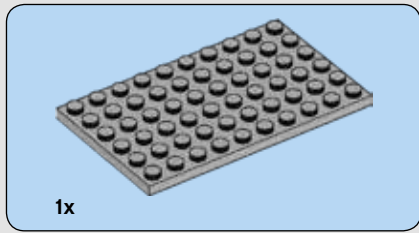

15

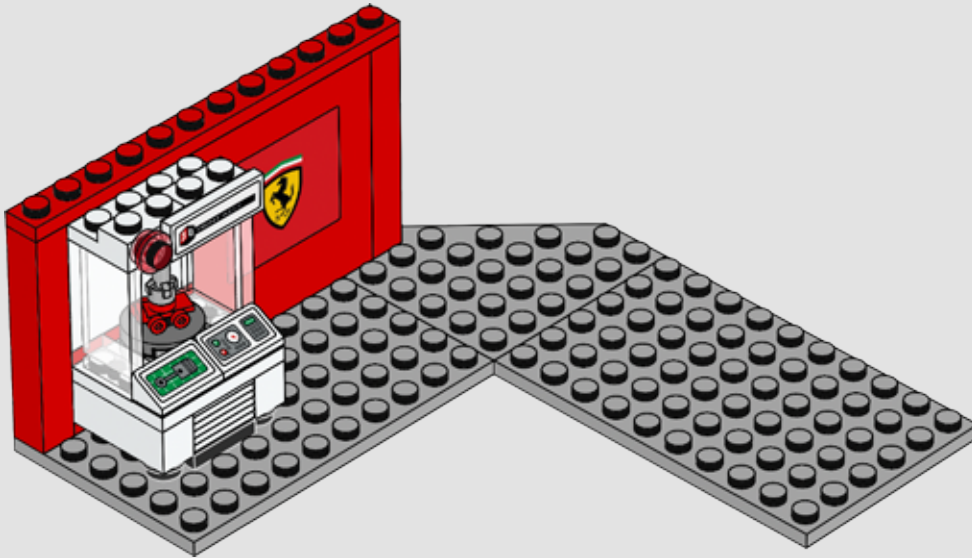

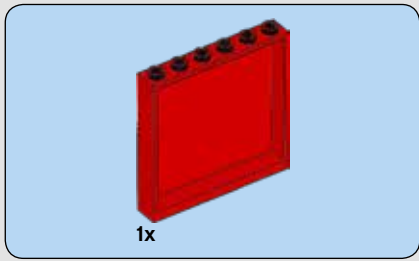

16

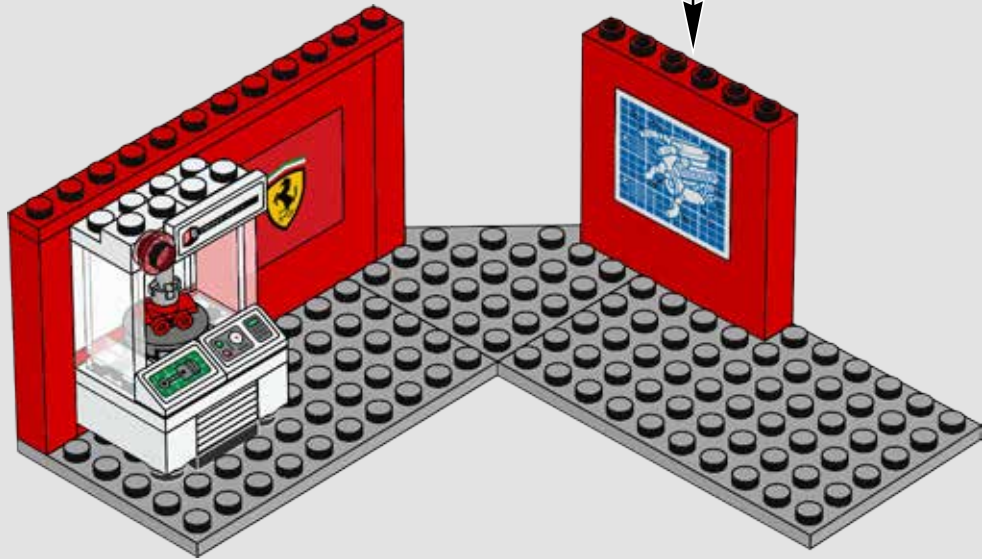
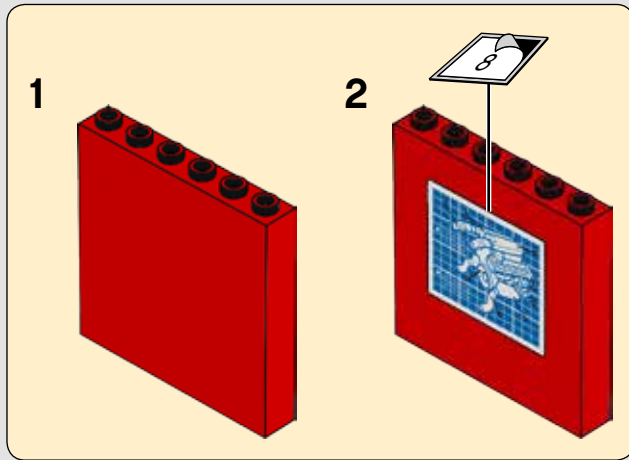



2x

17

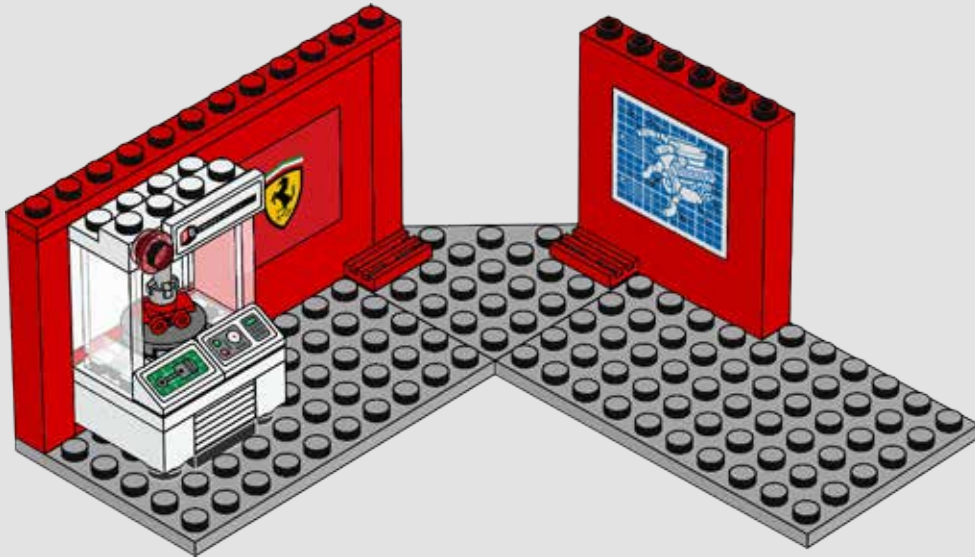

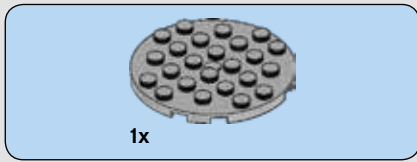

18

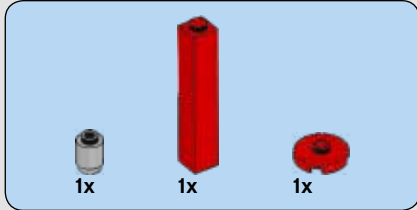
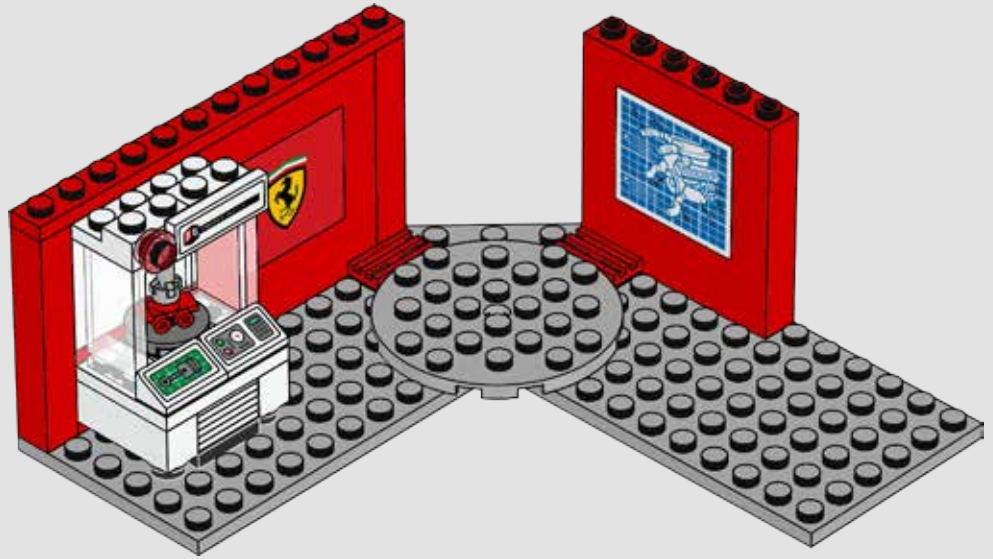

19

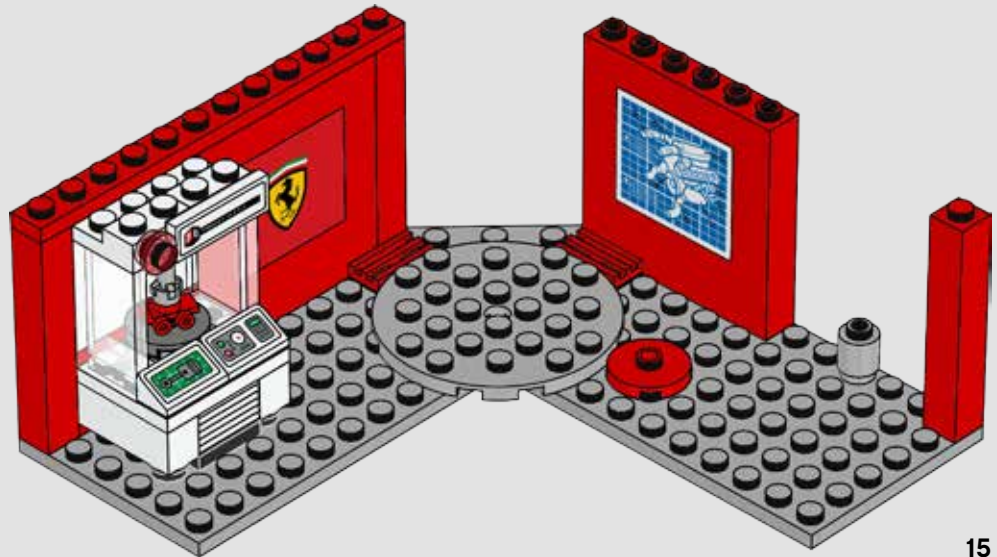

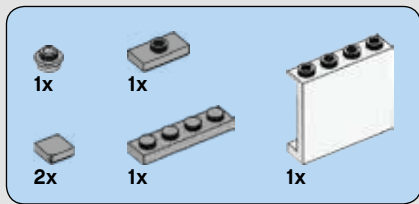

20

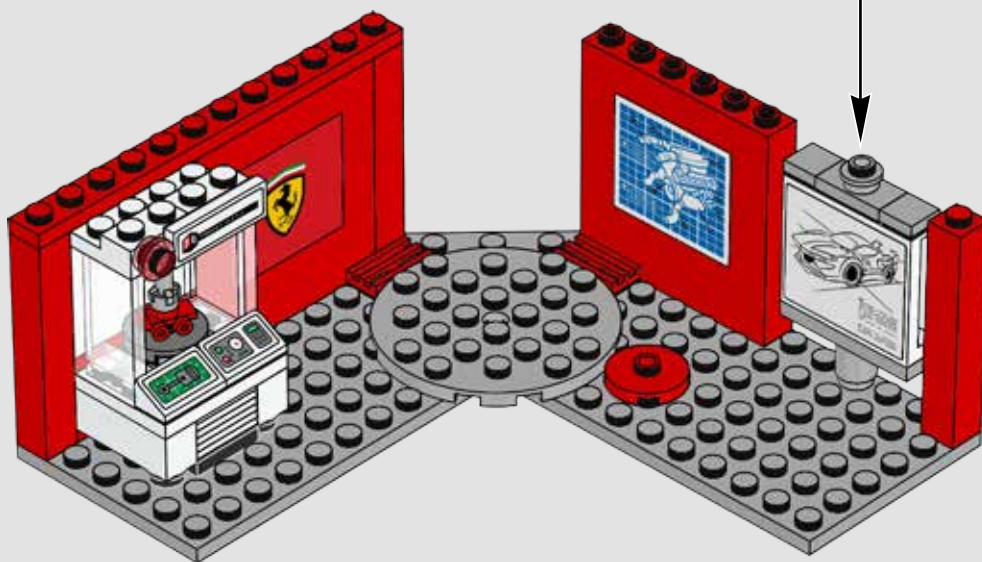
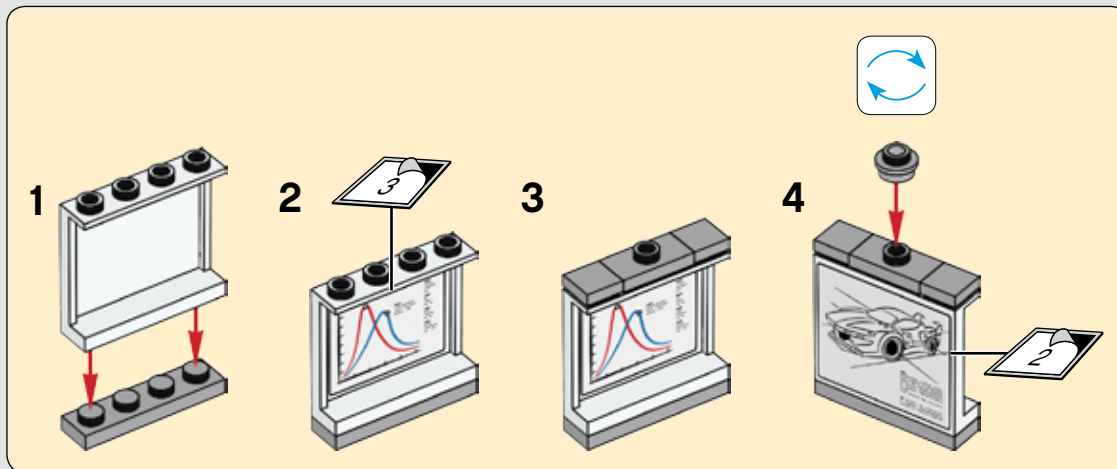



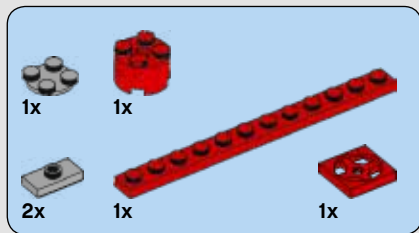

21

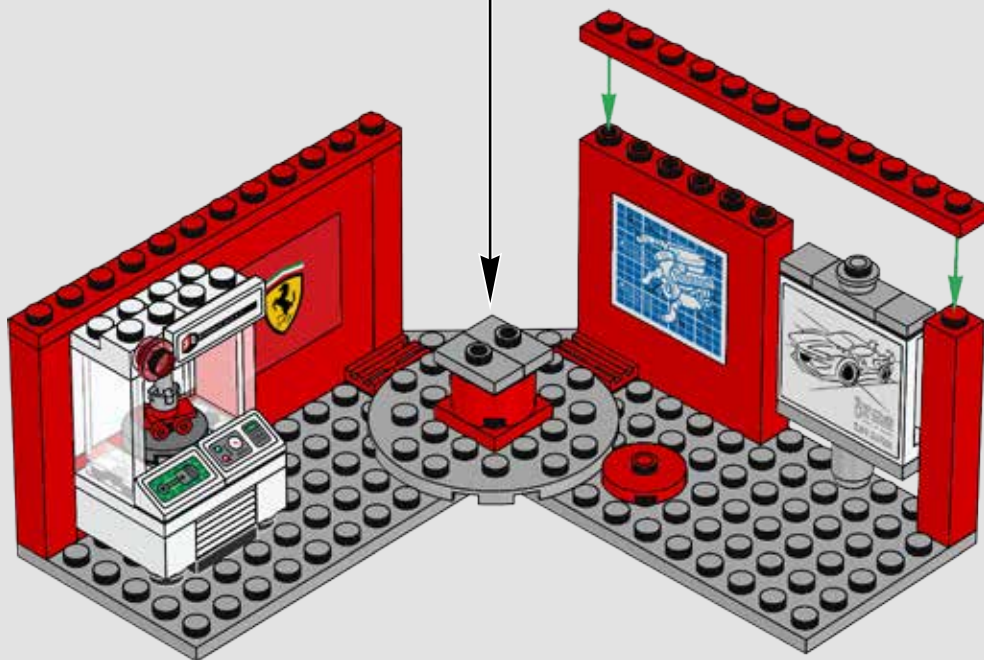
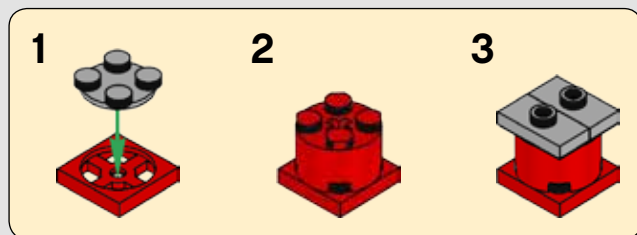



1x

22

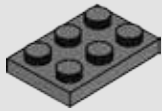

2x



2x

23

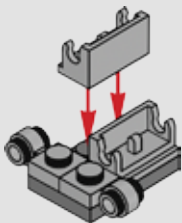

2x



1x

24

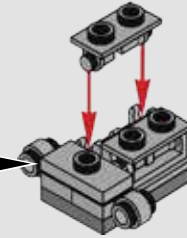
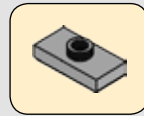

2x



2x

25

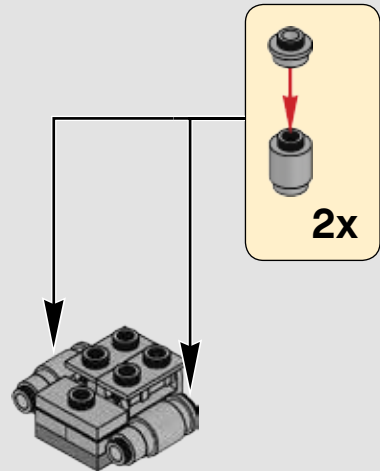



1x

# 26

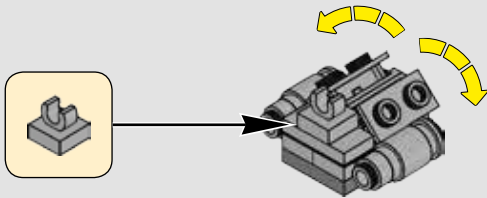

2x



1x

# 27

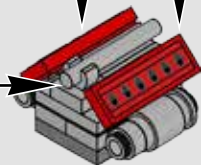
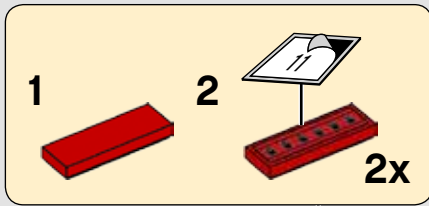

2x



1x



2x



2x

# 28

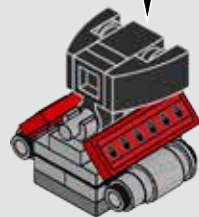
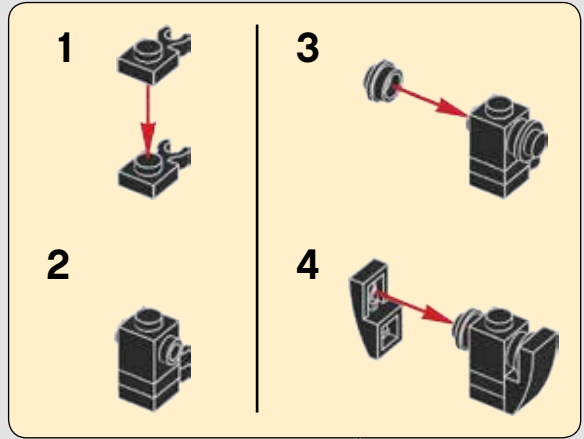

29

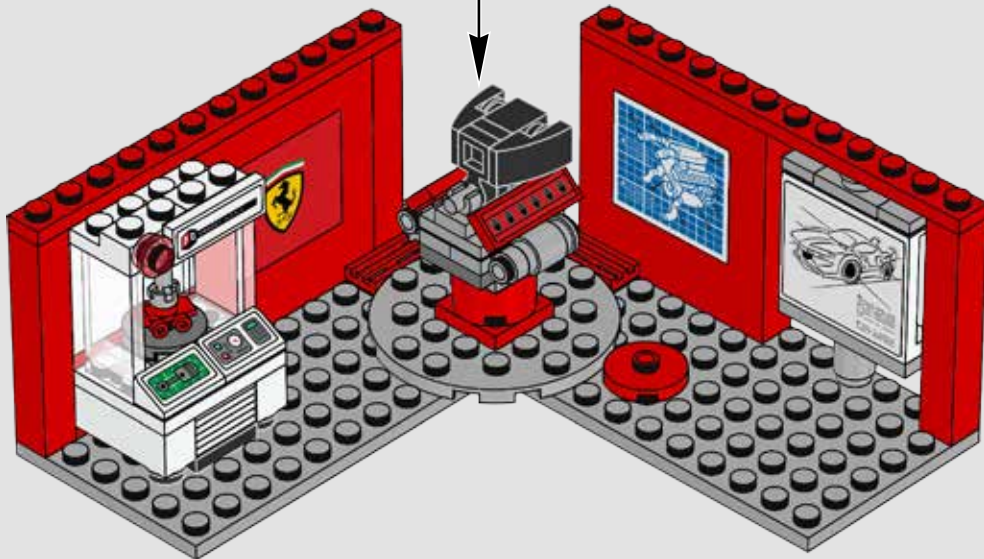

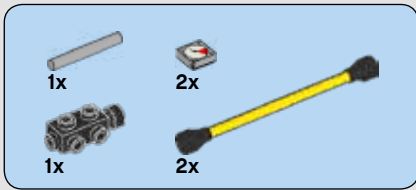

30

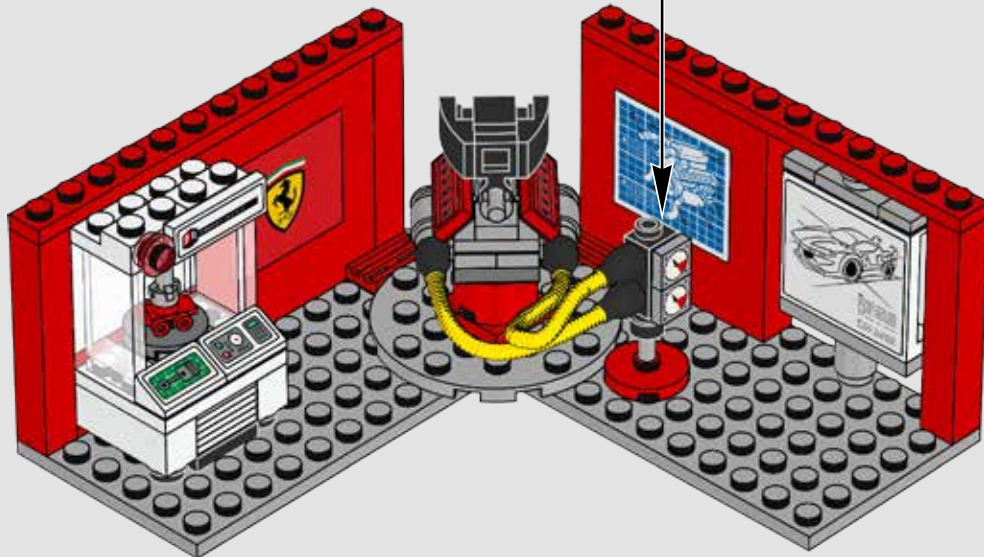
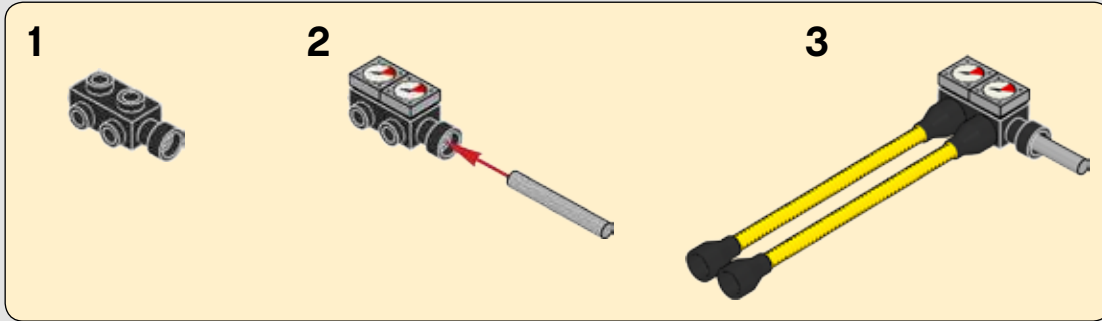



31

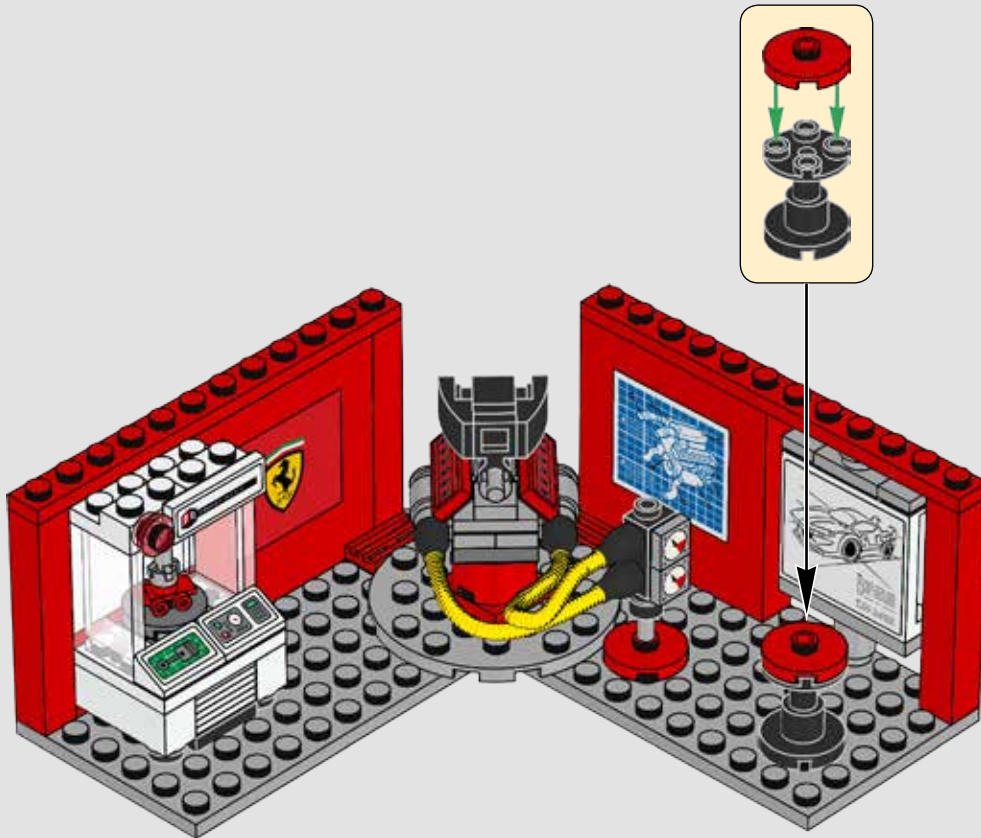

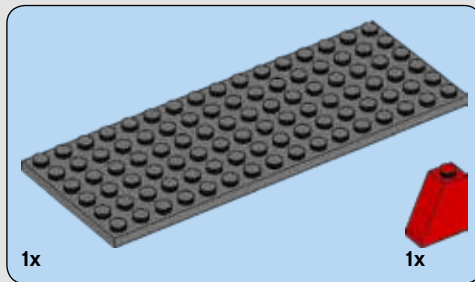
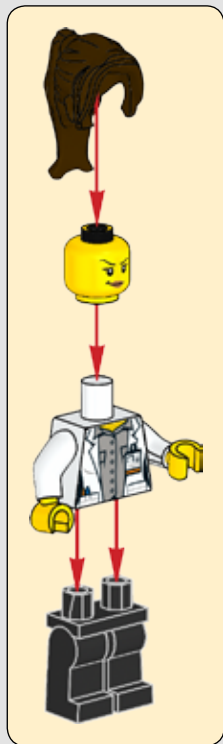
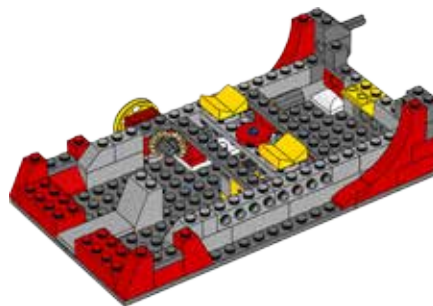
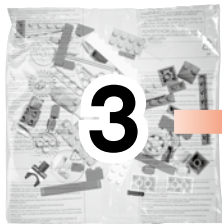

1

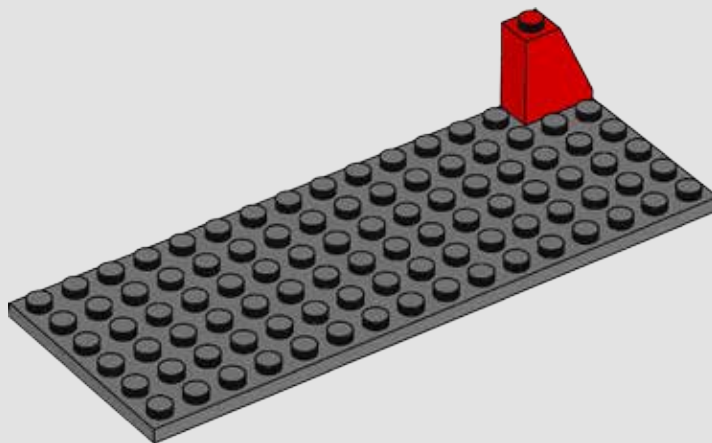

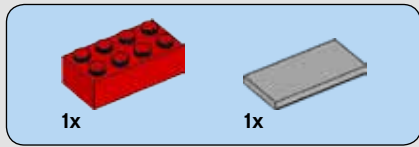

2

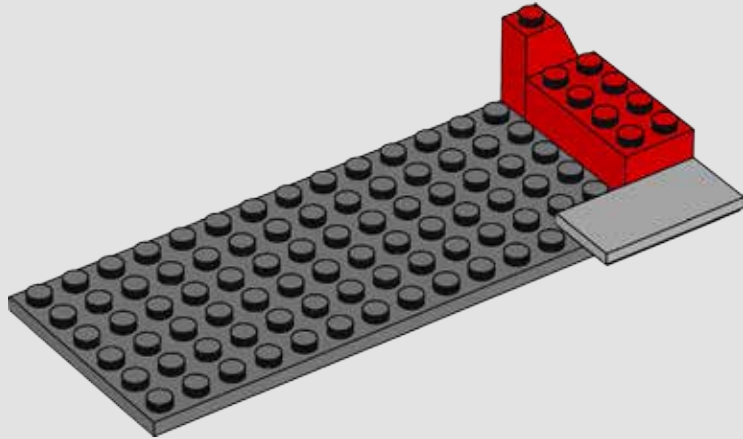



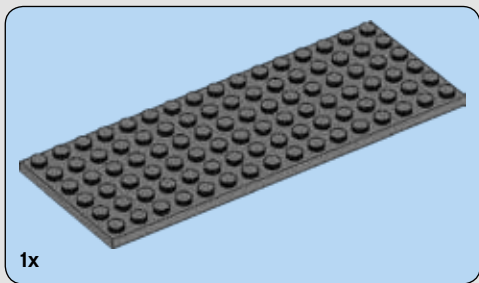

3

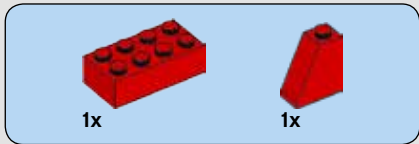
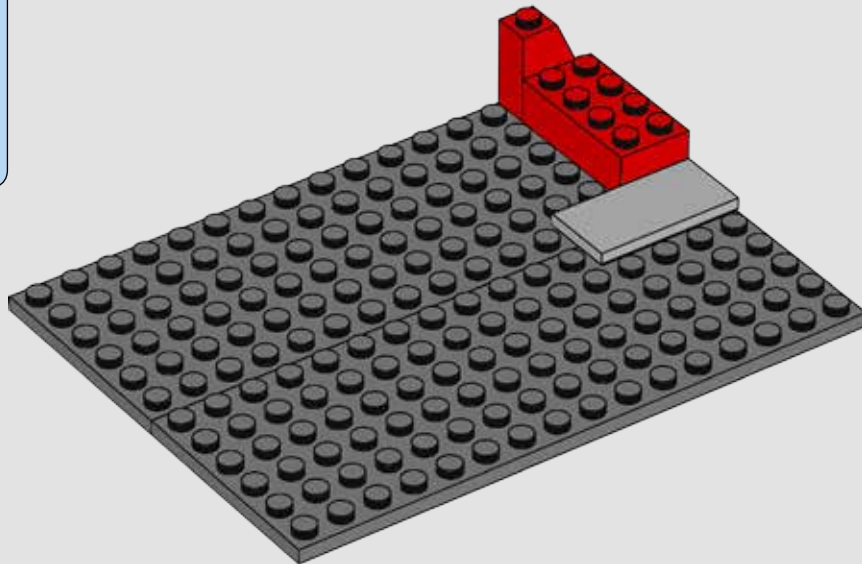

4

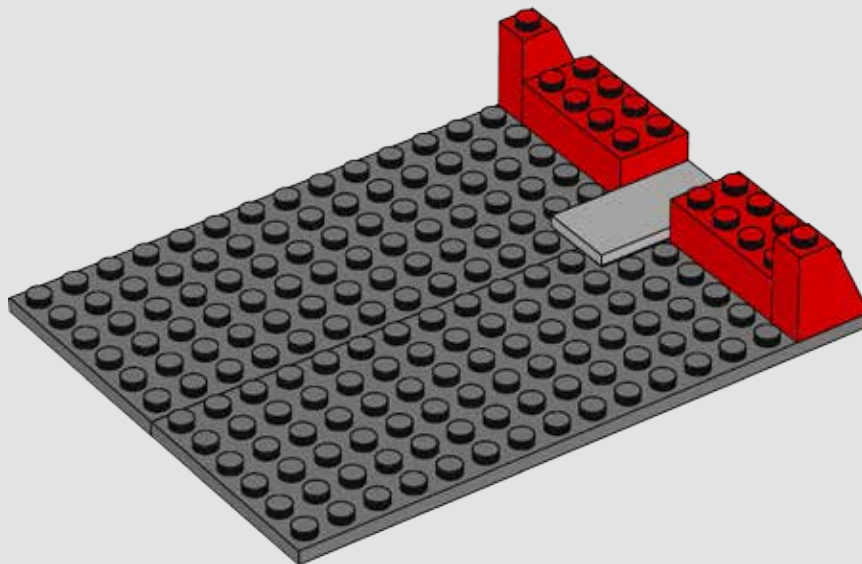

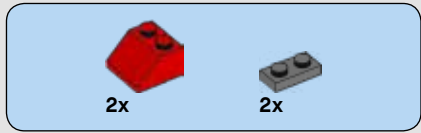

5

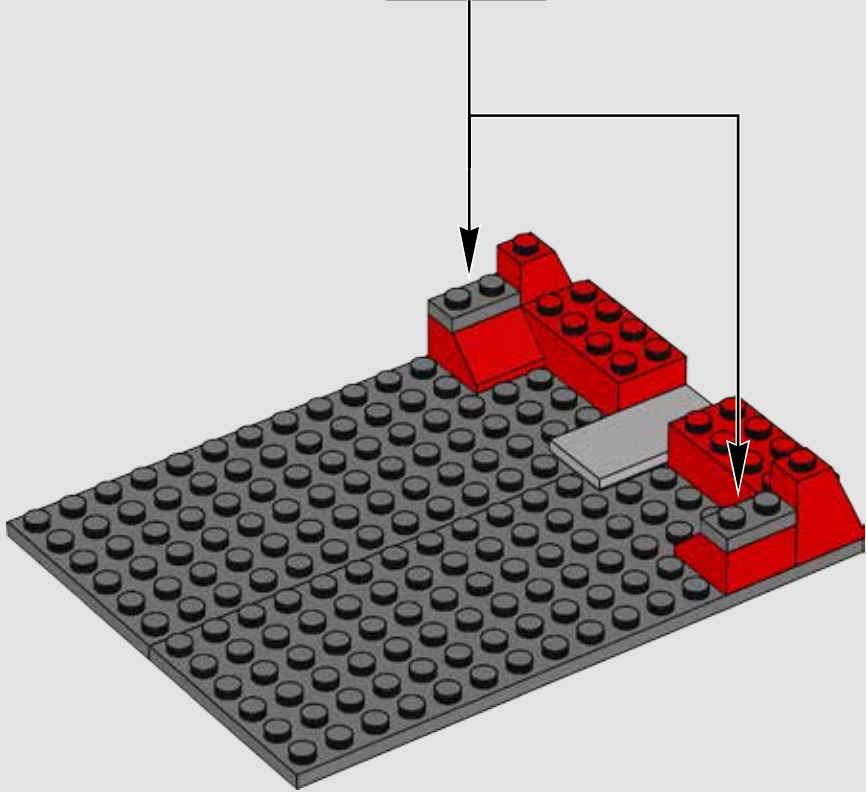
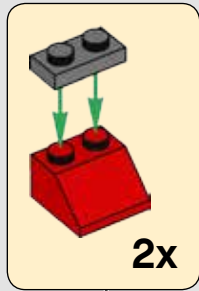

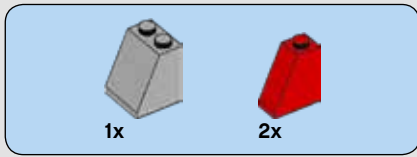

6

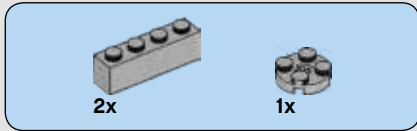
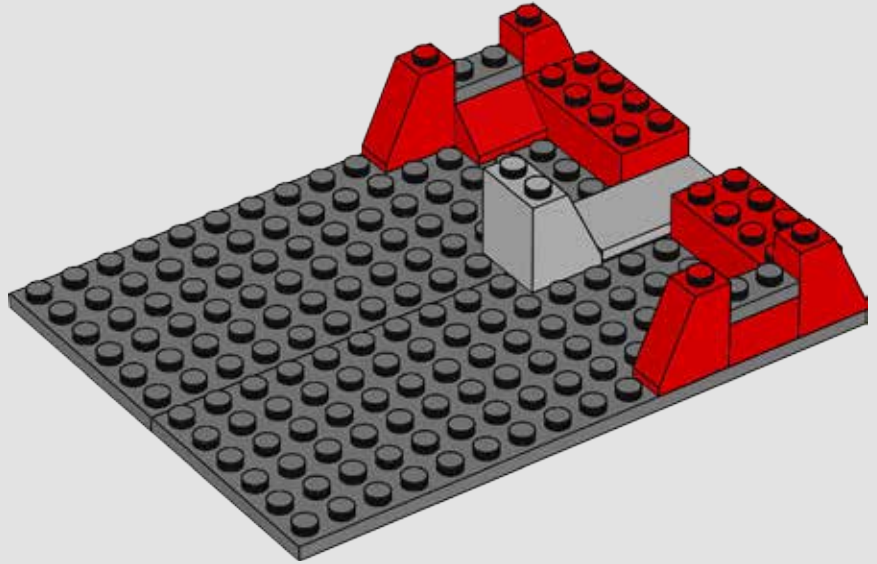

7

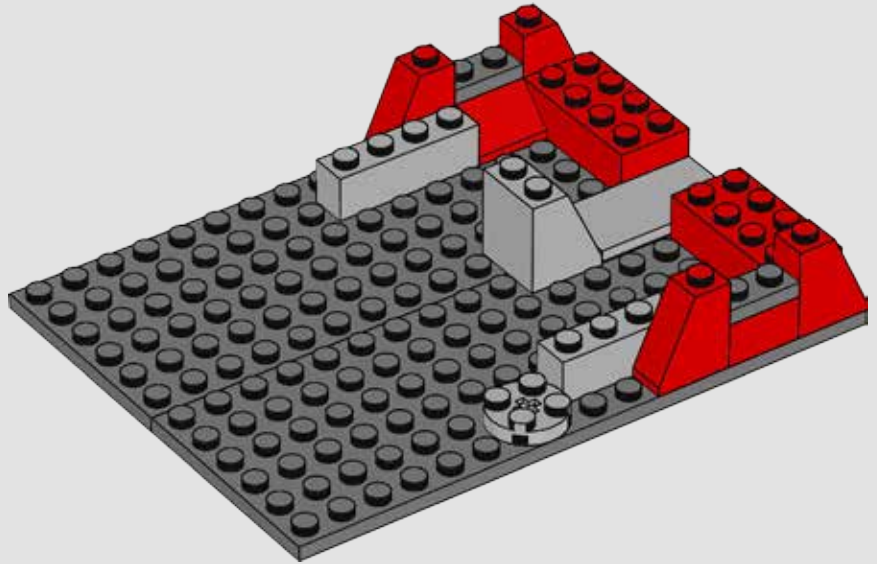

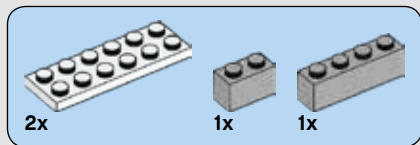

8

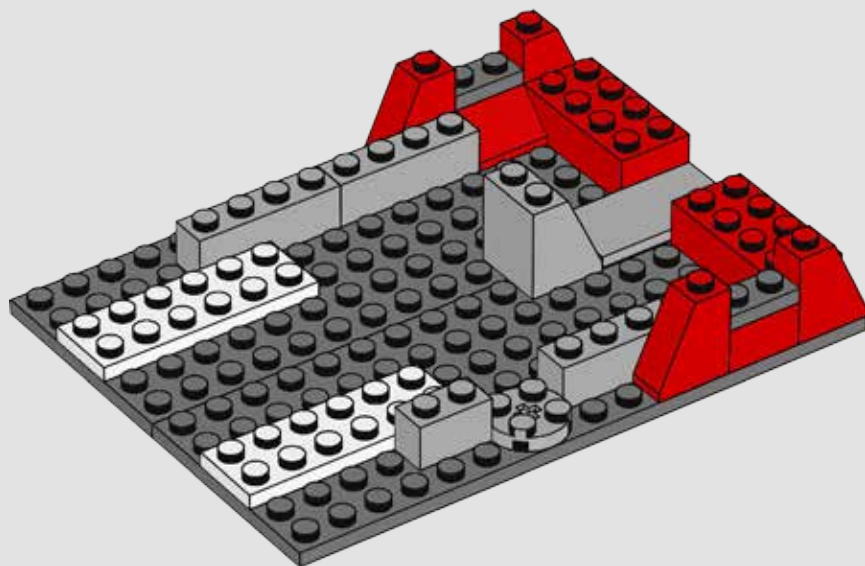



4x

9

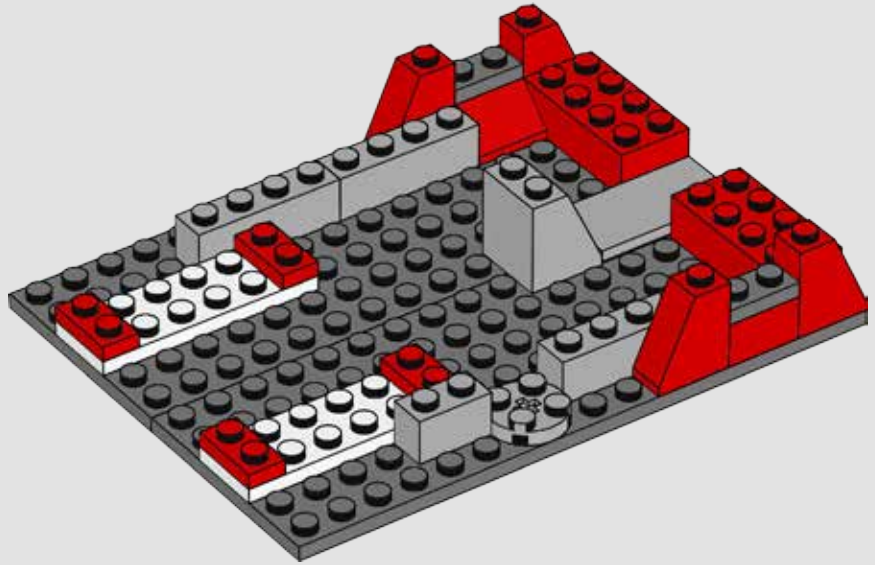

3x



1x

10

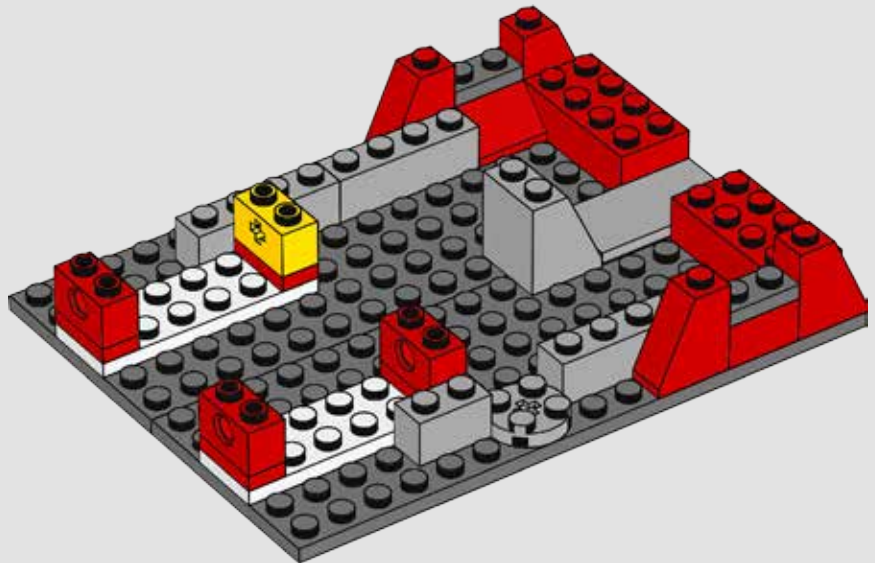

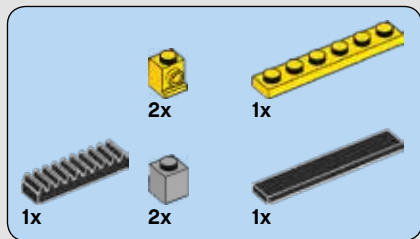

# 11

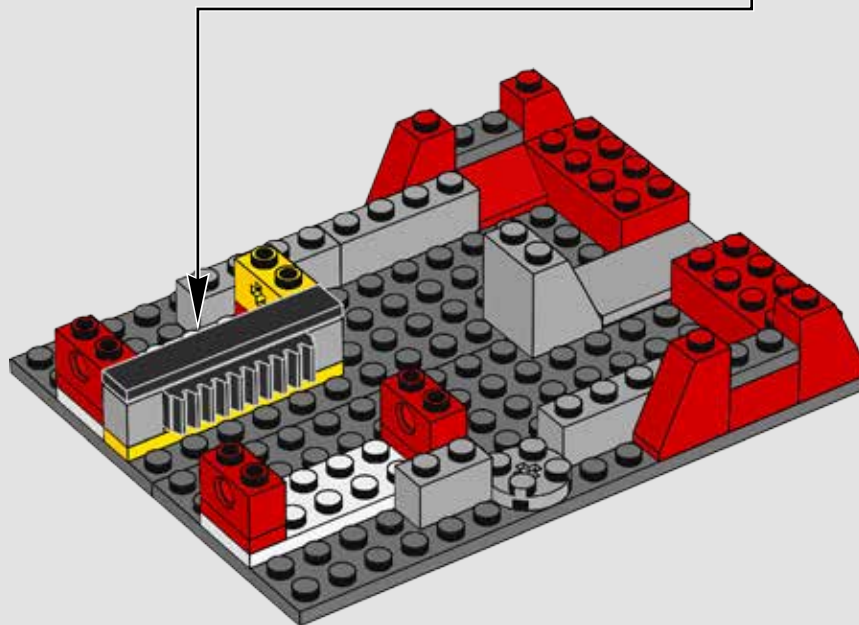
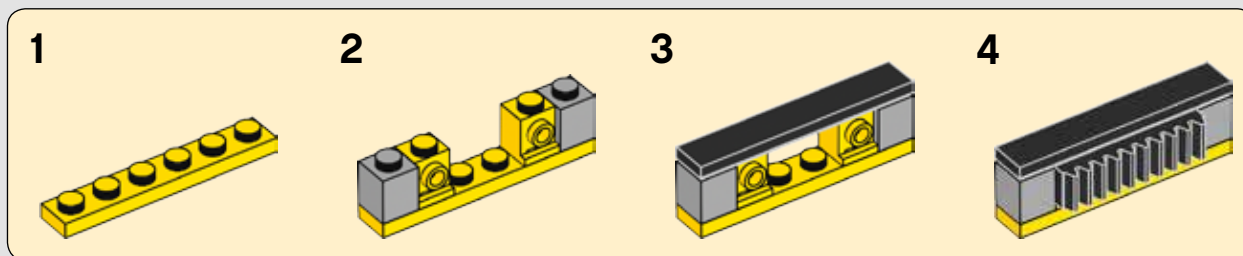

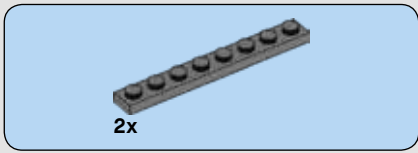

12

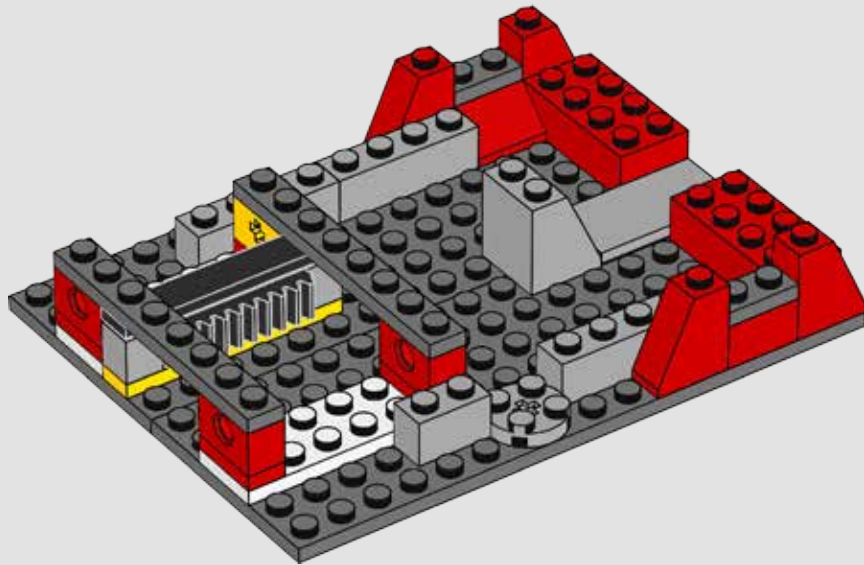

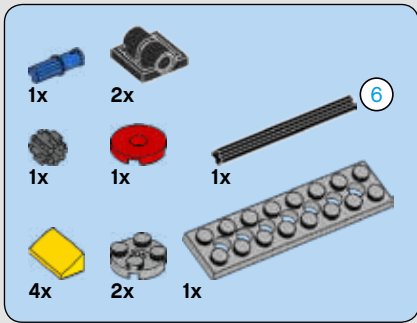

13

1

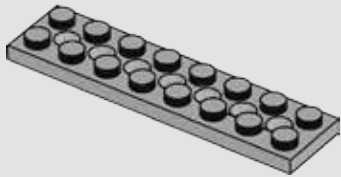

2

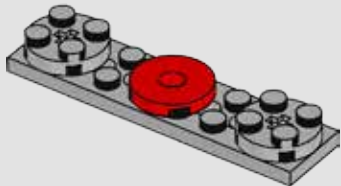

3

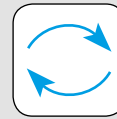
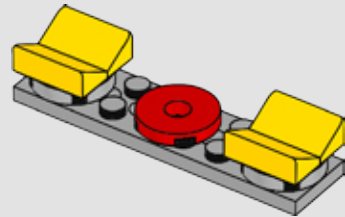

4

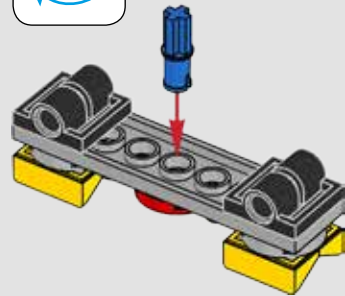

5

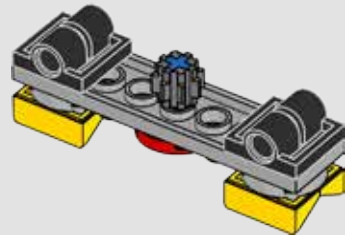



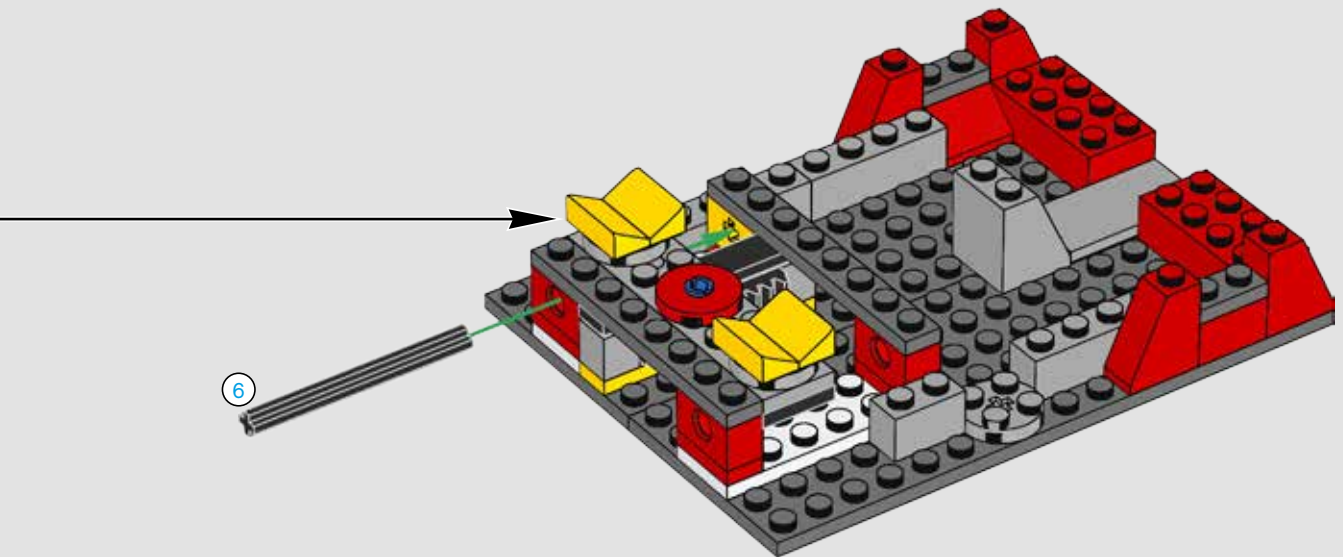

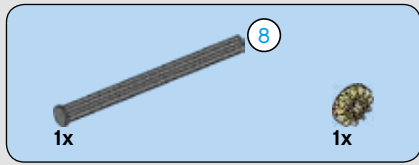

14

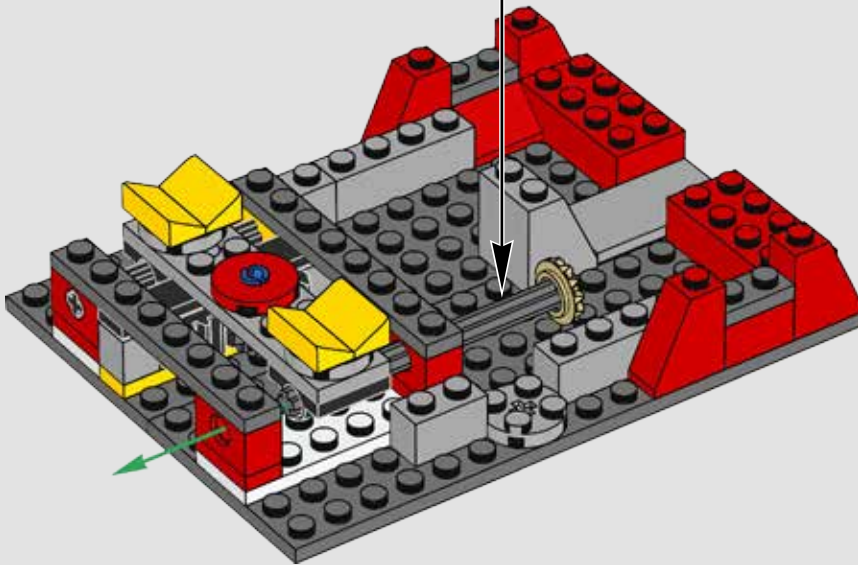
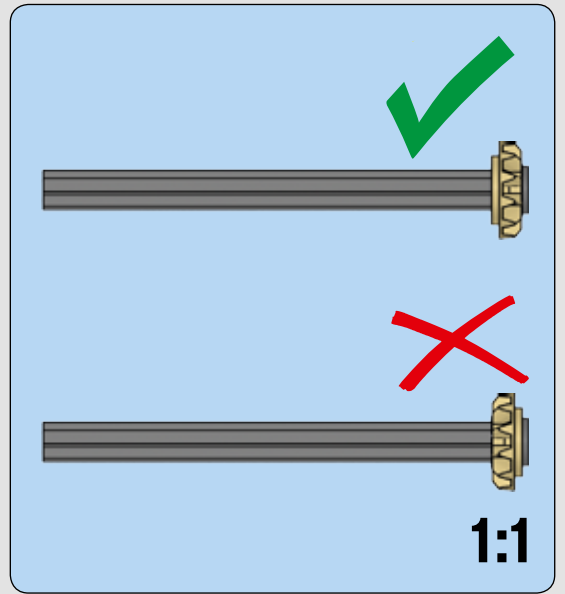
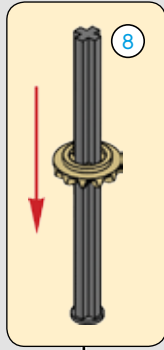



1x



1x

15

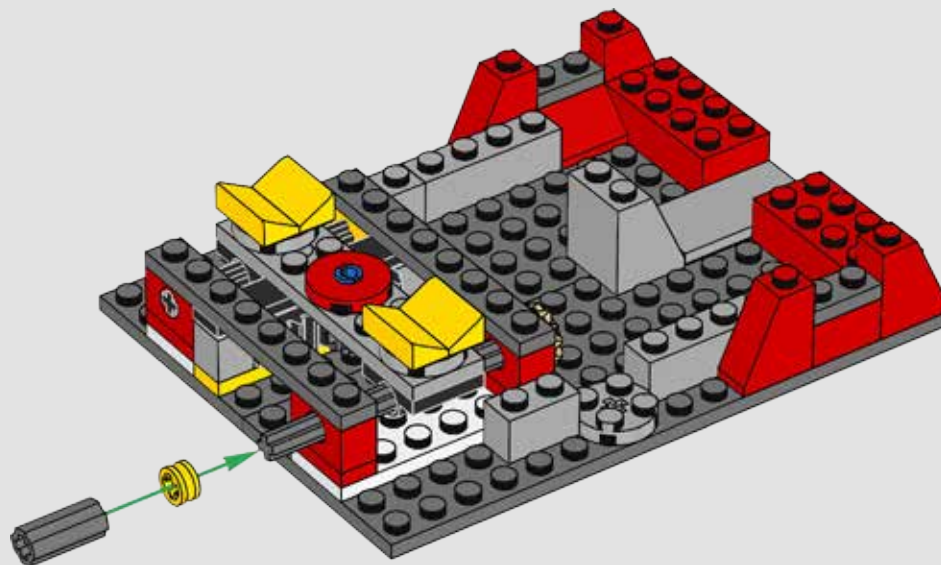

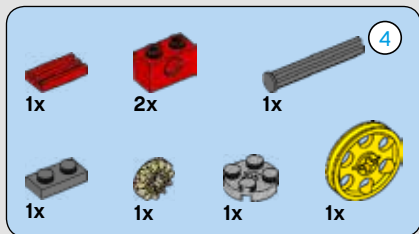

16

1



2

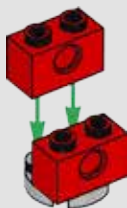

3



4

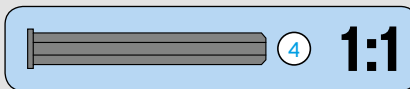
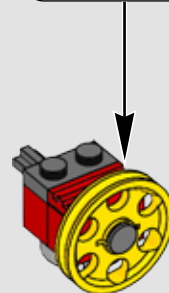
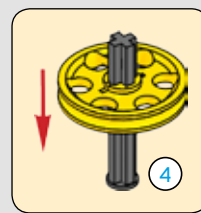

5

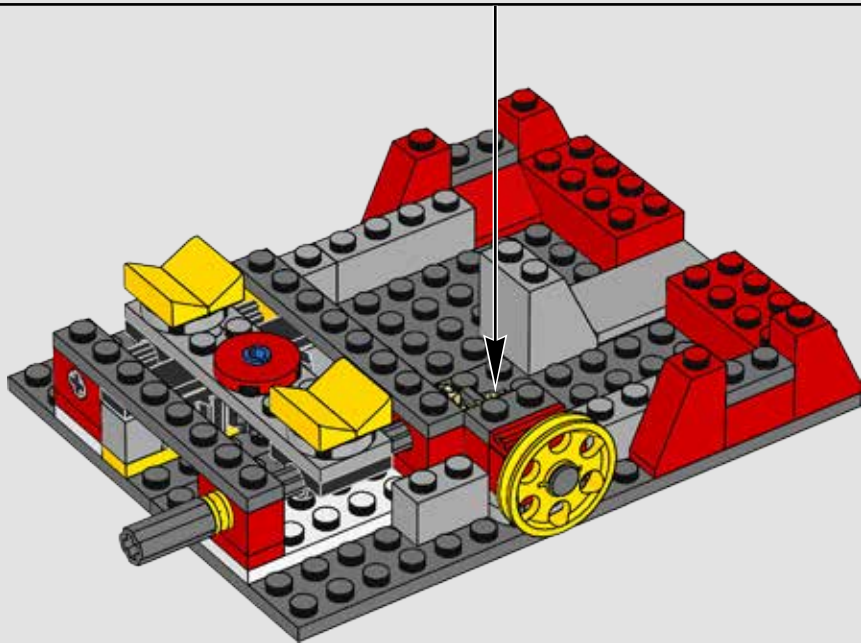
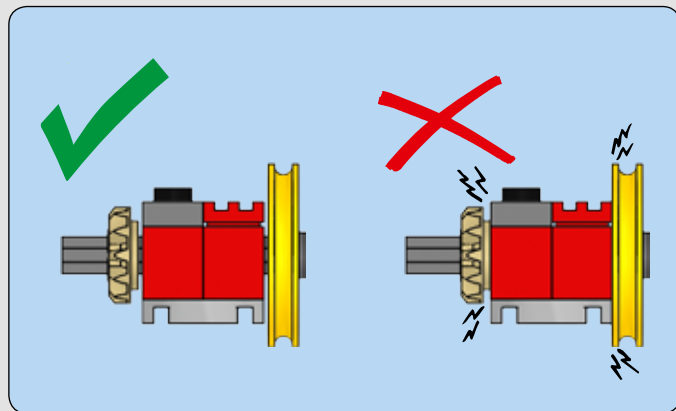
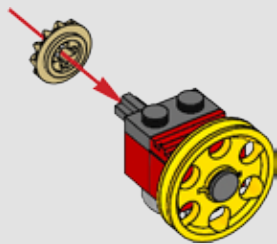

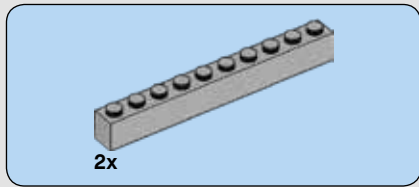

17

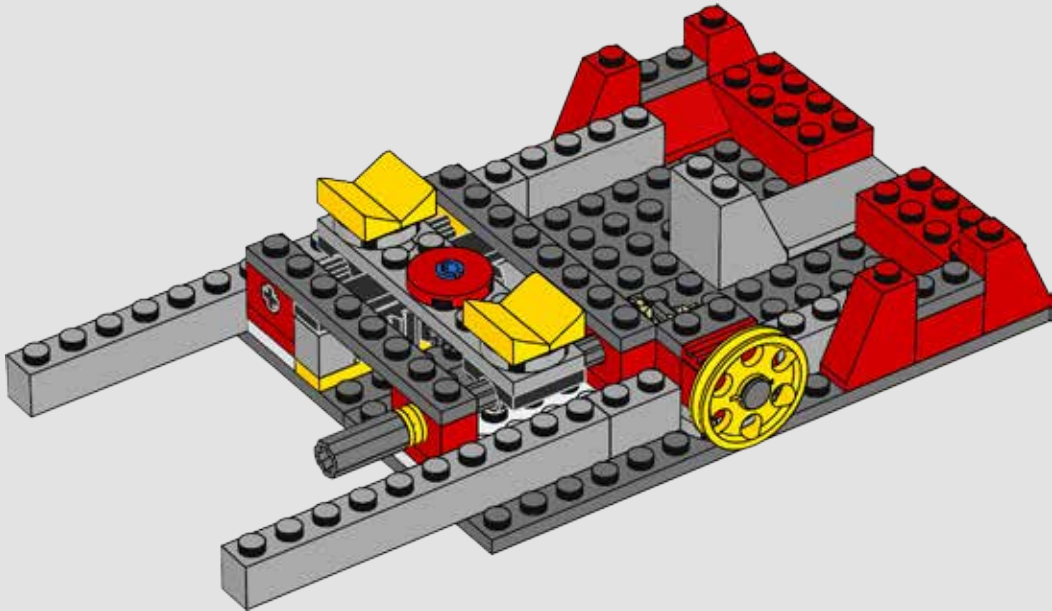

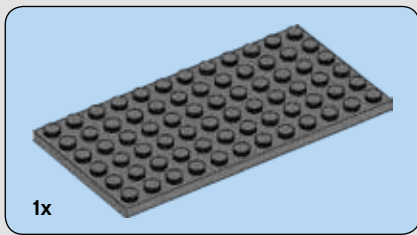

18

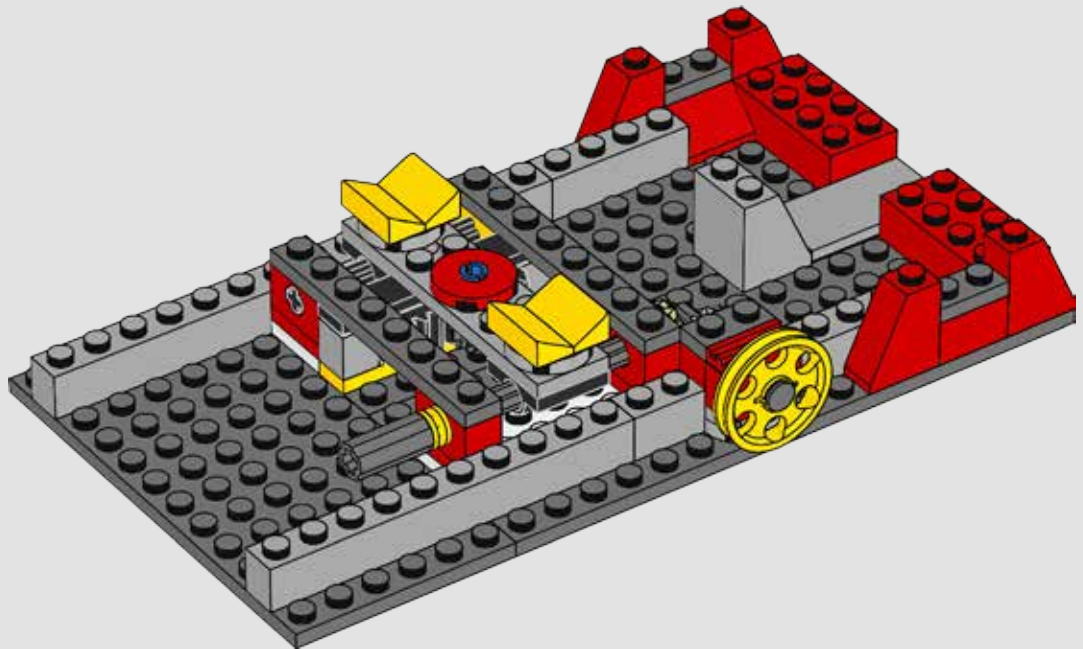



2x

19

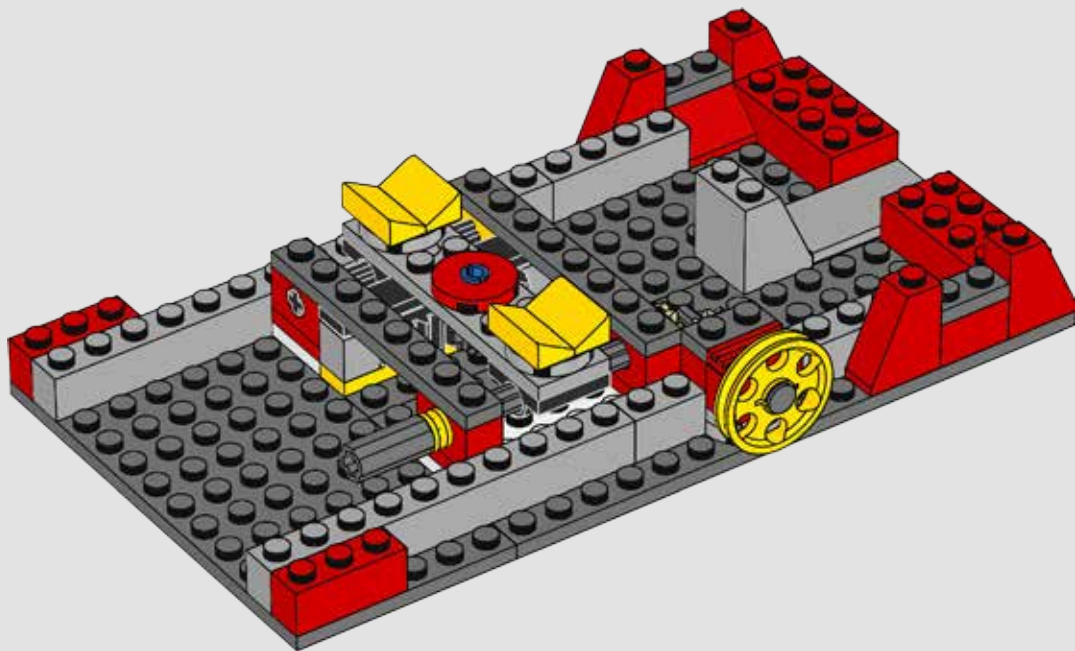



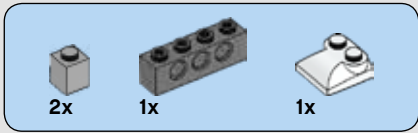

20

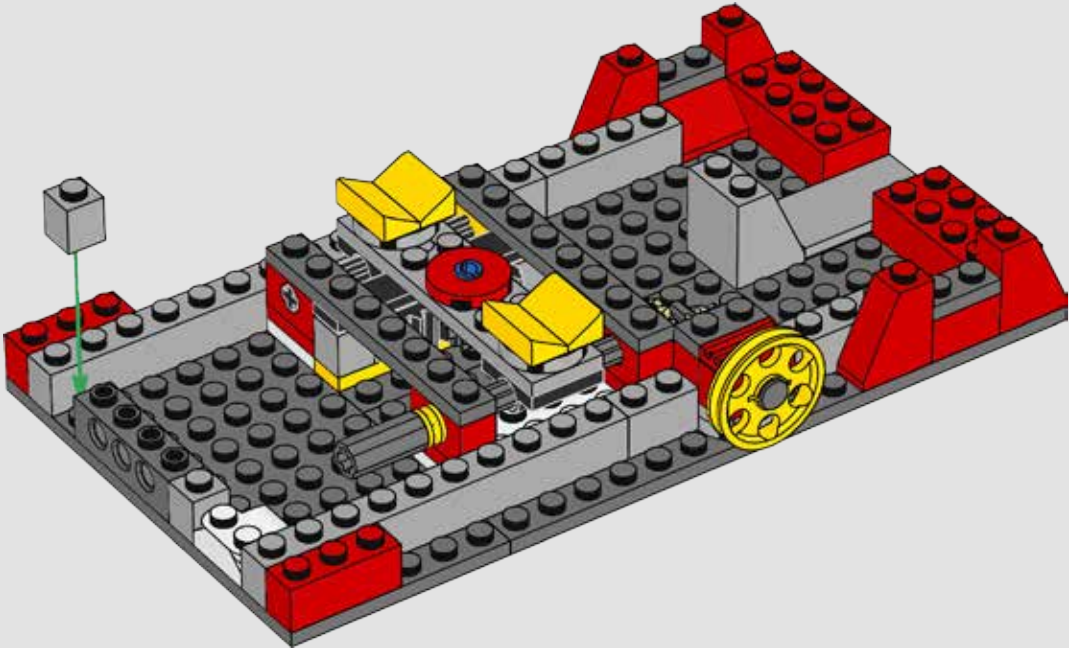

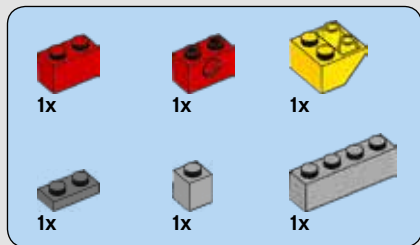

21

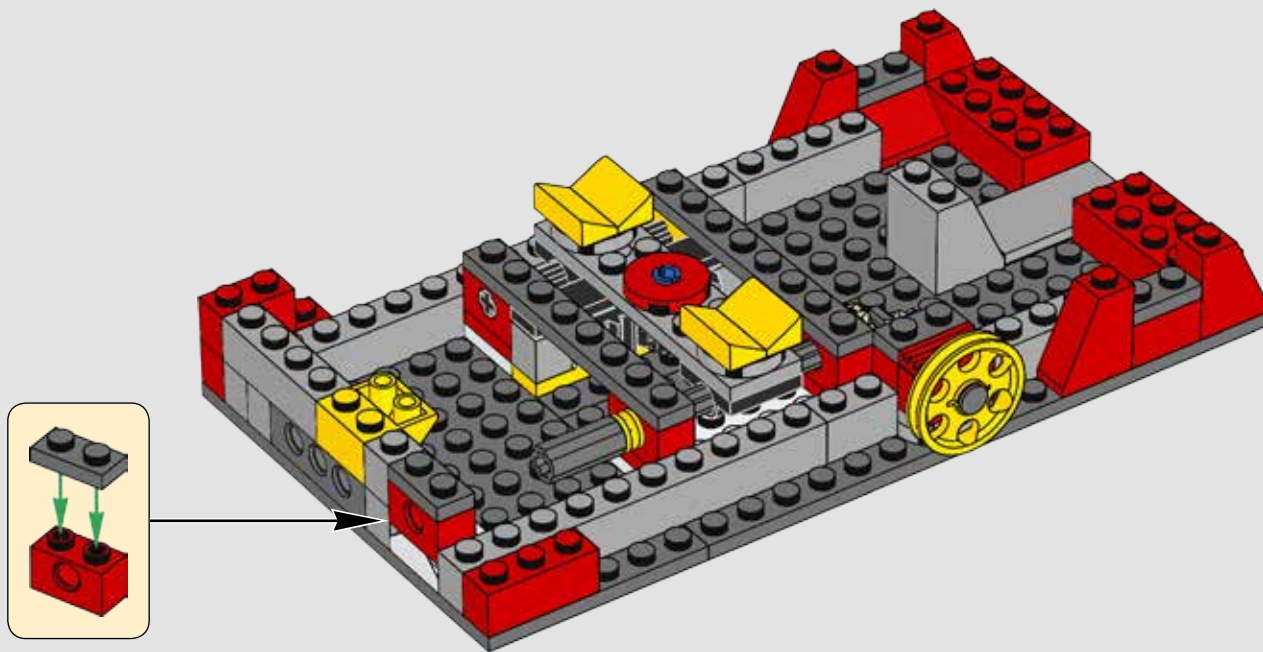

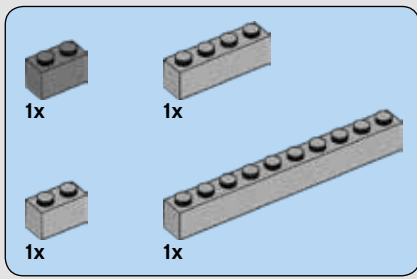

22

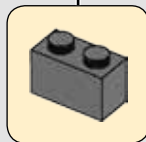
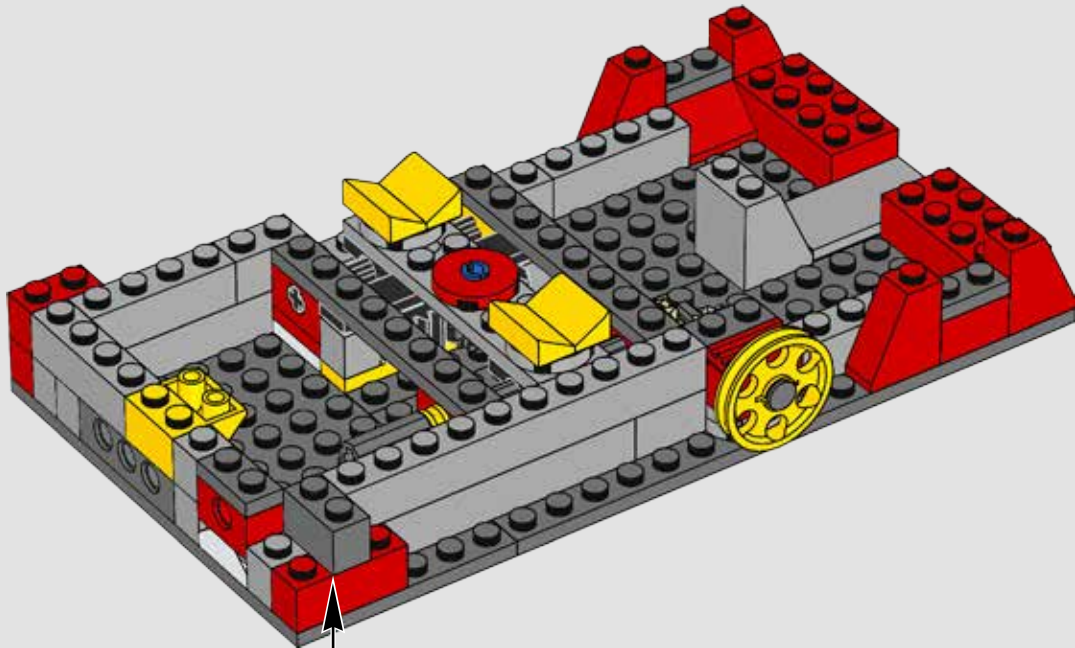

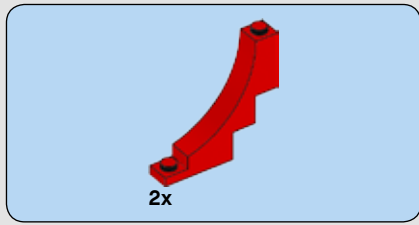

23

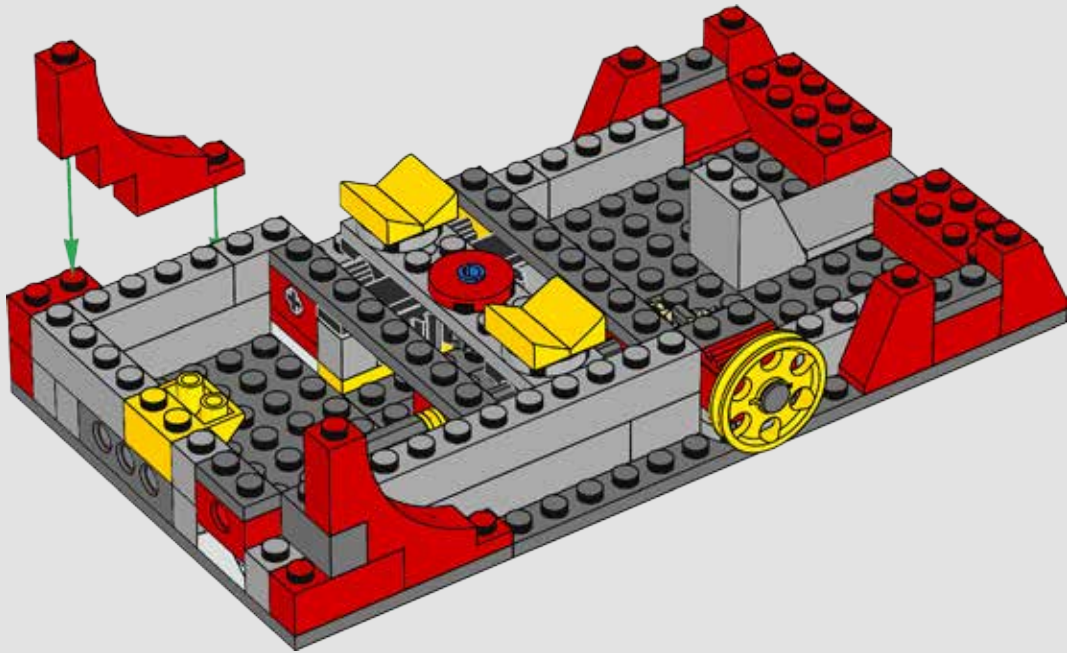

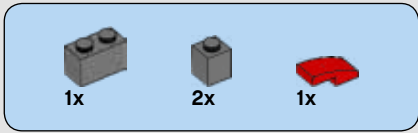

24

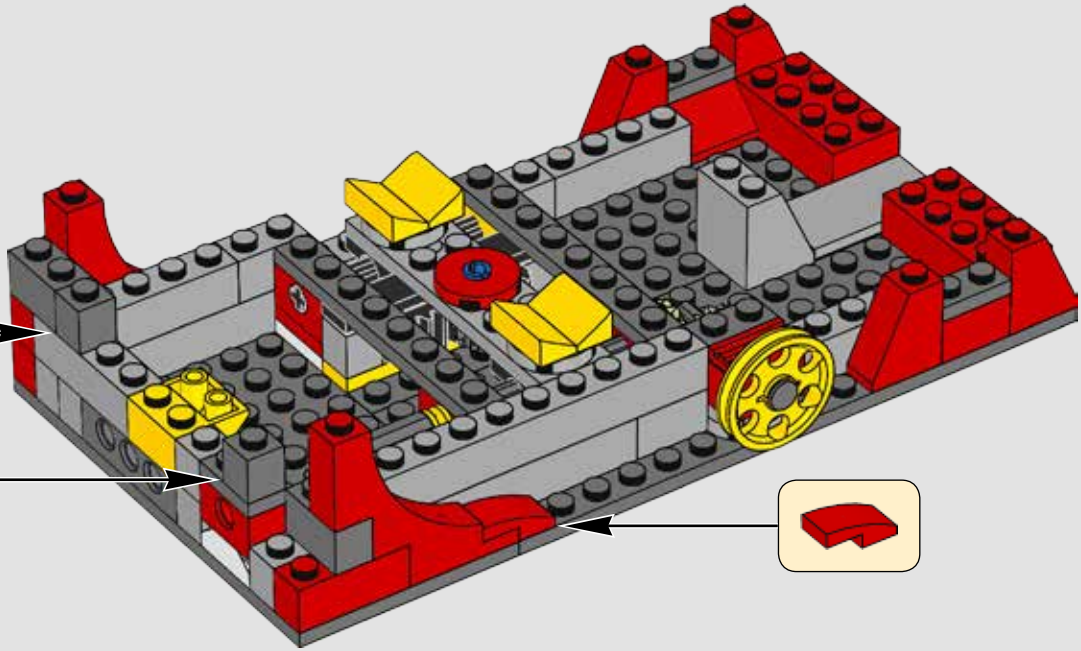
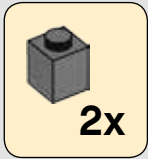

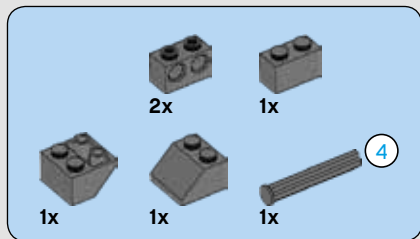

25

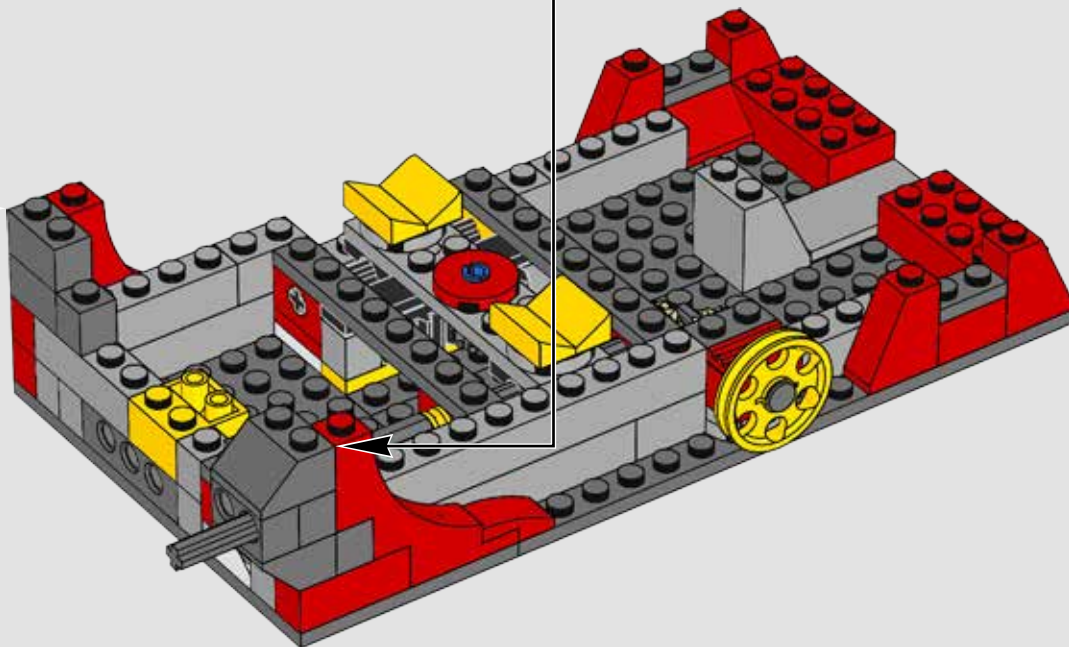
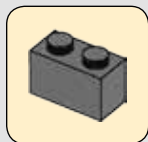
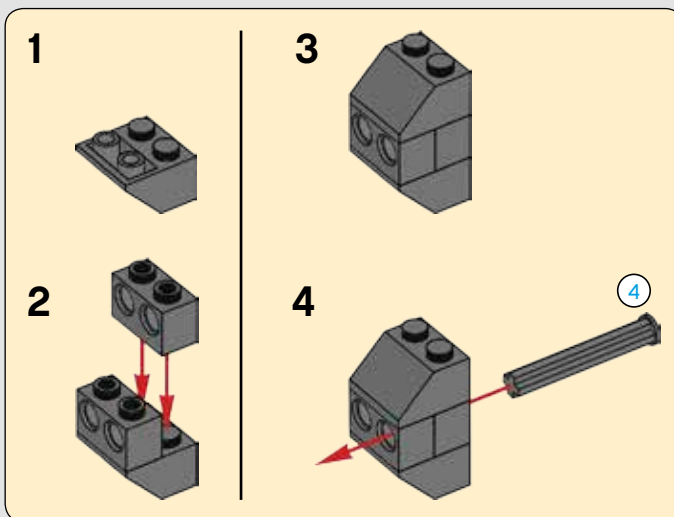
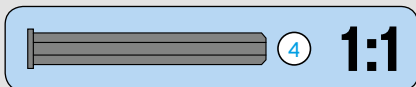

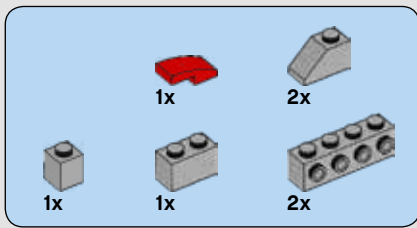

26

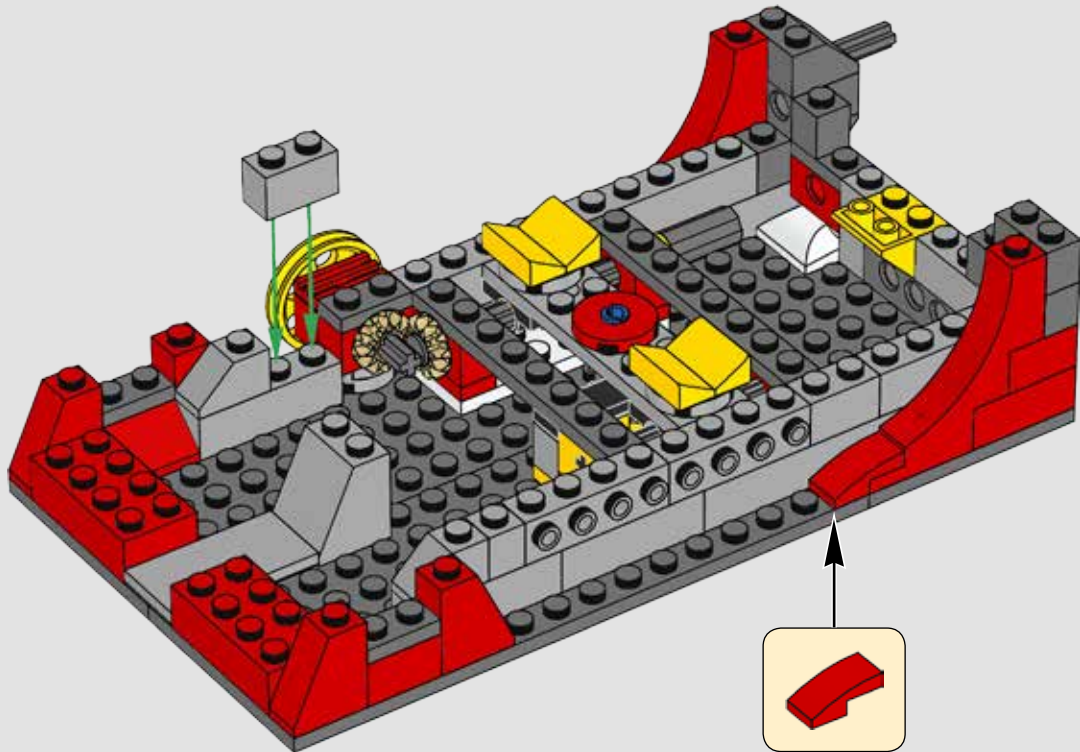
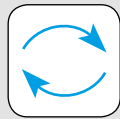

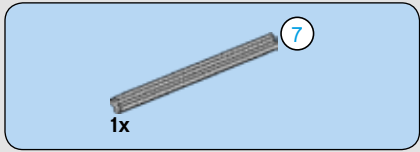
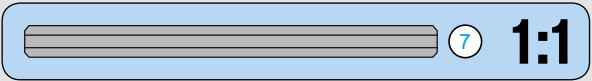
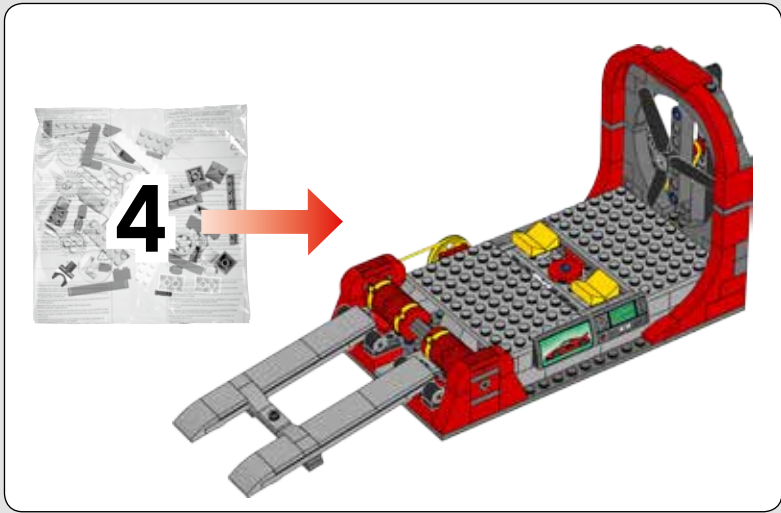

27

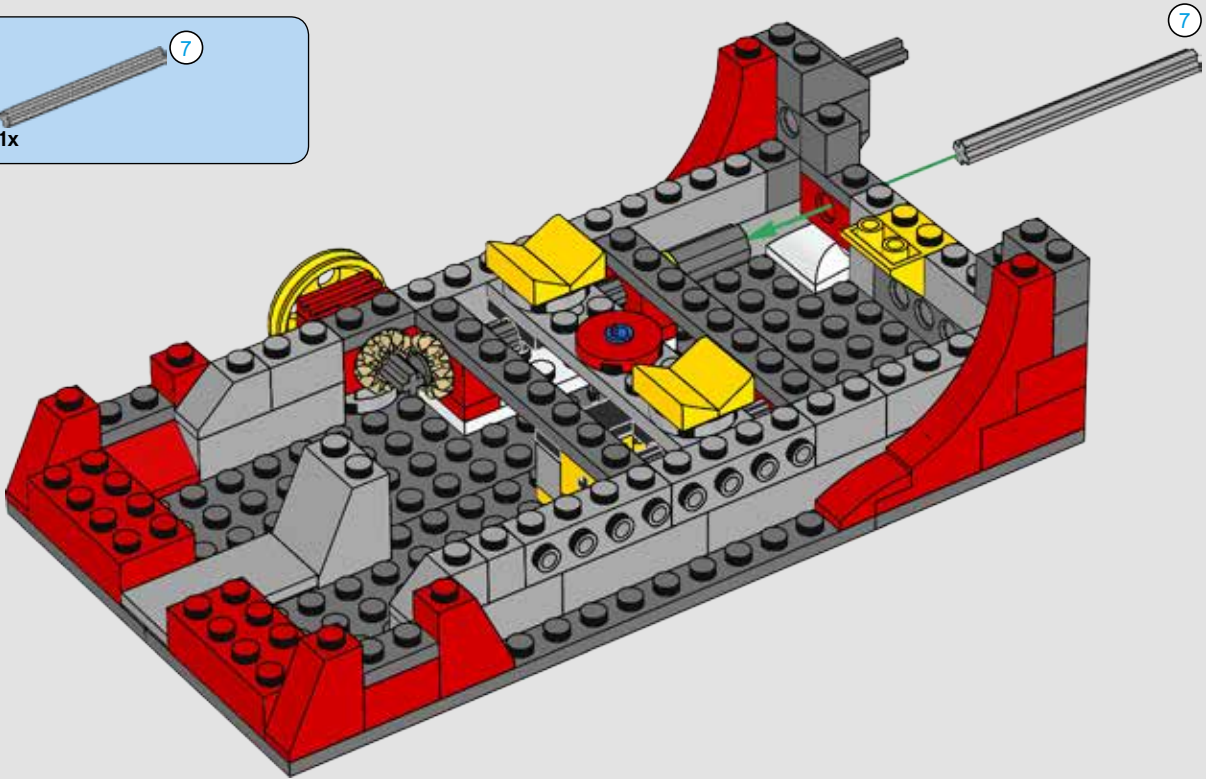





1x



1x

28

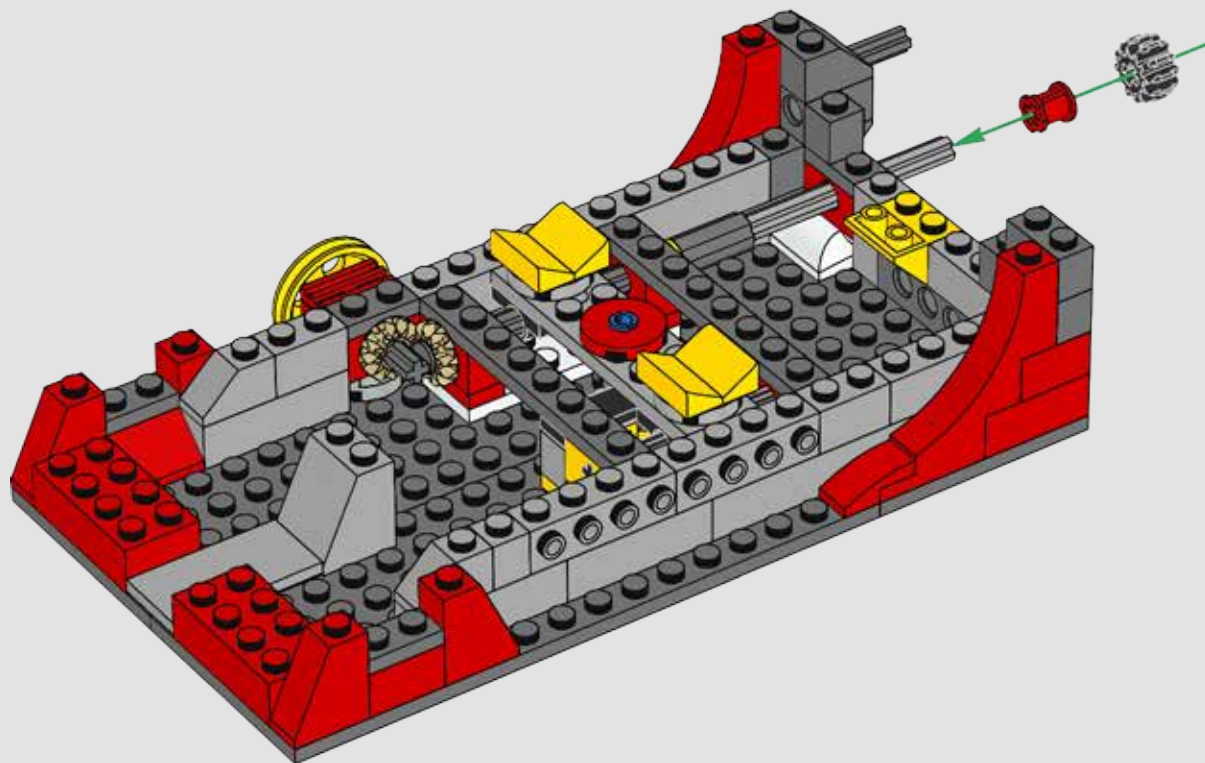

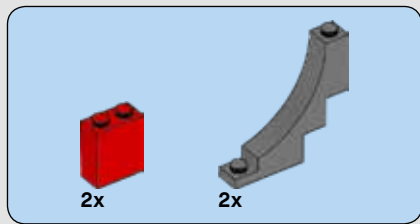

29

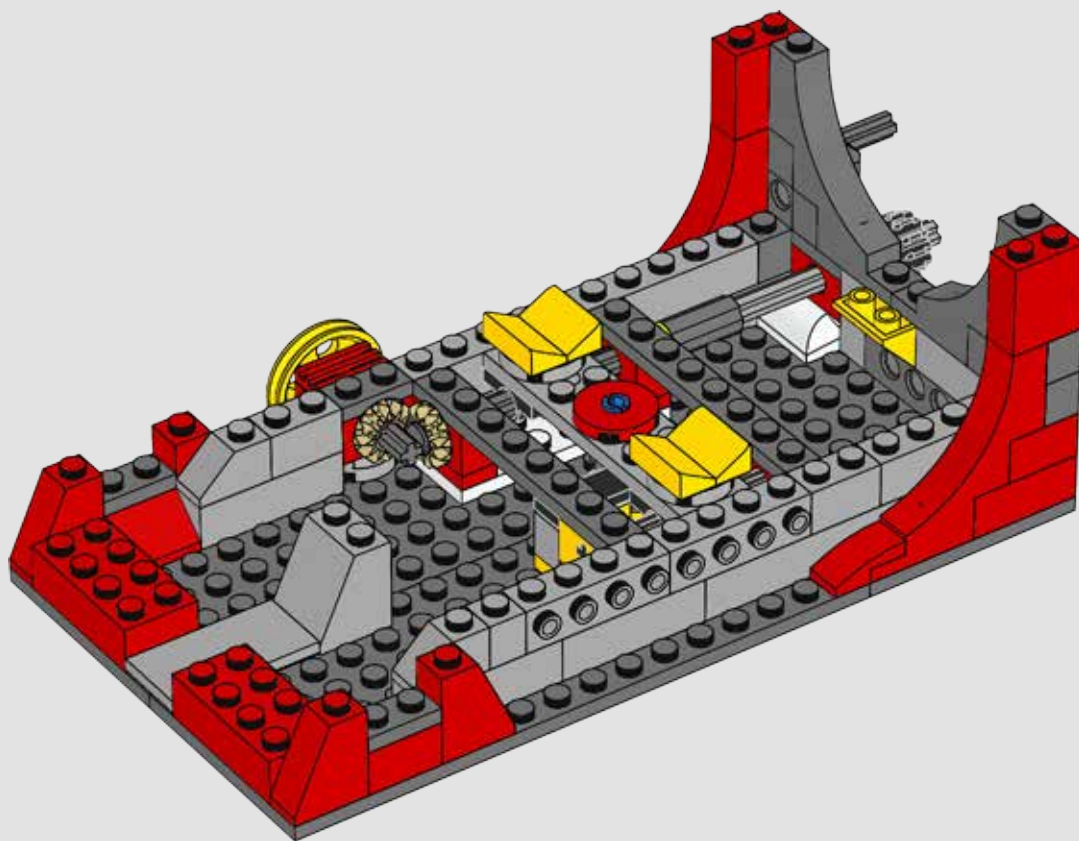

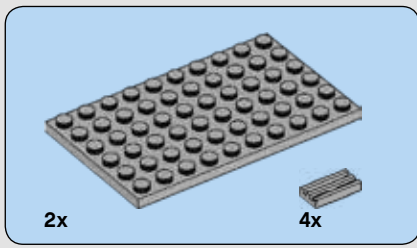

30

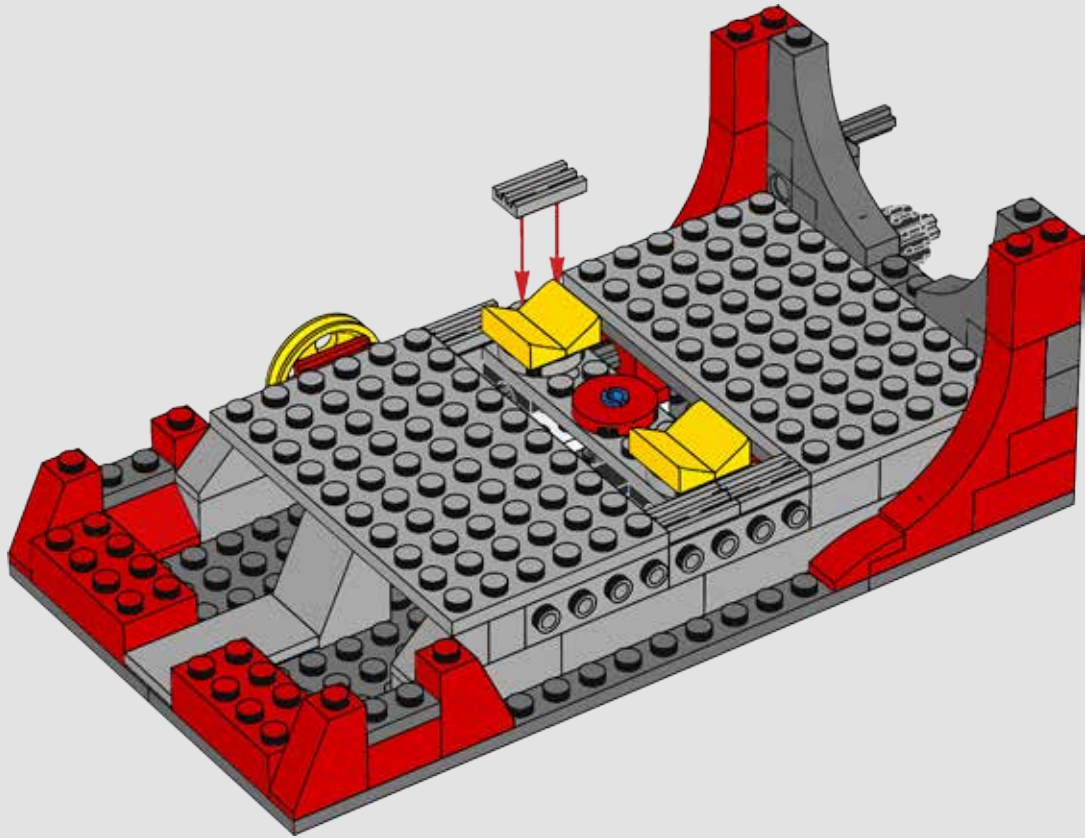



2x

31

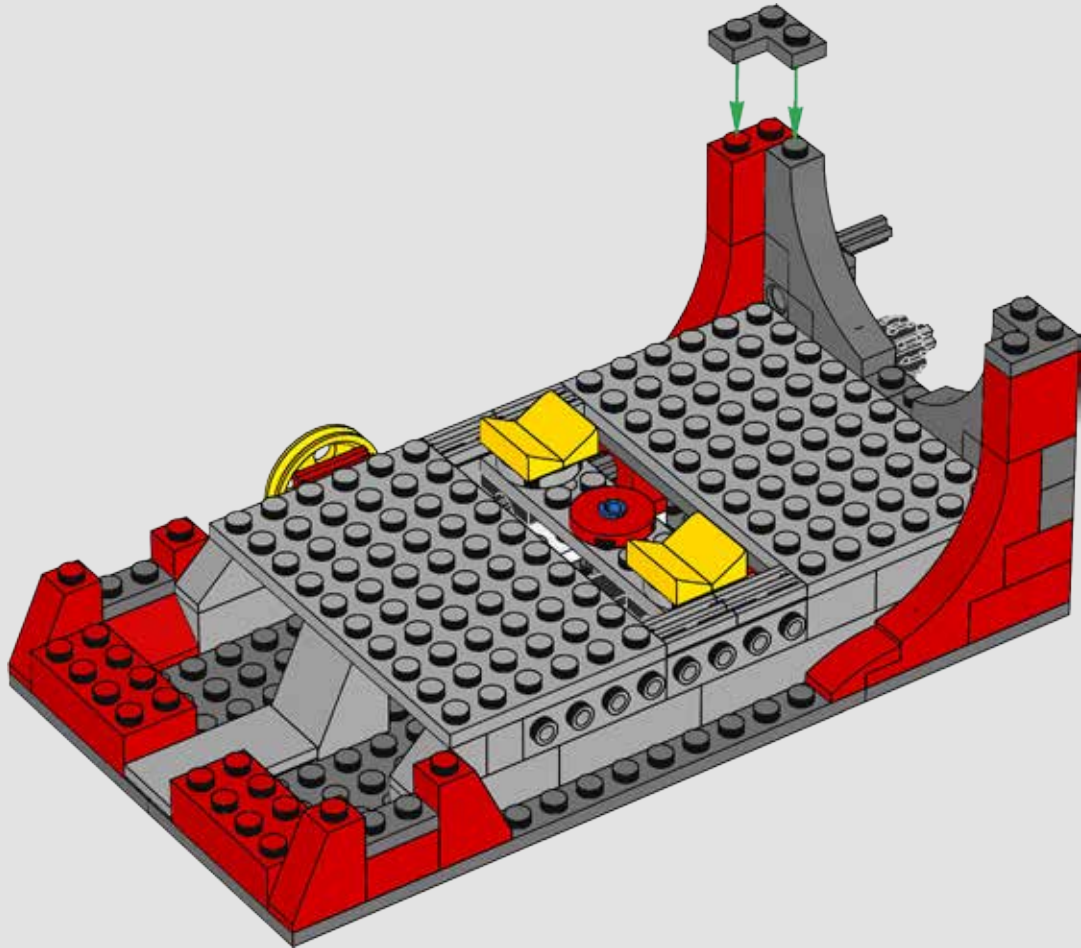

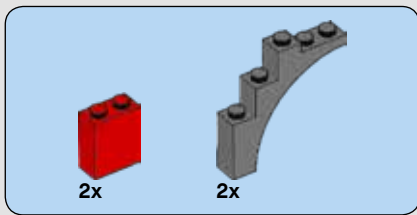

32

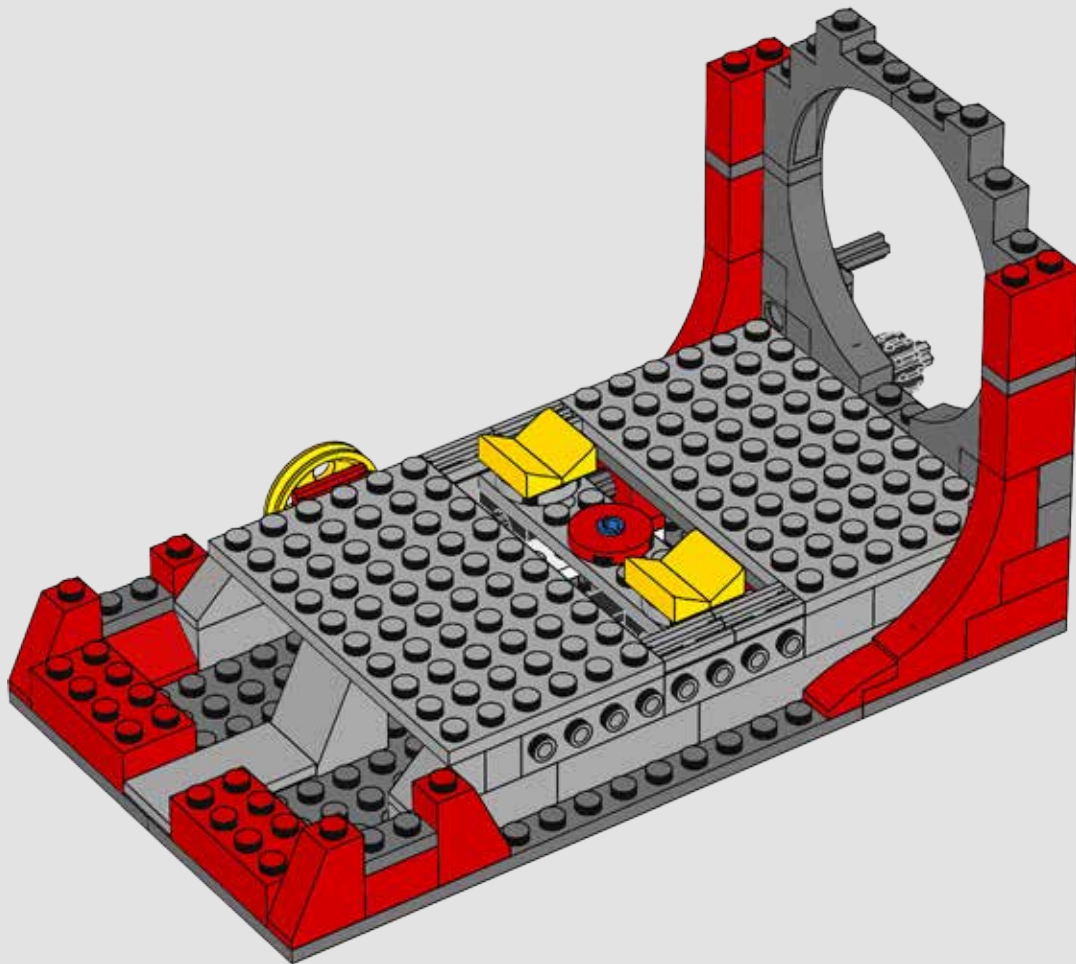

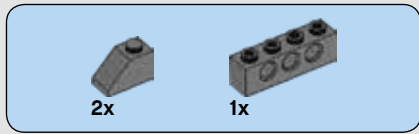

33

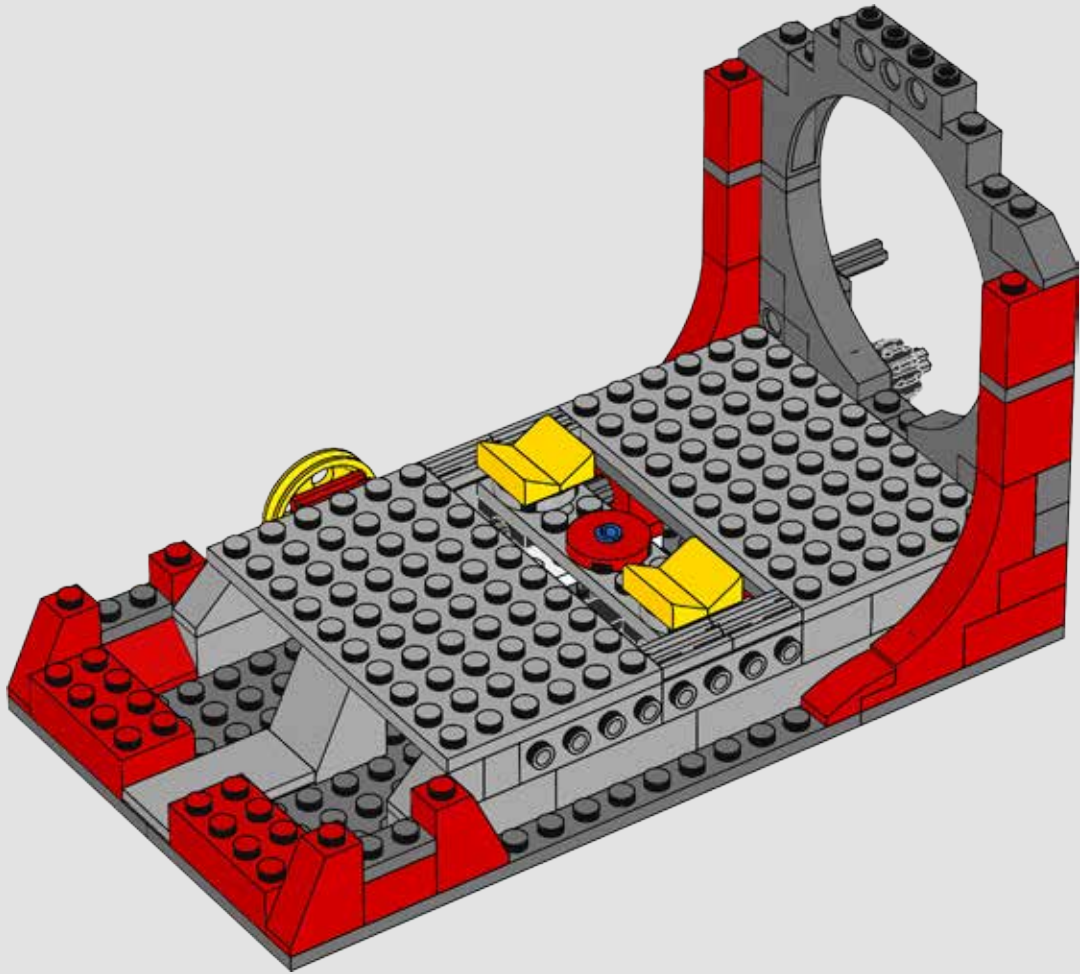



2x

34

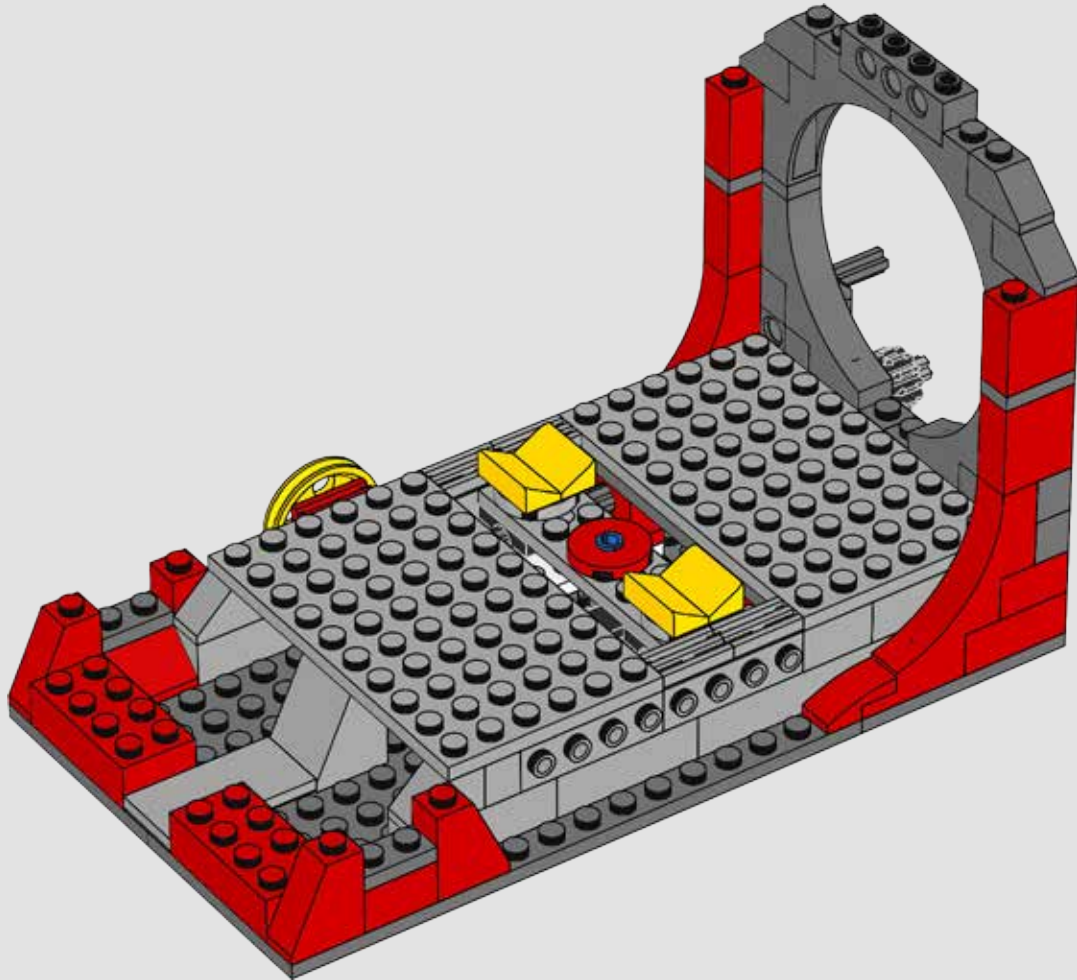



35

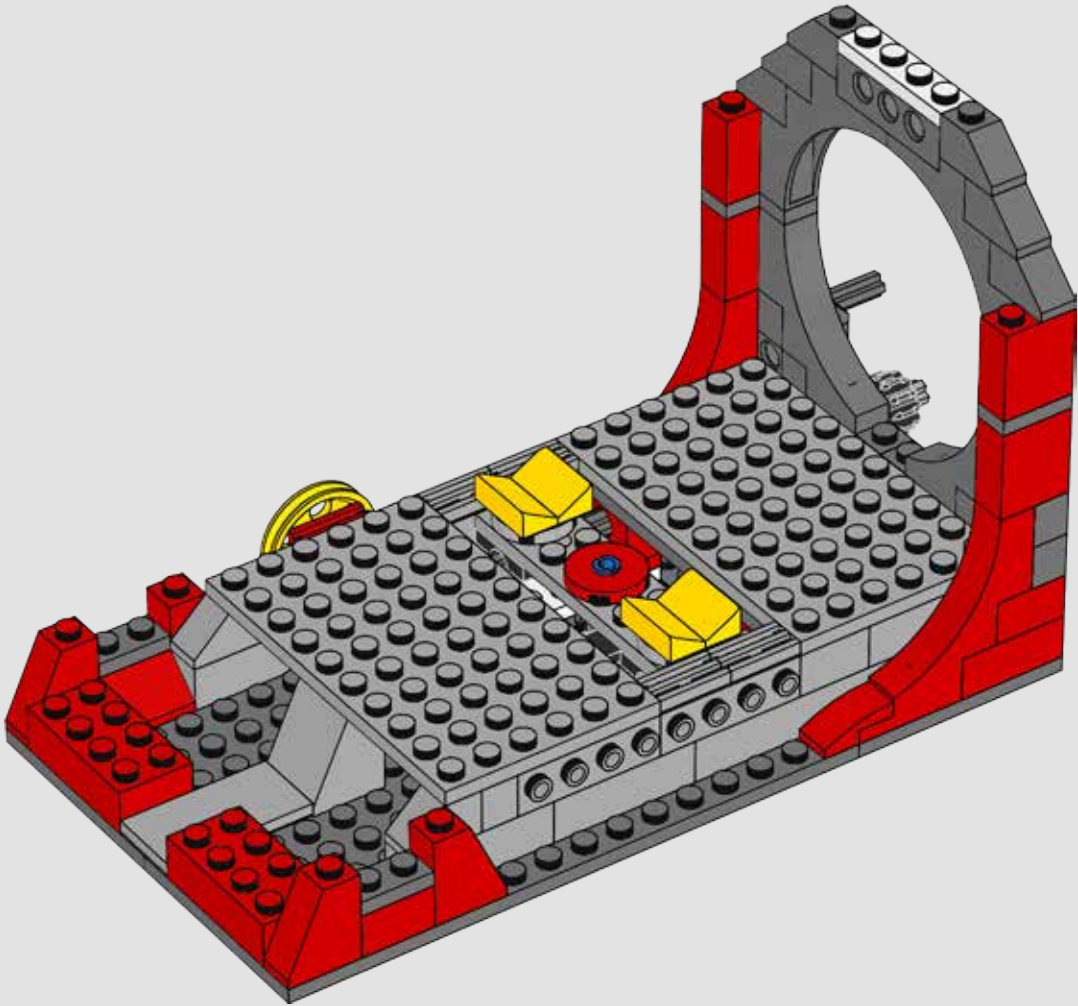



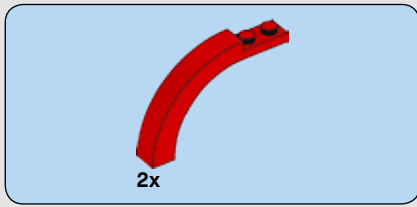

36

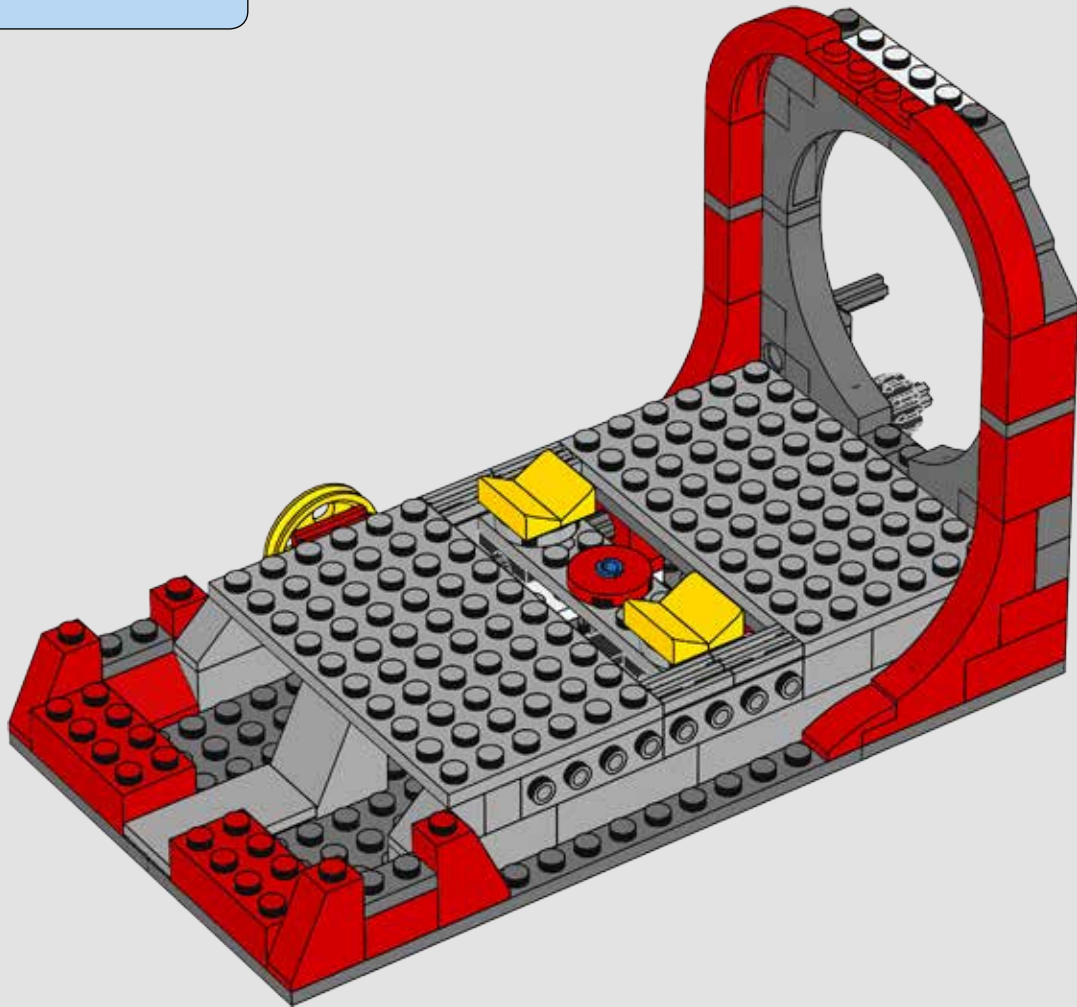

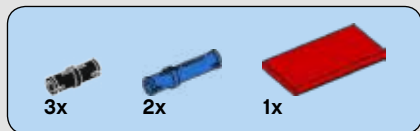

37

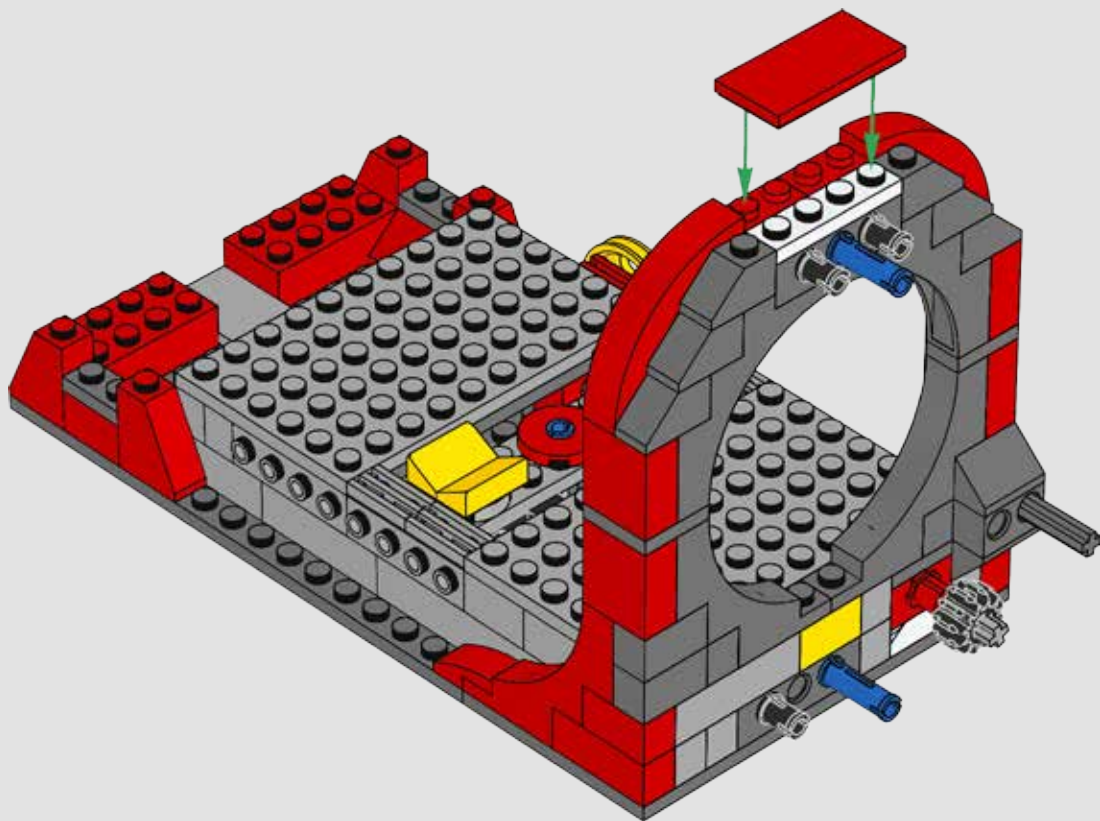

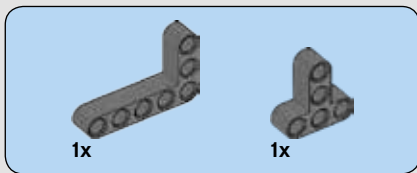

38

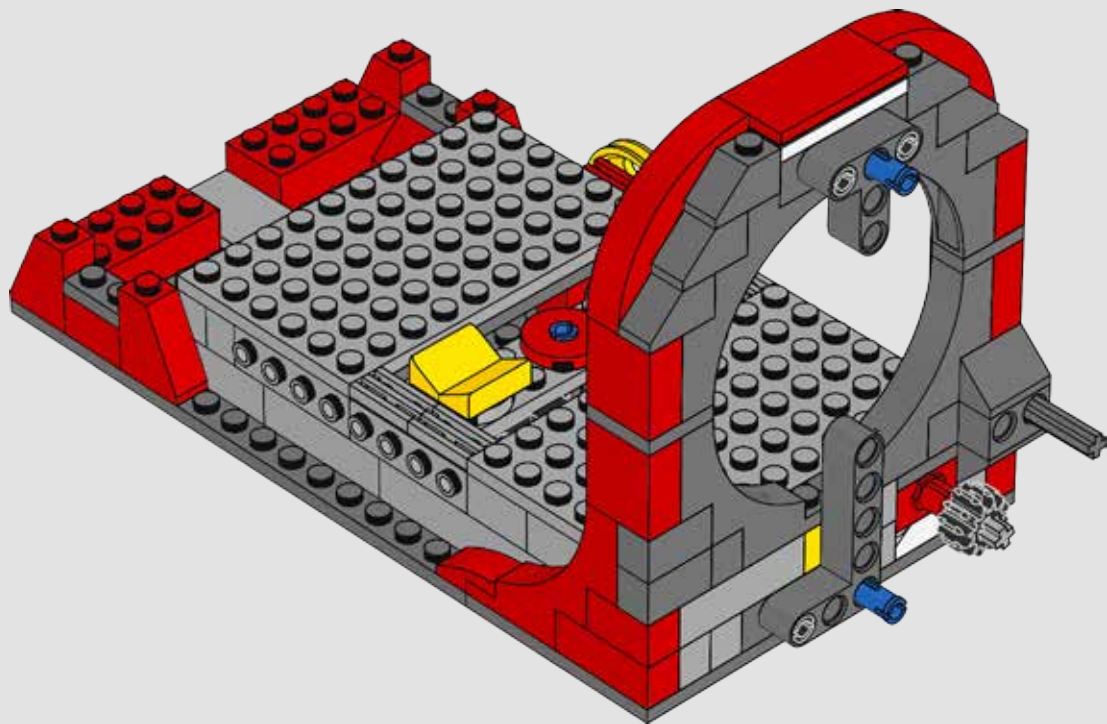

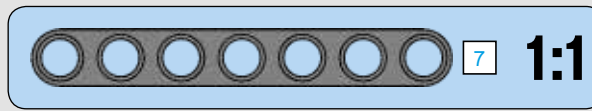
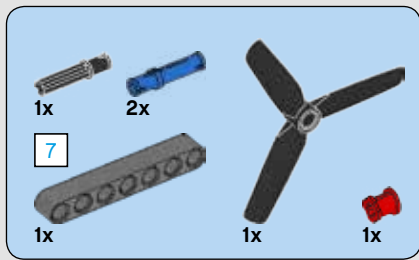

39

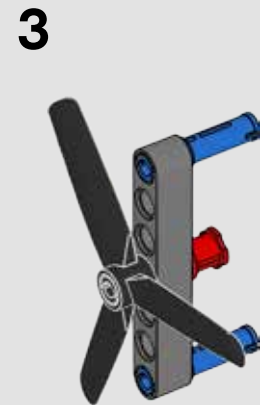
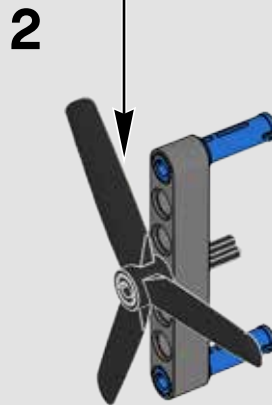
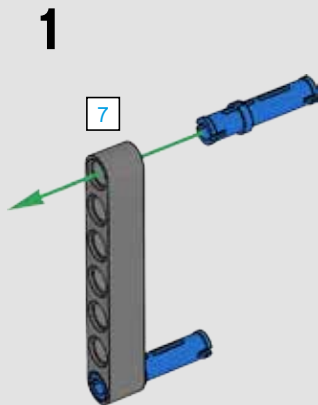
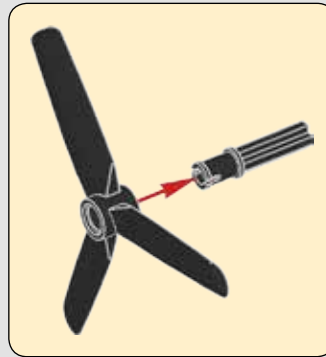

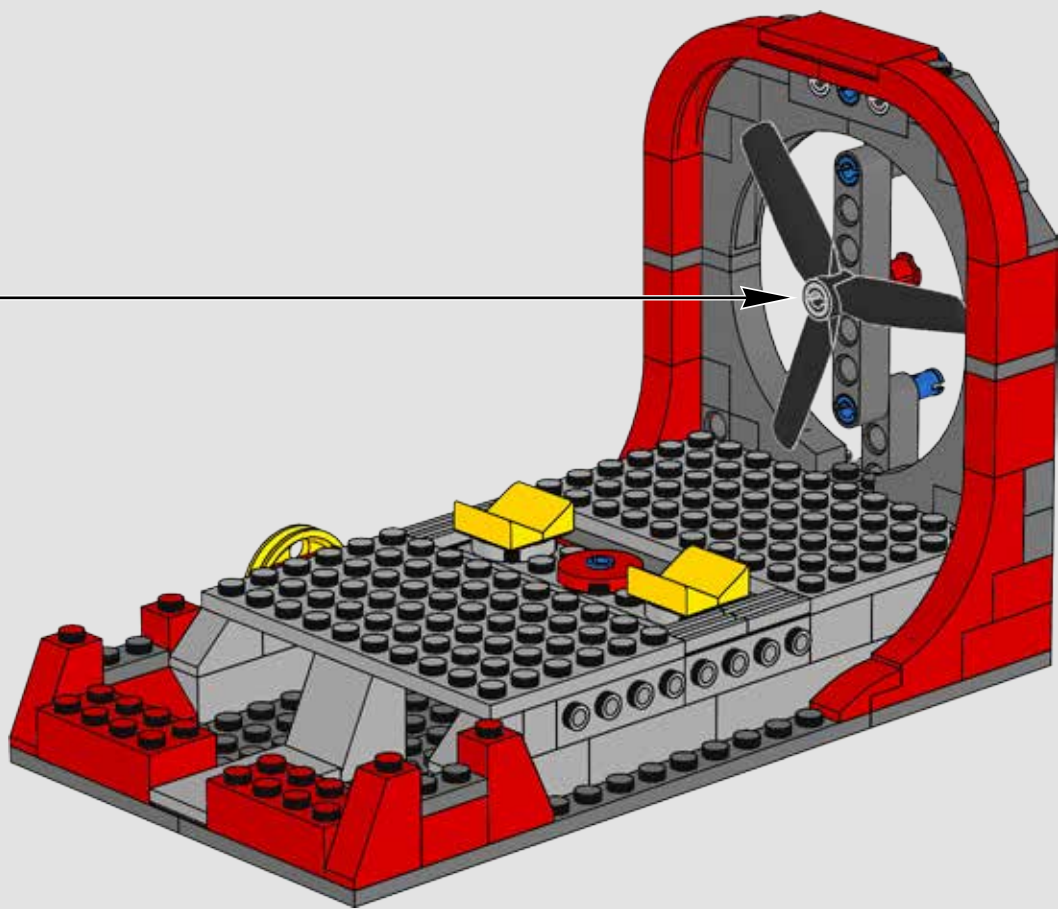



1x

40

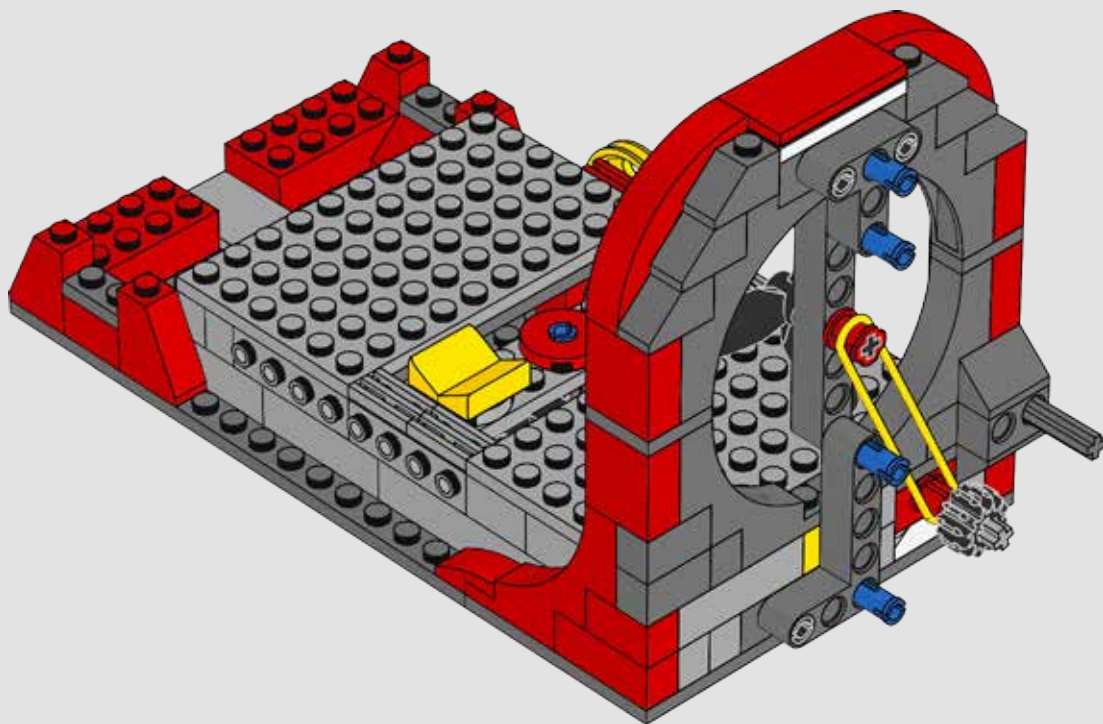

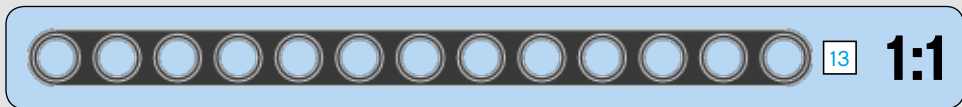
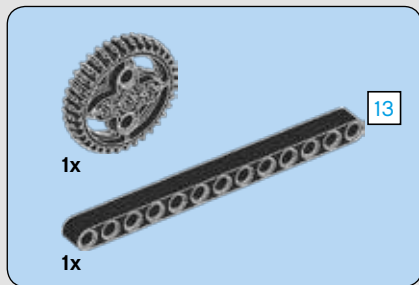

41

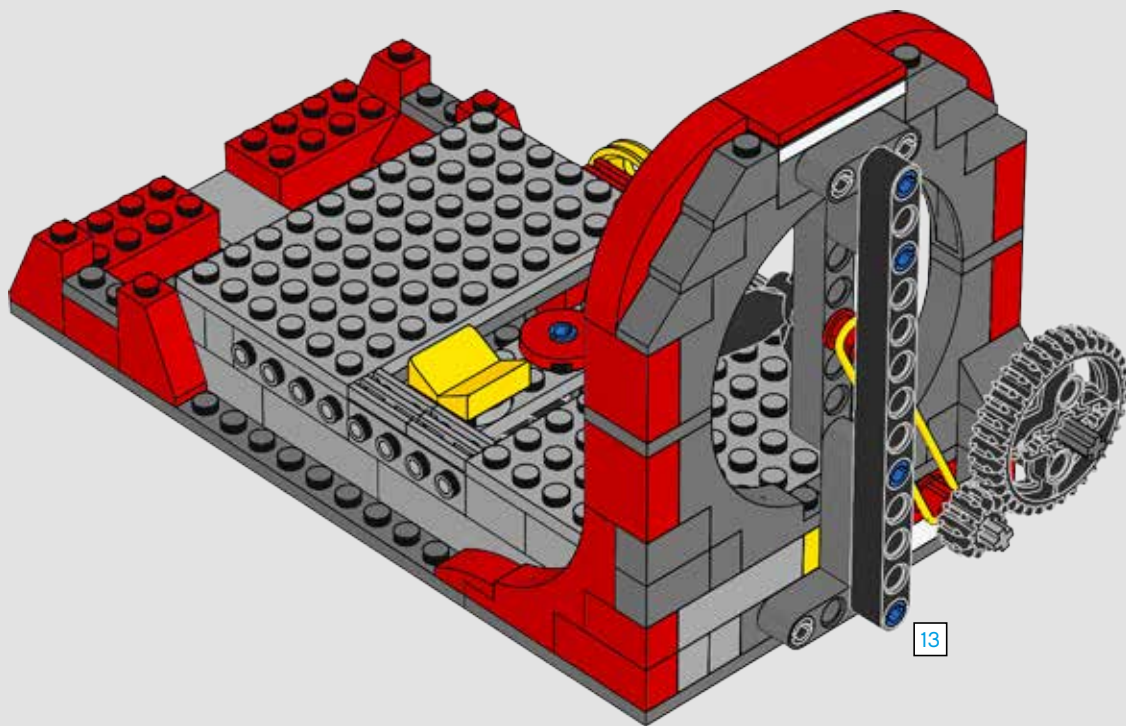

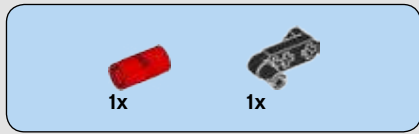

42

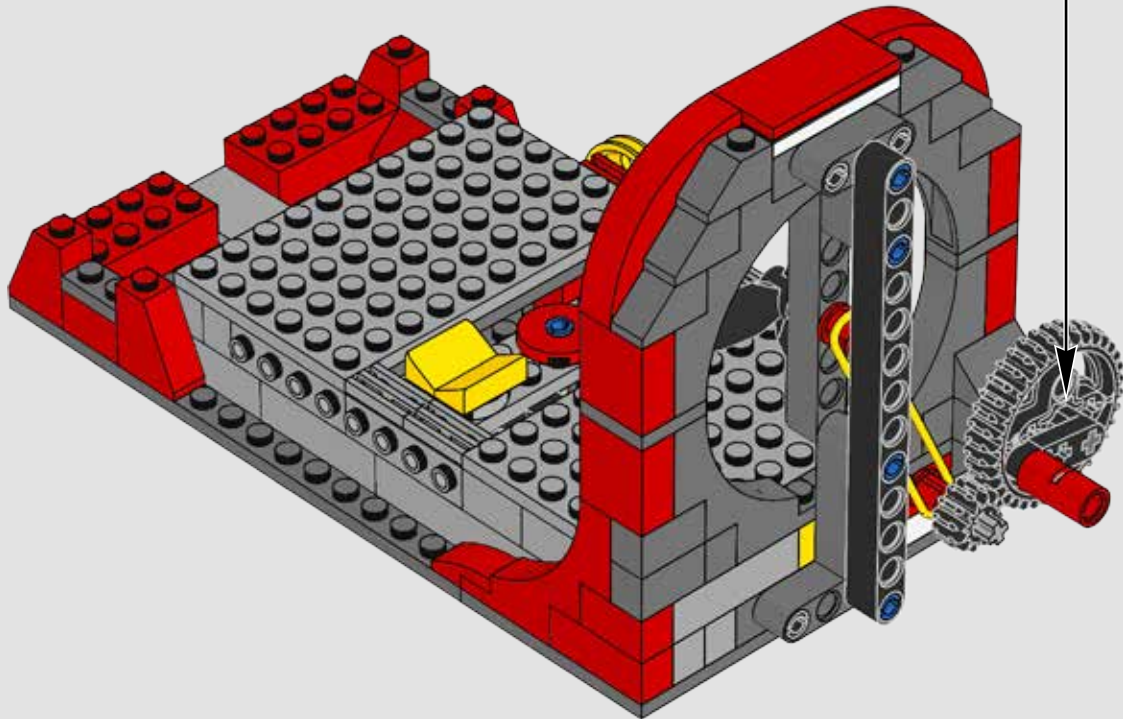
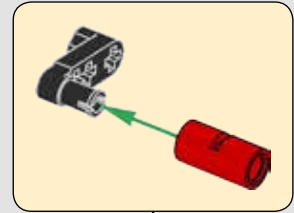



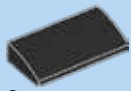

2x

# 43

1



2



1



2

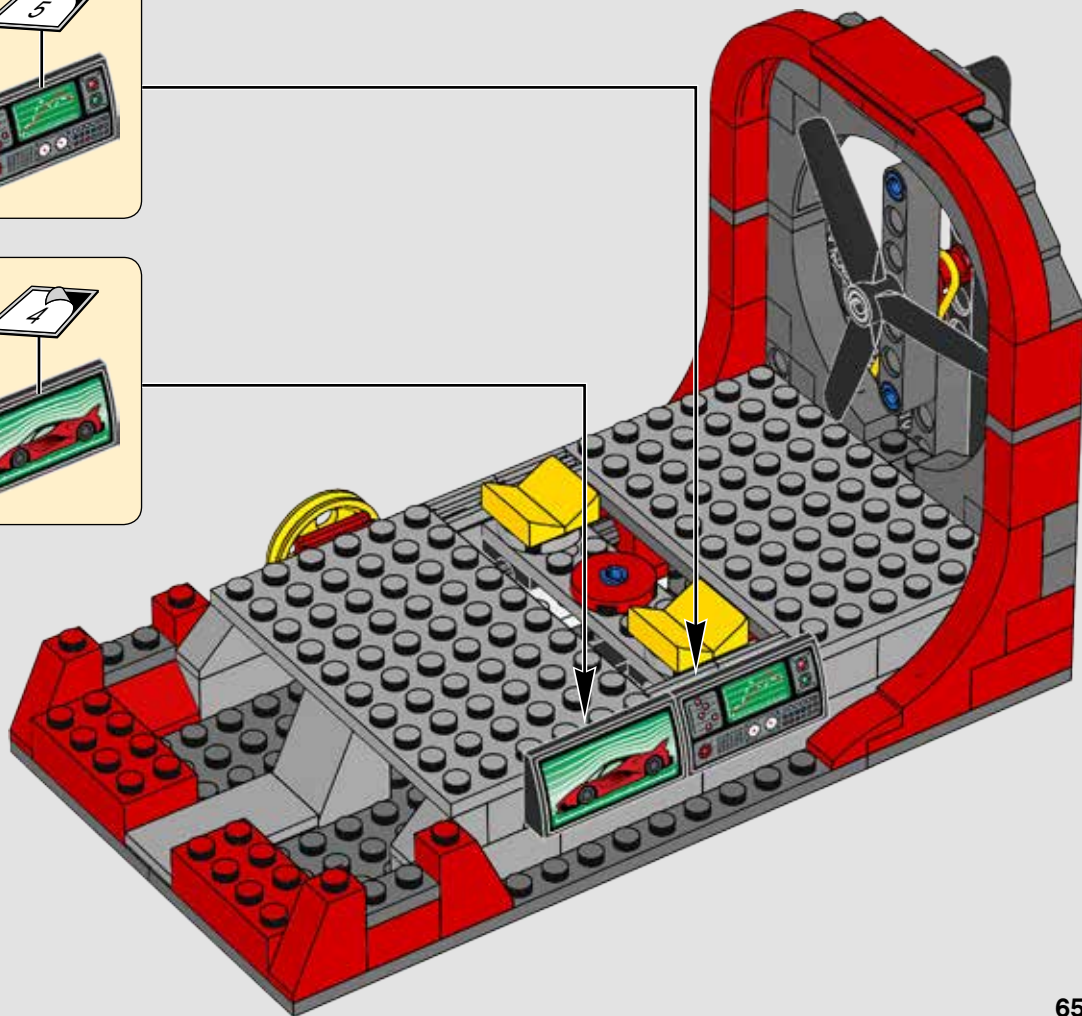

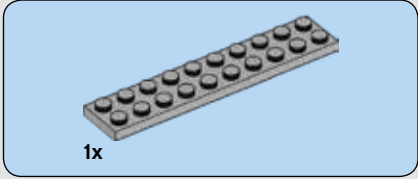
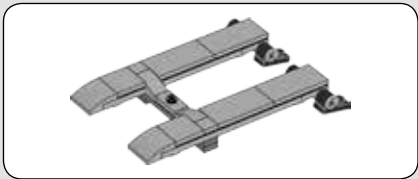

44

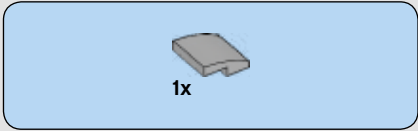
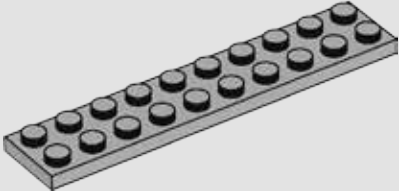

45

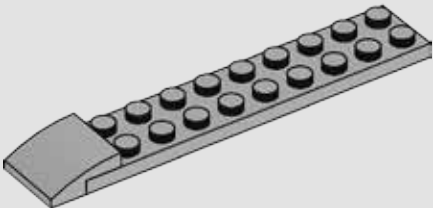

46

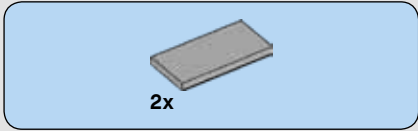
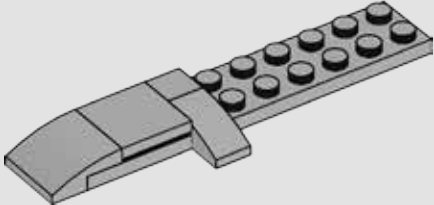

47

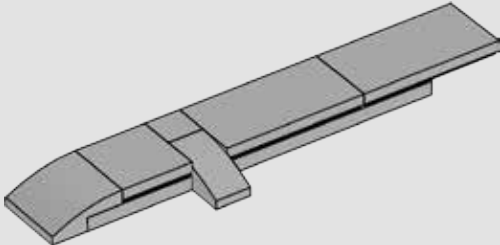

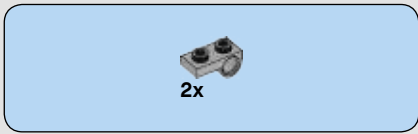

48

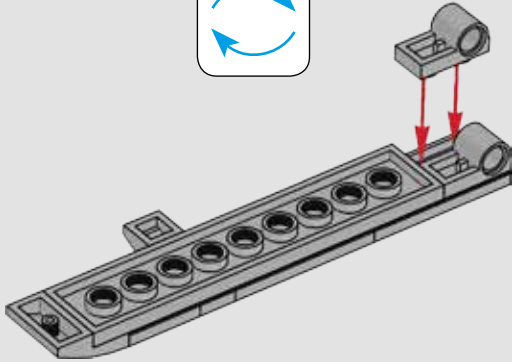

49

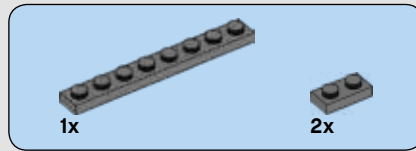
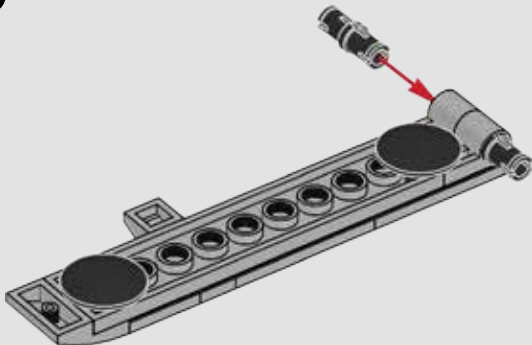

50

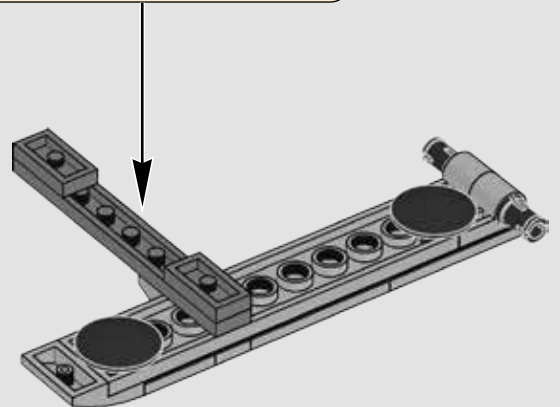
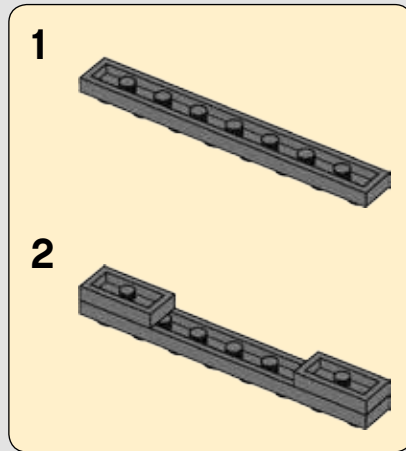

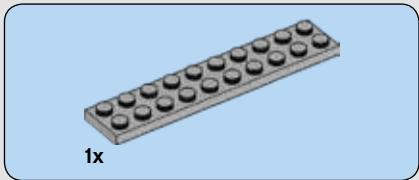

**51**

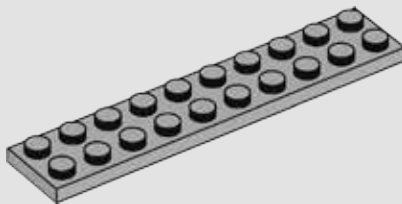

**52**

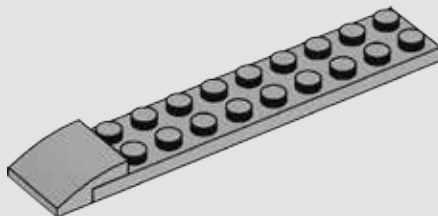

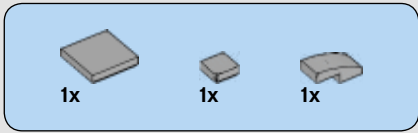

53

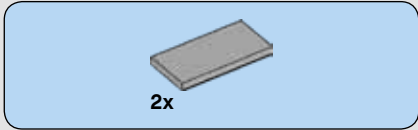
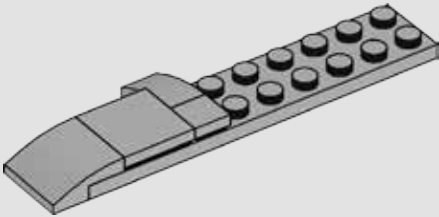

54

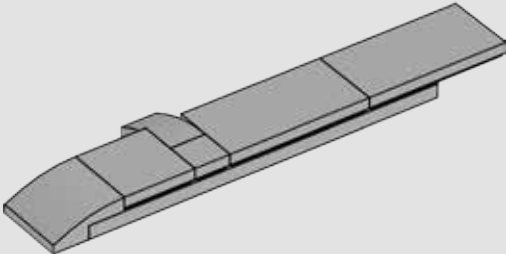

55

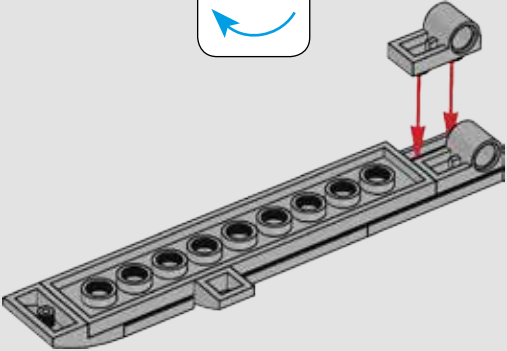

56

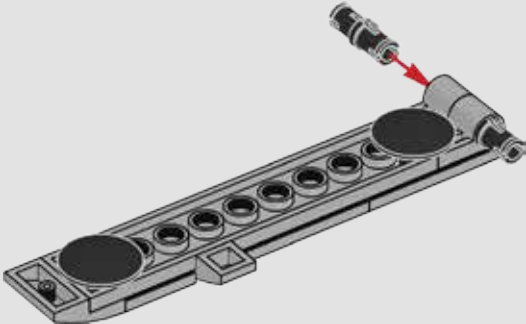

57

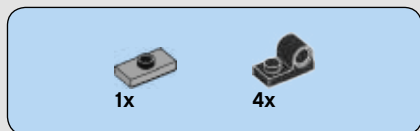
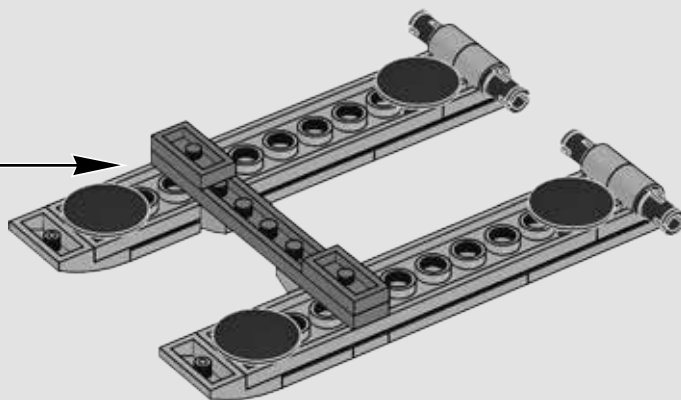

58

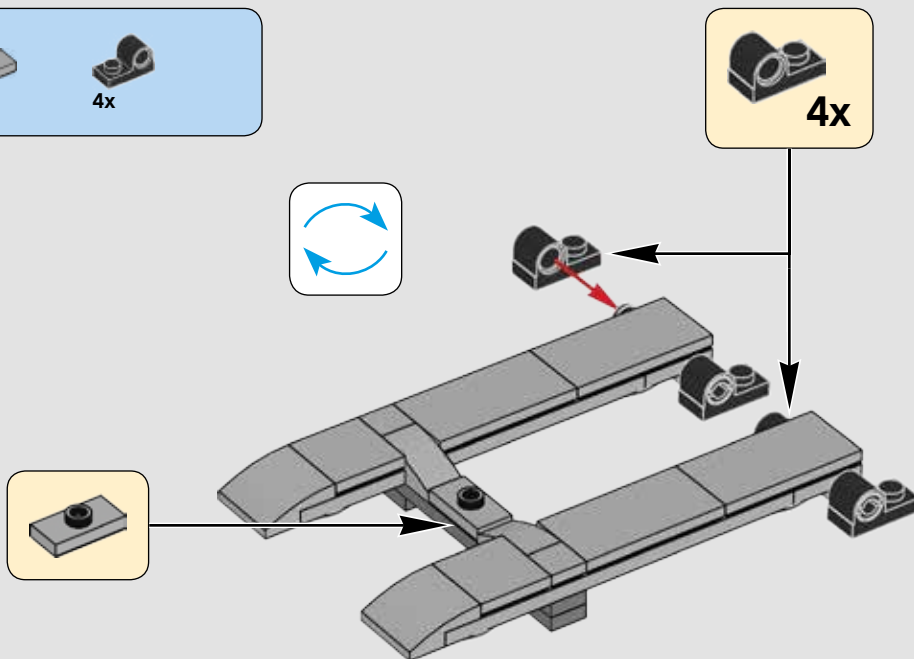

59

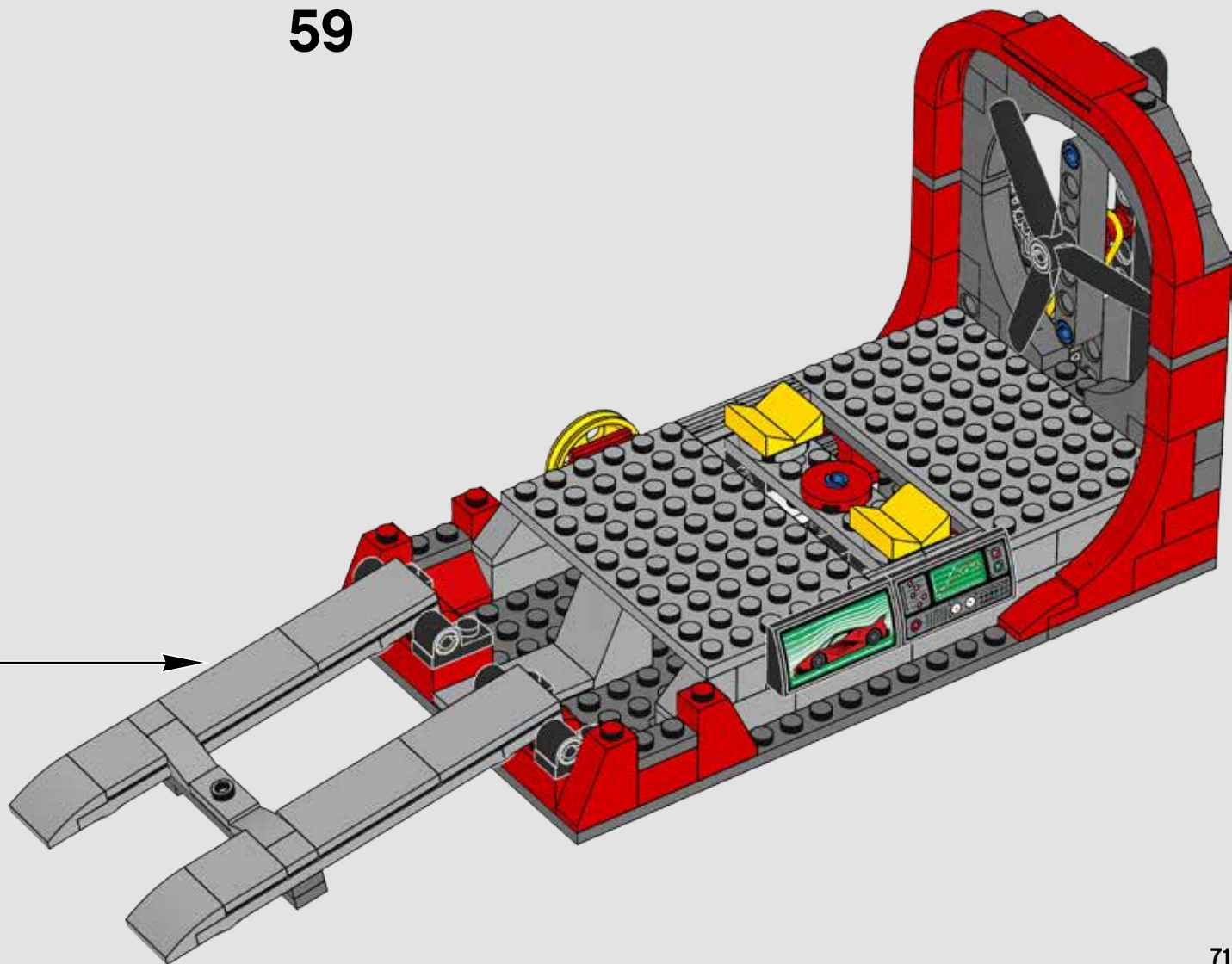

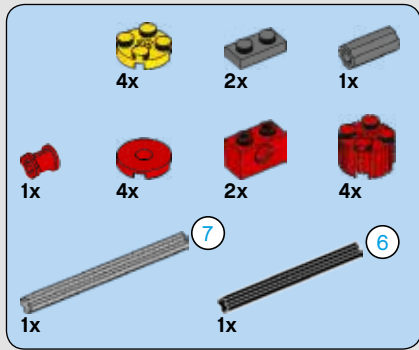

60

1

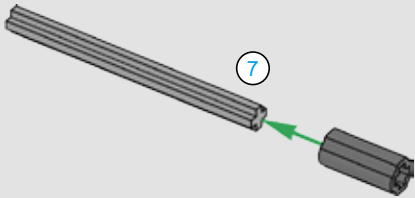

2

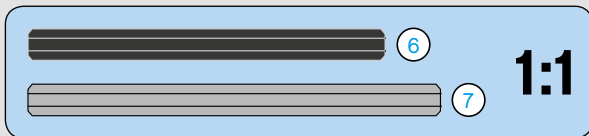
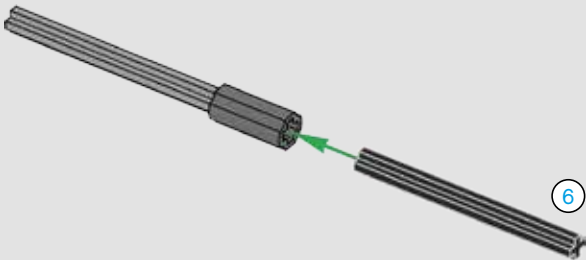

72

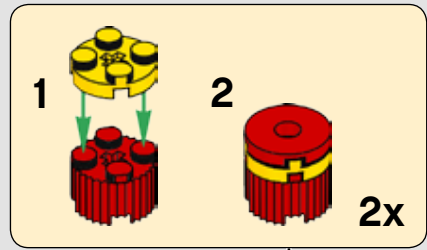

3

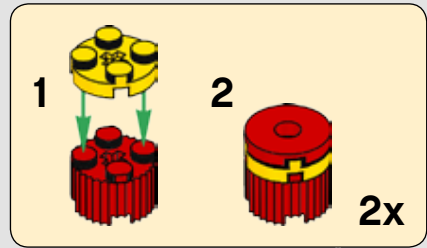
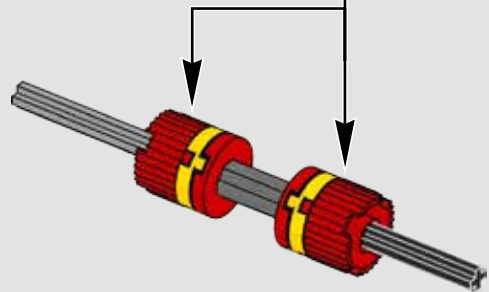

4

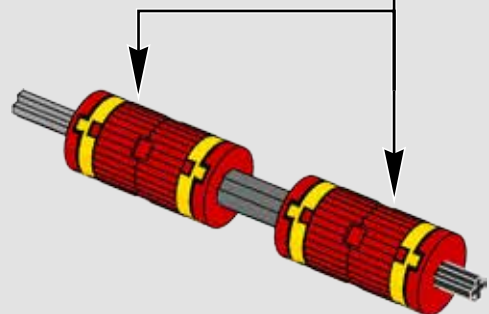



5

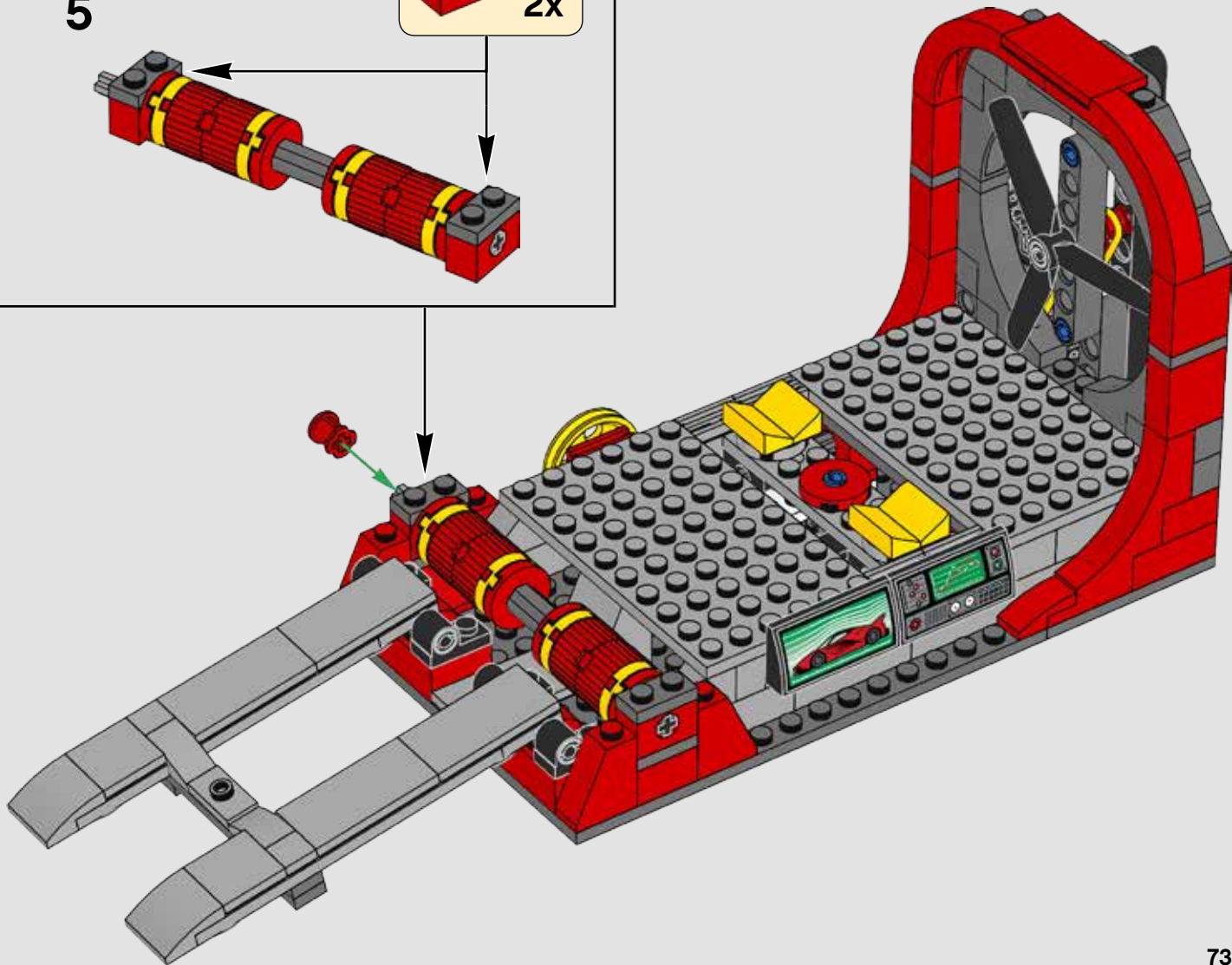
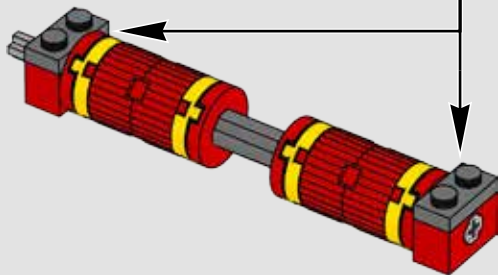
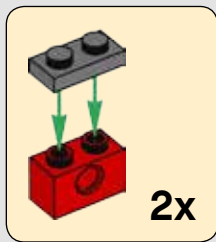

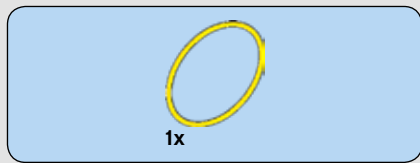

61

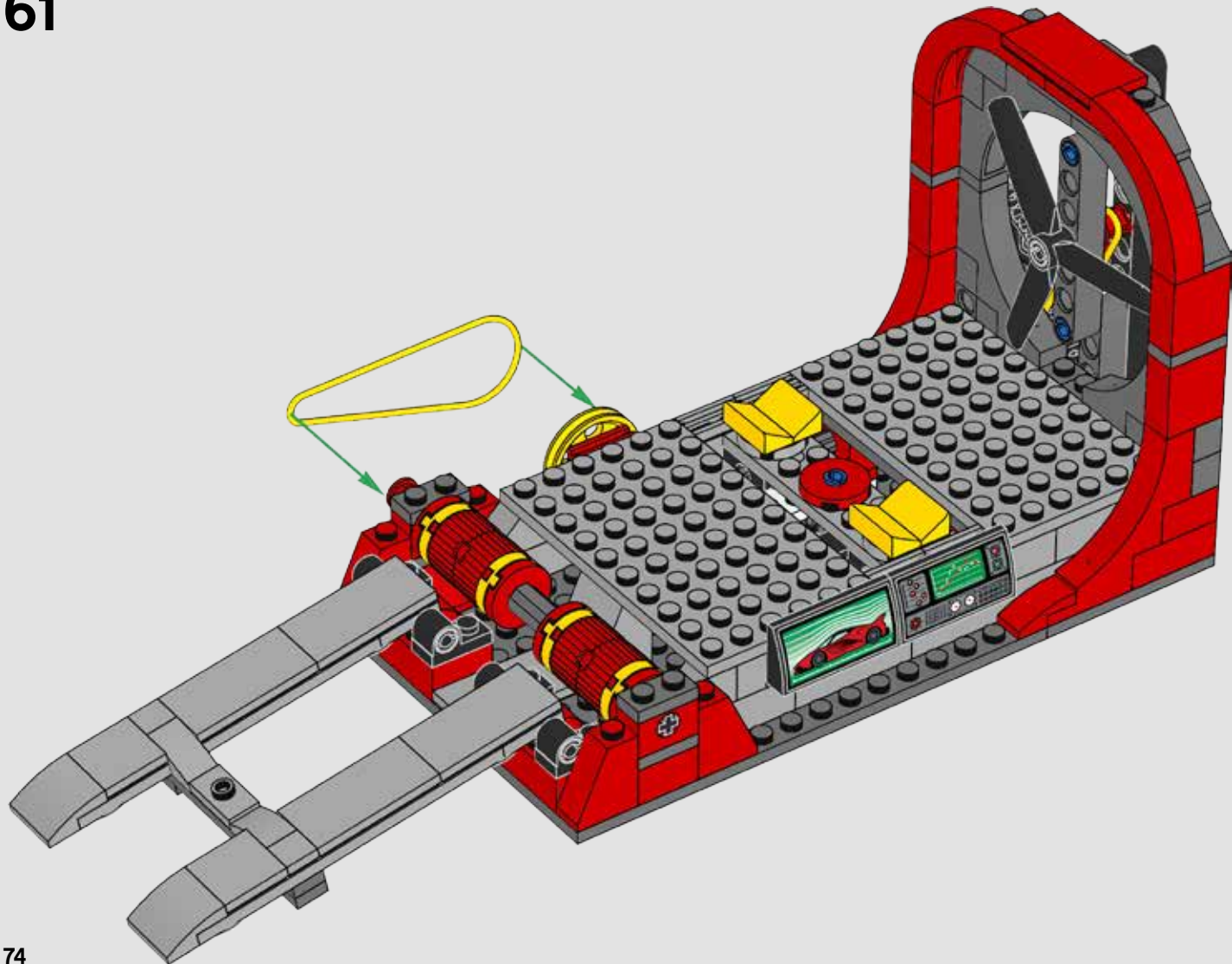



4x

62

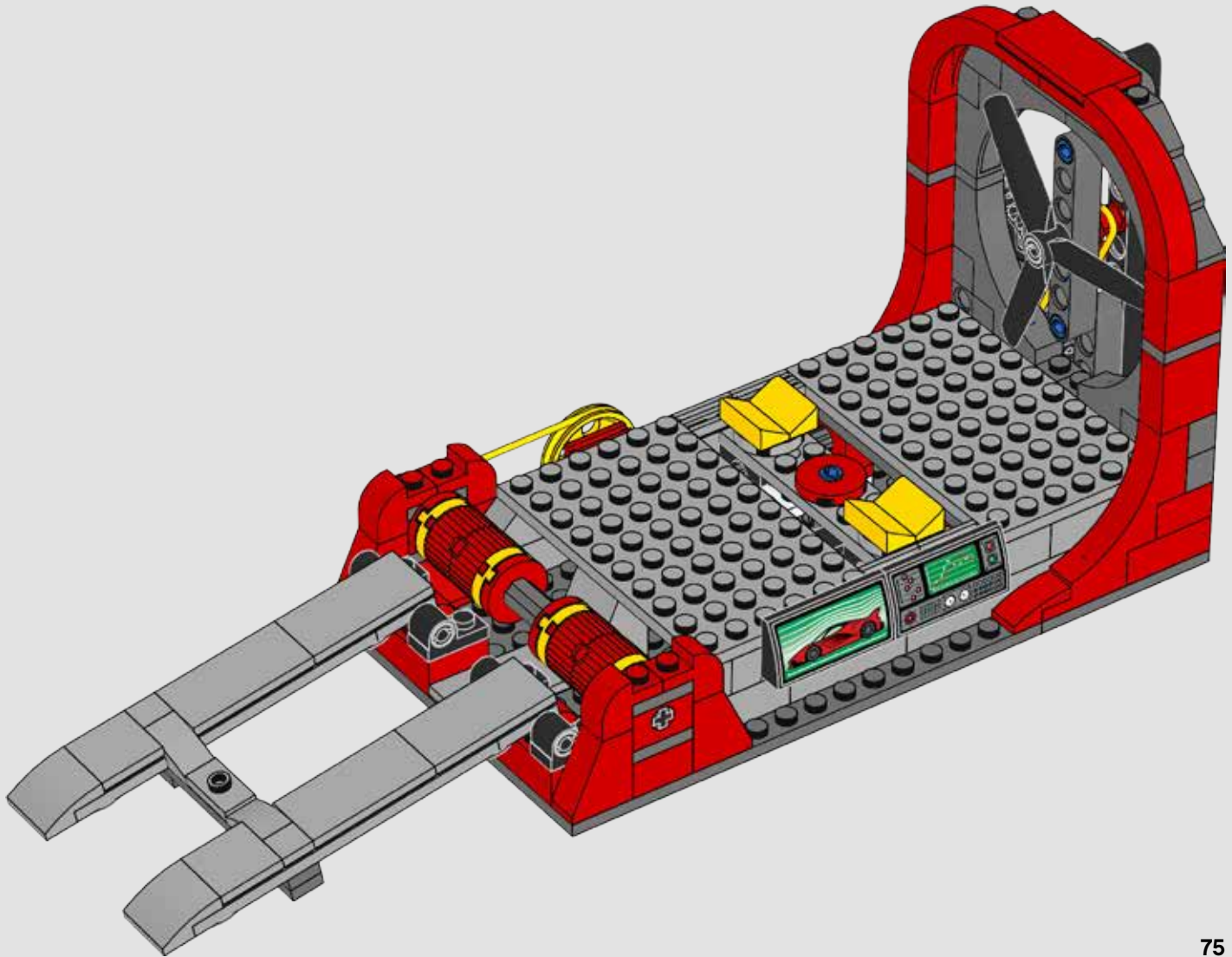



2x

63

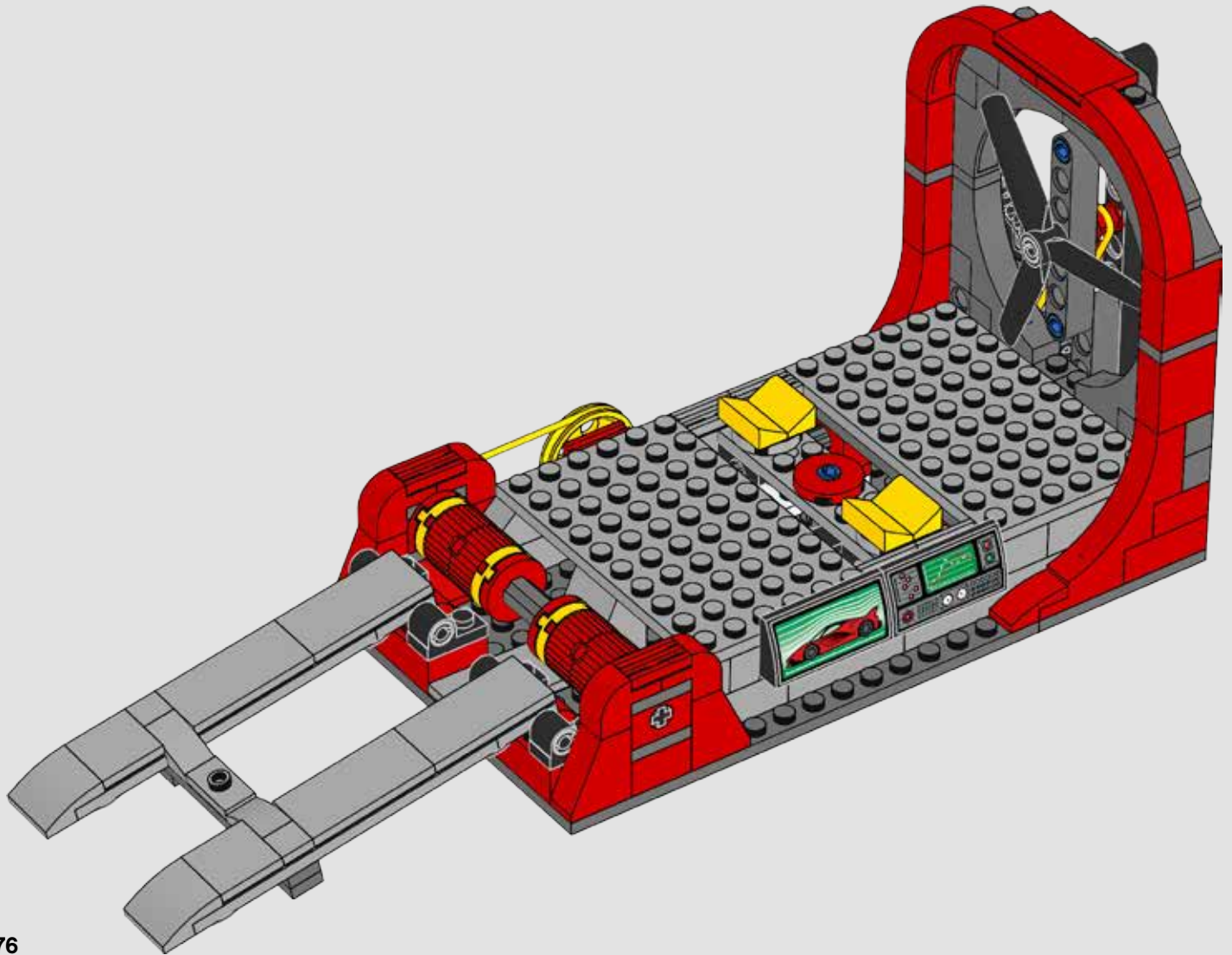



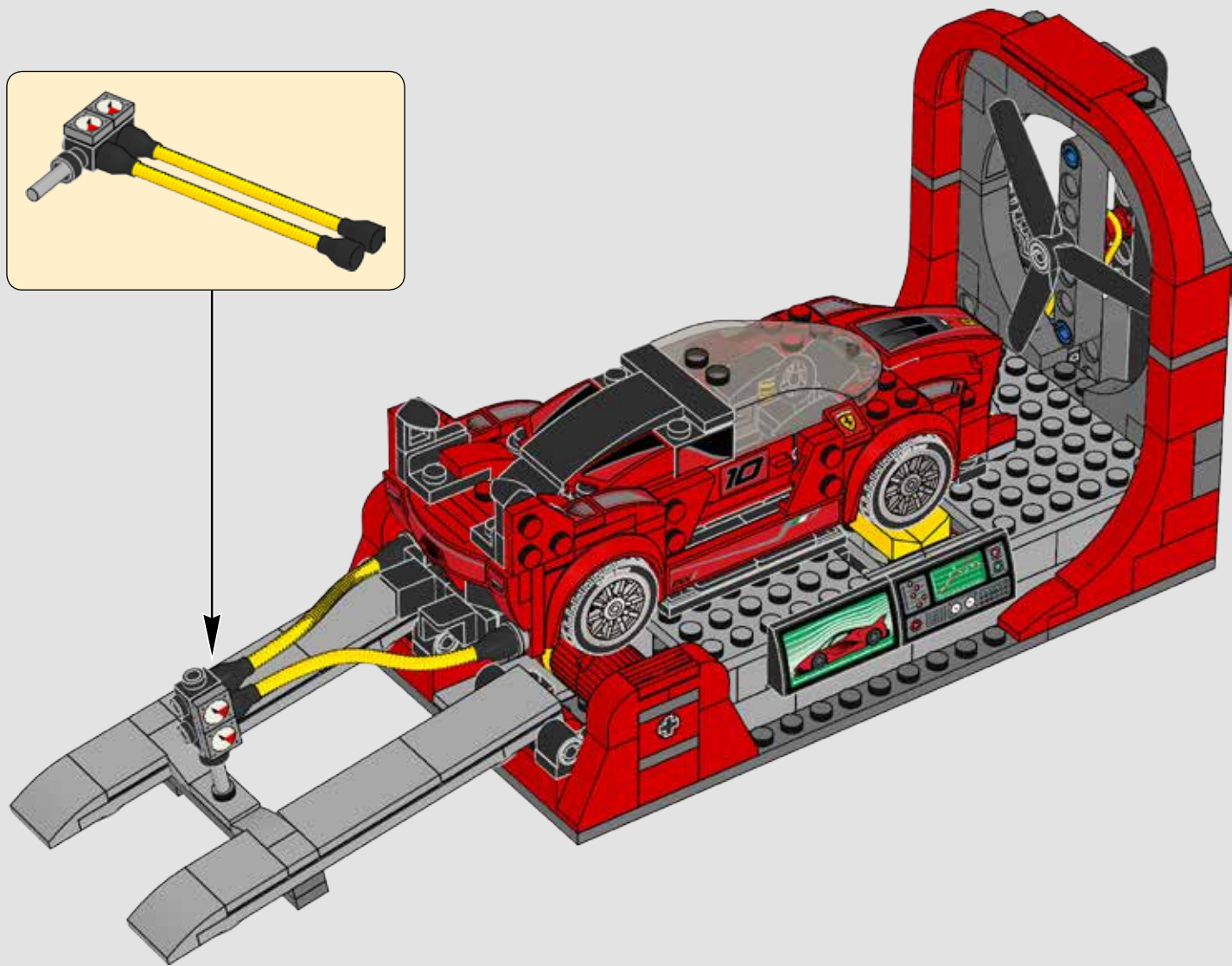
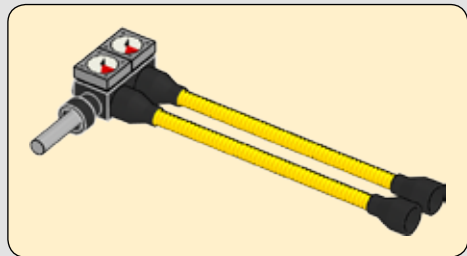

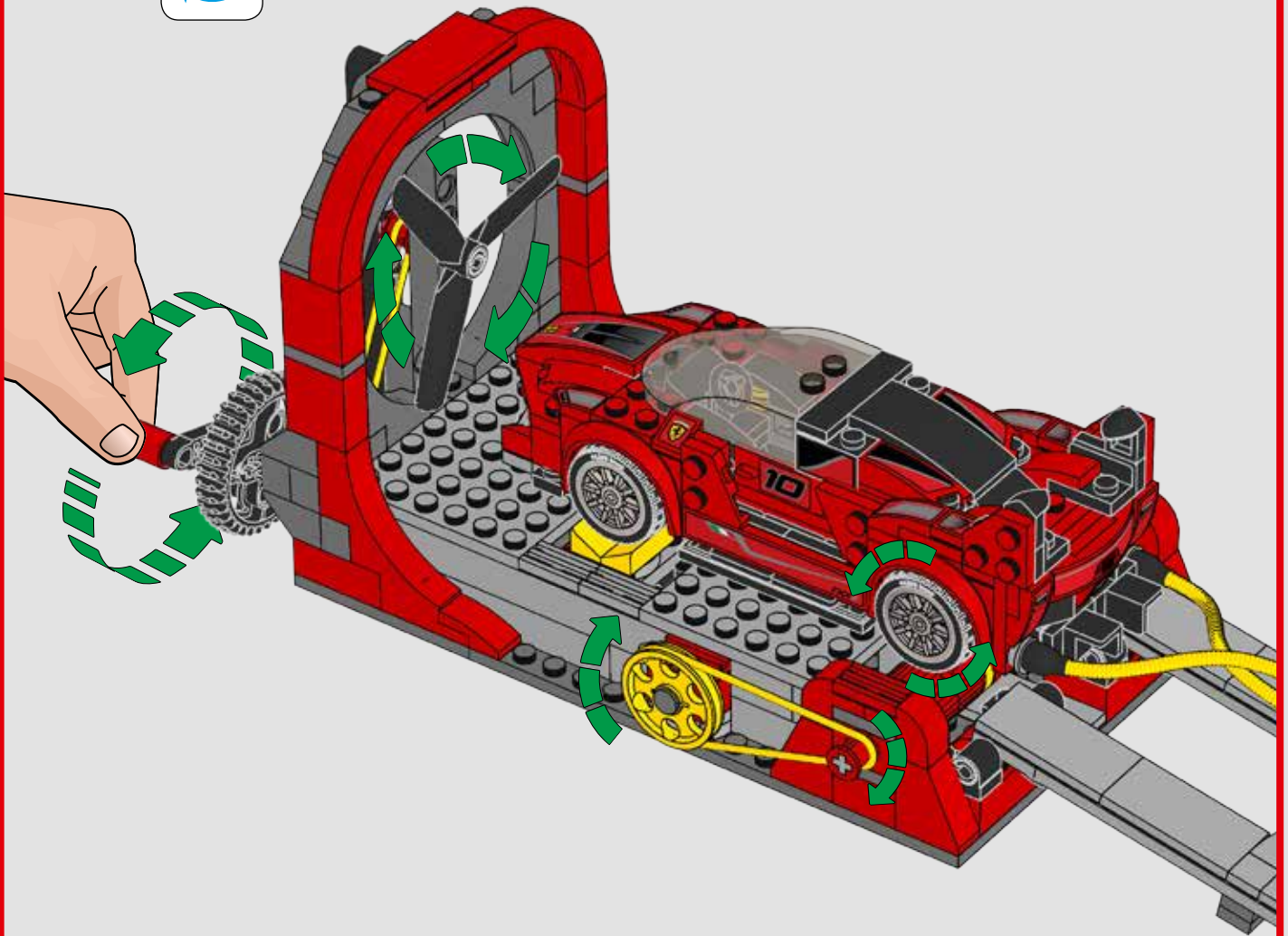



# SPEED

CHAMPIONS



WATCH COOL VIDEOS AT [LEGO.COM/SPEEDCHAMPIONS](http://LEGO.COM/SPEEDCHAMPIONS)  
 REGARDE DES VIDÉOS SUPER COOL SUR [LEGO.FR/SPEEDCHAMPIONS](http://LEGO.FR/SPEEDCHAMPIONS)  
 DESCUBRE FANTÁSTICOS VIDEOS EN: [LEGO.COM/SPEEDCHAMPIONS](http://LEGO.COM/SPEEDCHAMPIONS)



The Bugatti logo and Bugatti wordmark are trademarks of Bugatti International S.A. and are used under license.

Produced under license of Ferrari S.p.A. The name FERRARI, the PRANCING HORSE device, all associated logos and distinctive designs are property of Ferrari S.p.A.

The body designs of the Ferrari cars are protected as Ferrari S.p.A. property under design, trademark and trade dress regulations.

Produit sous licence FERRARI S.p.A. La dénomination FERRARI, l'emblème du CHEVAL CABRÉ, ainsi que l'ensemble des logos et signes distinctifs associés sont la propriété intellectuelle de la société FERRARI S.p.A., de même que le design de la carrosserie des voitures FERRARI est protégé en vertu des réglementations applicables aux dessins et modèles, aux marques et aux habillages de marque.

Fabricado bajo licencia de Ferrari S.p.A. La denominación FERRARI, el símbolo del CABALLO RAMPANTE, todos los logotipos asociados y los diseños distintivos son propiedad de Ferrari S.p.A. Los diseños de la carrocería de los coches Ferrari están protegidos como propiedad de Ferrari S.p.A. con arreglo a normas de diseño, modelo, marca registrada e imagen comercial.

Ford Motor Company Trademarks and Trade Dress used under license to the LEGO Group.

Ford marques et robe commerce utilisées sous licence pour Lego.

Ford Marques e imagen comercial utilizan bajo licencia de Lego.

"Mercedes-Benz" and the design of the enclosed product are subject to intellectual property protection owned by Daimler AG. They are used by The LEGO Group under license.

Manufactured under licence from Mercedes-Benz Grand Prix Limited. All logos featured on the livery and tyres are used with the permission of their respective owners all of whom reserve their respective rights in the same.

LEGO and the LEGO logo are trademarks of the/son des marques de commerce du/son marcas registradas de LEGO Group. ©2017 The LEGO Group.





# SPEED CHAMPIONS



75881



75877



75882



75879











75878



75883



4x 4650646	1x 4537986	1x 4613174	1x 6177500	16x 614124		1x 403226	12x 614126		1x 4251378
1x 614321	2x 6089698	4x 6102586	5x 4504379	1x 4239601	2x 4544151	4x 4278359	2x 4504382	4x 6102596	
2x 6132541	1x 368021	2x 300121	3x 4227155	1x 6153328	1x 366624	7x 4121715	2x 281726	1x 4255563	1x 4206482
1x 300421	2x 303921	2x 300121	6x 302421	1x 6124911		2x 9339	2x 281726		4x 4514553
1x 6173126	1x 4288209	2x 6173955	1x 6177505	1x 6112620	2x 4558851	2x 9339	1x 6106280	1x 241926	1x 4527065
2x 6173961	2x 362321	2x 6016772	3x 4212410	1x 6174813		2x 300426	1x 6089119	3x 663626	1x 4527065
4x 4515371	2x 362221	2x 6016772	4x 4212410	2x 407024	1x 6092833	3x 6092585	1x 4523339		2x 6010737
5x 241221	2x 4533742	1x 241921	4x 307021	4x 4550348	4x 4666579	4x 6114987	1x 4285883	1x 6055123	2x 6010737
4x 609121	2x 6183732	2x 6185958	2x 300521	4x 403224	4x 4666579	6x 6047276	1x 4285883		1x 3005741
4x 4143832	3x 302121	1x 366621	2x 6141552	1x 4233484	2x 4106347	8x 302326	1x 243126	2x 370626	2x 379526
8x 370021	1x 4157223	2x 4113858	2x 6141553	1x 4494224	2x 6173959	1x 73081	1x 4205760	2x 346026	2x 346026
8x 6029946	7x 371021	1x 4562544	1x 4562544	1x 366024	1x 4214559	12x 6020193	1x 371026	1x 4656764	1x 4656764
11x 302321	1x 4633914	2x 4505067	1x 6177507	1x 6076799	1x 4177431	1x 4563044	2x 4587844	1x 4656764	1x 4656764
1x 4611701	1x 4560179	2x 4505067	5x 6102138	2x 4514843	2x 4550017	1x 4225201	2x 4587844	1x 4656764	1x 4656764
					2x 4548180	1x 306826	1x 4647286	1x 4522933	

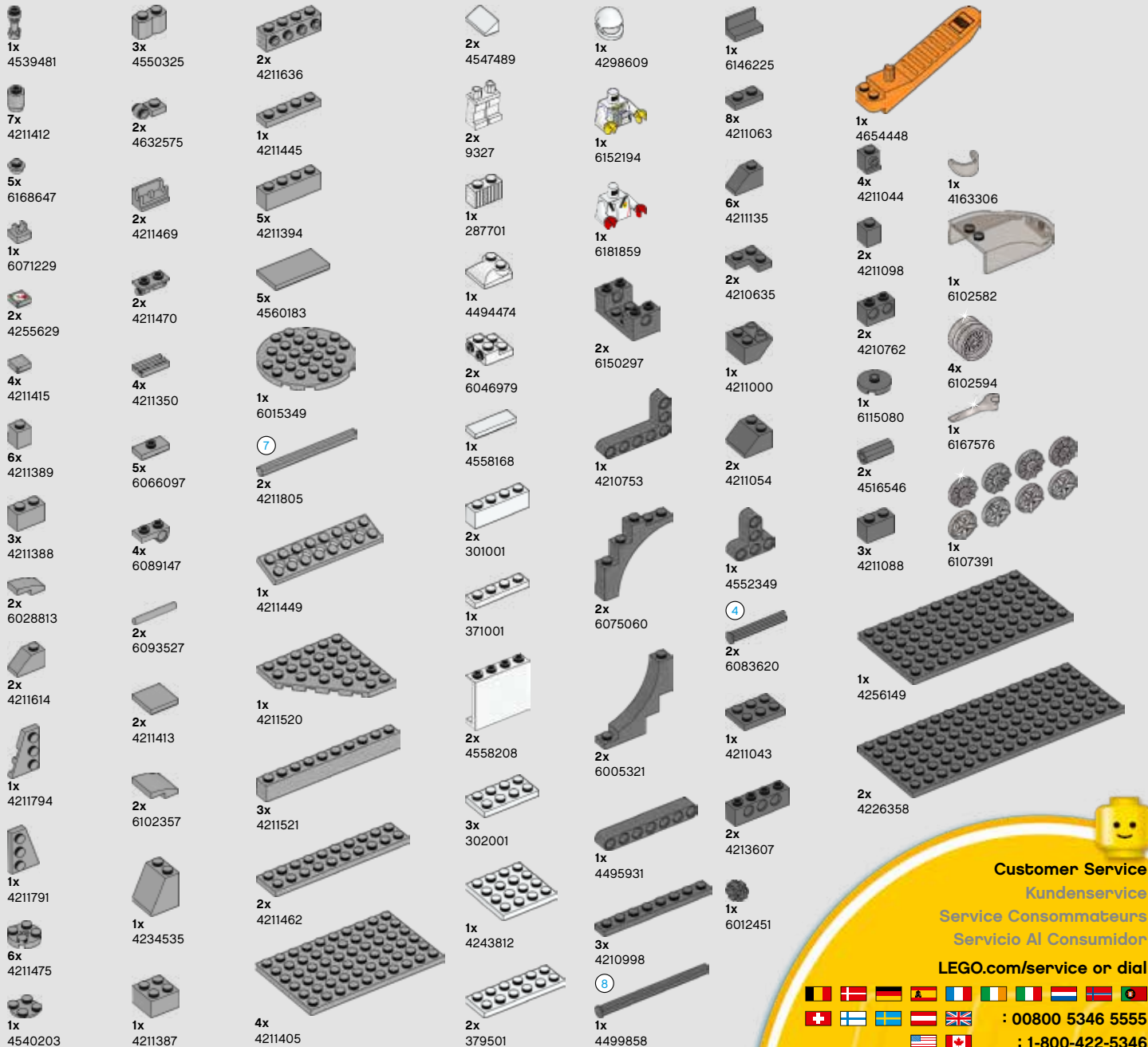

Customer Service

Kundenservice

Service Consommateurs

Servicio Al Consumidor

LEGO.com/service or dial



: 00800 5346 5555

: 1-800-422-5346



# WIN

GO TO [WWW.LEGO.COM/PRODUCTFEEDBACK](http://WWW.LEGO.COM/PRODUCTFEEDBACK) AND  
GIVE US YOUR SHORT **FEEDBACK** ABOUT THIS  
LEGO® SET FOR A CHANCE TO WIN  
A COOL LEGO PRIZE.

Terms & Conditions apply

# LEGO.com/productfeedback

## GEWINNE

Erzähle uns auf  
[www.LEGO.com/productfeedback](http://www.LEGO.com/productfeedback)

etwas über die Erfahrungen, die du mit  
diesem LEGO® Set gemacht hast, und  
sichere dir die Chance auf einen coolen  
LEGO Preis!

Es gelten die Teilnahmebedingungen

## GAGNE

Rends-toi sur  
[www.LEGO.com/productfeedback](http://www.LEGO.com/productfeedback)

et donne-nous quelques commentaires  
sur ce produit LEGO® pour avoir une  
chance de gagner un prix LEGO !

Voir Conditions Générales

## GANAN

Visita  
[www.LEGO.com/productfeedback](http://www.LEGO.com/productfeedback)

y envíanos tu opinión acerca de este set  
LEGO®. ¡Participarás en el sorteo de un  
premio LEGO!

Términos y Condiciones aplicables

## 获取奖品

登录  
[www.LEGO.com/productfeedback](http://www.LEGO.com/productfeedback)

给出关于此乐高®套装的简短反馈，  
就有机会获得炫酷乐高奖品

《条款及条件》适用