



MARVEL STUDIOS  
THE  
INFINITY  
SAGA

Booklet available in English on  
Hef in deutscher Sprache erhältlich auf  
Livret disponible en français sur  
Libretto disponibile in Italiano su  
Folletto disponibile en español en  
如需中文版手册, 请访问





## **BUILDING IS A SUPERPOWER!**

Forging with LEGO® bricks is a type of forging that you can do in your living room! If you can build it, then you are truly worthy. The hammer comes with three extra hidden treasures inside and a stand with translucent blue bricks to resemble lightning crackling underneath it. Please be warned that if you throw it, it's not likely to return to your hand (in one piece), but rebuilding might just be an even bigger superpower...

Jesper C. Nielsen  
Creative Lead

© 2022 MARVEL

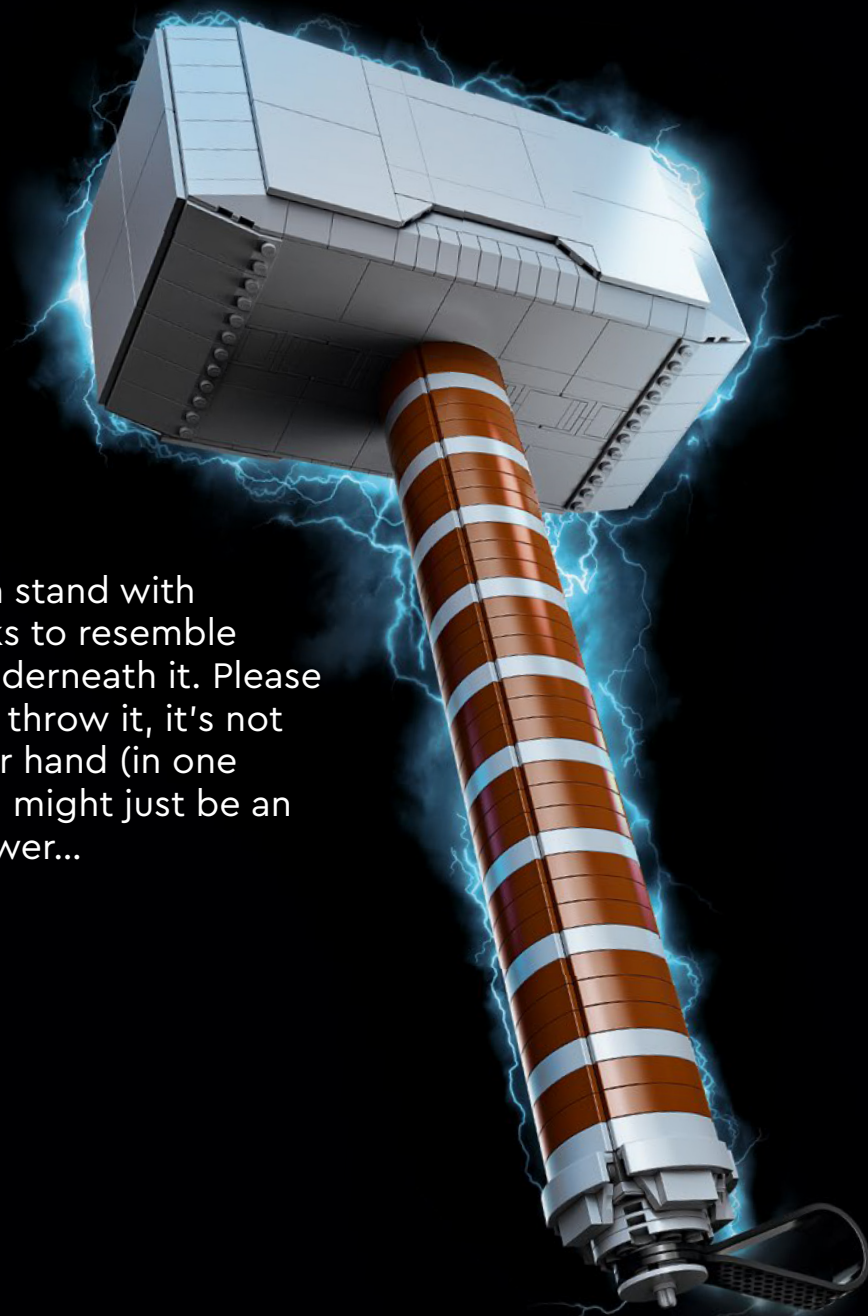

**"WHOSOEVER HOLDS THIS  
HAMMER, IF HE BE WORTHY,  
SHALL POSSESS THE POWER OF  
THOR." – ODIN**

Forged from the heart of a dying star by the Dwarves for the Asgardian Royal Family, Mjölfnir, the enchanted war-hammer, is a weapon of great power. Along with giving the wielder of the hammer incredible strength and durability, Mjölfnir can also manipulate lightning by either channelling its own electricity or drawing the

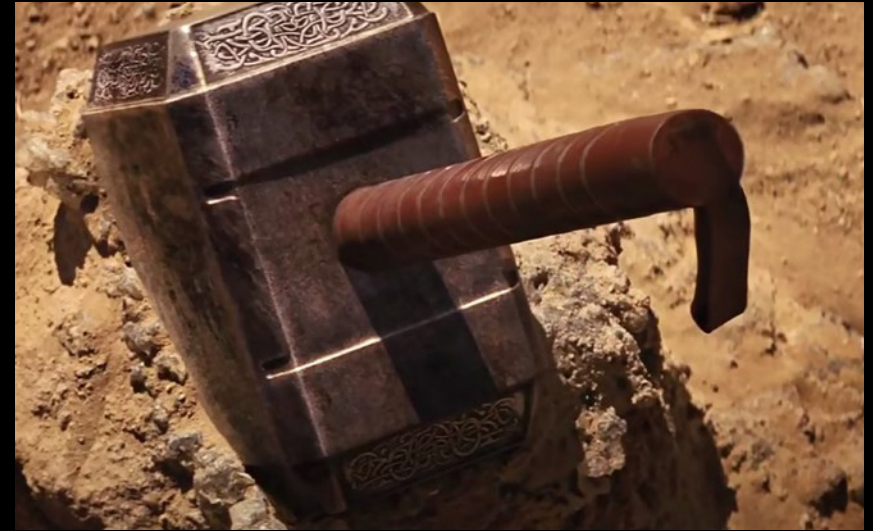

power of the lightning from the surrounding environment. In a world of many, few people have been worthy enough to wield, or even lift, the hammer. For a short period of time, when he was exiled to Earth as a mortal by Odin, even Thor couldn't lift Mjölfnir! Will you be amongst the chosen, worthy few?

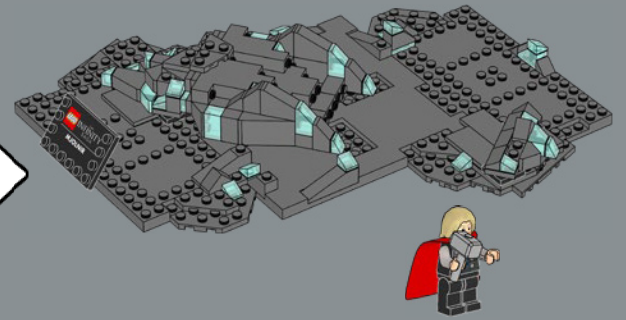
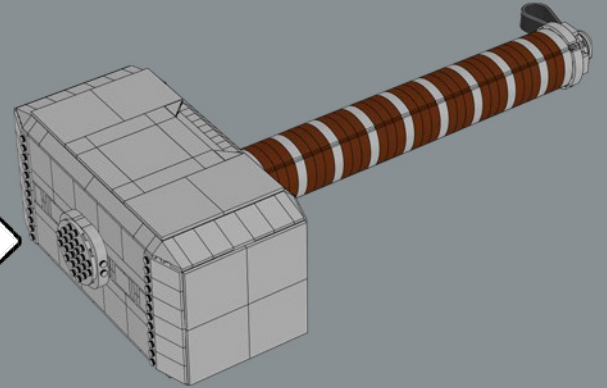
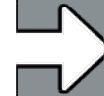
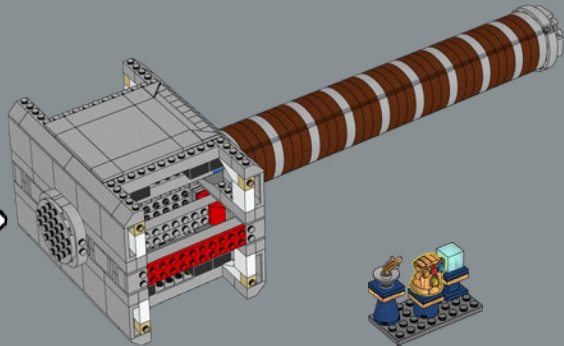
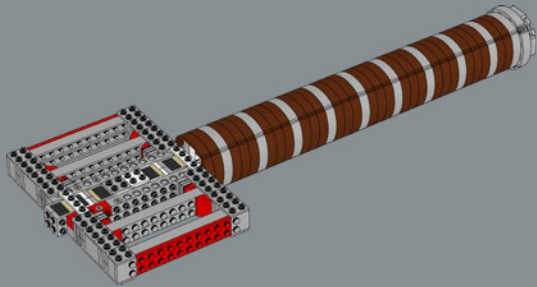
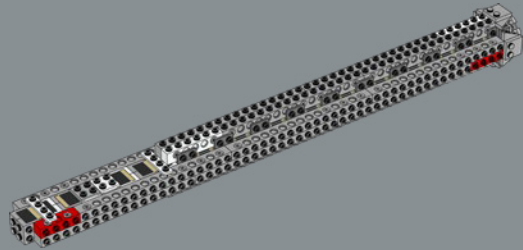

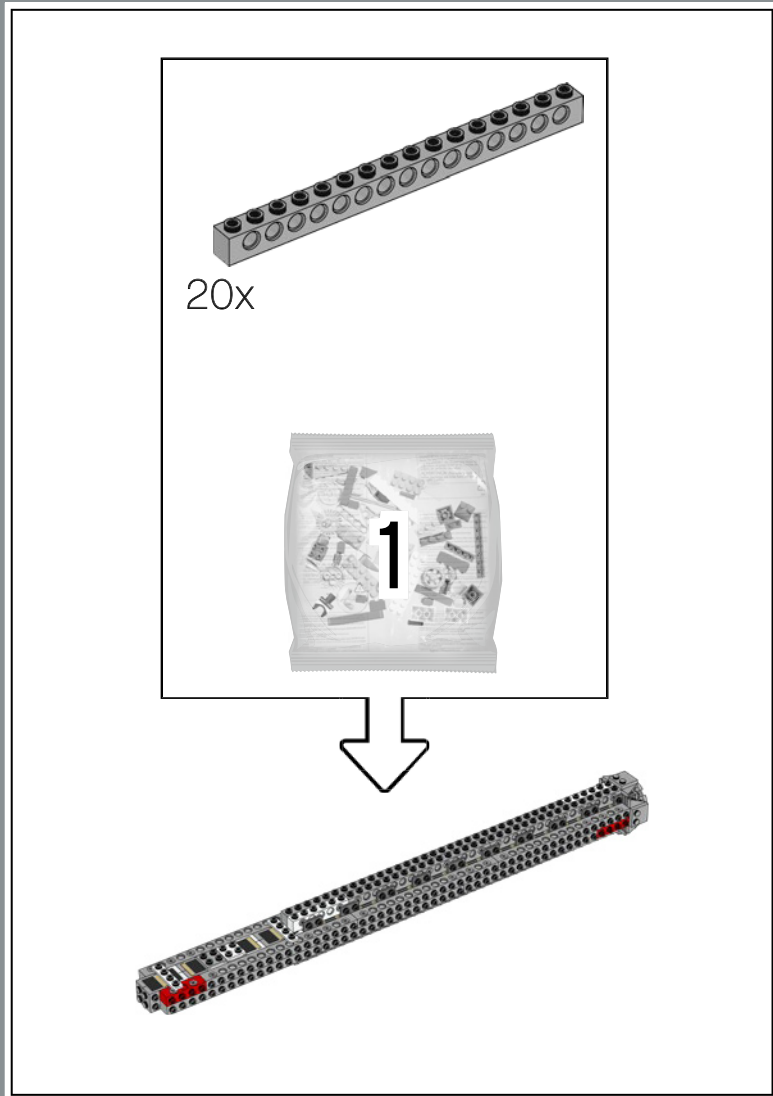

1

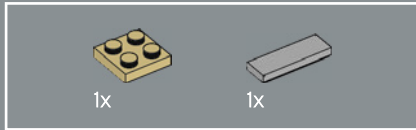
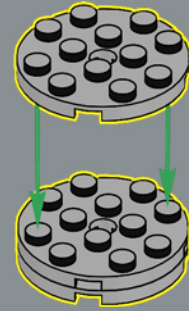

2

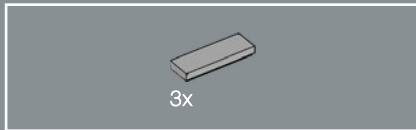
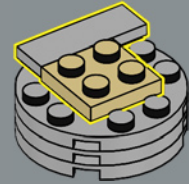

3

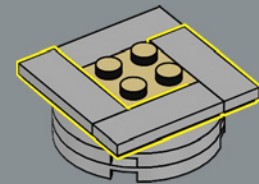

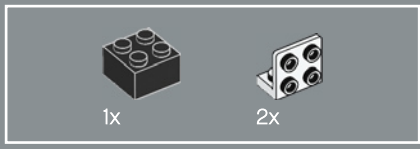

4

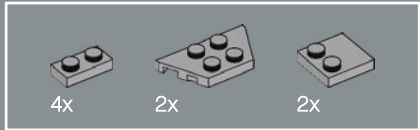
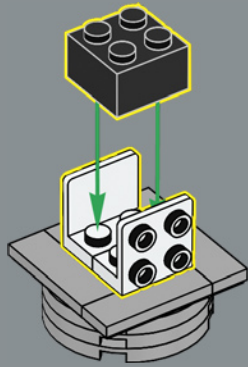

5

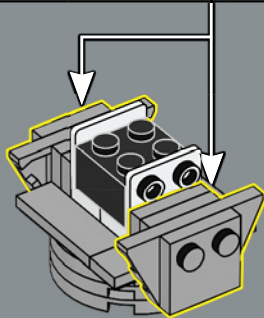
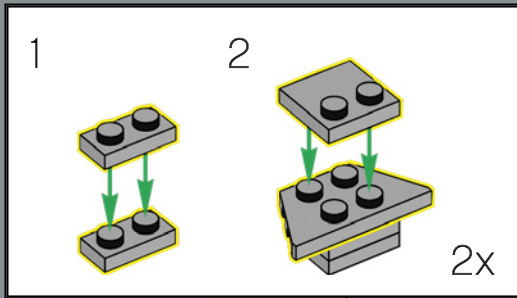

6

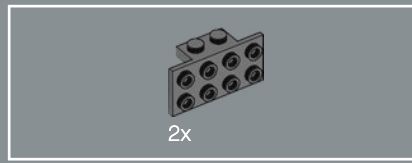

6

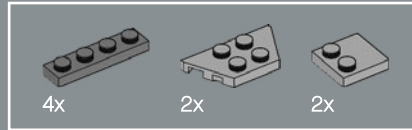
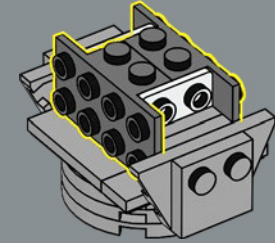

7

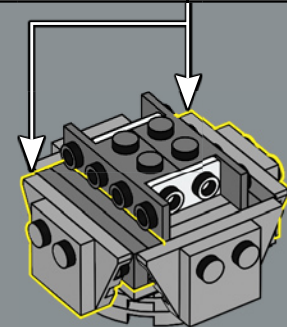
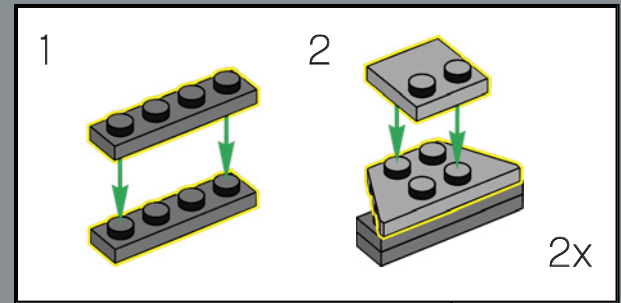

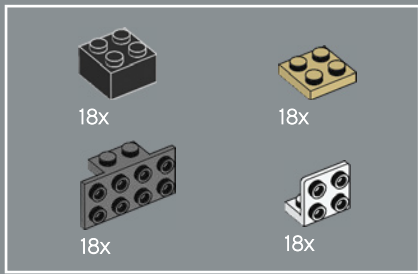

8

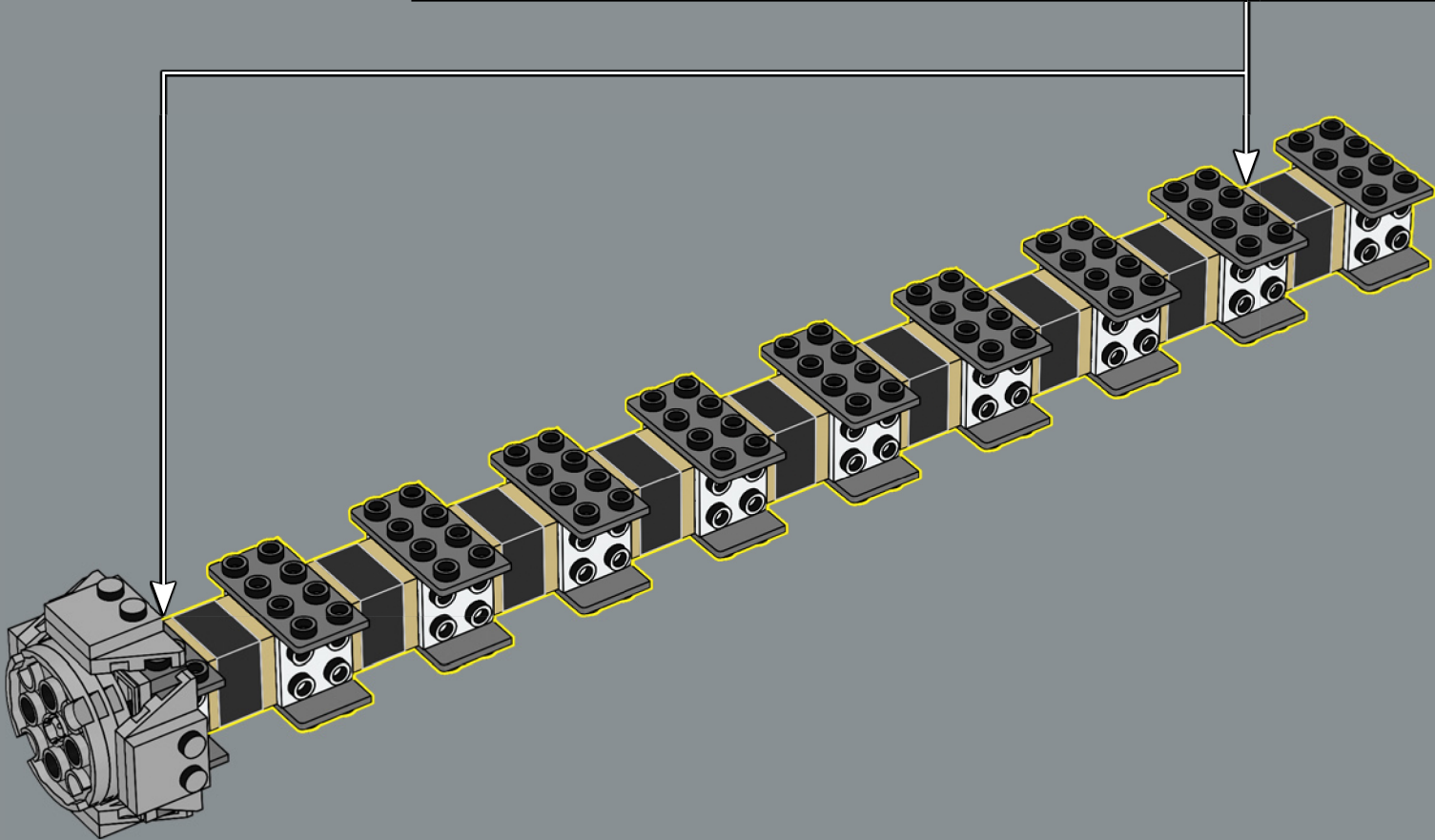
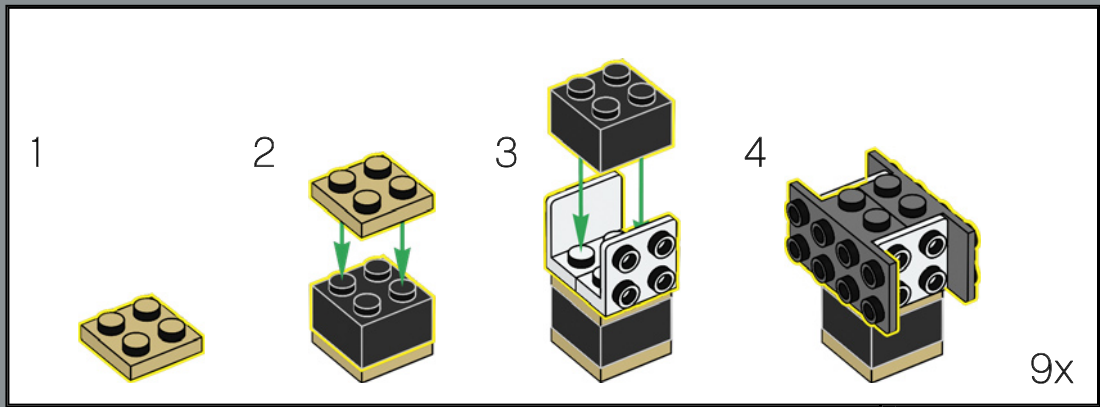

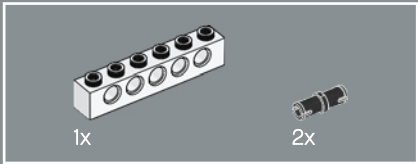
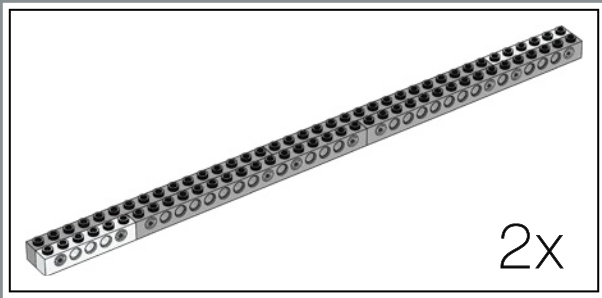

9

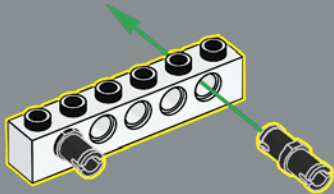

8

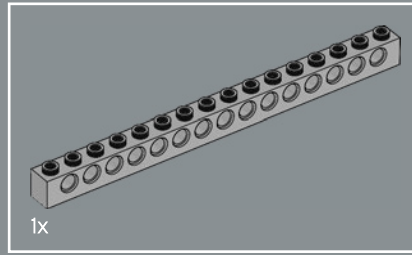

10

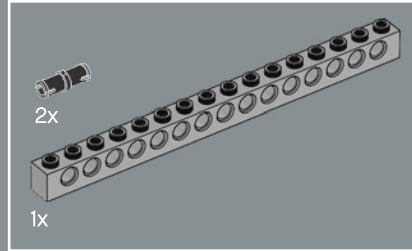
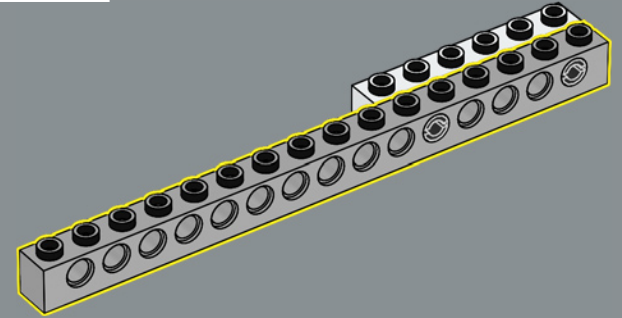

11

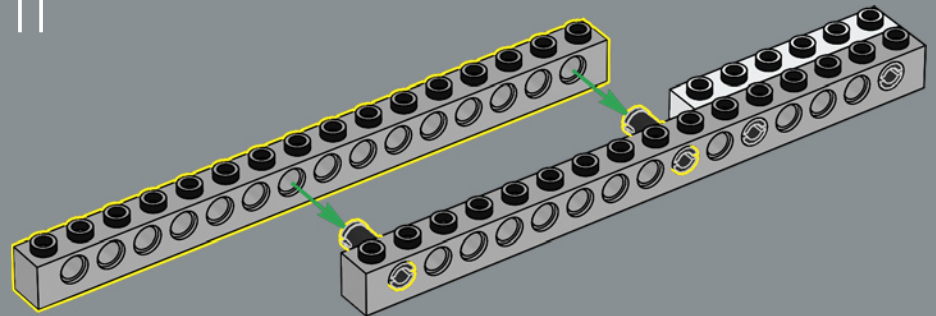



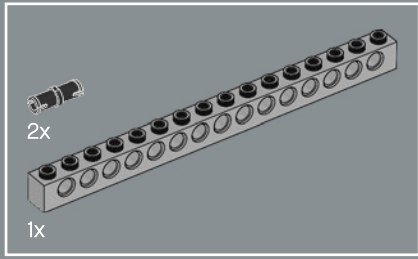

12

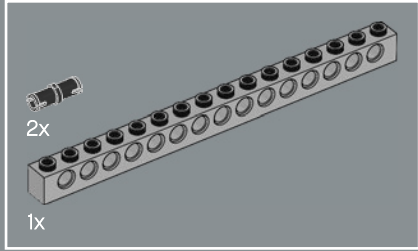
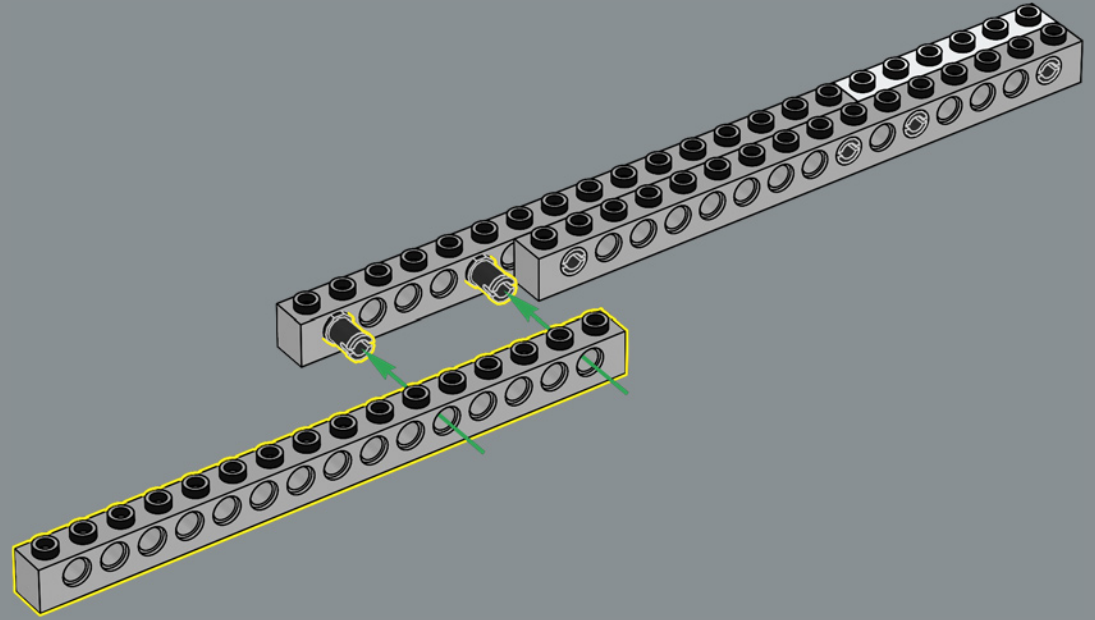

13

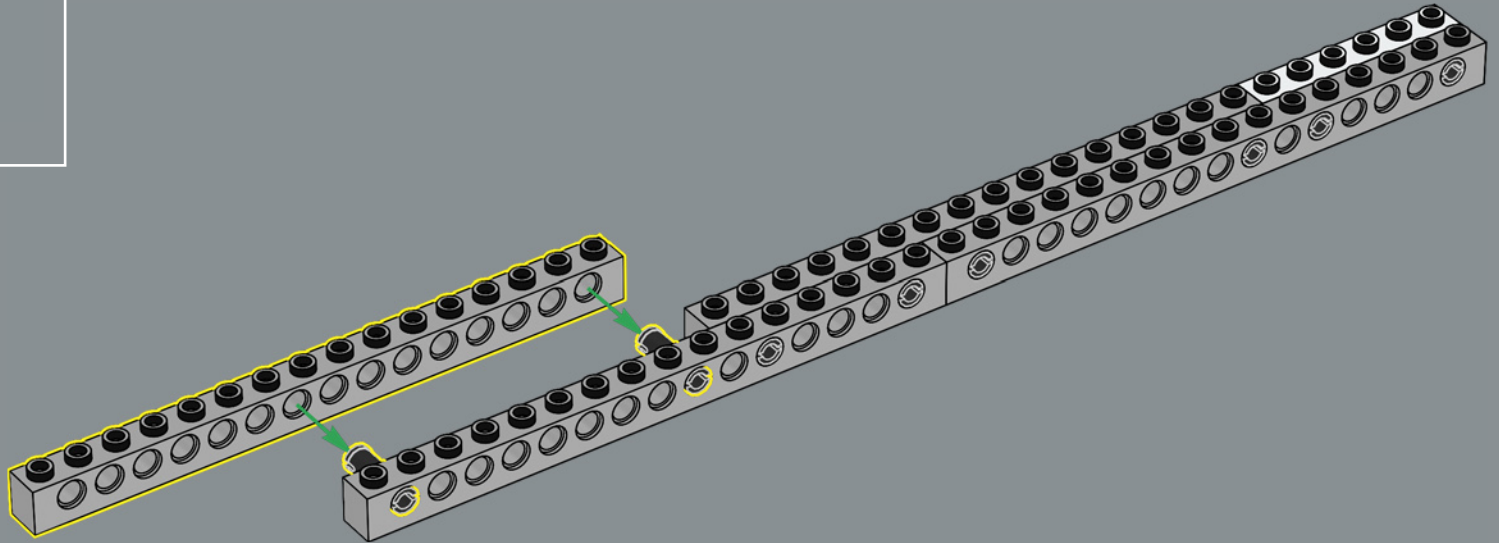

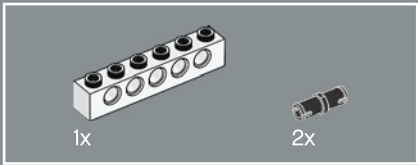

14

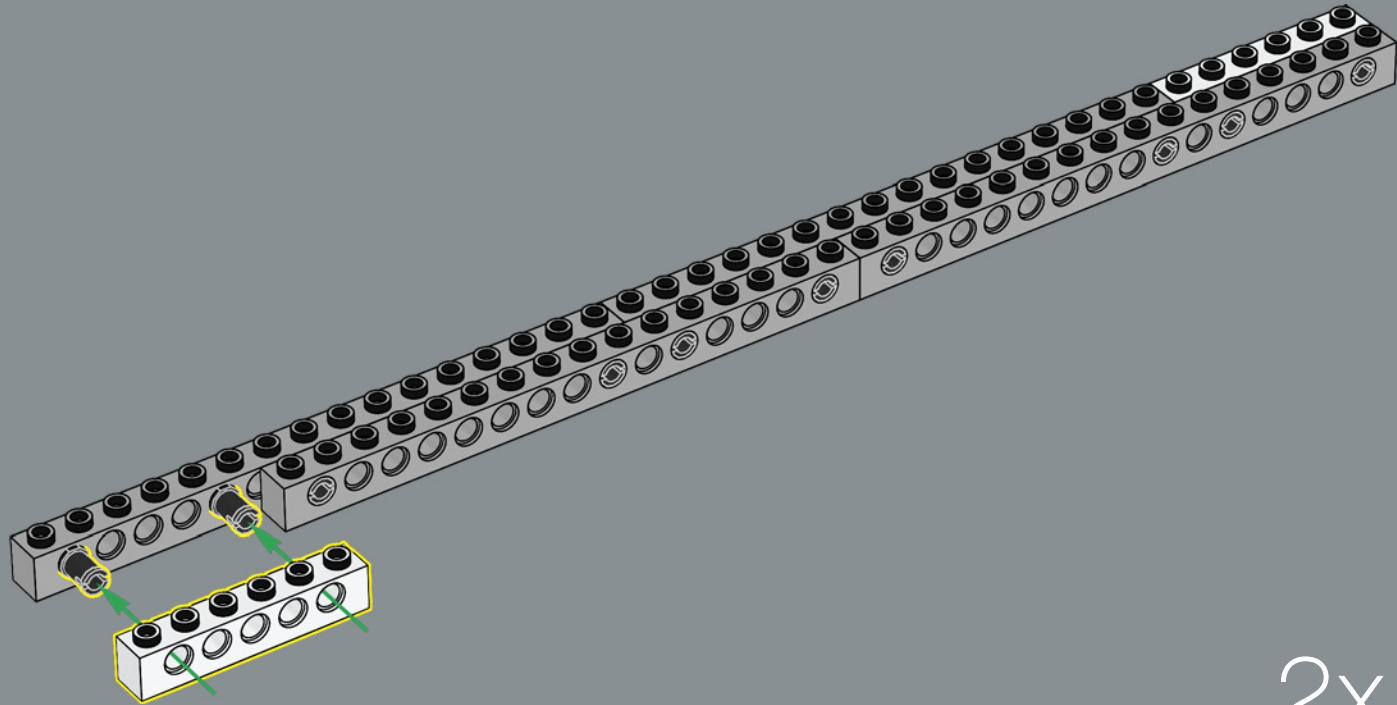

15

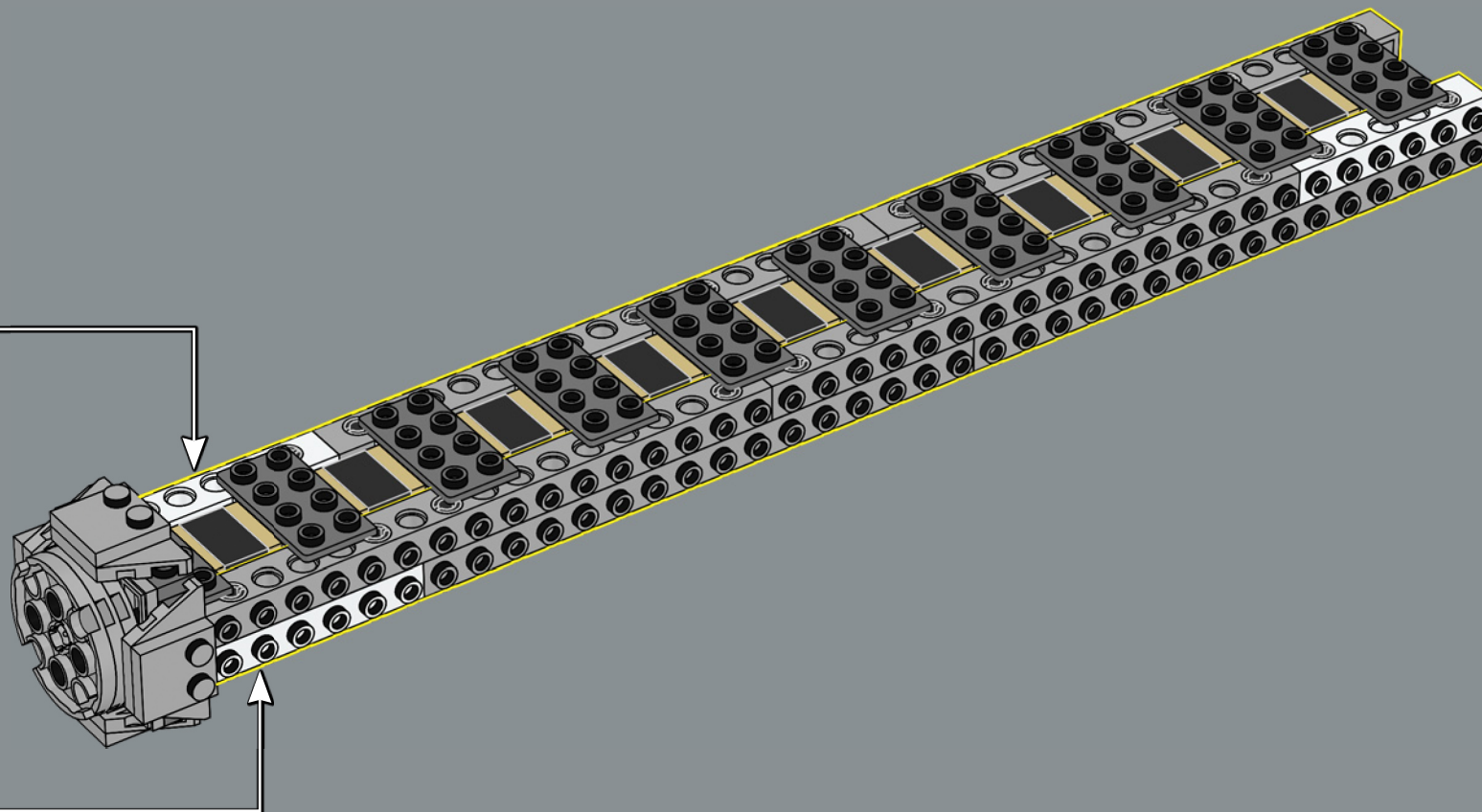

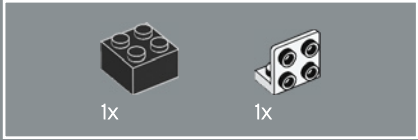
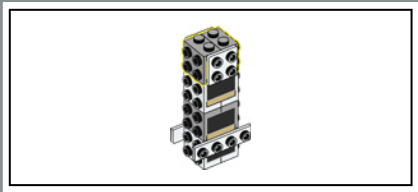

16

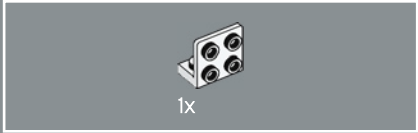
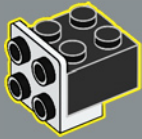

17

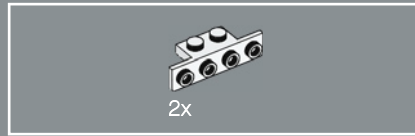

18

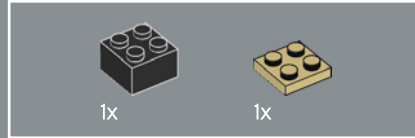
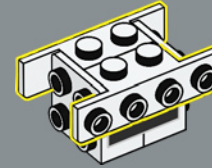

19

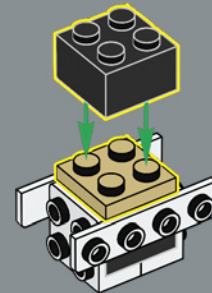



20

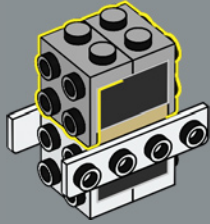

21

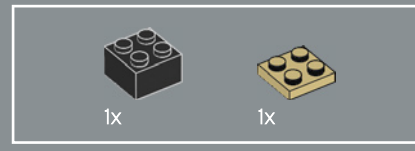
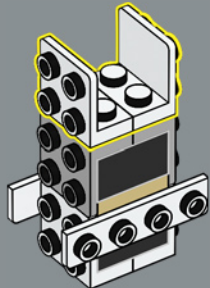

22

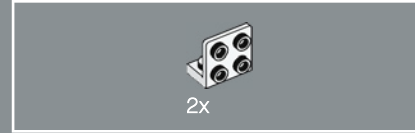
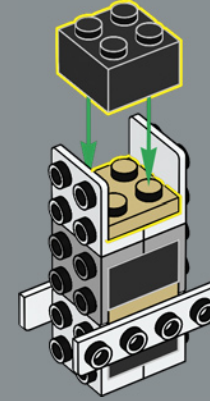

23

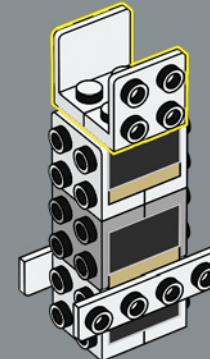



1x

24

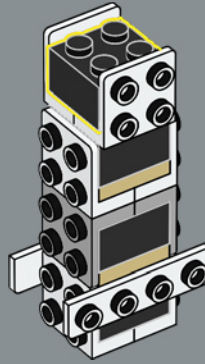

2x

25

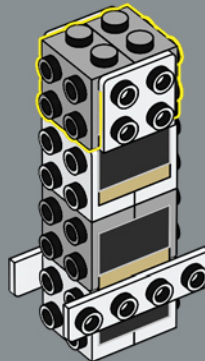

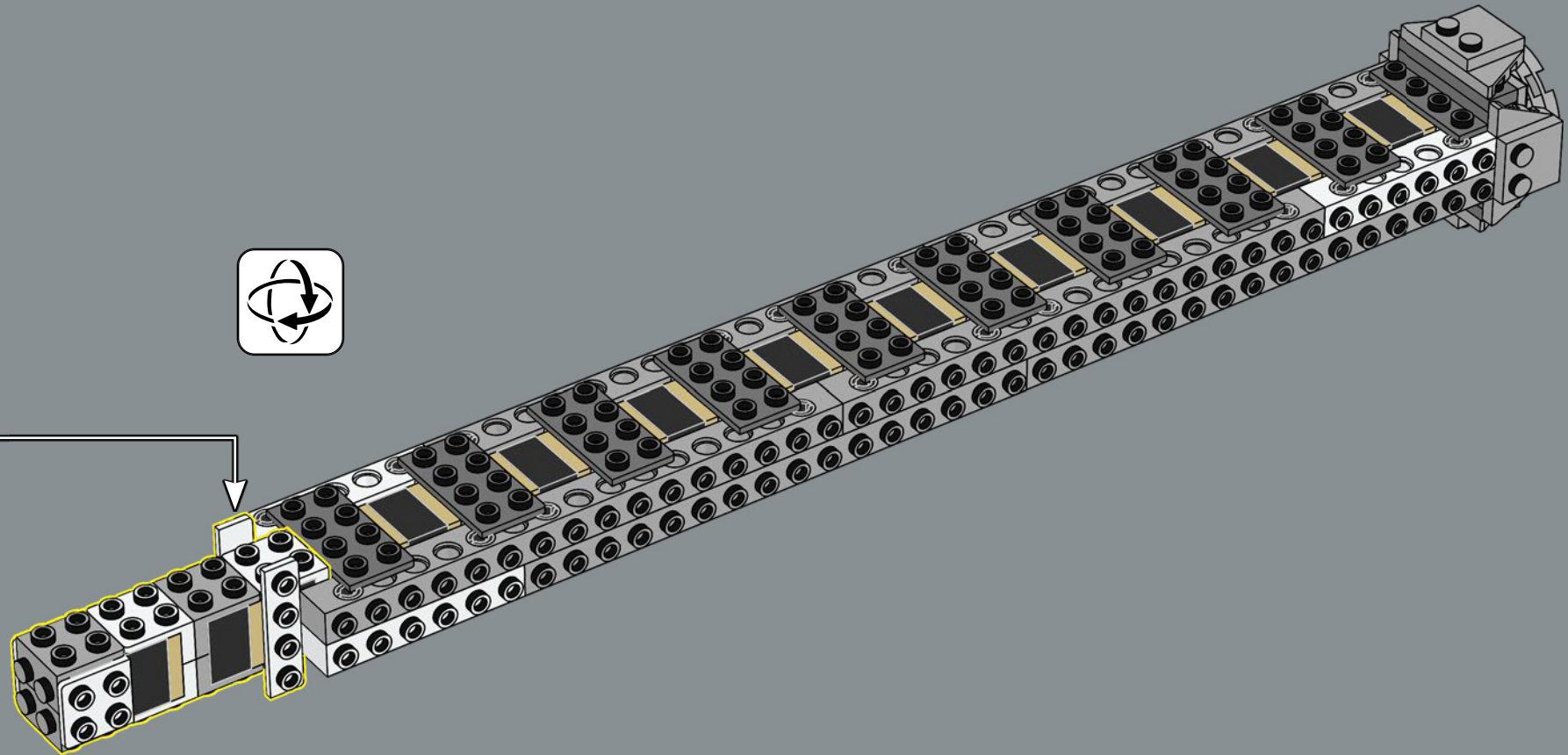

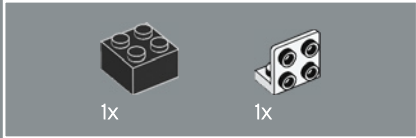
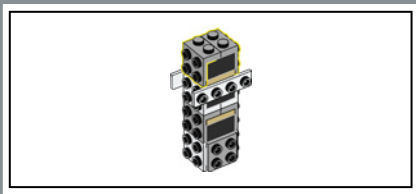

27

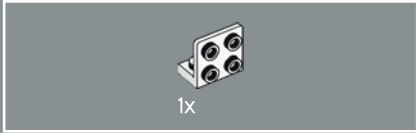
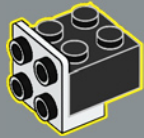

28

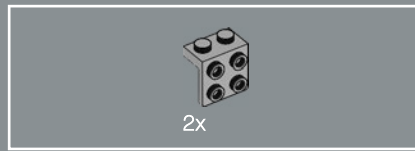
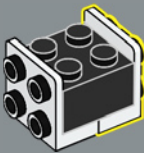

29

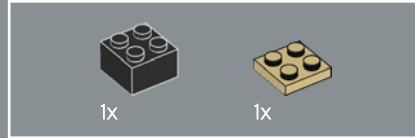
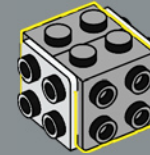

30

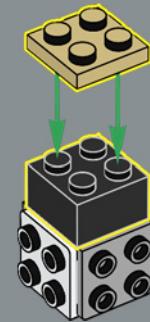





31

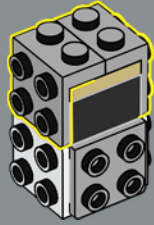

32

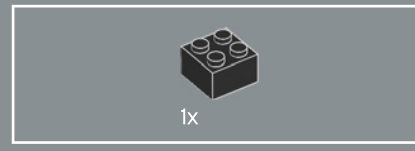
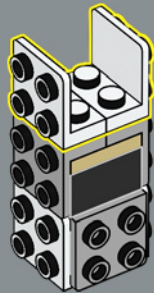

33

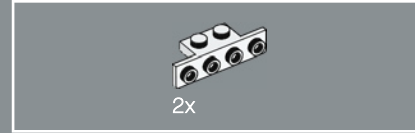
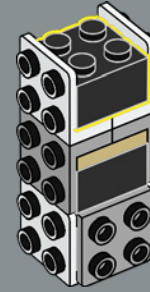

34

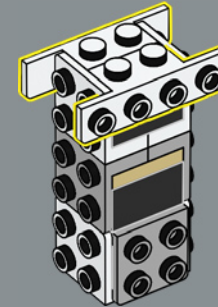

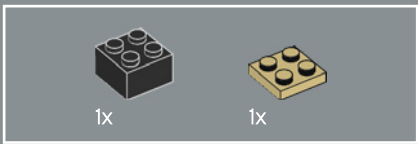

35

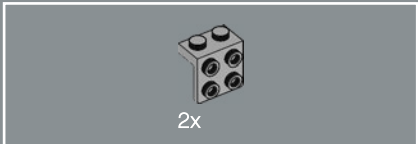
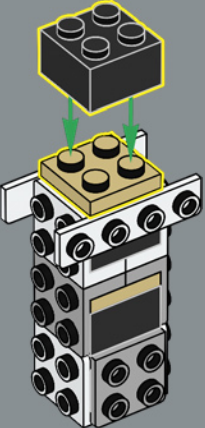

36

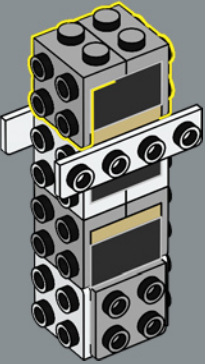

37

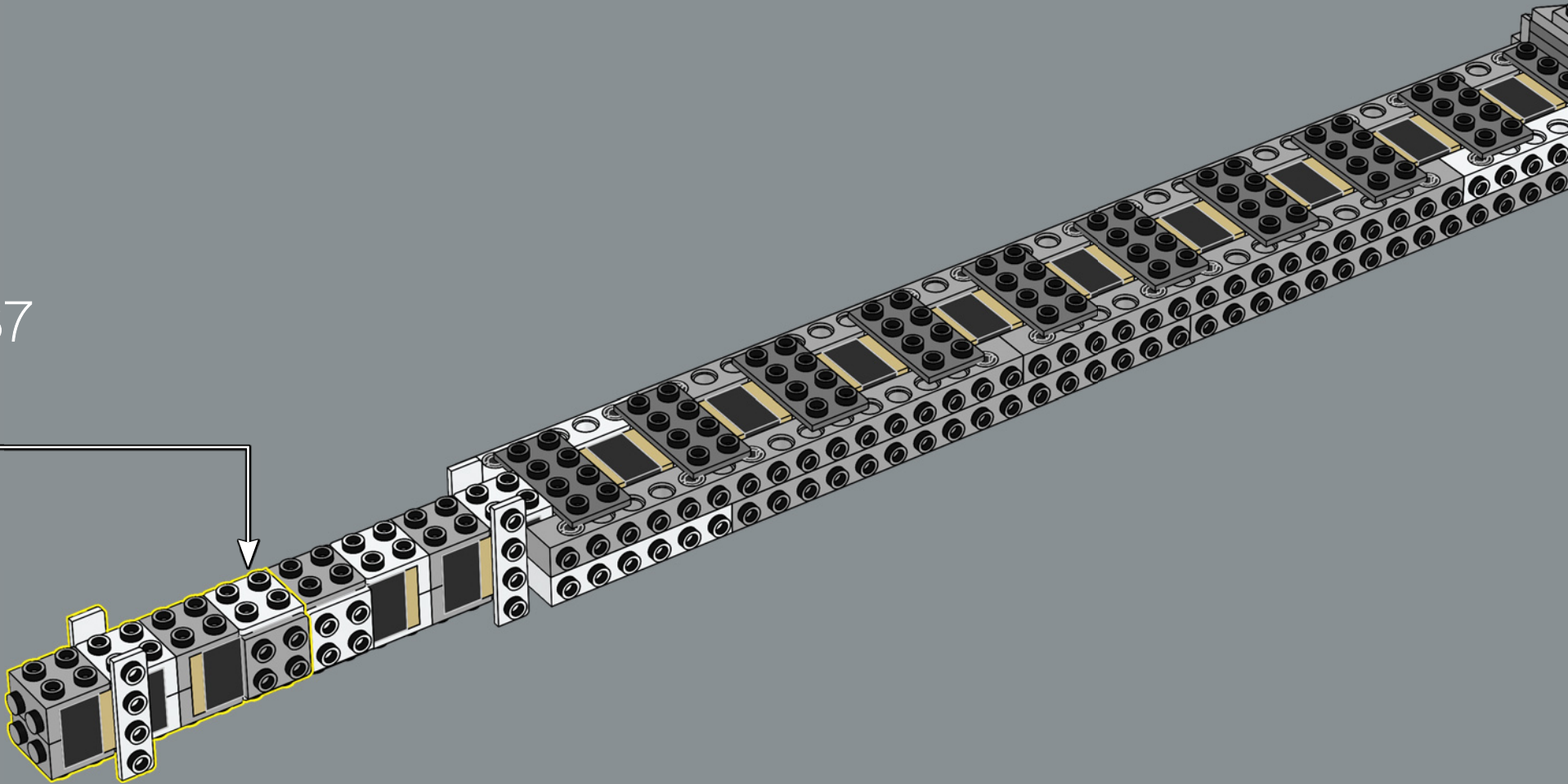

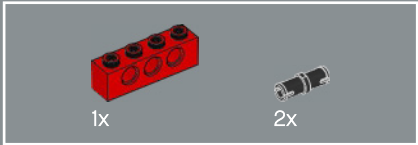
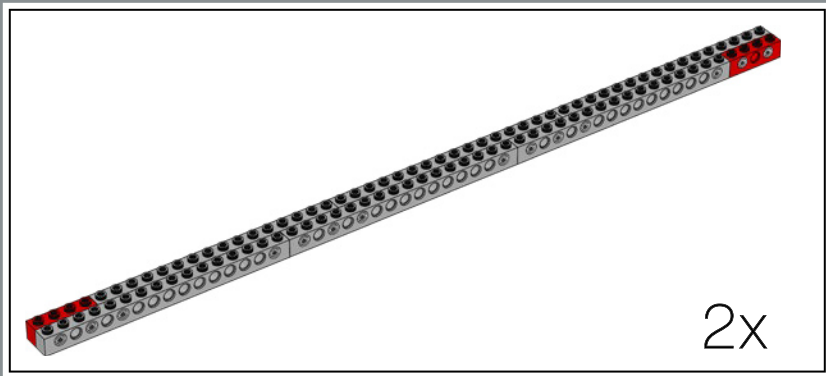

38

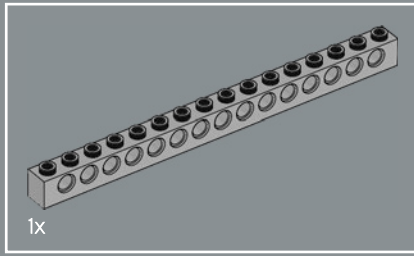
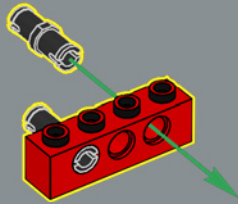

39

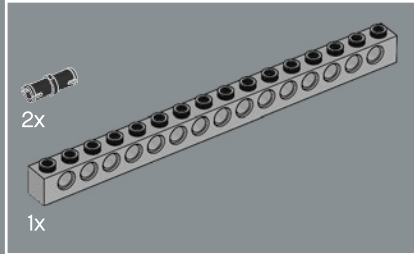
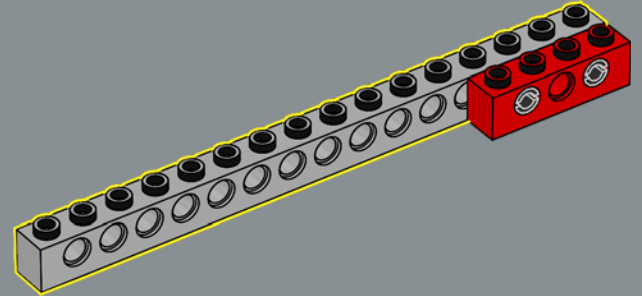

40

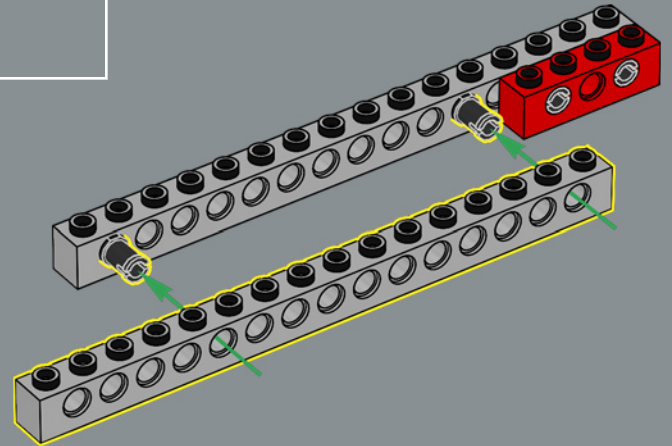

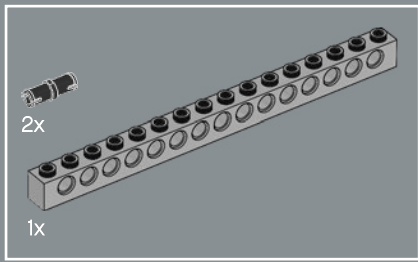

41

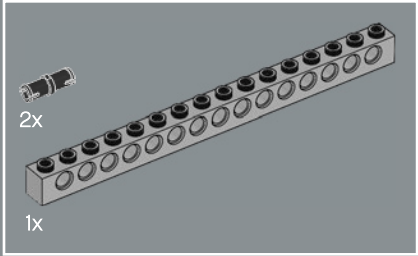
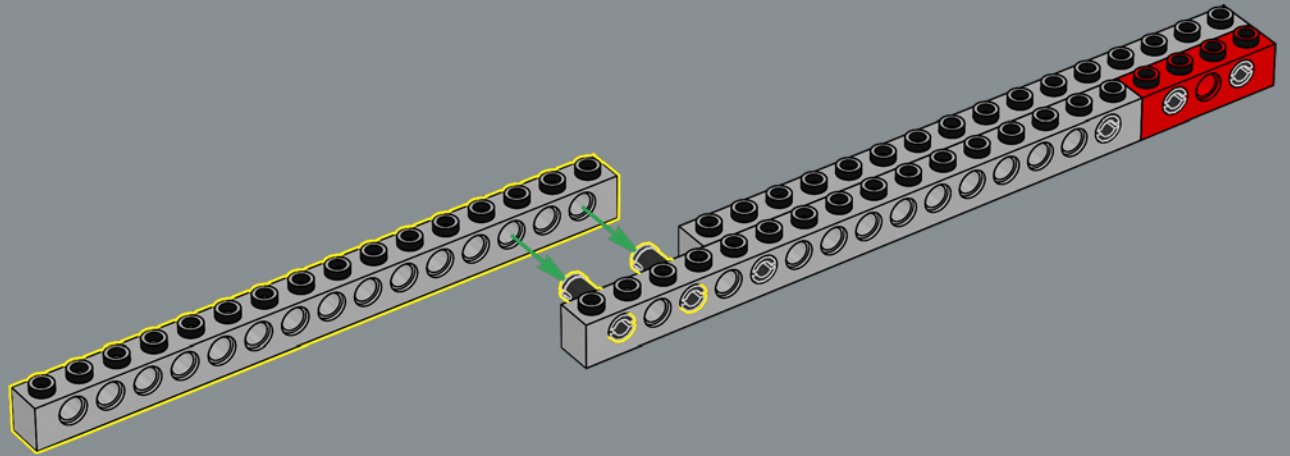

42

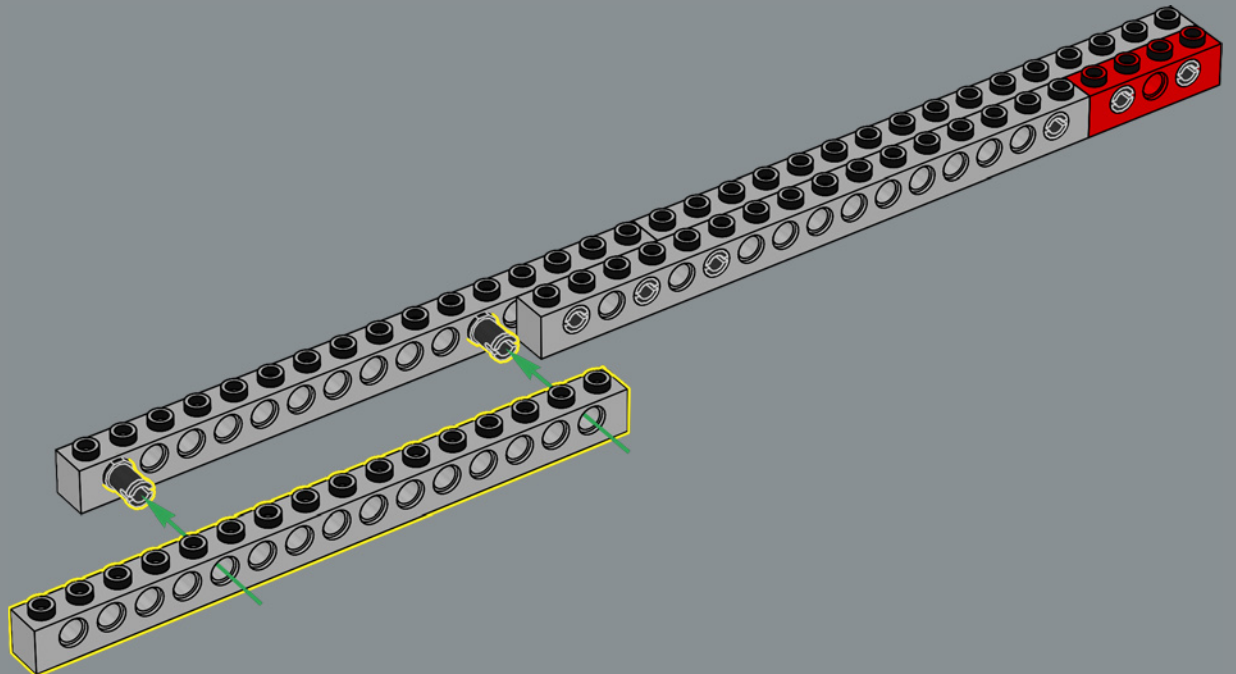

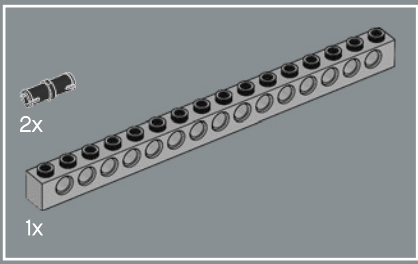

43

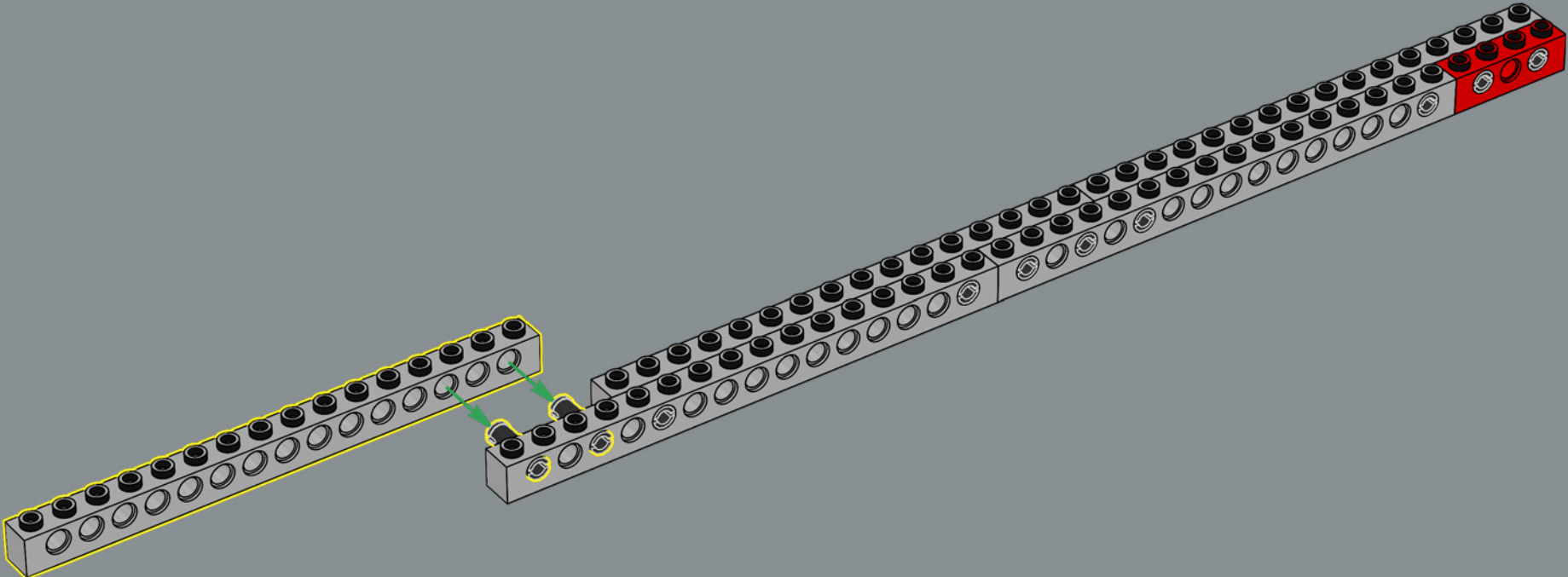

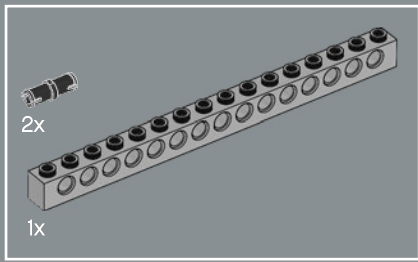

44

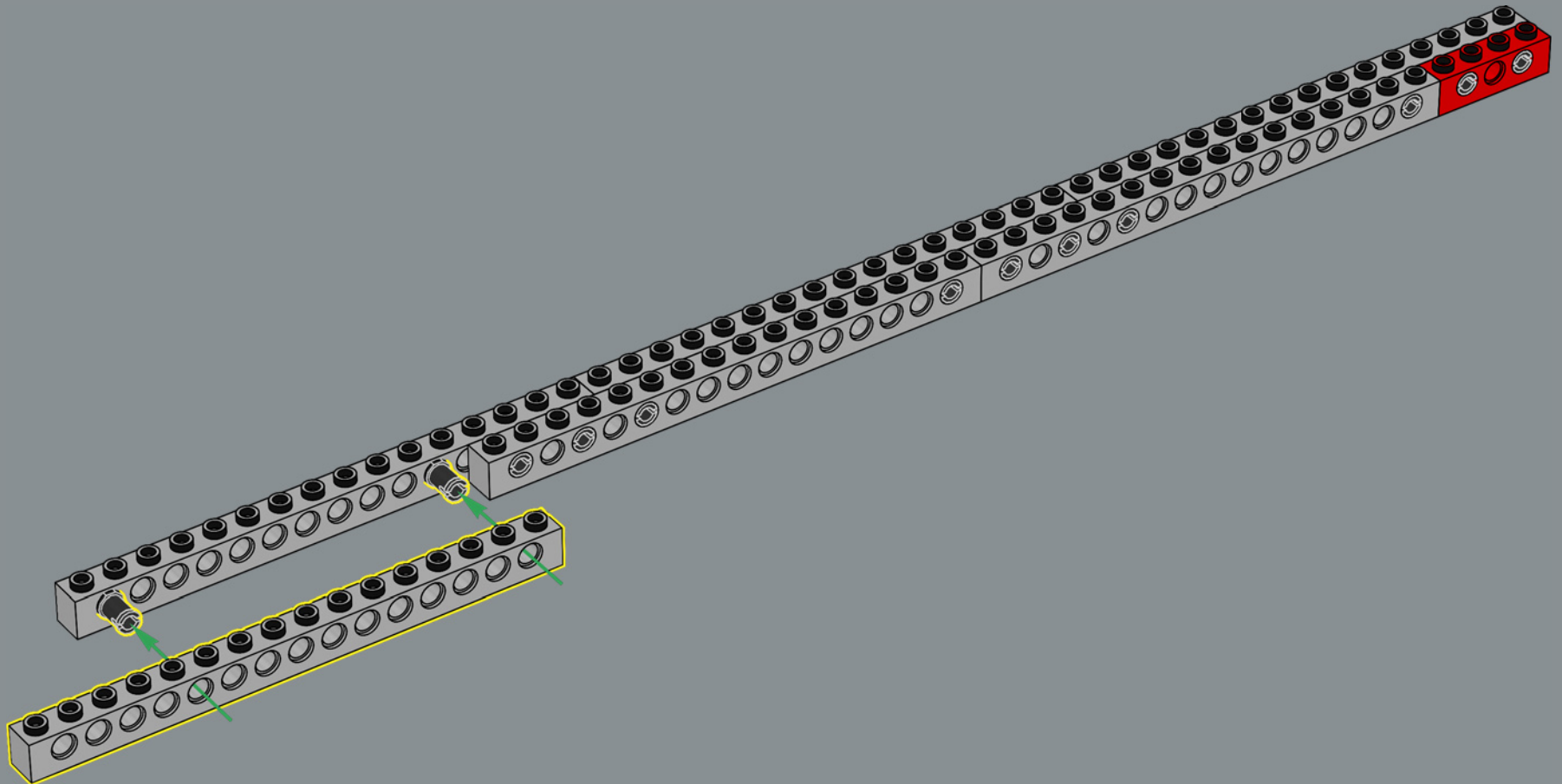

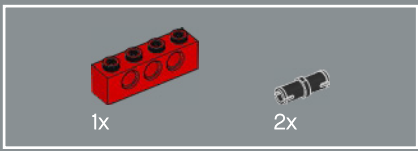

45

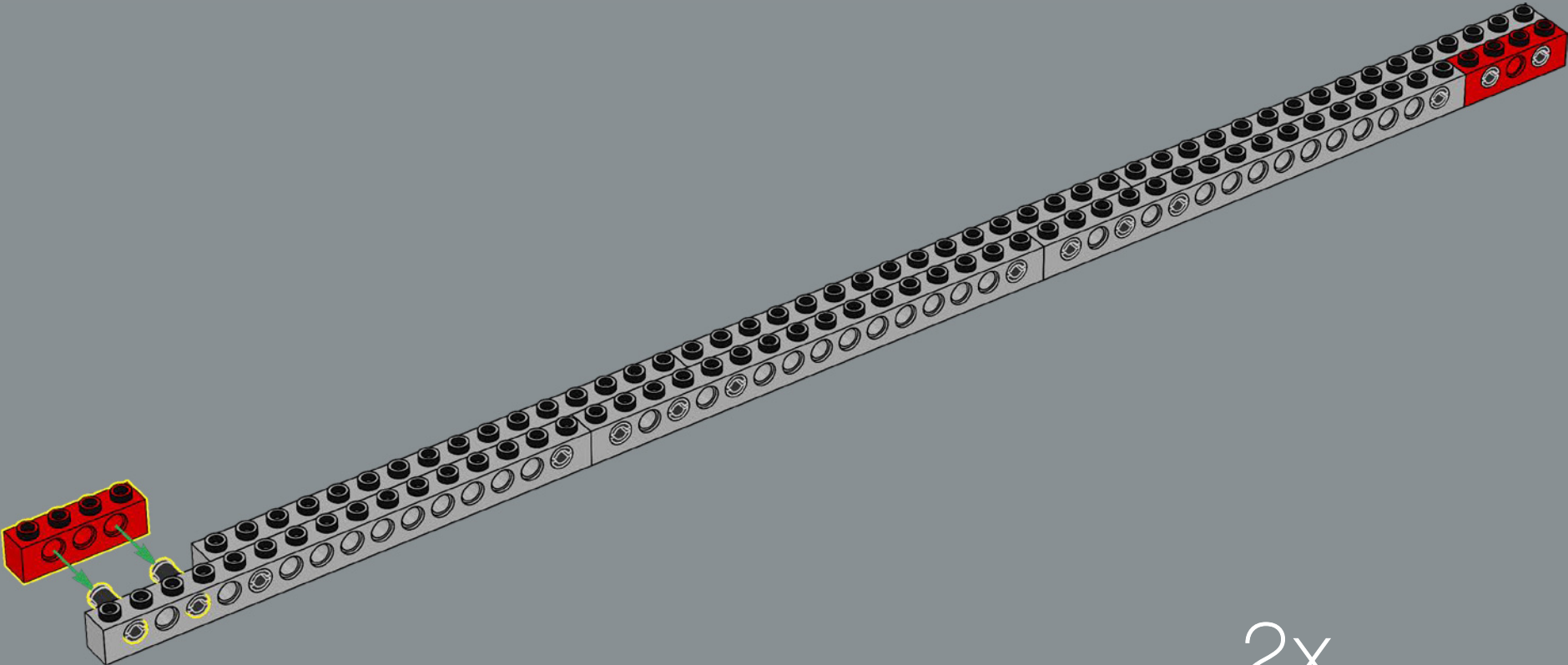



46

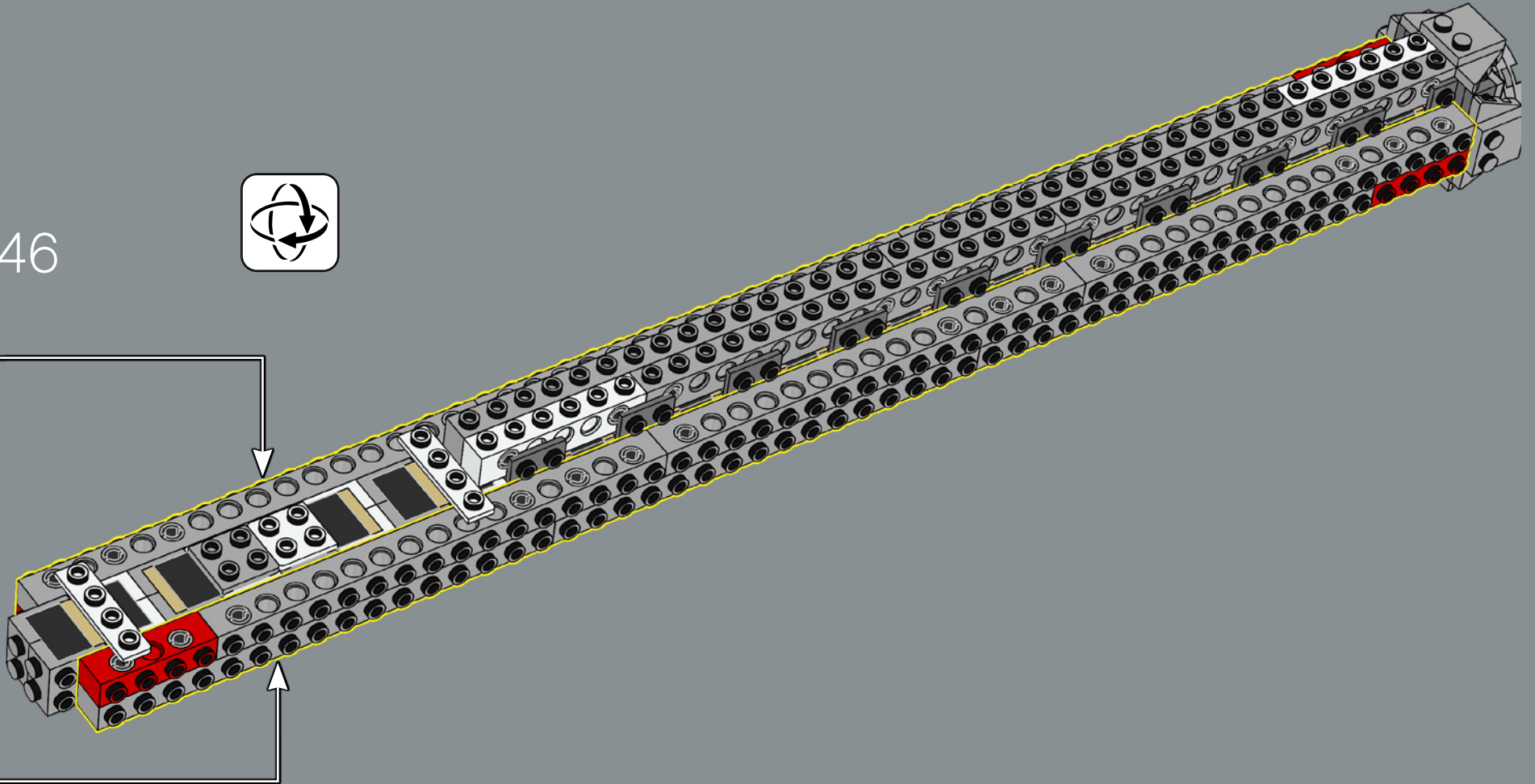

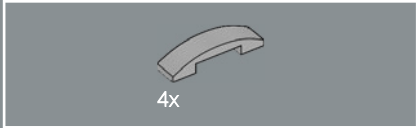
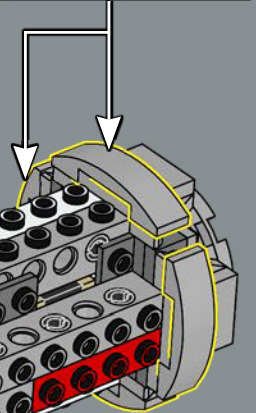
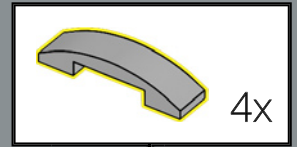
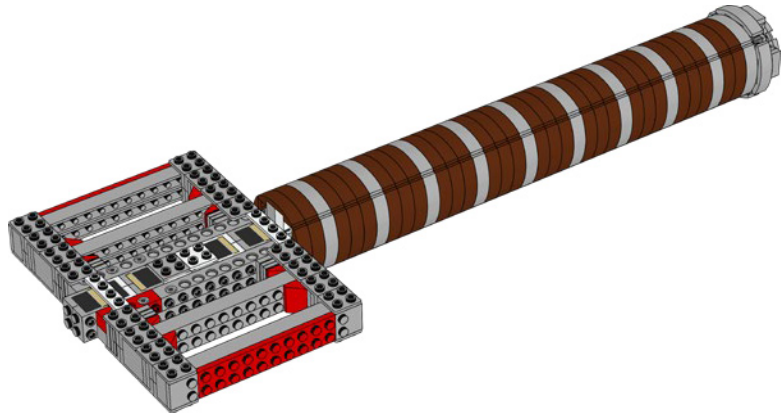
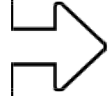

47

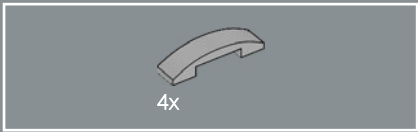

48

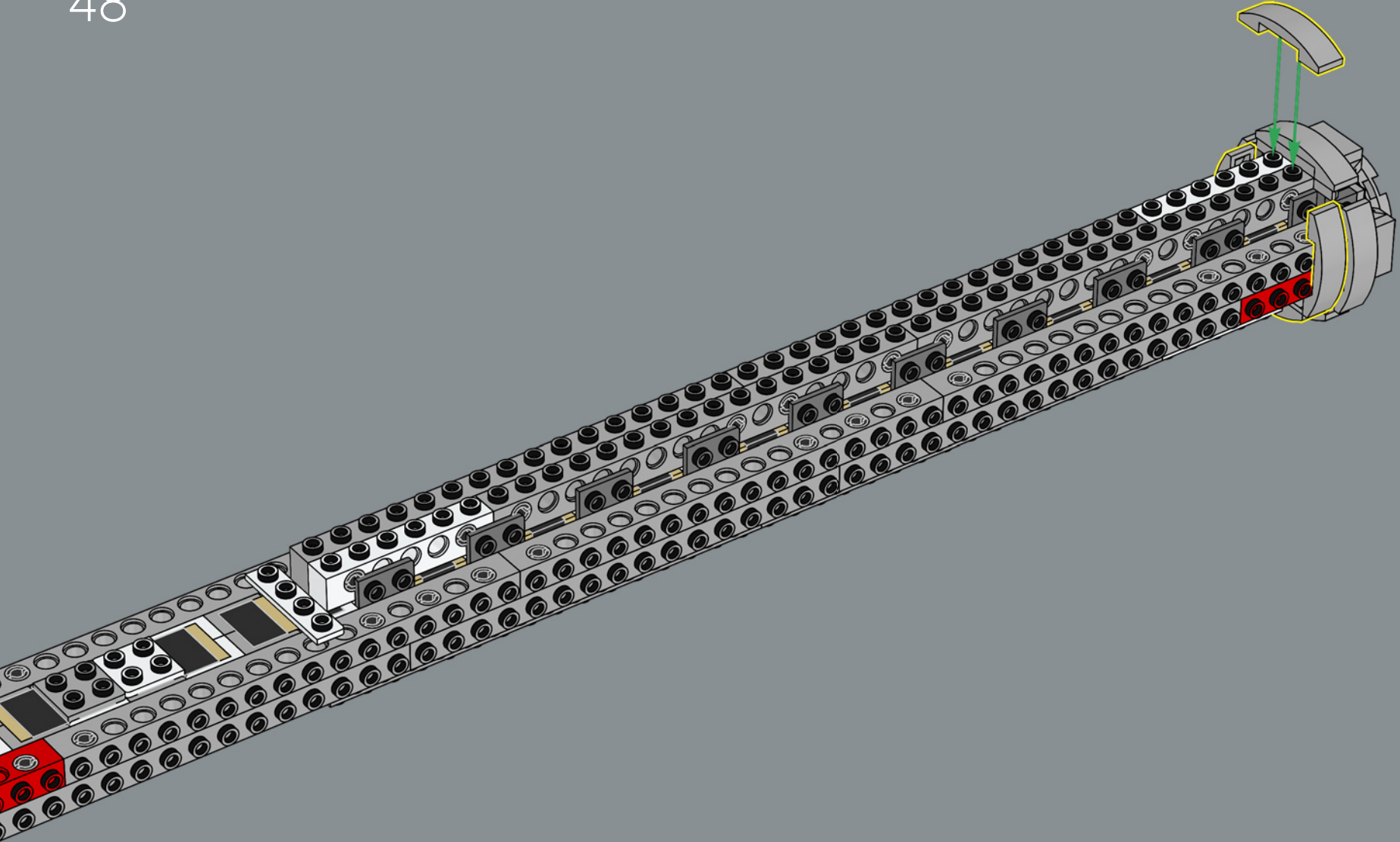

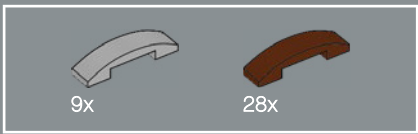

49

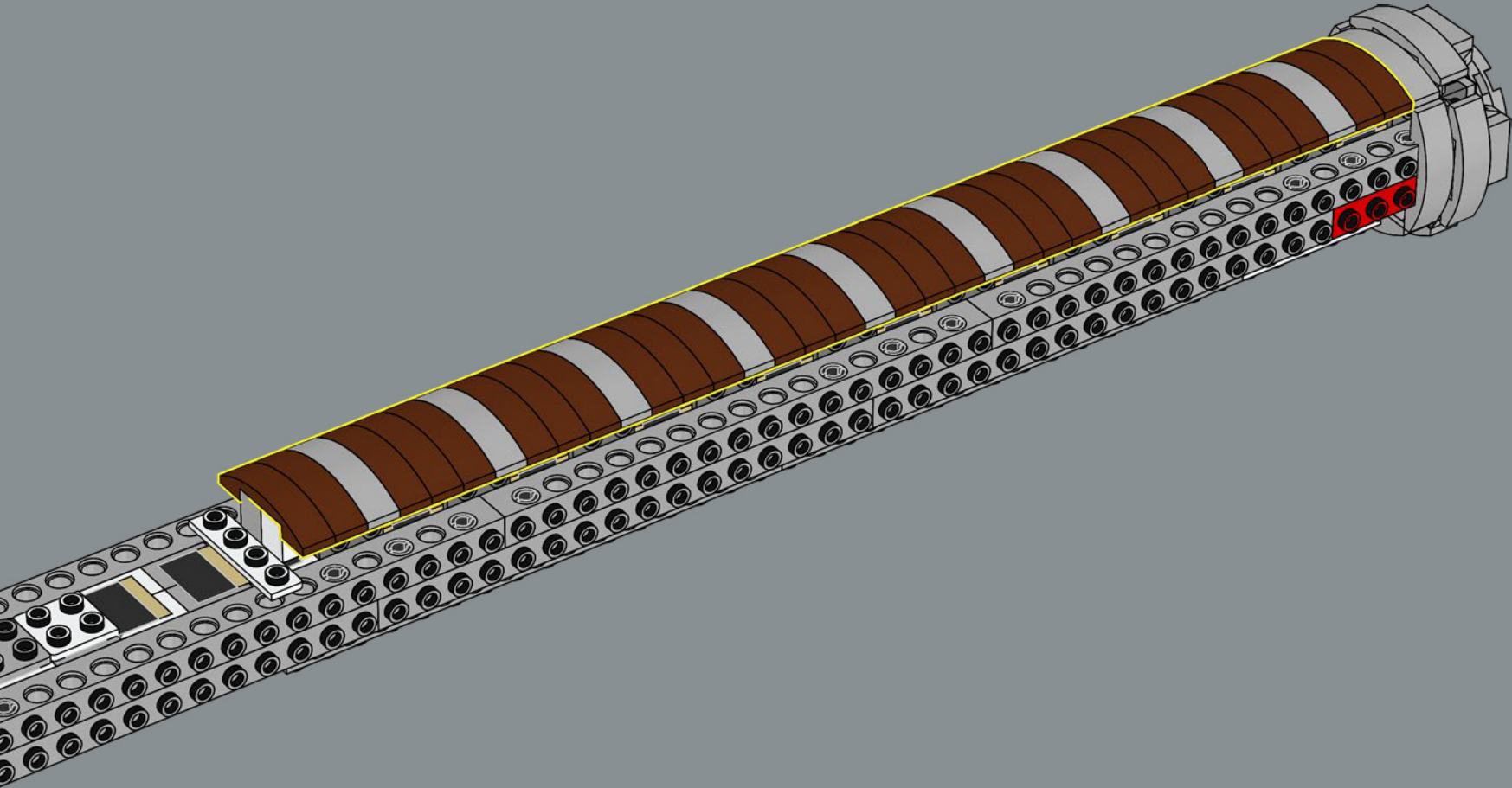

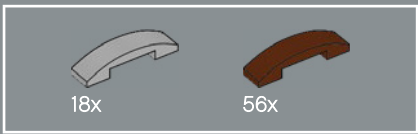

50

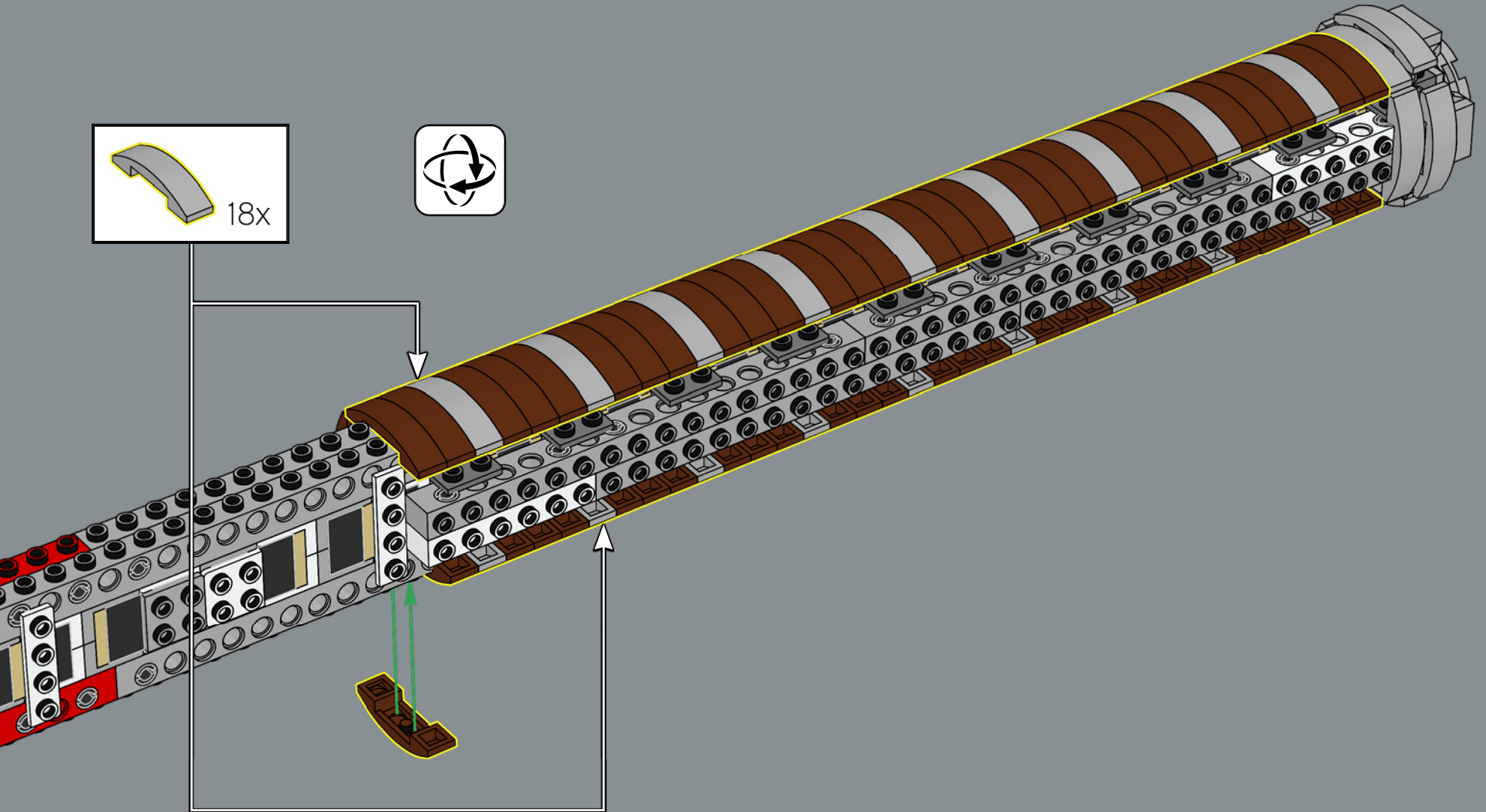
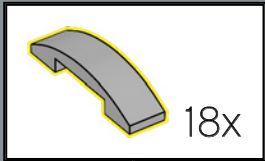

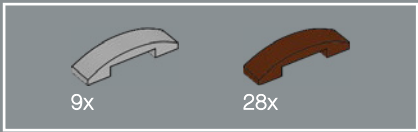

51

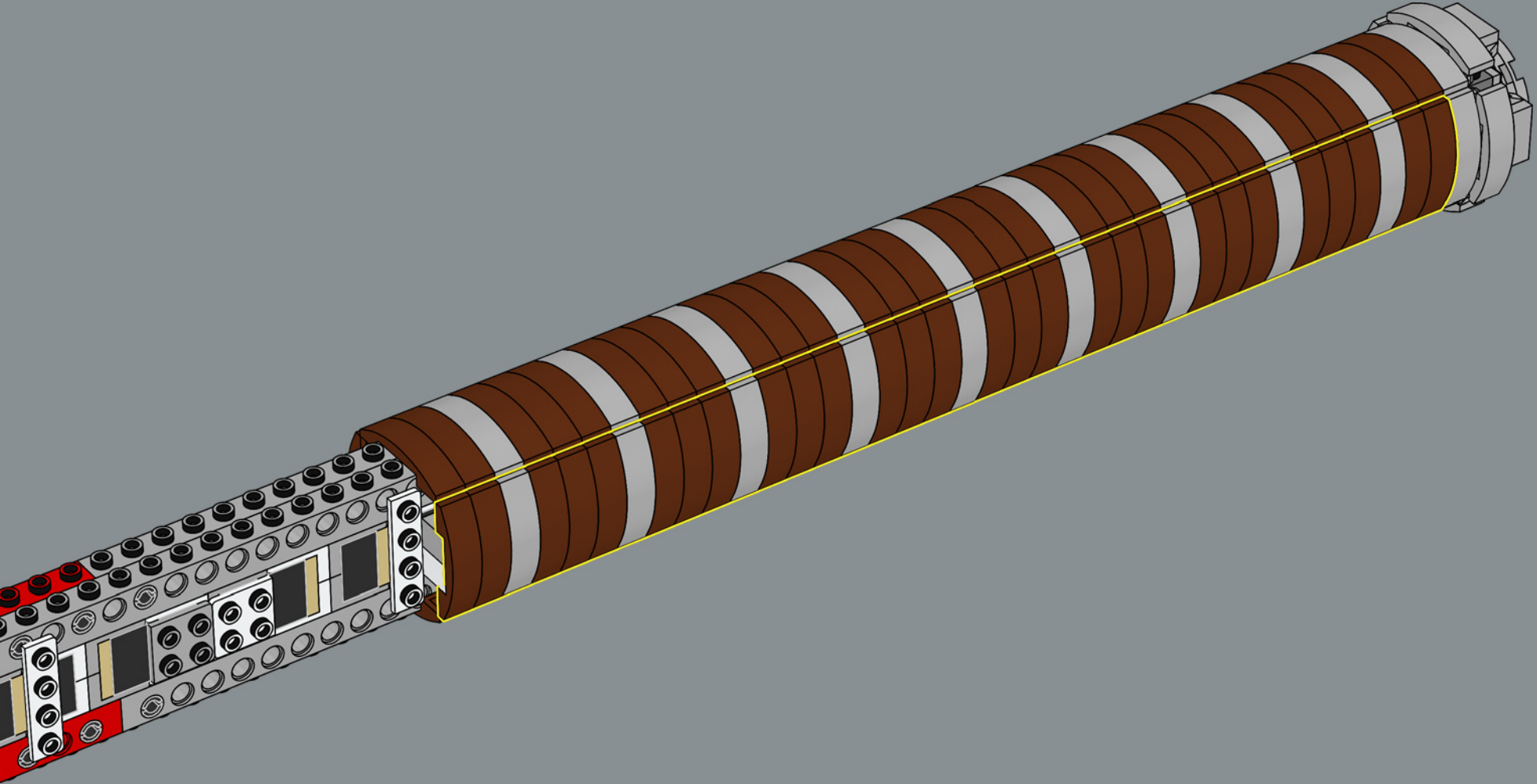

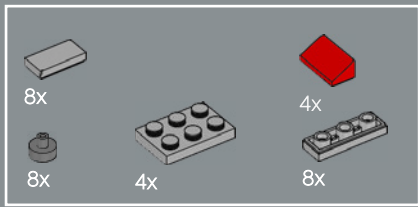

52

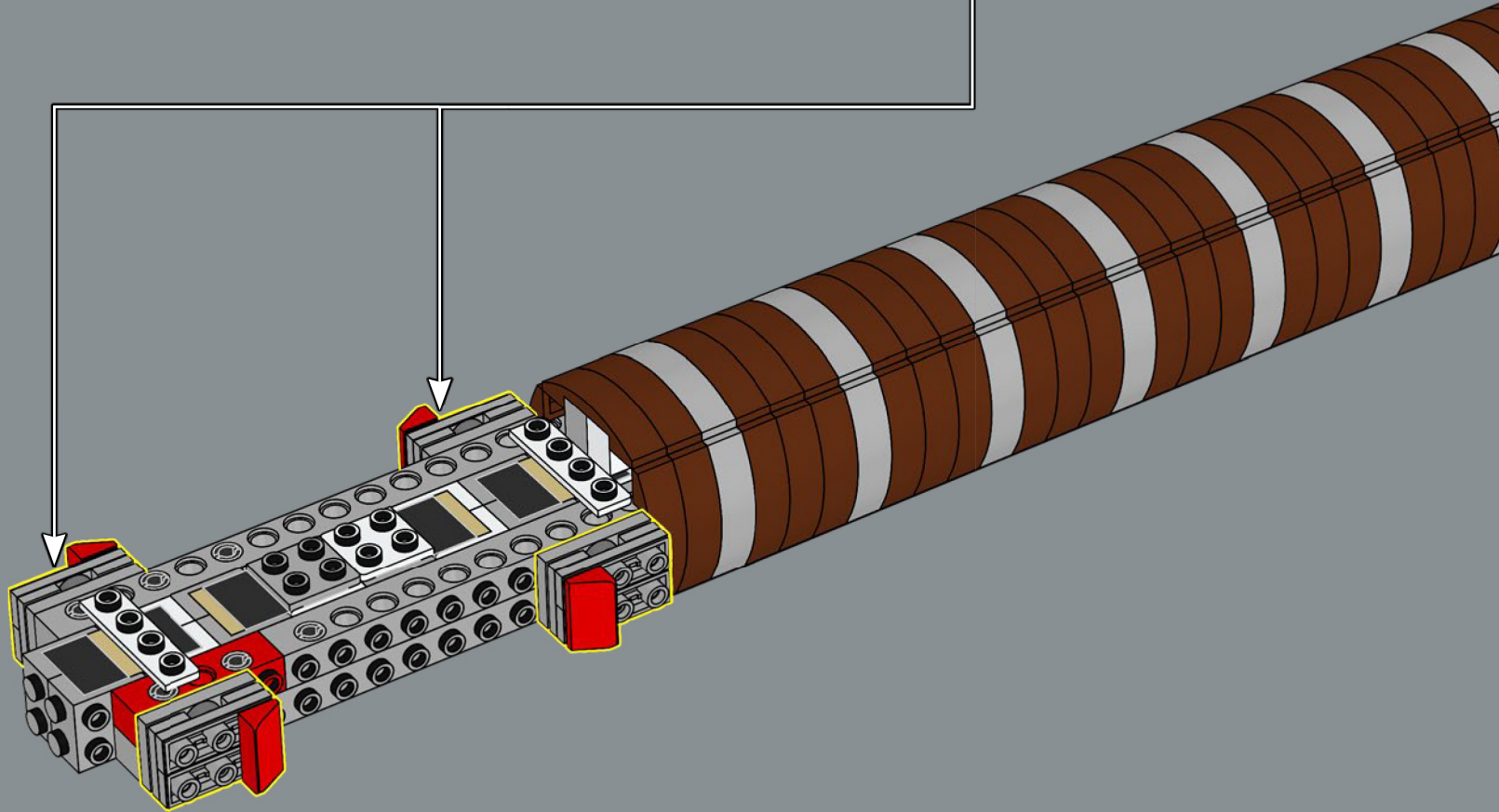
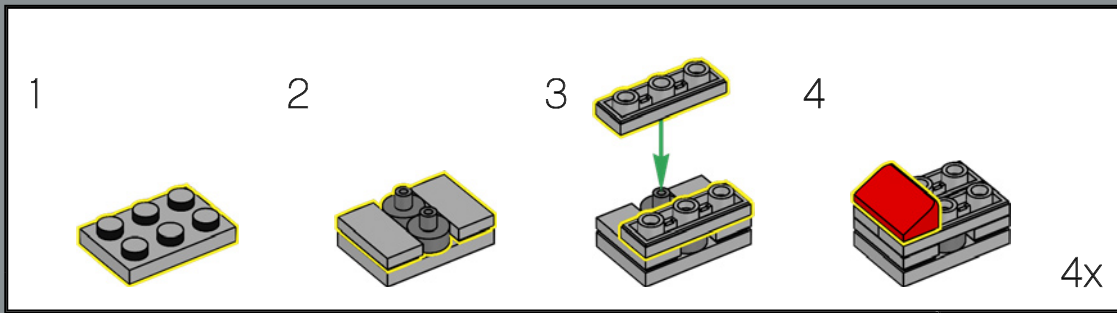



8x

53



8x

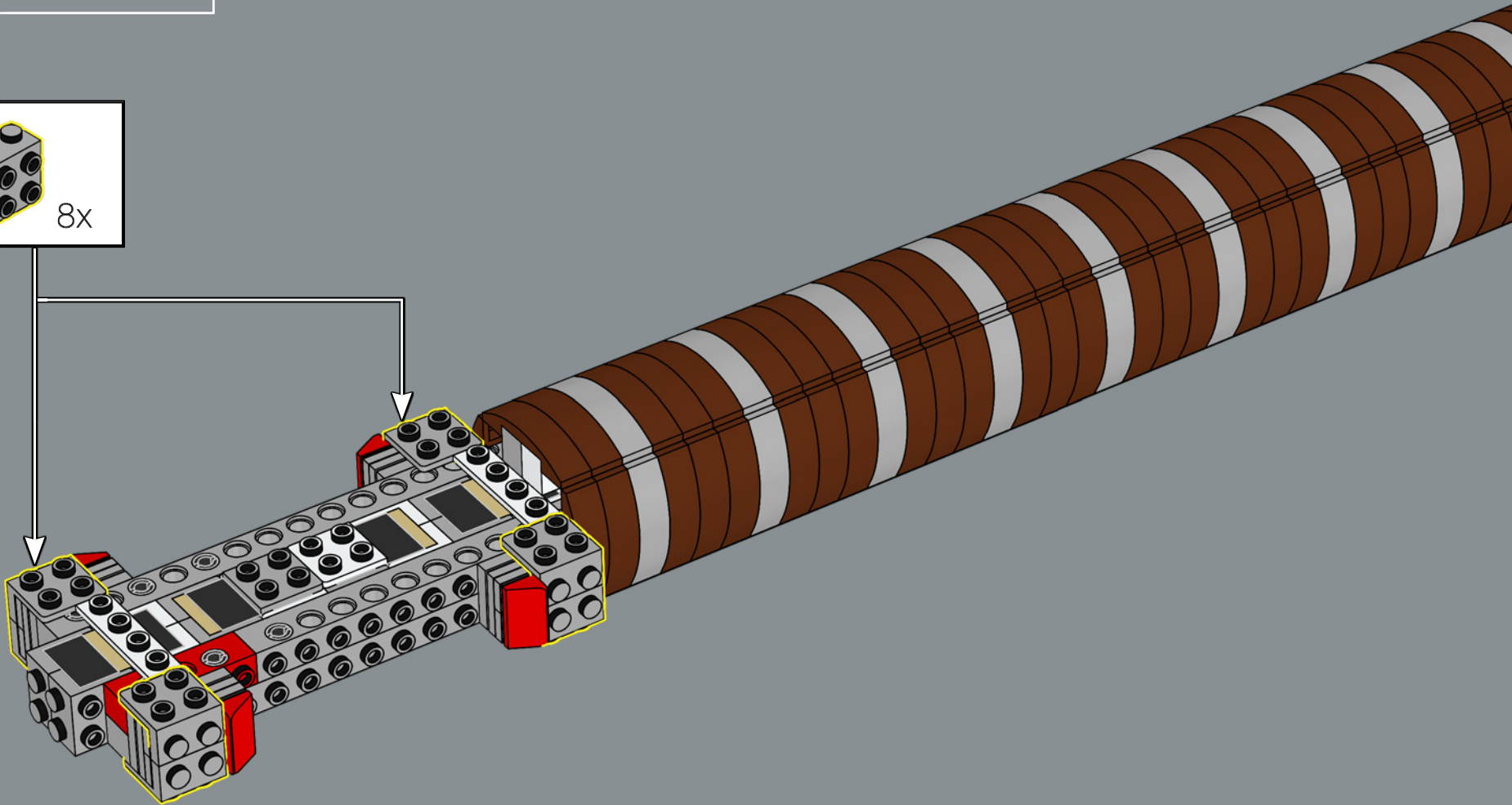



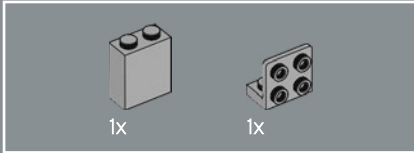
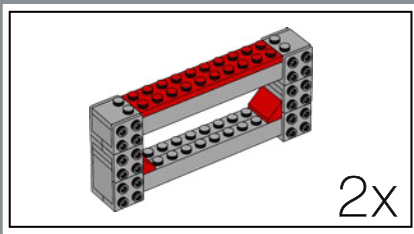

54

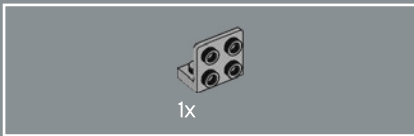
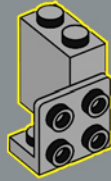

55

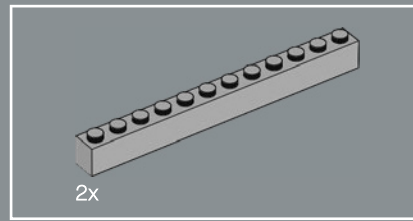
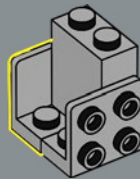

56

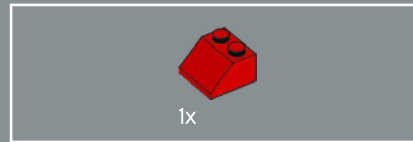
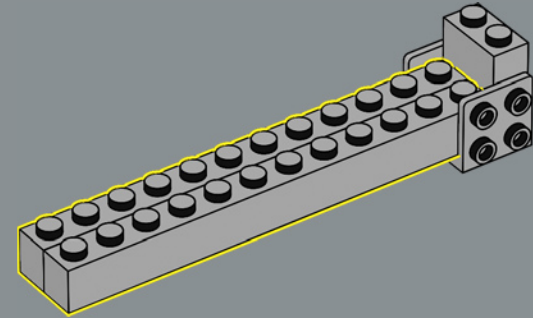

57

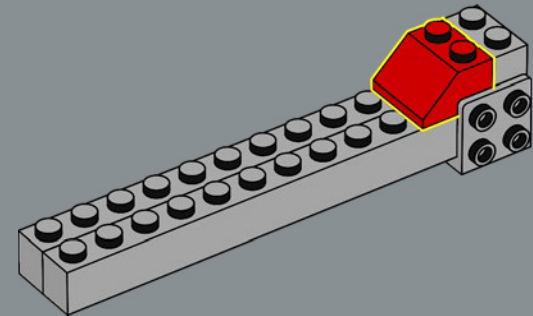



2x

58

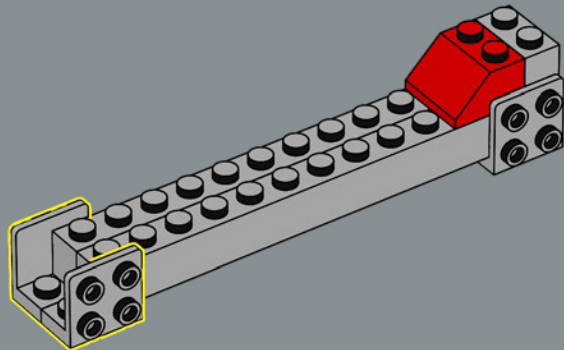

1x

59

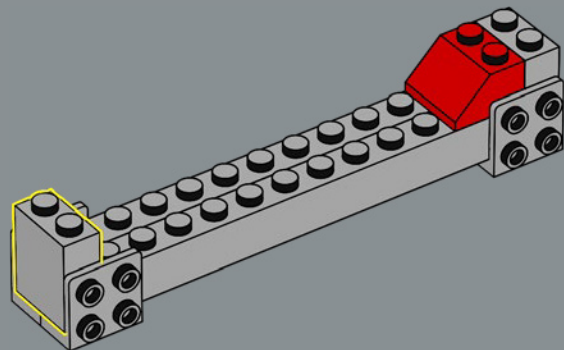

1x

60

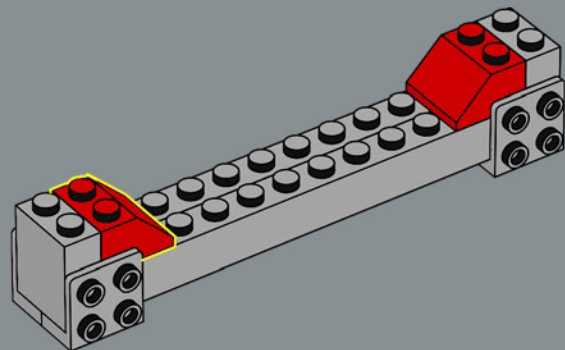

4x

61

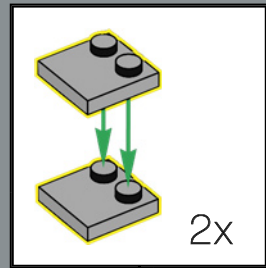

2x

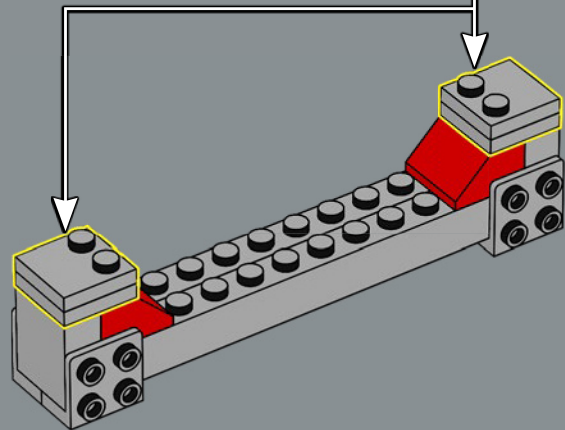

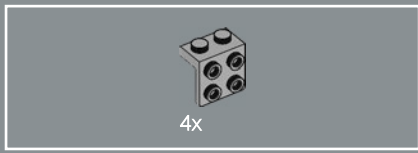

62

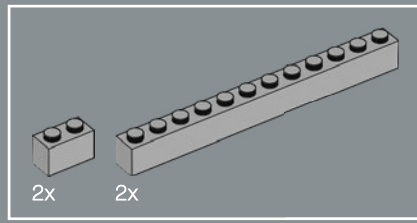
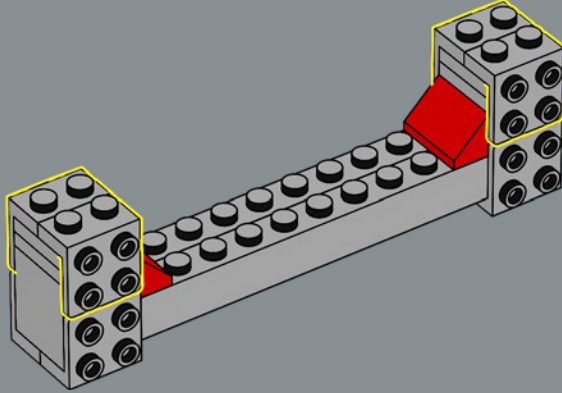

64

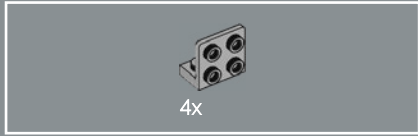
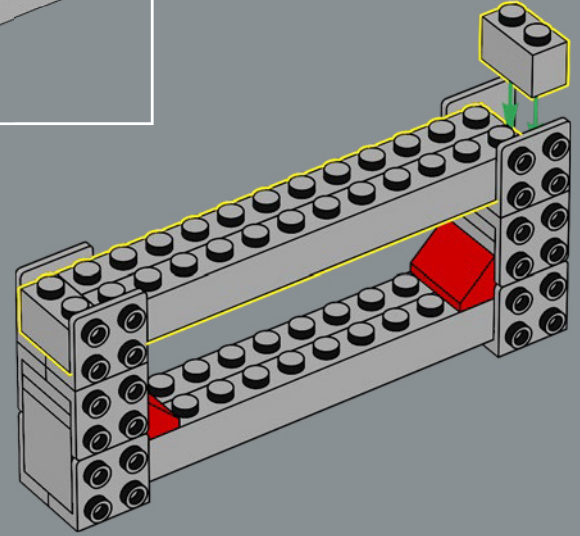

63

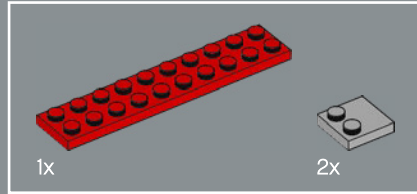
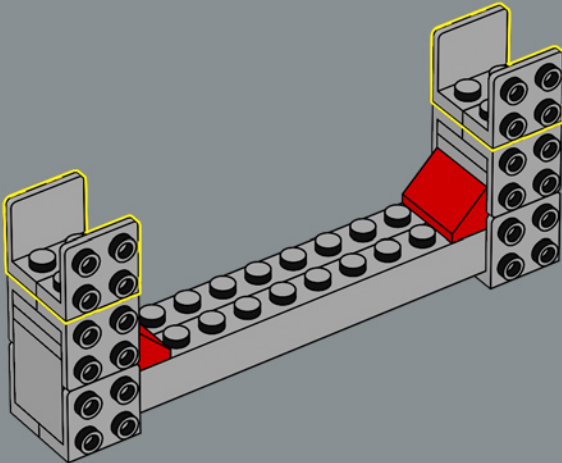

65

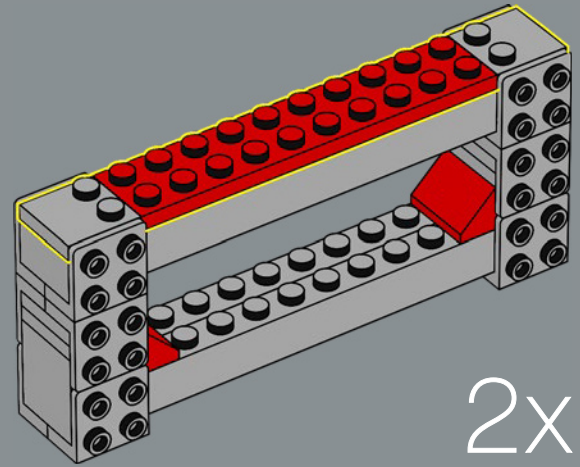

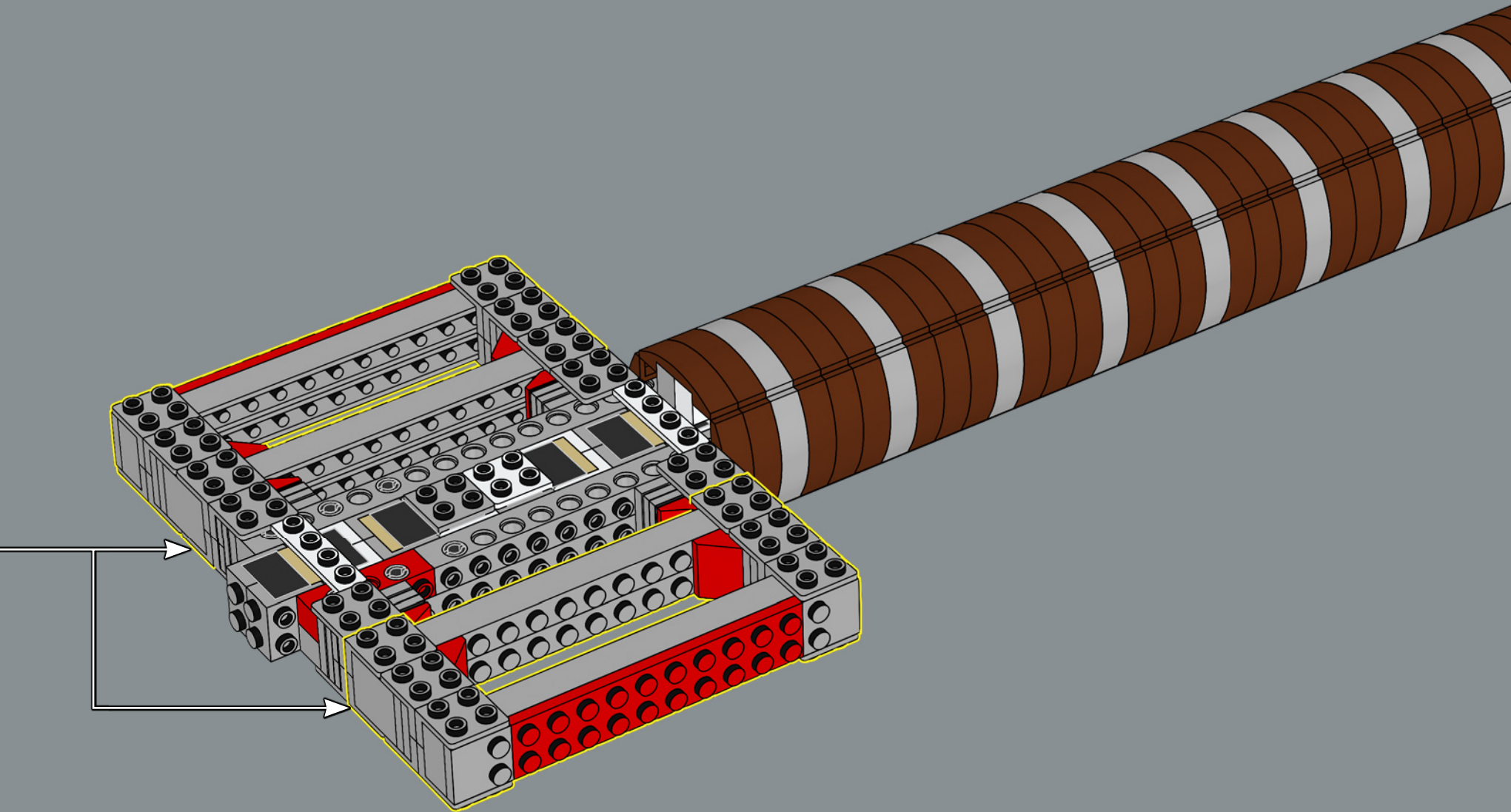

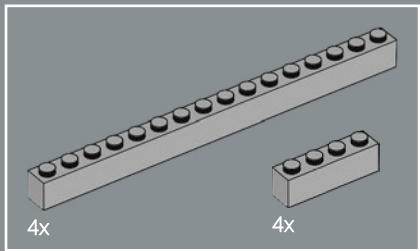
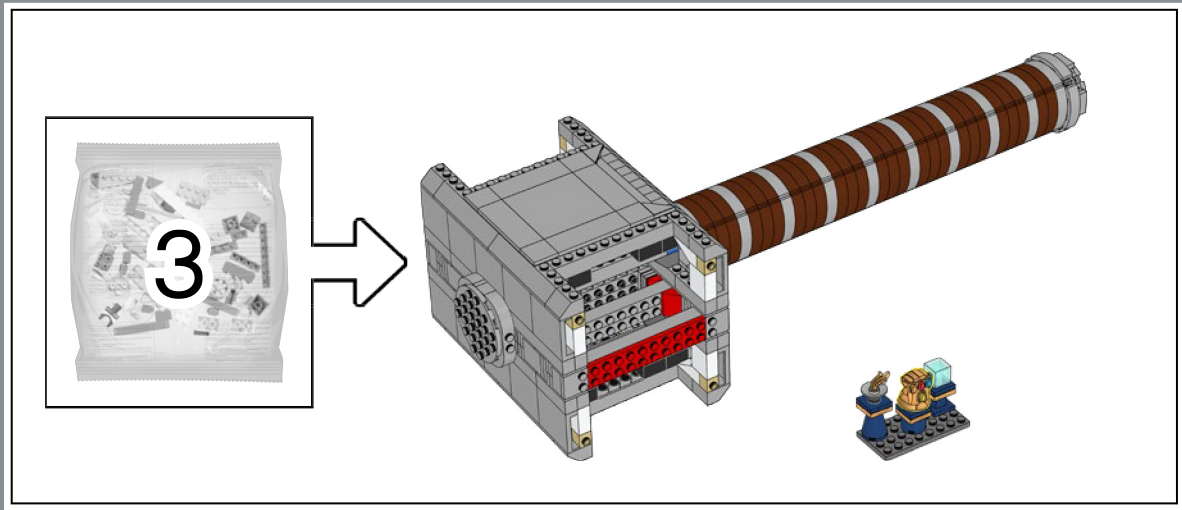

67

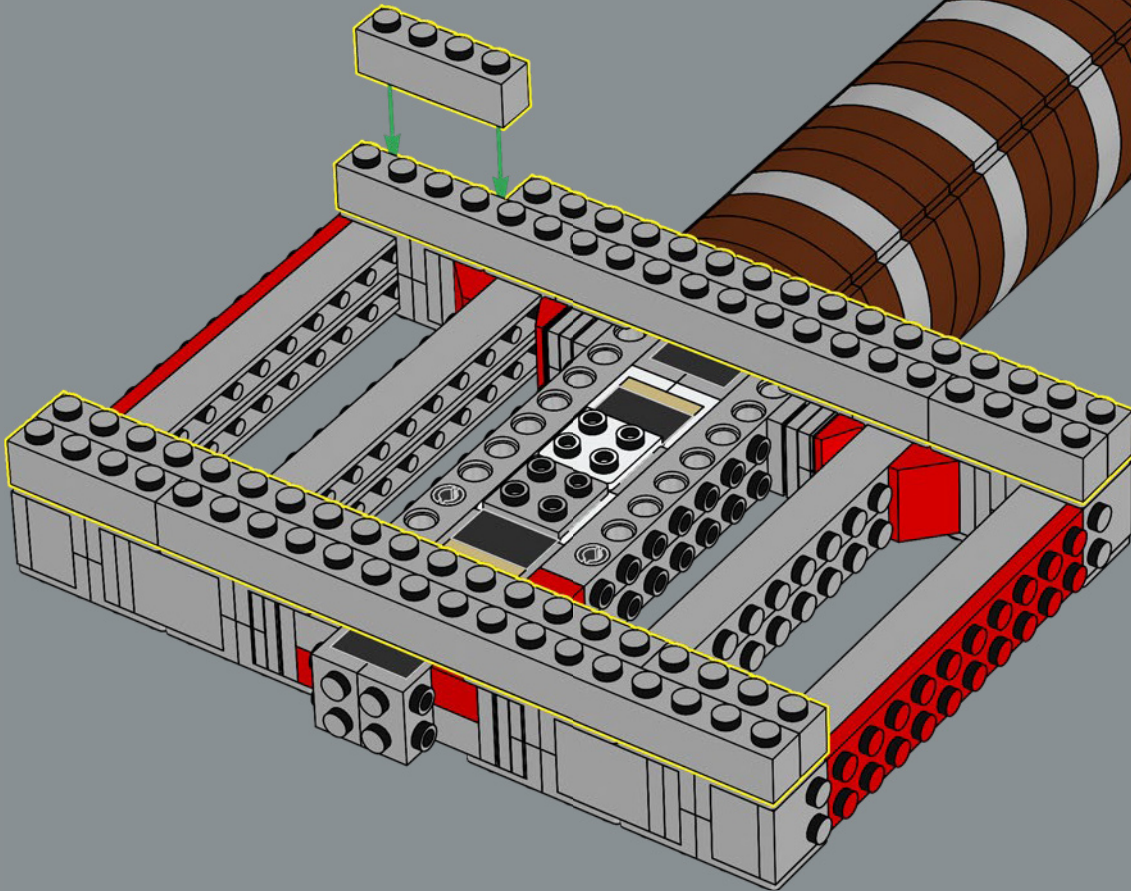

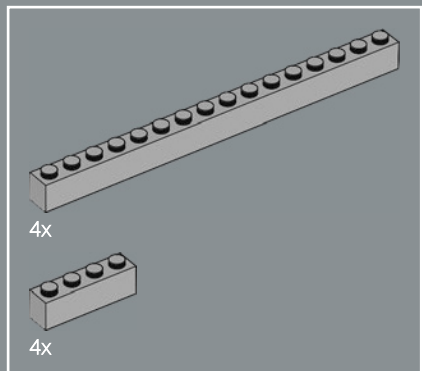

68

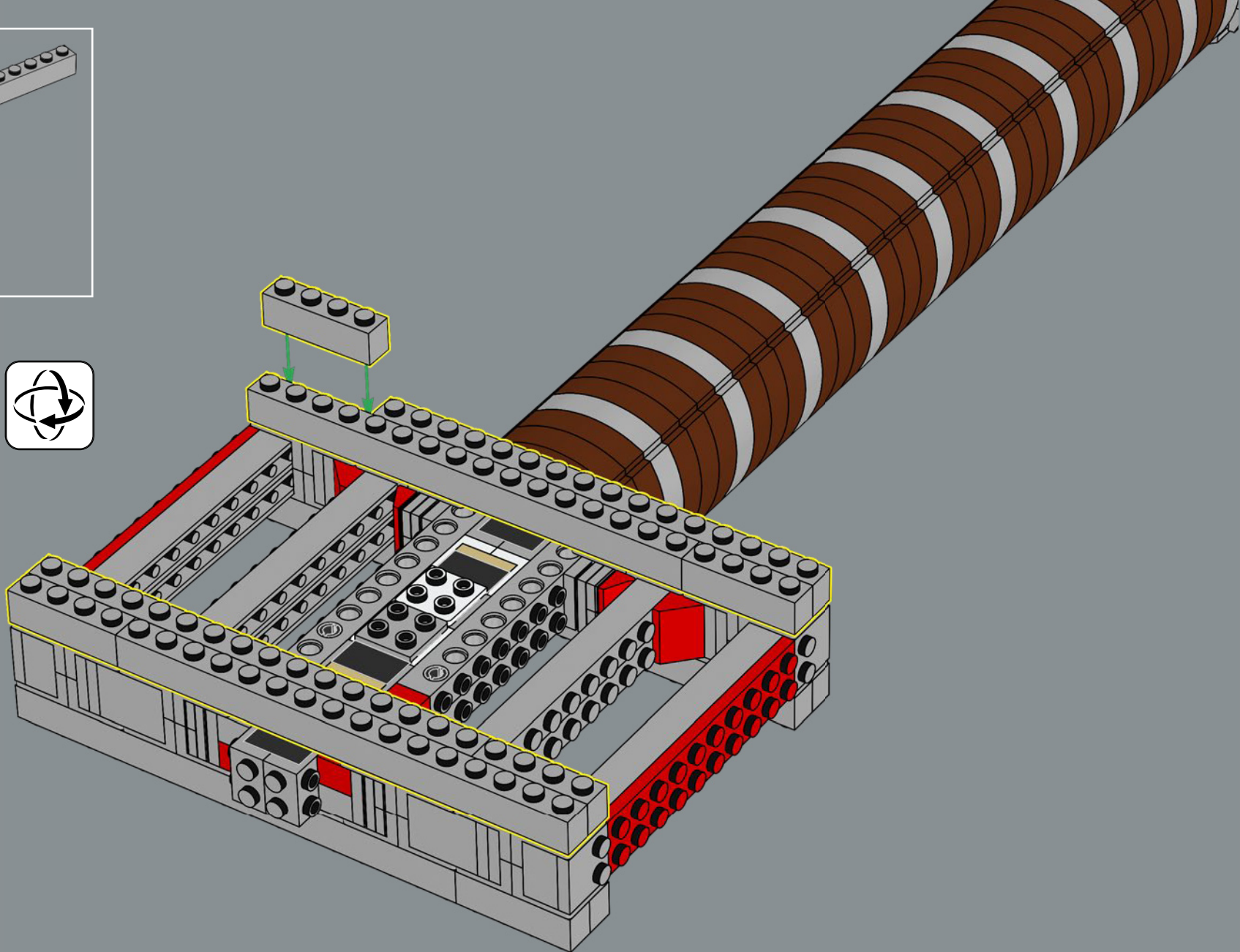

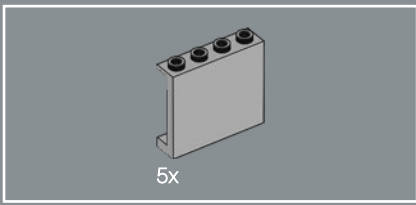

69

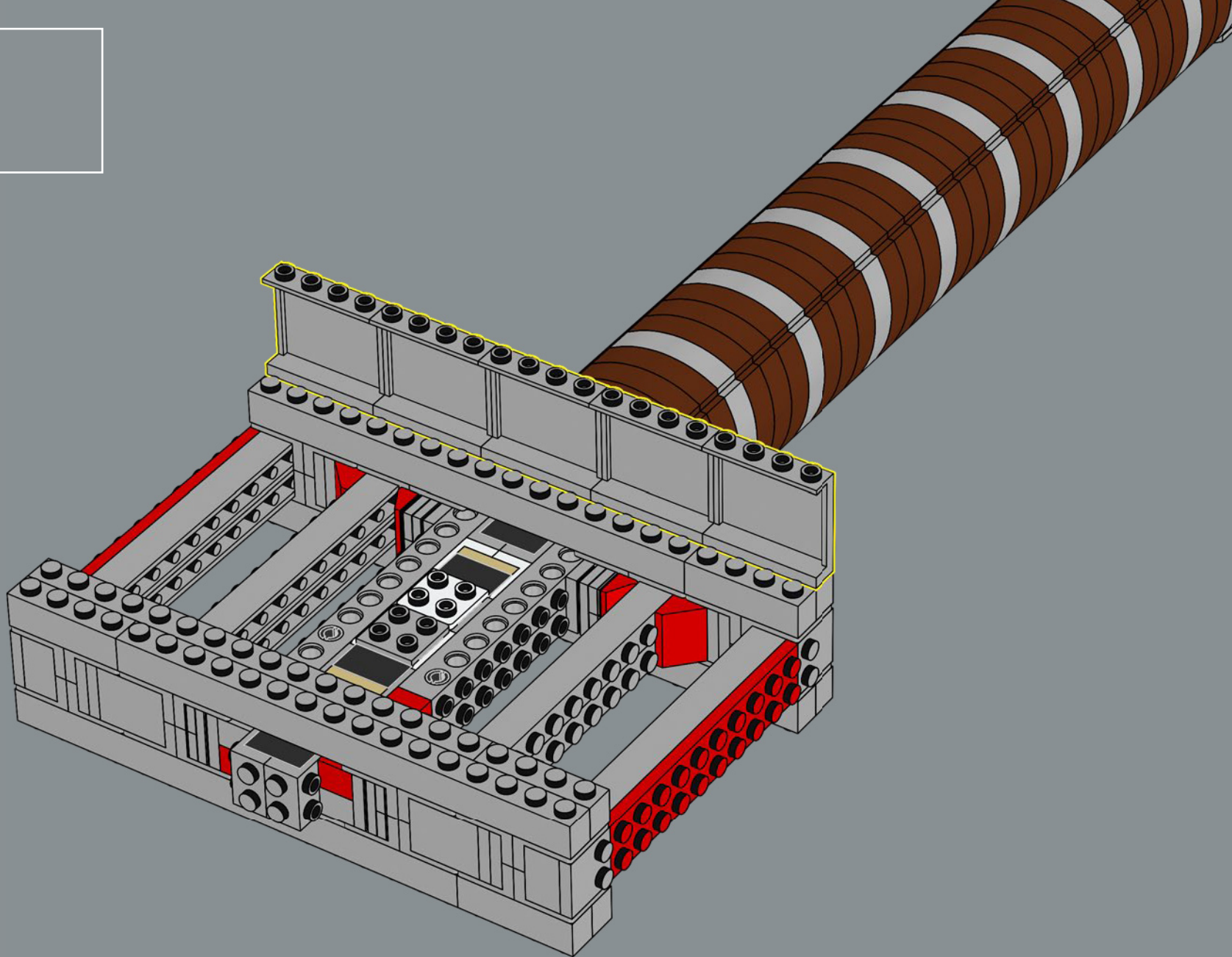

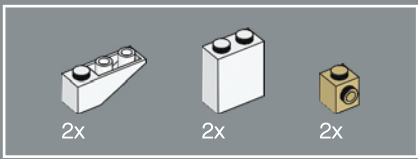

70

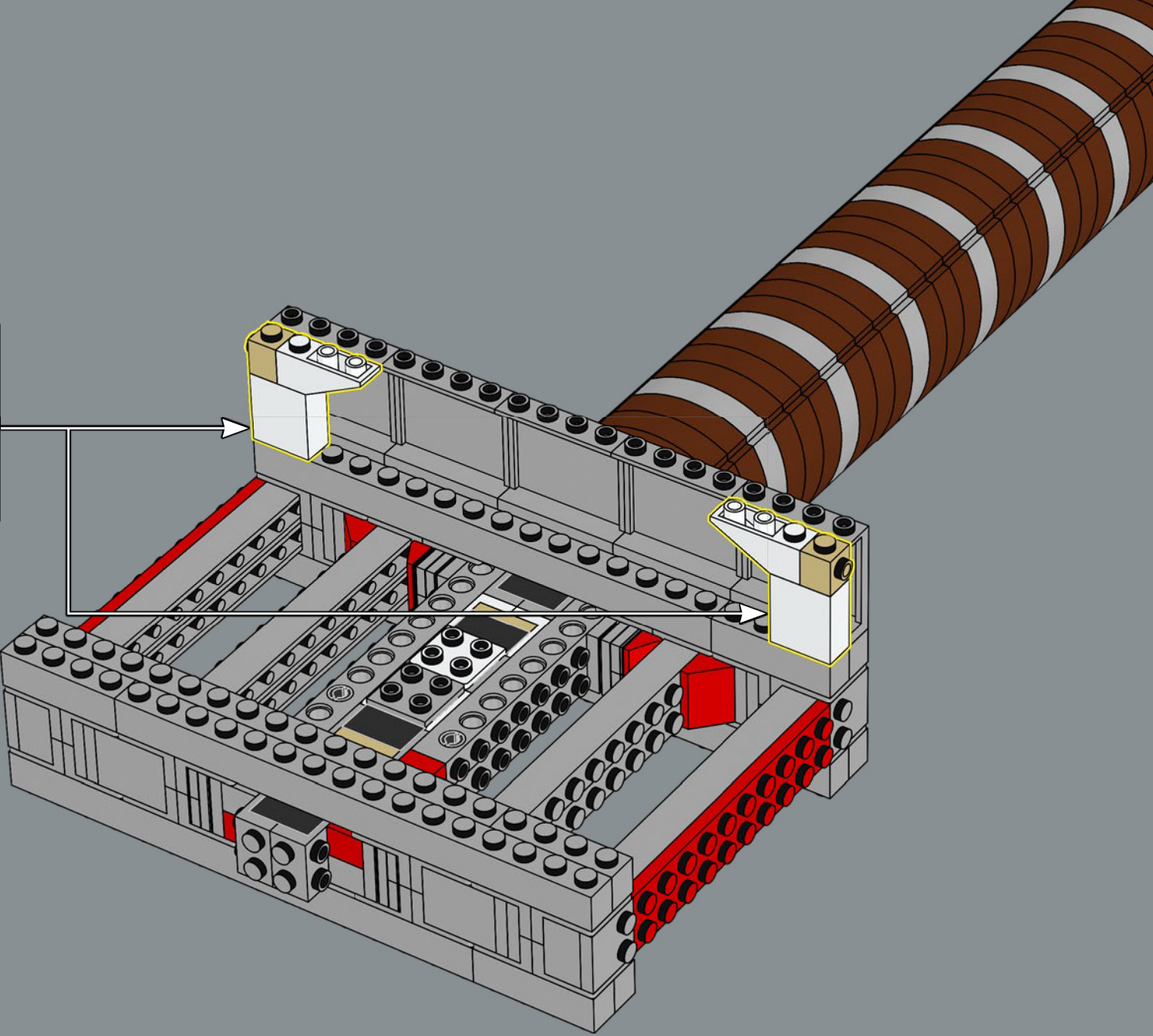
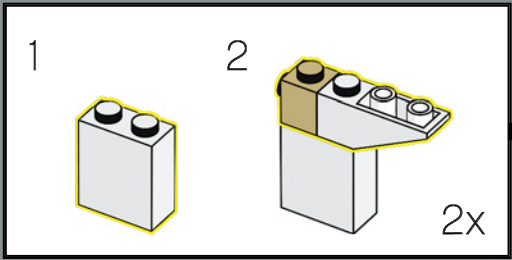



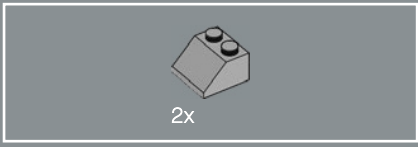

71

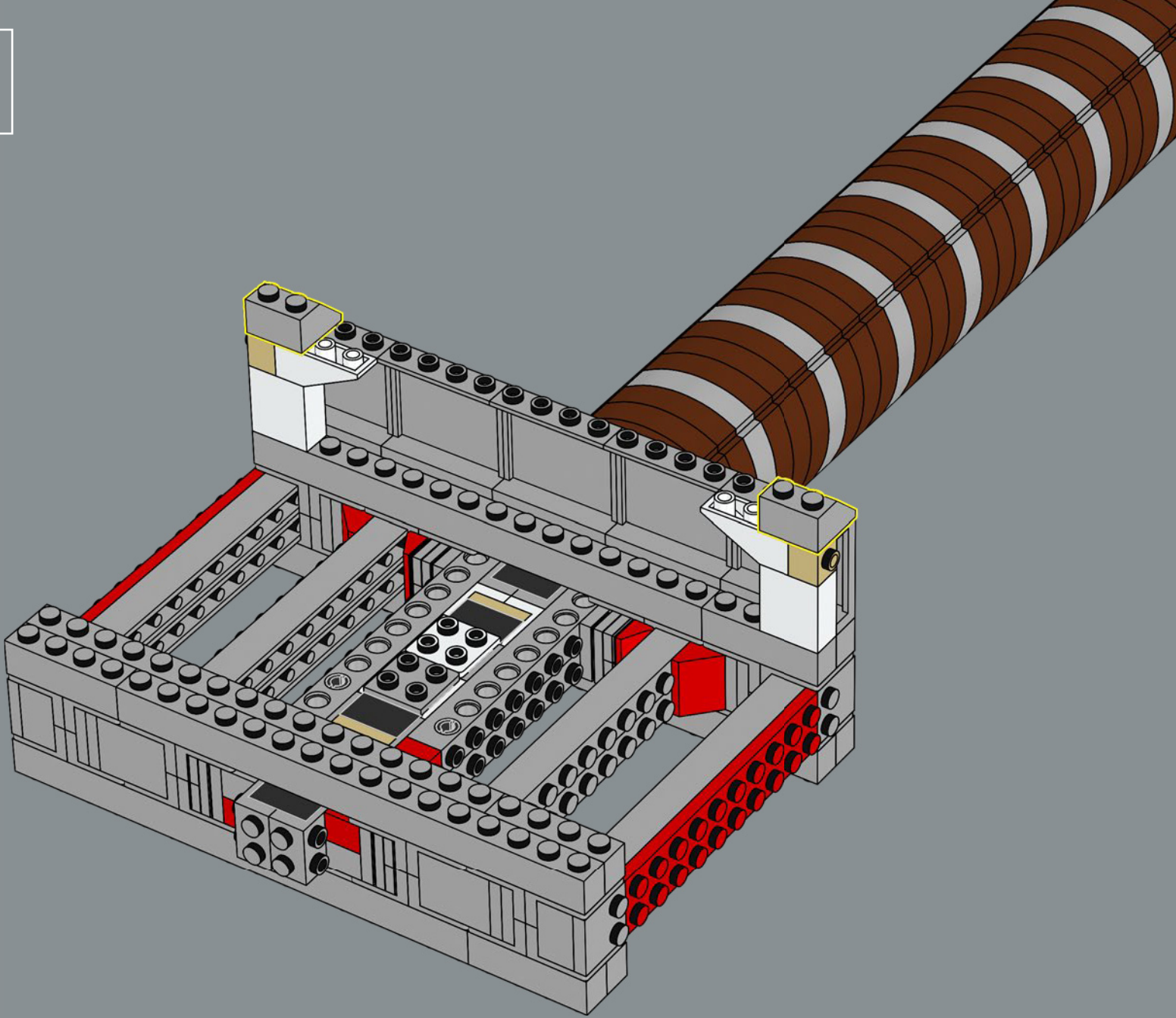

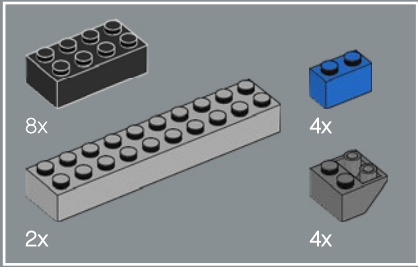
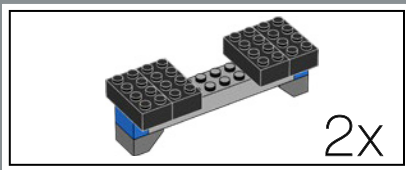

72

1

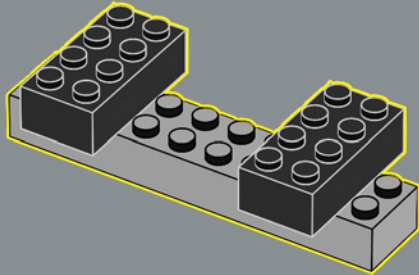

2

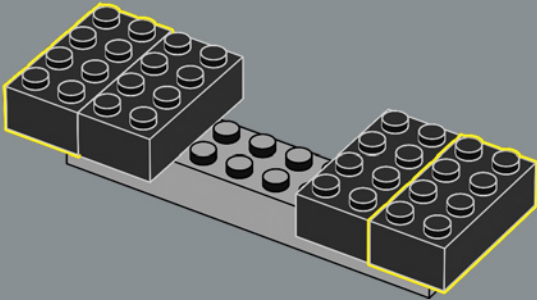

3

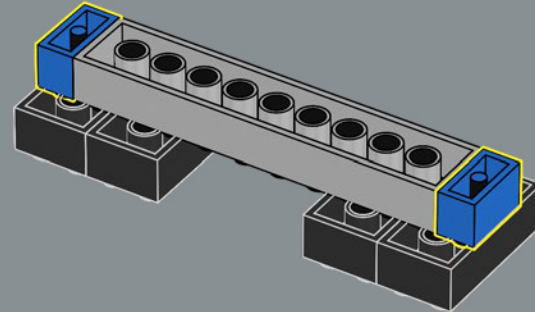

4

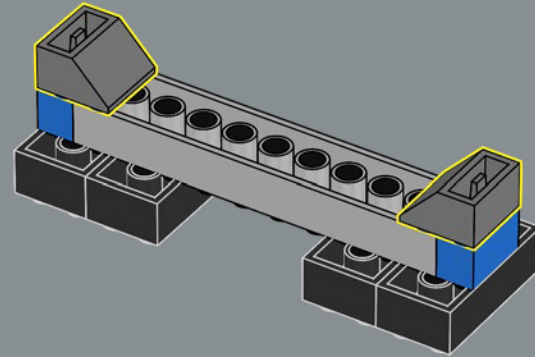

2x

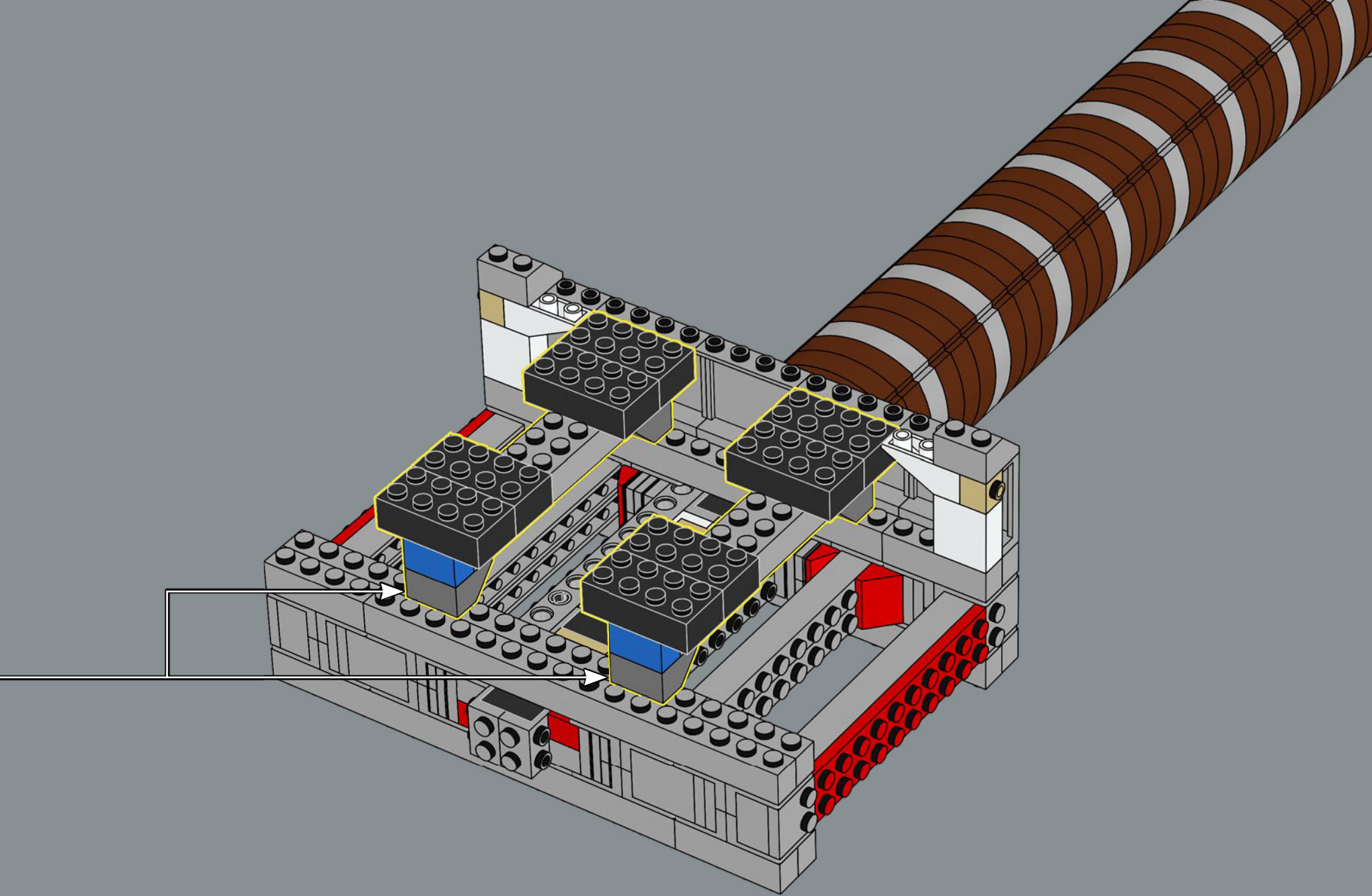

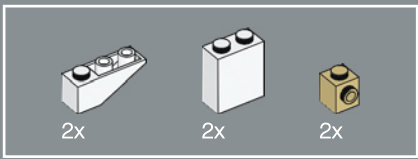

73

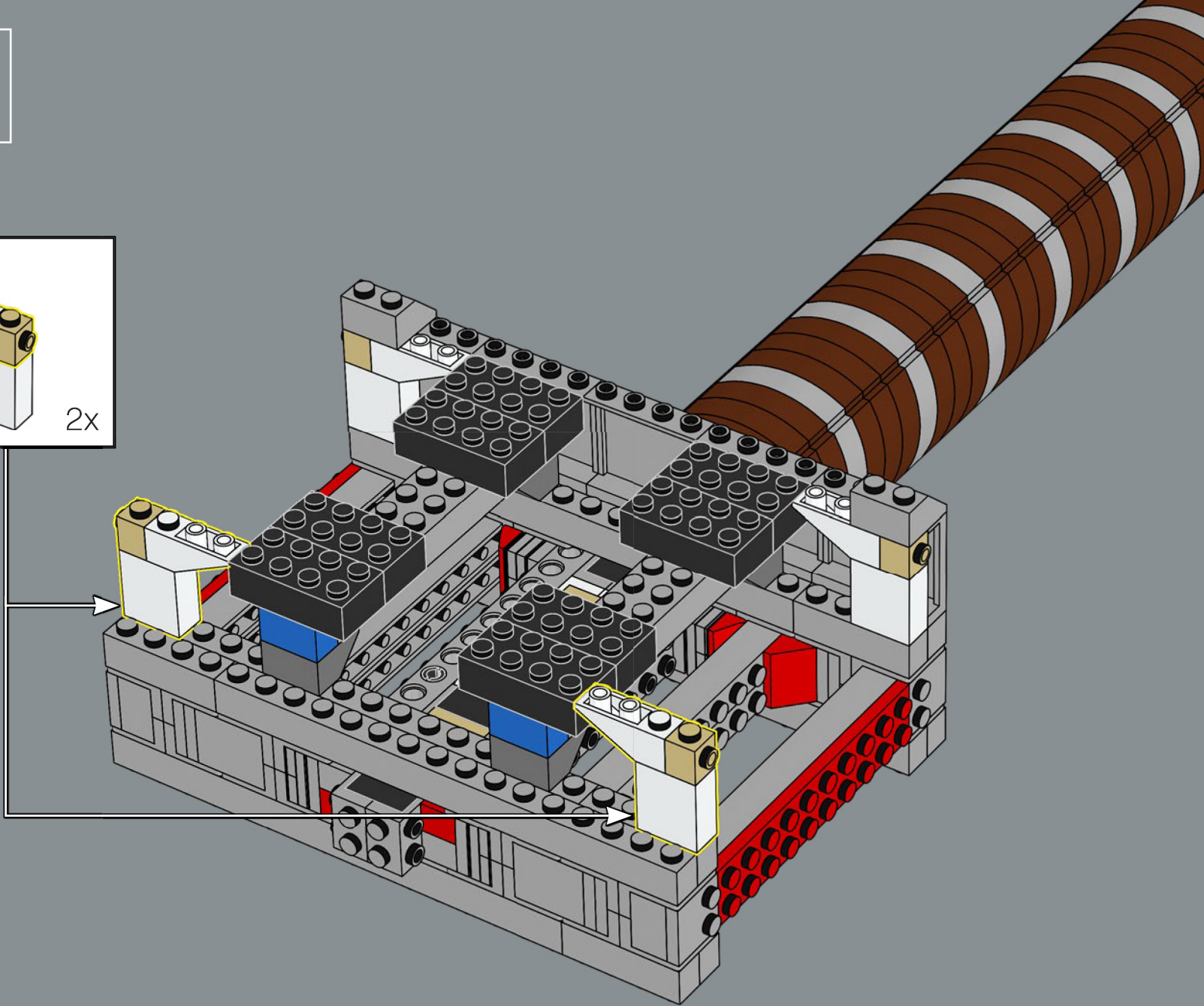
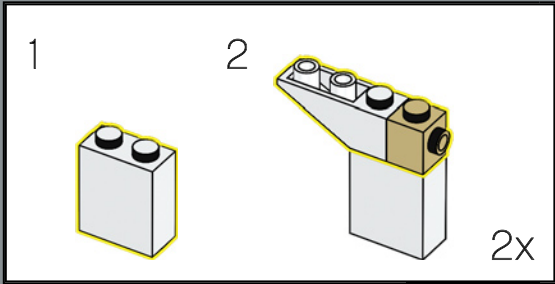

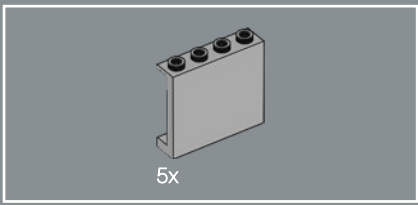

74

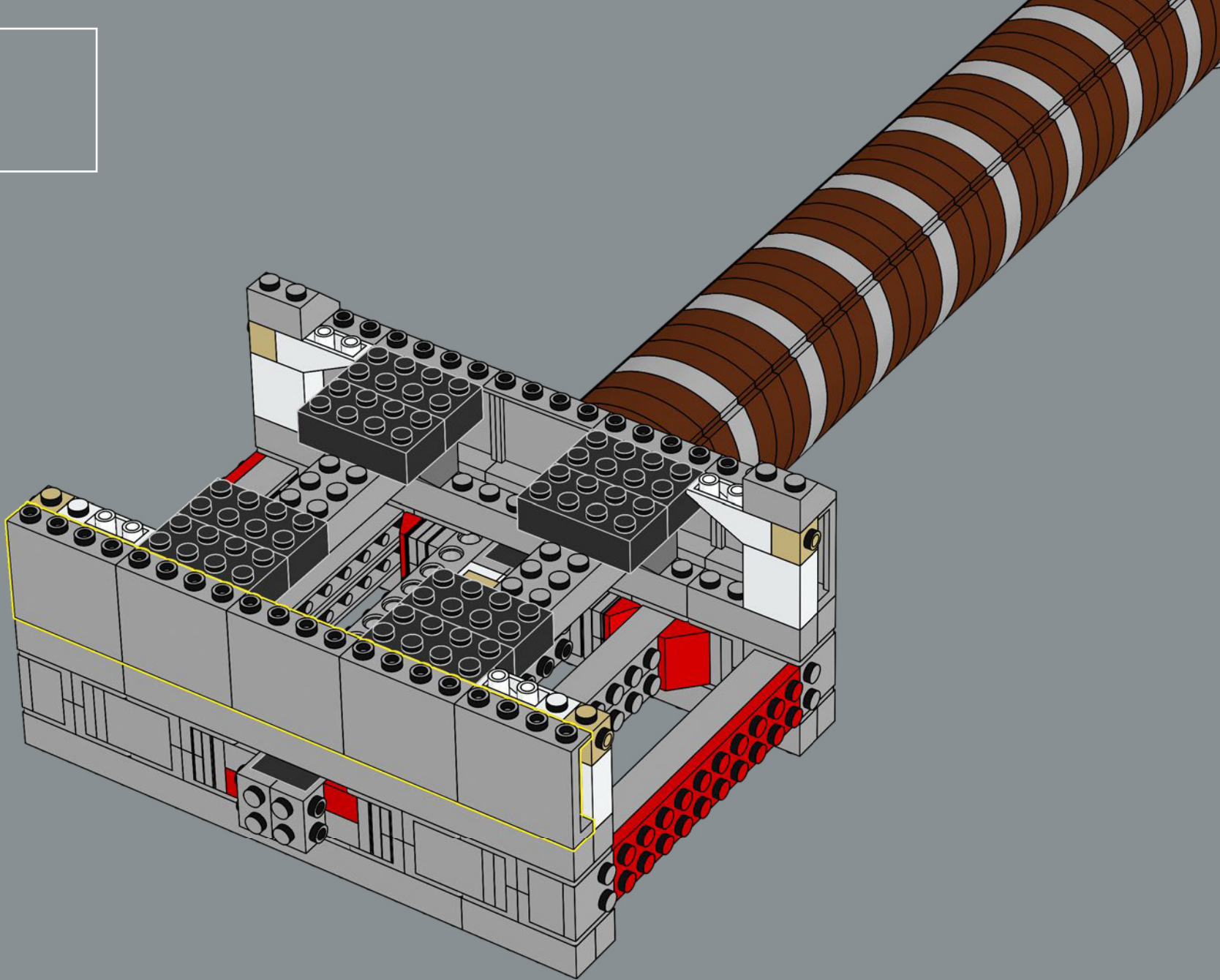

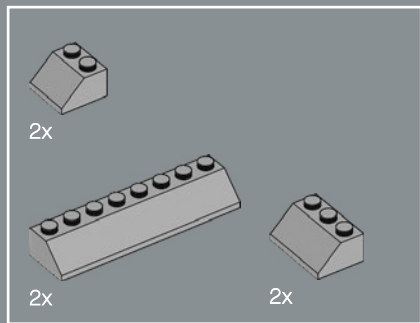

75

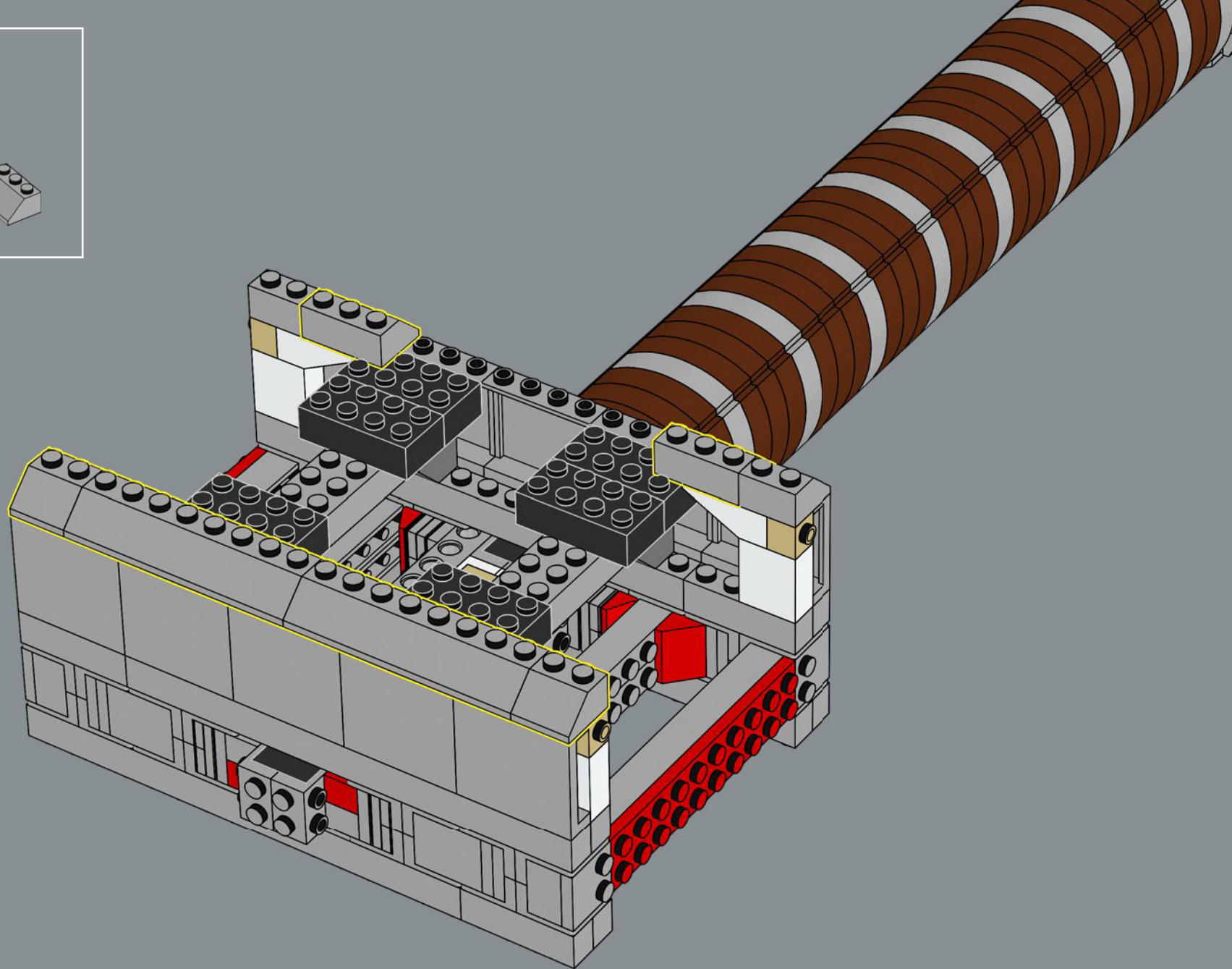

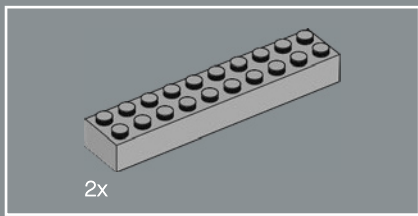

76

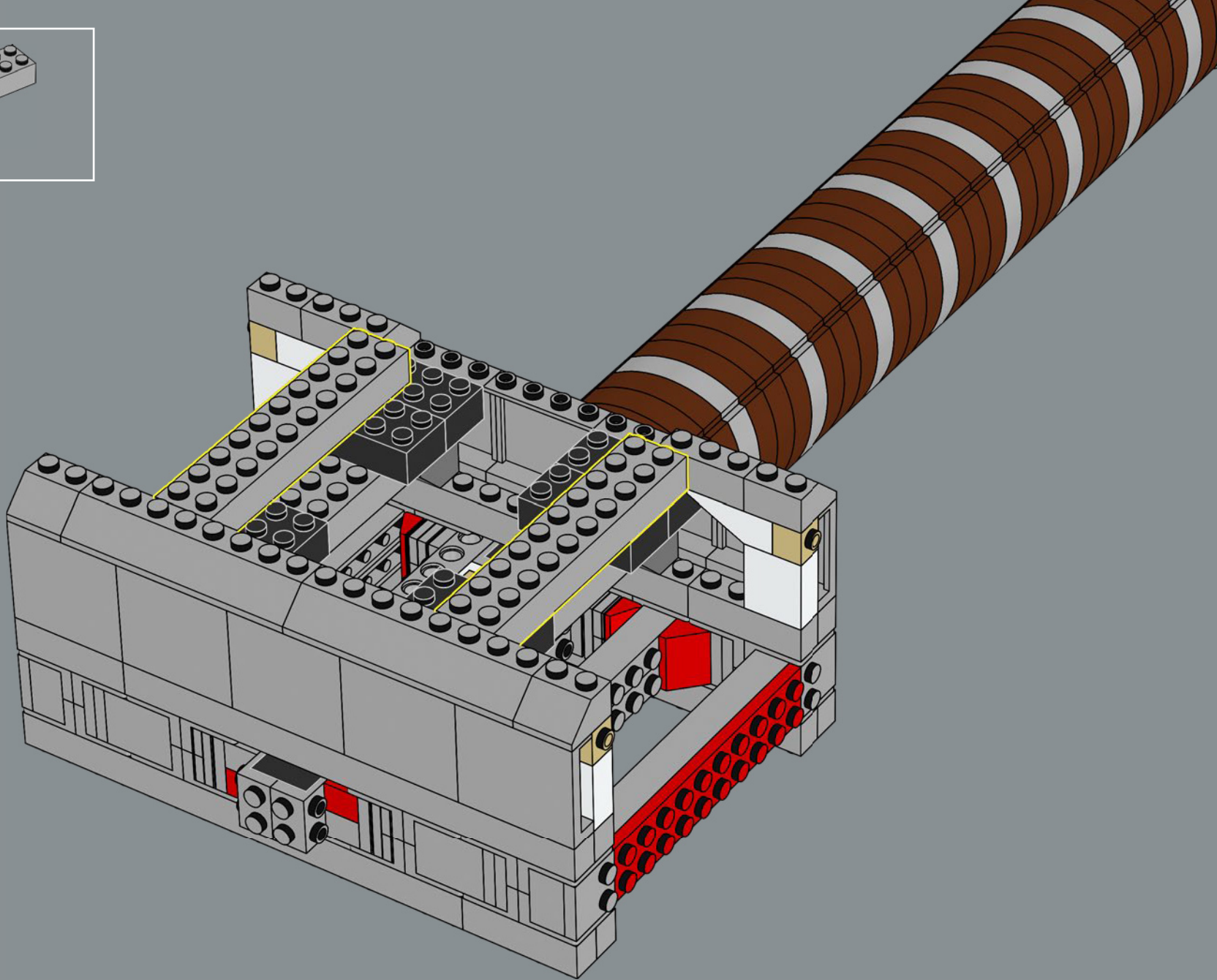

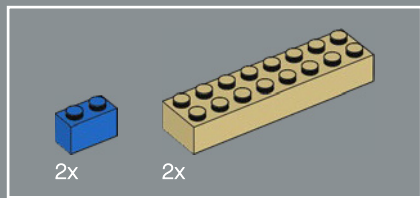

77

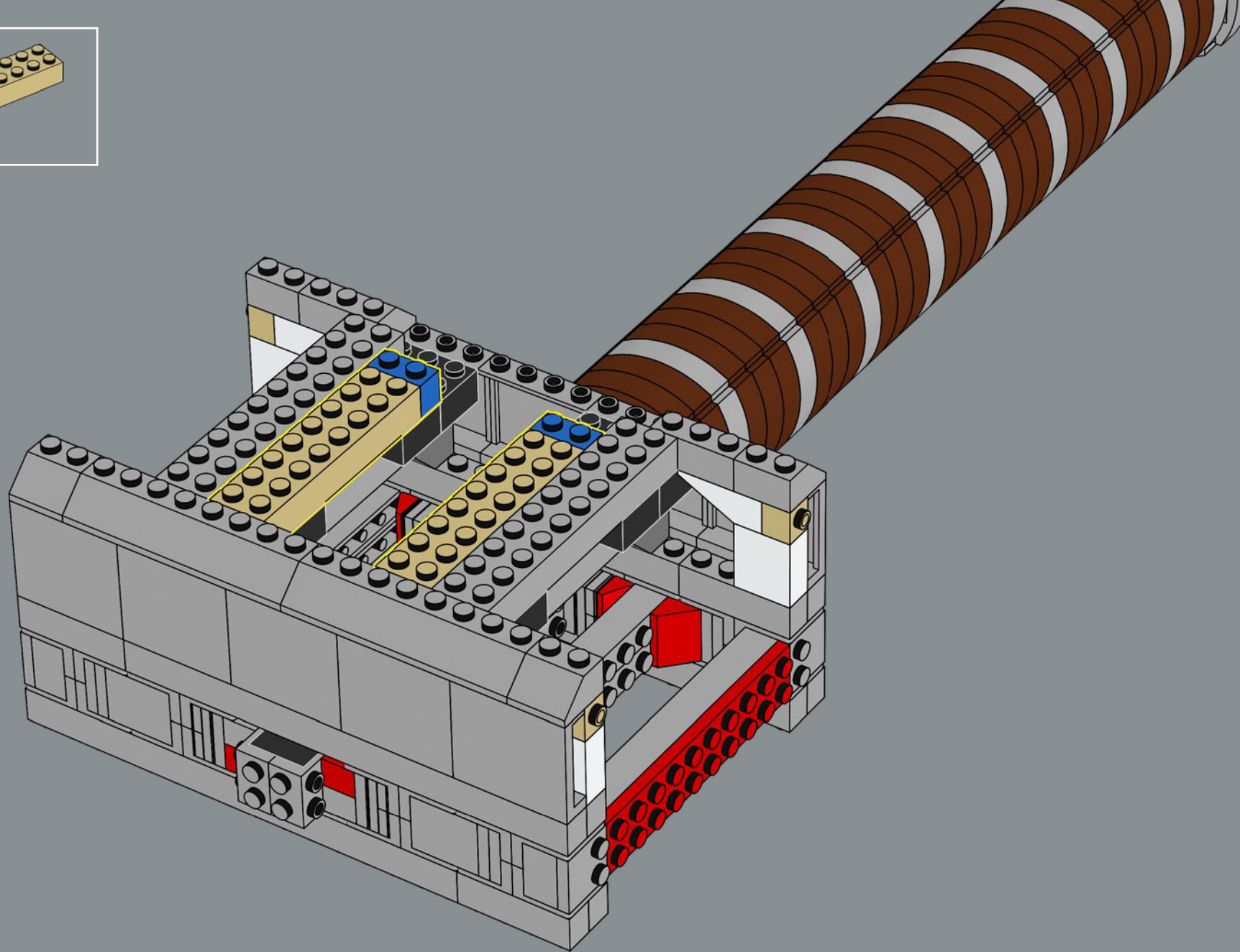



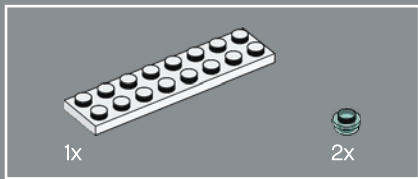

78

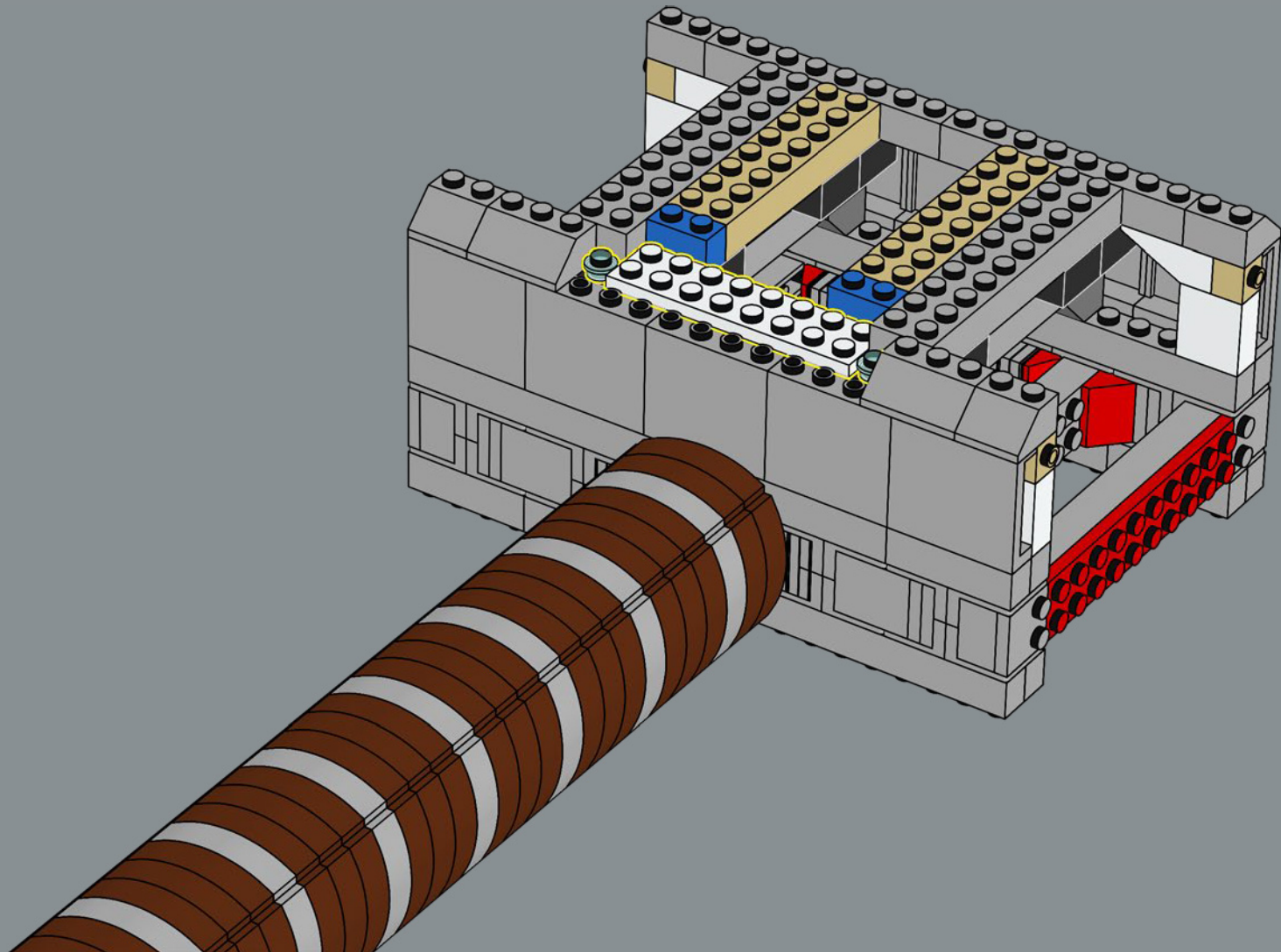

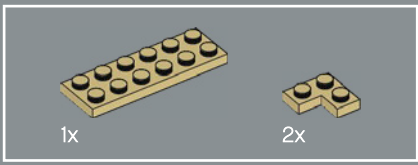

79

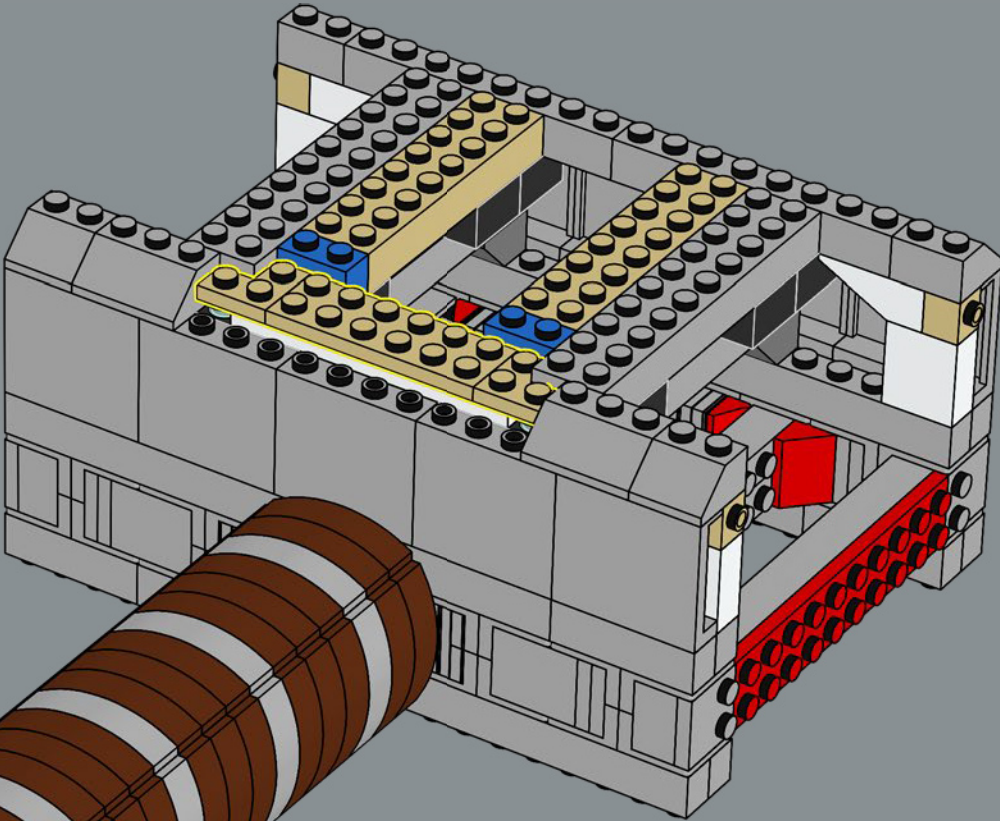

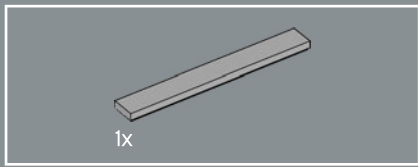

80

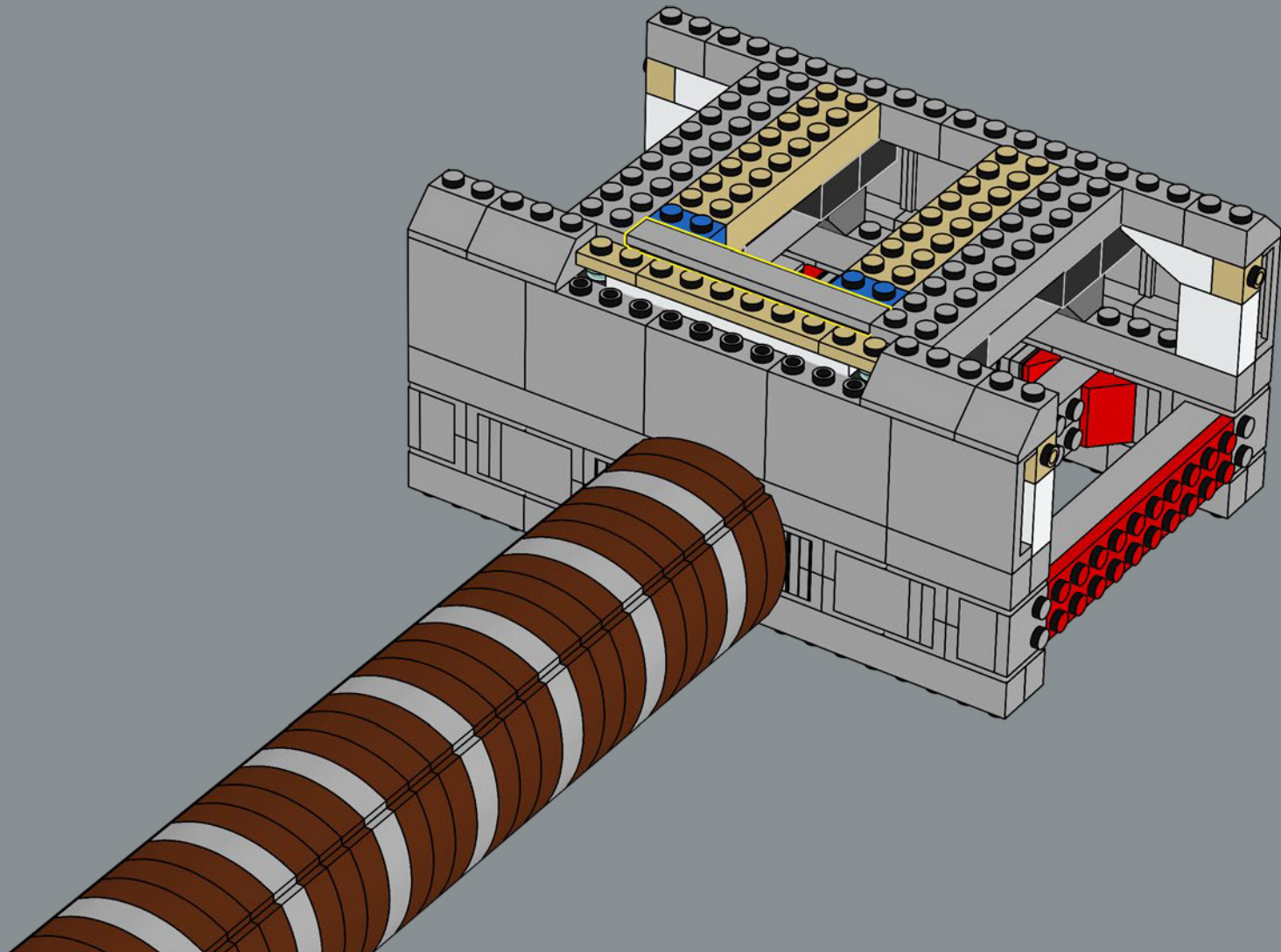



10x

81

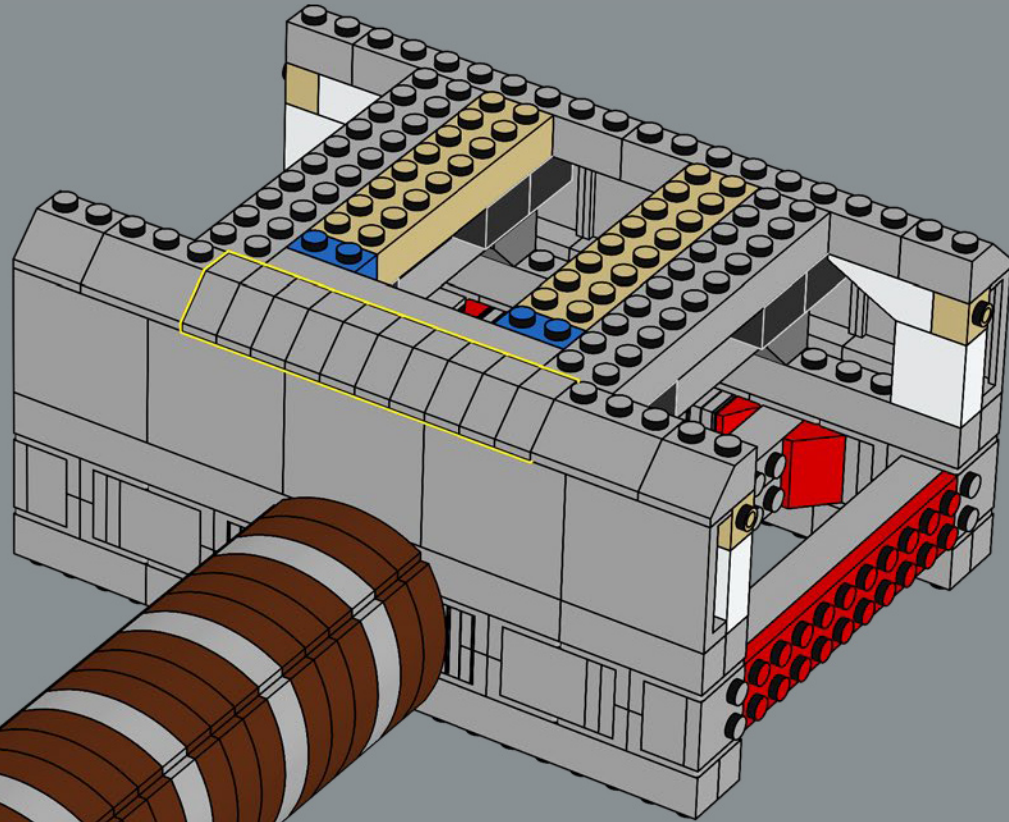

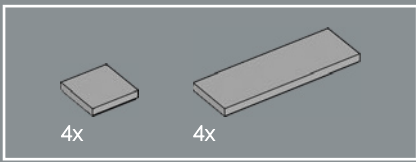

82

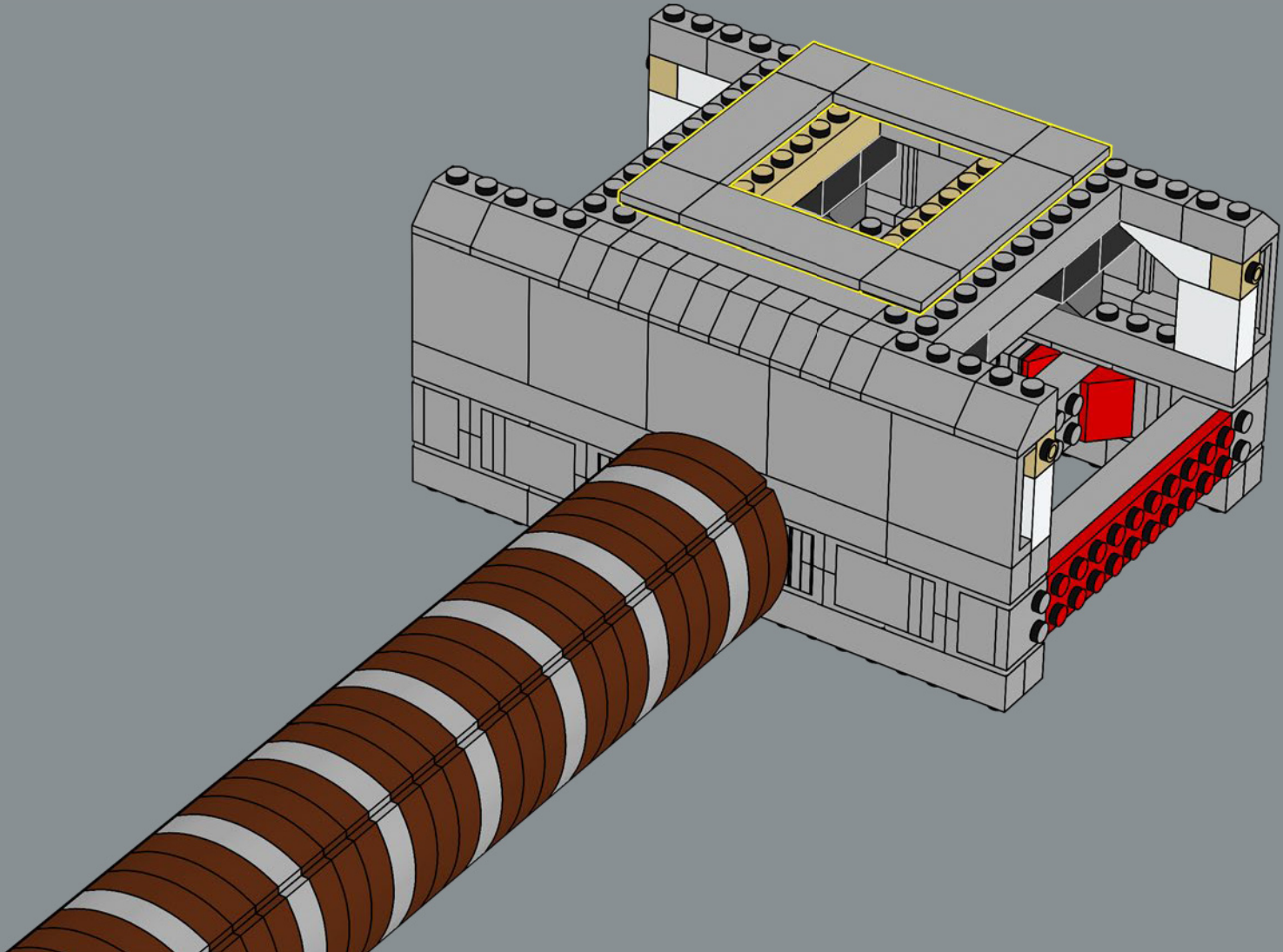

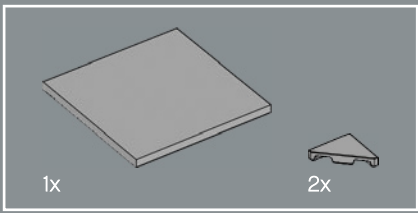

83

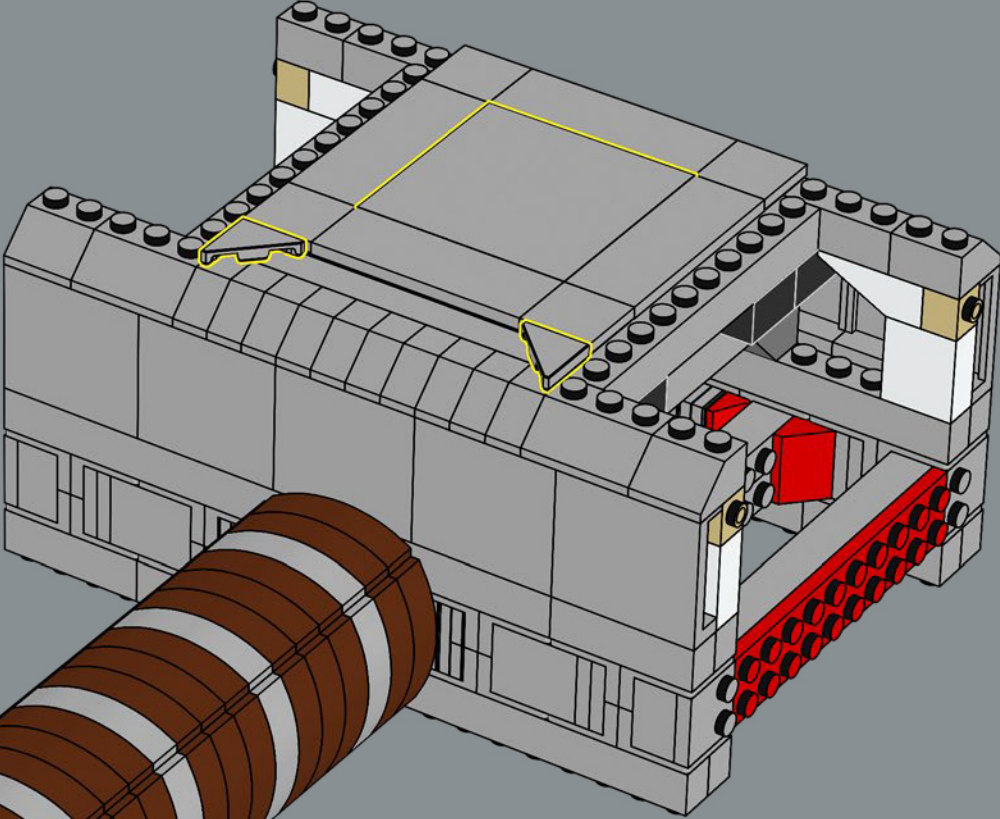

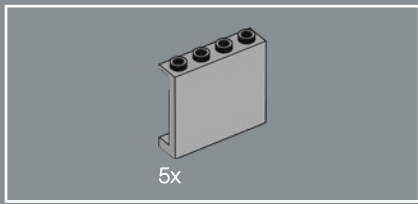

84

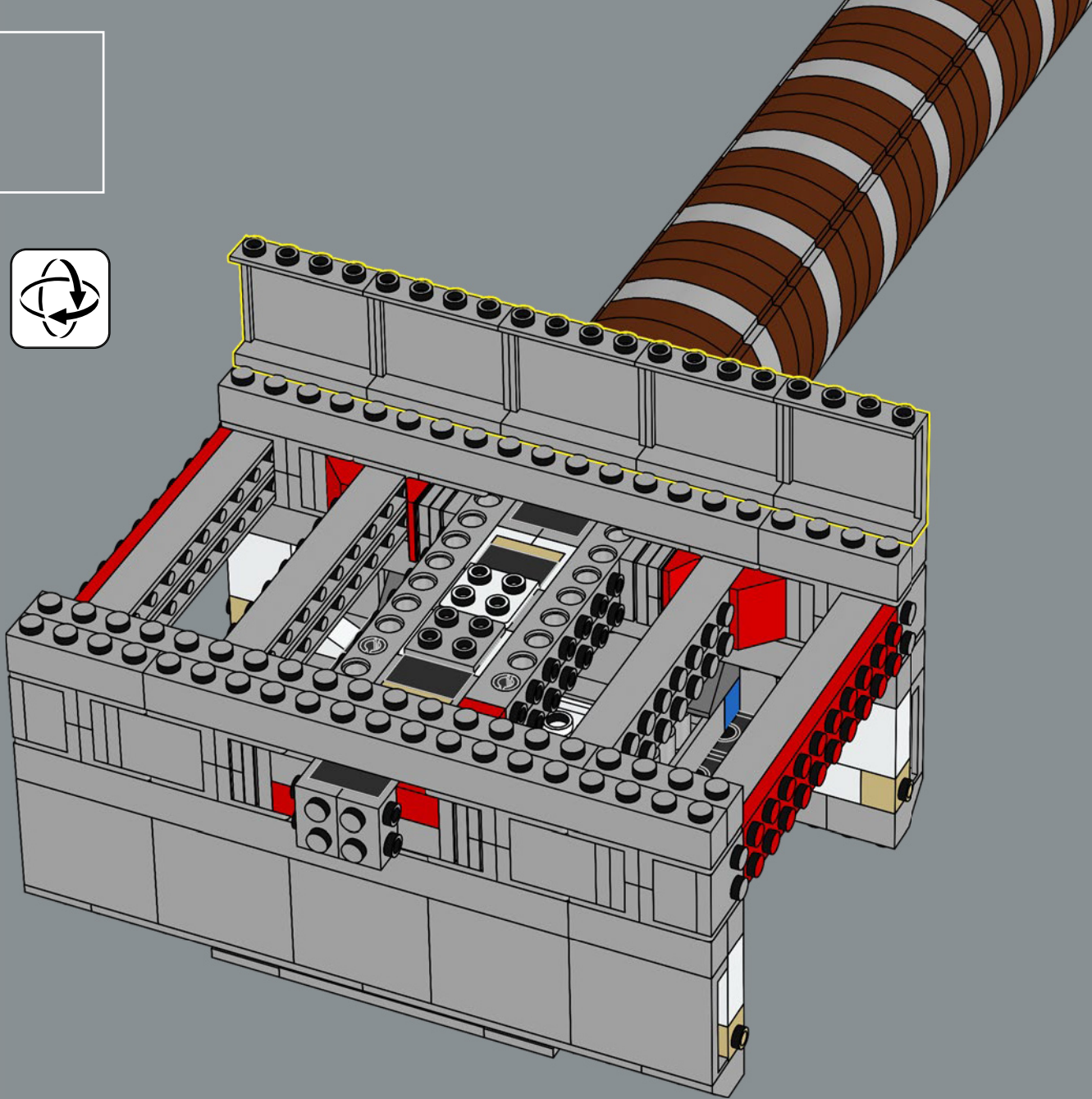

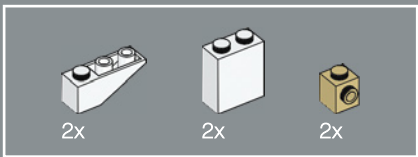

85

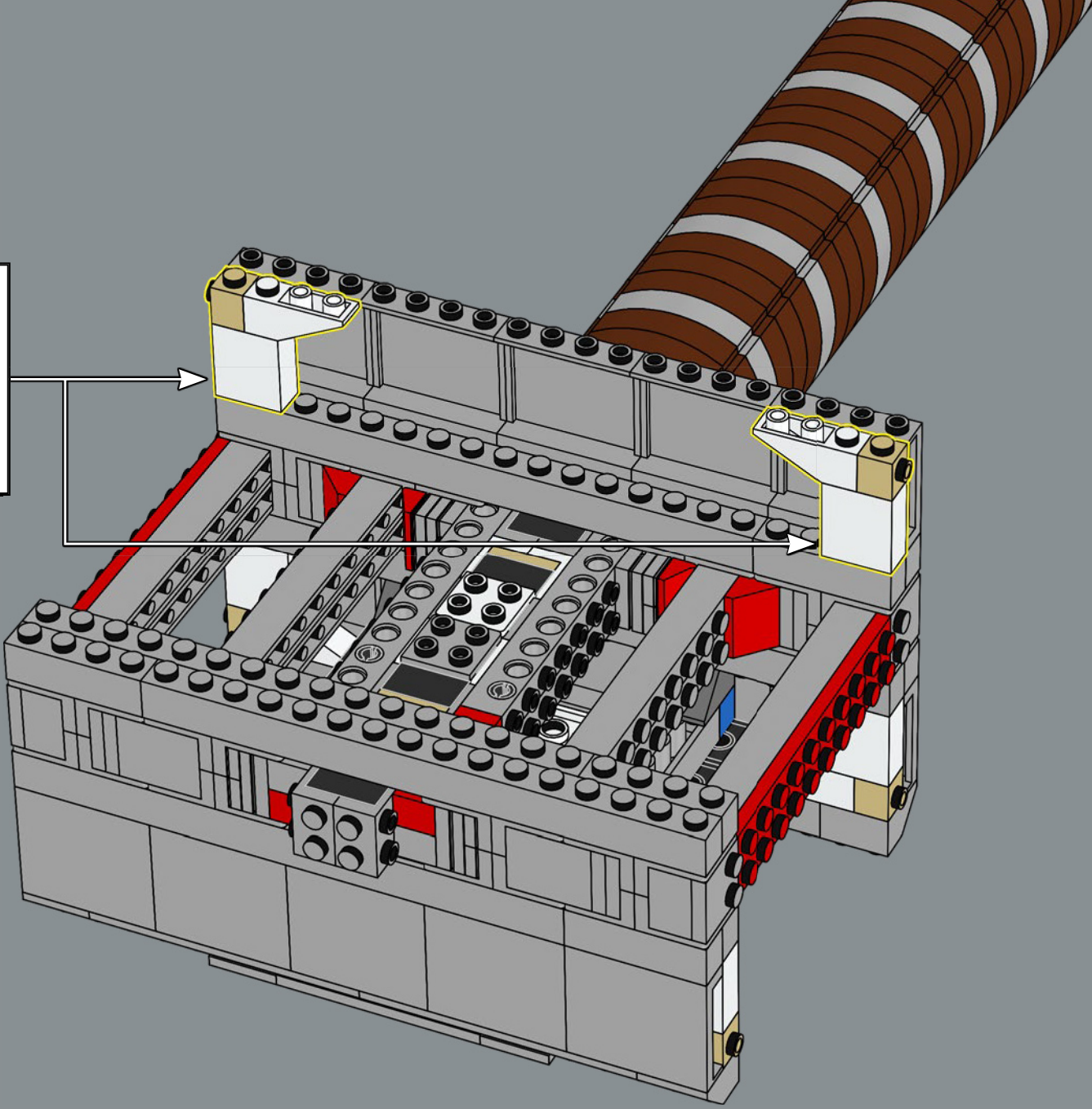
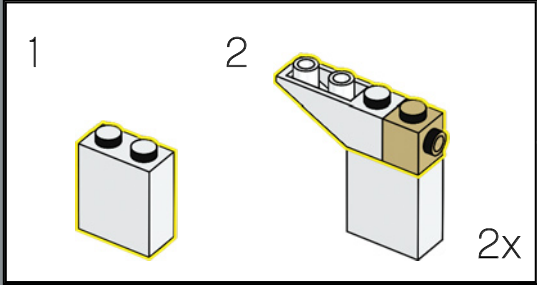



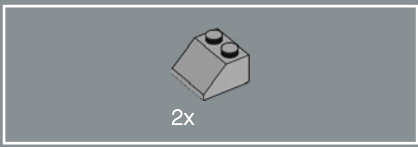

86

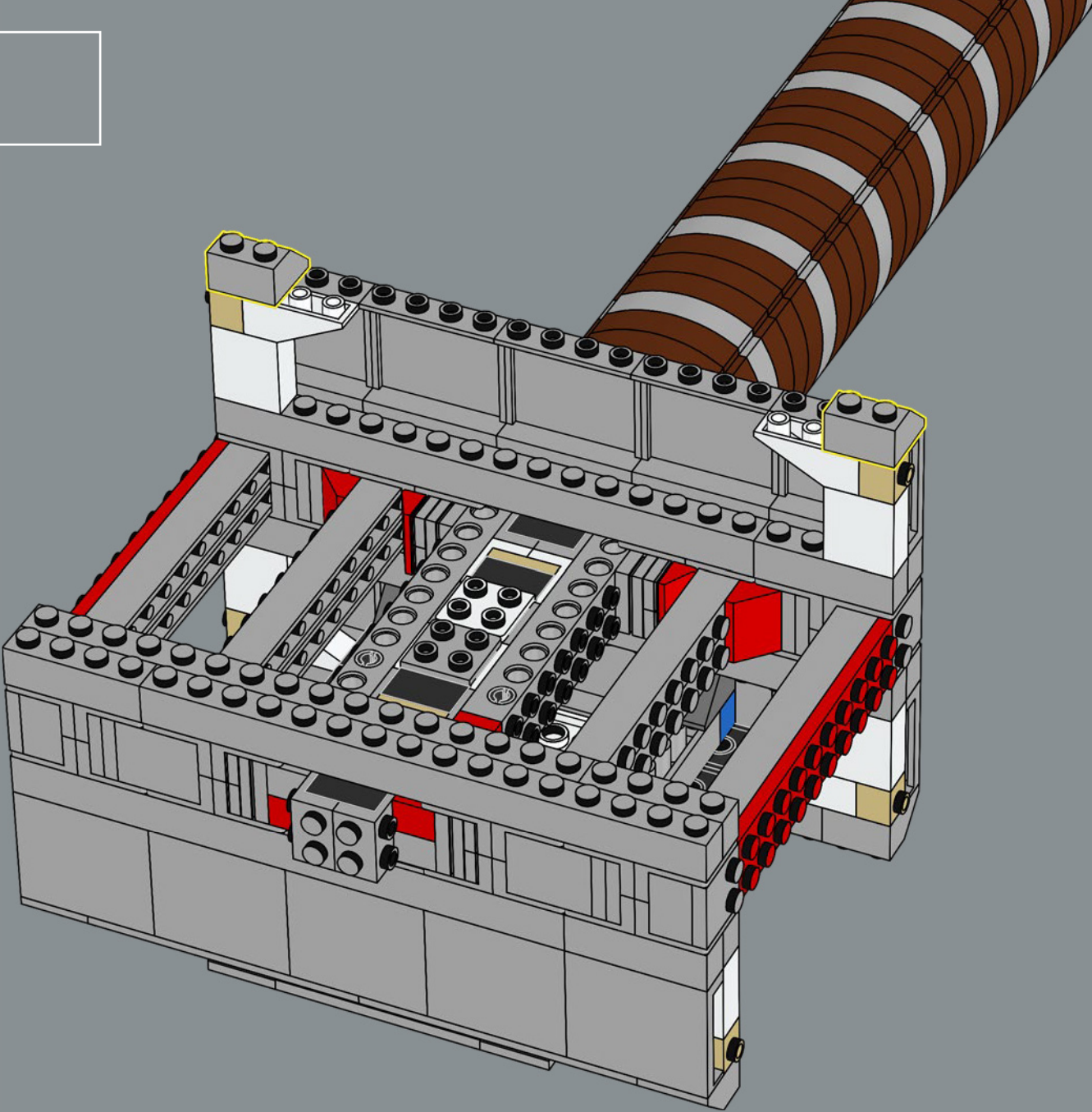

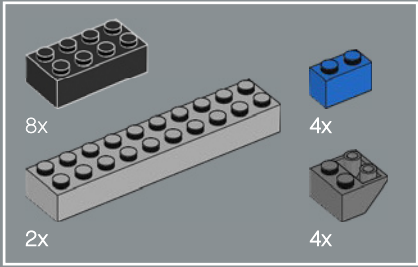
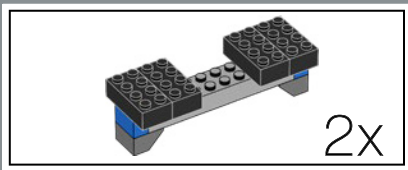

87

1

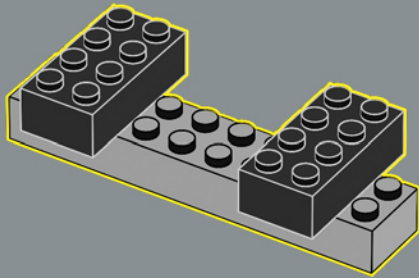

2

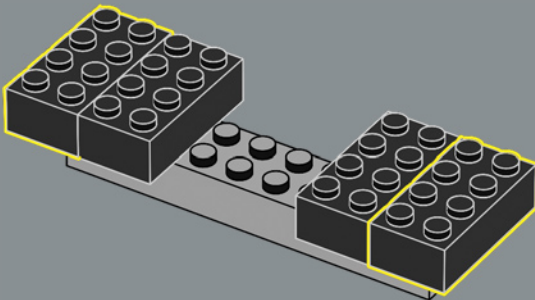

3

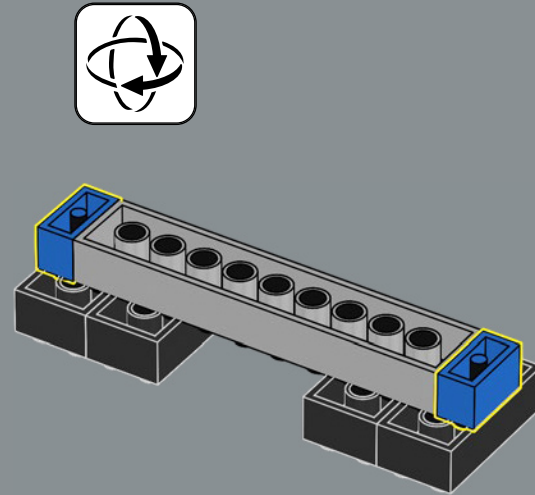

4

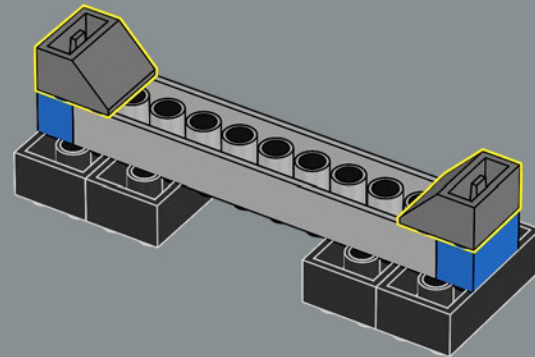

2x

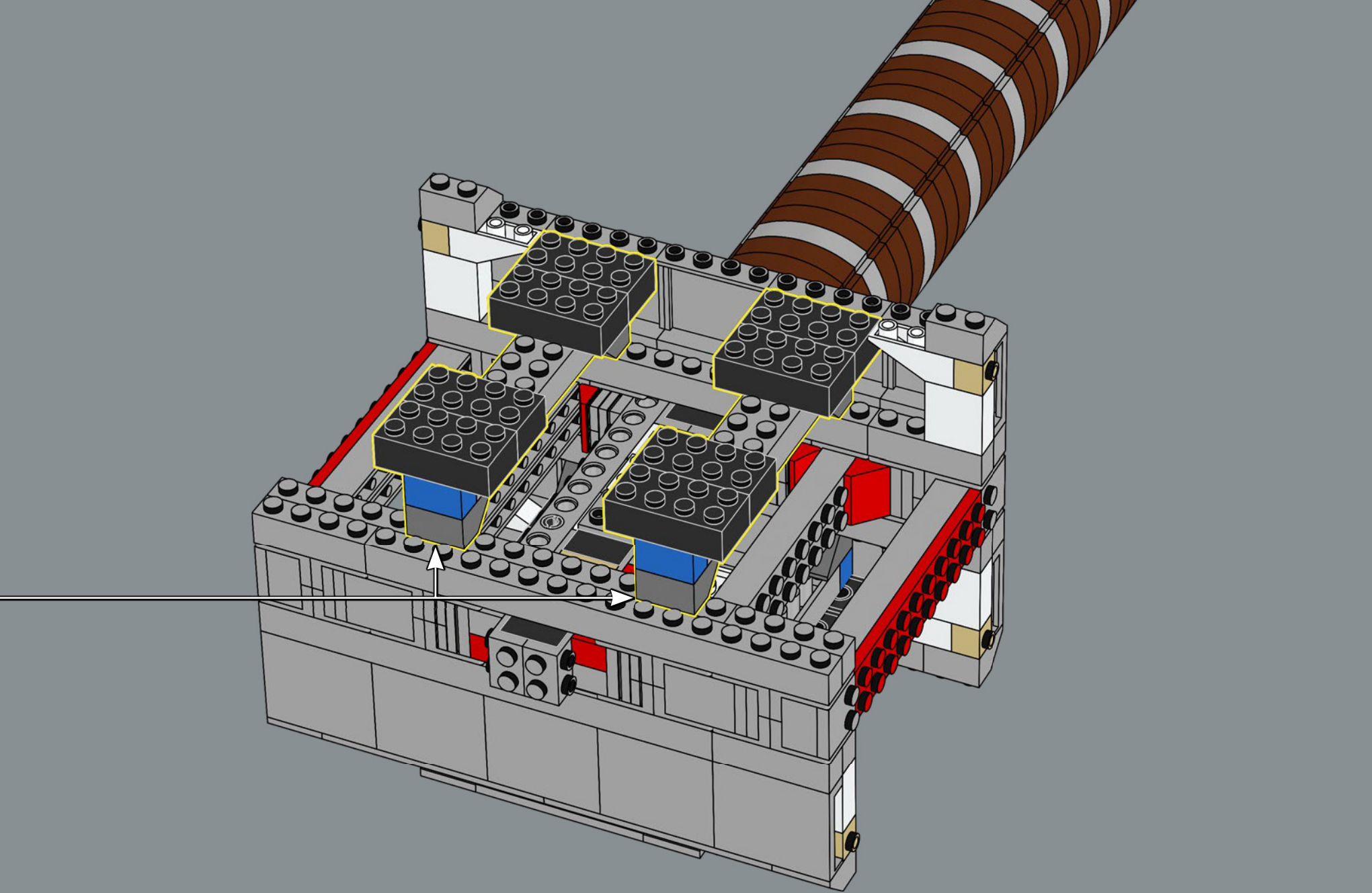

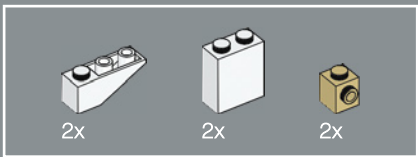

88

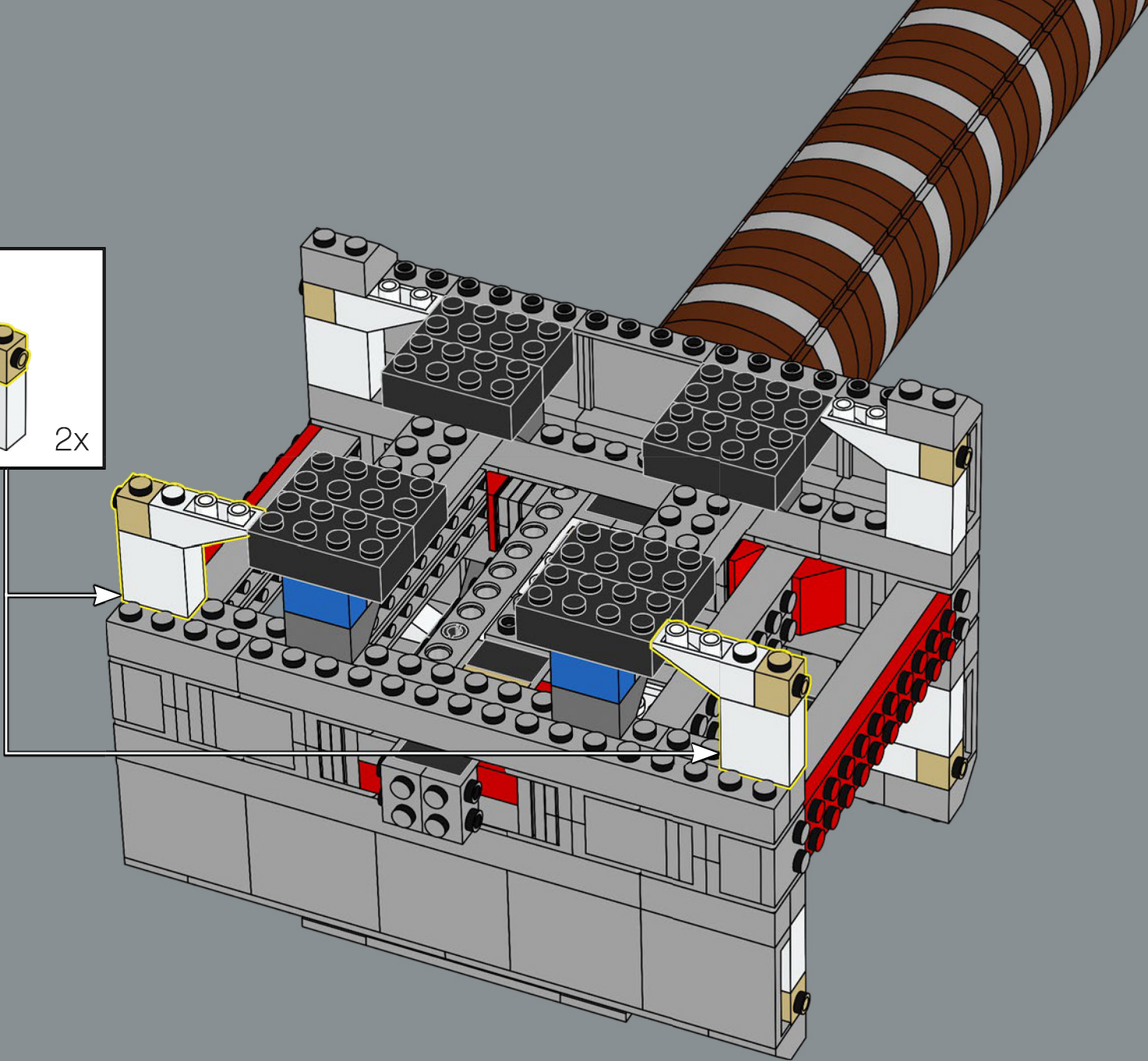
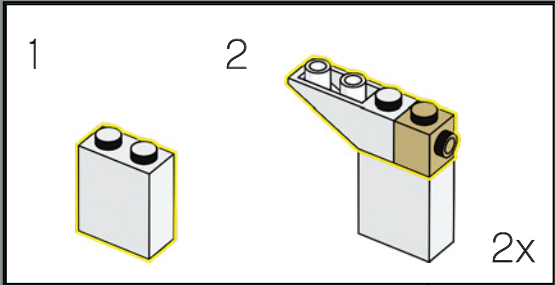

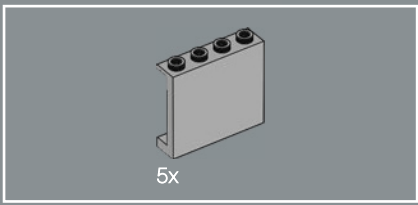

89

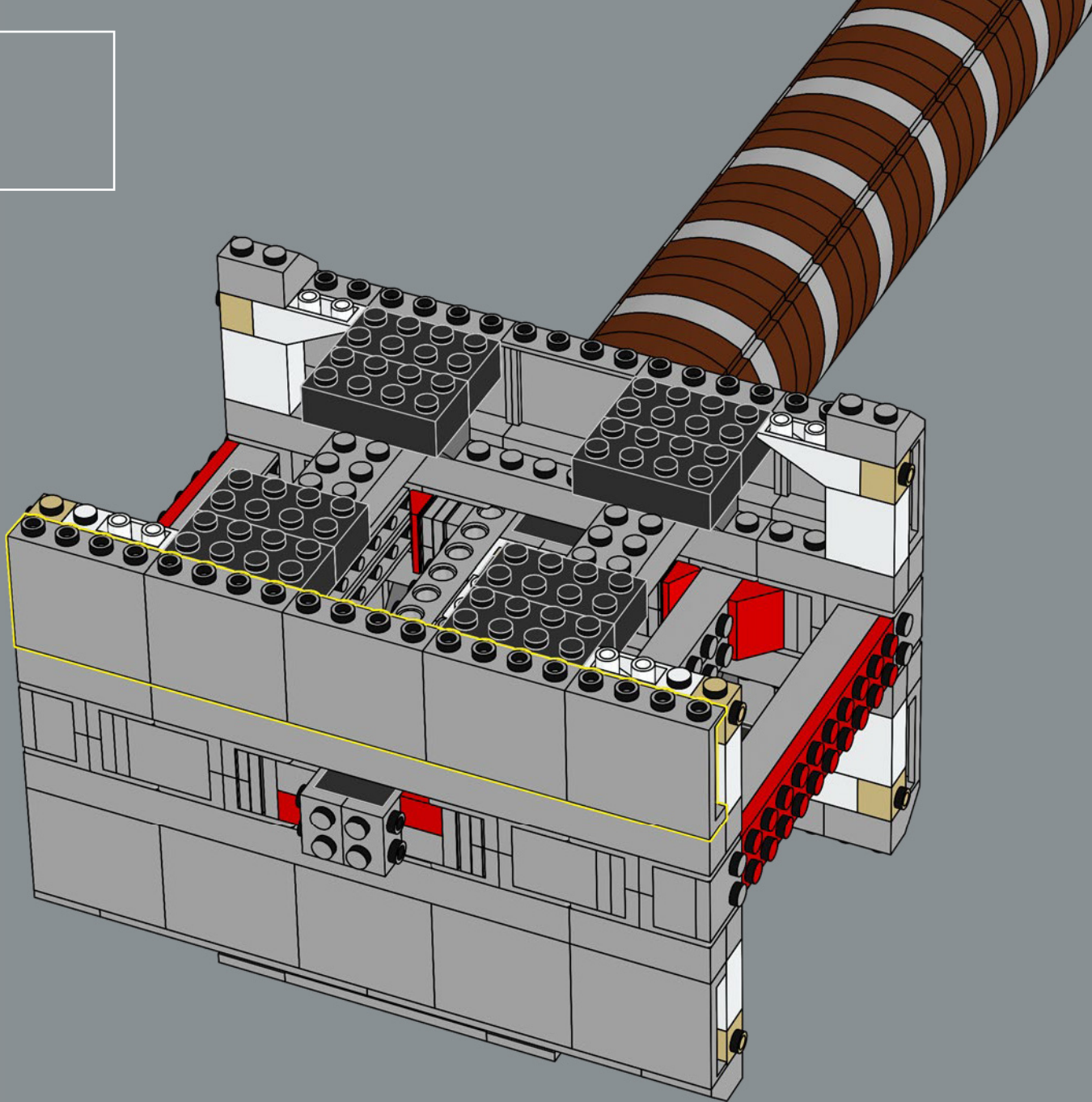

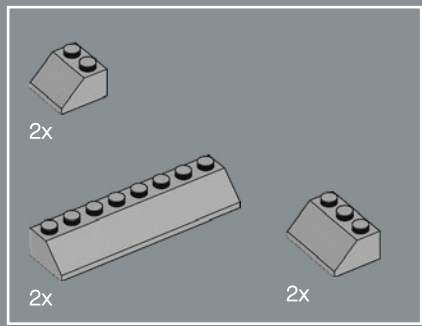

90

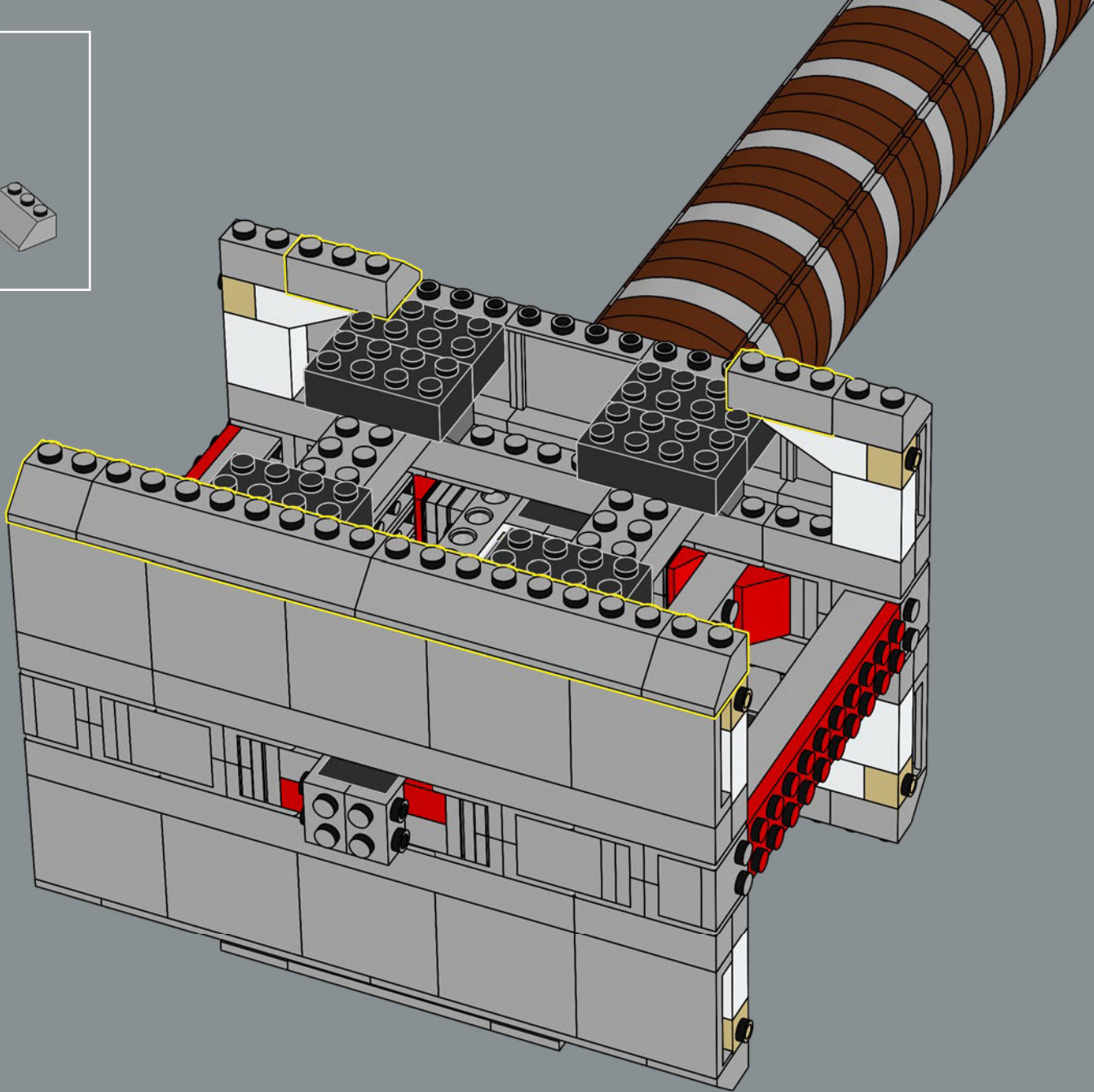

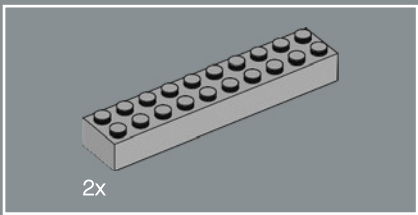

91

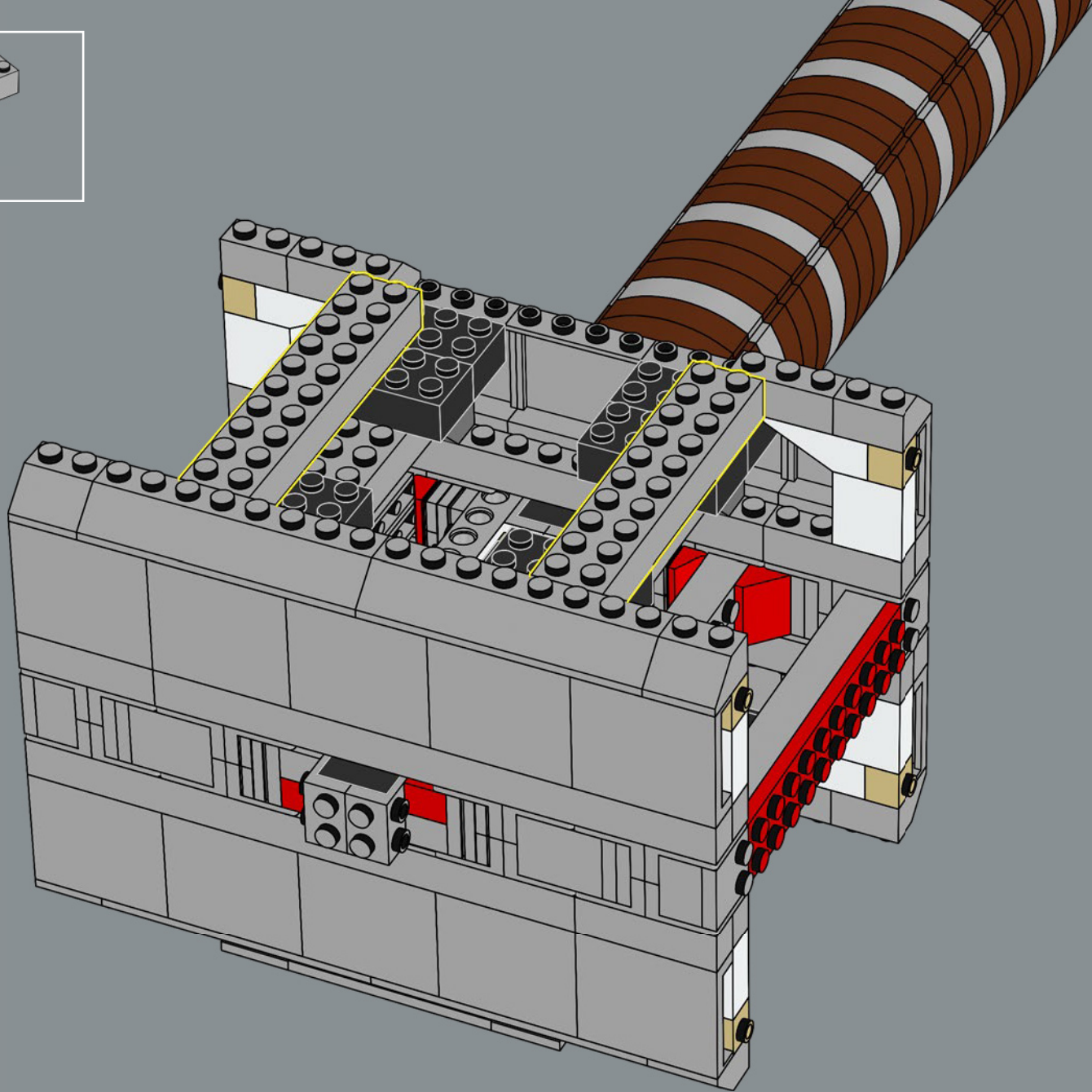

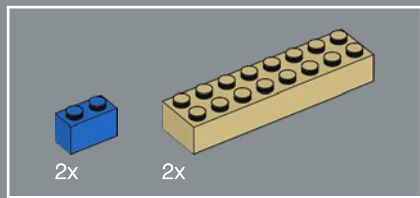

92

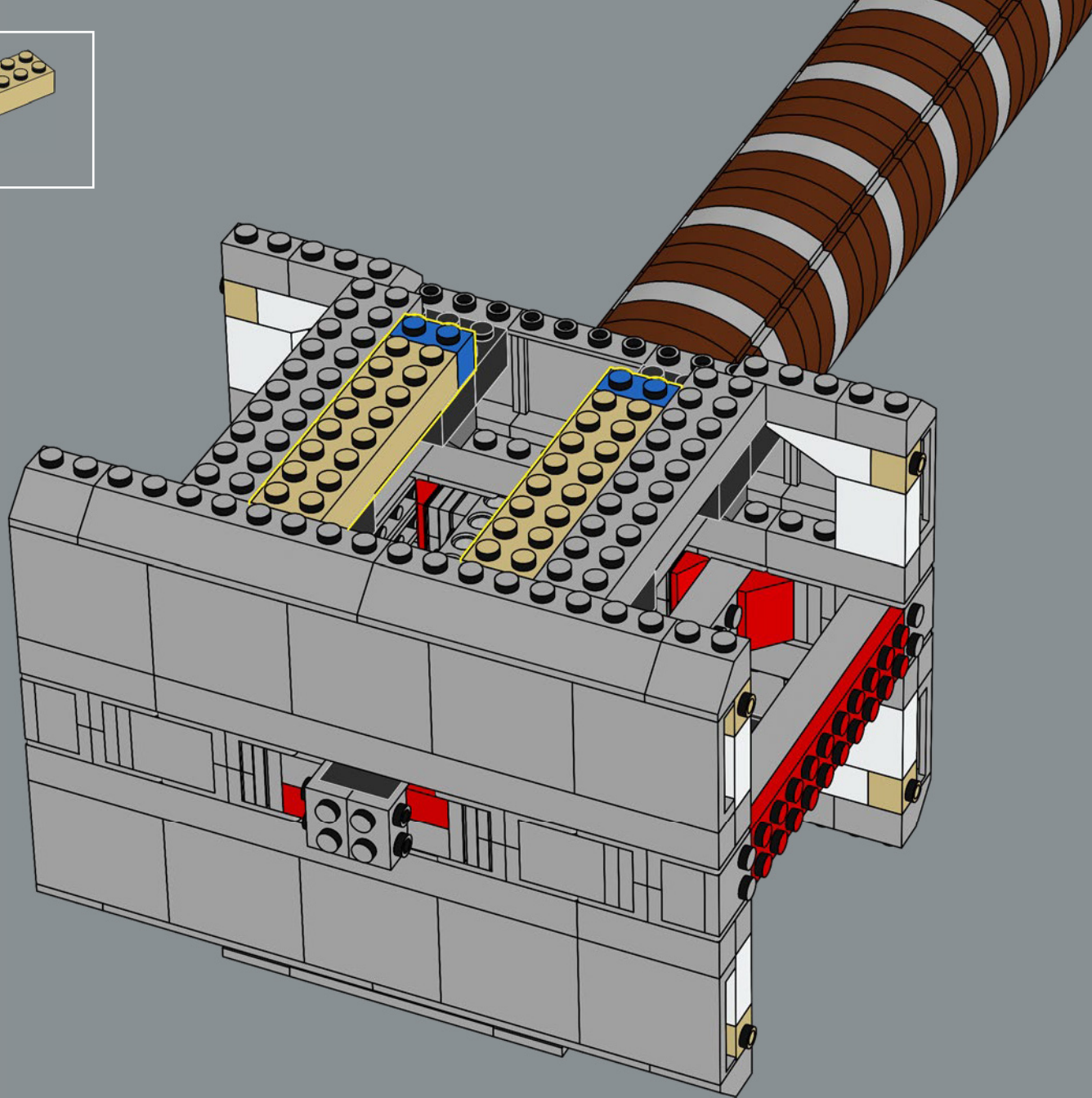



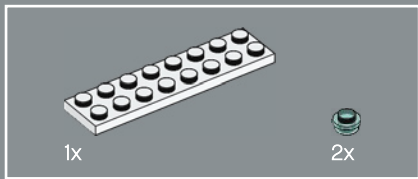

93

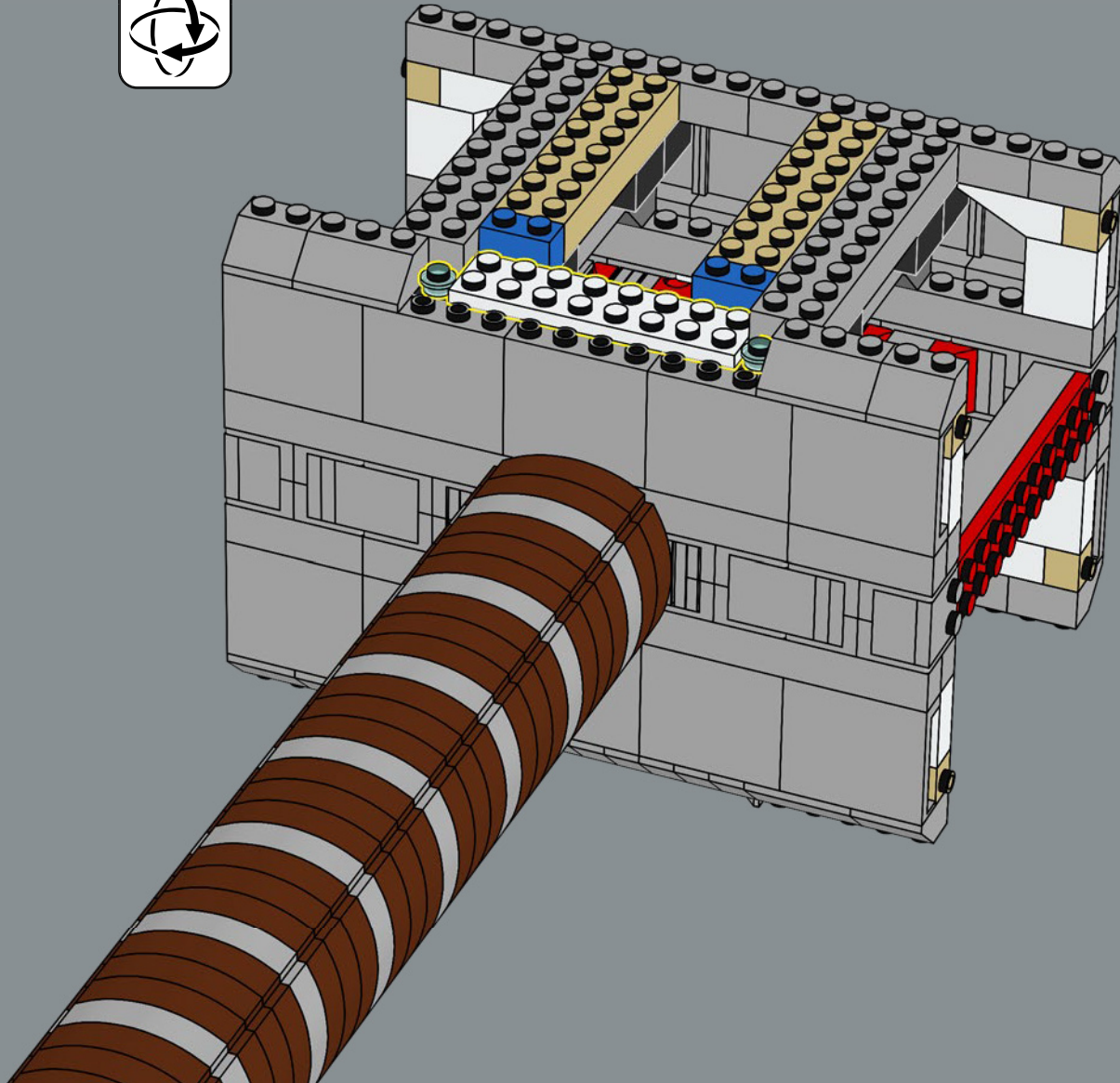

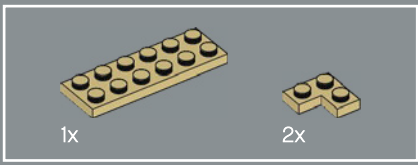

94

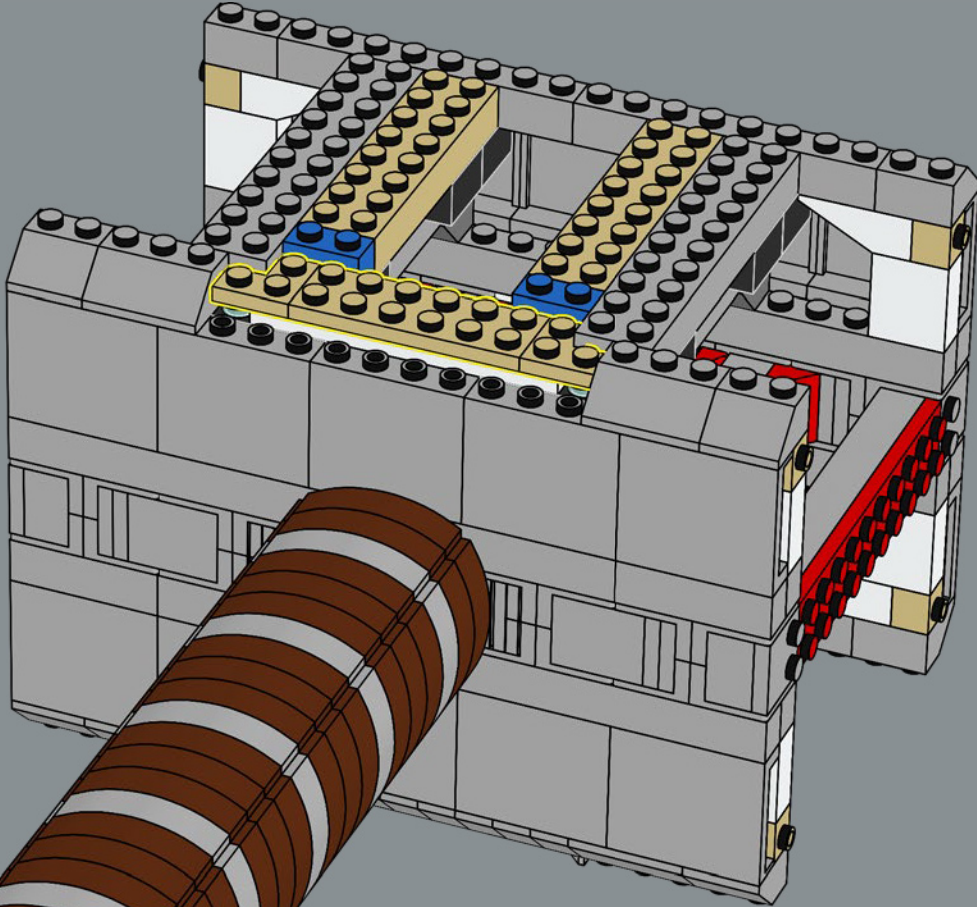

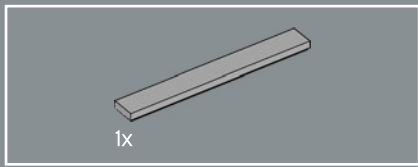

95

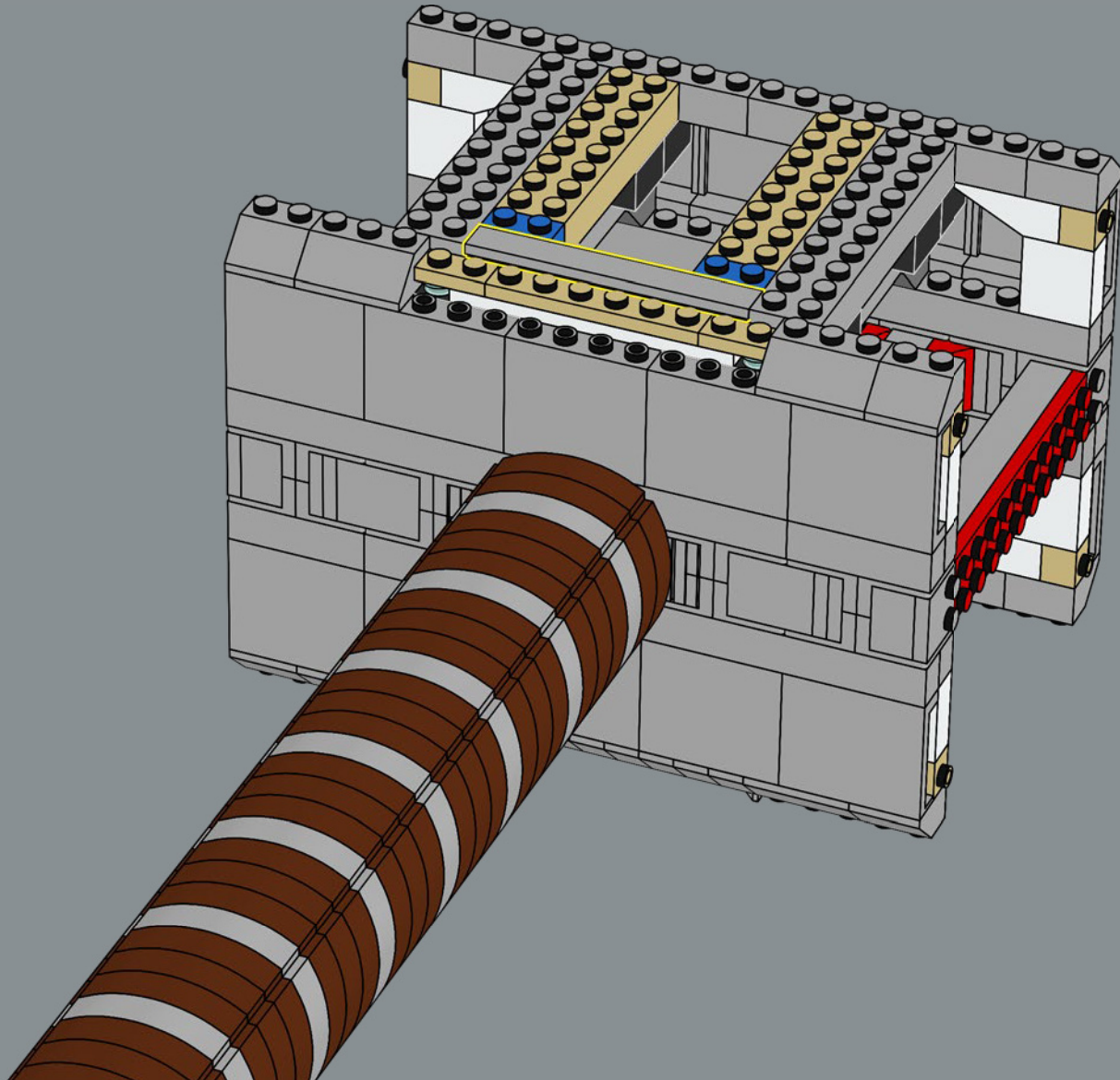



10x

96

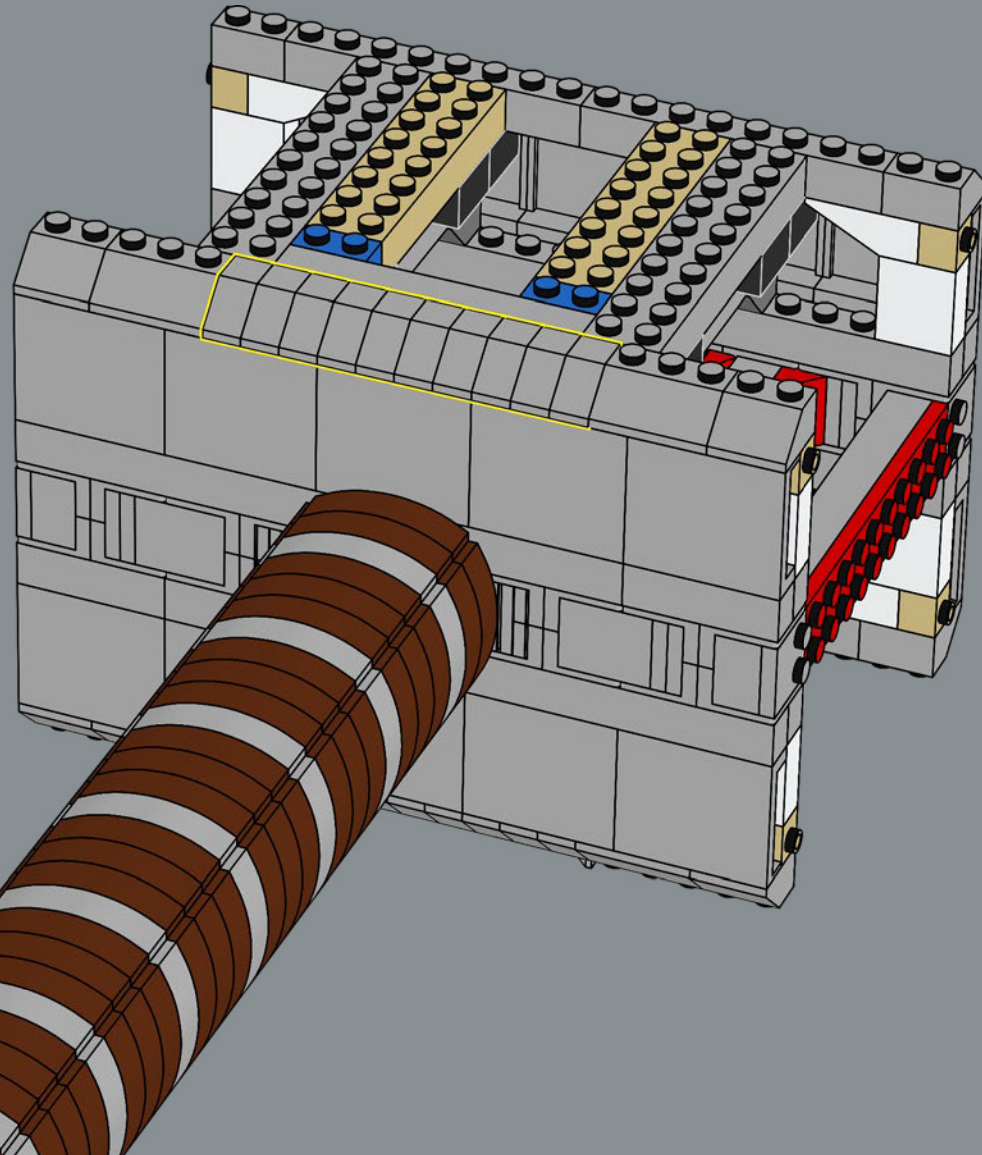

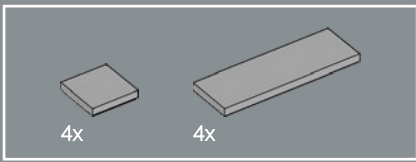

97

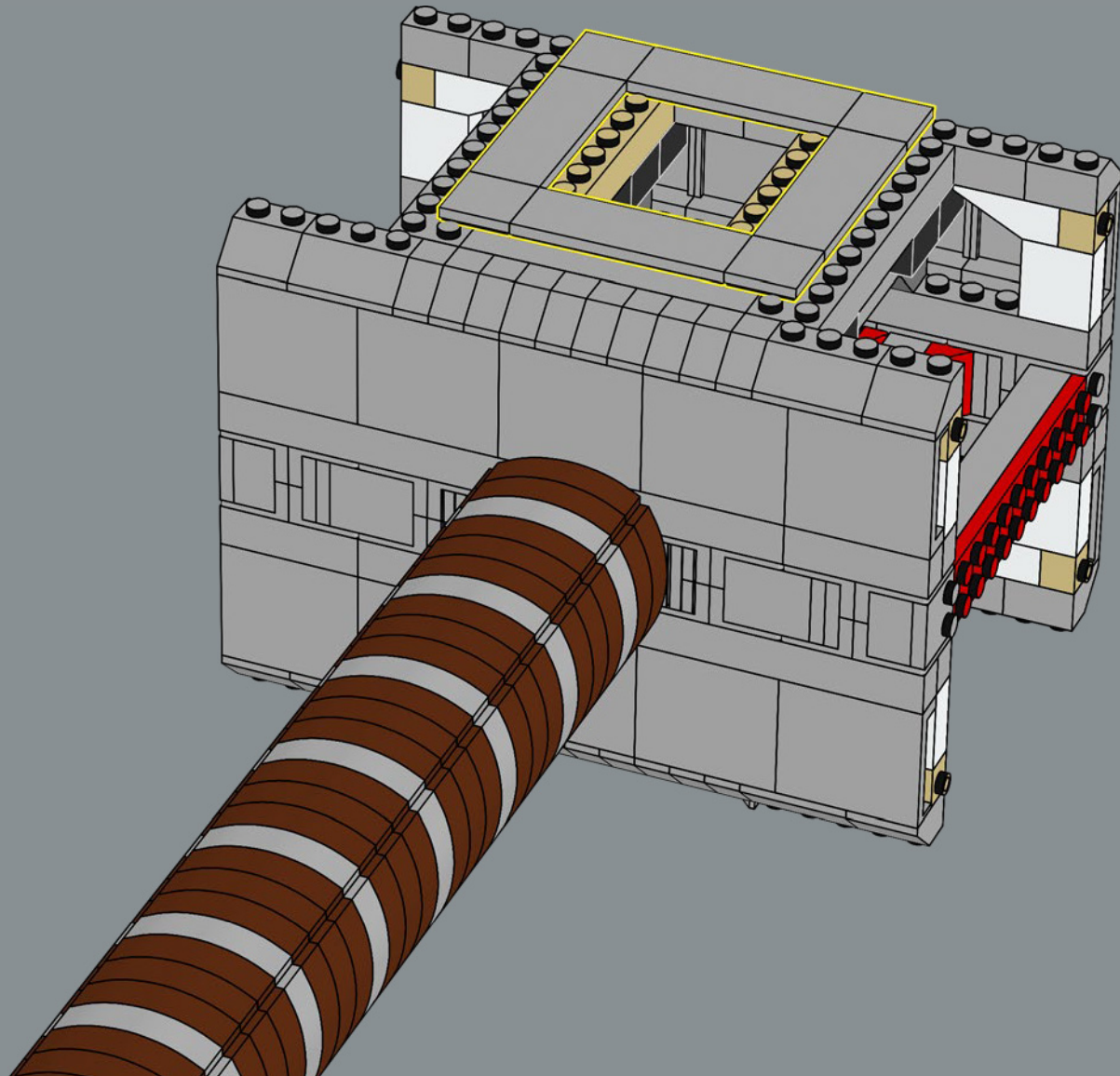

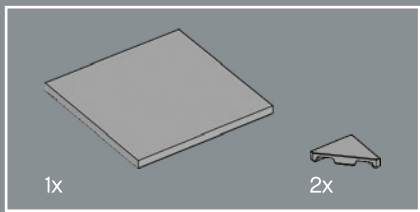

98

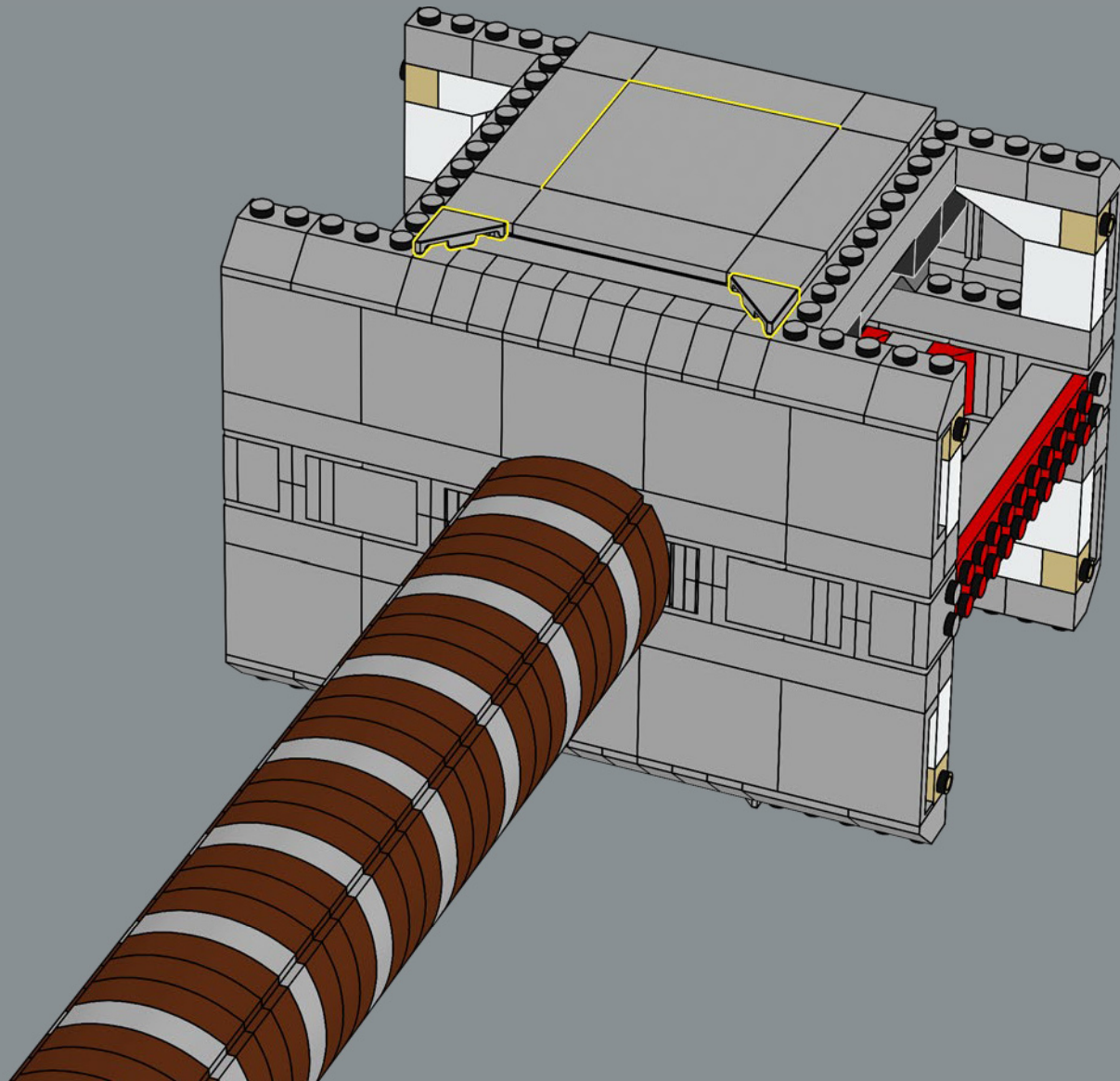

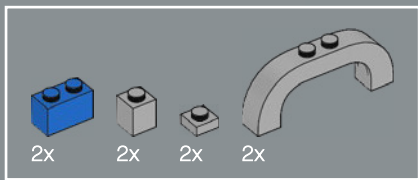

99

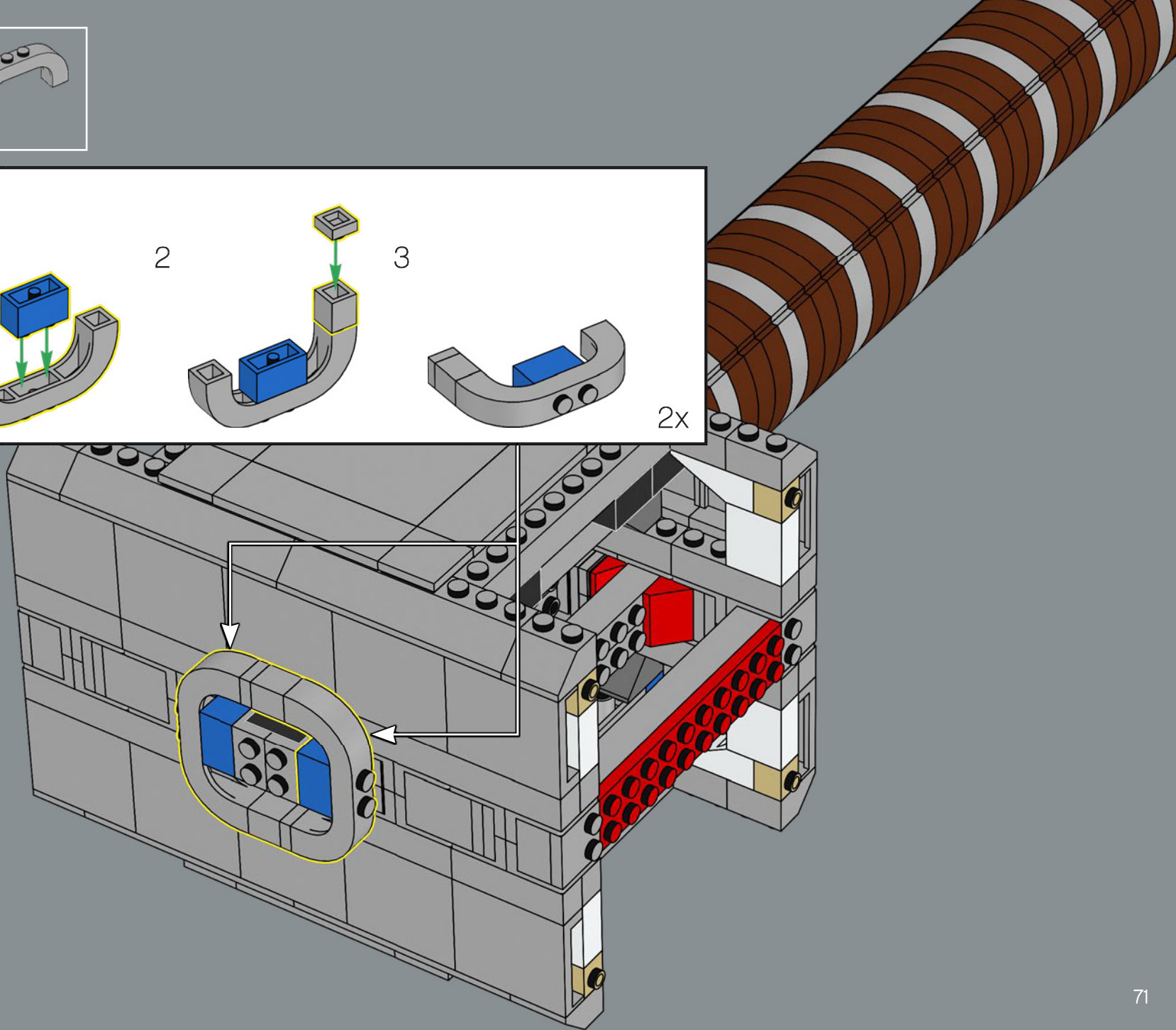
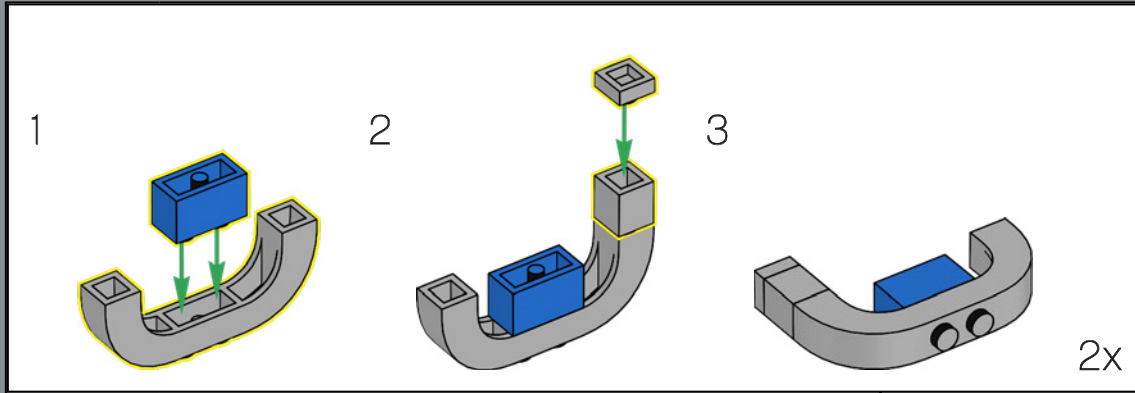

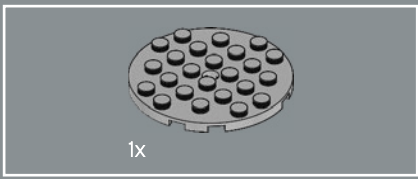

100

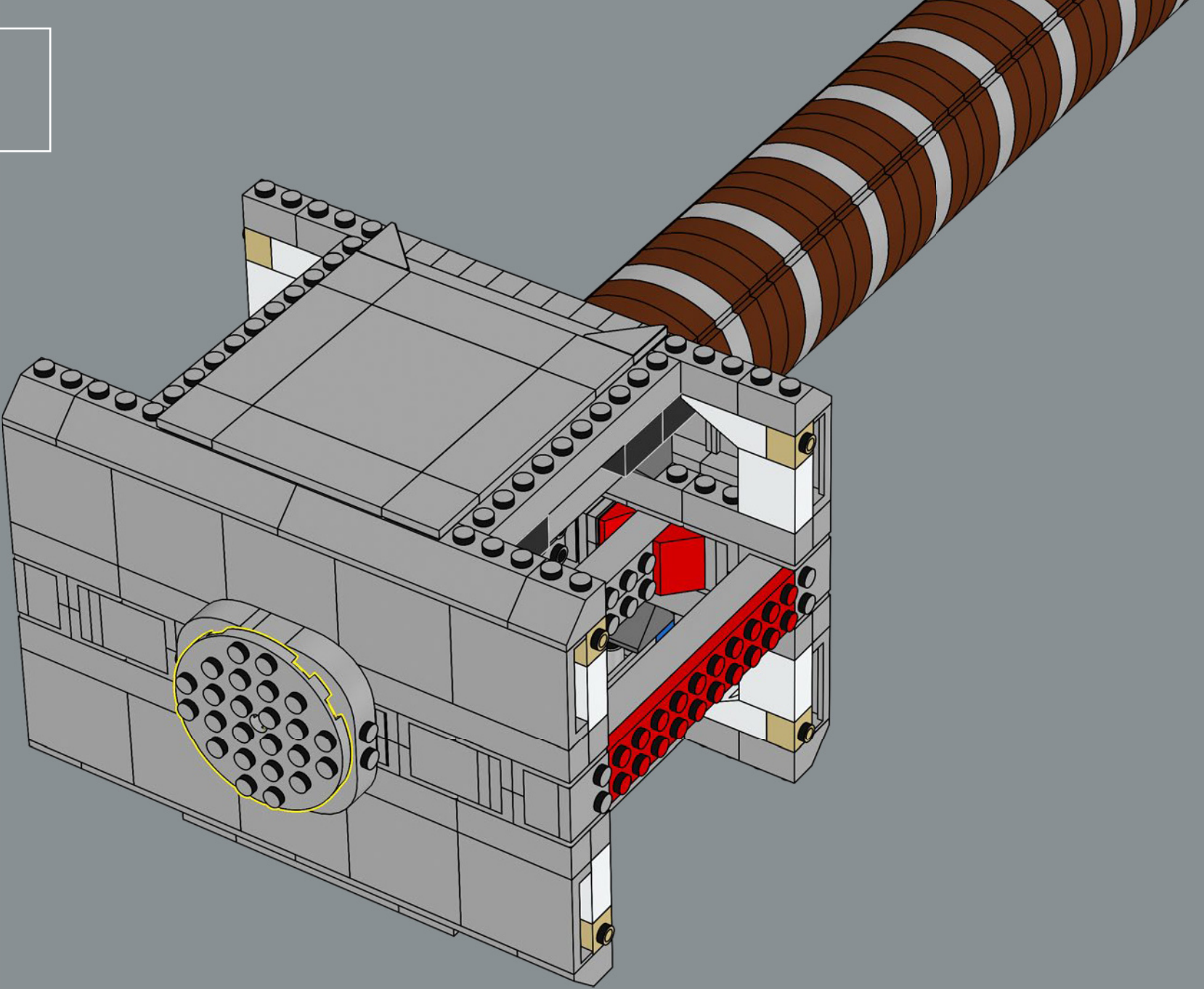



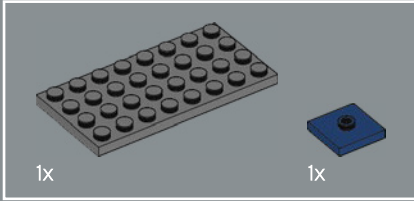

101

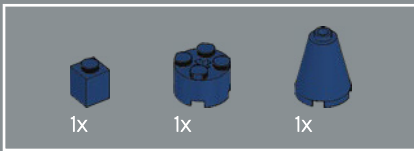
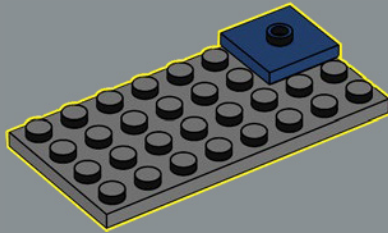

102

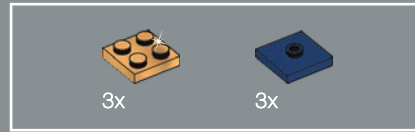
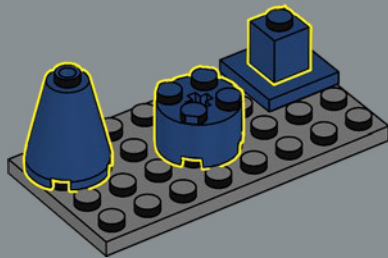

103

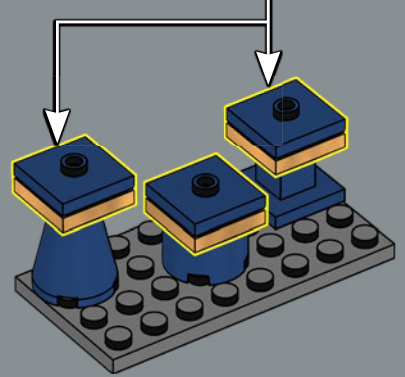
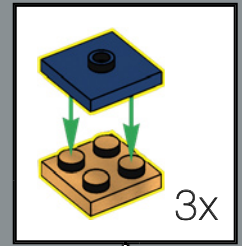

104

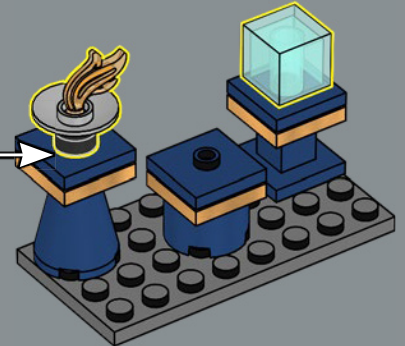
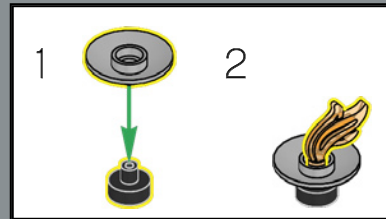



2x

105

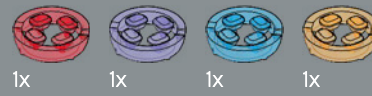
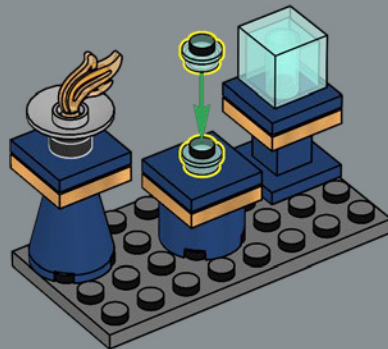

1x

1x

1x

1x



1x

1x



1x

106

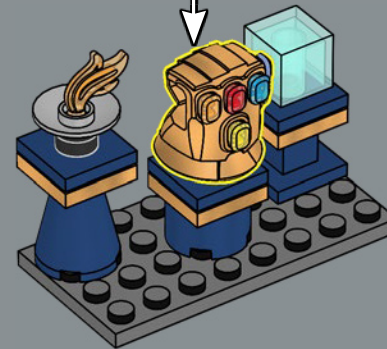
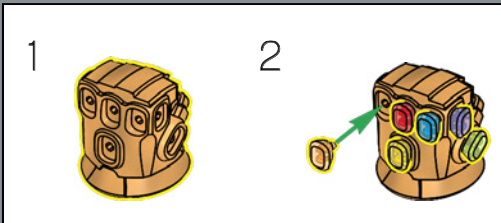

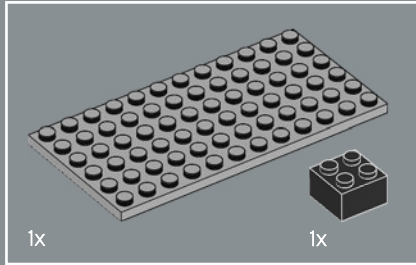
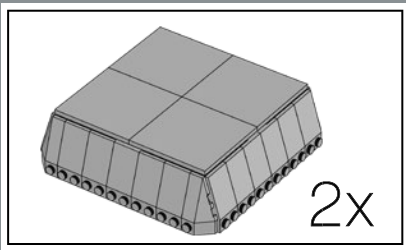
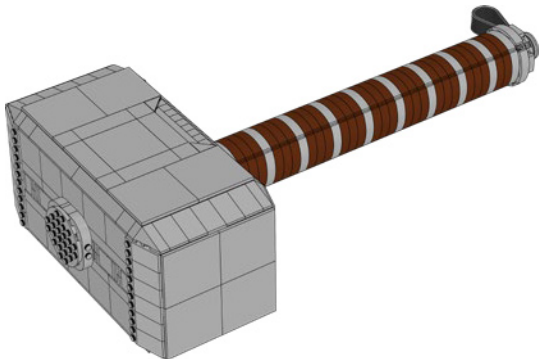

107

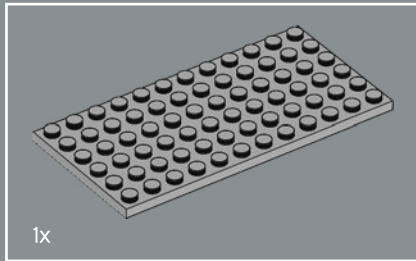
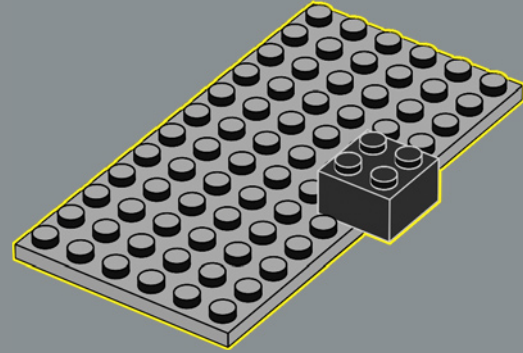

108

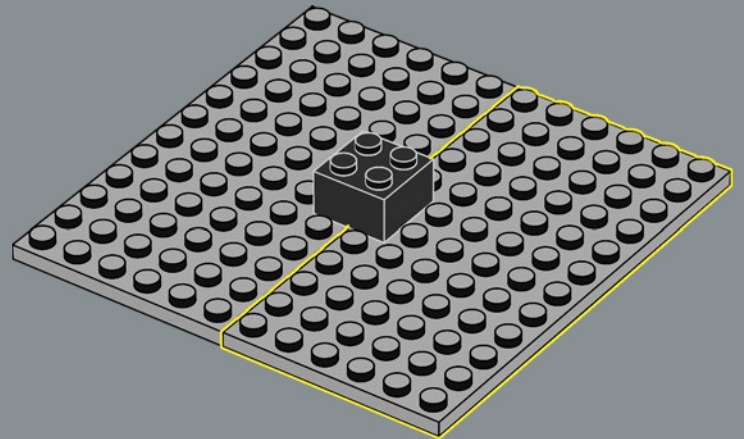

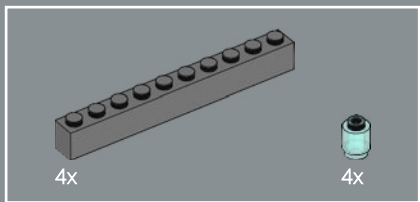

109

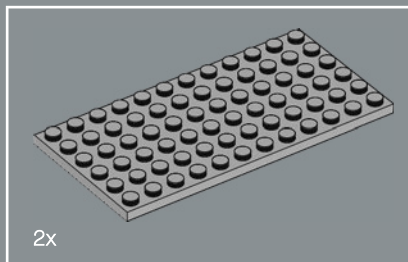
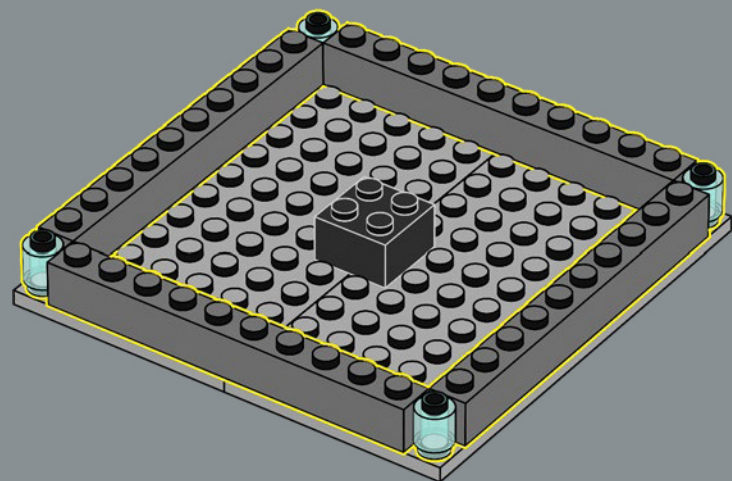

110

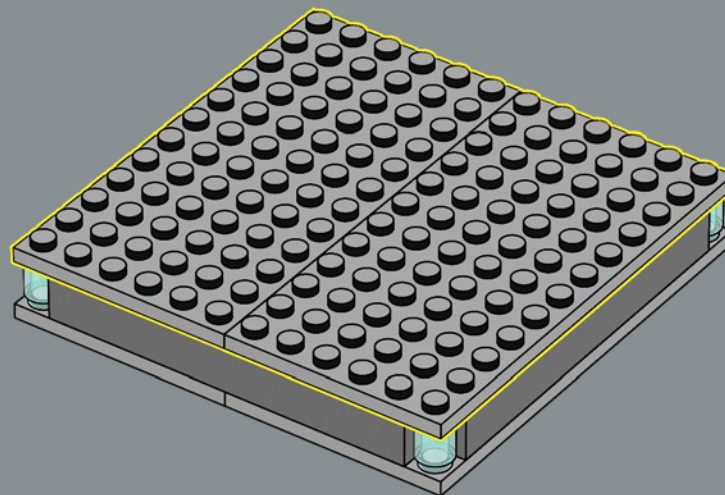

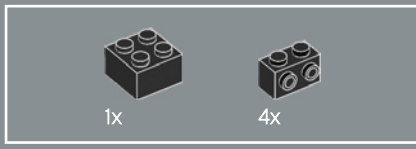

111

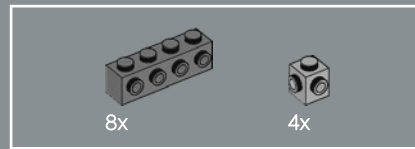
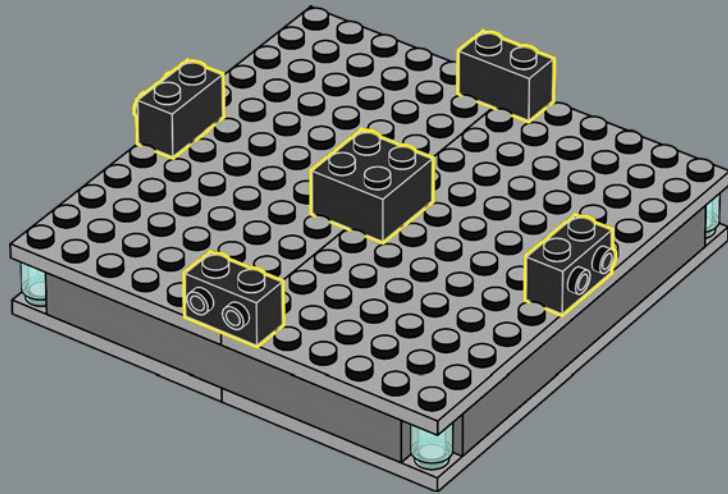

112

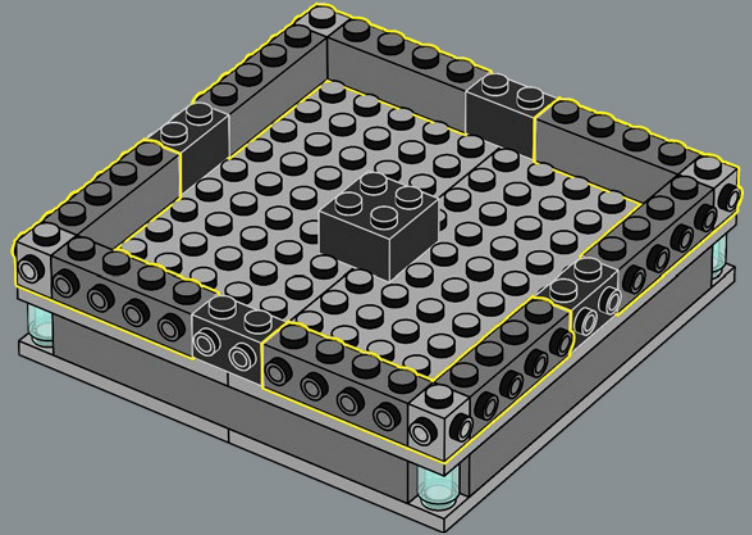

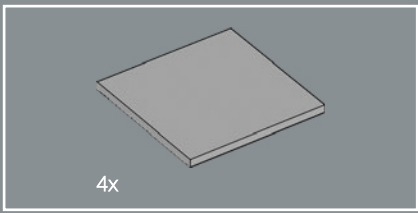

113

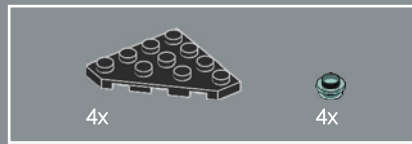
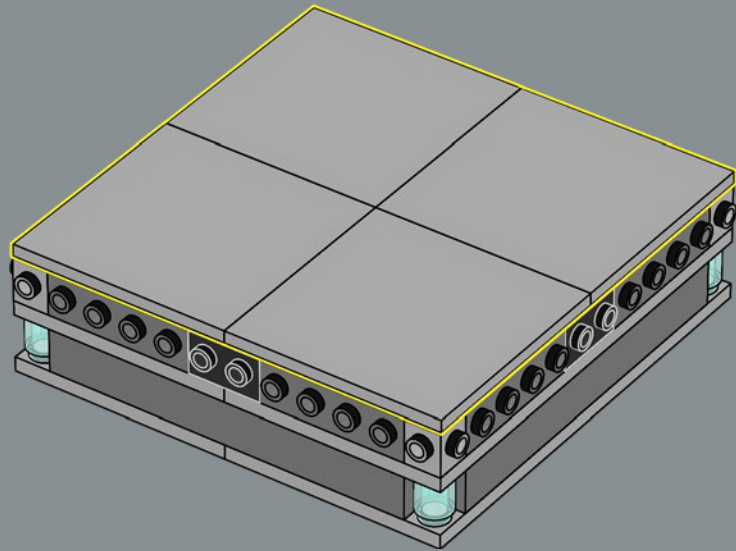

114

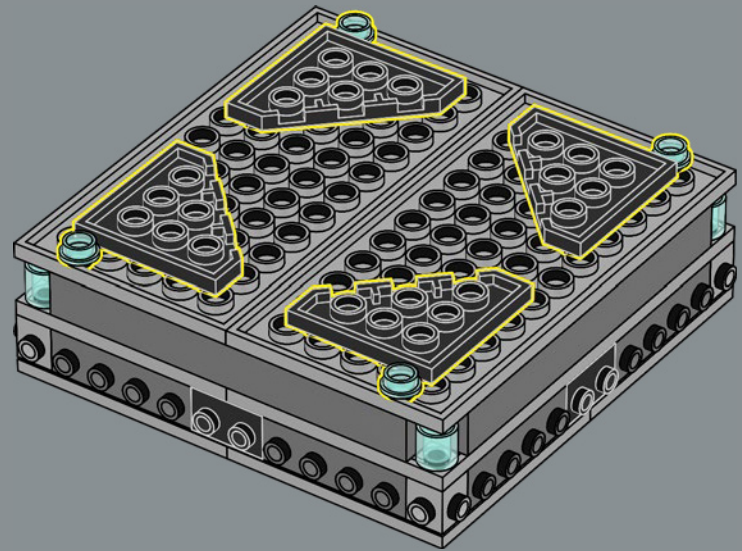



115

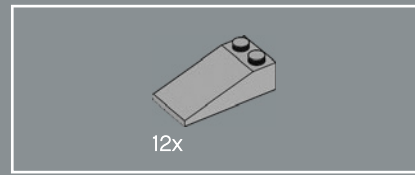
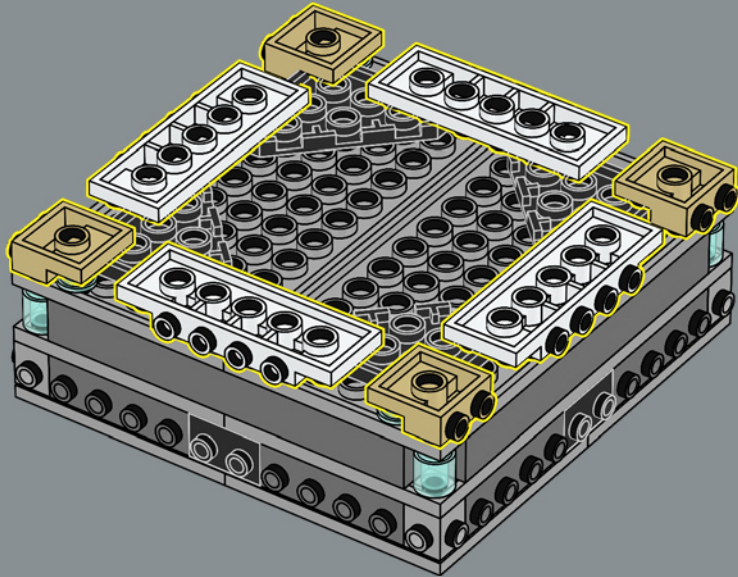

116

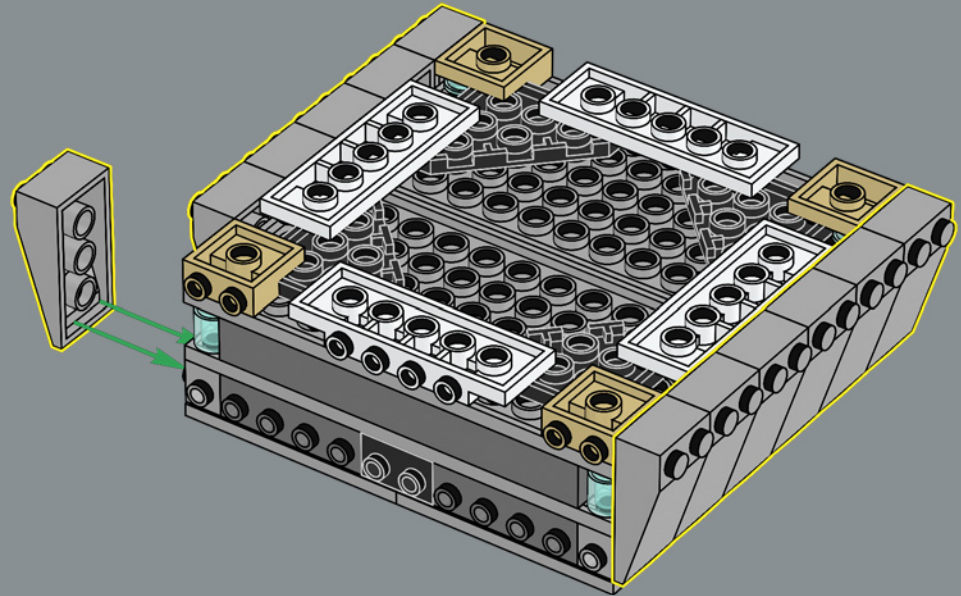





119

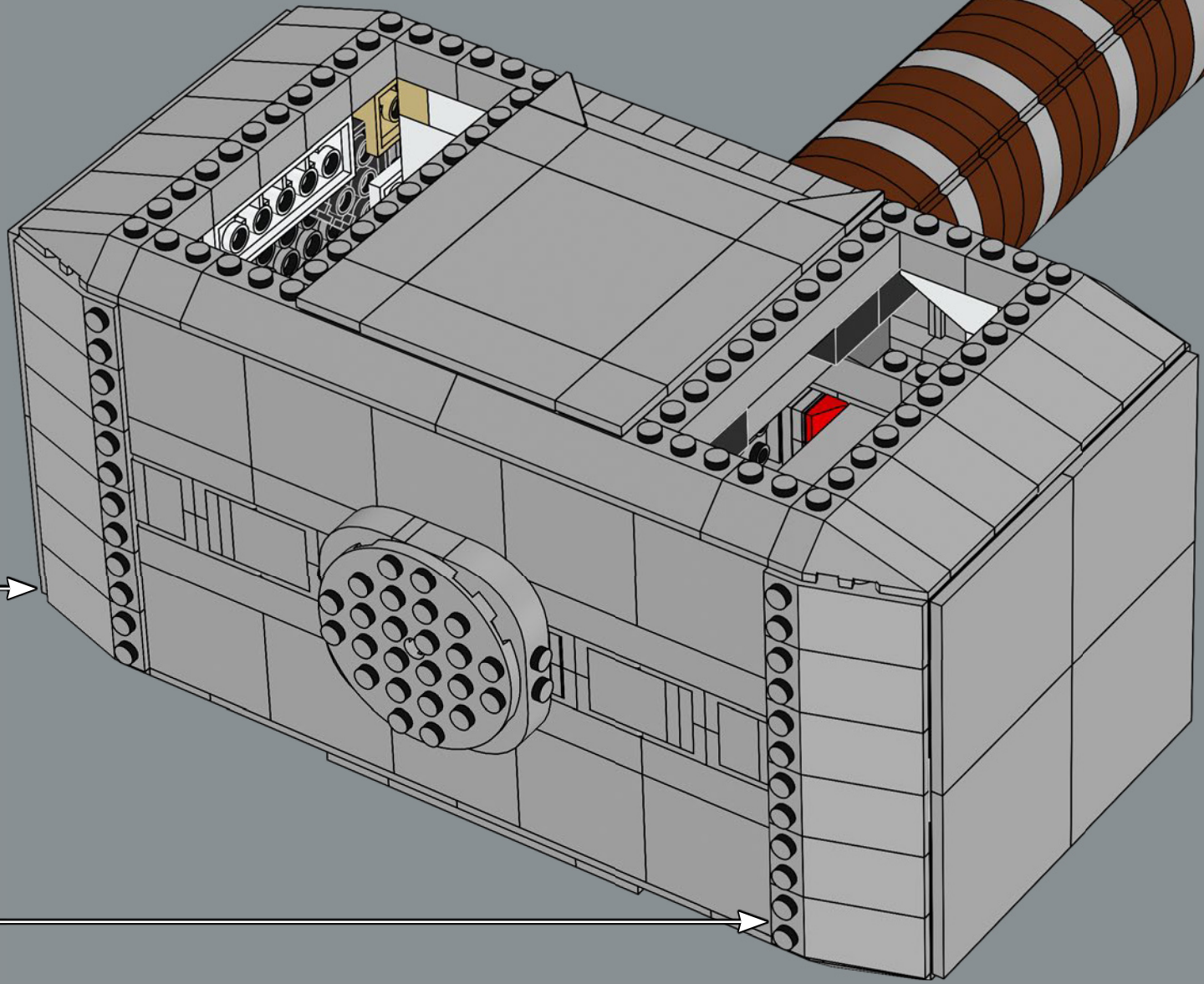

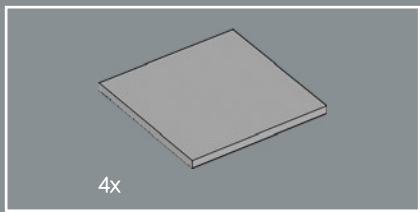

120

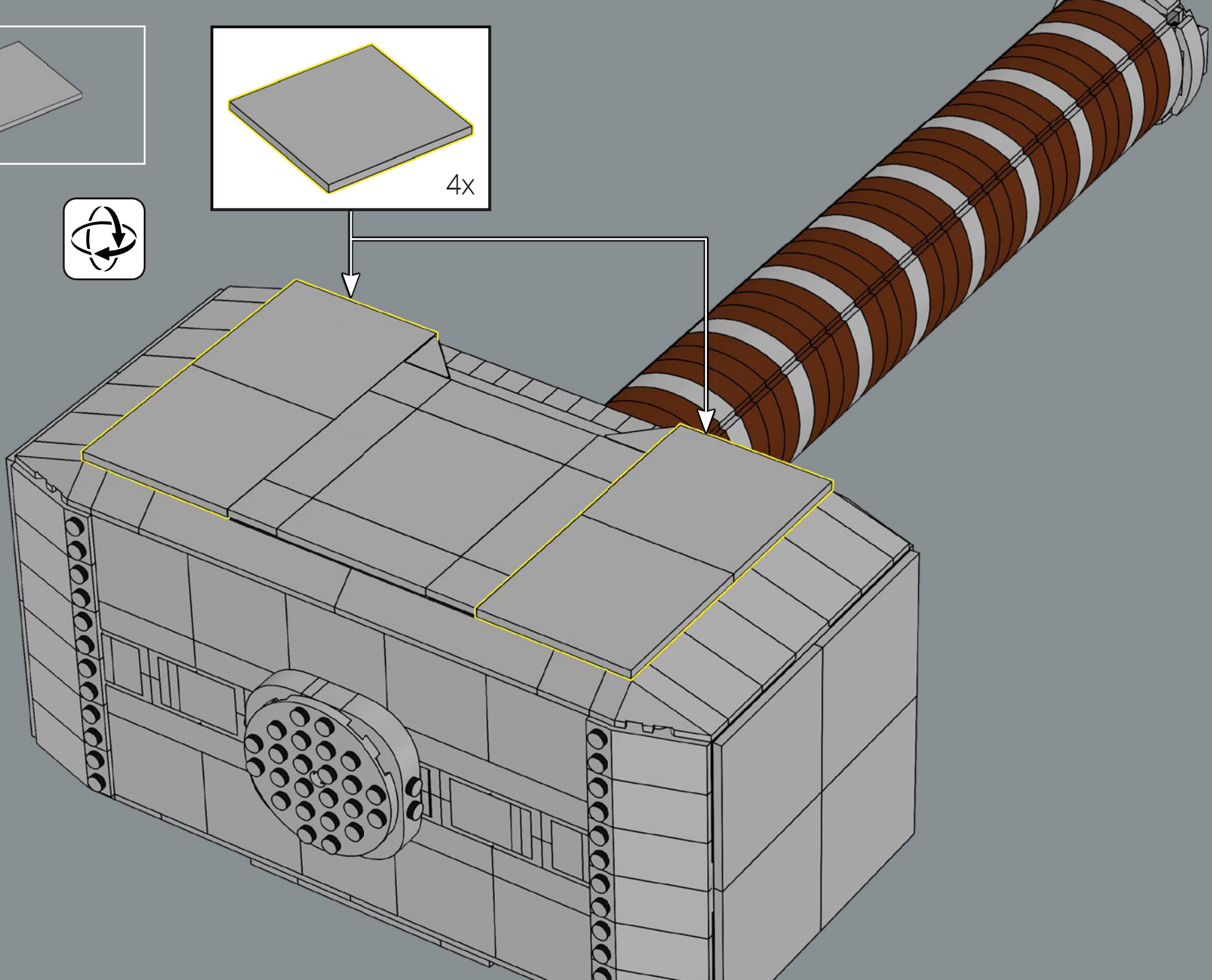
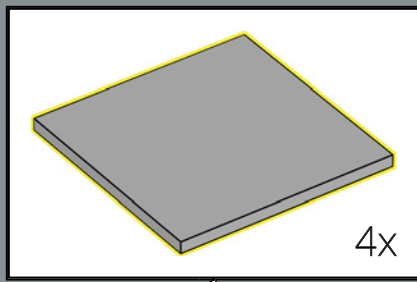

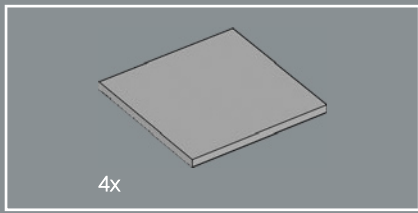

121

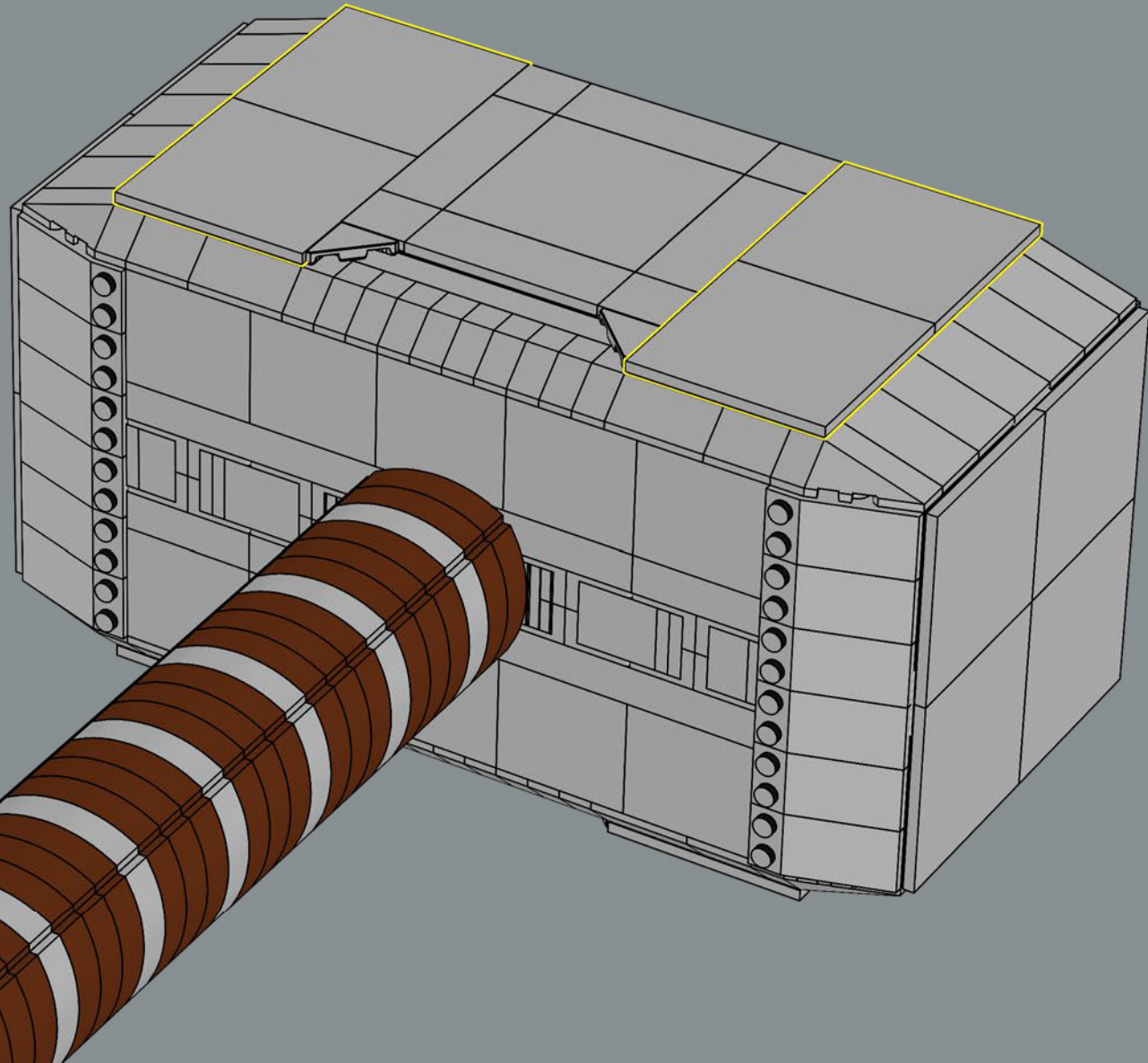

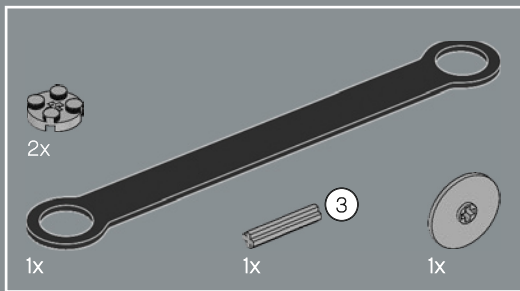

122

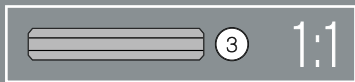
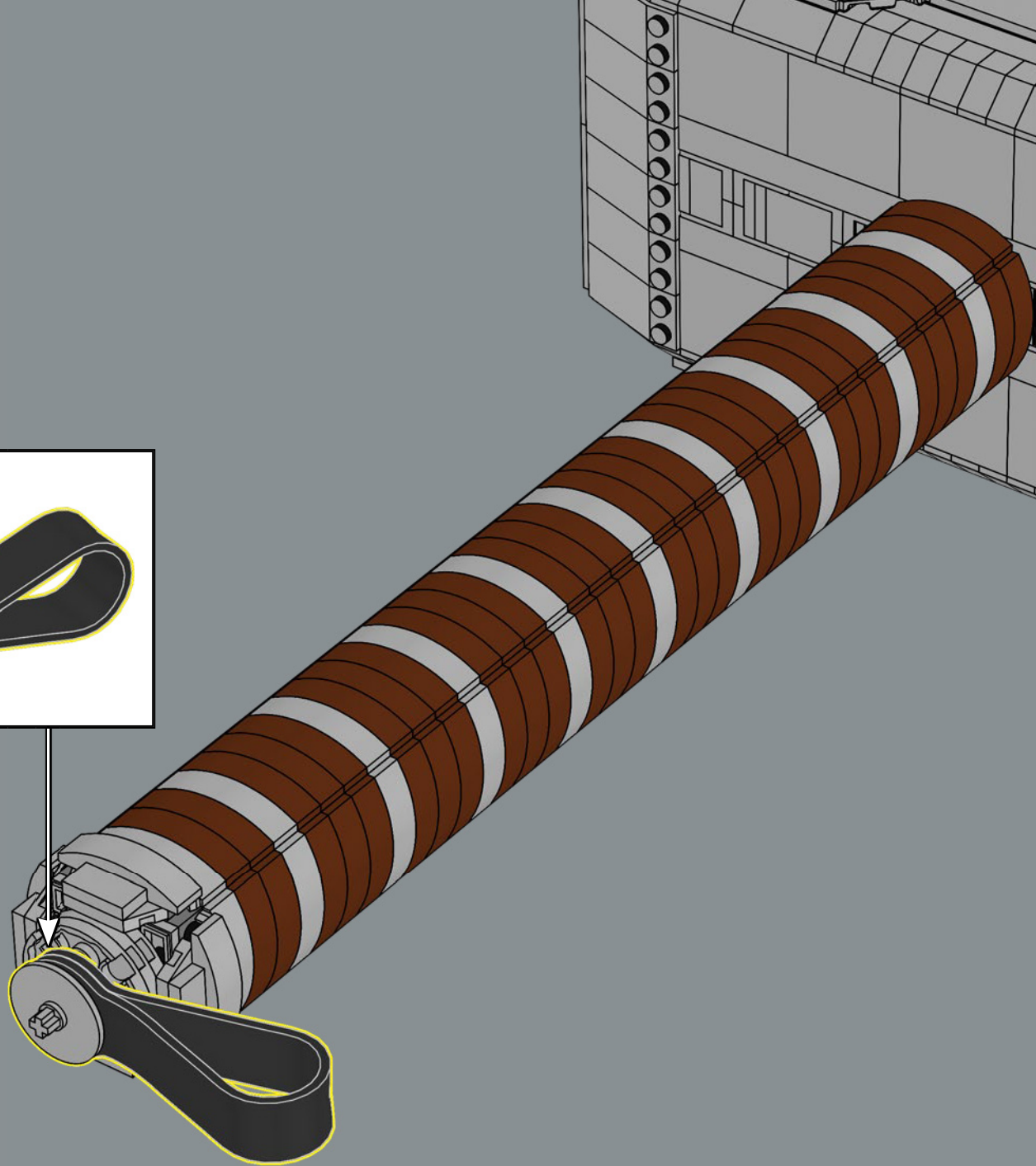
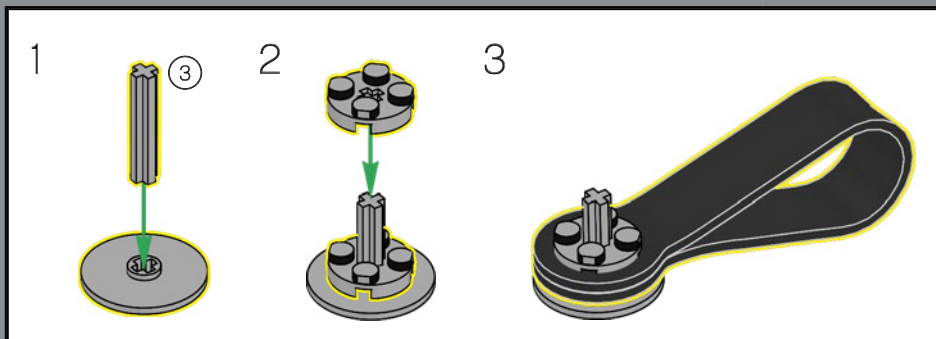

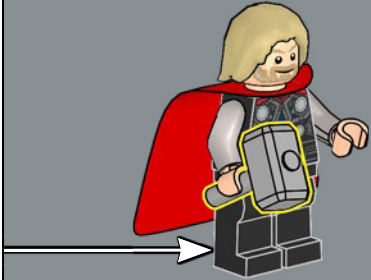
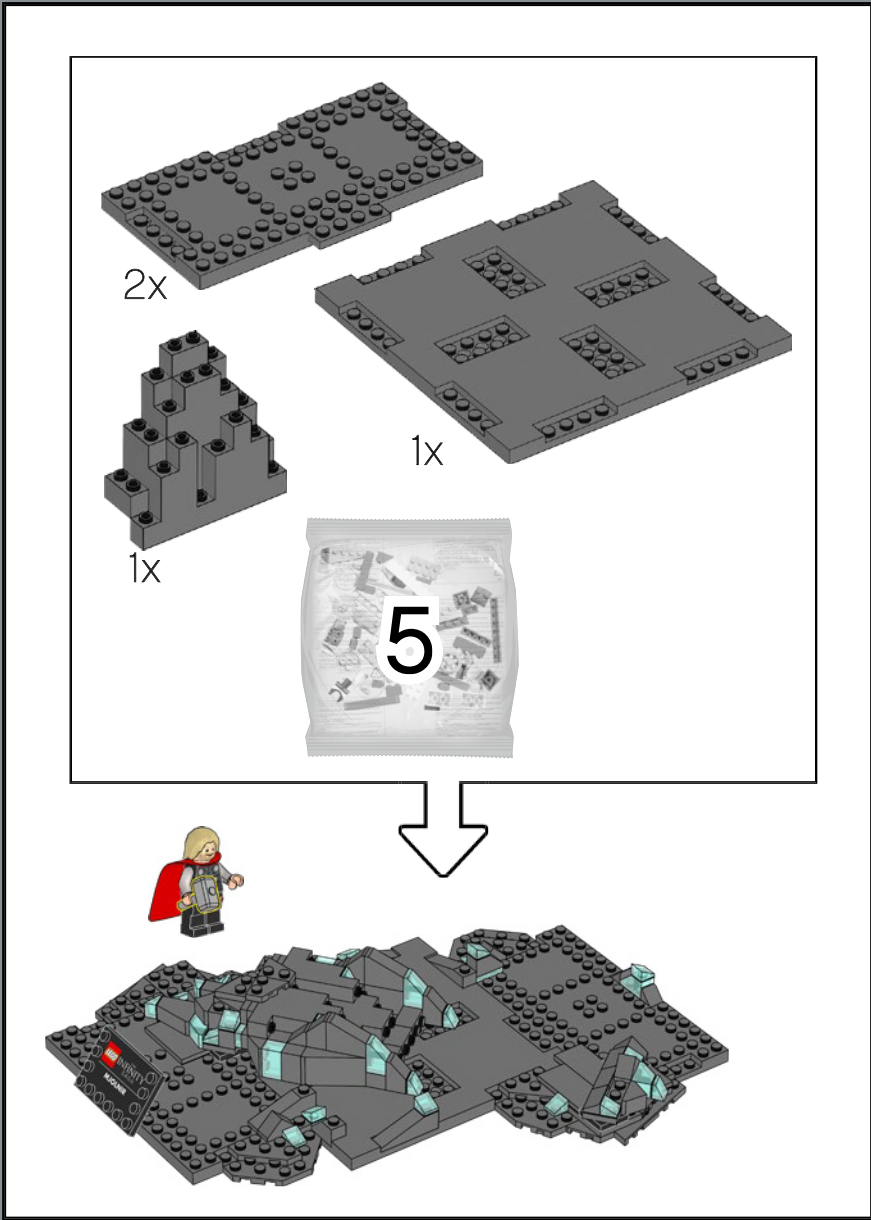

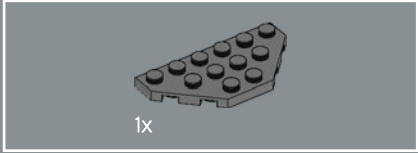
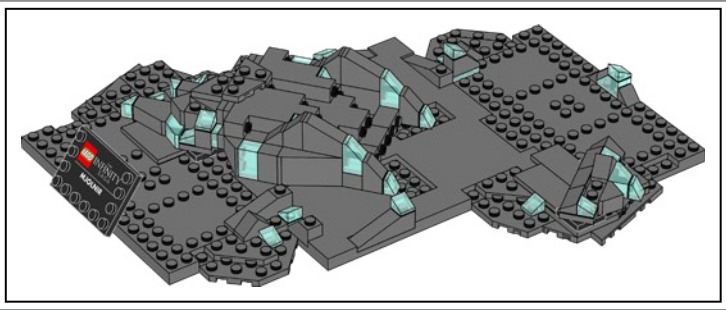

123

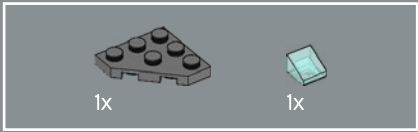
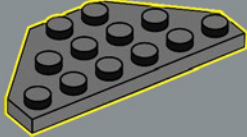

124

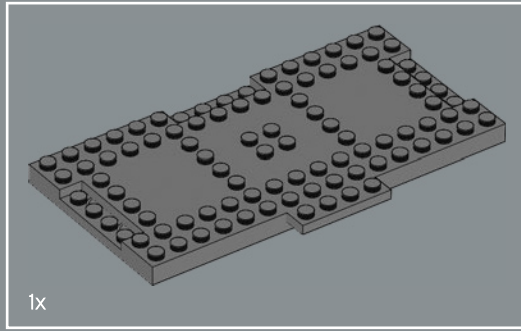
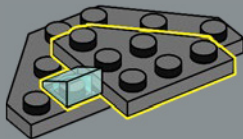

125

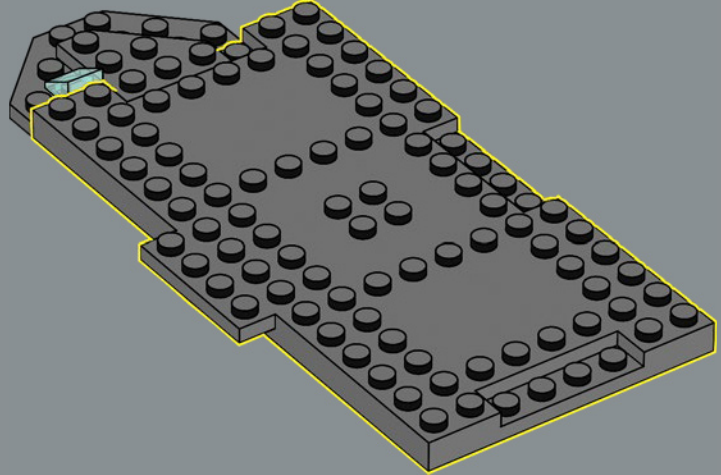



126

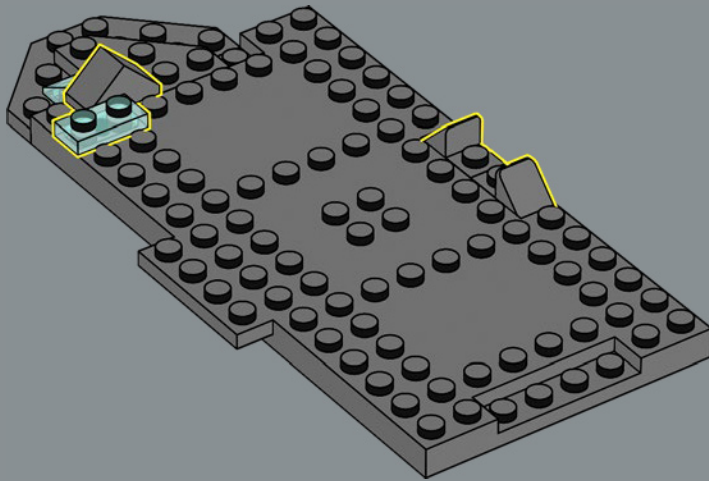

127

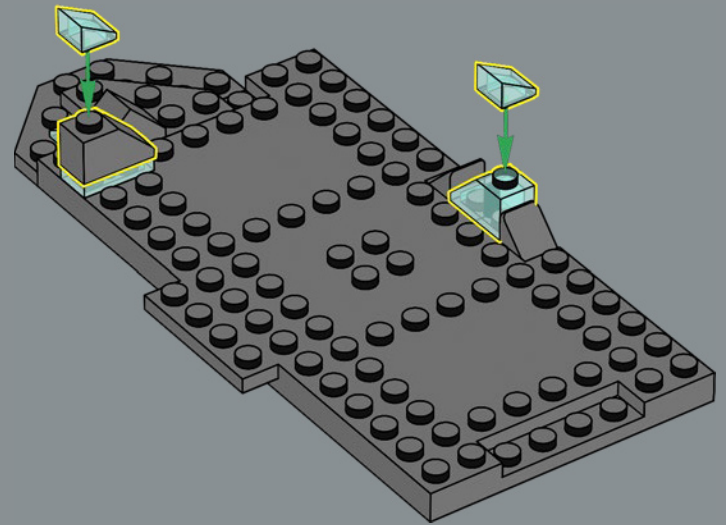

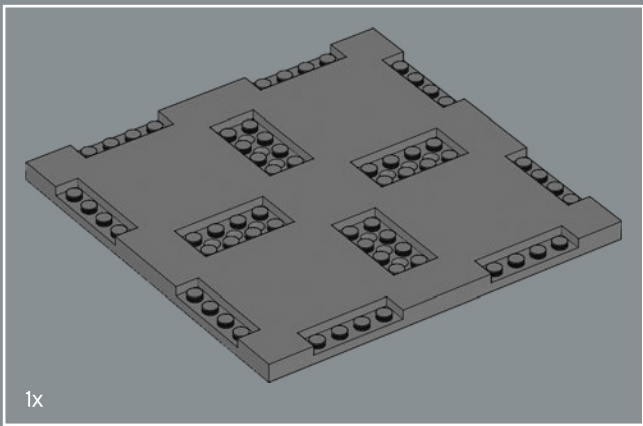

128

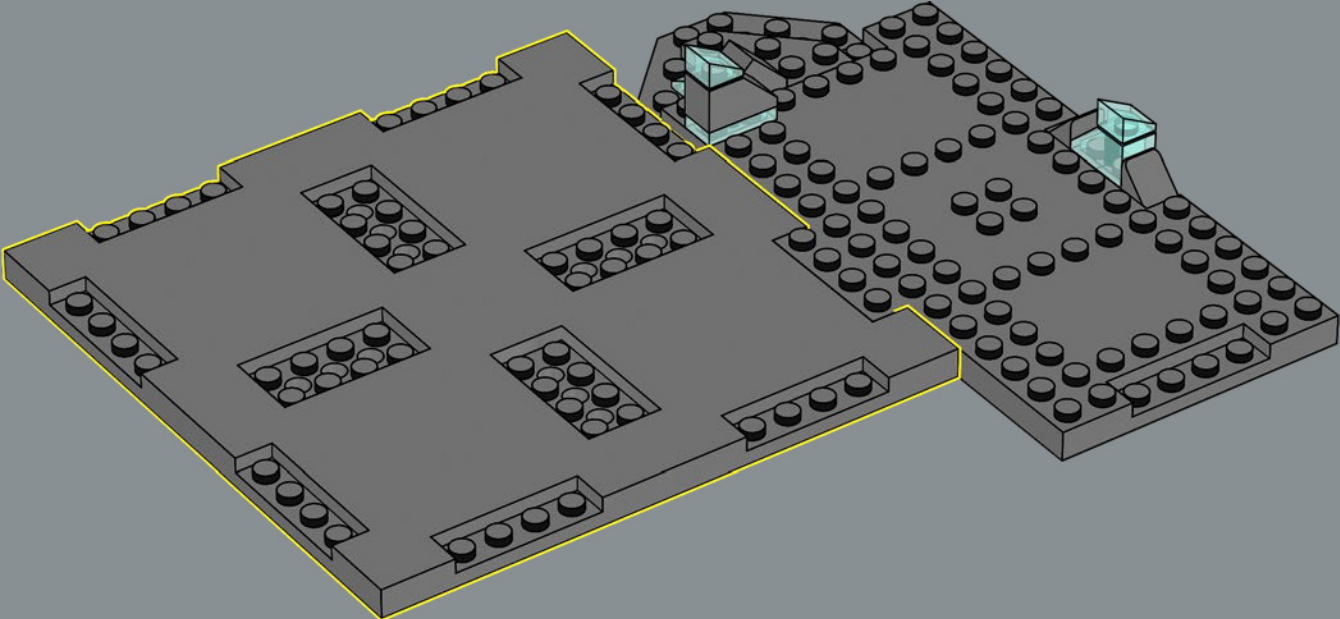



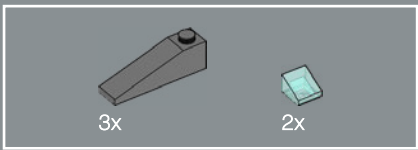

129

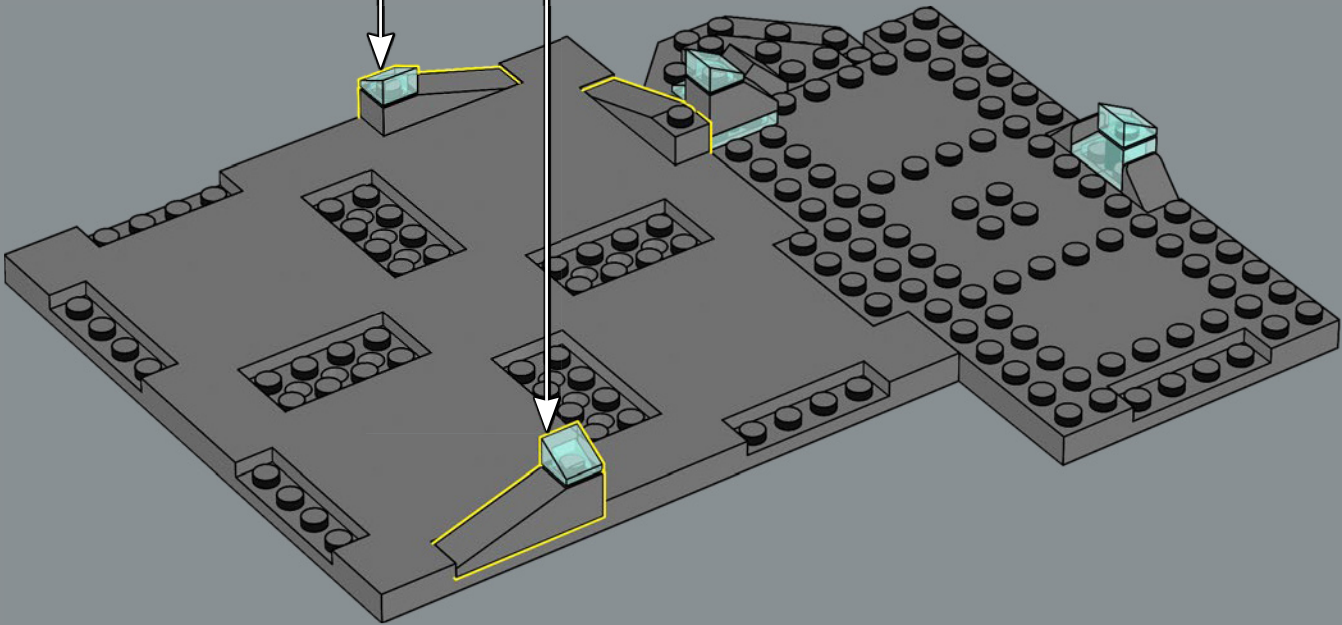
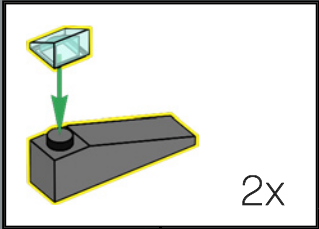

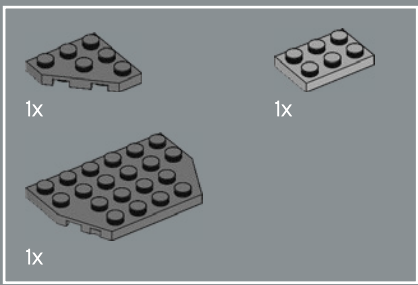

130

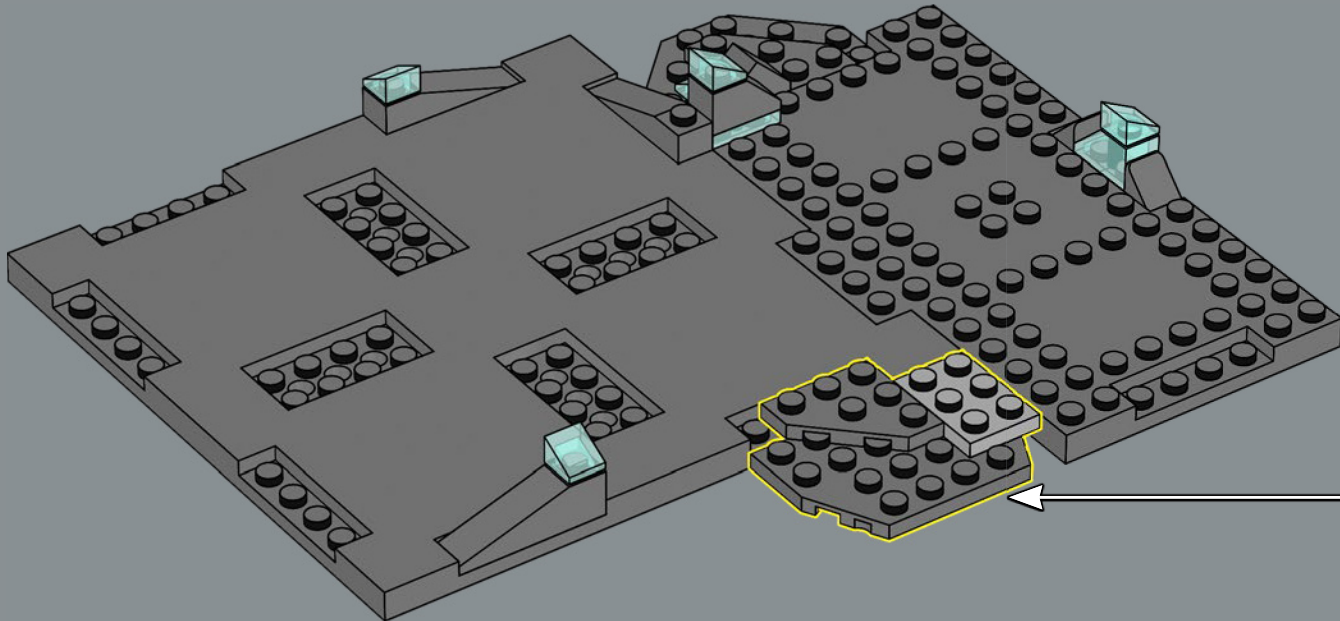
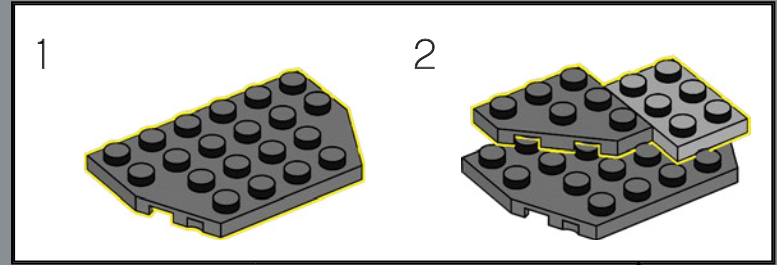

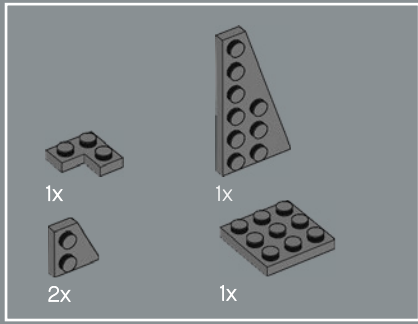

131

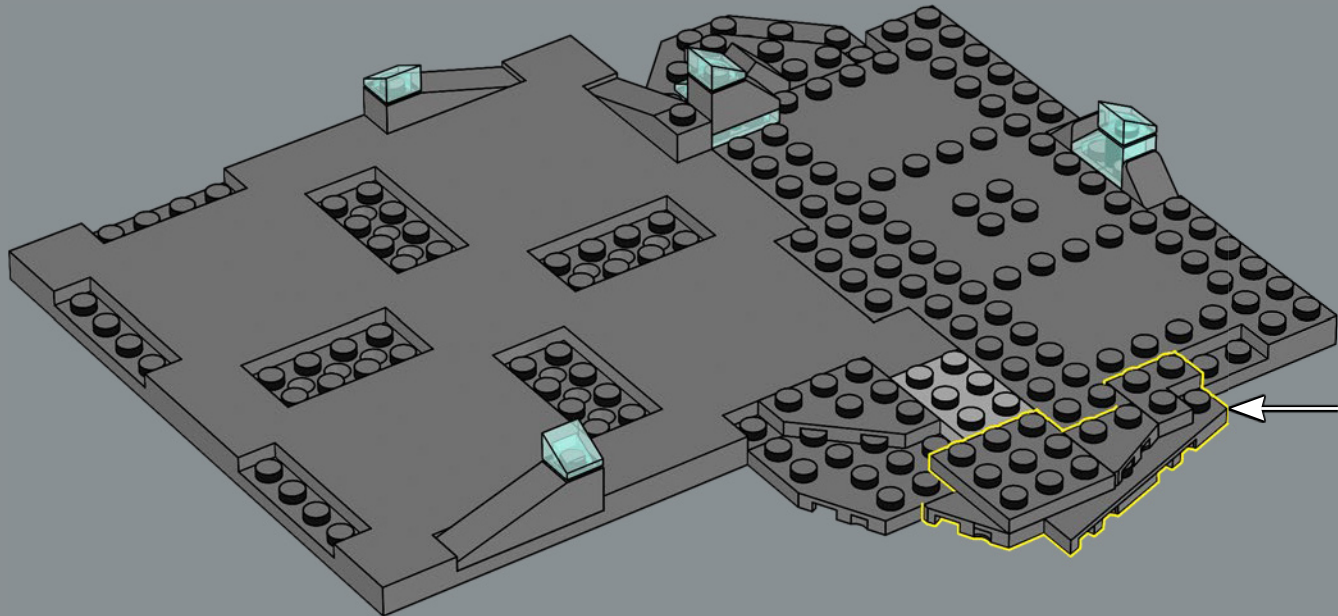
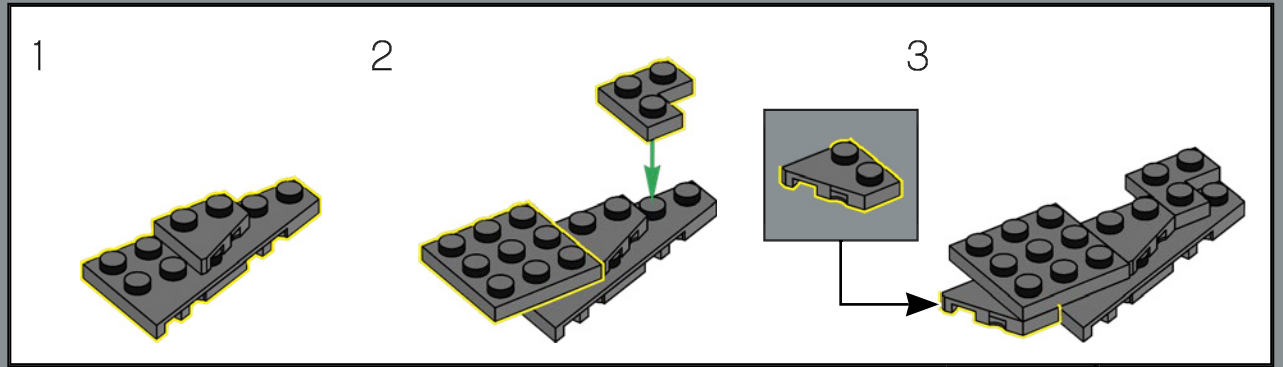

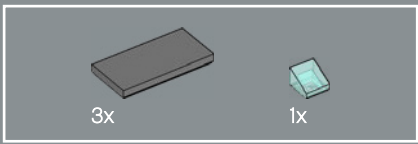

132

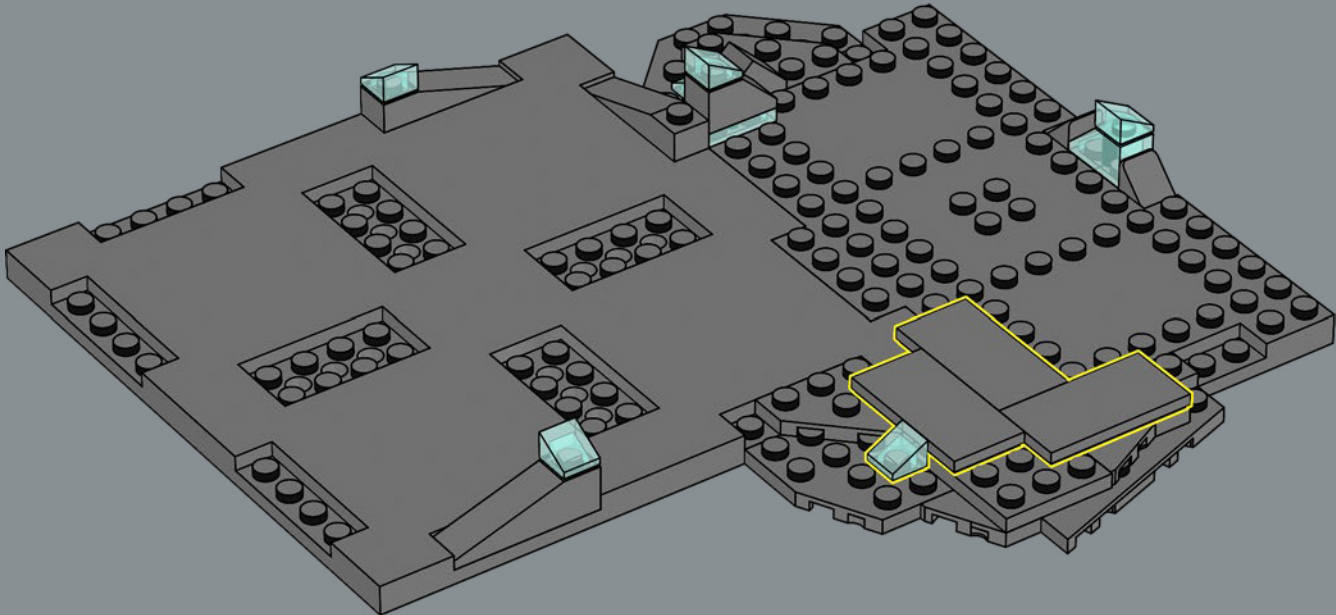



133

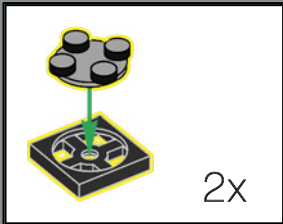
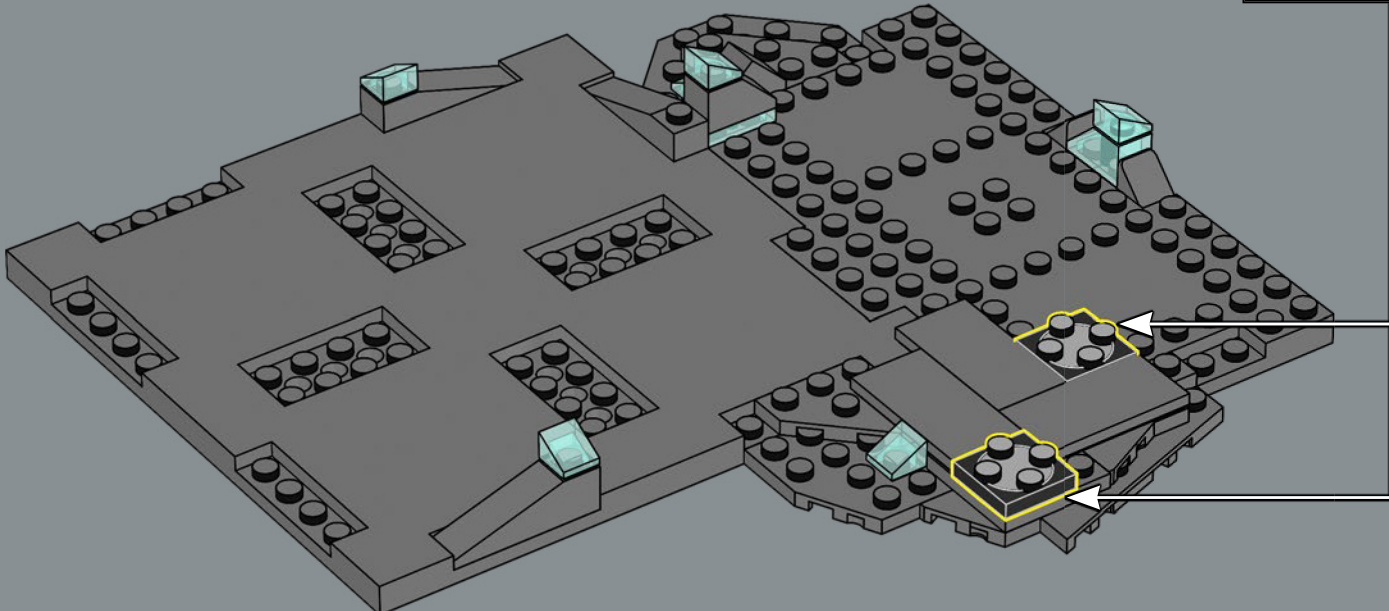



1x

134

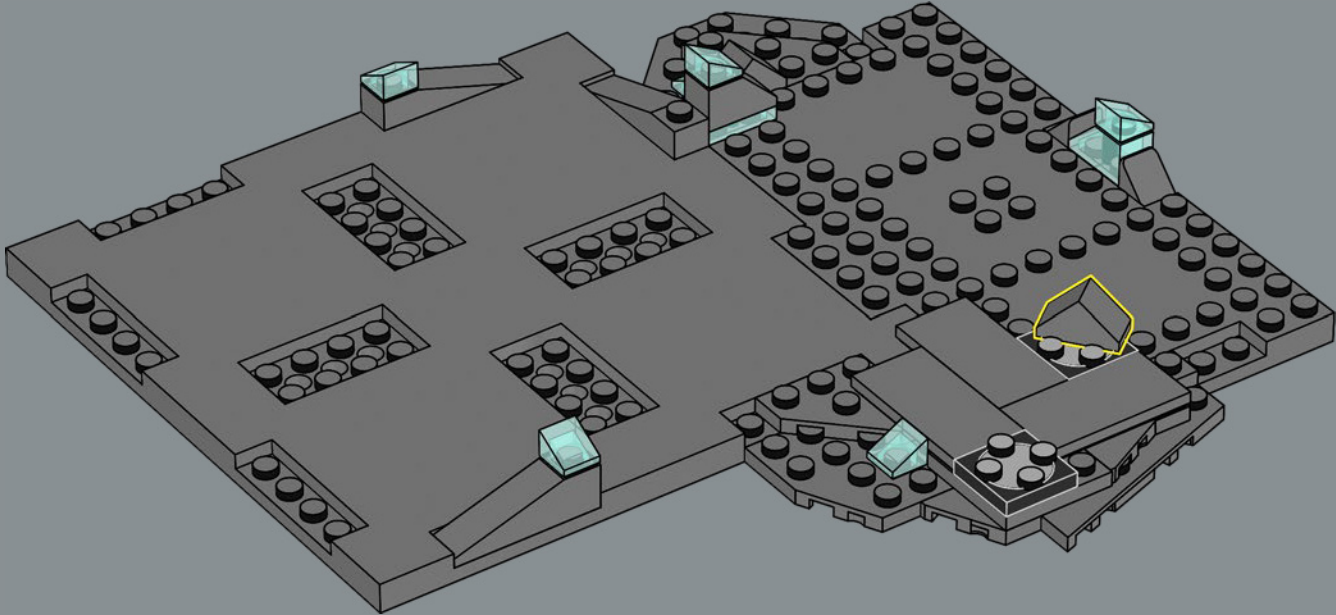

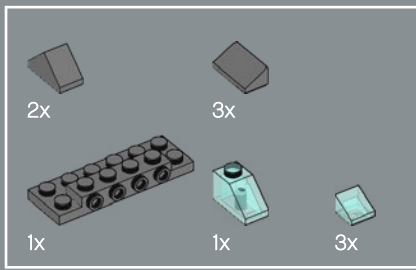

135

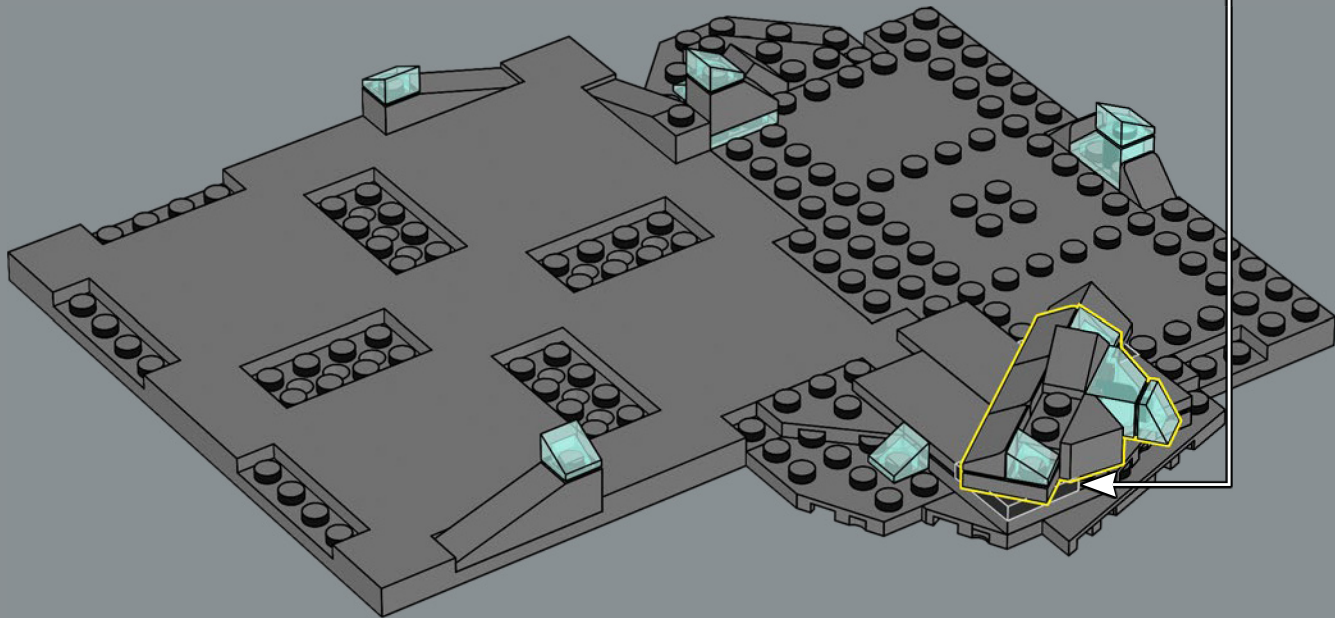
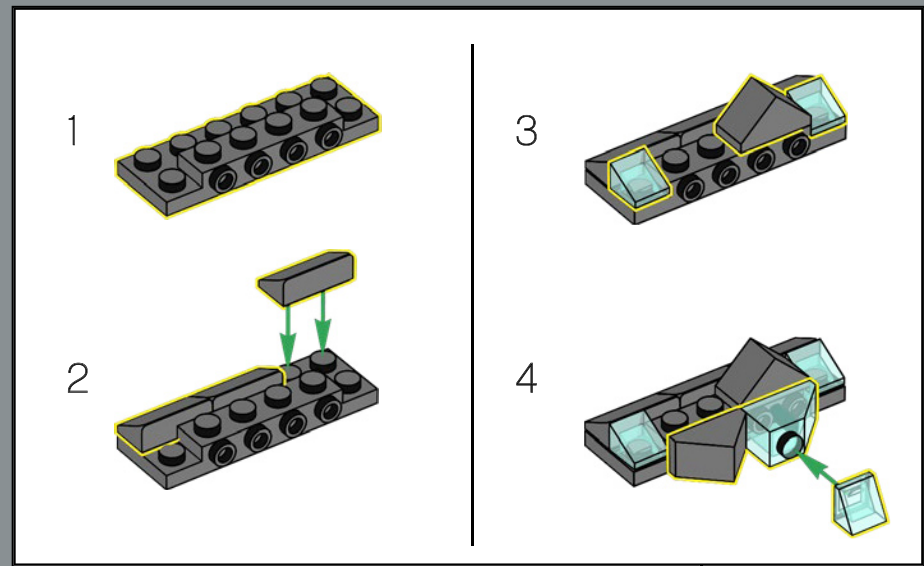

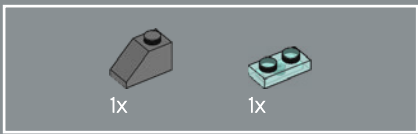

136

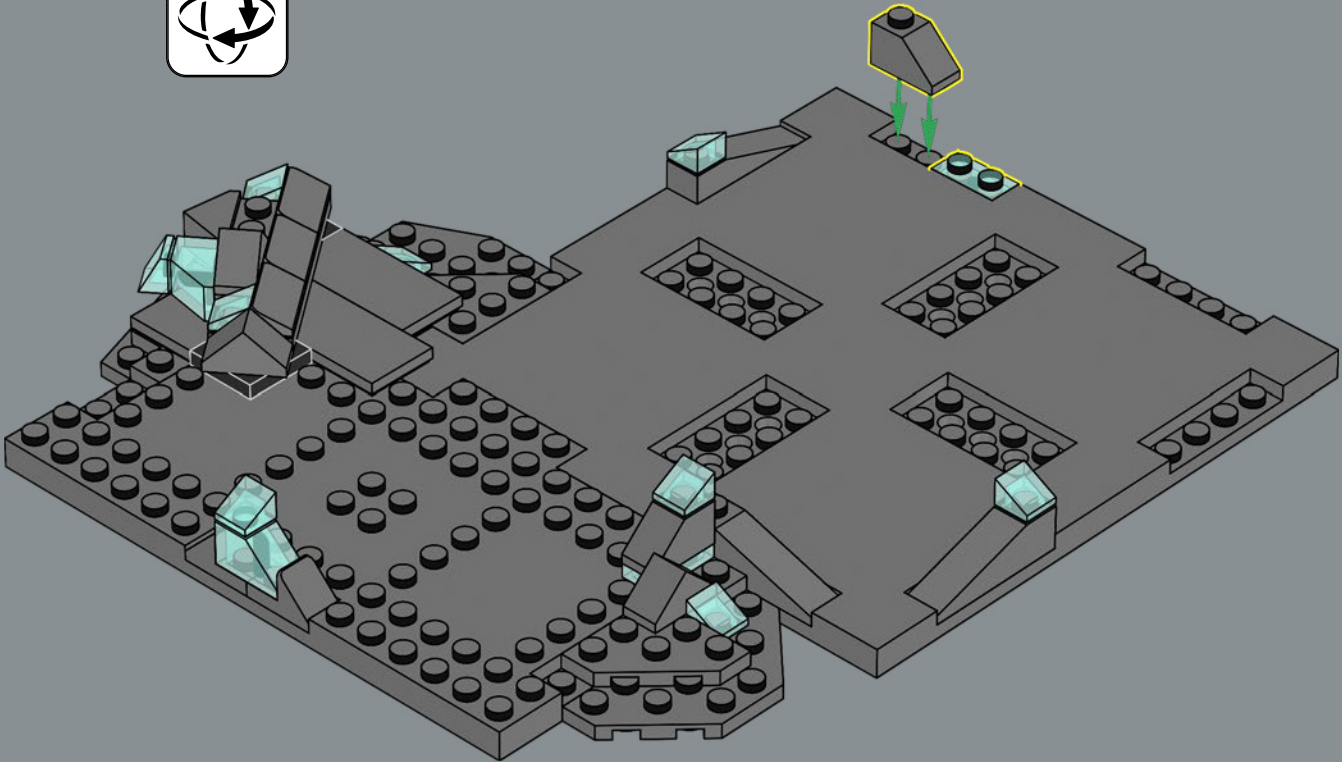



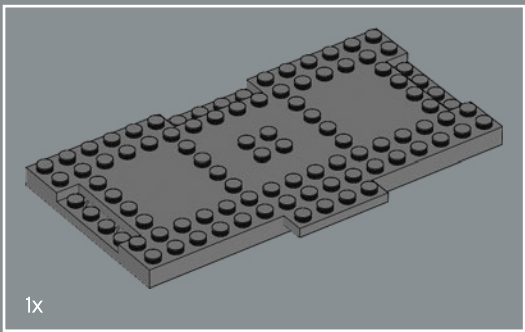

137

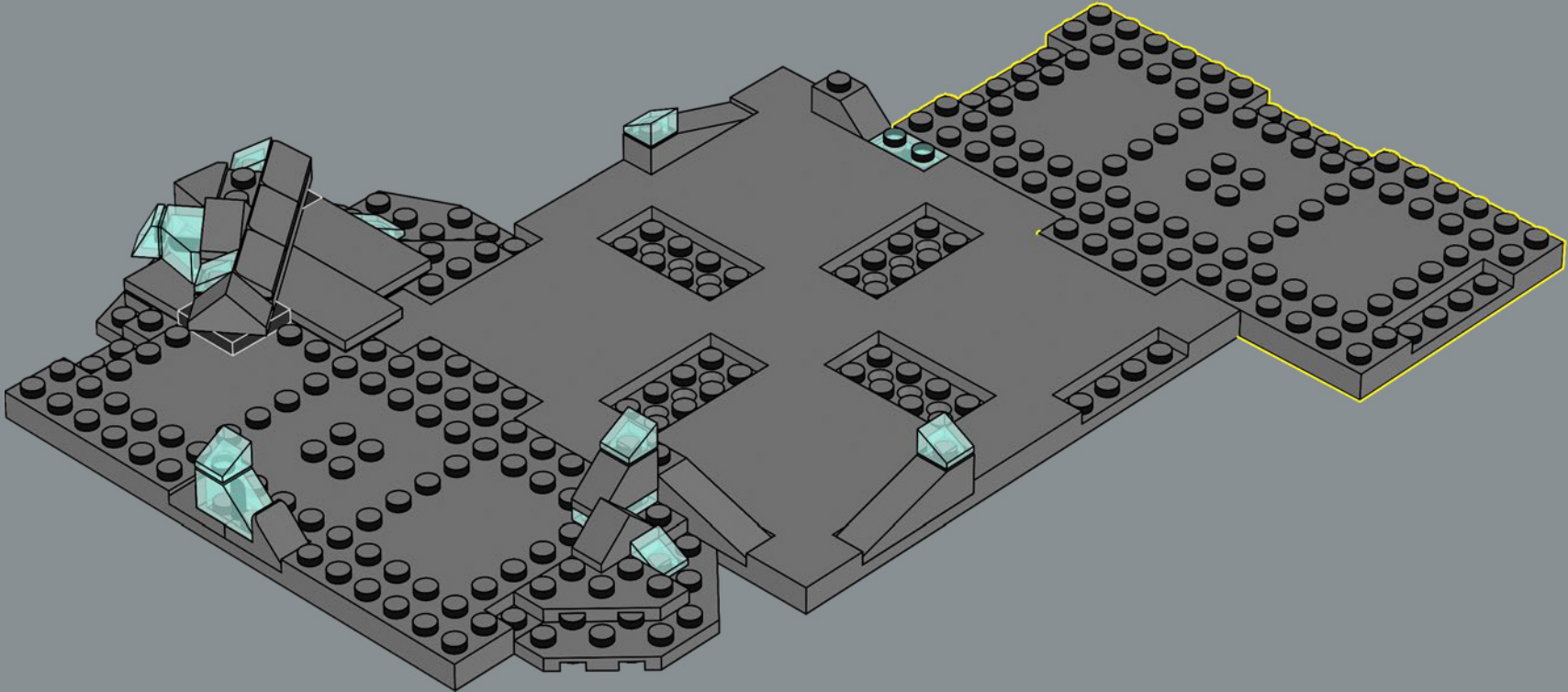

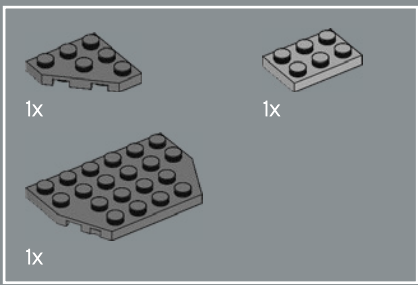

138

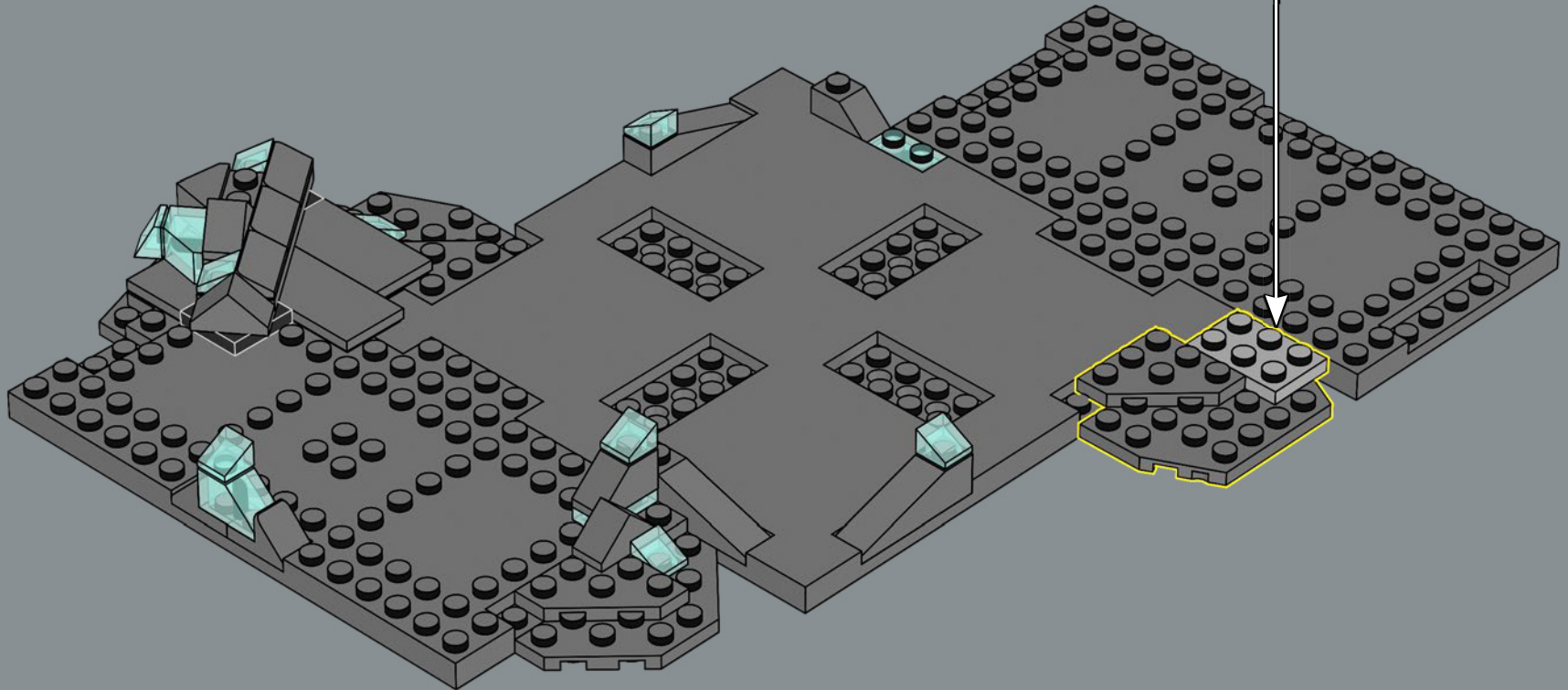
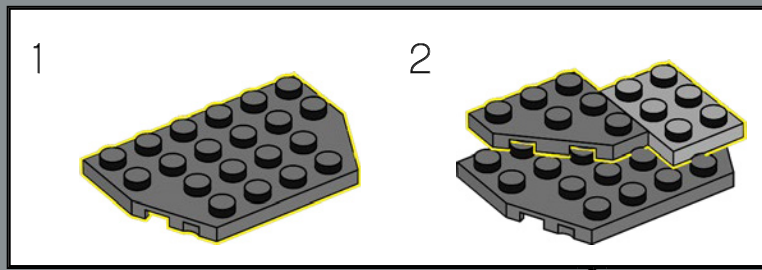

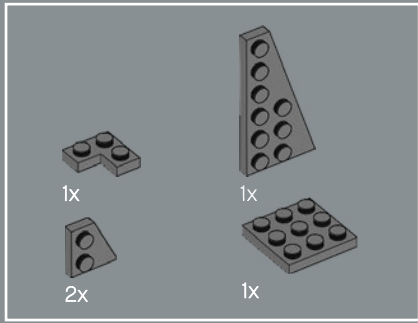

139

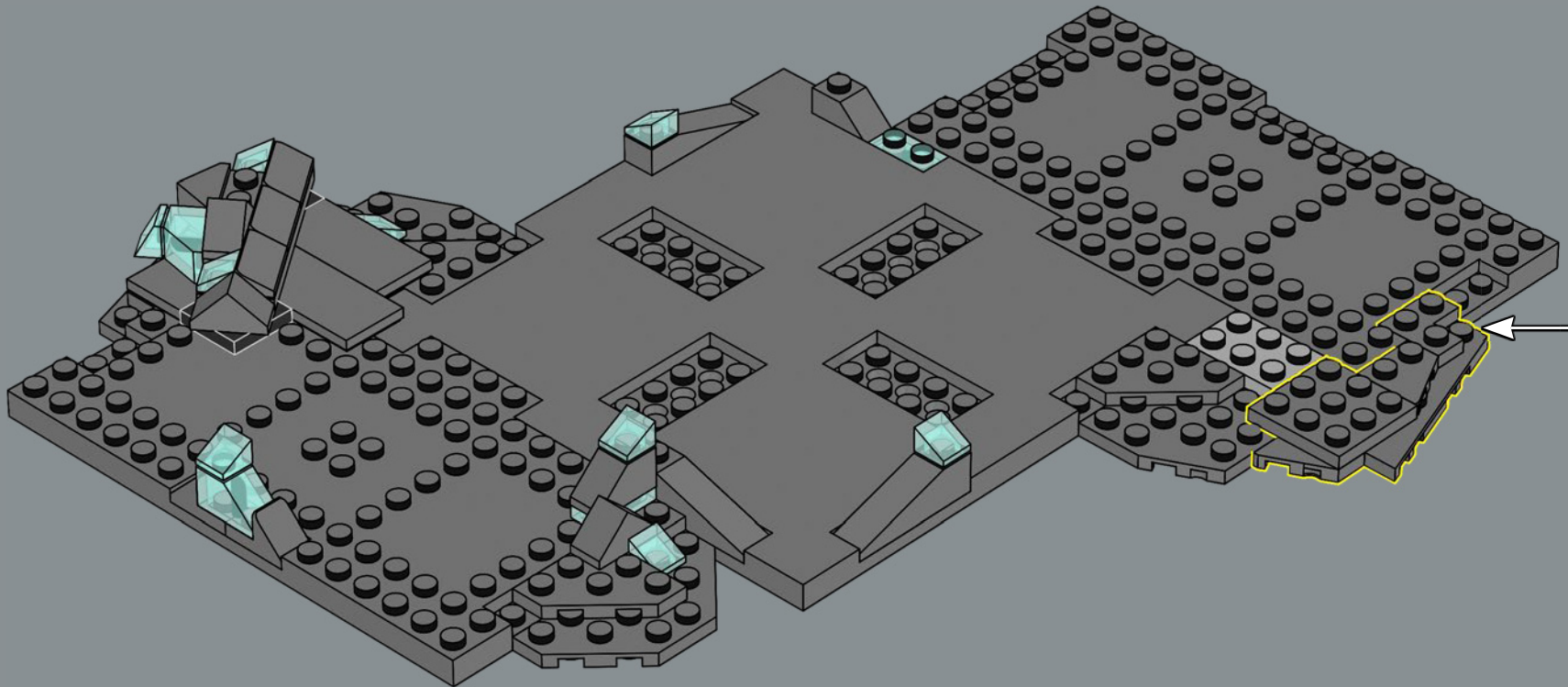
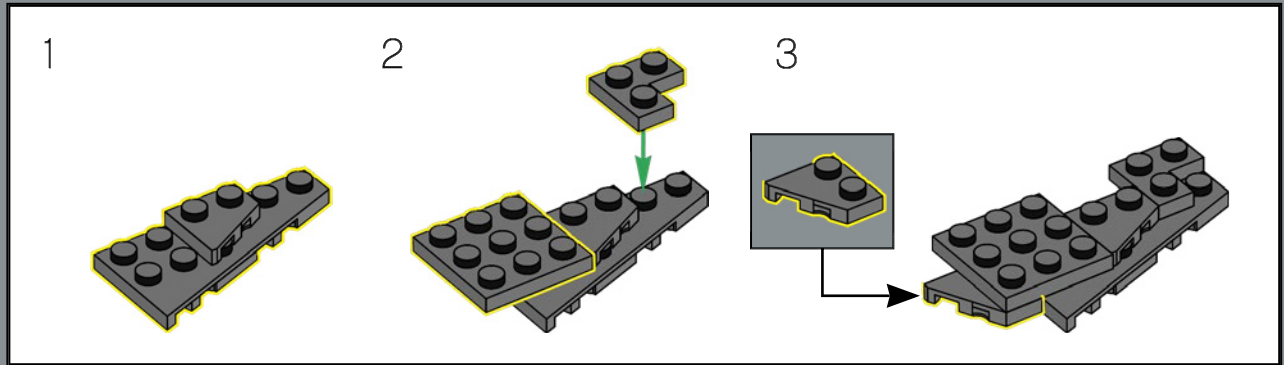

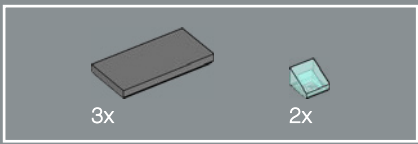

140

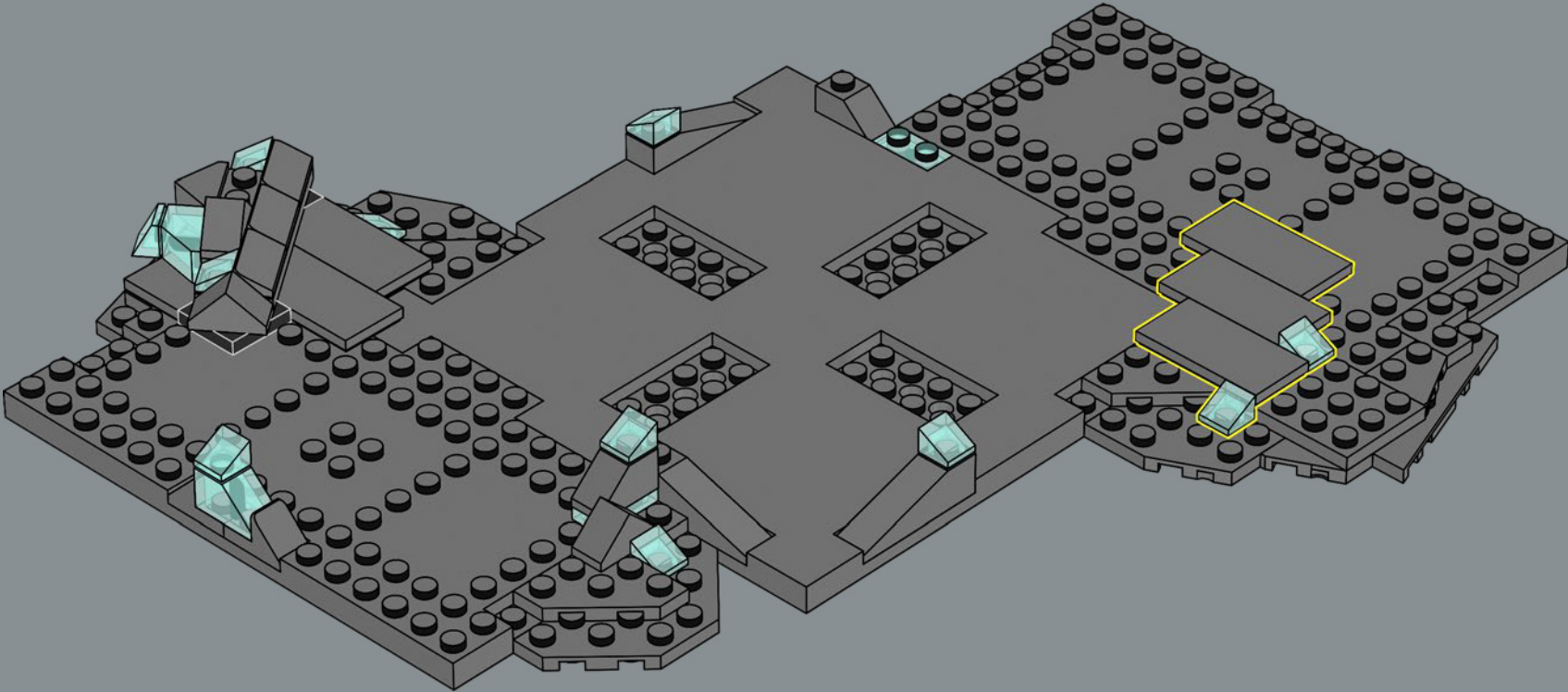



141

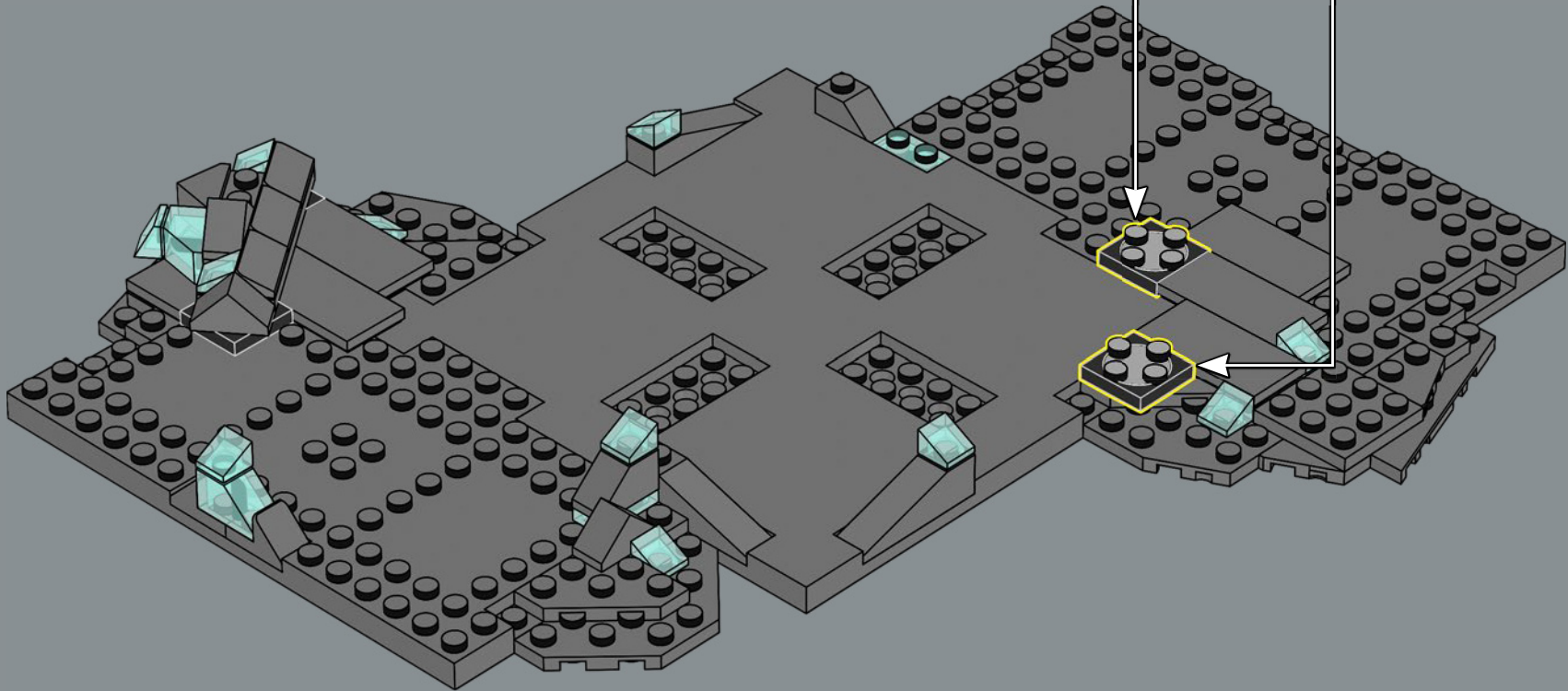
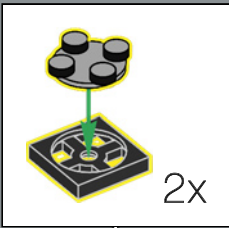

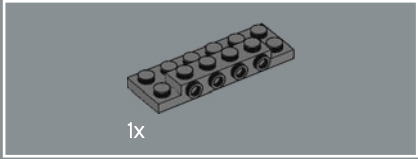
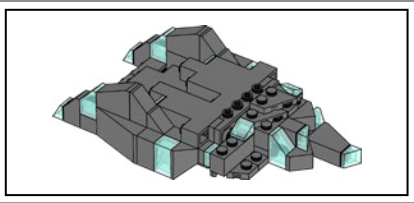

1x

142

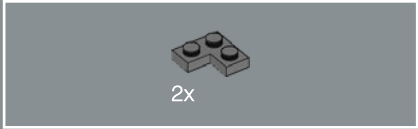
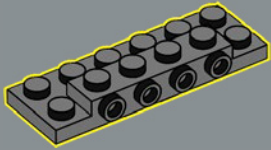

2x

143

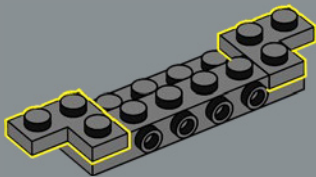

2x

144



2x

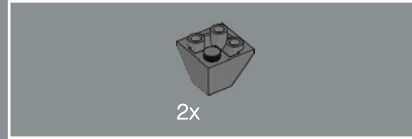
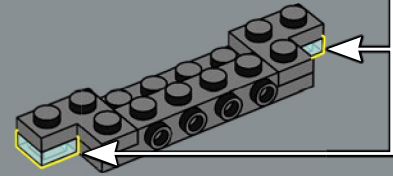

2x

145

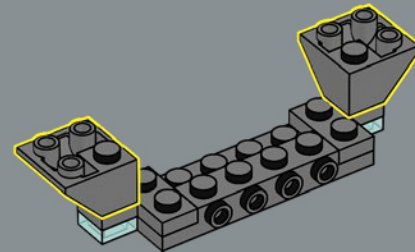

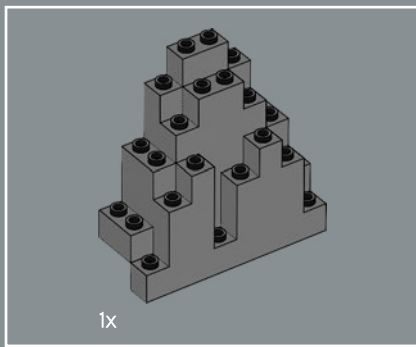

146

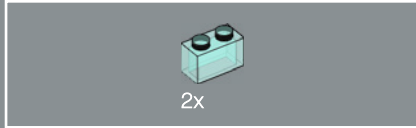
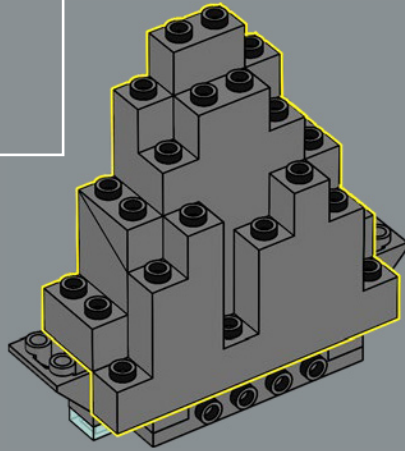

147

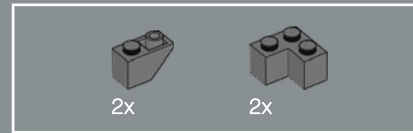
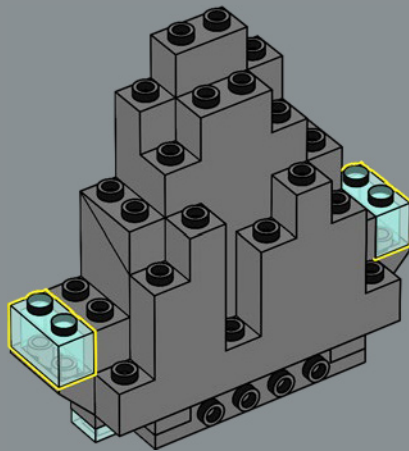

148

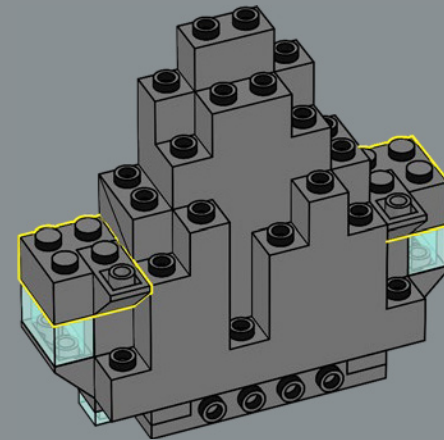



2x

149

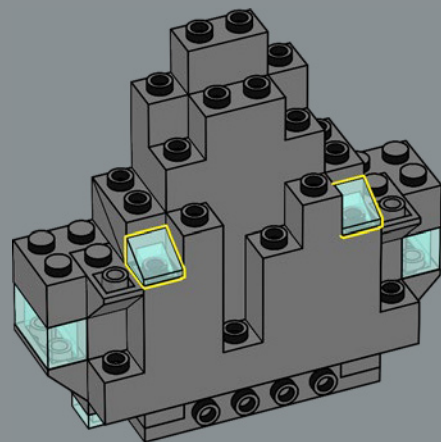

2x

150

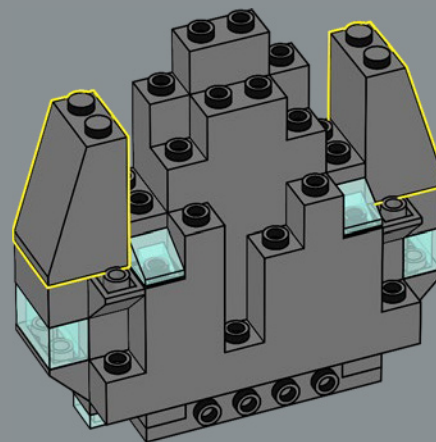



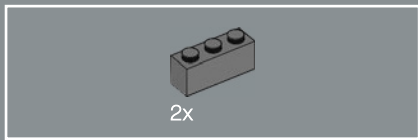

151

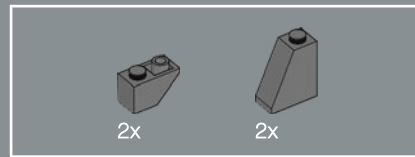
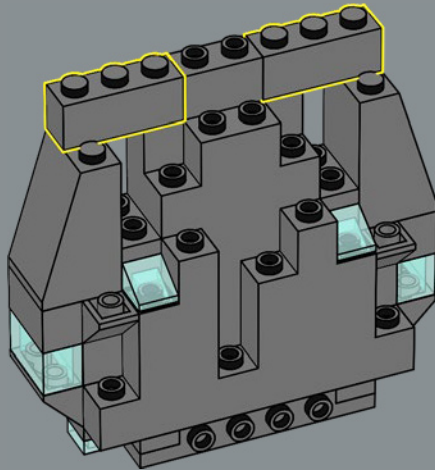

152

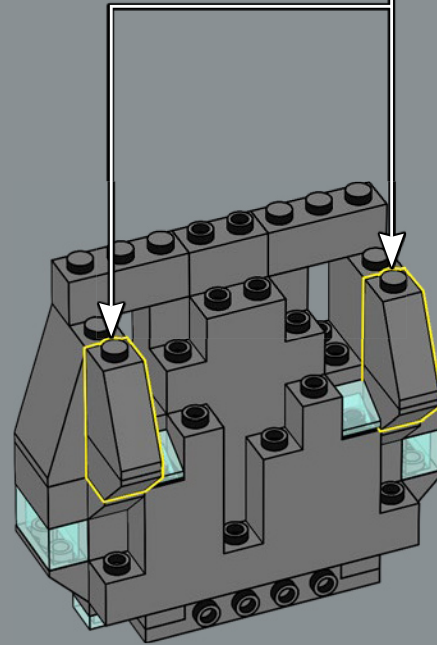
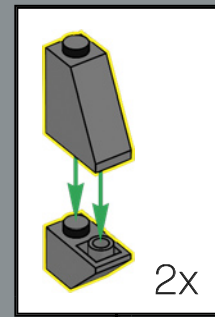



2x

153

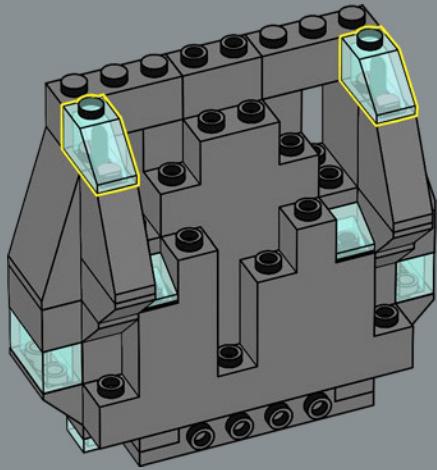

2x



2x

154

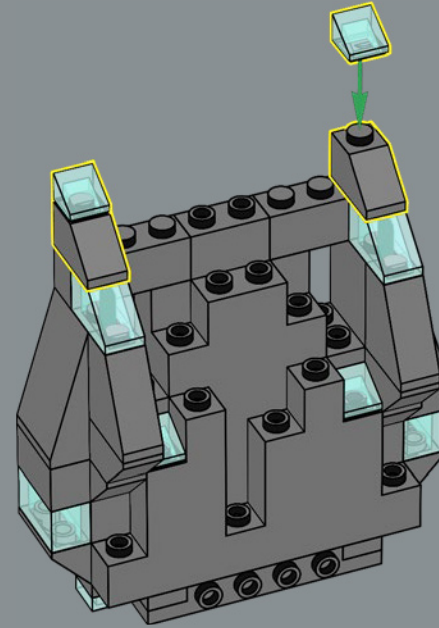

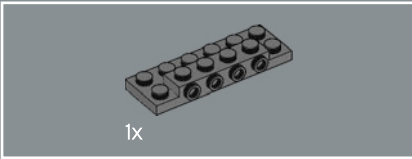
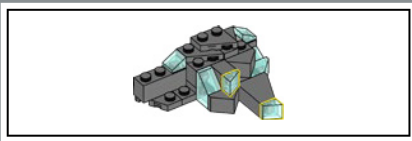

155

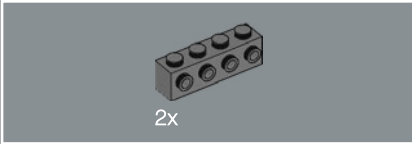
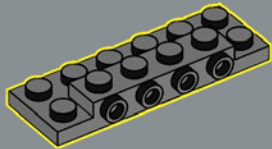

156

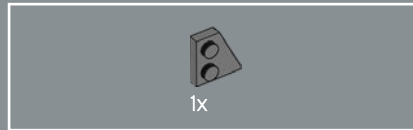
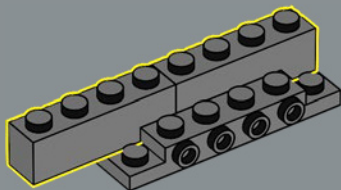

157

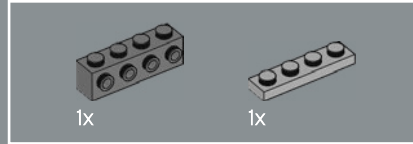
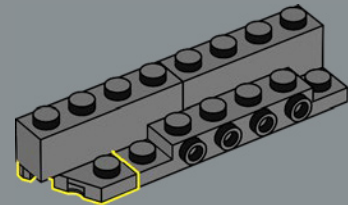

158

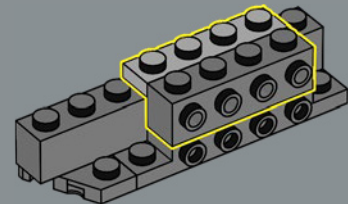

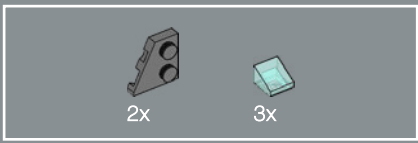

159

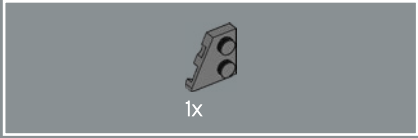
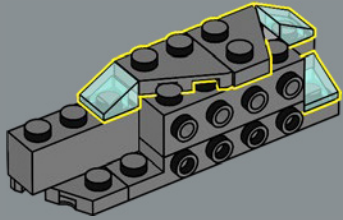

160

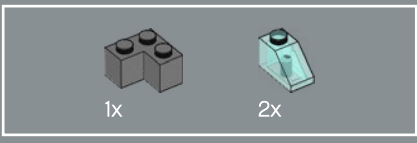
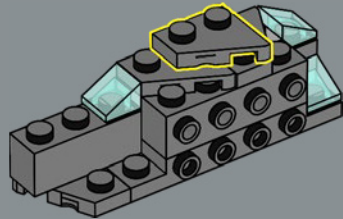

161

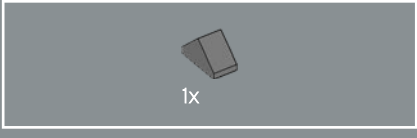
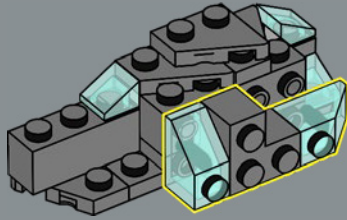

162

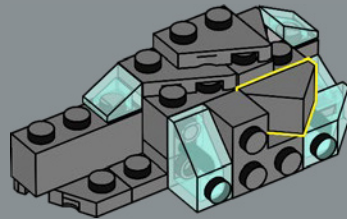

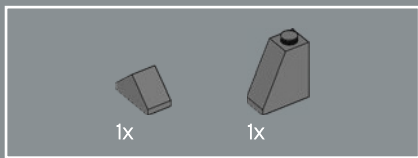

163

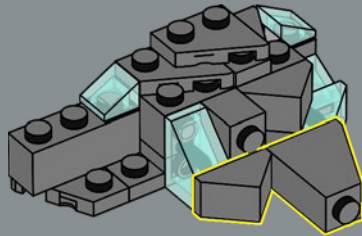

164

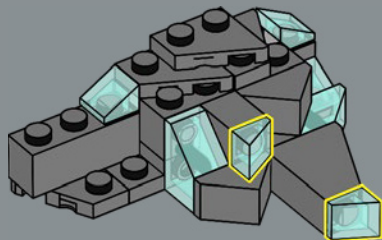

165

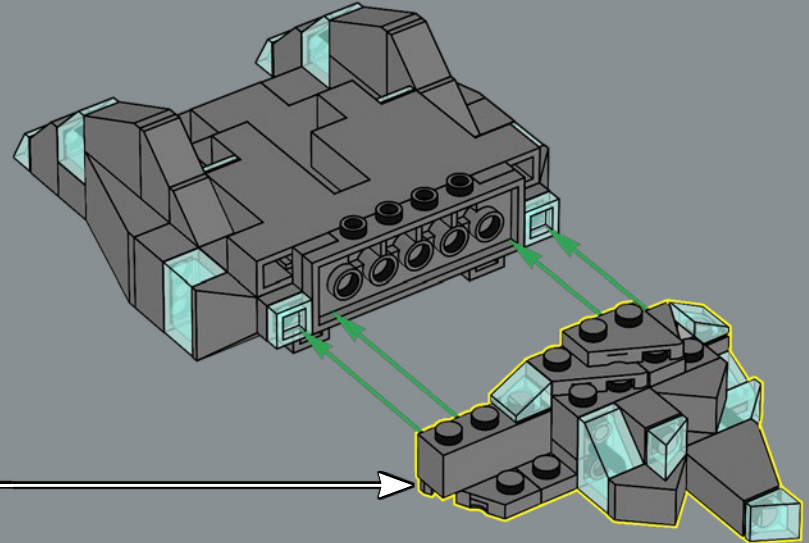

166

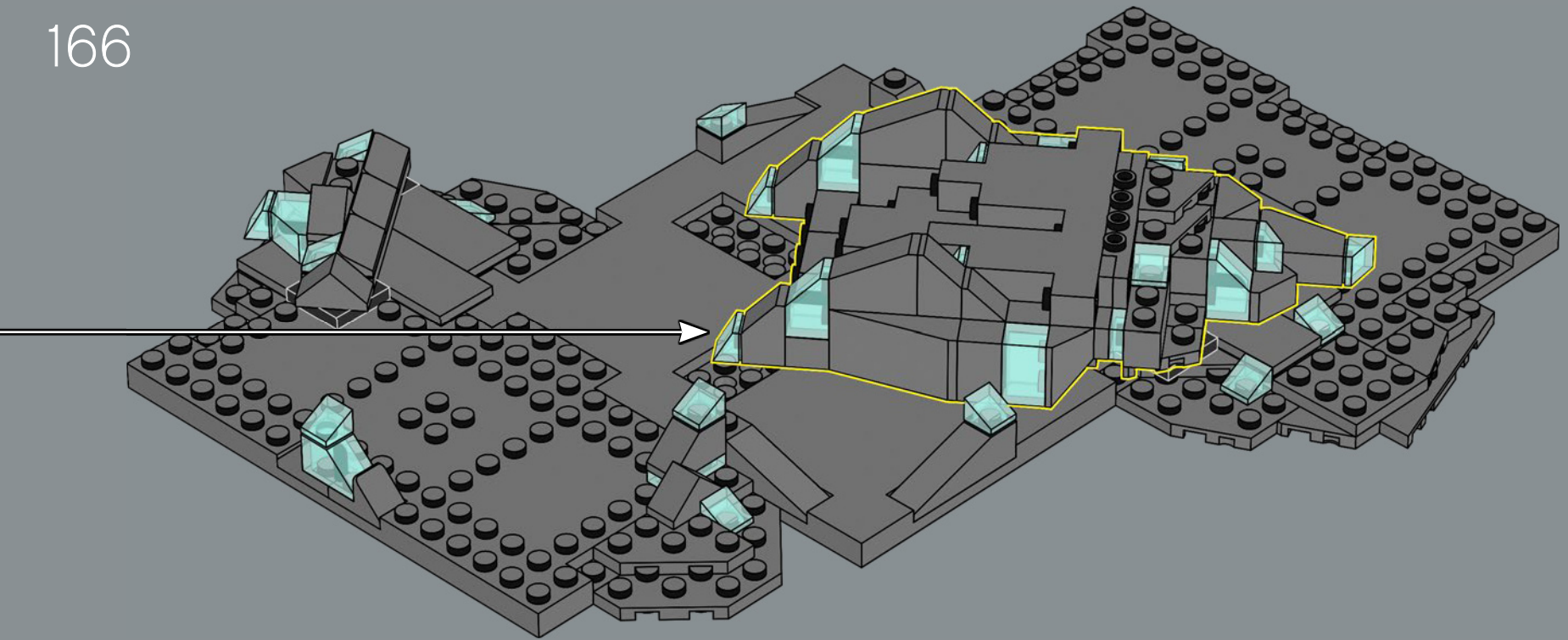

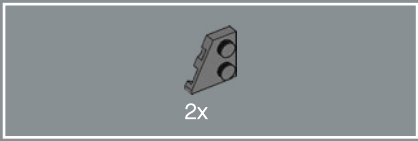

167

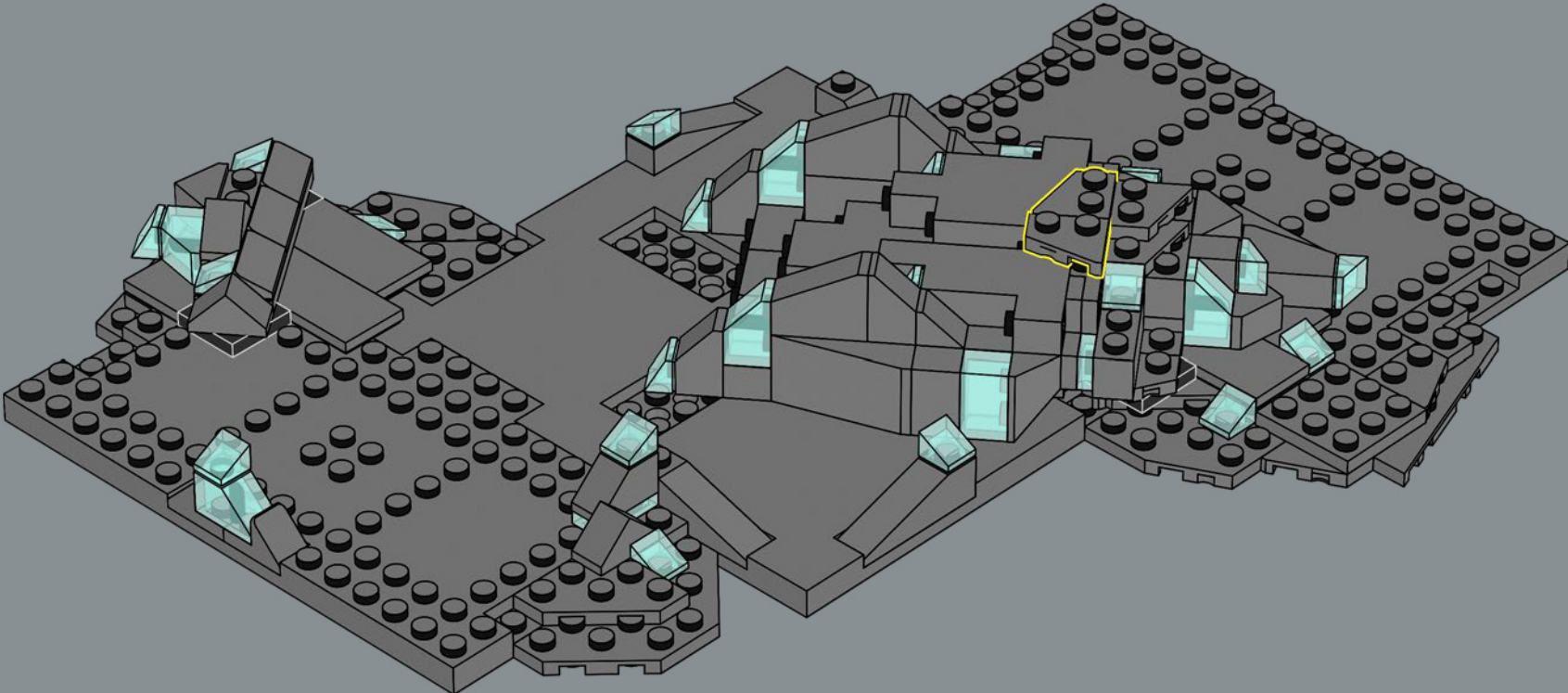

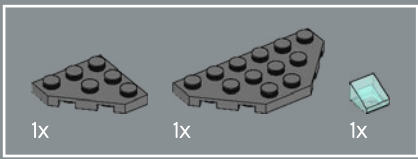

168

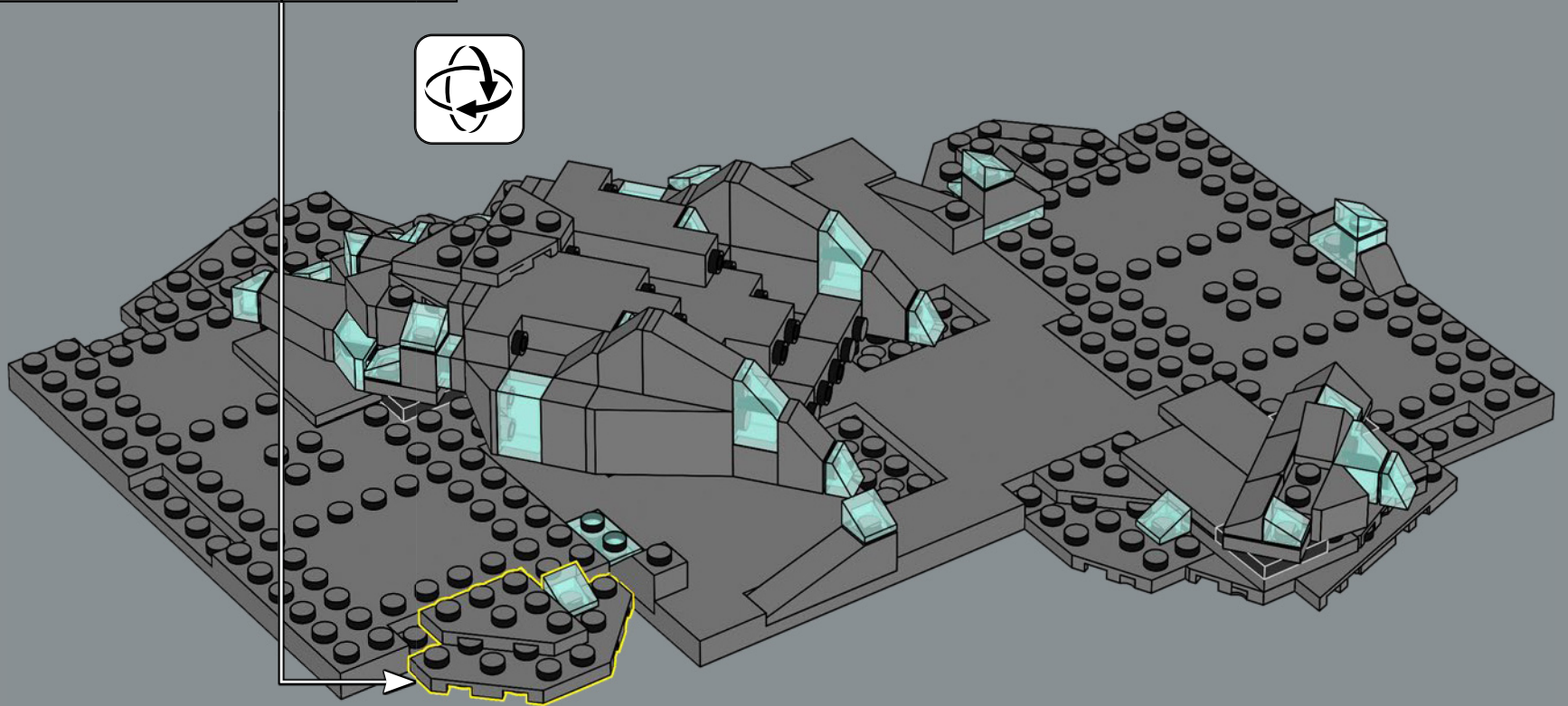
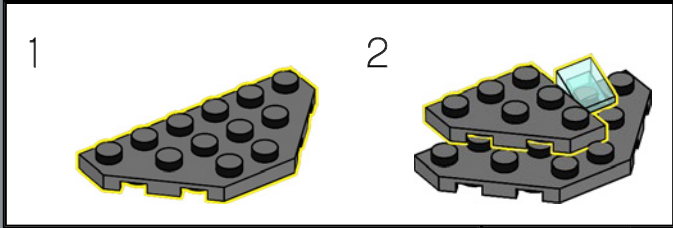



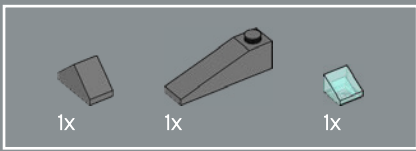

169

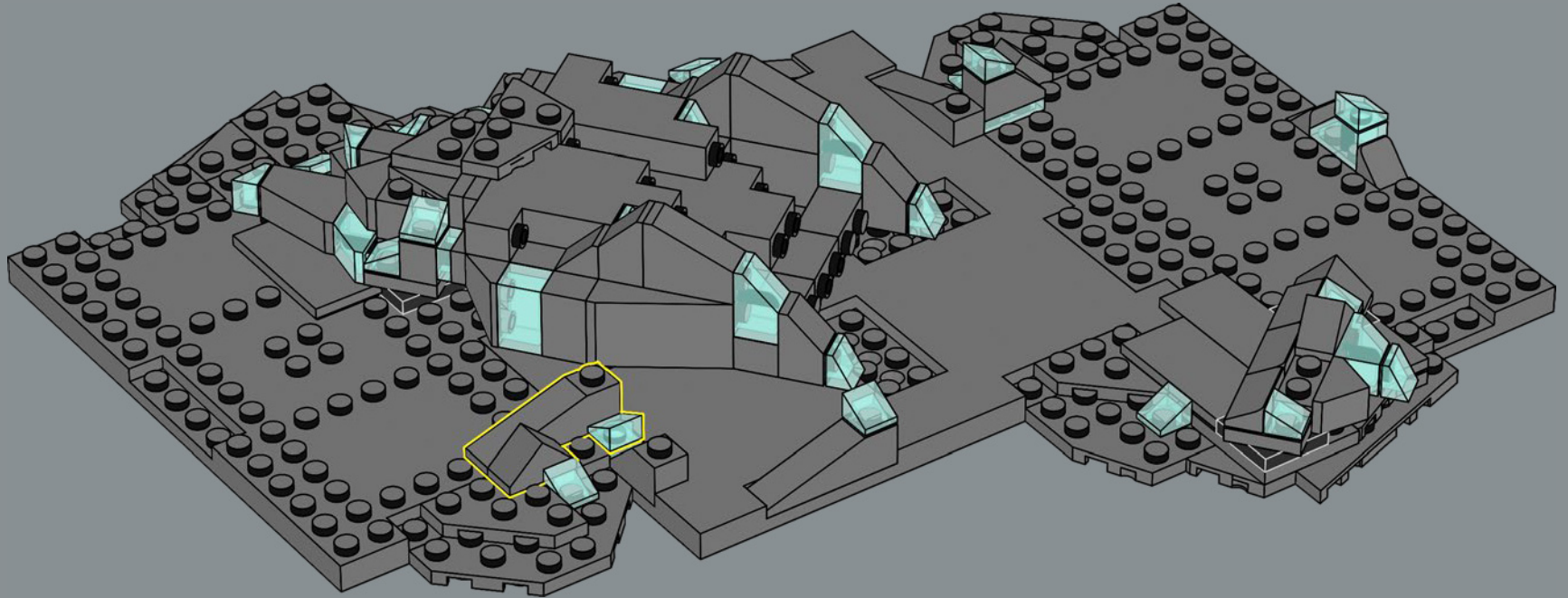



2x

170

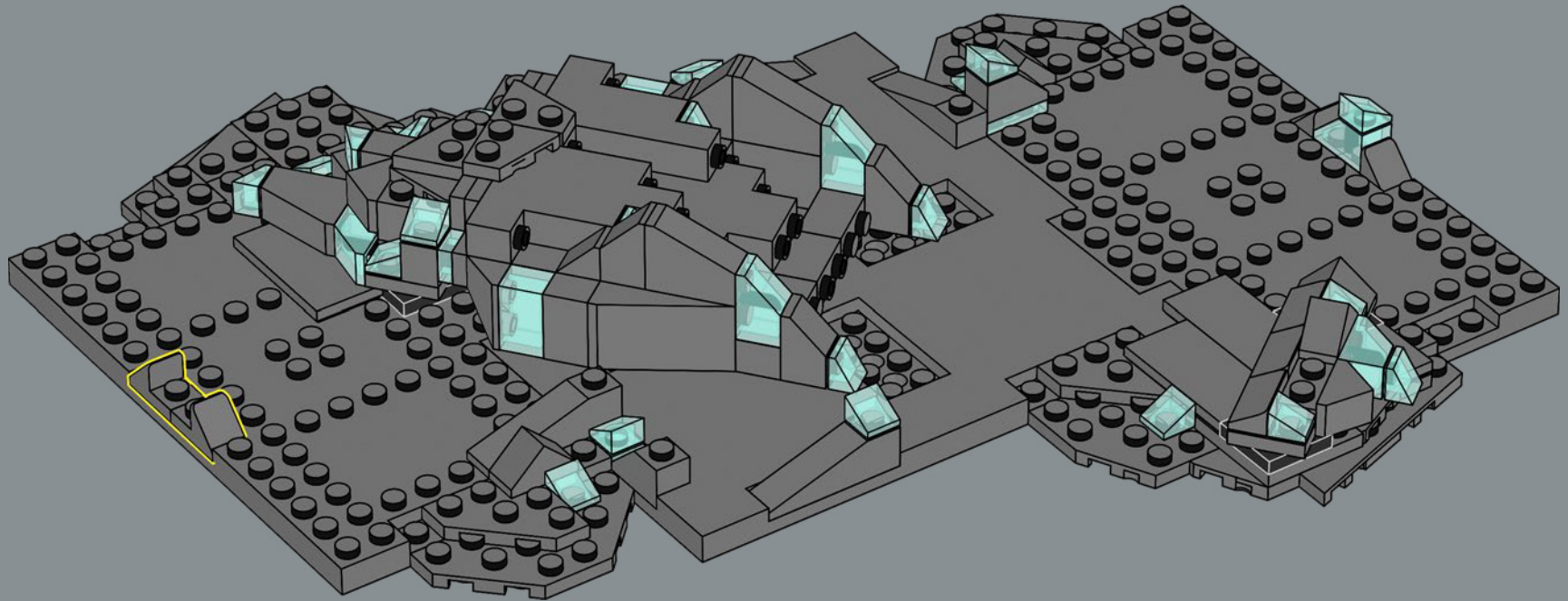

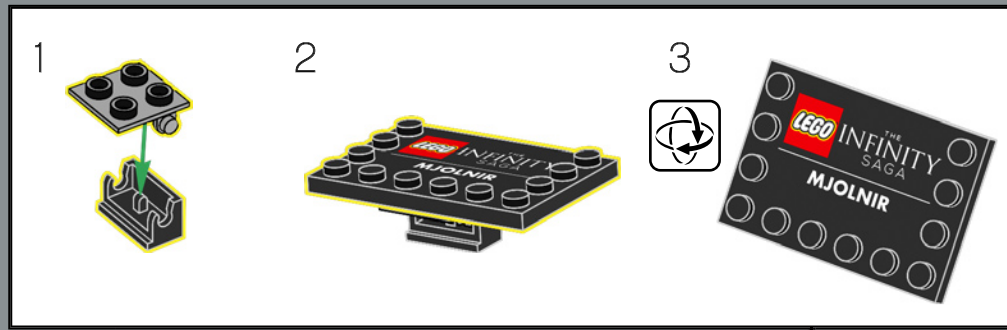
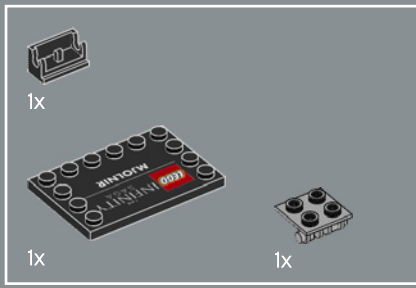

171

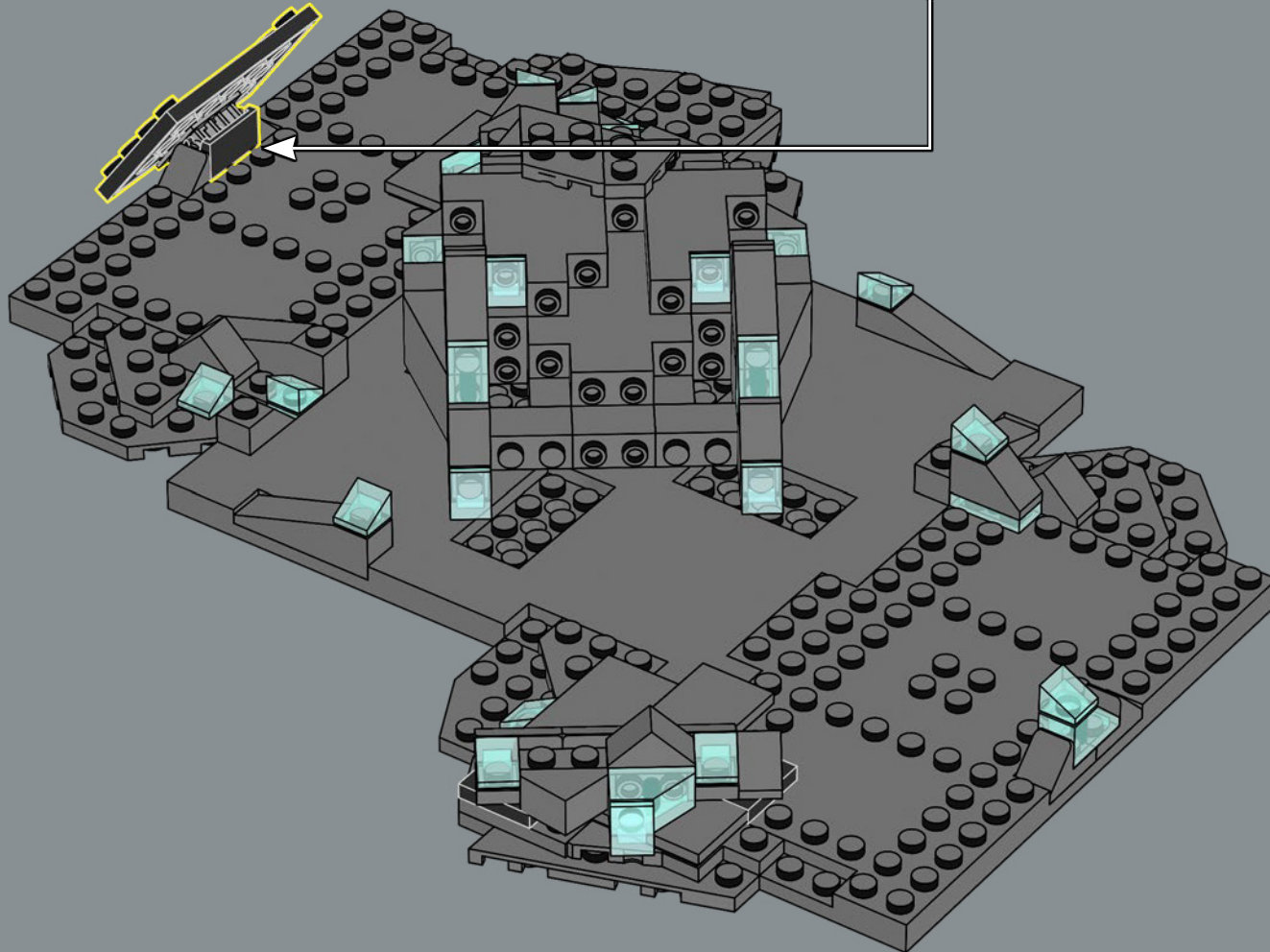





# FEEDBACK AND WIN



## FEEDBACK AND WIN

Your feedback will help shape the future development of this product series.

Please visit:

## FEEDBACK UND GEWINNEN

Dein Feedback trägt zur Weiterentwicklung dieser Produktreihe bei.

Geh auf:

## COMMENTEZ ET GAGNEZ

Vos commentaires nous aideront à concevoir les futurs produits de cette gamme.

Rendez-vous sur :

## COMENTA Y GANA

Tu opinión nos ayudará a dar forma al desarrollo de esta serie de productos en el futuro.

Visita:

## 反馈有奖

您的反馈将有助于我们在今后改进本系列产品。

请访问：

[LEGO.com/productfeedback](https://www.lego.com/productfeedback)

By completing, you will automatically enter a drawing to win a LEGO® set.

Terms & Conditions apply.

Durch Ausfüllen nimmst du automatisch an der Verlosung eines LEGO® Preises teil.

Es gelten die Teilnahmebedingungen.

En envoyant vos commentaires, vous serez automatiquement inscrit(e) à un tirage au sort qui vous permettra de remporter un prix LEGO®.

Offre soumise à conditions.

Al contestar, participarás automáticamente en el sorteo y podrás ganar un set LEGO®.

Sujeto a Términos y Condiciones.

完成我们的反馈调查，即可自动进入抽奖环节，赢取乐高®套装。

适用《条款和条件》。



8x  
4113261



30x  
6097637



8x  
428701



4x  
6168618



4x  
389401



8x  
4560929

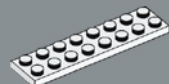

2x  
303401



8x  
4579260



1x  
6294704



23x  
4114084



4x  
4114077



8x  
6132769



2x  
4113993

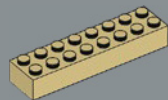

4x  
6037398



4x  
4651524



4x  
303921



4x  
370121



1x  
6305110



2x  
383221



14x  
300423



1x  
6186675



48x  
6279875



1x  
9339



1x  
393726



8x  
6138173



4x  
368026



31x  
300326



1x  
6395354



16x  
300126



8x  
4160025



1x  
6376667

1x  
6317515



1x  
6221209



8x  
6238677



14x  
6240225



22x  
6245277



2x  
6252043



6x  
6373578



1x  
6351673



2x  
6244910



2x  
6240222



1x  
6223000



1x  
6294243



1x  
6222339



1x  
4255413



1x  
6144754



1x  
4505985



4x  
6389696



1x  
6314353



1x  
6223003



112x  
4658005



2x  
4211399



2x  
4211389



8x  
6267495



2x  
4211475



1x  
4211512



4x  
4540203



20x  
6213378



4x  
4211388



4x  
4211398



8x  
4211414



4x  
4211564



26x  
6117967



16x  
4654580



1x  
6004729



4x  
6217876



1x  
4667578



8x  
4211413



16x  
6212077



**Customer Service**  
**Kundenservice**  
**Service Consommateurs**  
**Servicio Al Consumidor**

[LEGO.com/service](http://LEGO.com/service) or dial



00800 5346 5555 :

1-800-422-5346 :





1x  
4211881



8x  
4211410



1x  
4211815



8x  
6251044



4x  
4558169



4x  
4211773



4x  
4507056



6x  
4211396



4x  
4180418



1x  
4211445



8x  
4211394



44x  
4622803



20x  
6059033



3x  
4515351



4x  
4180408



44x  
4509915



2x  
6186338



1x  
6015349



8x  
6318584



2x  
4211481



4x  
4509914



18x  
6014617



8x  
4617862



8x  
4211522

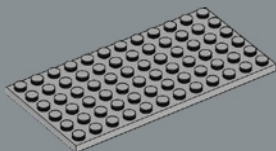

8x  
4211400

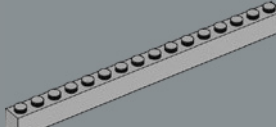

8x  
4211366

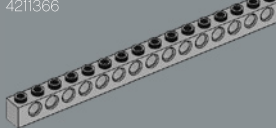

20x  
4211443



8x  
6271752



5x  
6143417



5x  
6143423



7x  
4226221



3x  
4567887



4x  
4211096



4x  
6069164



3x  
6013658



4x  
4211135



2x  
4290150



2x  
4210862



8x  
4211000



4x  
4210635



2x  
6000853



3x  
4211109



2x  
4211104



20x  
6118832



19x  
4210725



4x  
4211001



4x  
4210897



6x  
4560184



2x  
4210984



3x  
6401210



2x  
4521572



1x  
4216709



8x  
4211107



1x  
4211061



4x  
4535930



2x  
6039176

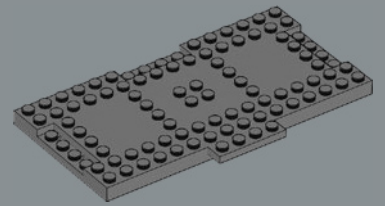

2x  
6112762

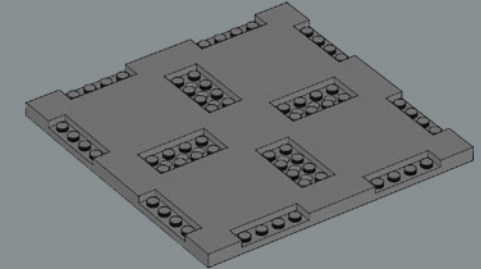

1x  
6325635



1x  
6350081



3x  
6347982



1x  
6376572



1x  
6223006

3

