

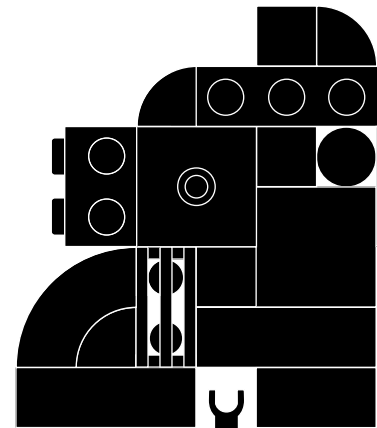

1

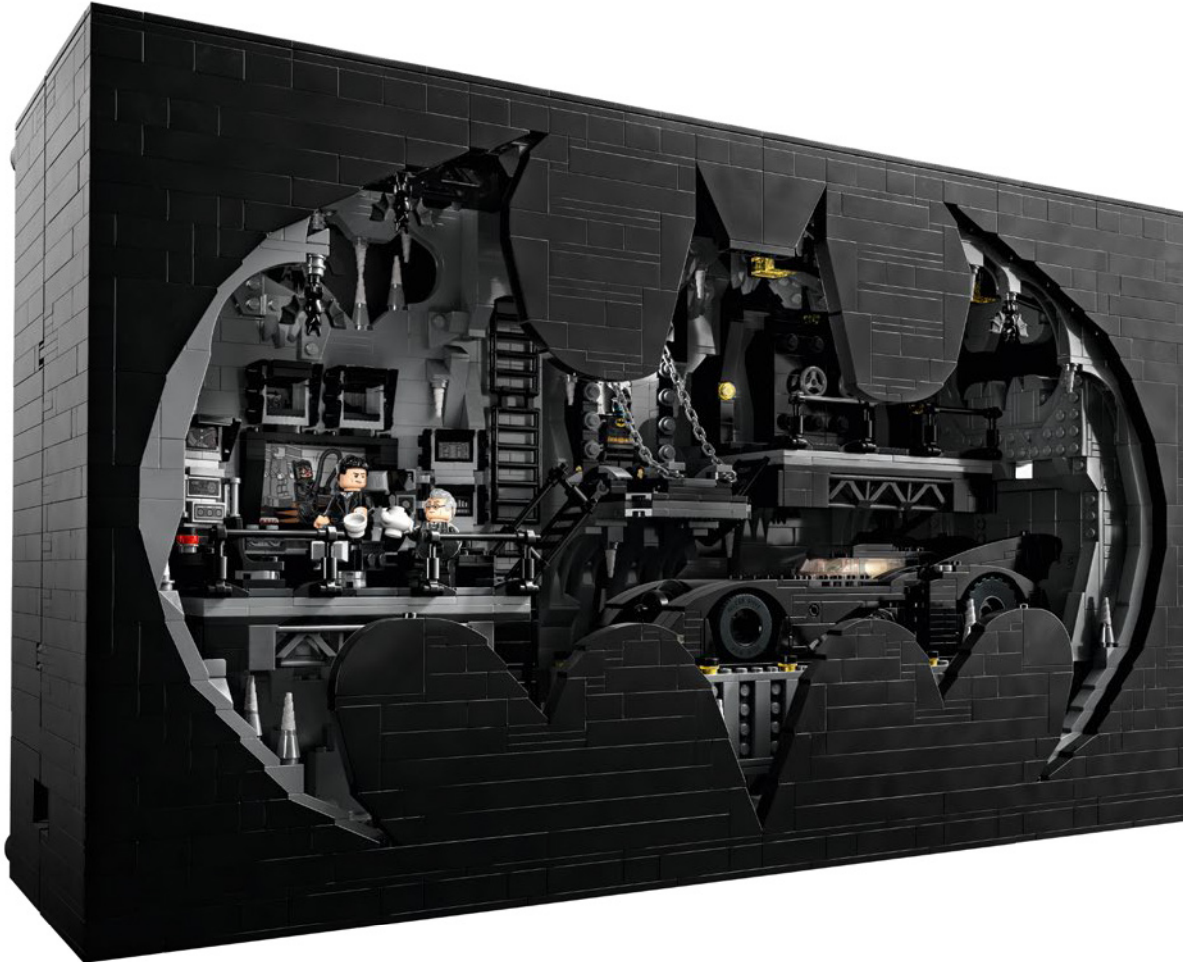



[LEGO.com/sustainable-packaging](https://LEGO.com/sustainable-packaging)



# LEGO® VIP

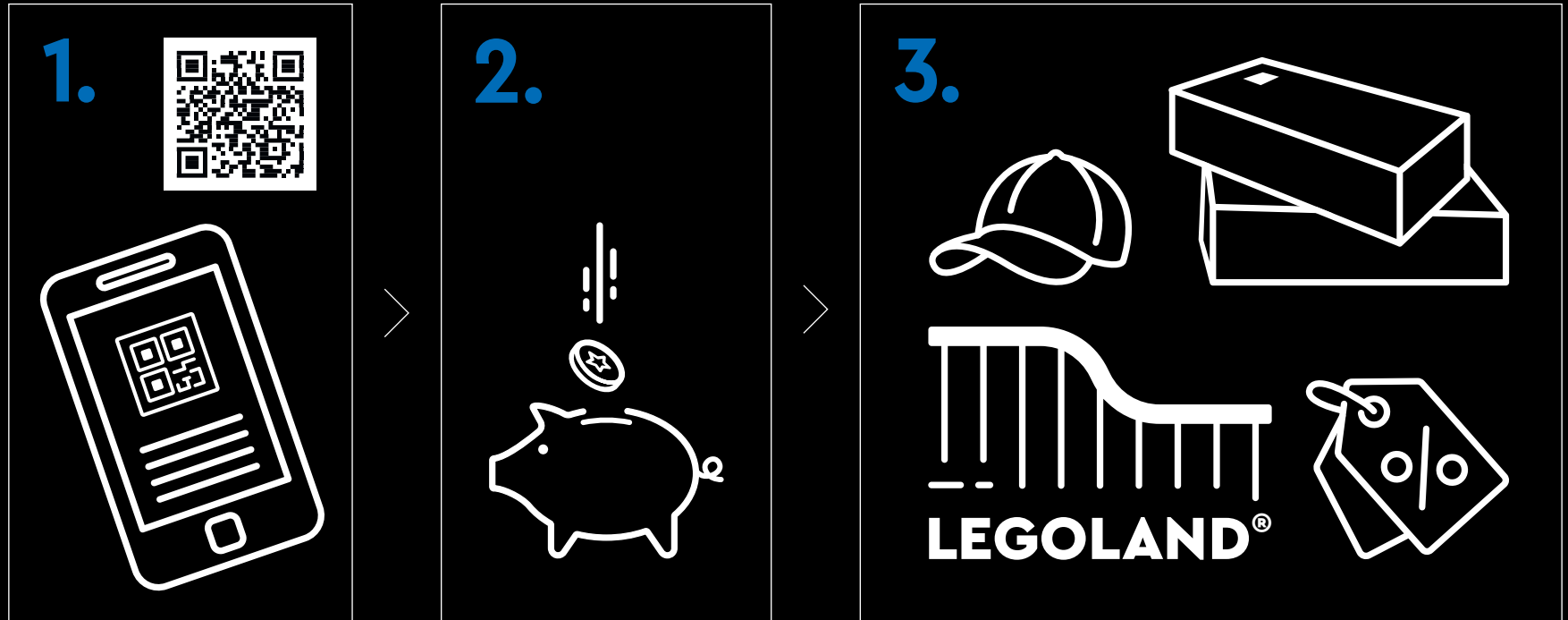

**1.** Sign up **2.** Earn points for purchases **3.** Redeem points for rewards, experiences, discounts & more | **1.** Melde dich an **2.** Sammle Punkte bei jedem Kauf **3.** Löse die Punkte für Belohnungen, Erlebnisse, Rabatte und Ähnliches ein | **1.** Inscrivez-vous **2.** Gagnez des points lors de vos achats **3.** Échangez vos points contre des récompenses, des expériences, des remises et bien plus encore | **1.** Iscriviti **2.** Guadagna punti con i tuoi acquisti **3.** Riscatta punti per premi, esperienze, sconti e altro ancora | **1.** Regístrate **2.** Gana puntos por tus compras **3.** Canjea puntos por recompensas, experiencias, descuentos y mucho más | **1.** Registe-se **2.** Ganhe pontos em compras **3.** Troque os pontos para prémios, experiências, descontos e muito mais | **1.** 注册 **2.** 购物赚积分 **3.** 用积分兑换奖励、体验、折扣等 | **1.** Zarejestruj się **2.** Zdobywaj punkty za zakupy **3.** Wymieniaj punkty na rabaty, przygody i inne nagrody | **1.** Zaregistrujte se **2.** Sbírejte body za nákupy **3.** Vyměňujte body za odměny, zážitky, slevy a spoustu dalšího | **1.** Zaregistrujte se **2.** Získavajte body za nákupy **3.** Uplatnite si body a získajte odmeny, rôzne zážitky, zľavy a ešte viac | **1.** Regisztrálj **2.** Szerez pontokat minden vásárlással **3.** Váltsd be pontjaidat jutalmakra, élményekre, kedvezményekre és egyebekre | **1.** Înscric-te **2.** Câștigă puncte pentru achiziții **3.** Valorifică puncte pentru recompense, experiențe, reduceri și multe altele | **1.** Регистрируйте се **2.** Получайте точки за покупки **3.** Используйте точки за награды, услуги, отстъпки и т.н. | **1.** Reģistrējies **2.** Pelni punktus par pirkumiem **3.** Izmanto punktus, lai saņemtu balvas, izklaides iespējas, atlaides un daudz ko citu | **1.** Registreeru **2.** Teeni ostude eest punkte **3.** Lunasta punktide eest preemiad, elamused, allahindlused ja muu | **1.** Užsiregistruokite **2.** Pelnykite taškus už pirkinius **3.** Panaudokite taškus atlygiui, funkcijoms, nuolaidoms ir ne tik





“你一定得当全城唯一的‘人兽’吗？”

-阿尔弗莱德·潘尼沃斯

## 蝙蝠洞的秘密

这款影盒是一种介于传统相框和展示箱之间的精致且功能丰富的混合体，将珍贵的纪念品以一种富有创意的方式展现了出来。它为你的收藏品营造了恰到好处的氛围，而深度效果使它们构成一件独特的艺术品。第一款乐高®影盒模型充满蝙蝠洞气息，并揭示了蝙蝠洞秘密：蝙蝠洞是一位超级英雄具有传奇色彩的基地，其主人以隐藏的身份保护哥谭市，这似乎再合理不过了。

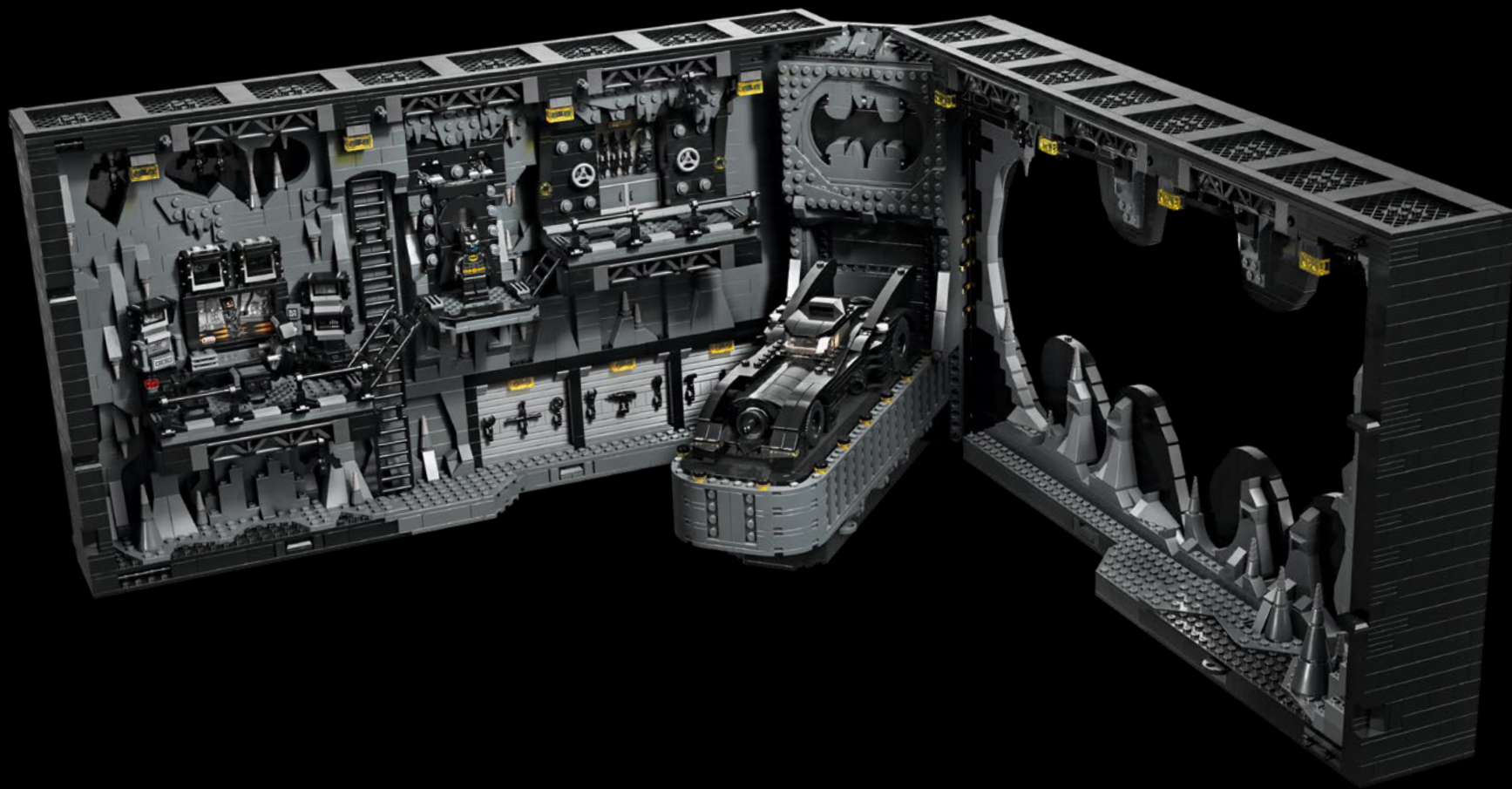





乐高® DC 蝙蝠侠设计师, 从左至右: Connie Bork, Bjarke Lykke Madsen, Daniel Lundin, Adam Corbally, Christian Barnkob, Carter Luce Baldwin, Jesper C. Nielsen, Ashwin Visser。

## 从概念到成品

创造任何一款乐高®套装, 无论大小, 都需要一个跨部门和跨职能的专家团队, 以带来最佳的拼搭和玩乐体验: 模型设计、美术设计、拼搭说明等。长期以来, 乐高 DC 蝙蝠侠创意负责人 Jesper C. Nielsen 一直有一个创意概念, 他称之为成年粉丝的“立体蝙蝠洞”: 一个复杂的立体模型, 结构紧凑, 可供展示在架子上。高级模型设计师 Bjarke Lykke Madsen 曾参与过四款乐高蝙蝠洞模型的制作, 并应邀探究这个想法能否以及如何通过一款可行的套装实现。



## 寻找灵感

Bjarke 从影盒设计和电影《蝙蝠侠归来》(1992 年) 中找到了灵感：“在《蝙蝠侠归来》中，你可以看到蝙蝠洞中所有这些令人惊叹的设计细节和功能。我产生了一个想法，影盒可以为其乐高® 版本增添艺术气息。Jesper 非常喜欢这个想法，并建议在前盖上引入镂空式蝙蝠侠标志。我们一致认为蝙蝠战车应该是蝙蝠洞的核心，所以我创造了镂空式蝙蝠侠标志，以容纳小人仔比例的蝙蝠战车。这也决定了模型的尺寸。然后我设计了第一个原型，其中包括蝙蝠战车平台、布置有计算机的工作区、存放蝙蝠战衣的保险库、工具柜等。”





## 组建超级英雄设计师团队

意识到这款模型的规模，Bjarke 便与模型设计师 Carter Luce Baldwin 携手合作，后者提出了通过打开盒子来查看平台的功能。两位设计师合作设计了第二个原型，其中包括打开功能，并改进了内部和平台的细节和功能。Carter 设计了主要入口，它被醒目的蝙蝠侠标志放大。Bjarke 在保险库内加了一块发光积木，以产生更多令人惊叹的效果，还设计了在计算机屏幕上切换图像的功能。为了凸显此功能，美术设计师 Daniel Lundin 为计算机屏幕设计了精致的贴纸。





## 微调功能和角色

在开发的最后阶段，高级模型设计师 Adam Grabowski 加入了团队，帮助优化模型，并对蝙蝠战车进行微调，以便于其通过主入口。高级模型指导 Christian Barnkob 和拼搭指导专家 Connie Bork 受邀就整体拼搭体验提供建议，由设计大师 Adam Corbally 和高级美术设计师 Ashwin Visser 搭档，以乐高“小人仔”形式捕捉并重现电影中的主要角色。



## 细节一览

· 本套装内含的 7 个小人仔中,有 5 个(布鲁斯·韦恩、阿尔弗莱德·潘尼沃斯、猫女、企鹅人和马克斯·史莱克)是全新的独家版小人仔。

· 两个蝙蝠侠小人仔拥有不同的斗篷和头盔设计:一个身披柔软的斗篷,允许他进入蝙蝠战车和保险库,另一个披着硬壳斗篷,可供在平台上展示。

· 转动模型背面的黄色旋钮,以触发平台和工作区中的功能。

· 将蝙蝠战车的尾焰组件存放在秘密的隐藏空间中。

· 打开保险库中的灯,带来令人惊叹的蝙蝠战衣展示效果。

· 爬上通往韦恩庄园的楼梯。

· 找到修复蝙蝠战车、蝙蝠战衣或装置在与反派战斗中遭受的损伤所需的工具。

· 放下吊桥,进入蝙蝠战衣保险库。

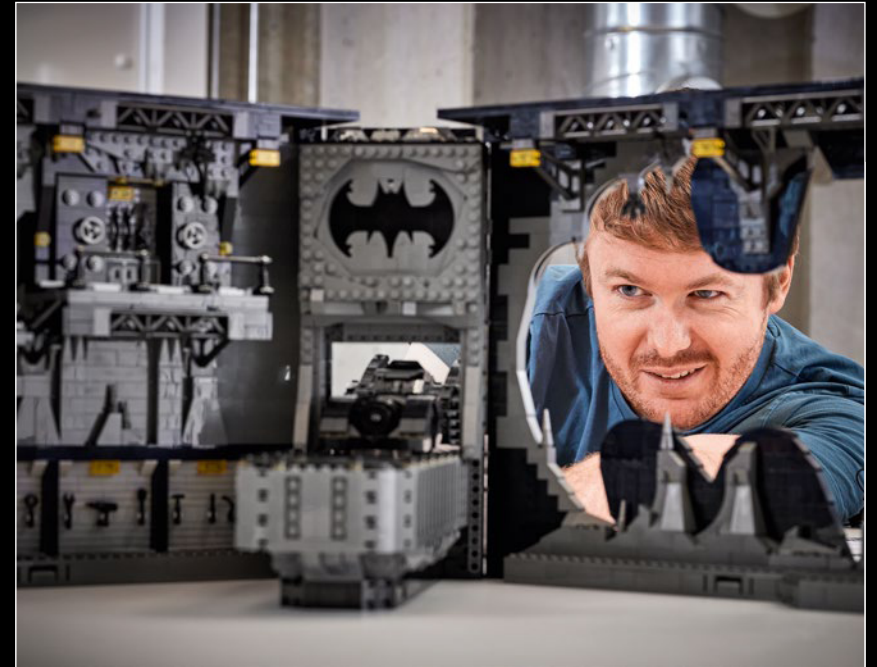
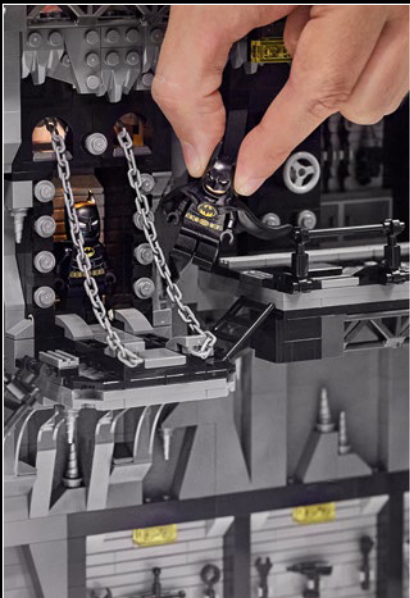
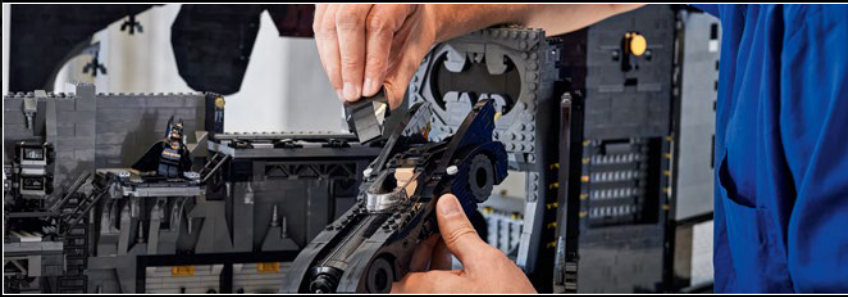



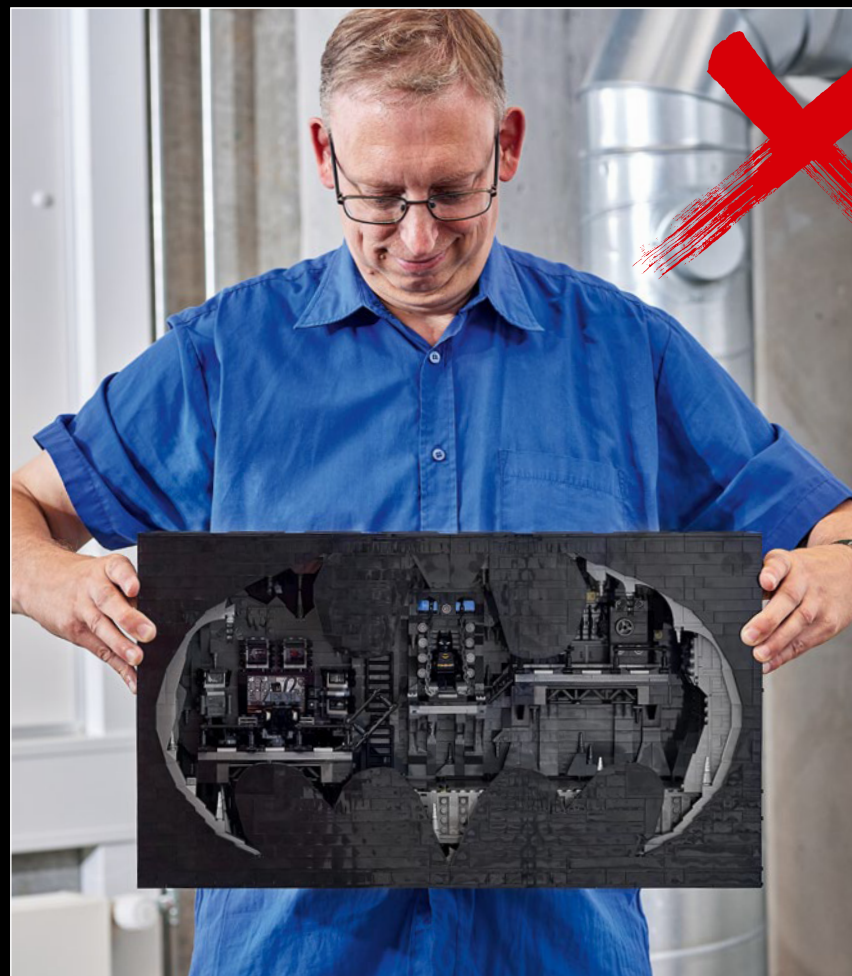
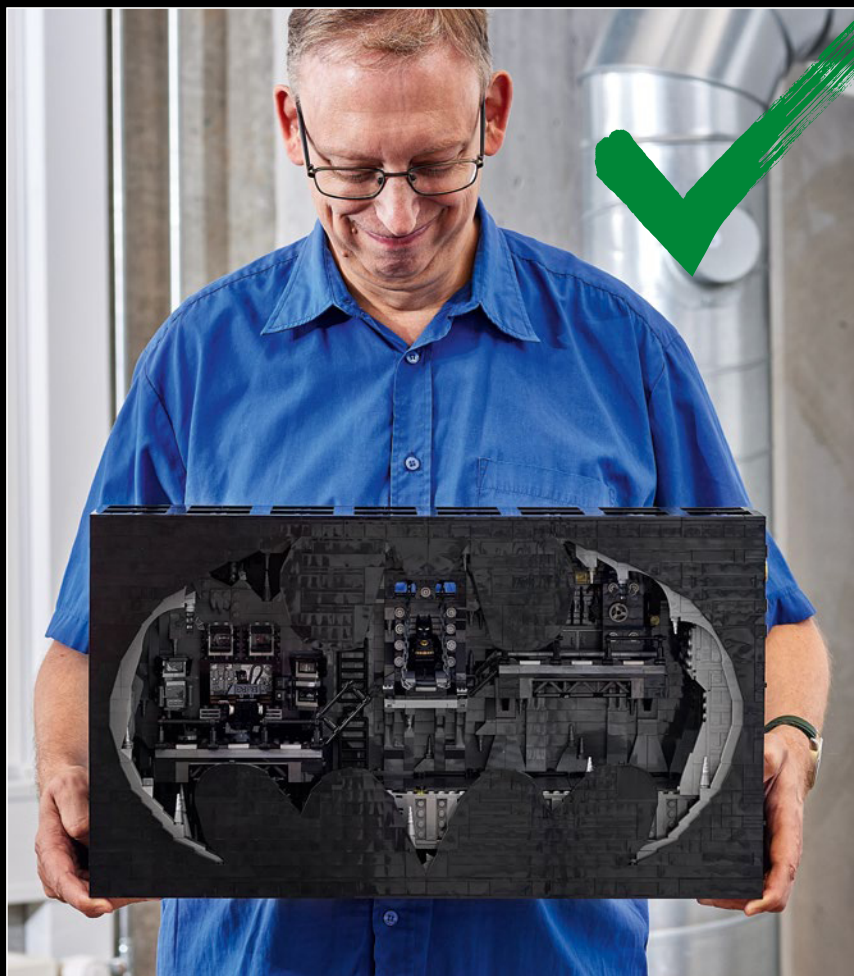

## 提示:如何抬起模型

注意:您的乐高®蝙蝠洞影盒经过专门设计,仅在闭合后方可抬起和移动。确保将模型关好,并在抬起和移动模型过程中用底部边缘承重。







## 穿上你的斗篷和头盔， 开始拼搭

“这是你之前从未见过的蝙蝠洞，它采用了我们以前从未用过的乐高®影盒形式。希望您能像我们一样在探索所有细节和拼搭技术的过程中获得无穷乐趣。谨代表我们整个团队，祝您拼搭愉快，玩得开心！”

Bjarke Lykke Madsen

“我是蝙蝠侠。”

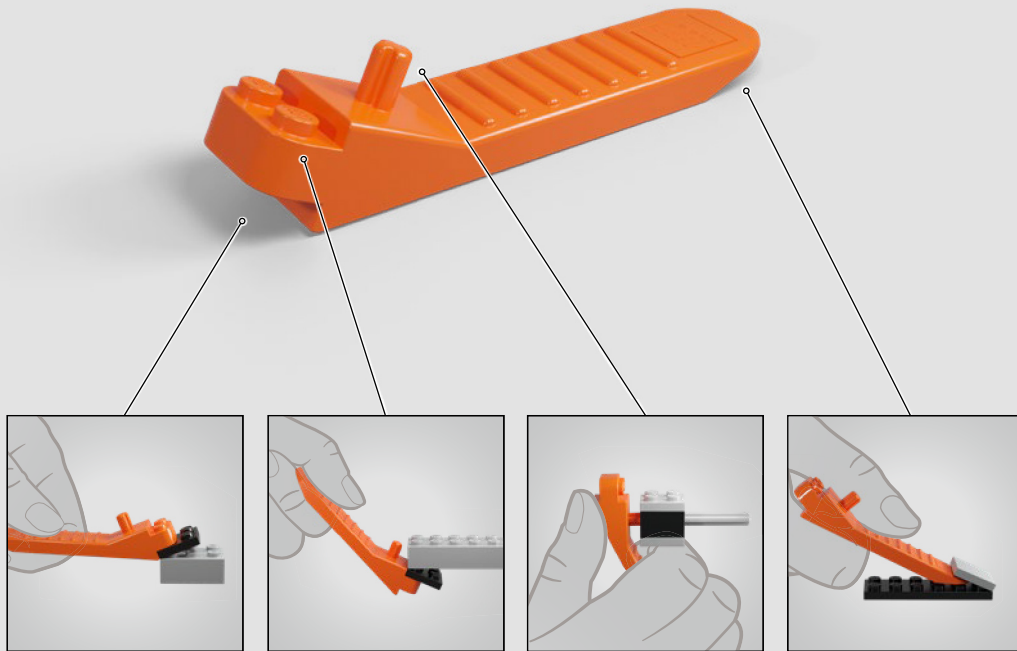



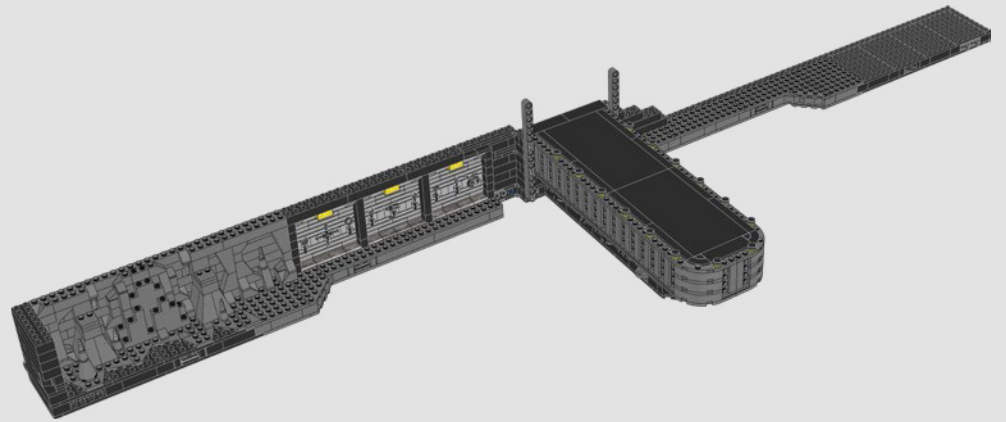
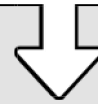
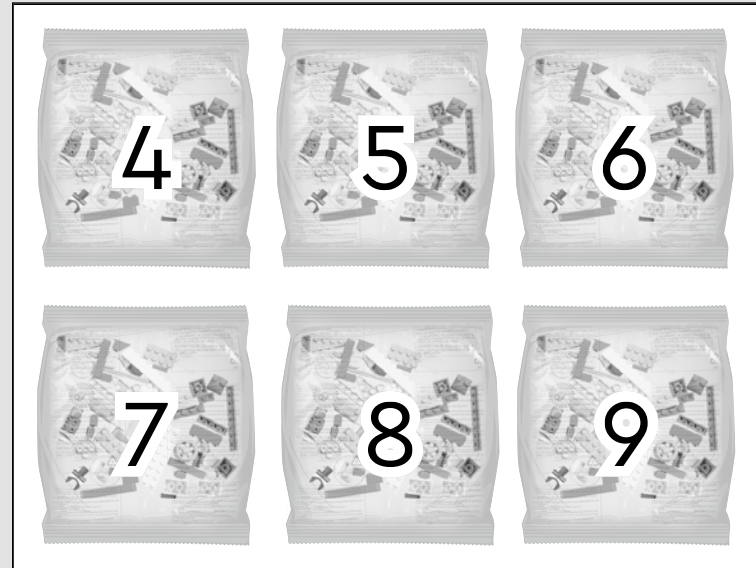
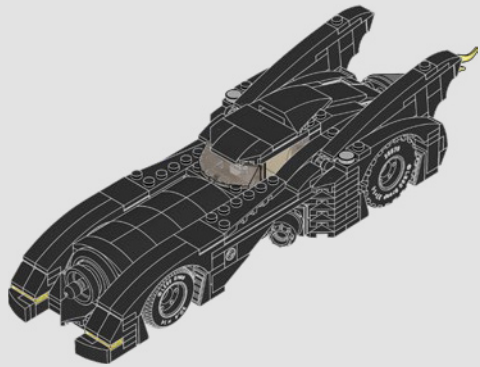
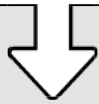
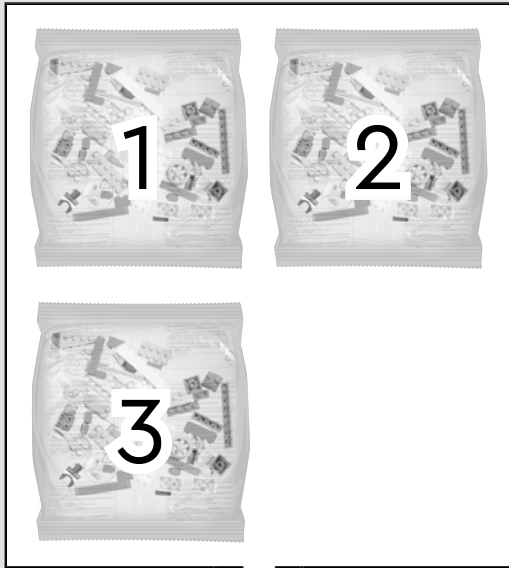

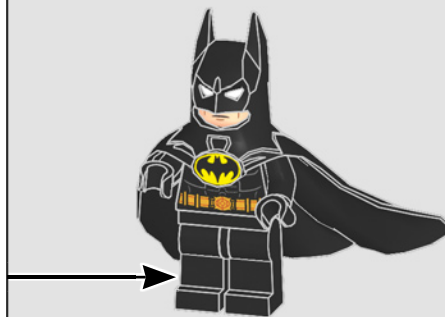
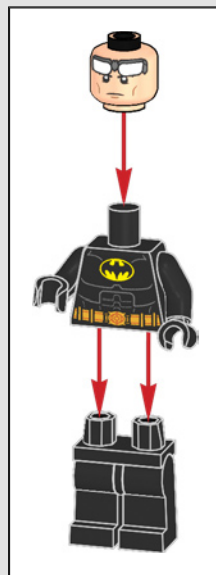



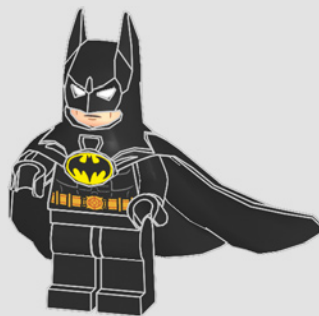

## 蝙蝠侠

蝙蝠侠是哥谭市的老牌英雄，激励了几代粉丝、作家和制片人。他是一位饱受折磨的义警，内心脆弱，深居简出，不寻求名声或荣耀。在悲剧的影响下，他感到自己负有揭露这座城市黑暗秘密的责任，却只能退到自己的阴影中。

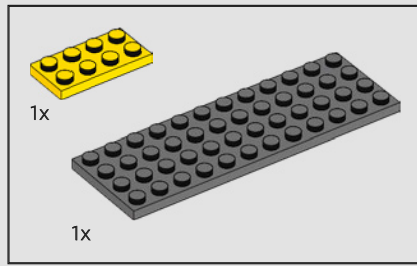
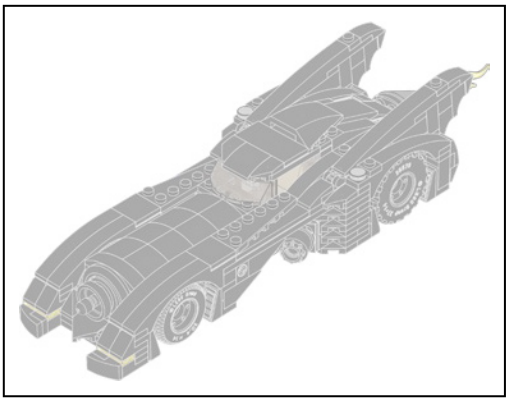

1

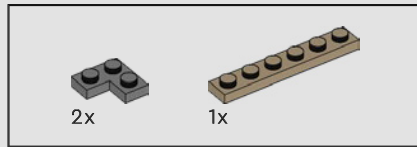
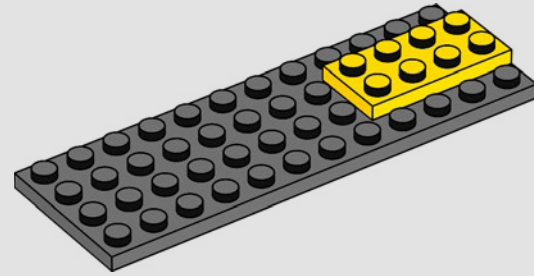

2

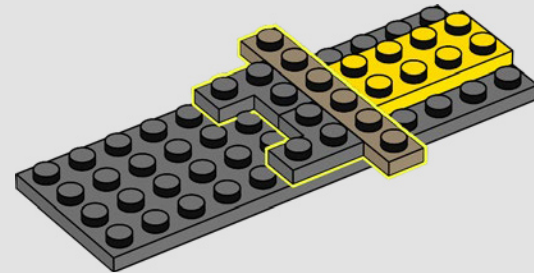

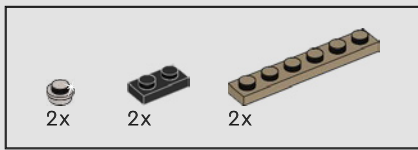

3

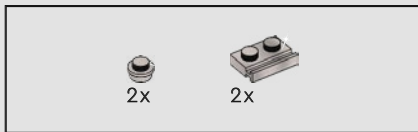
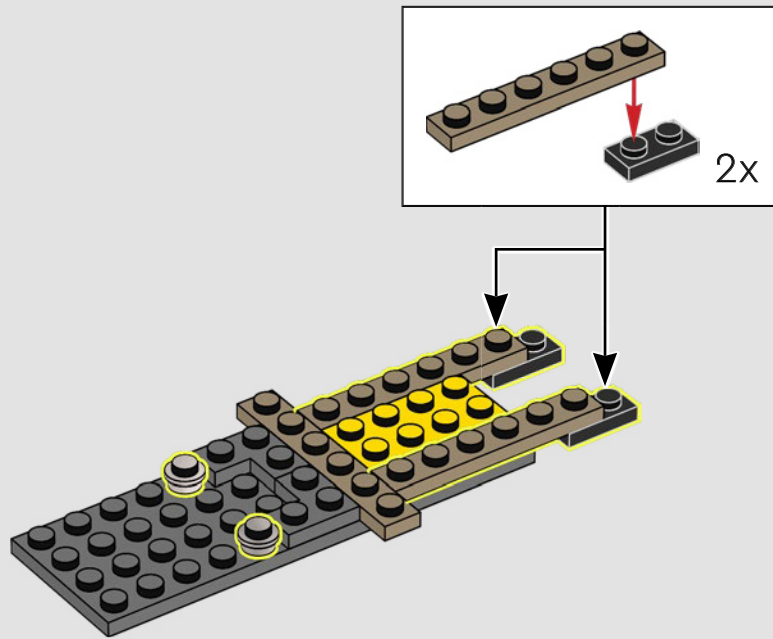

4

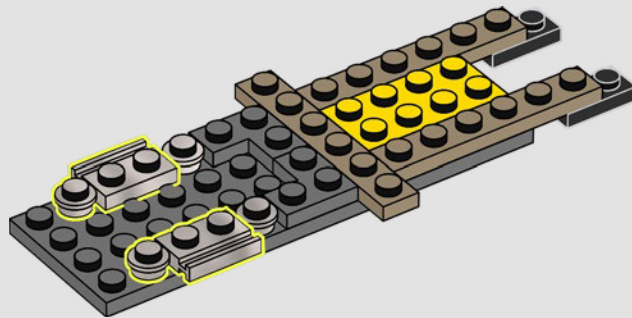



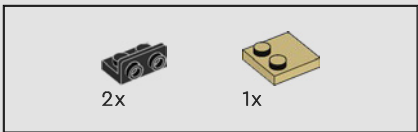

5

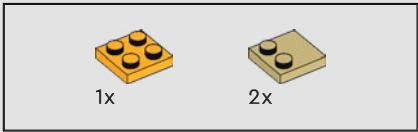
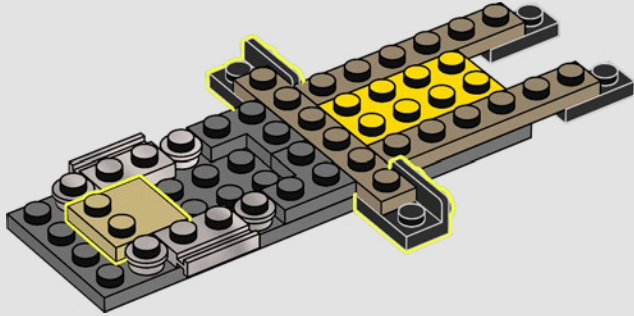

6

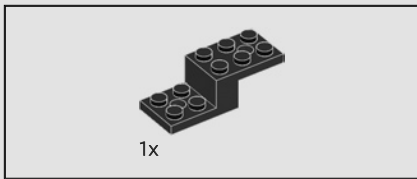
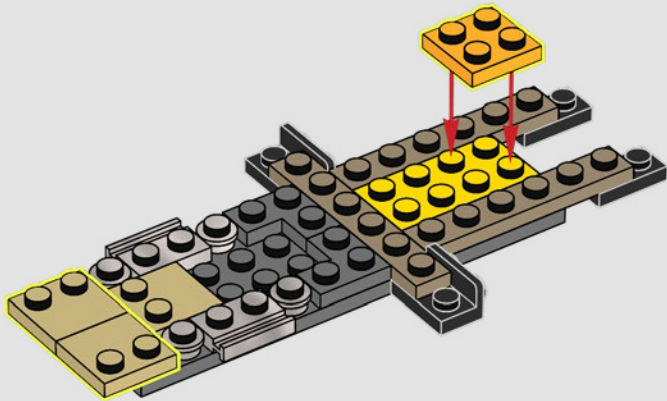

7

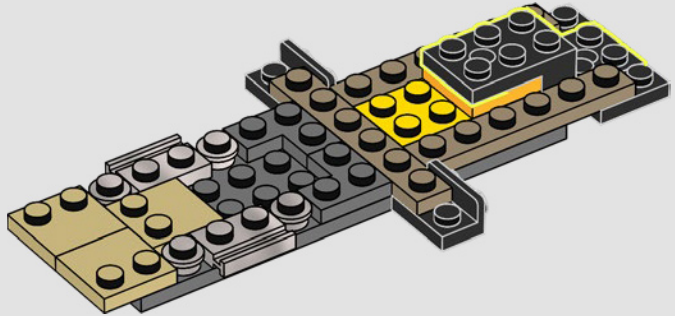

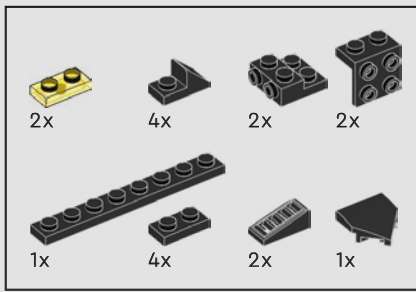

8

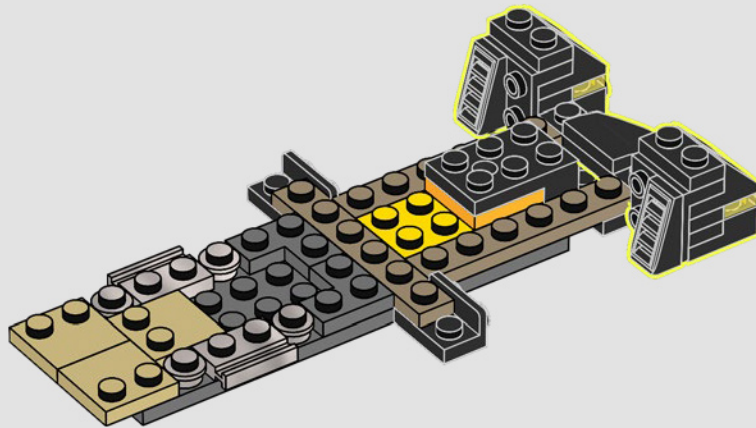
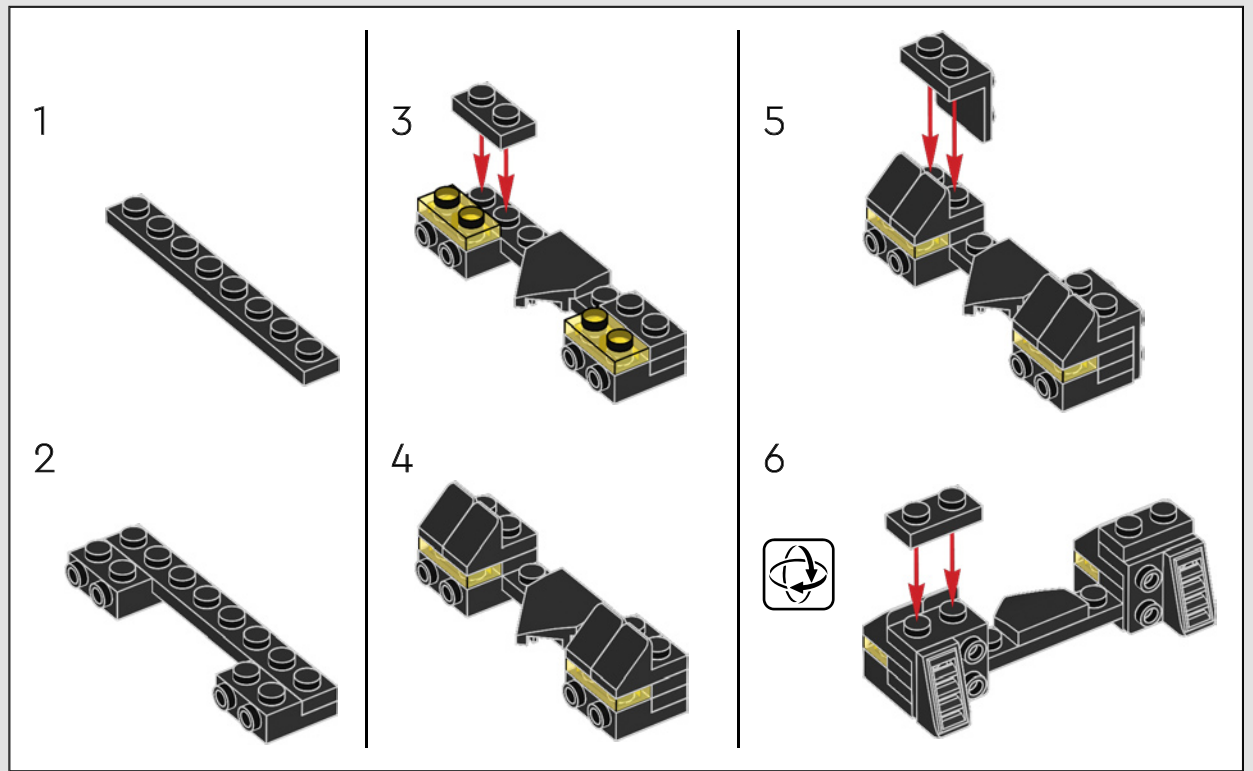



2x

9



2x

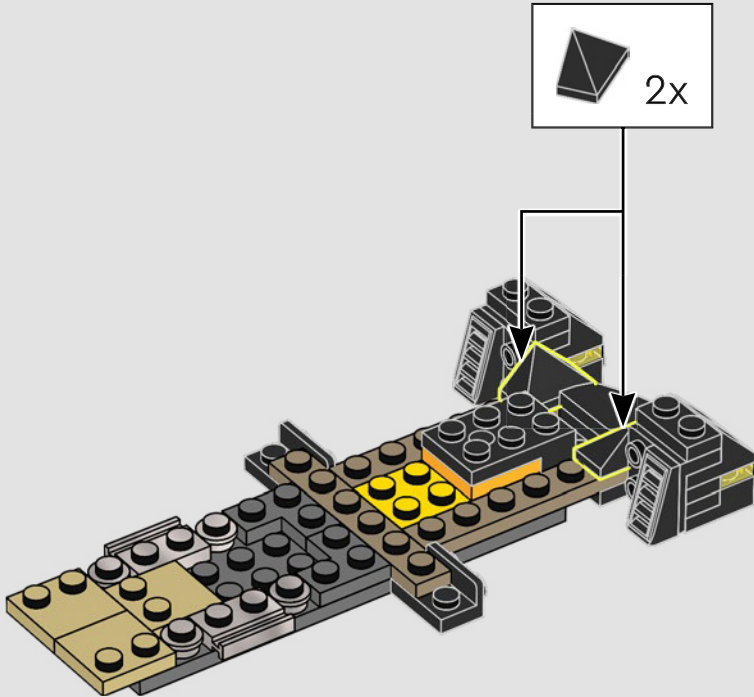

2x

10

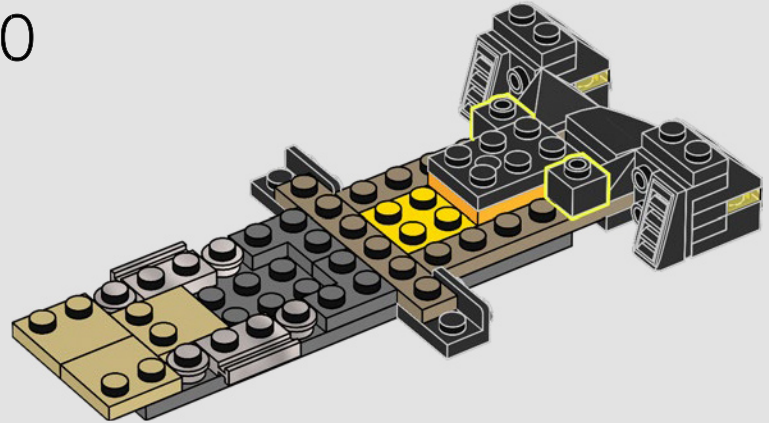

2x



2x



1x

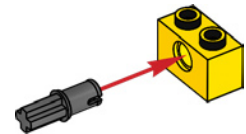

2x

11

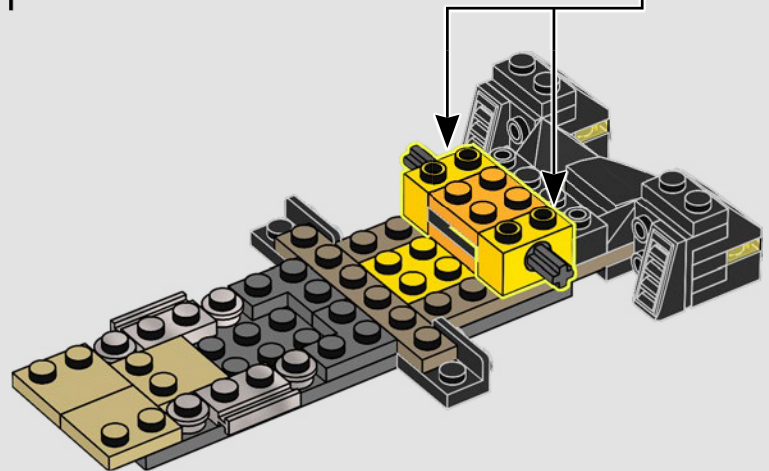



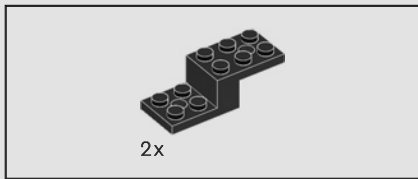

12

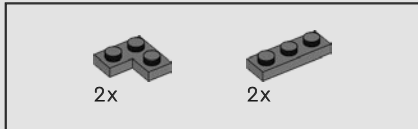
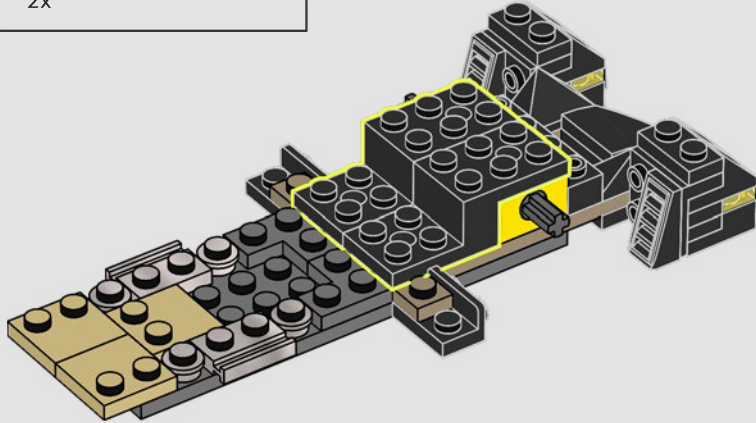

13

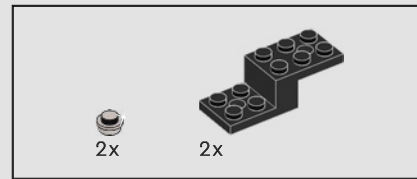
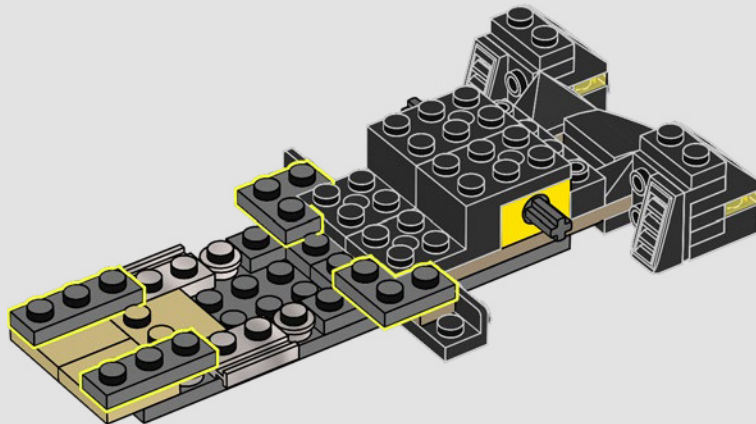

14

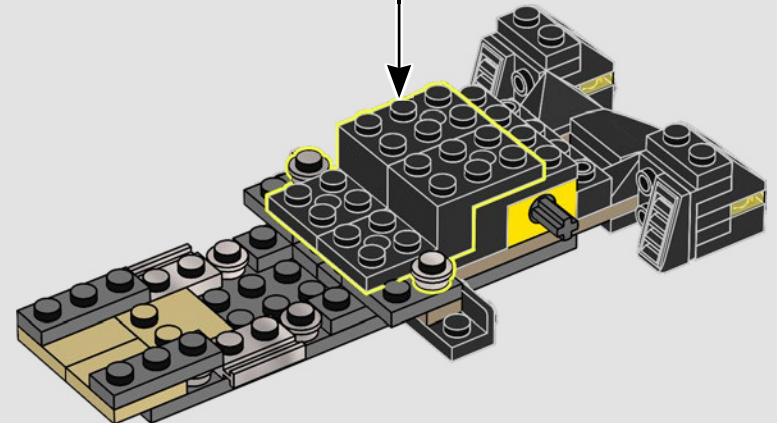
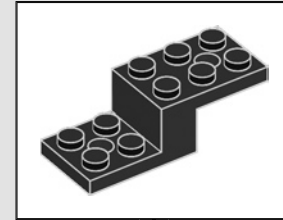

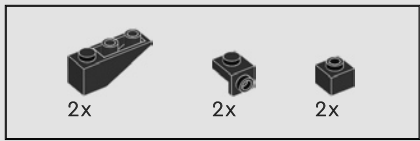

15

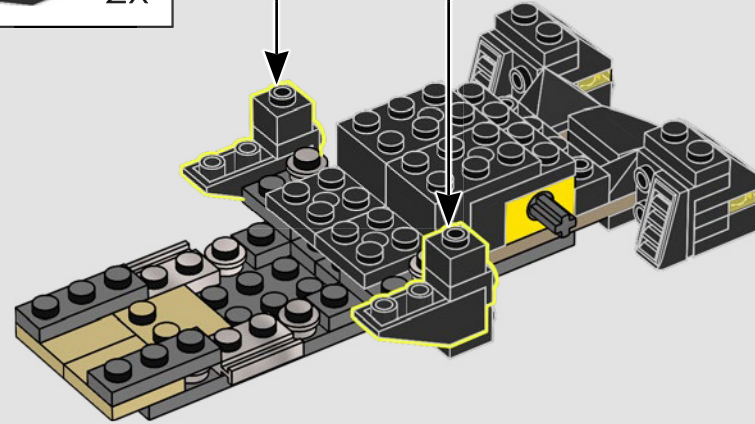
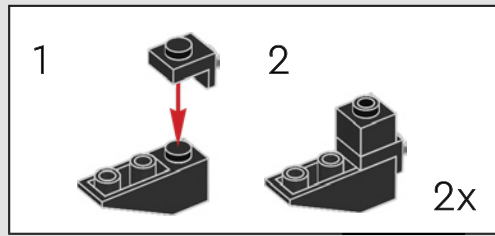

16

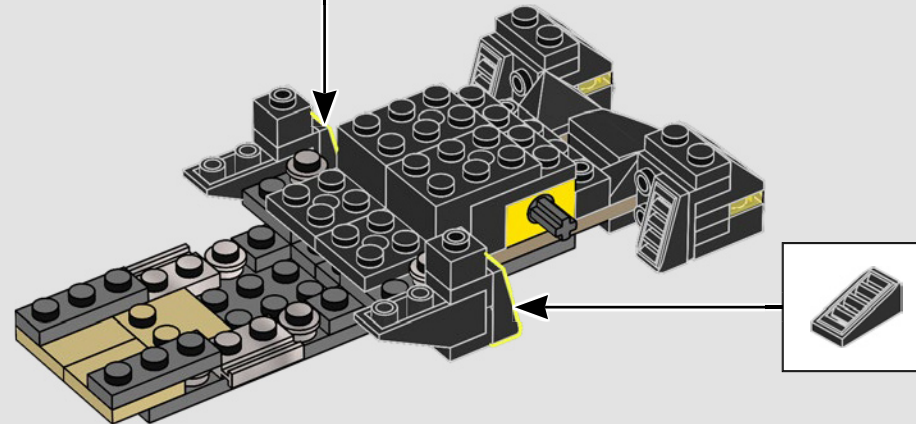

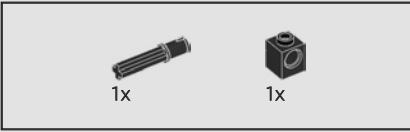
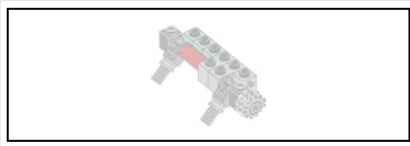

17

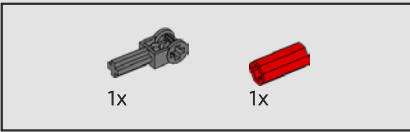
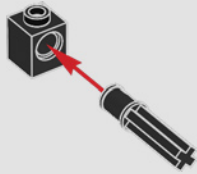

18

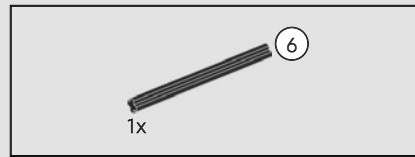
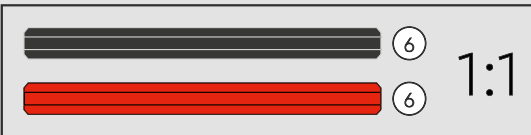
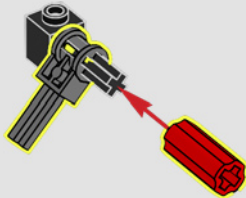

19

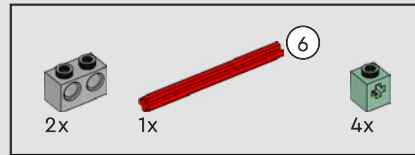
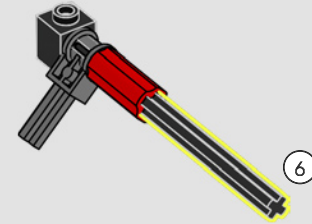

20

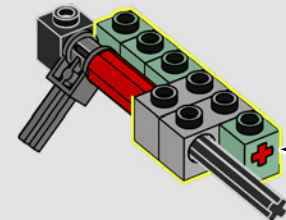
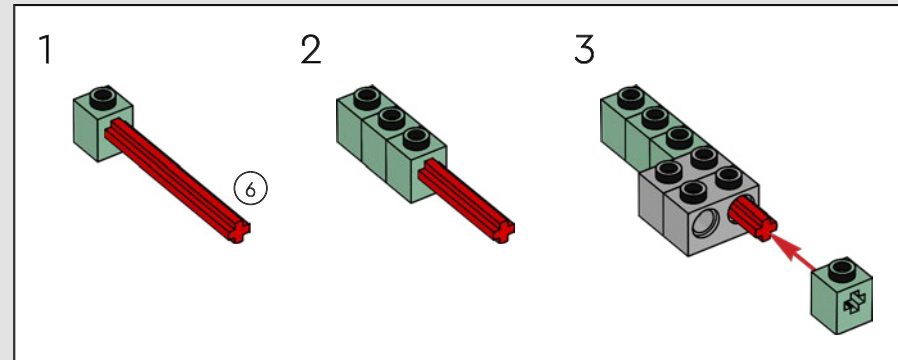





1x

21

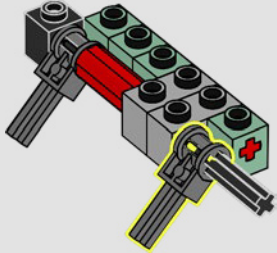

2x

22

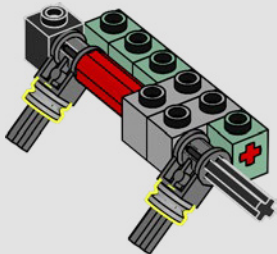

1x



1x

23

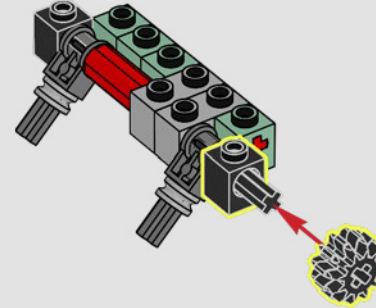

24

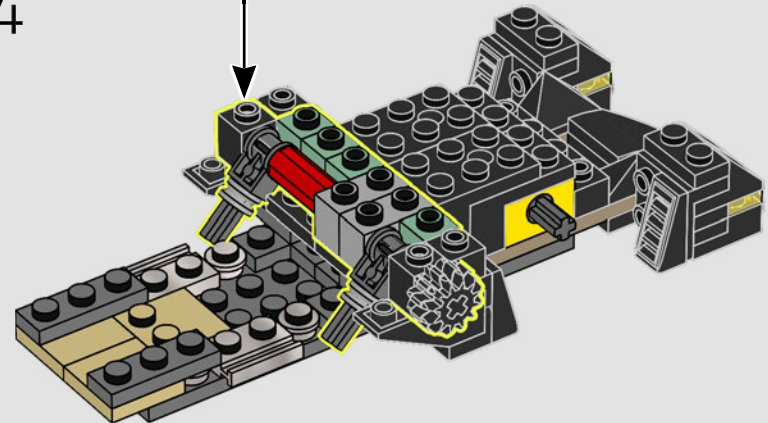

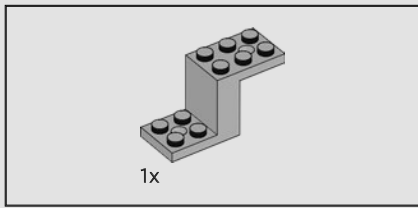

25

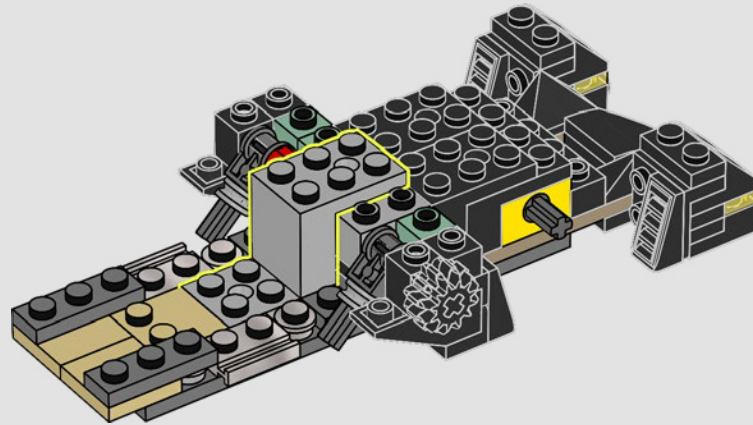

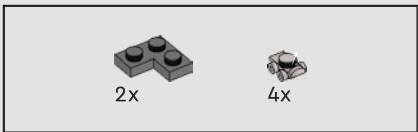

26

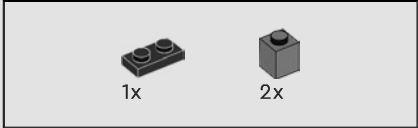
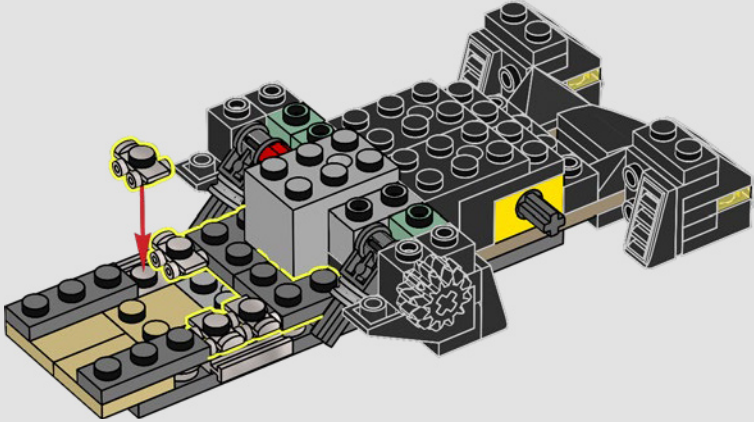

27

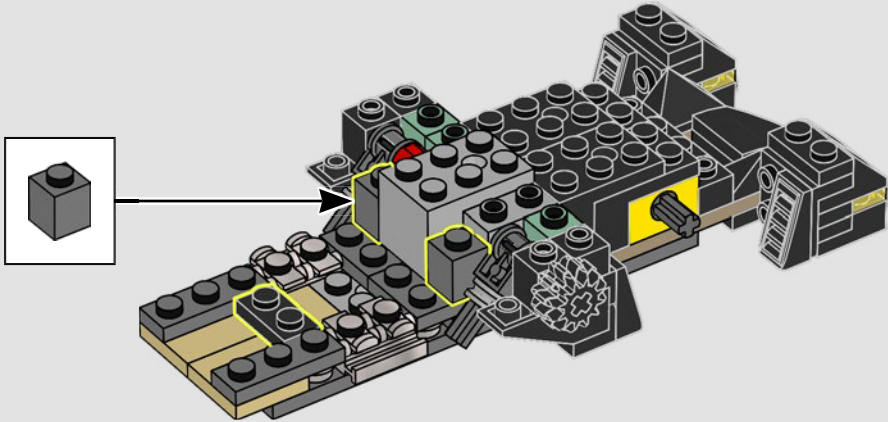



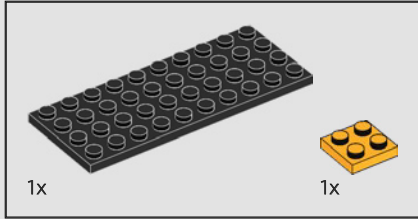
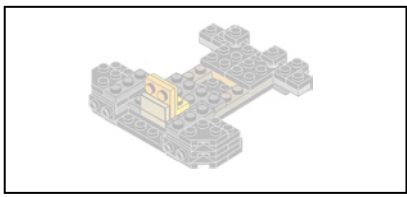

28

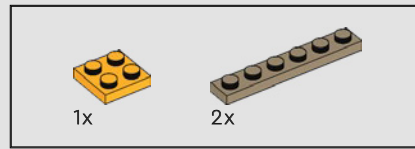
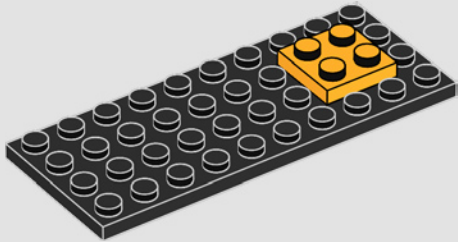

29

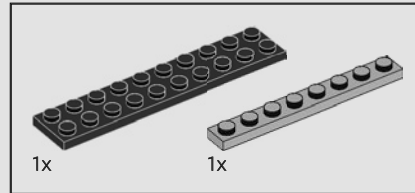
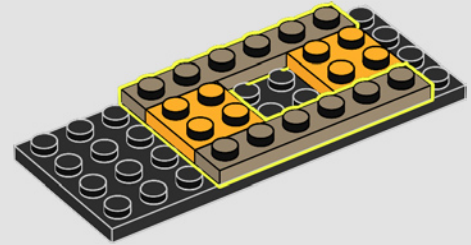

30

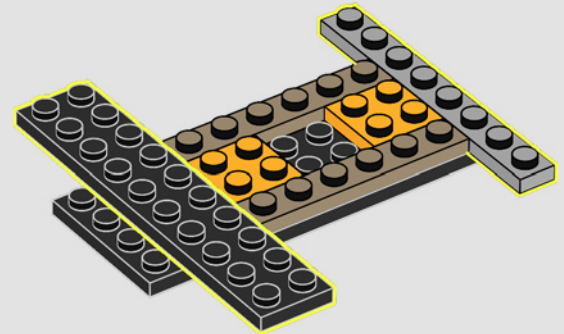

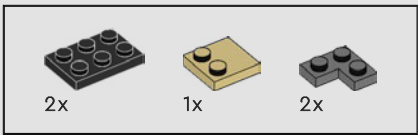

31

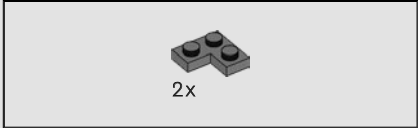
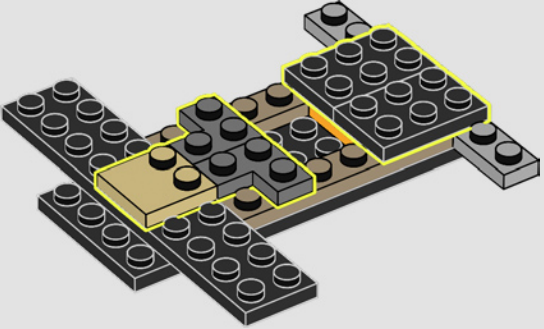

32

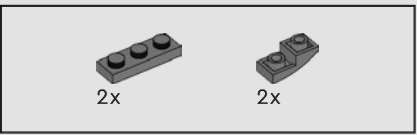
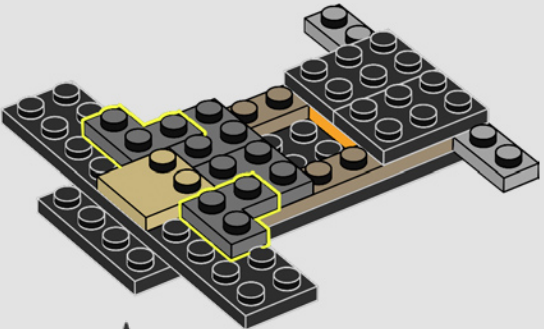

33

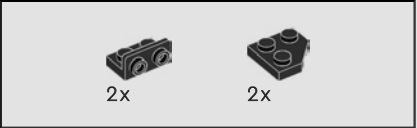
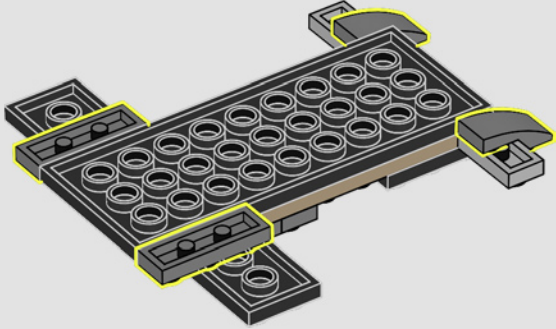

34

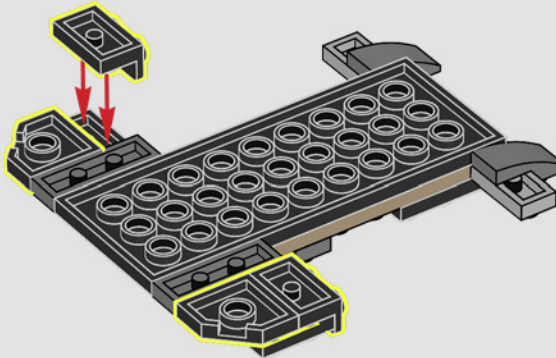

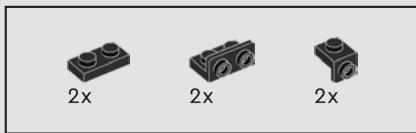

35

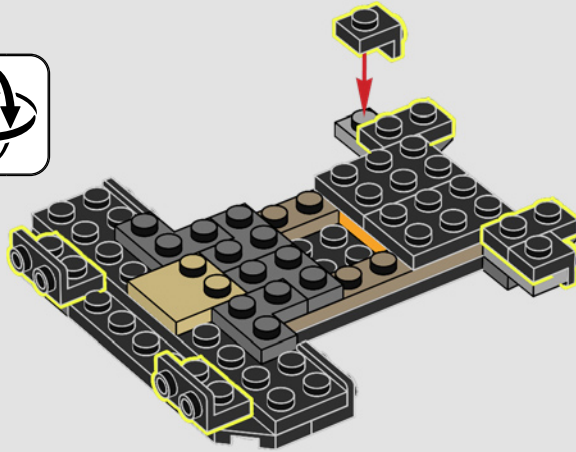

36

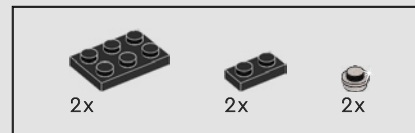
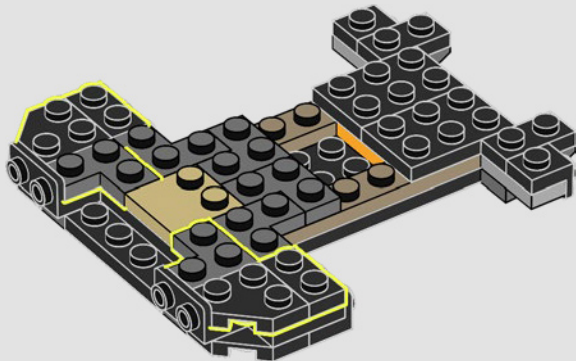

37

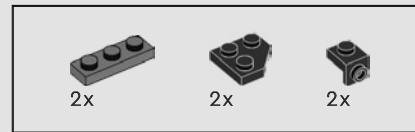
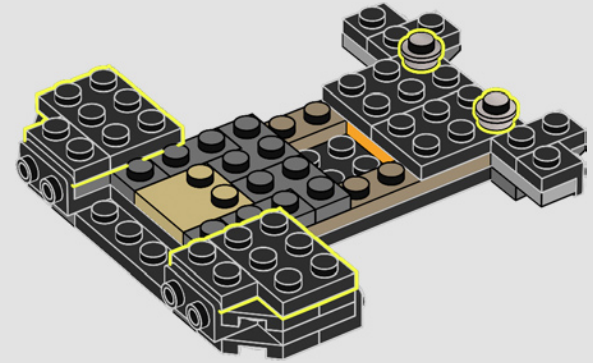

38

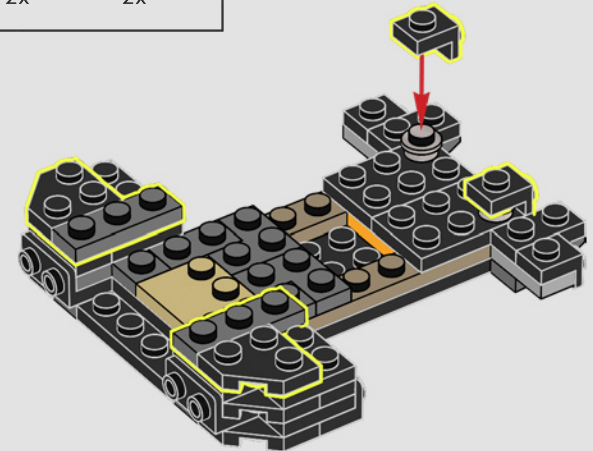



39

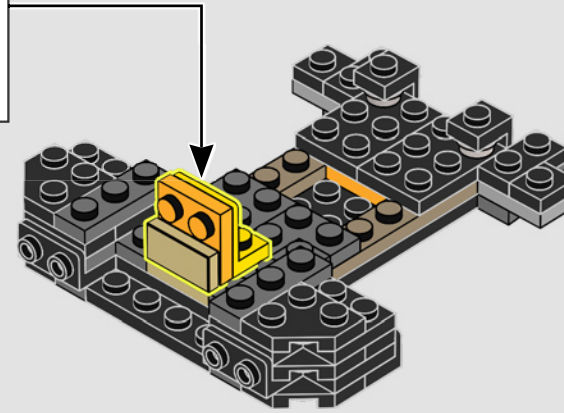
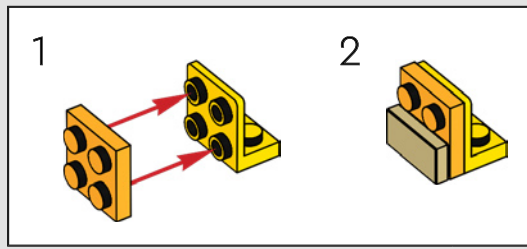

40

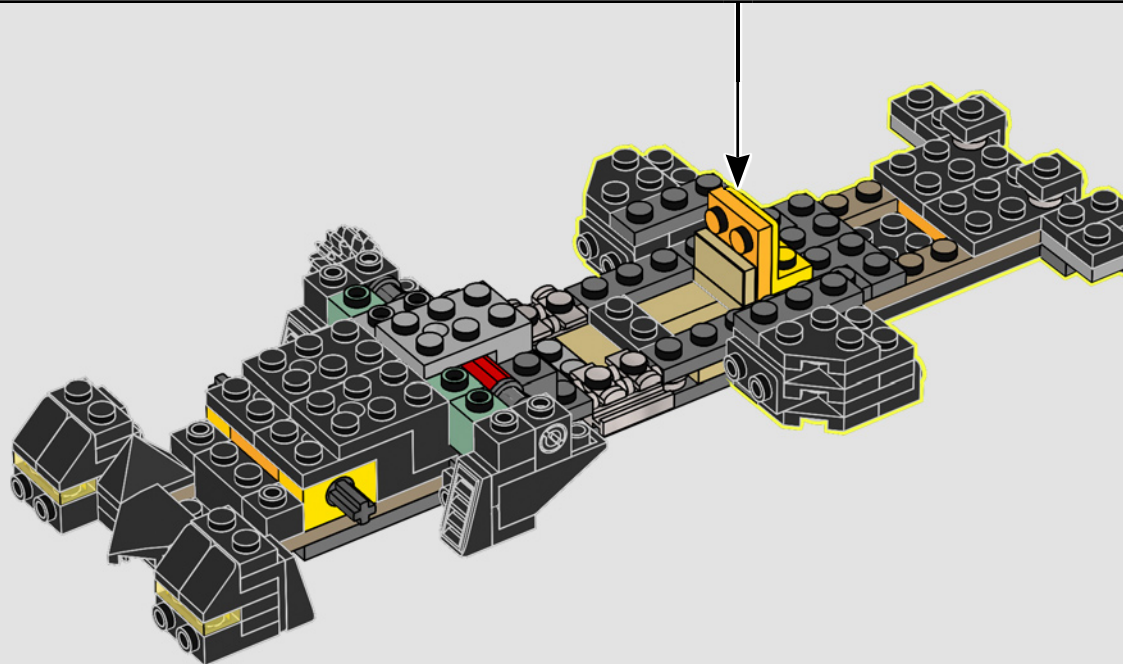



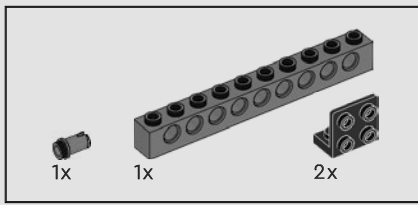

41

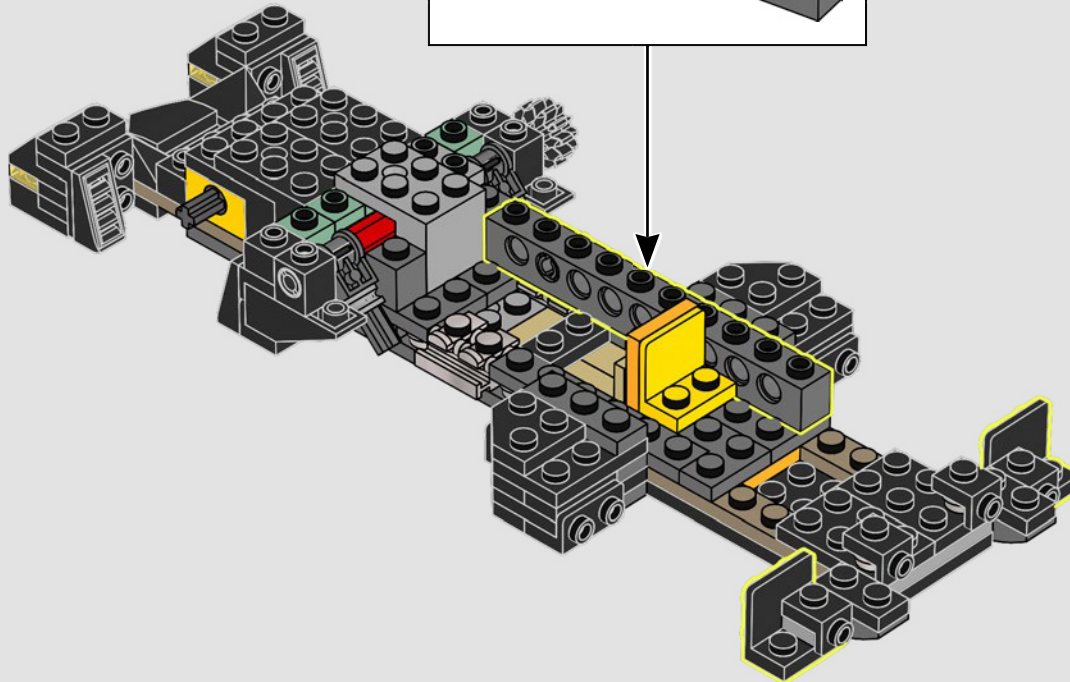
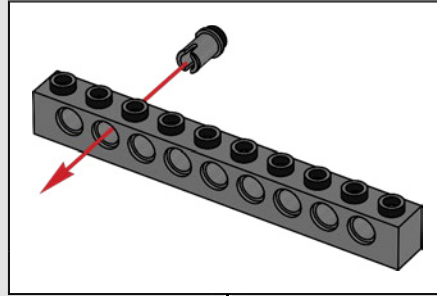



2x

42

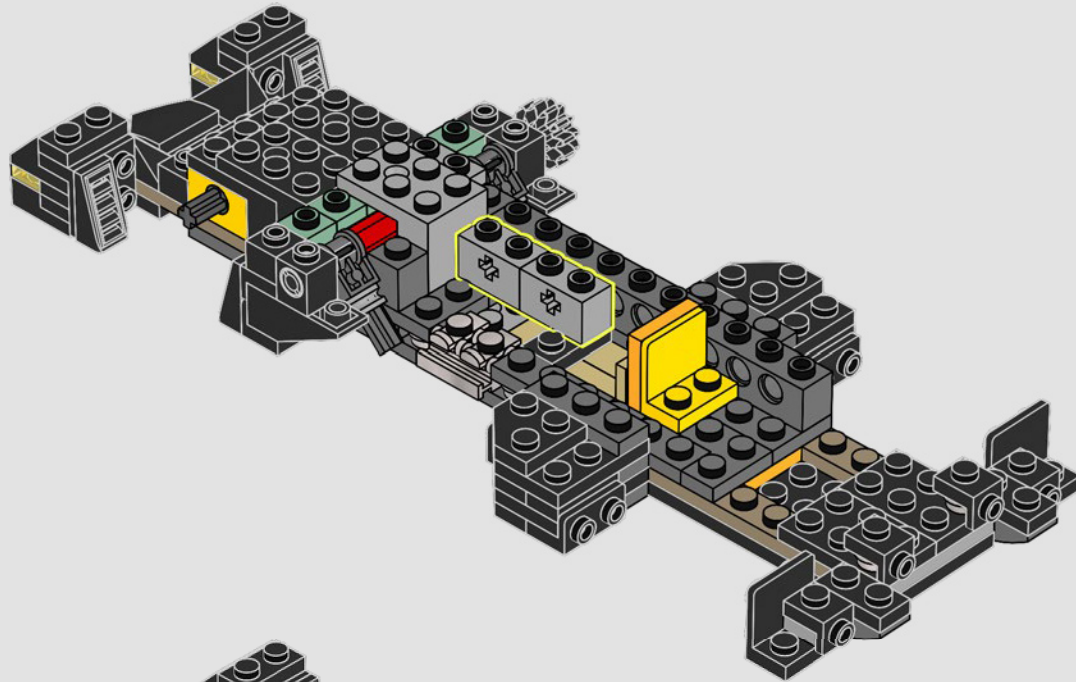

1x

43

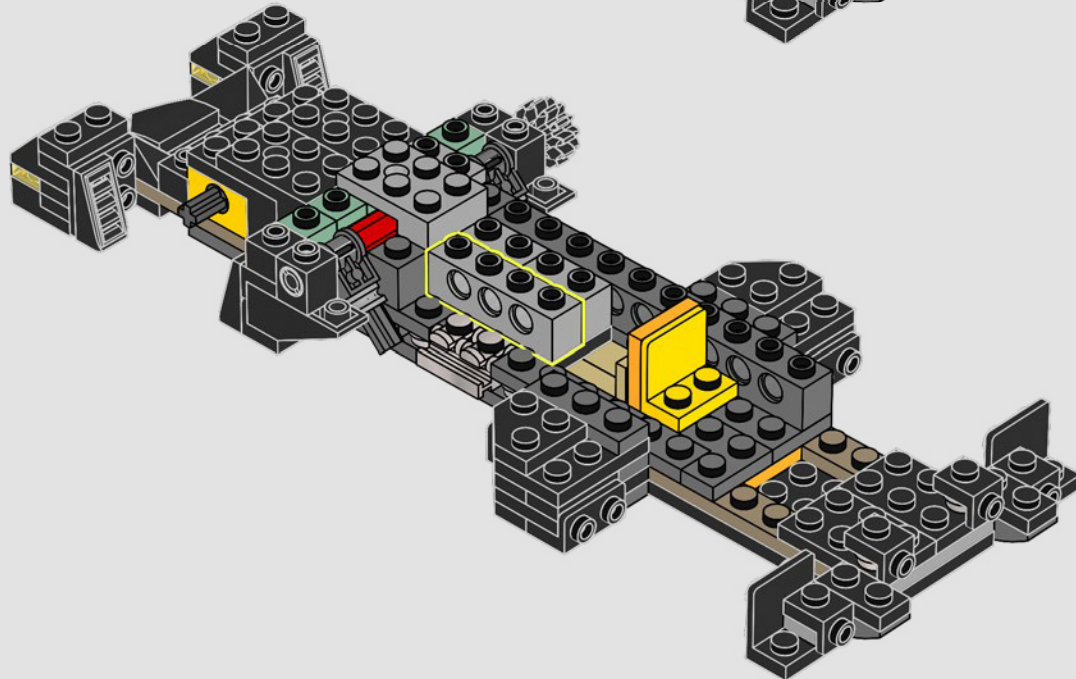

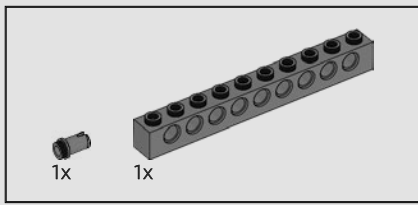

44

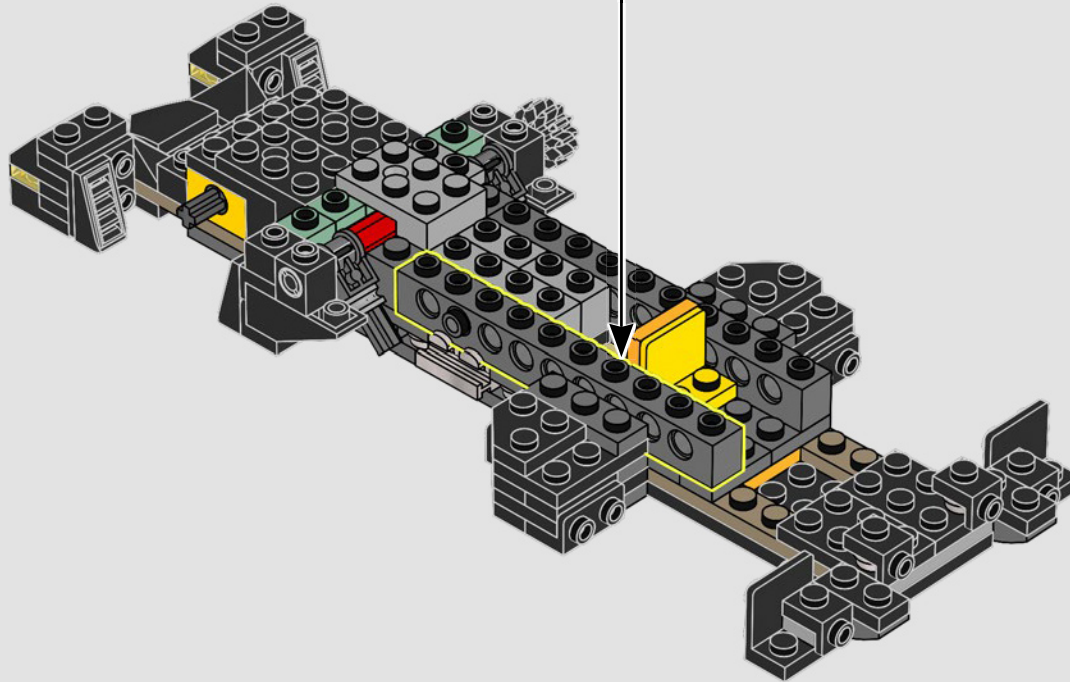
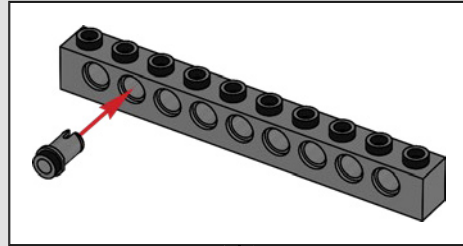

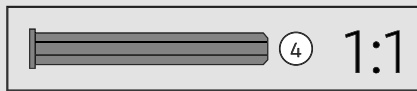
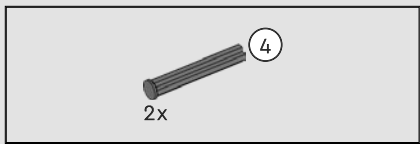

45

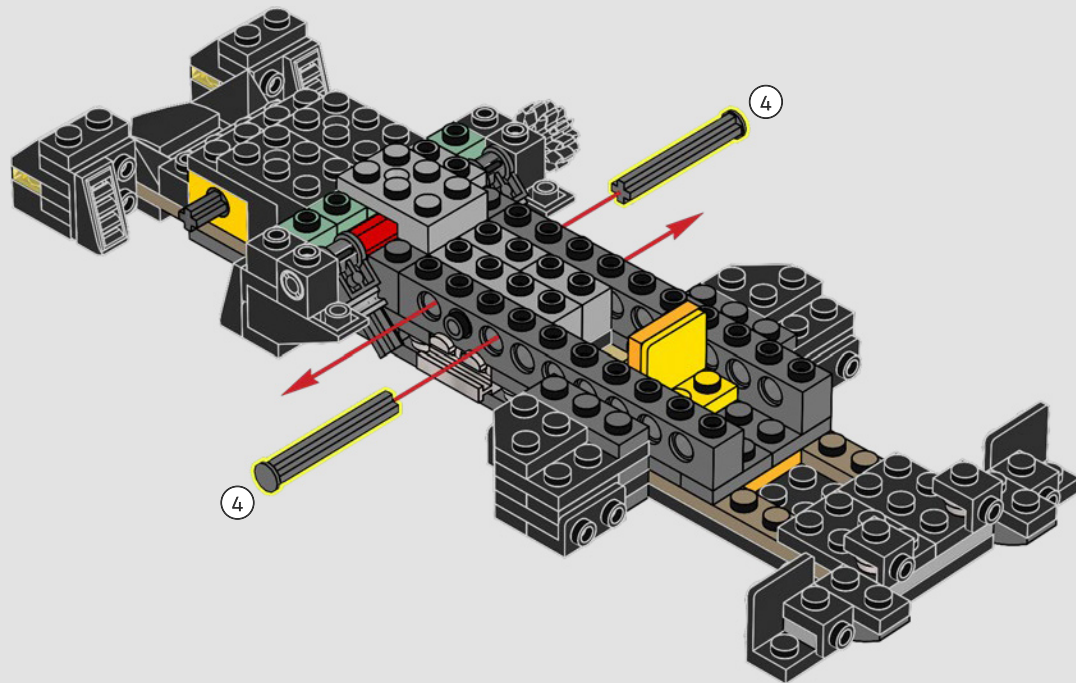



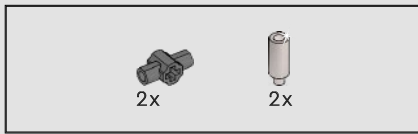

46

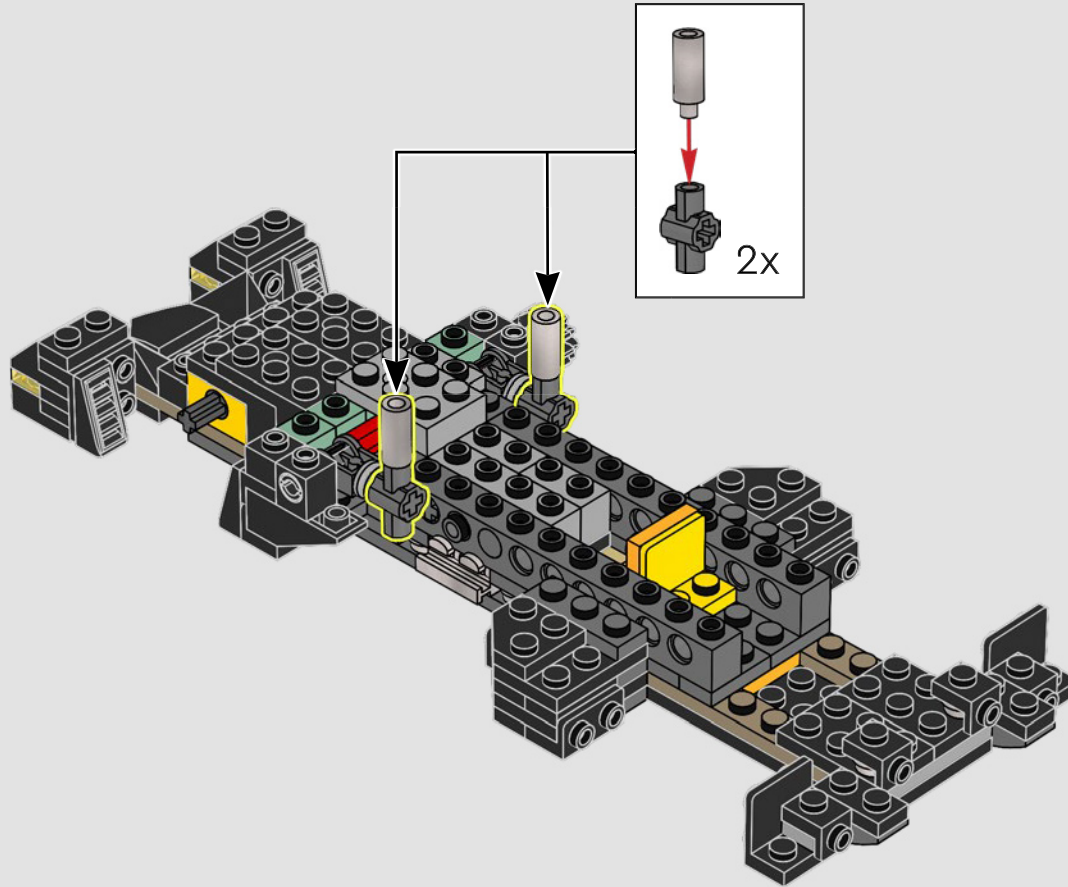



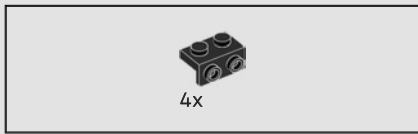

47

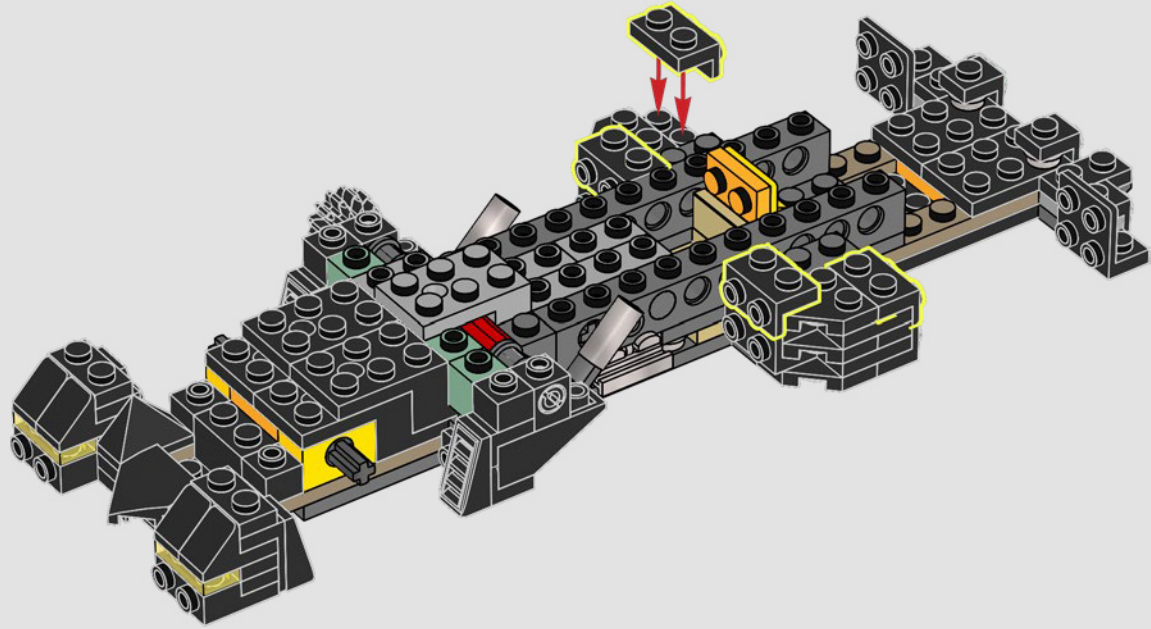

48

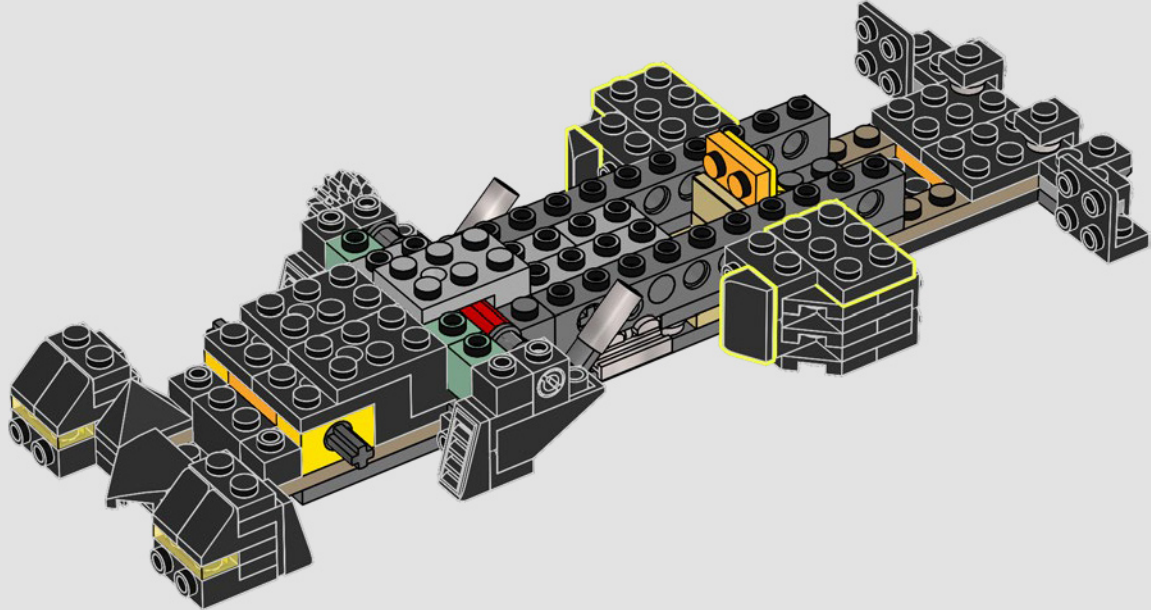

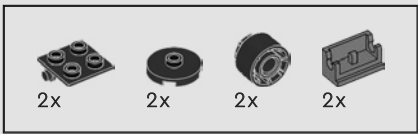

49

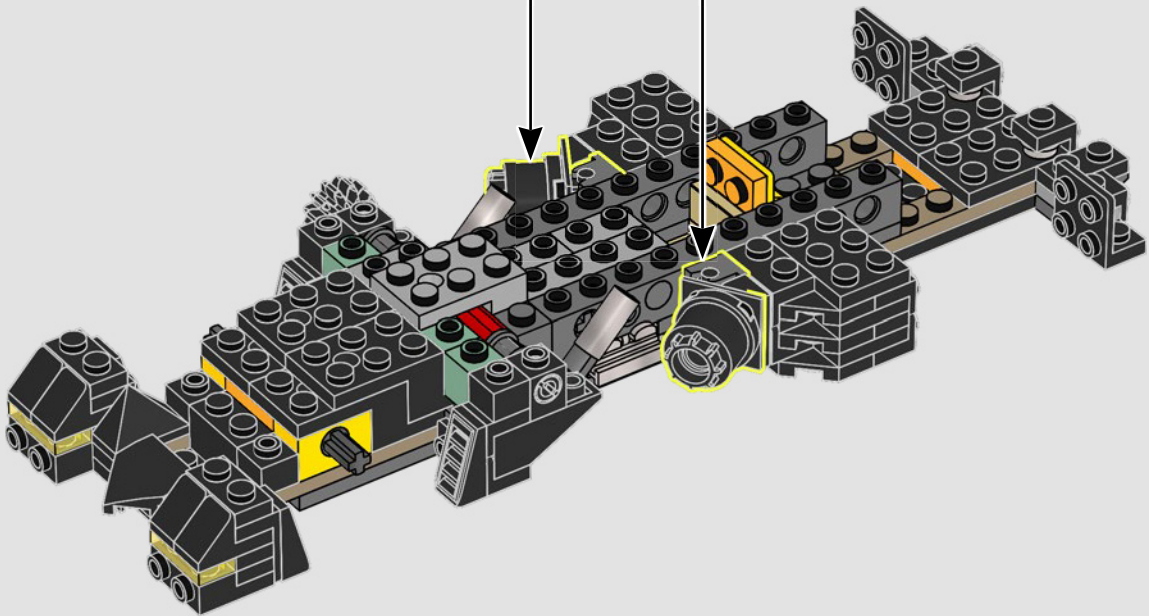
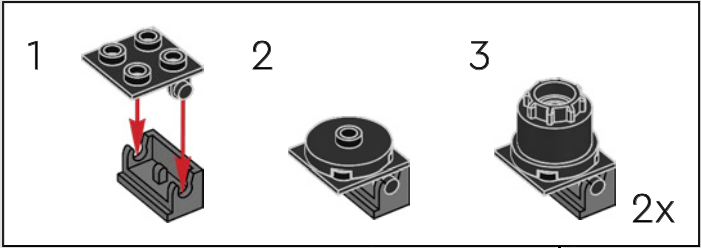



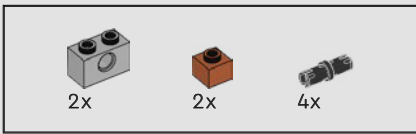

50

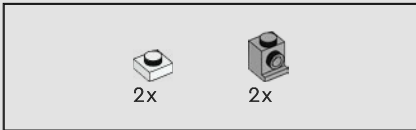
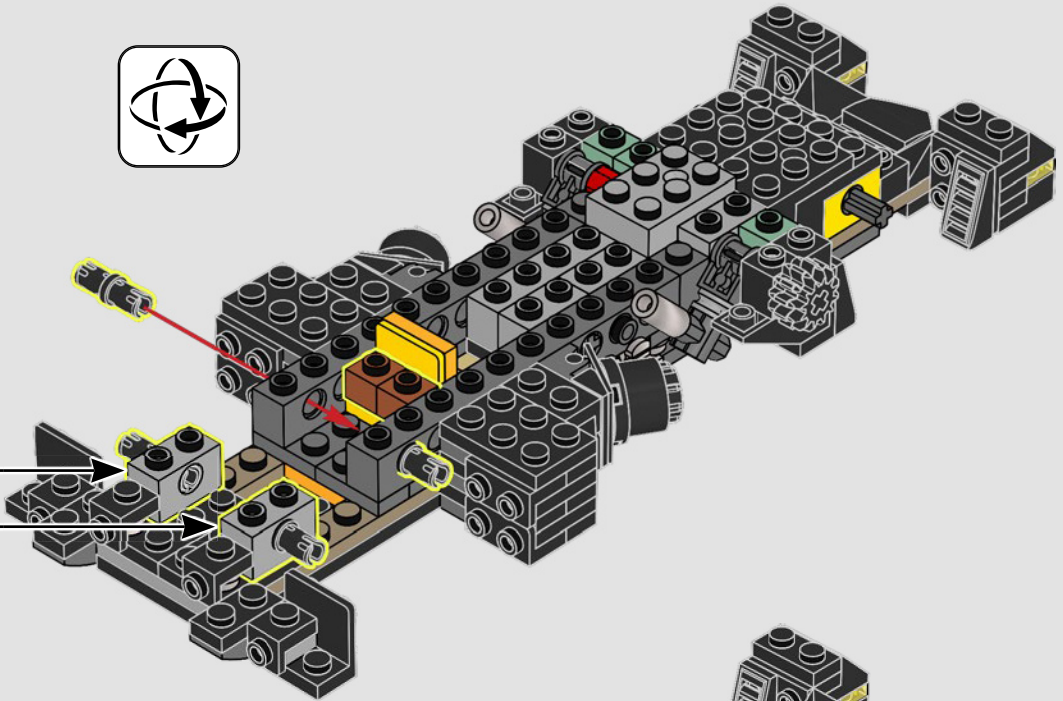
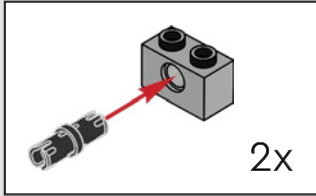

51

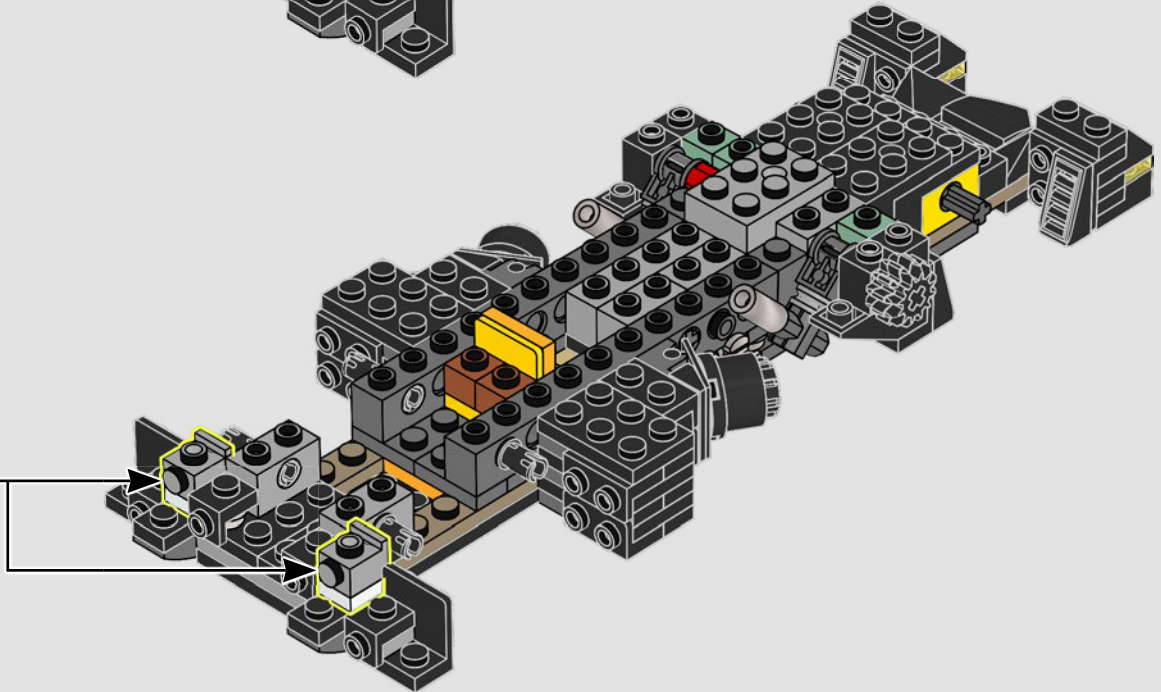
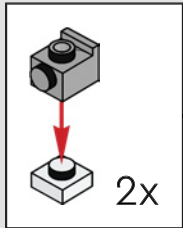

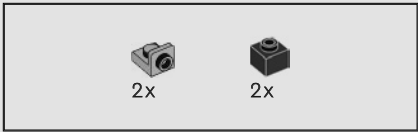

52

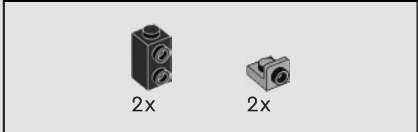
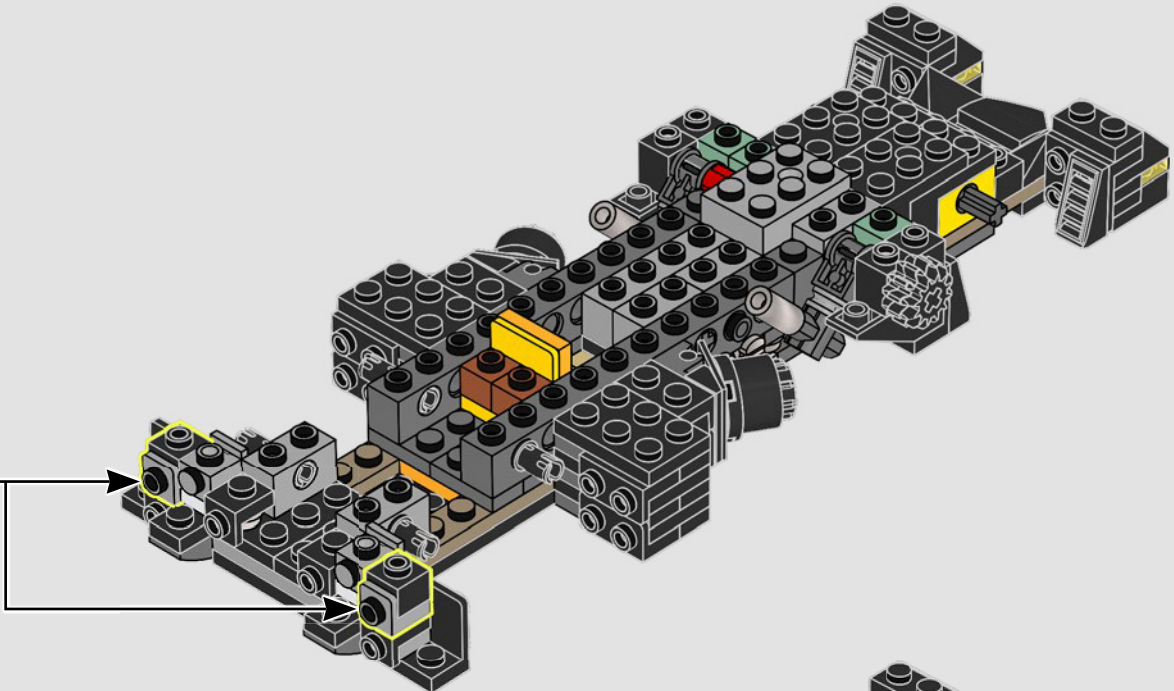
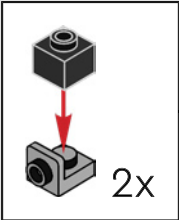

53

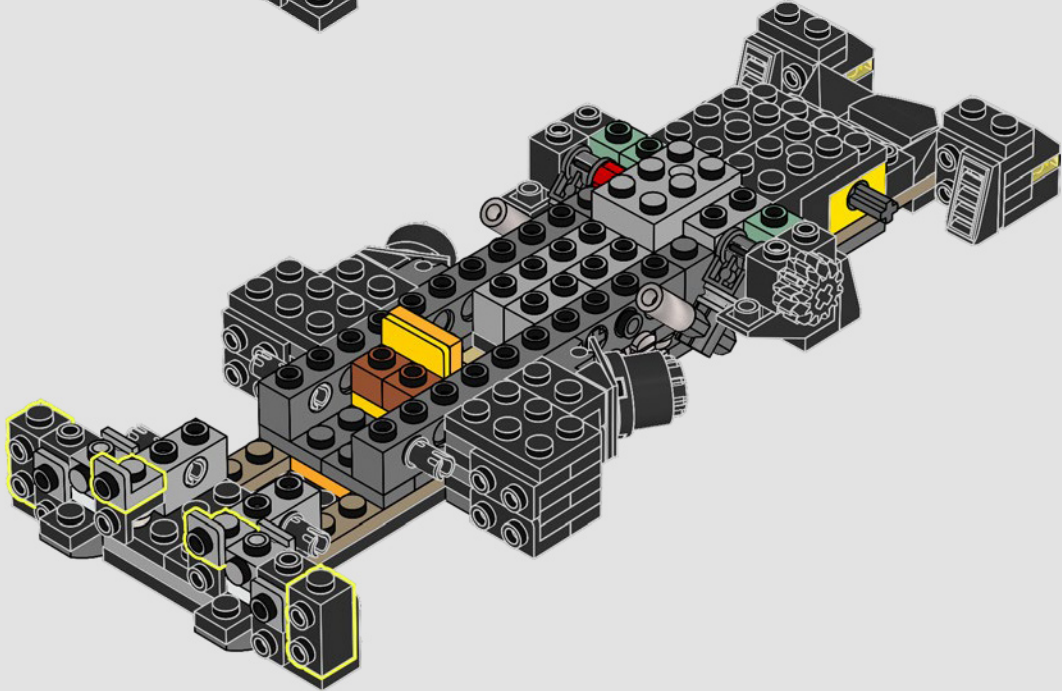

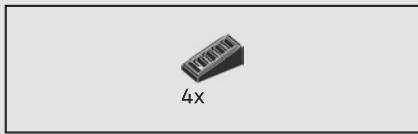

54

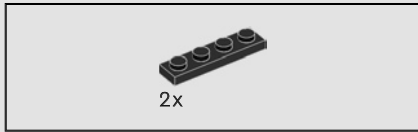
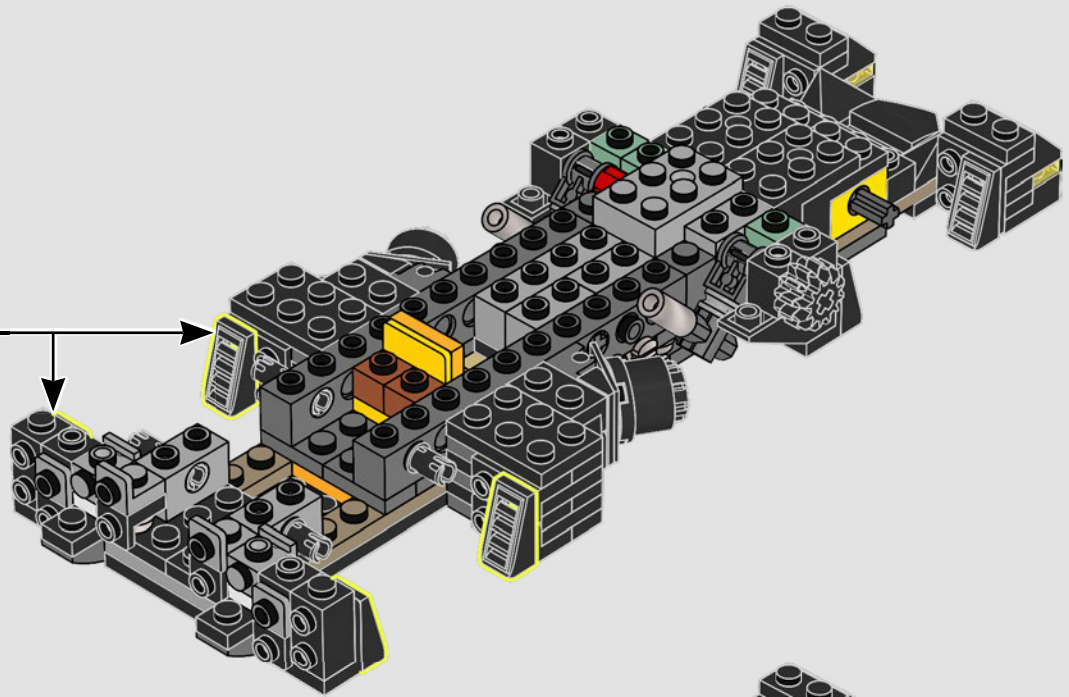
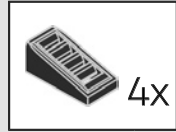

55

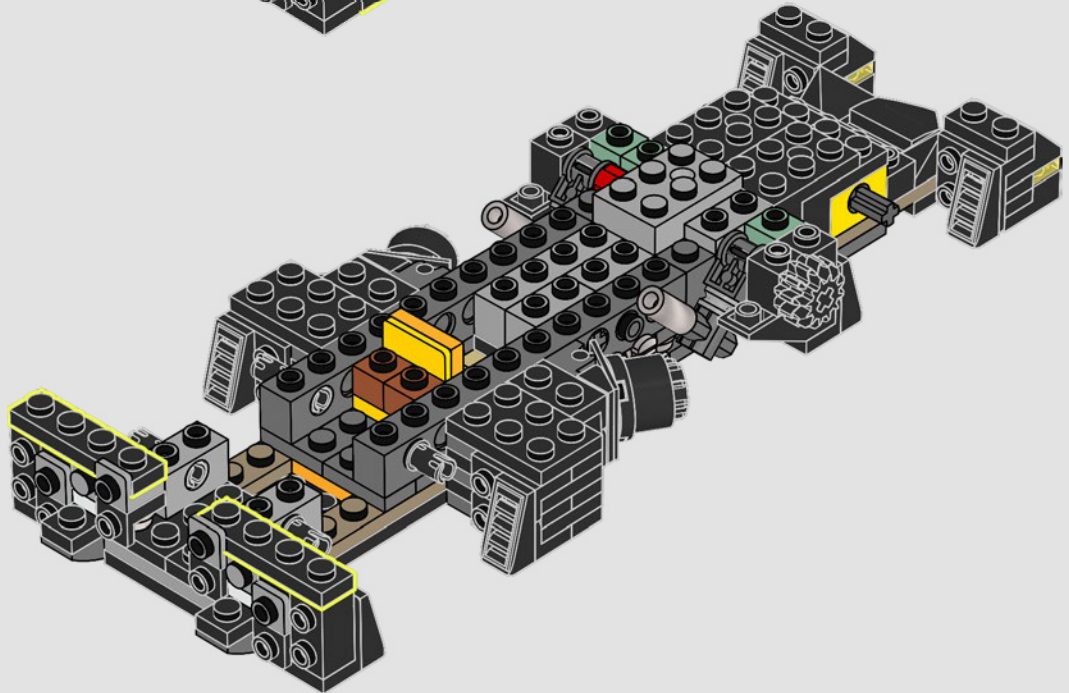



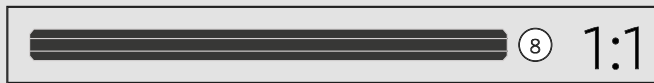
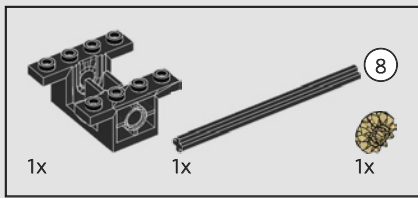

56

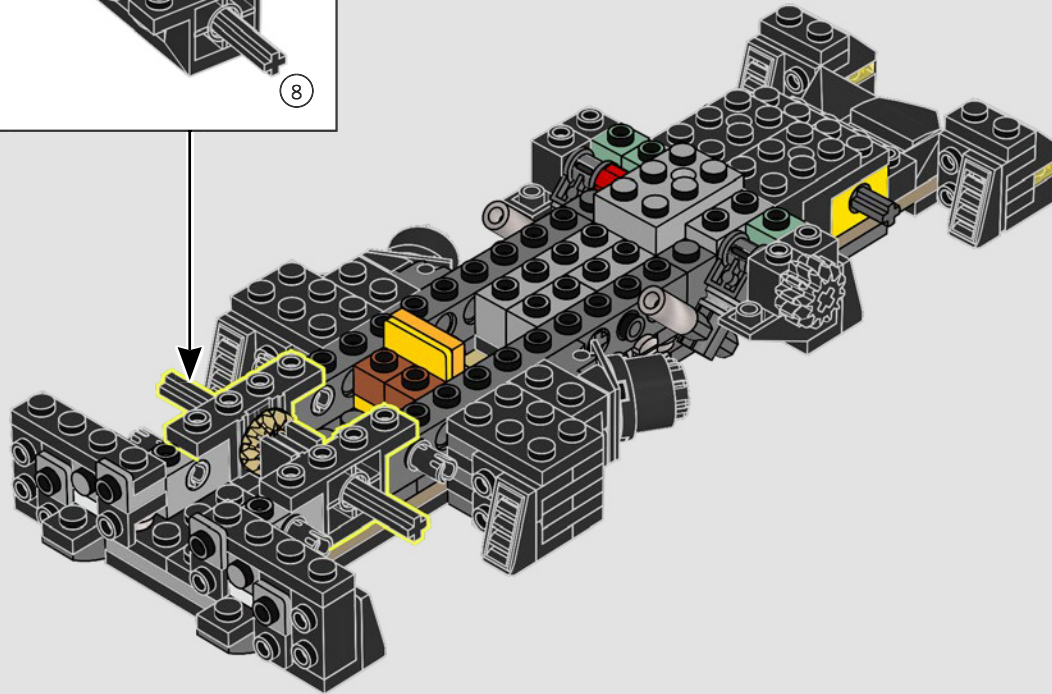
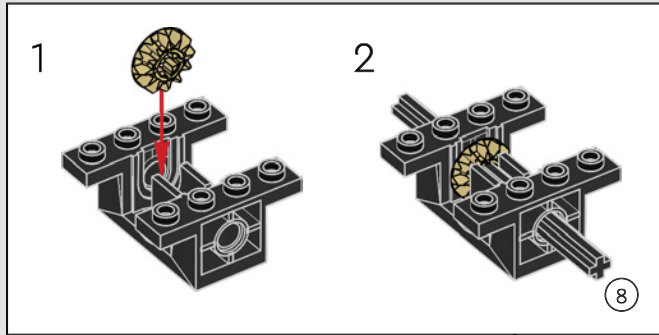



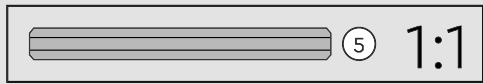
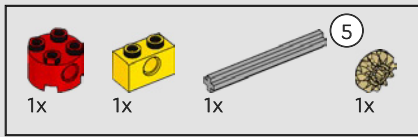

57

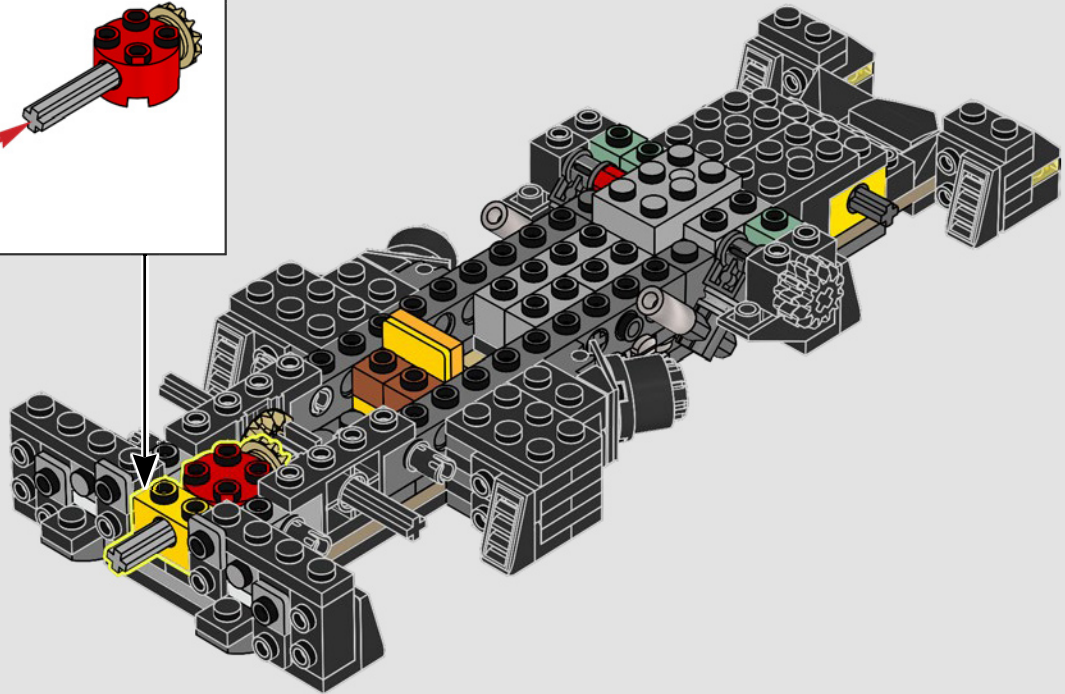
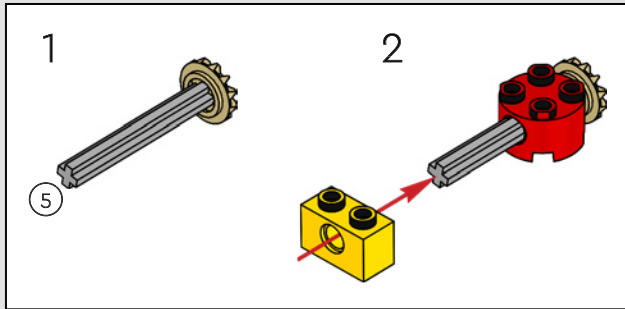

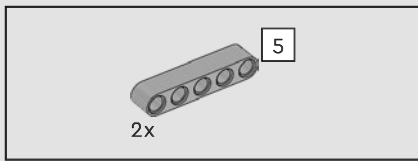

58

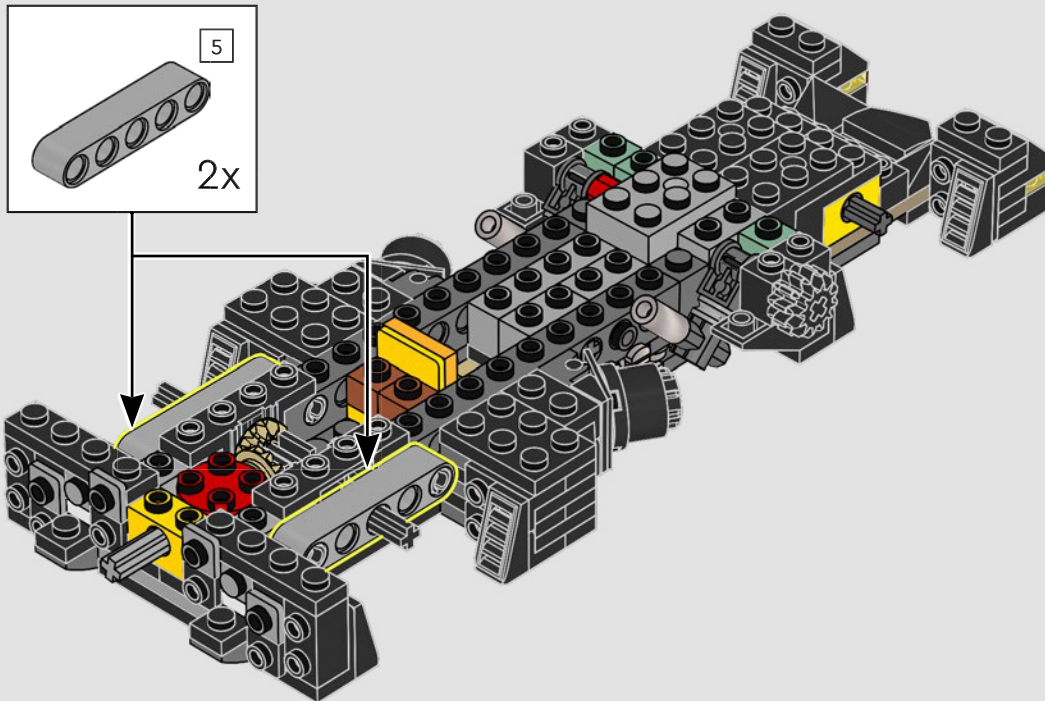

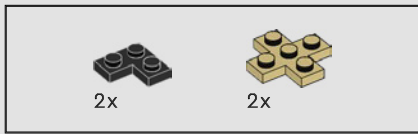

59

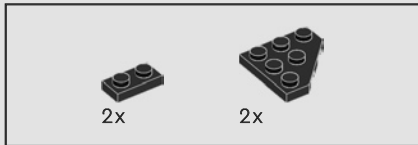
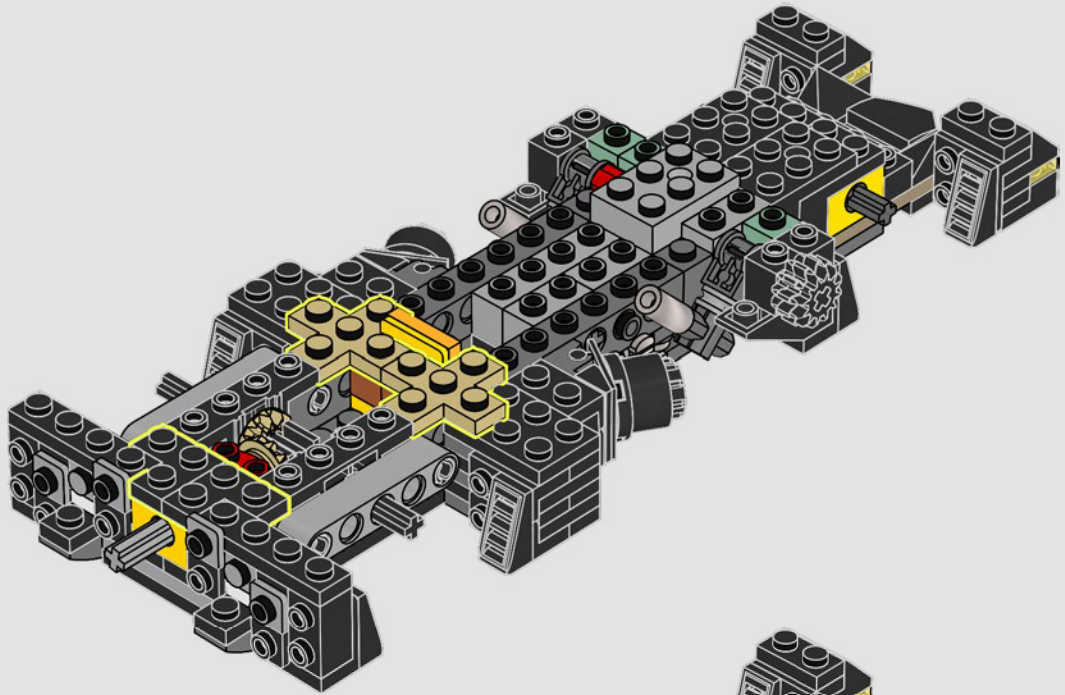

60

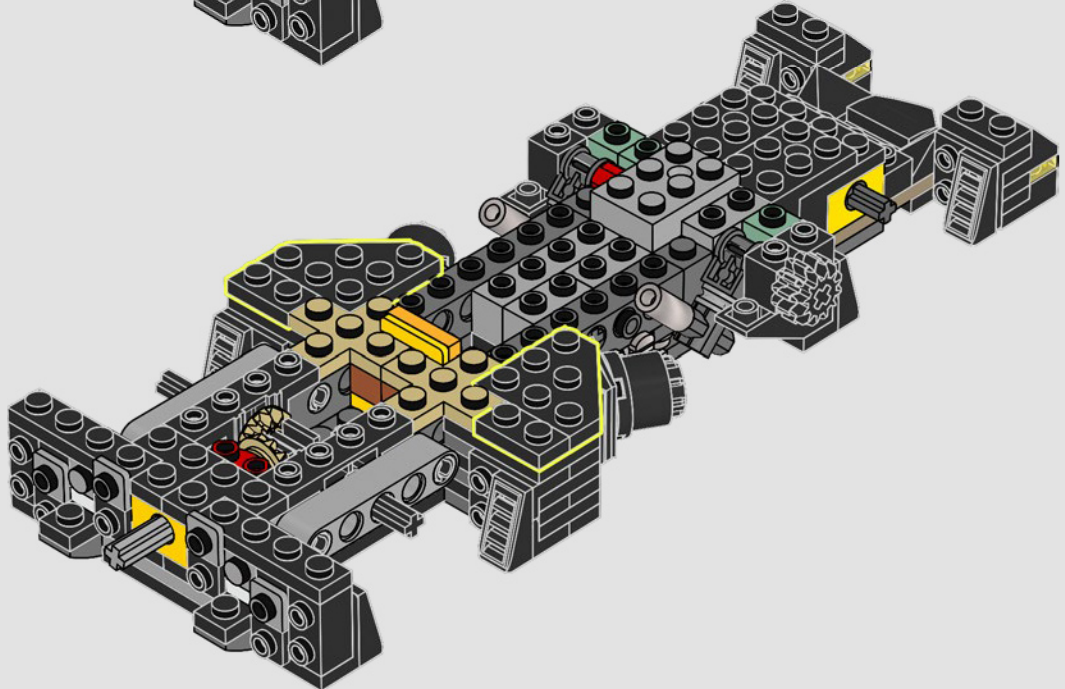

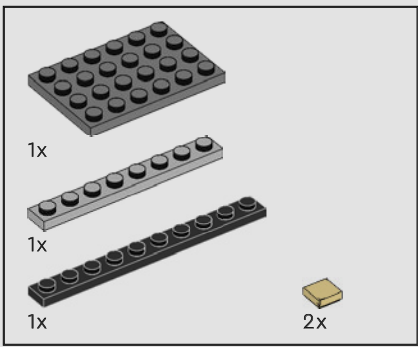

61

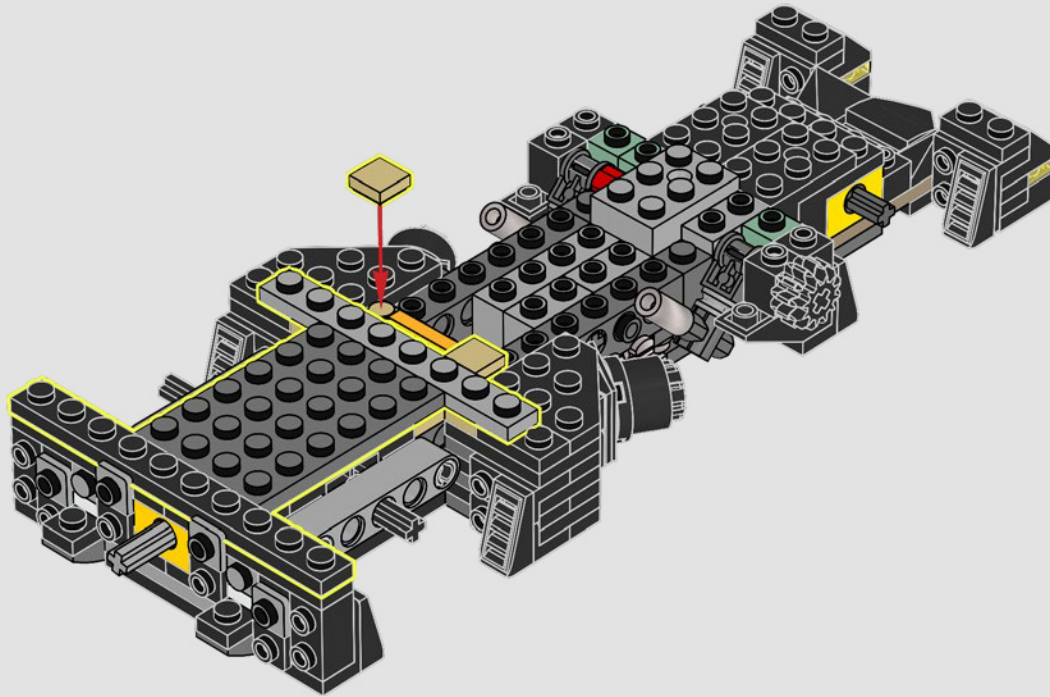



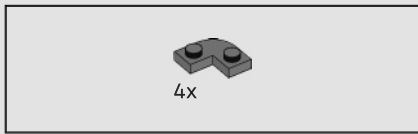

62

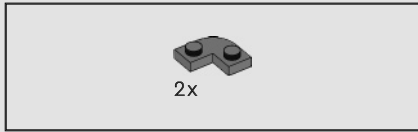
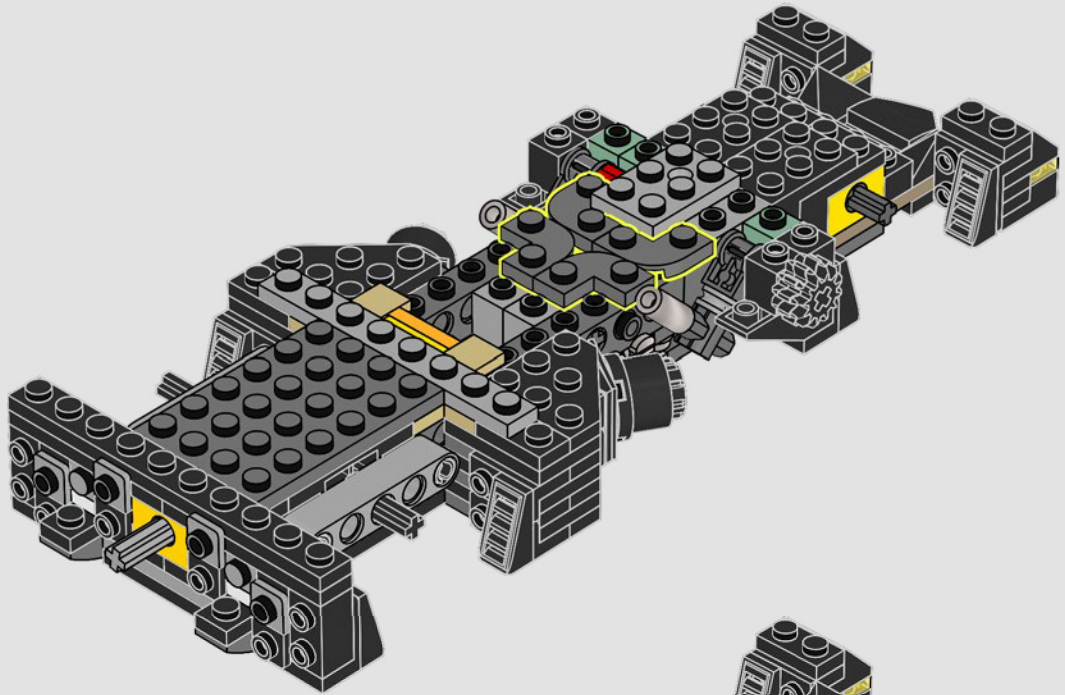

63

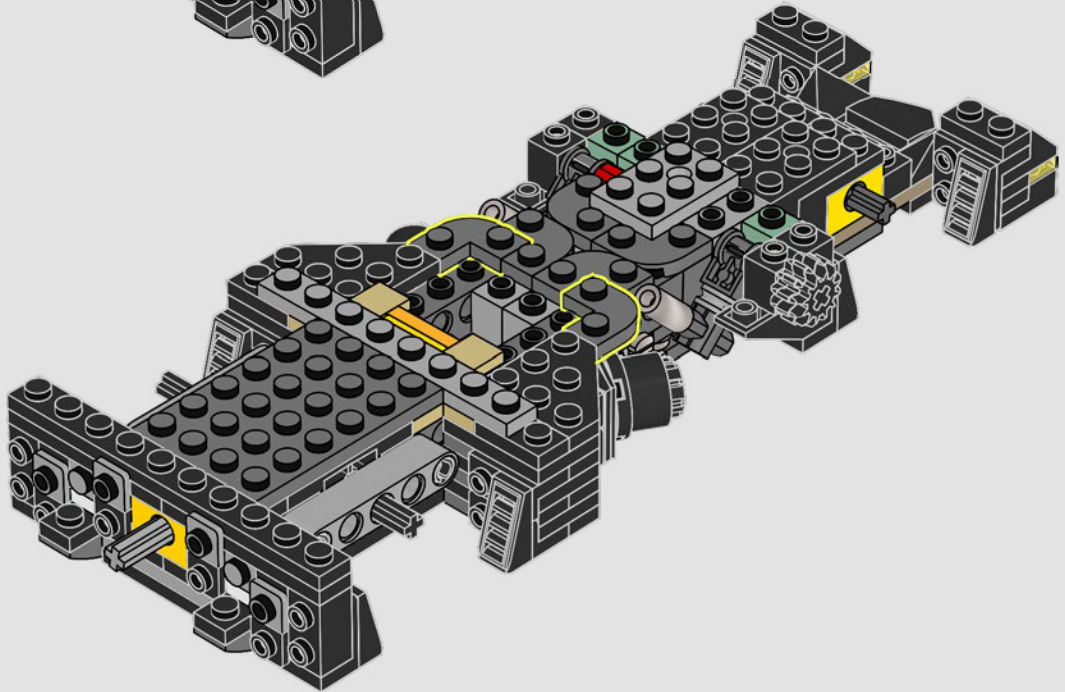

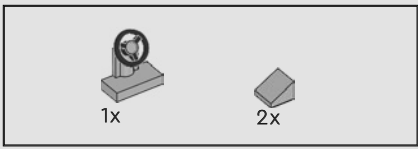

64

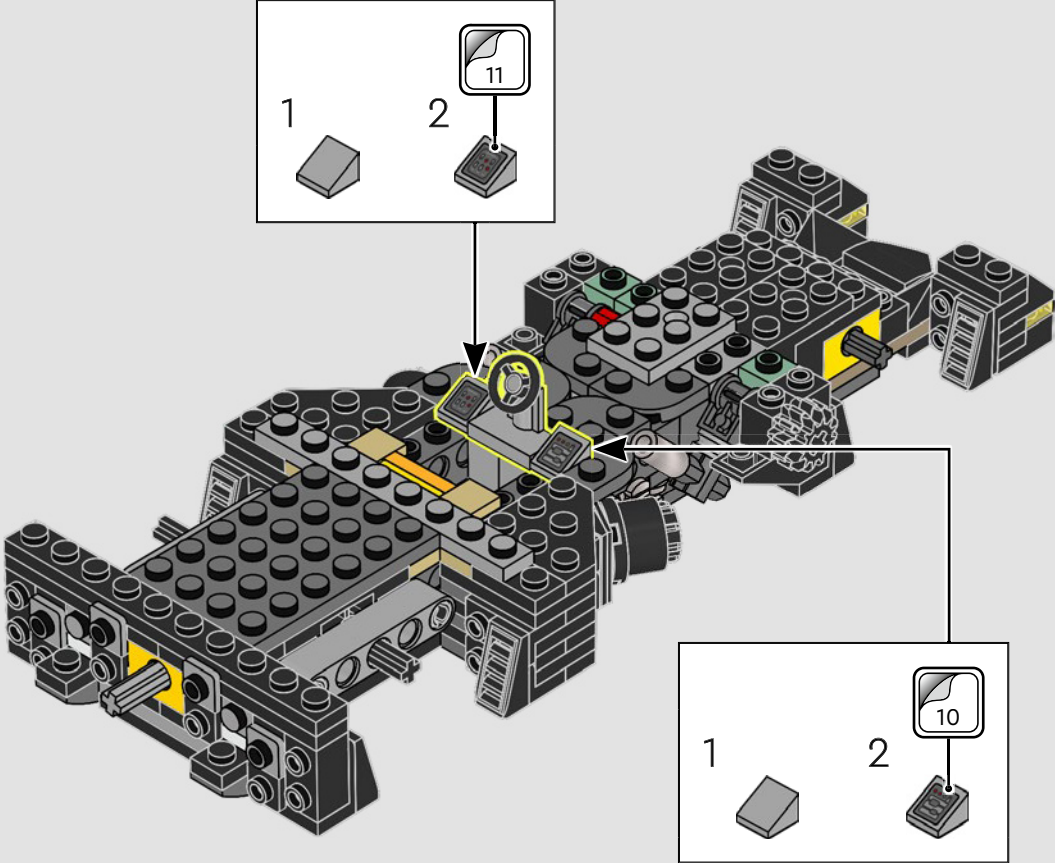

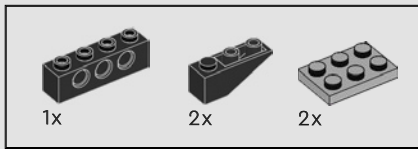

65

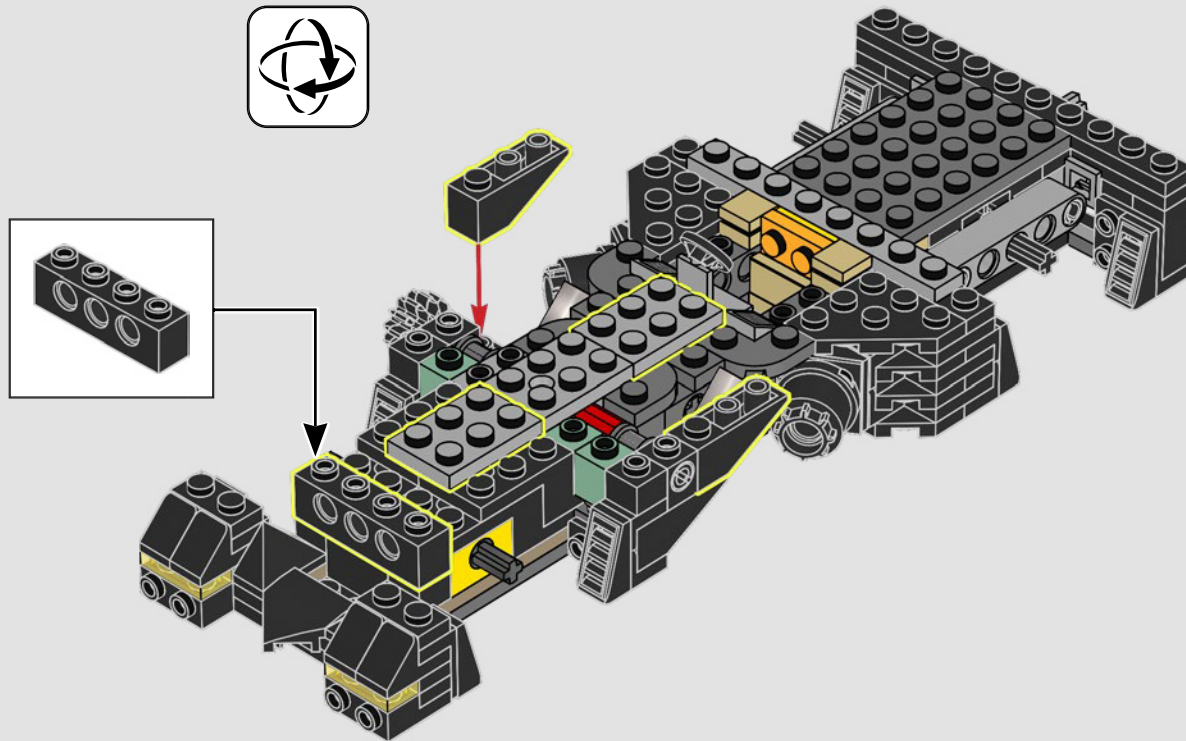

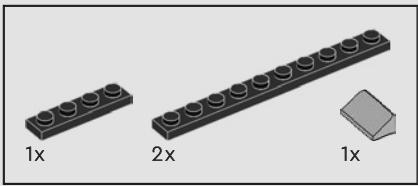

66

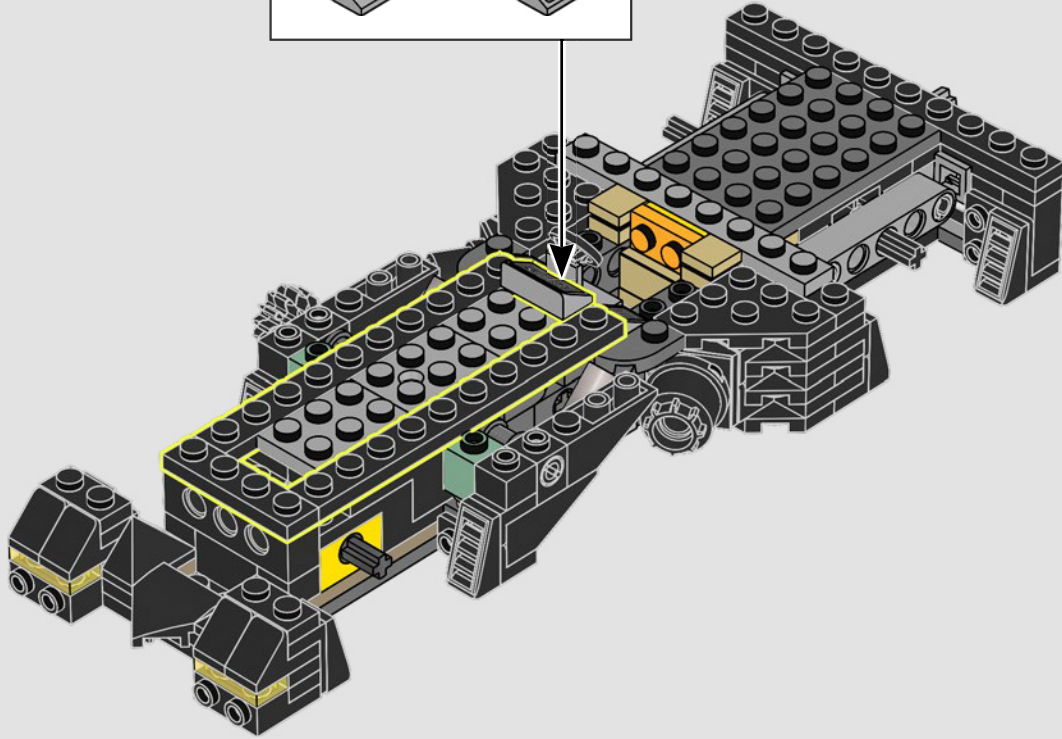
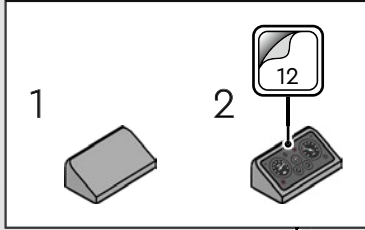



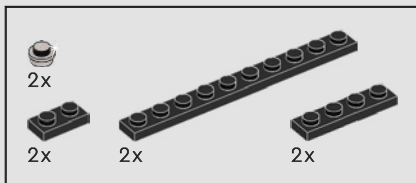

67

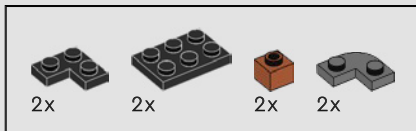
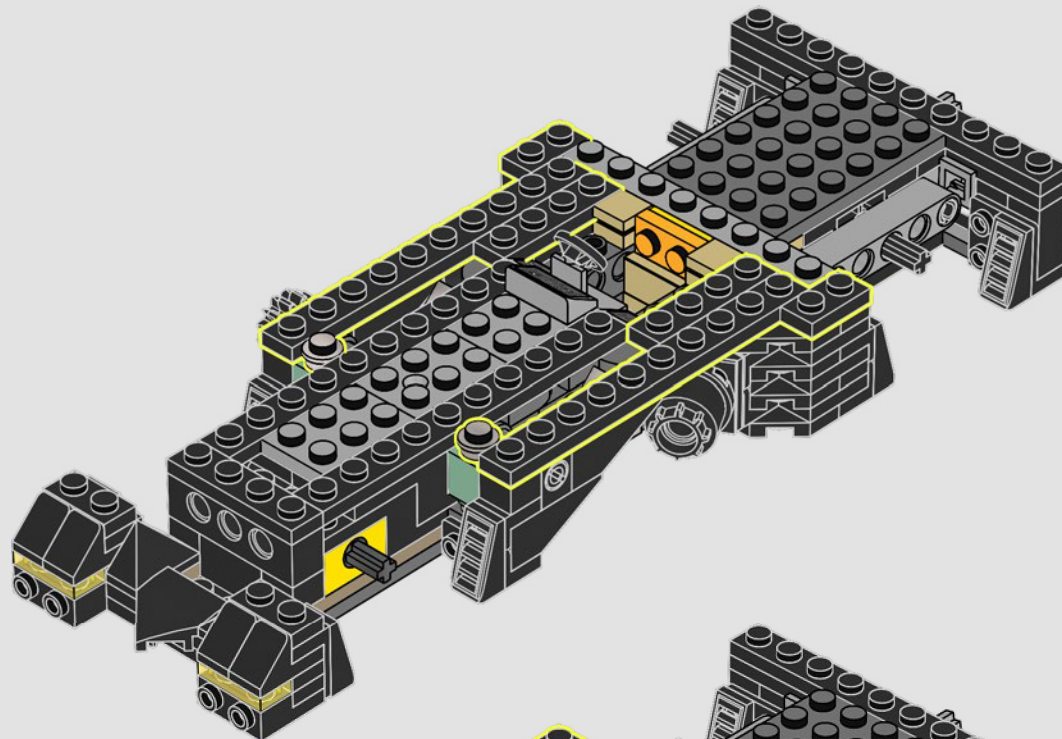

68

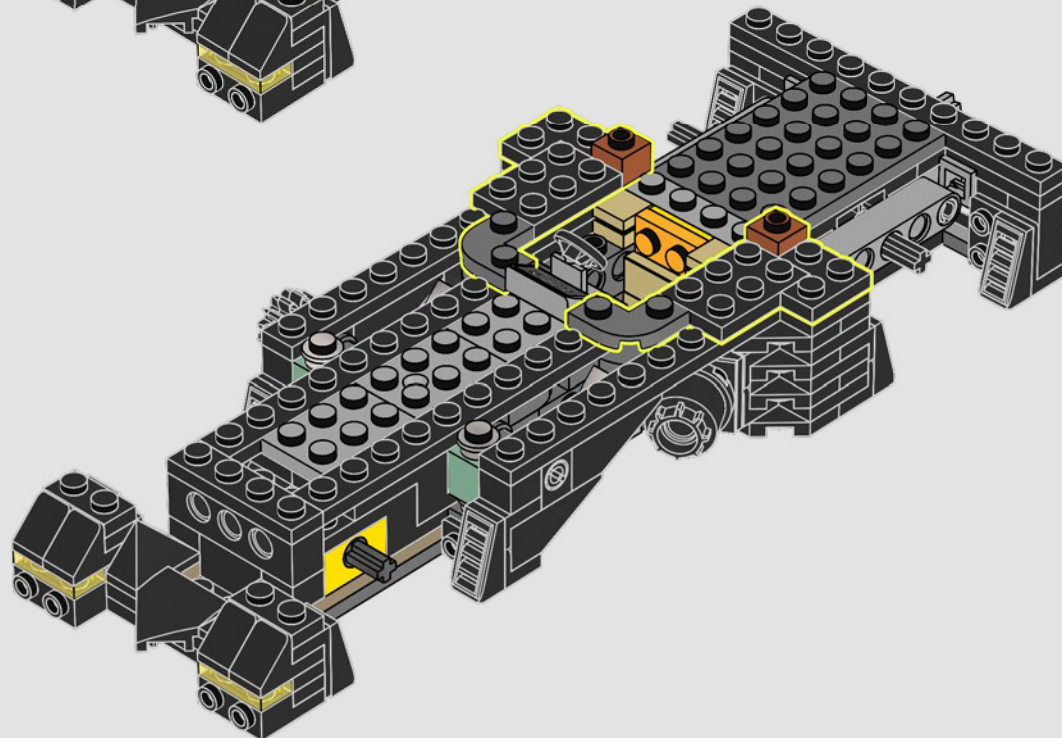

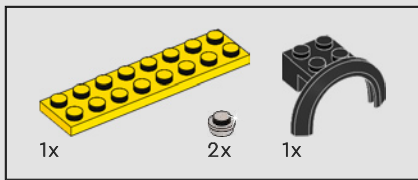

69

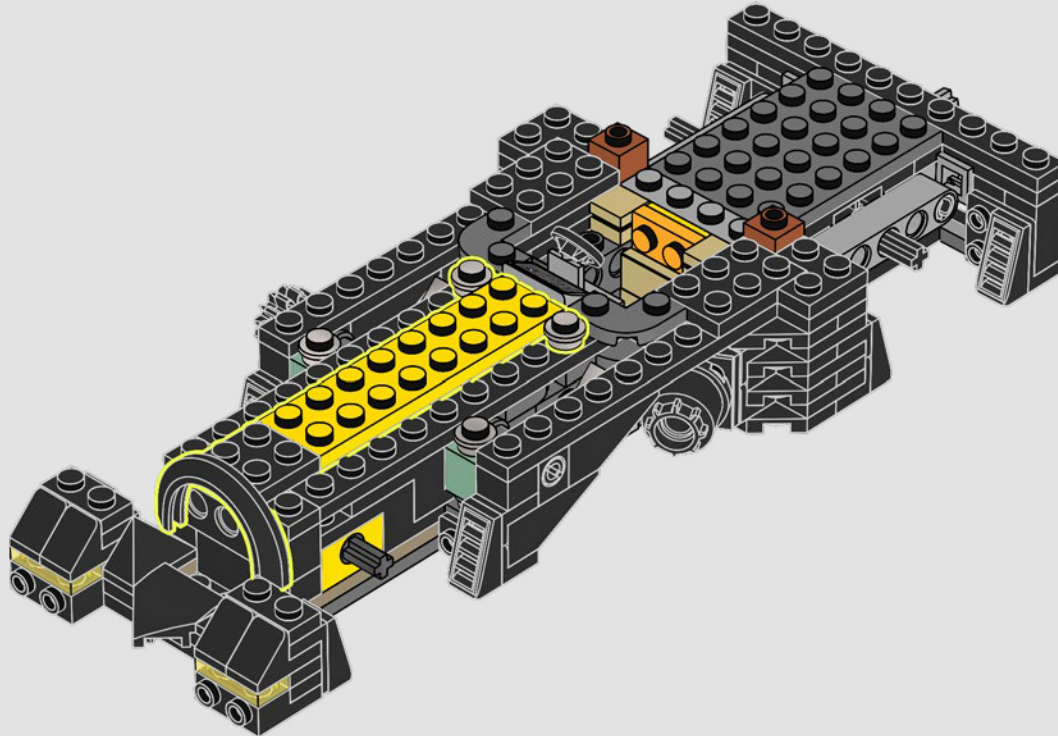

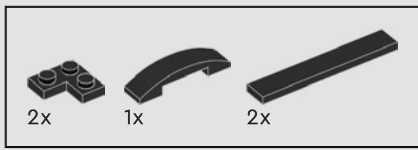

70

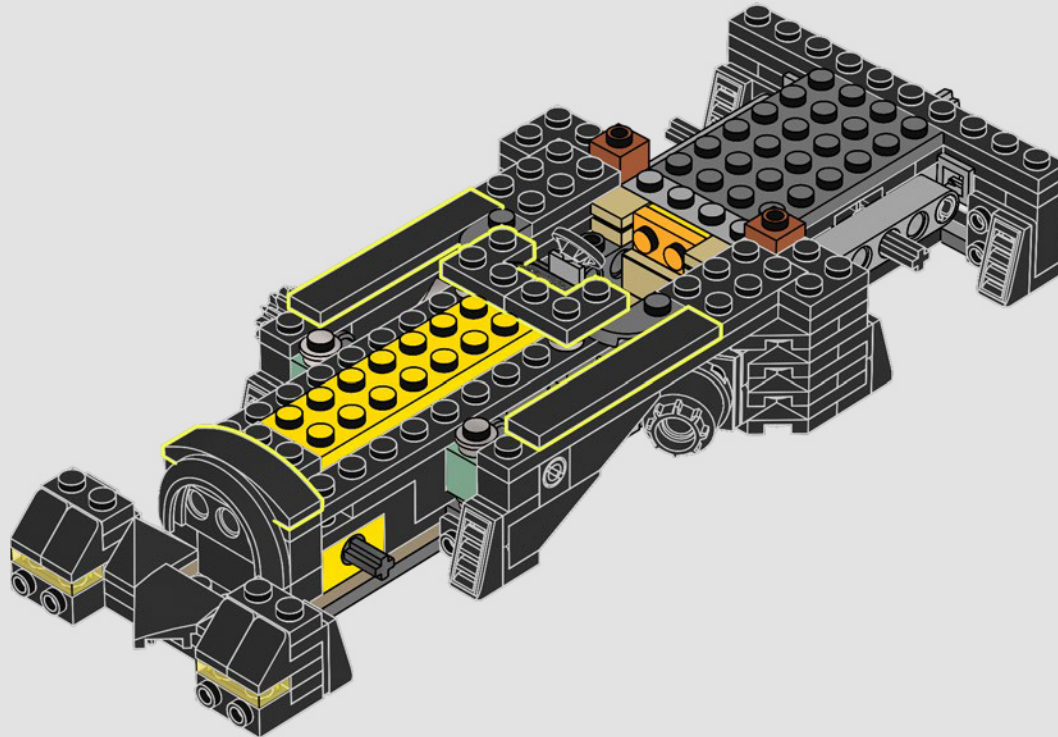



71

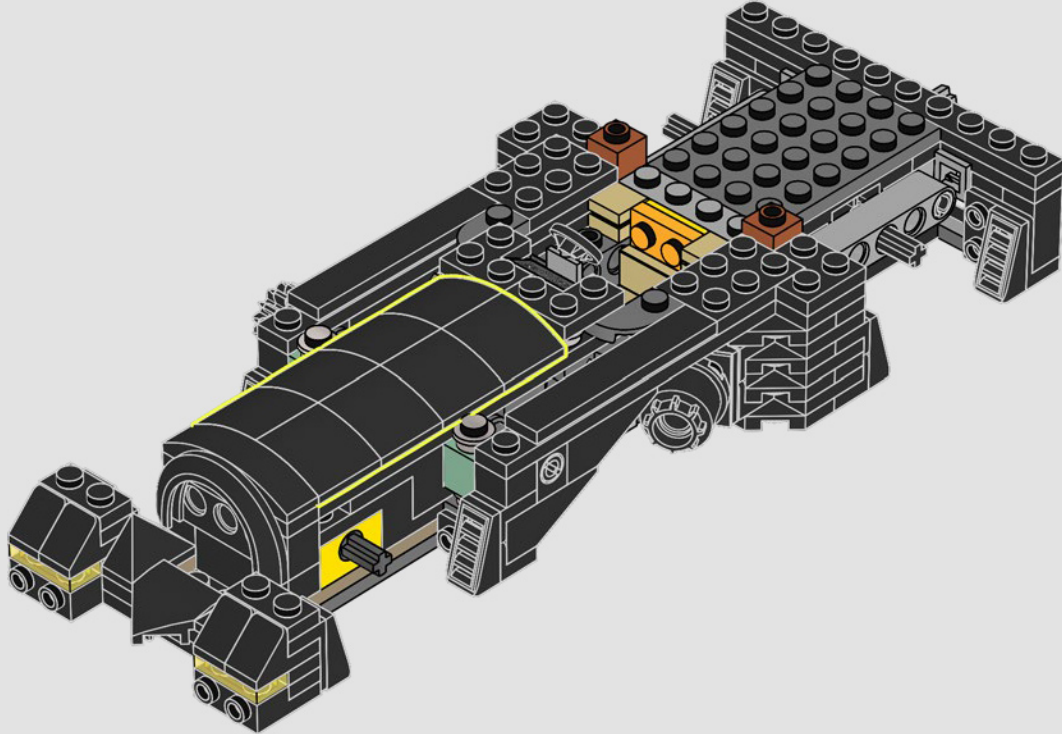



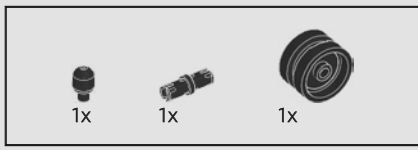

72

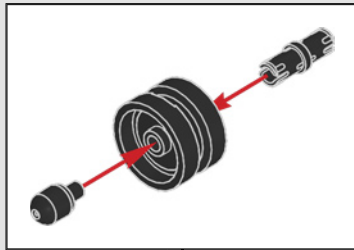
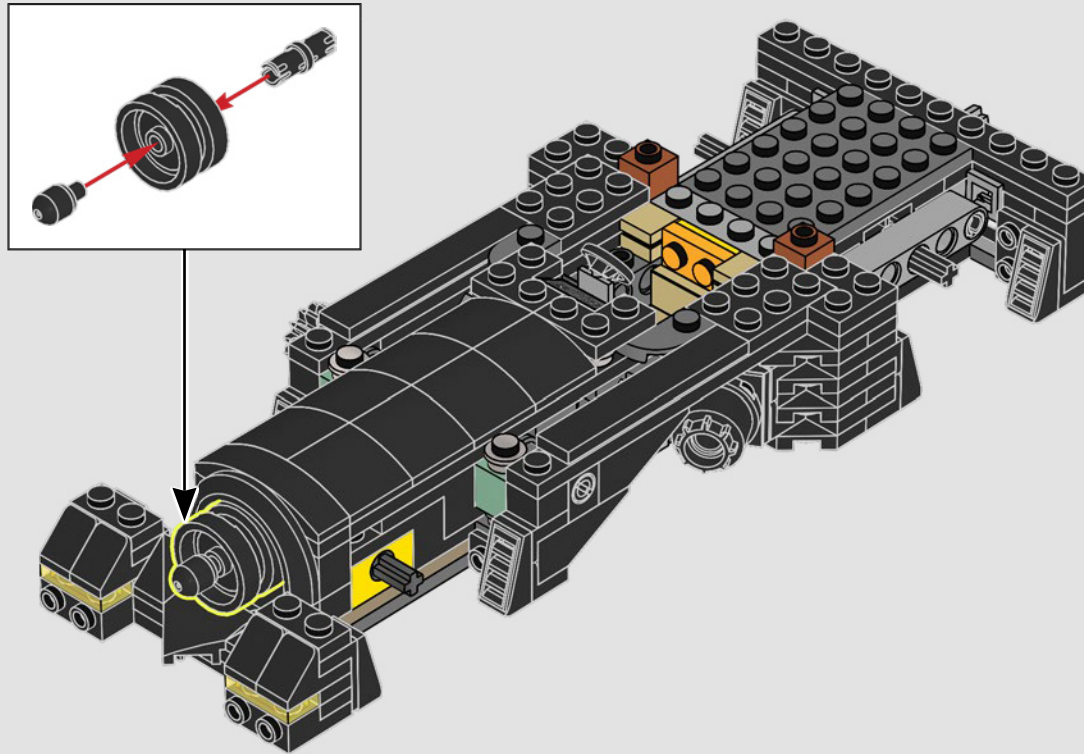



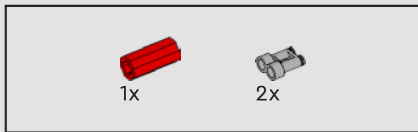

73

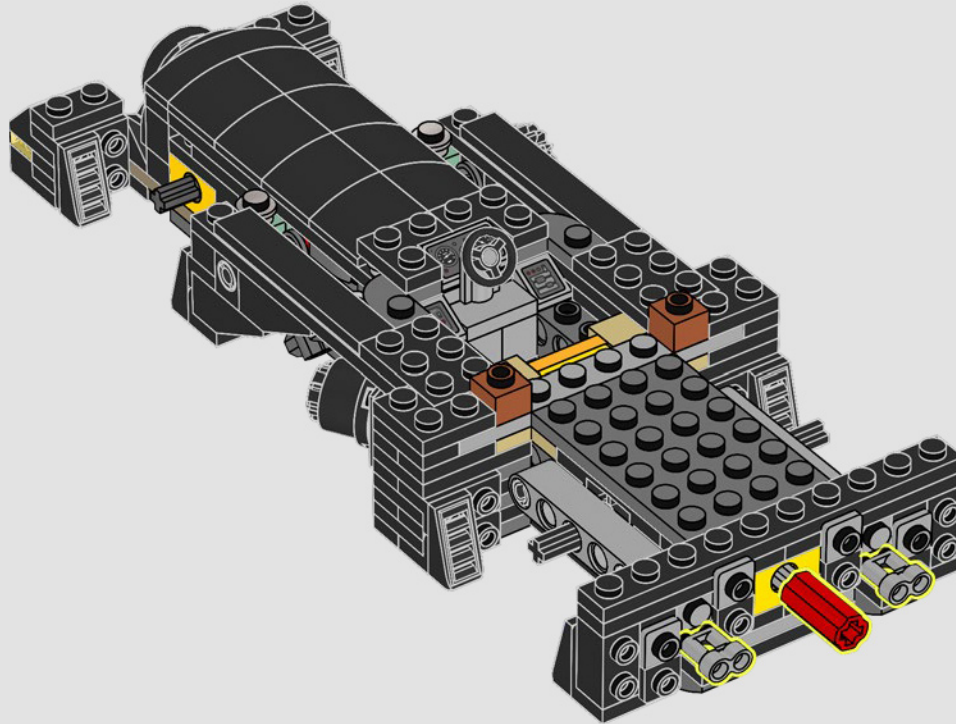



74

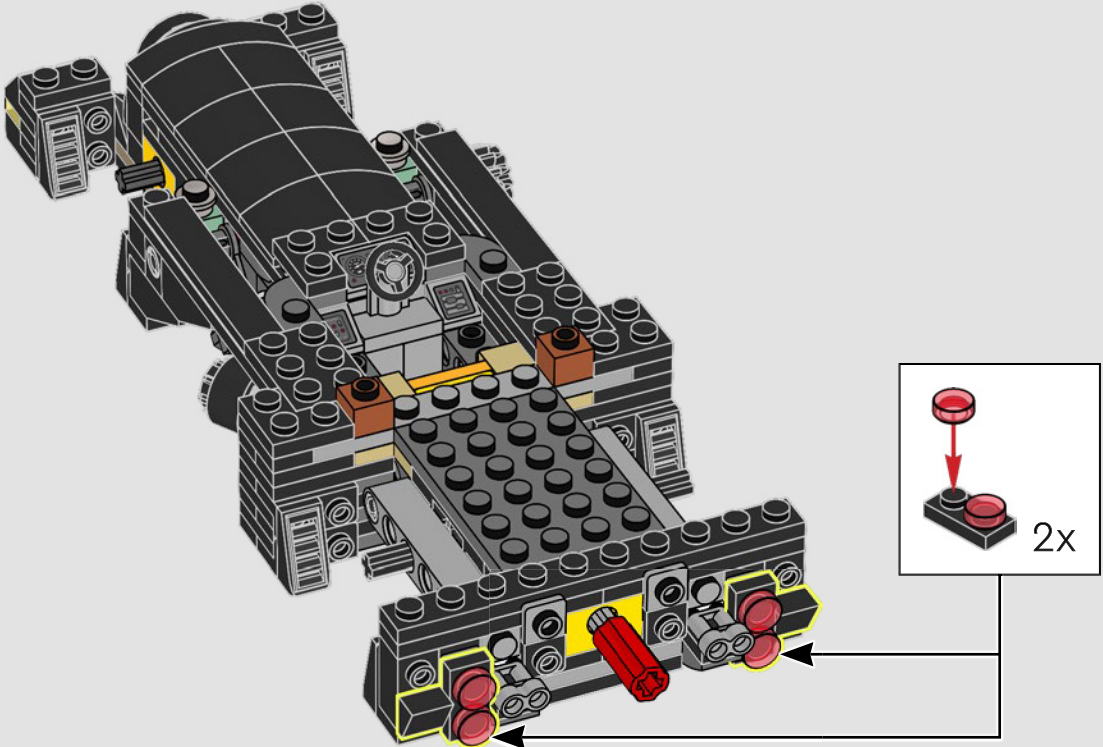



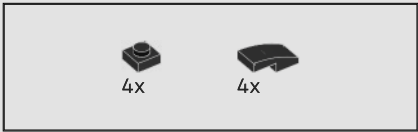

75

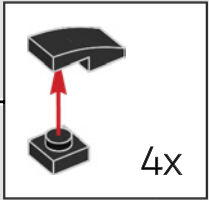
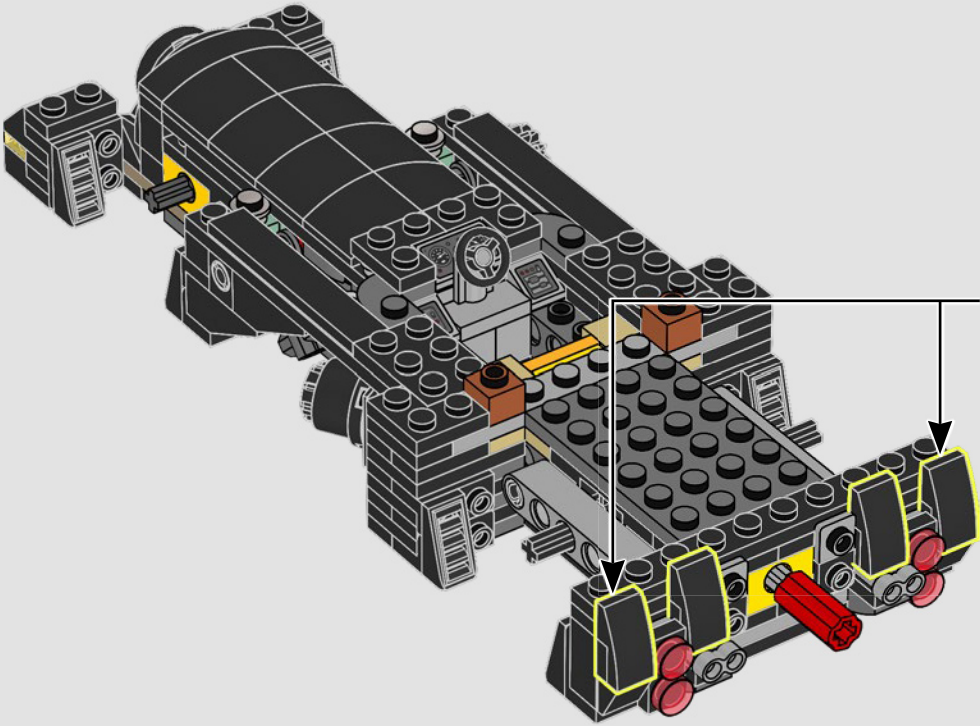

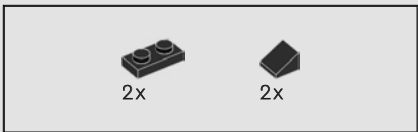

76

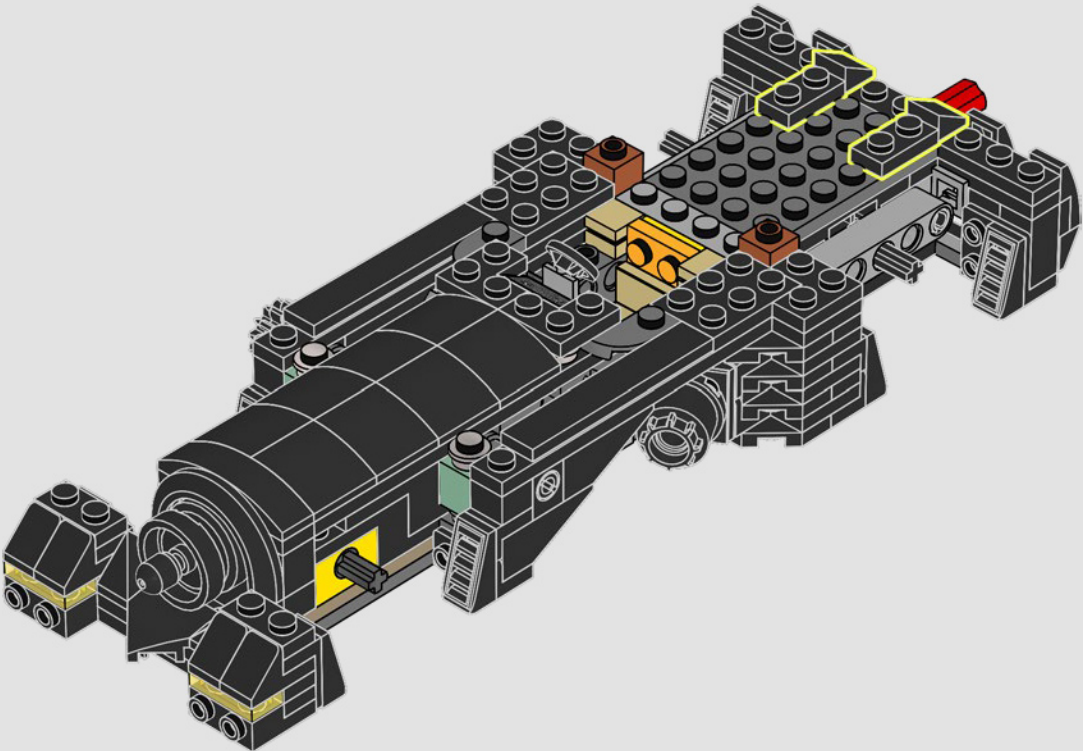

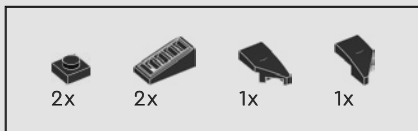

77

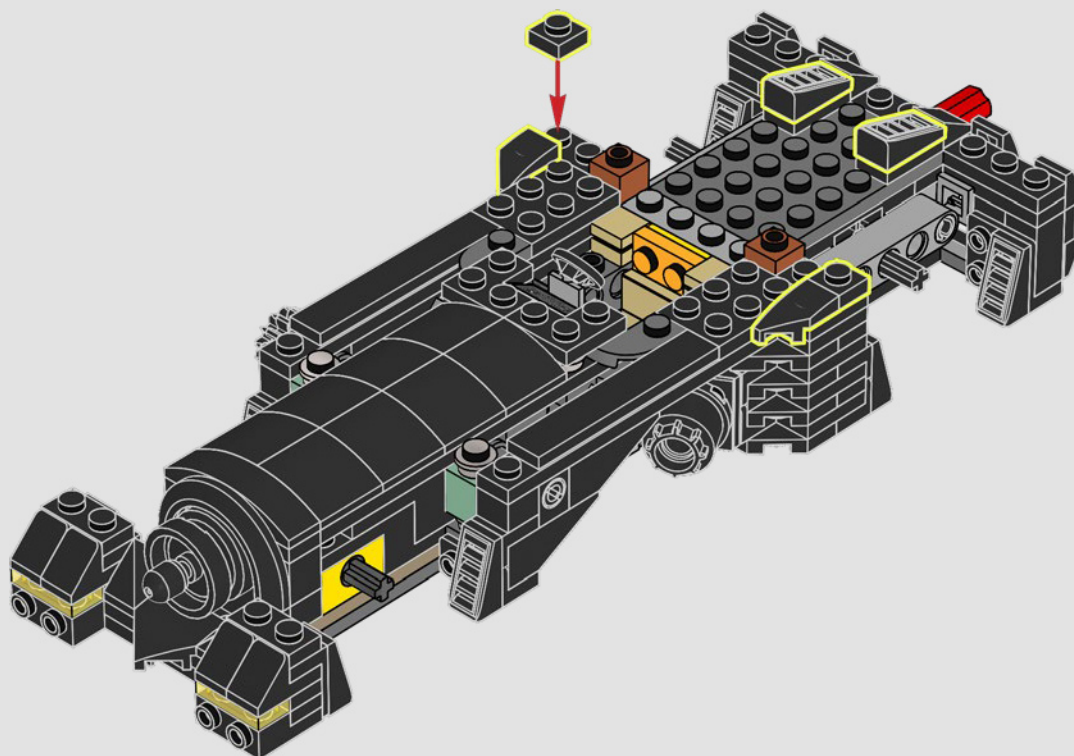

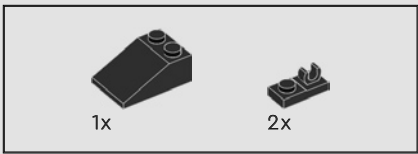

78

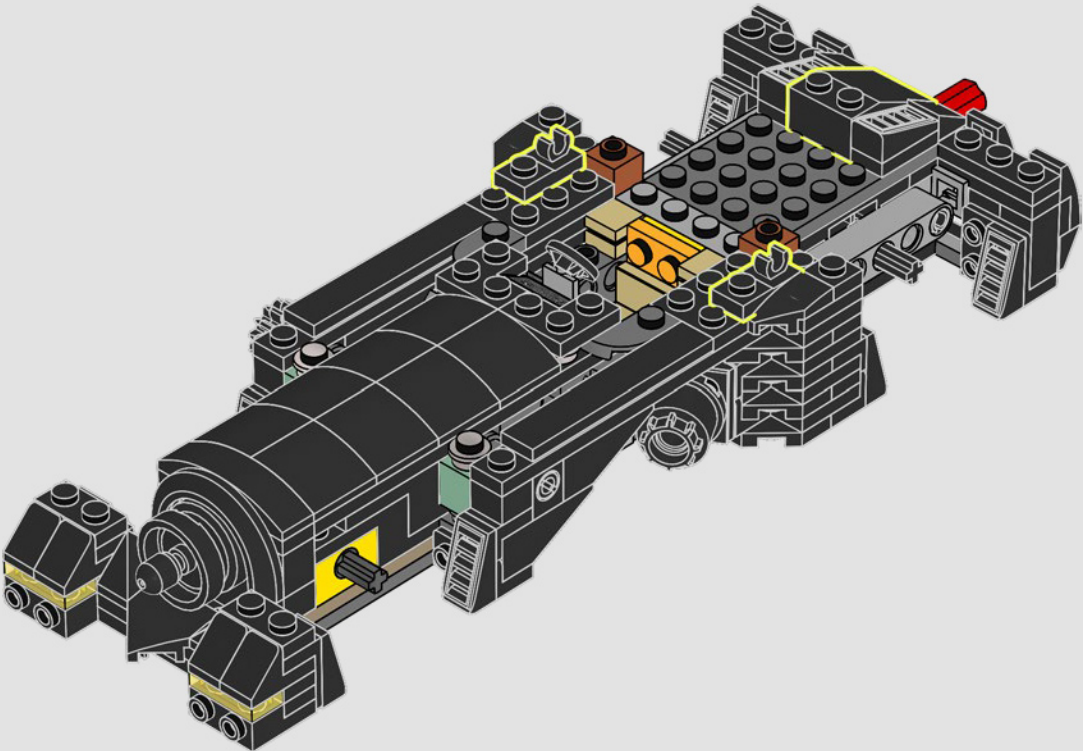



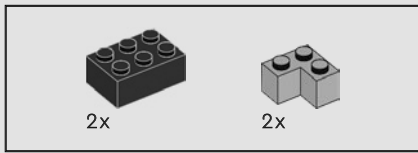

79

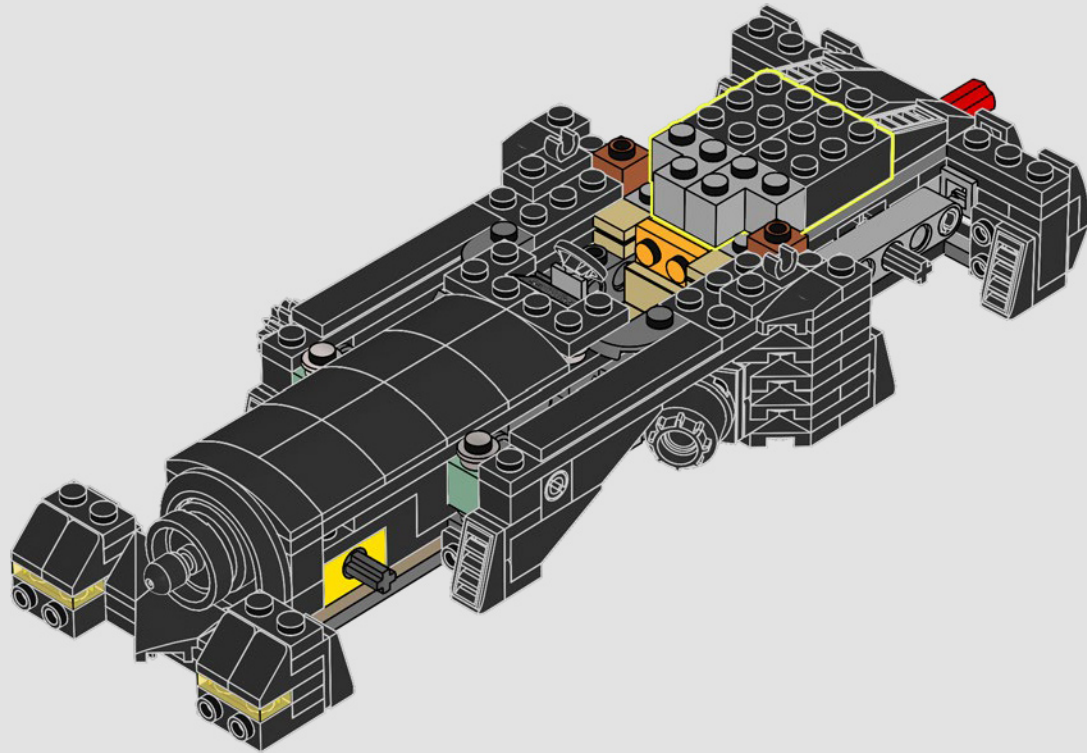

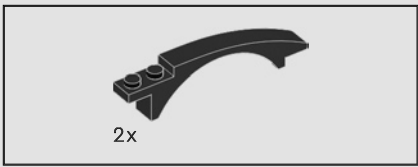

80

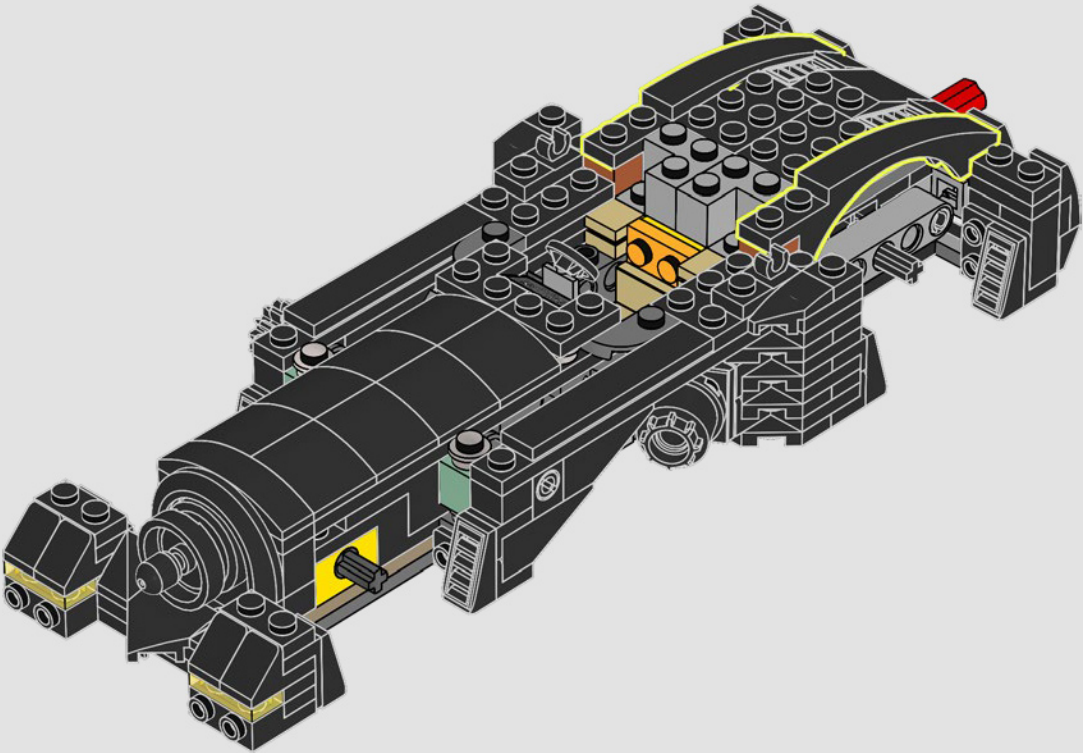



81

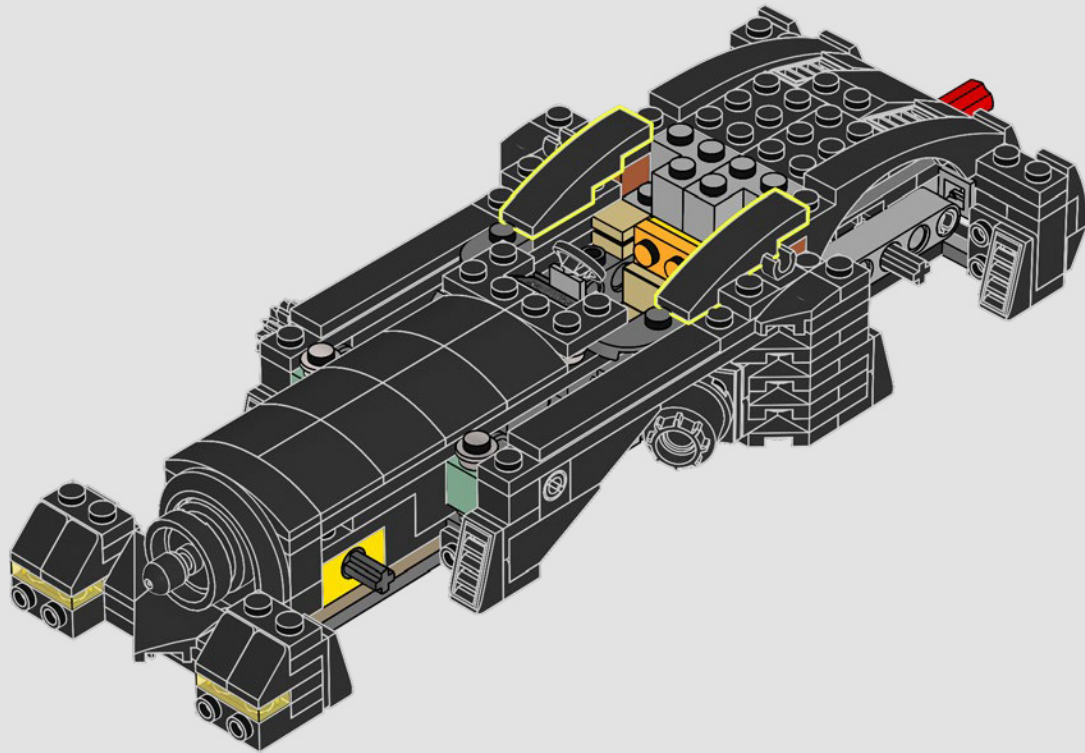

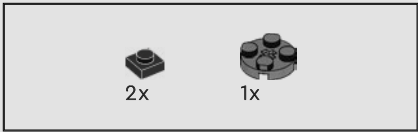

82

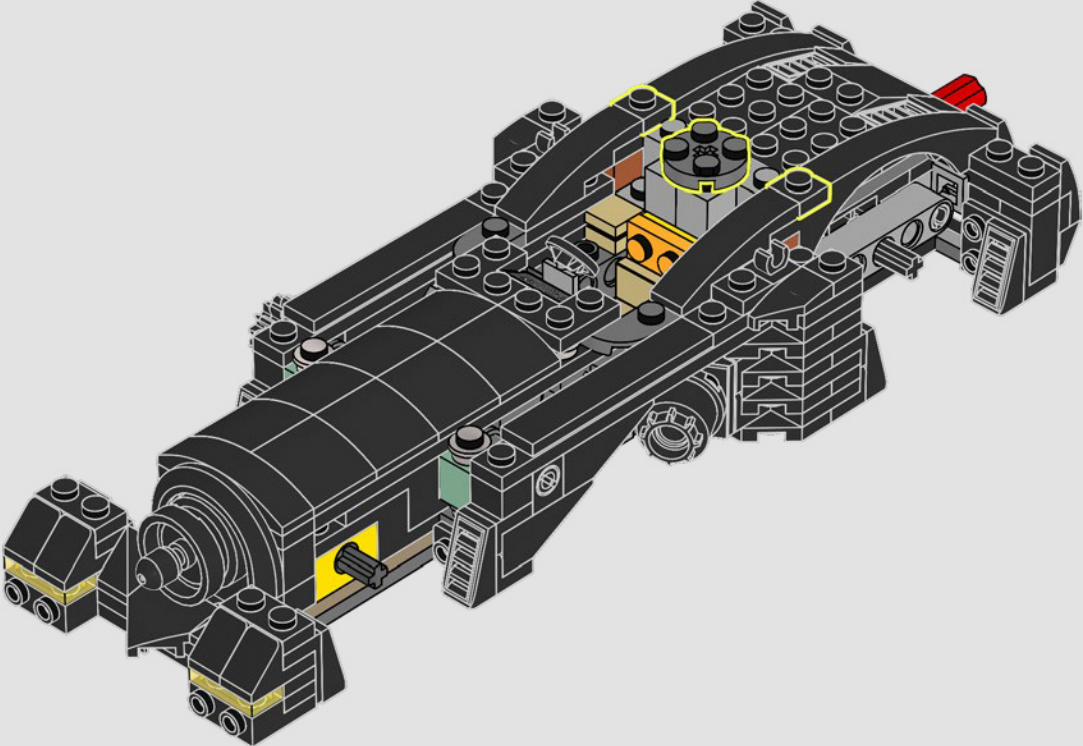



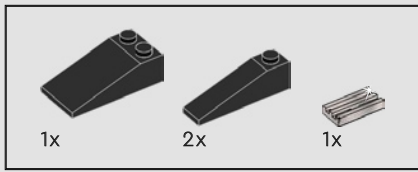

83

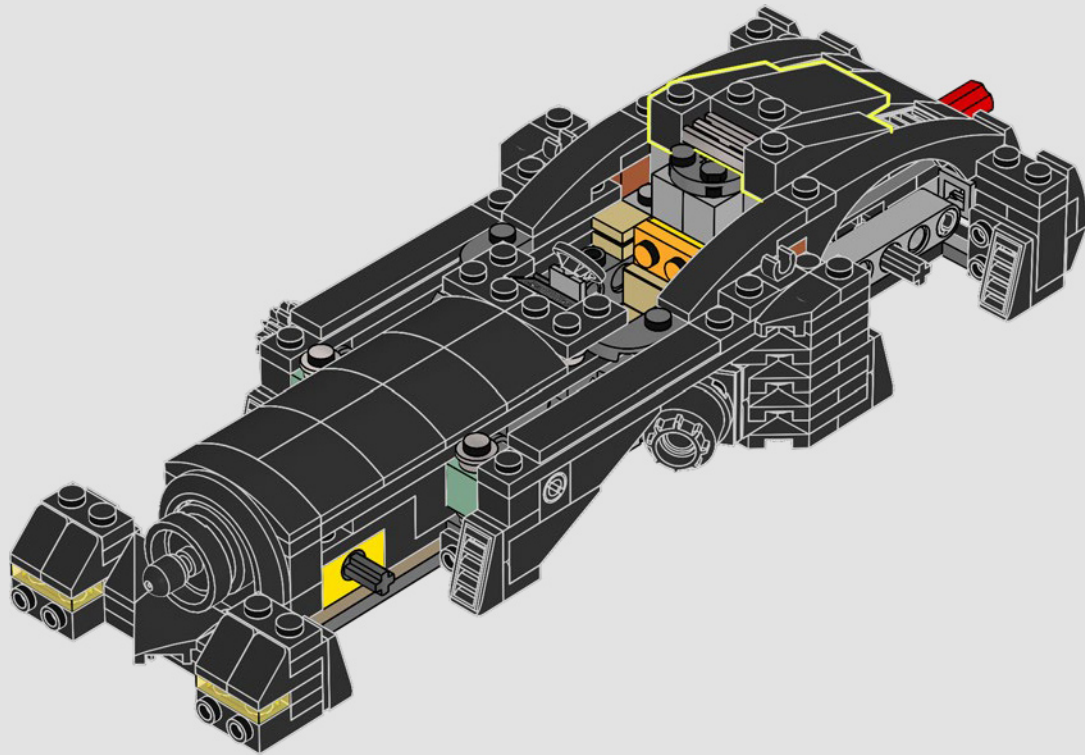

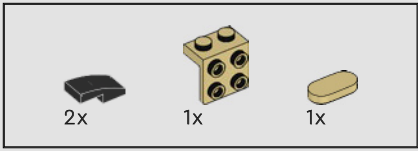

84

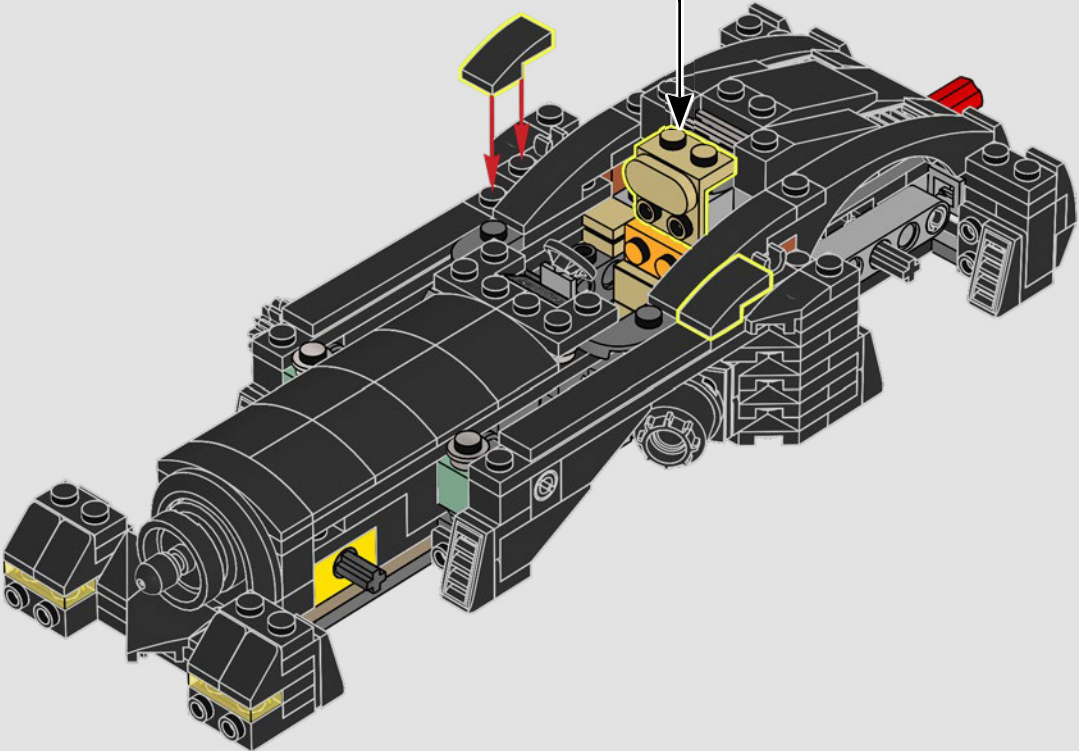
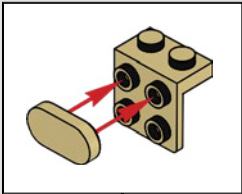

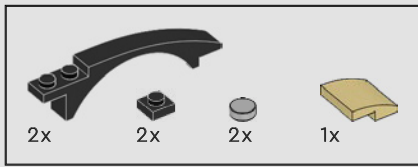

85

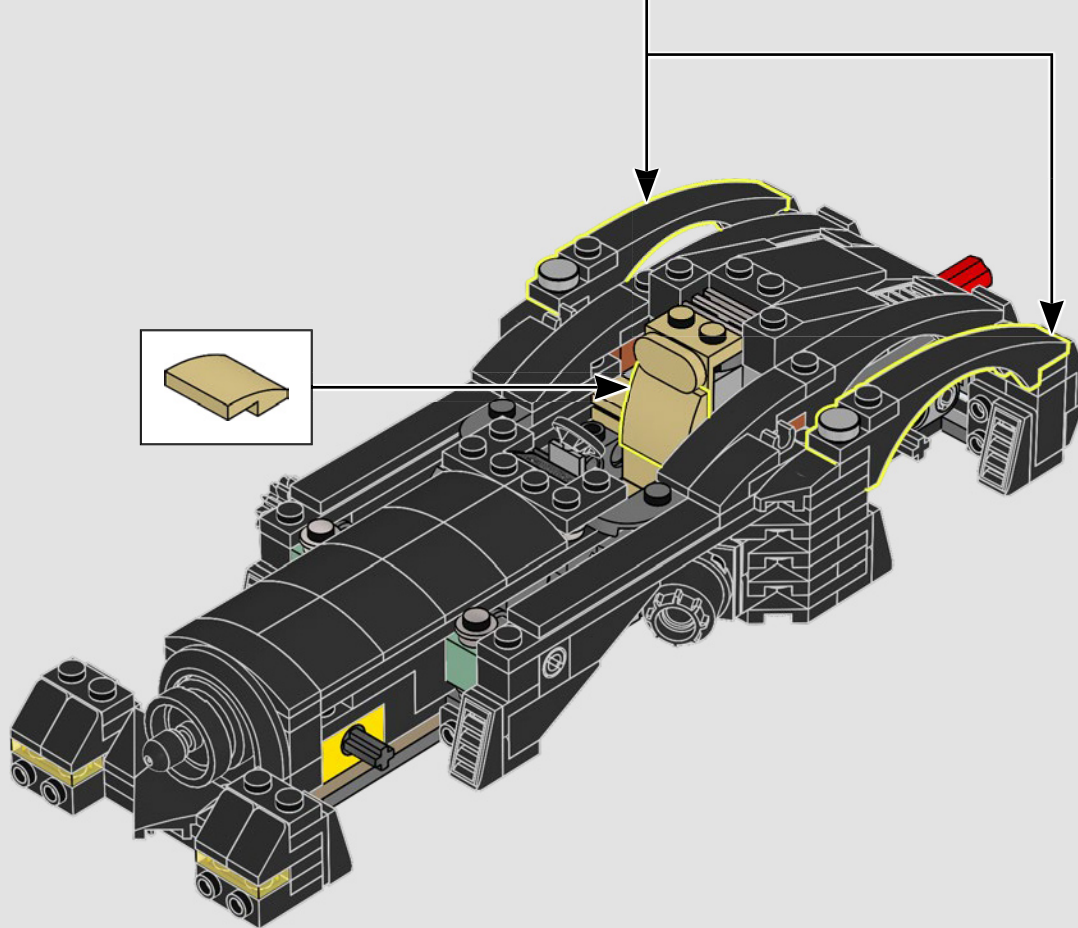
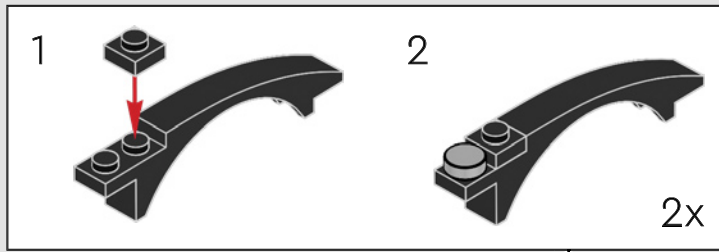

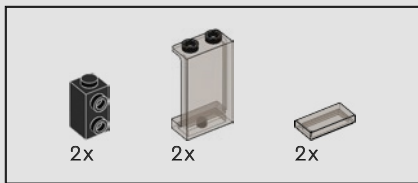

86

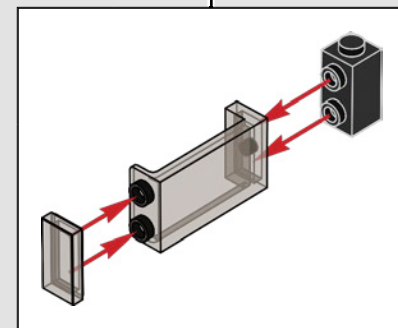
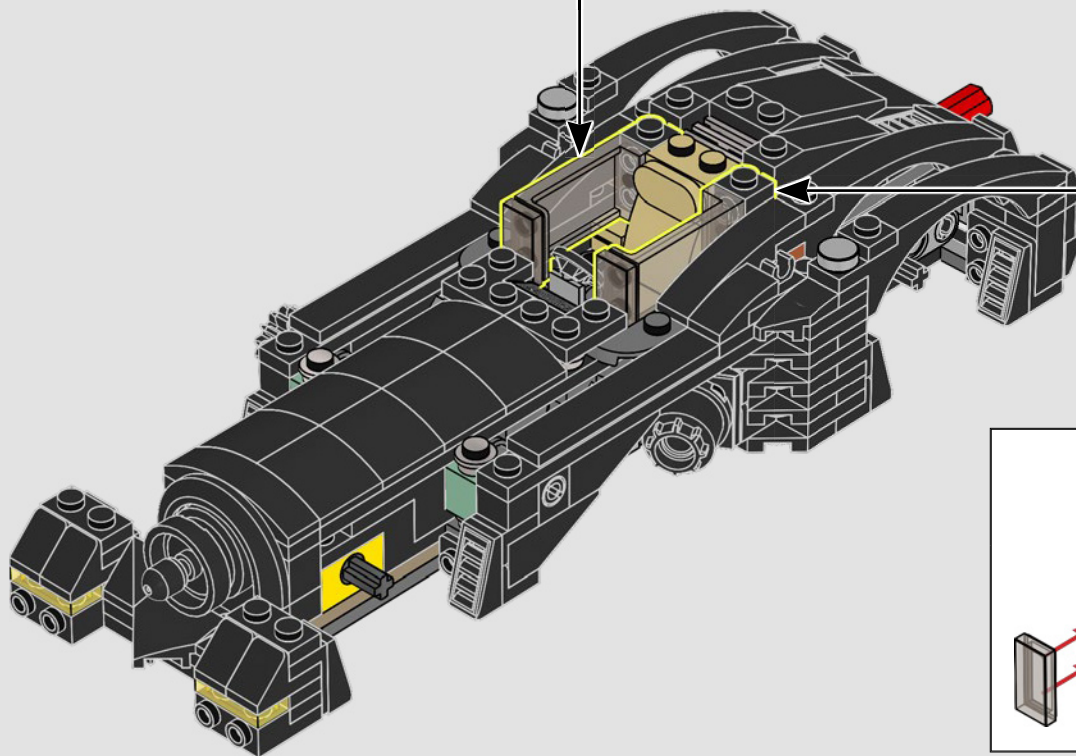
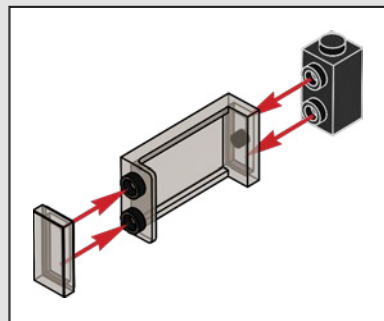



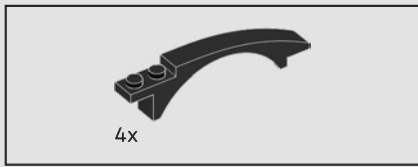

87

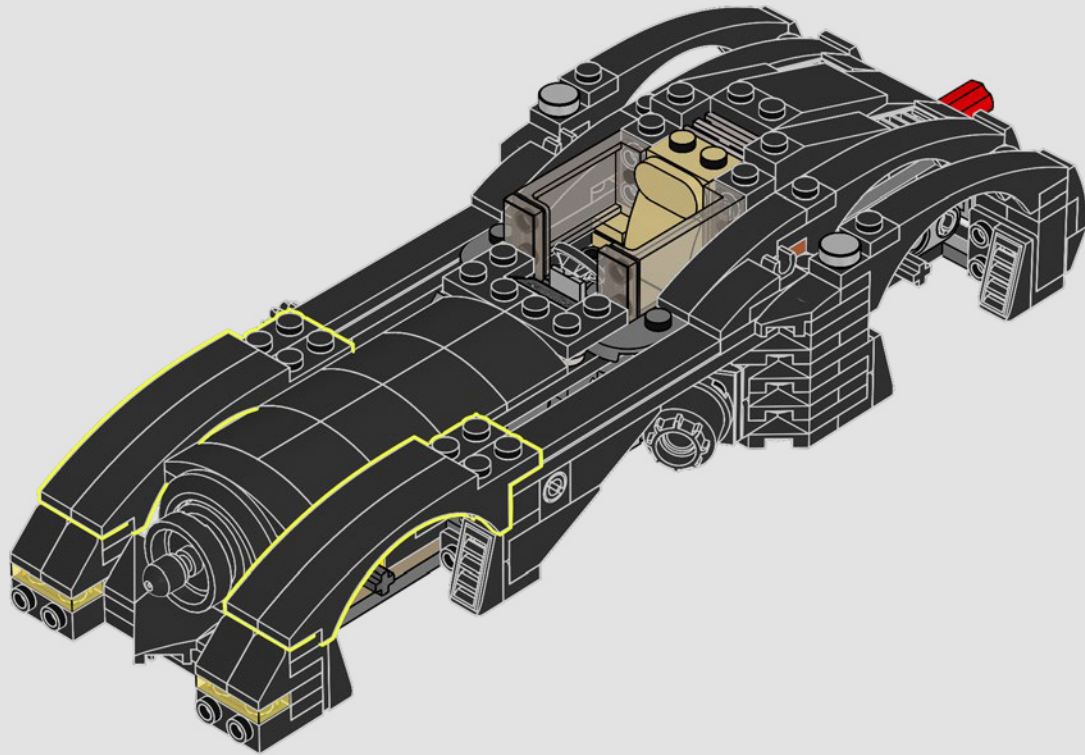

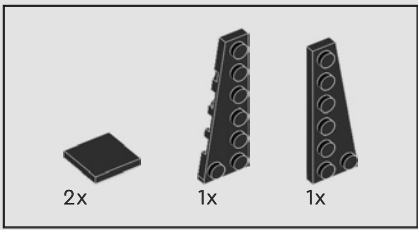

88

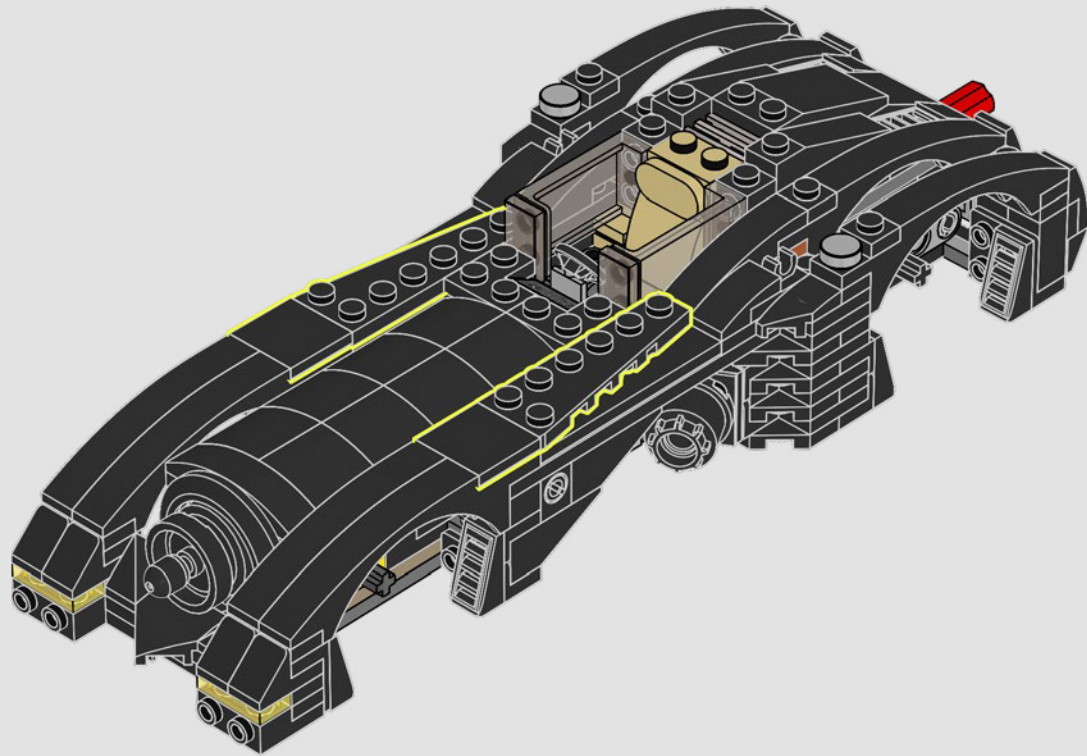

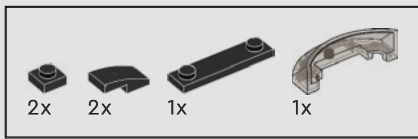

89

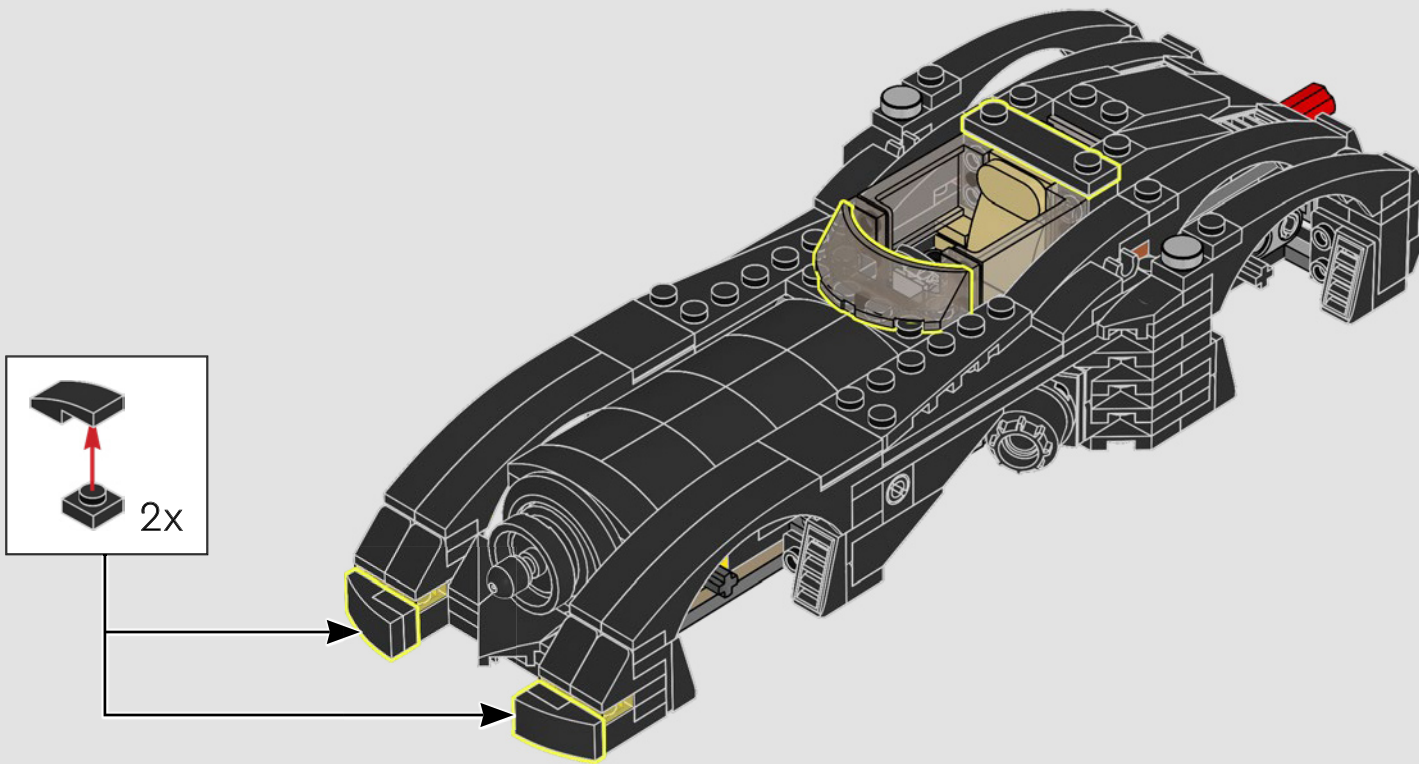

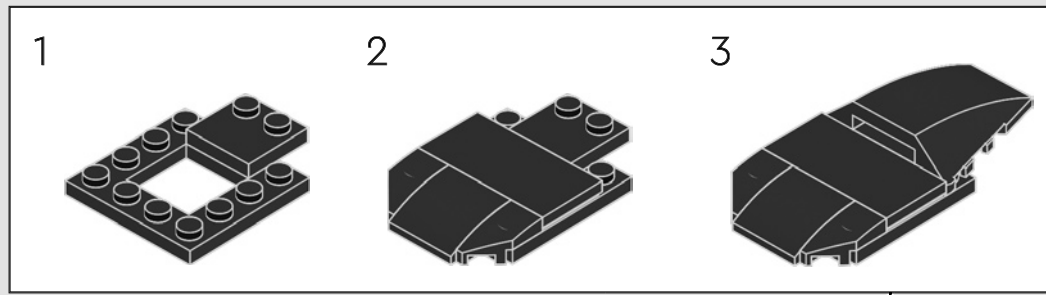
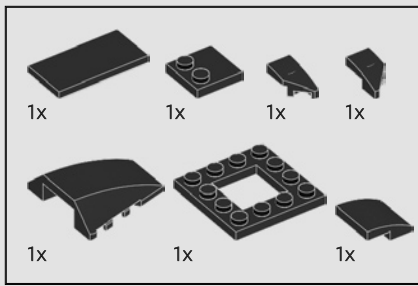

90

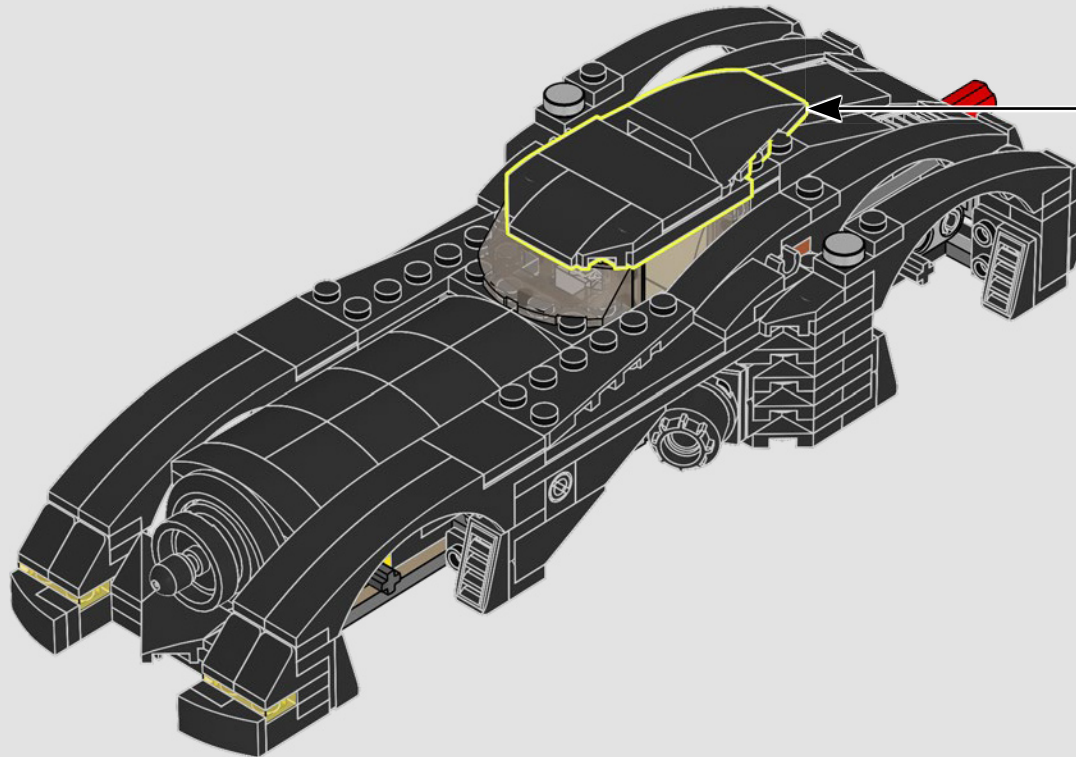



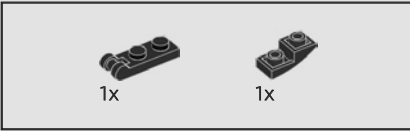
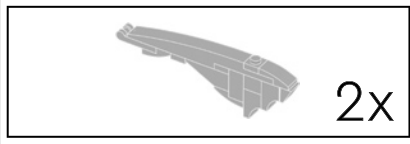

91

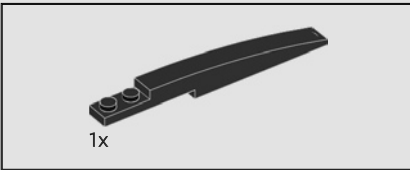
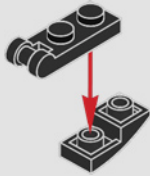

92

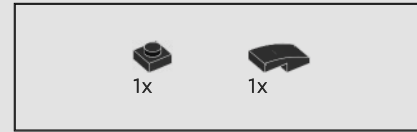
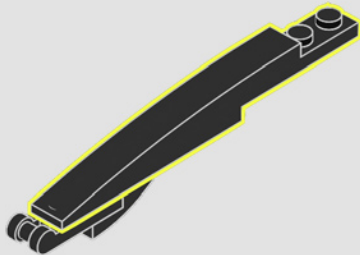

93

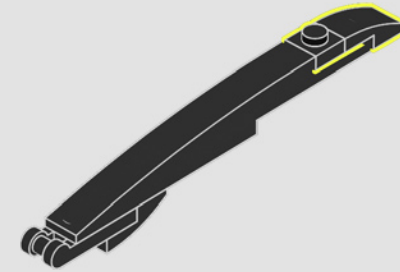

94

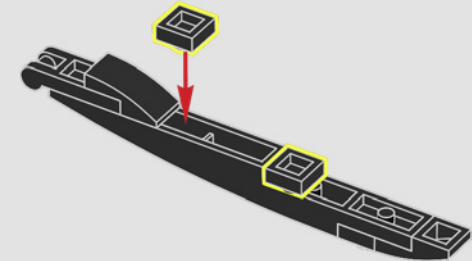
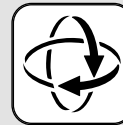

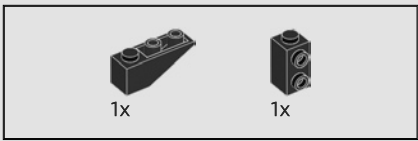

95

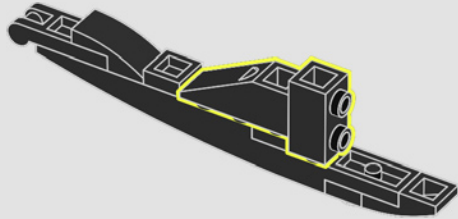

96

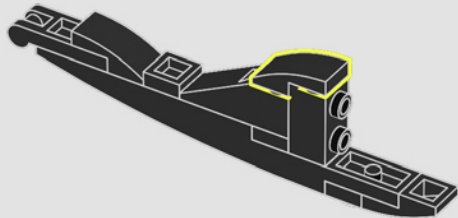

97

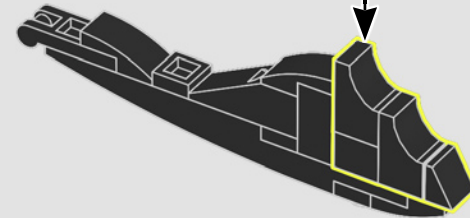
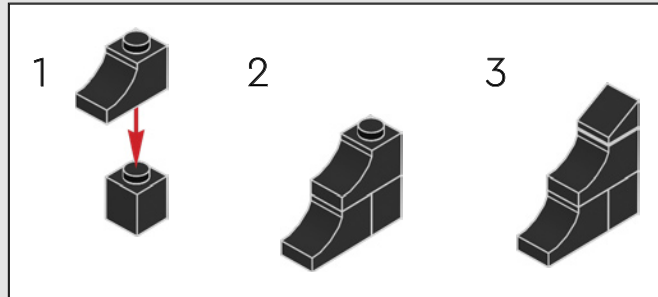

2x



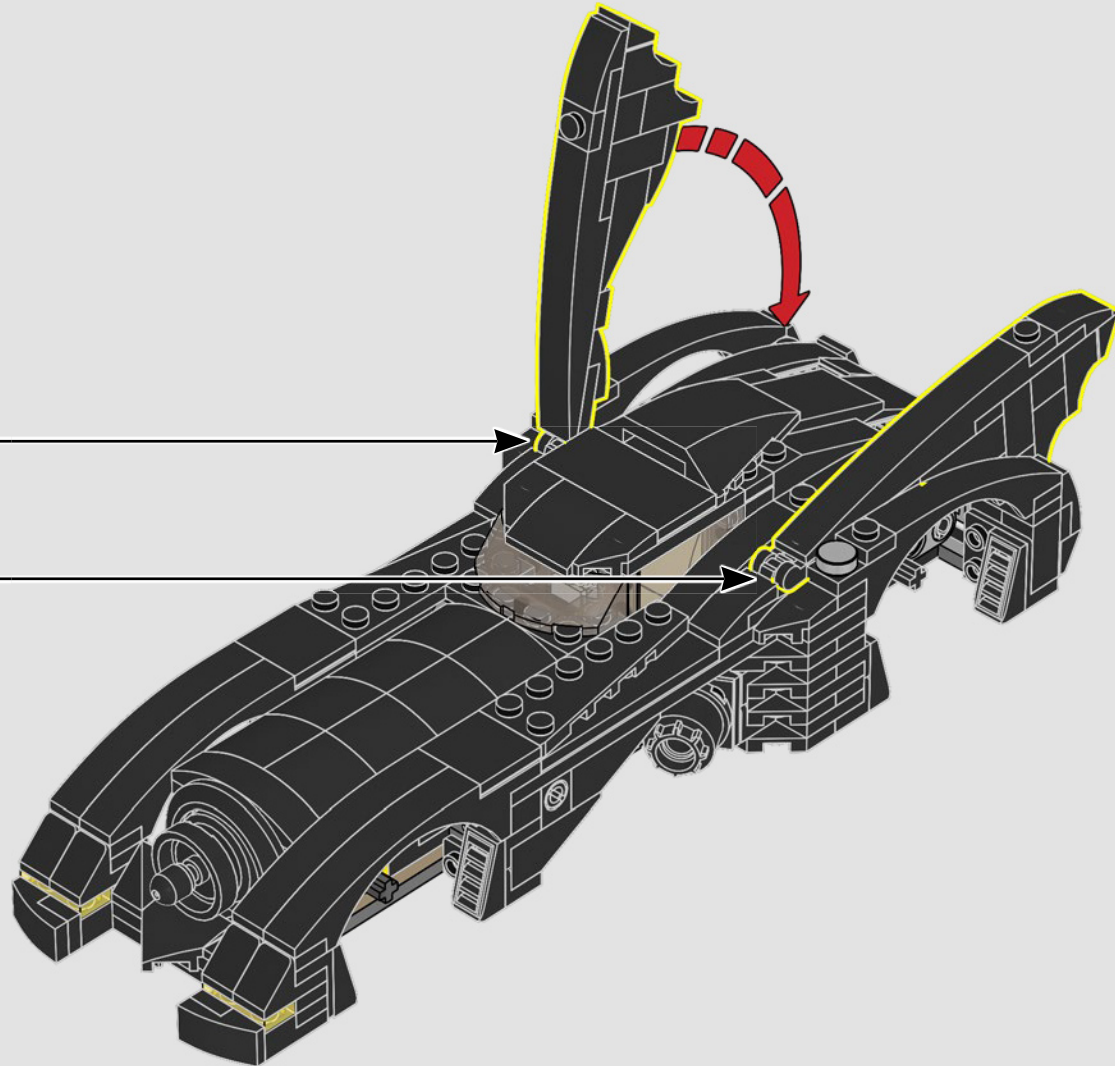

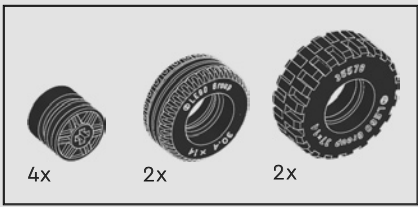

99

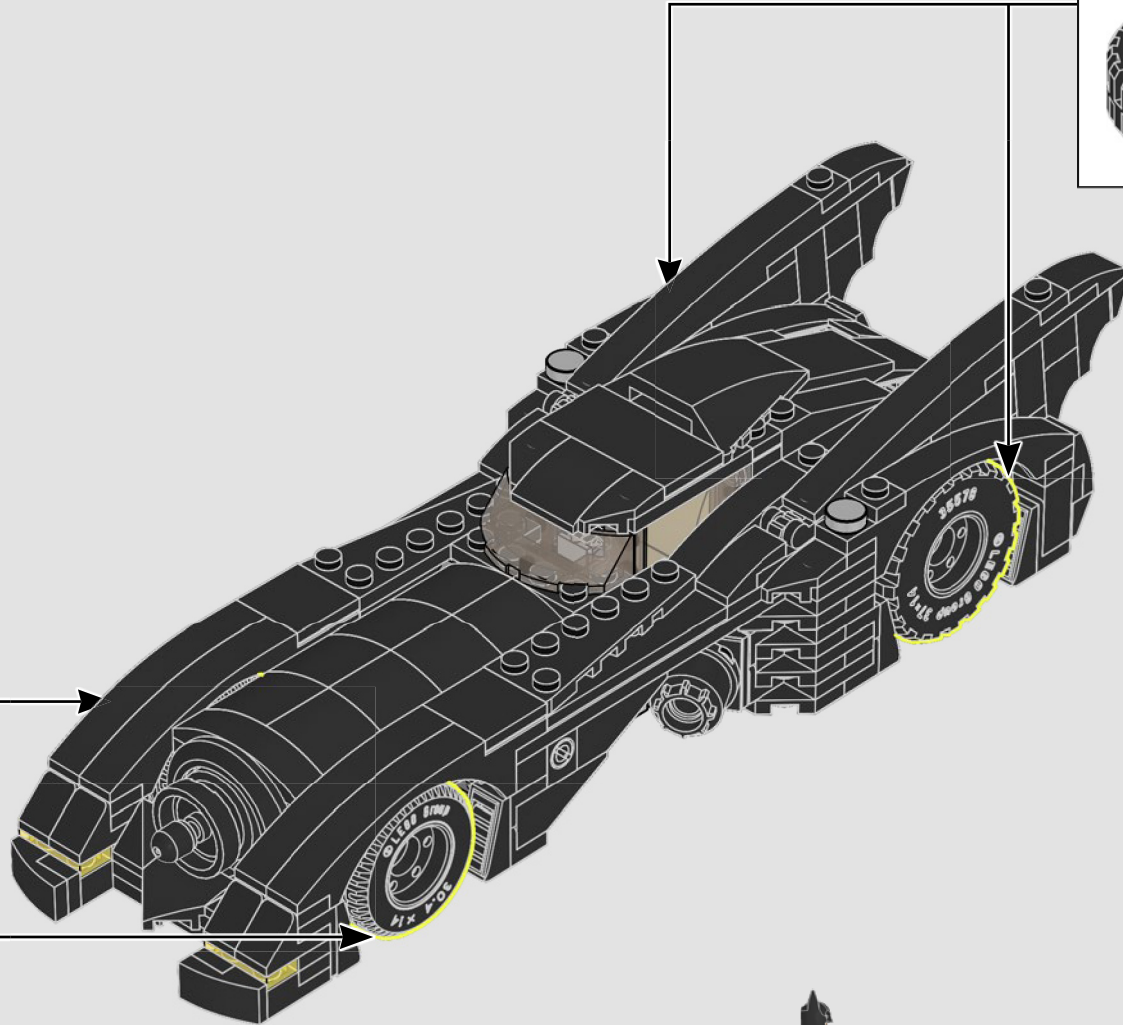
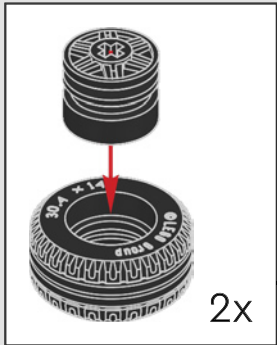
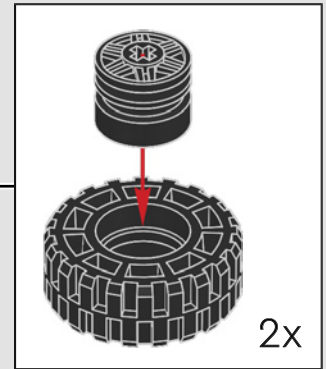



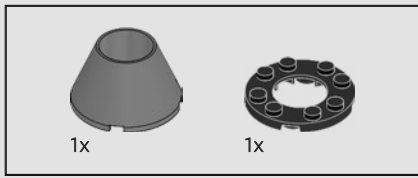

100

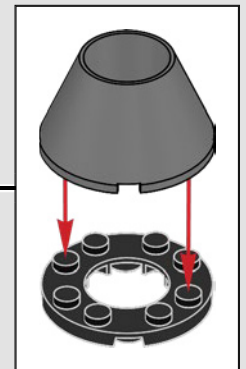
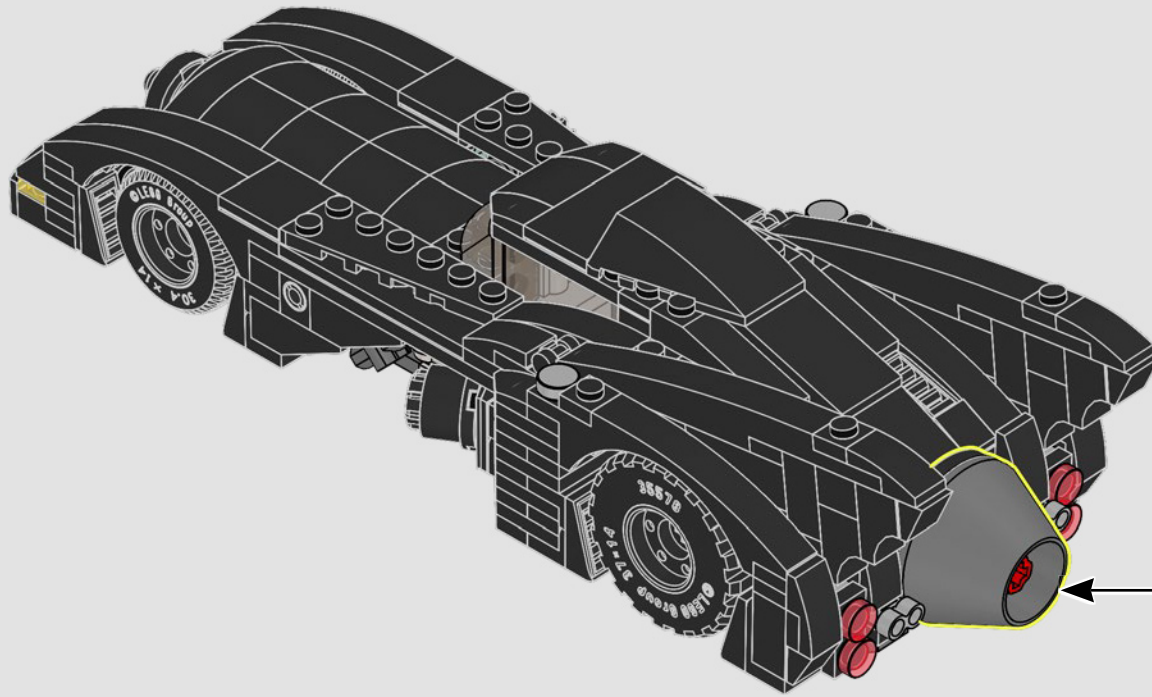



1x

101

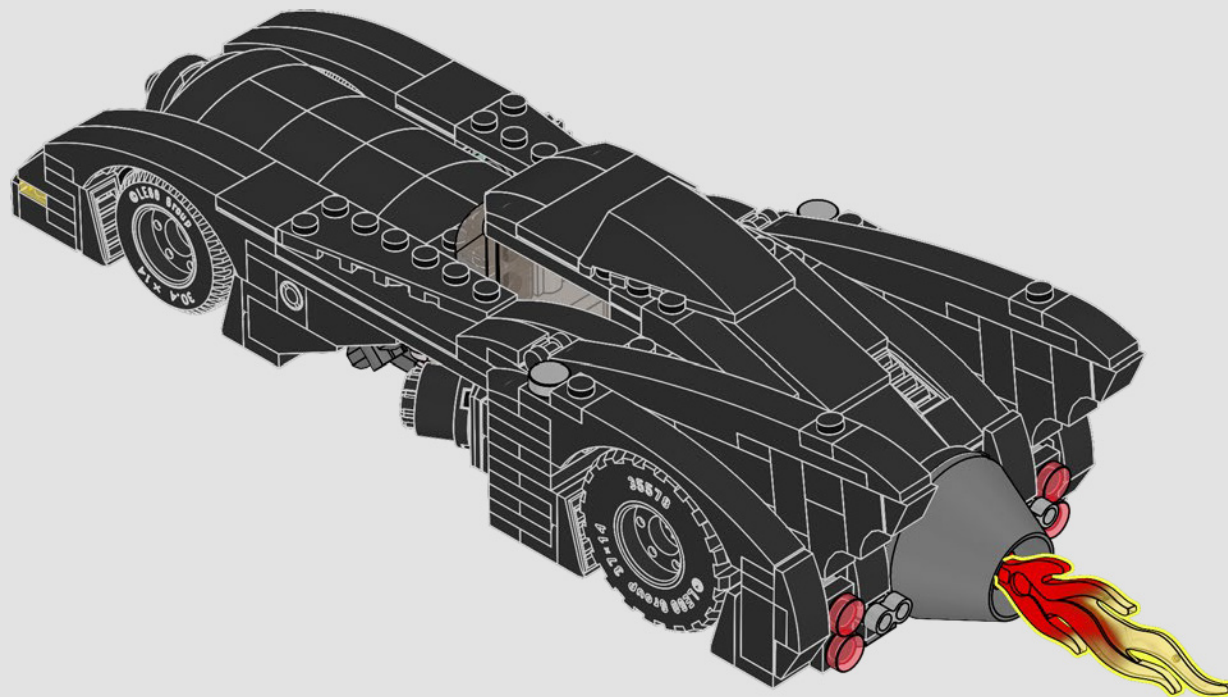

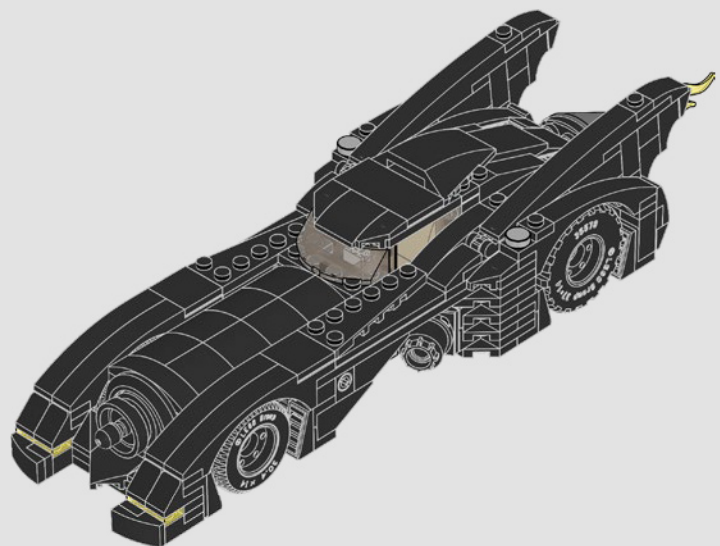

## 蝙蝠战车

没有蝙蝠战车,何谈蝙蝠洞。可以扭转副驾驶座一侧的操纵杆,显露并发射隐藏的大炮,可以打开驾驶舱,将蝙蝠侠小人仔(身披软斗篷)放入,还可以安装尾焰组件,并在驾驶汽车过程中看着它转动。

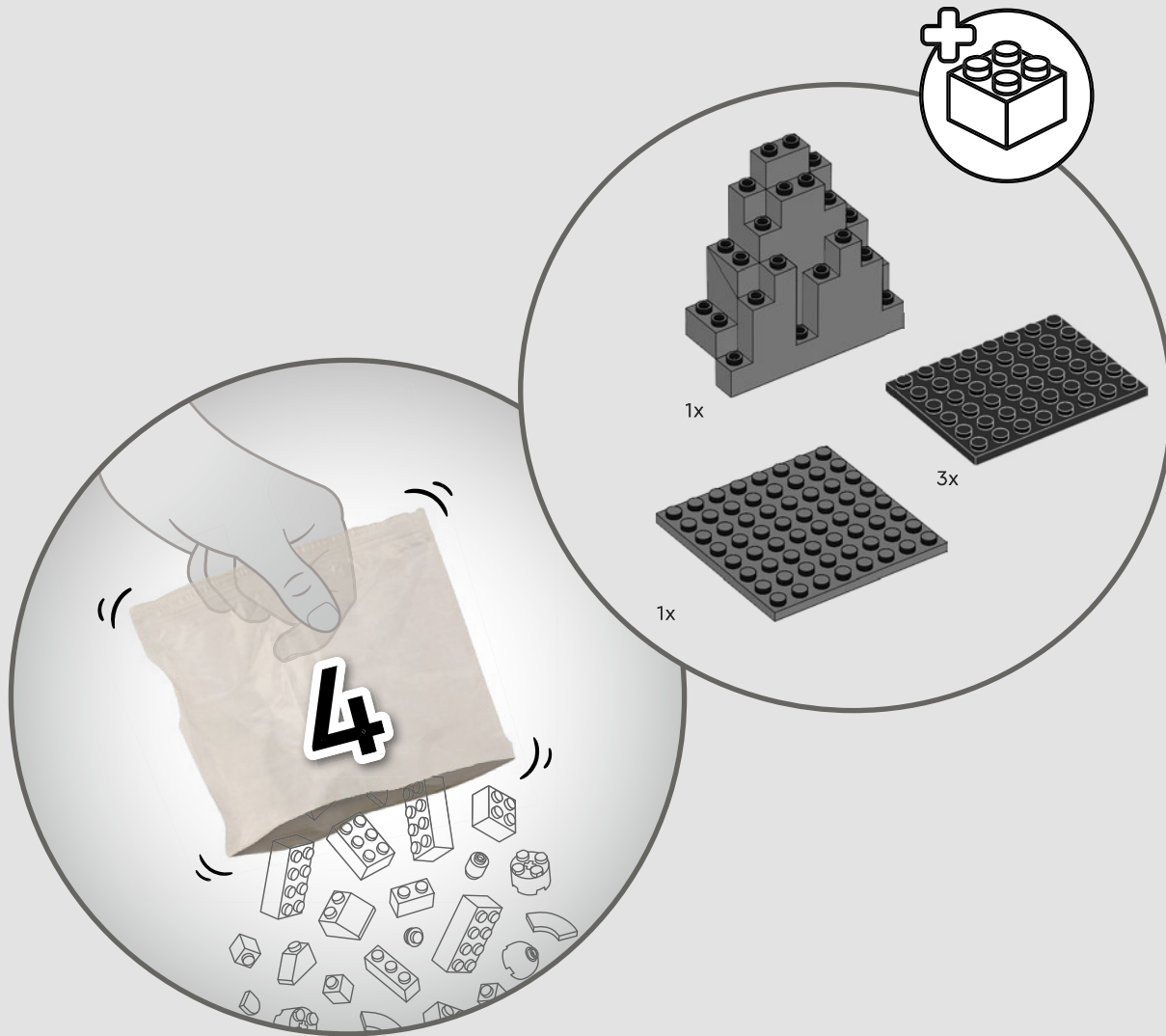

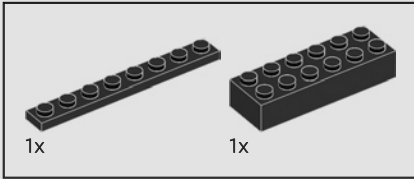
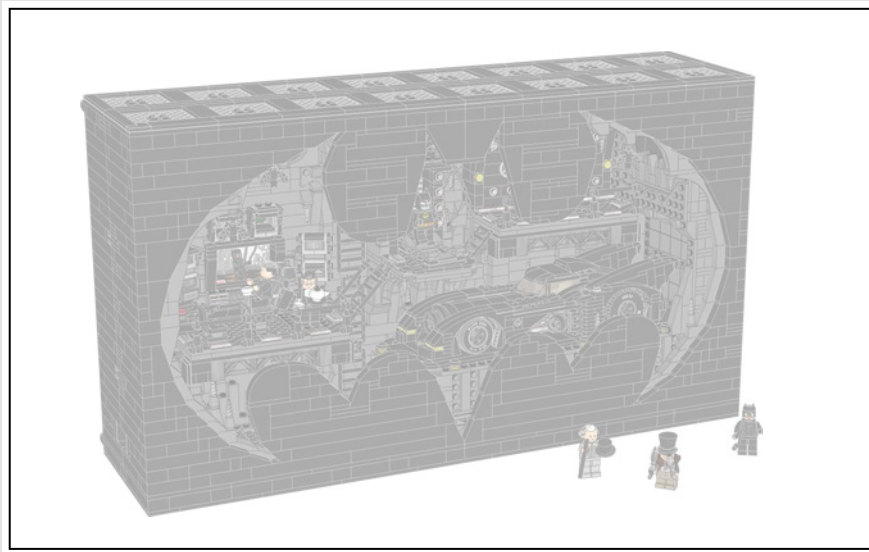

102

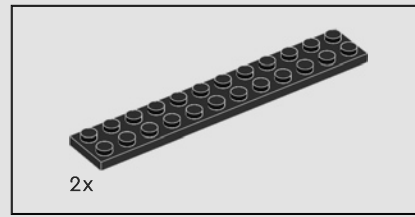
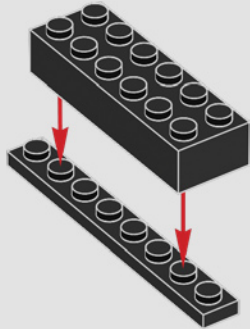

103

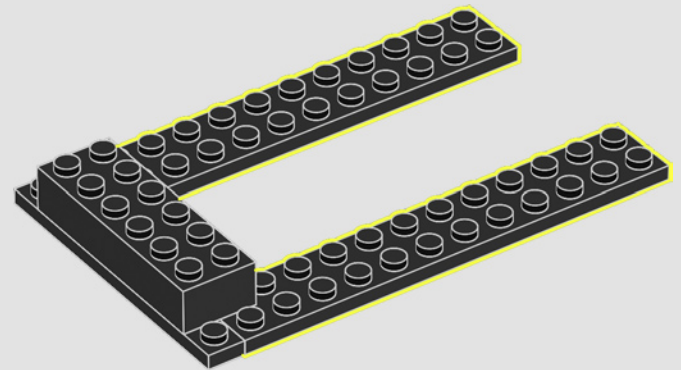



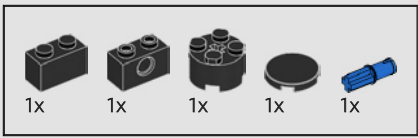

104

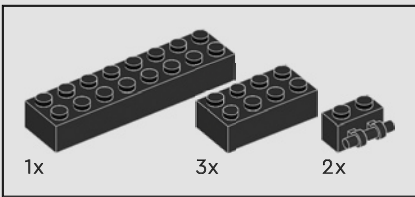
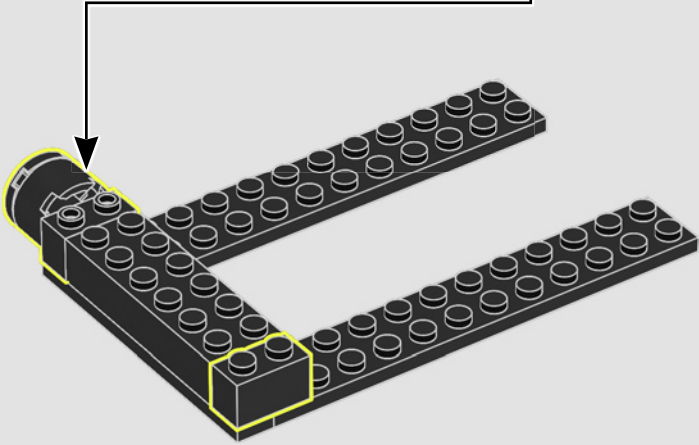
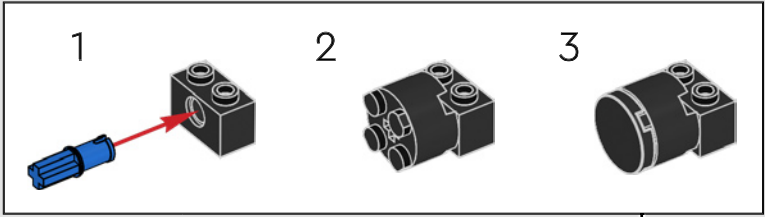

105

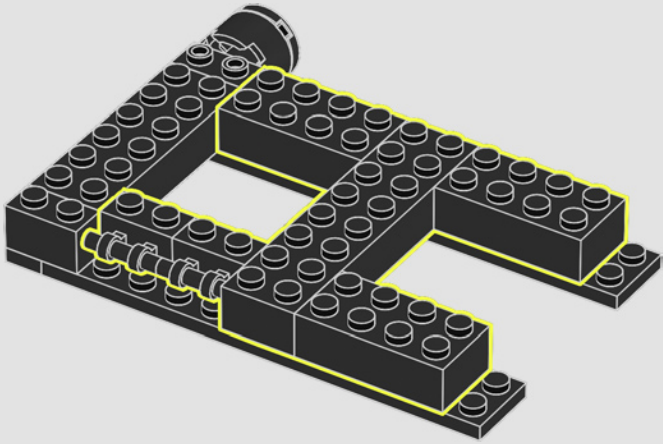

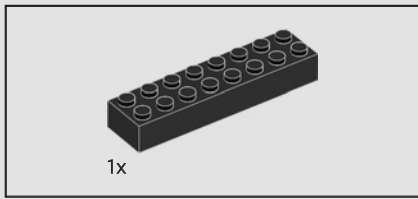

106

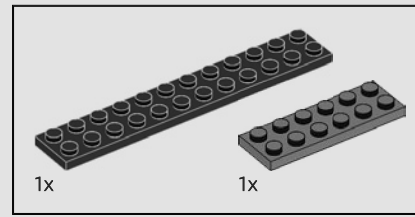
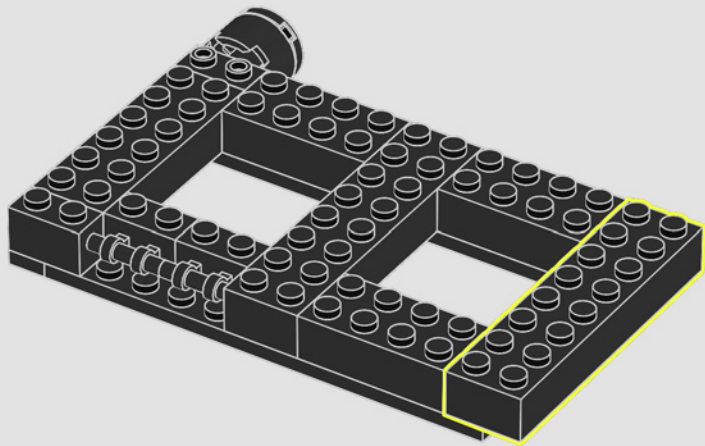

107

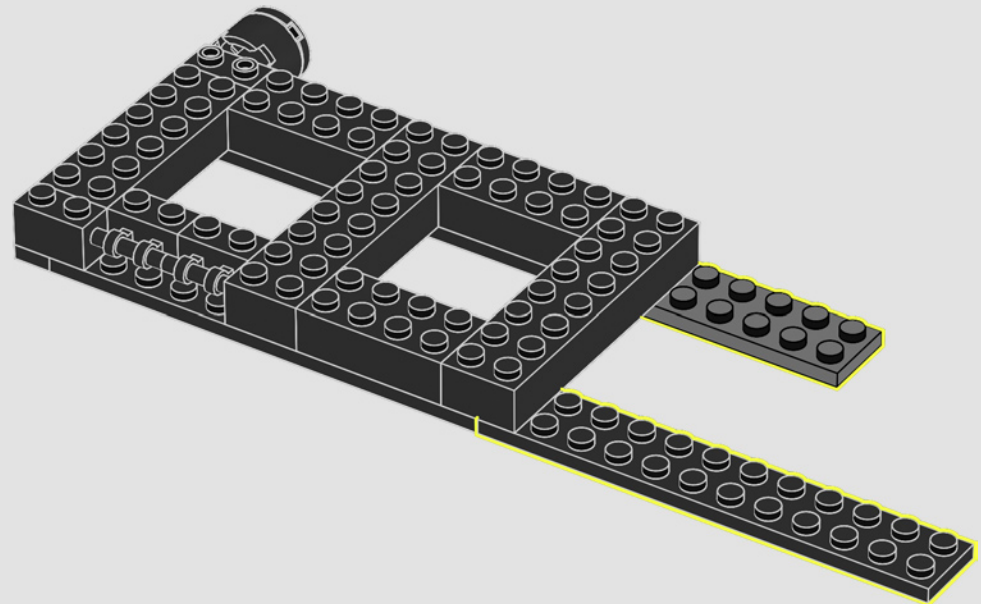

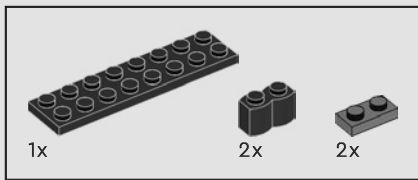

108

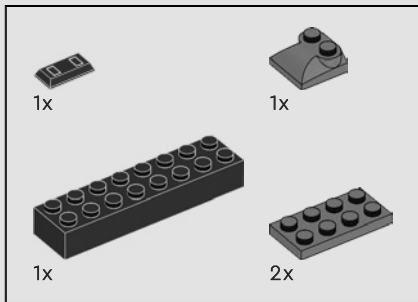
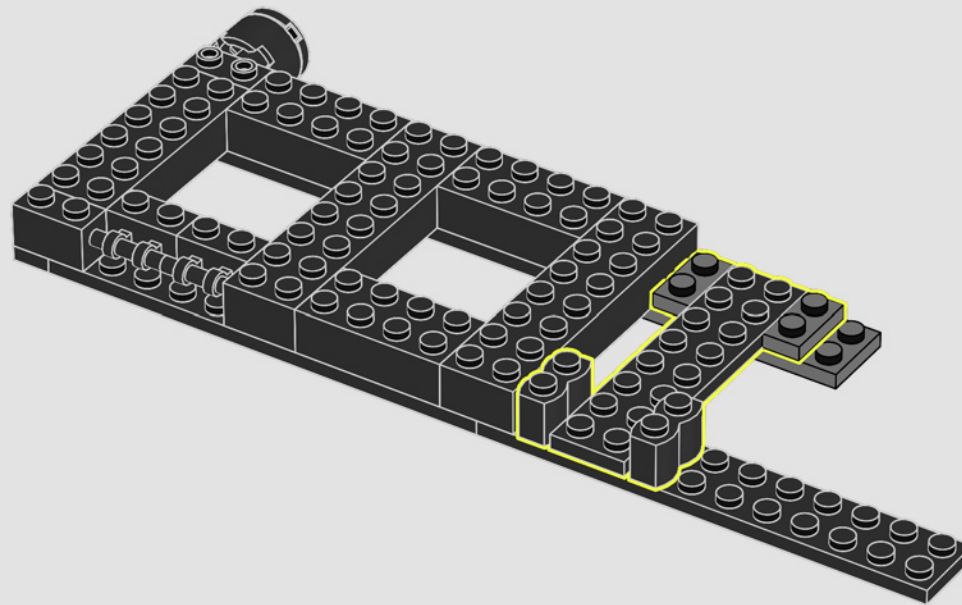

109

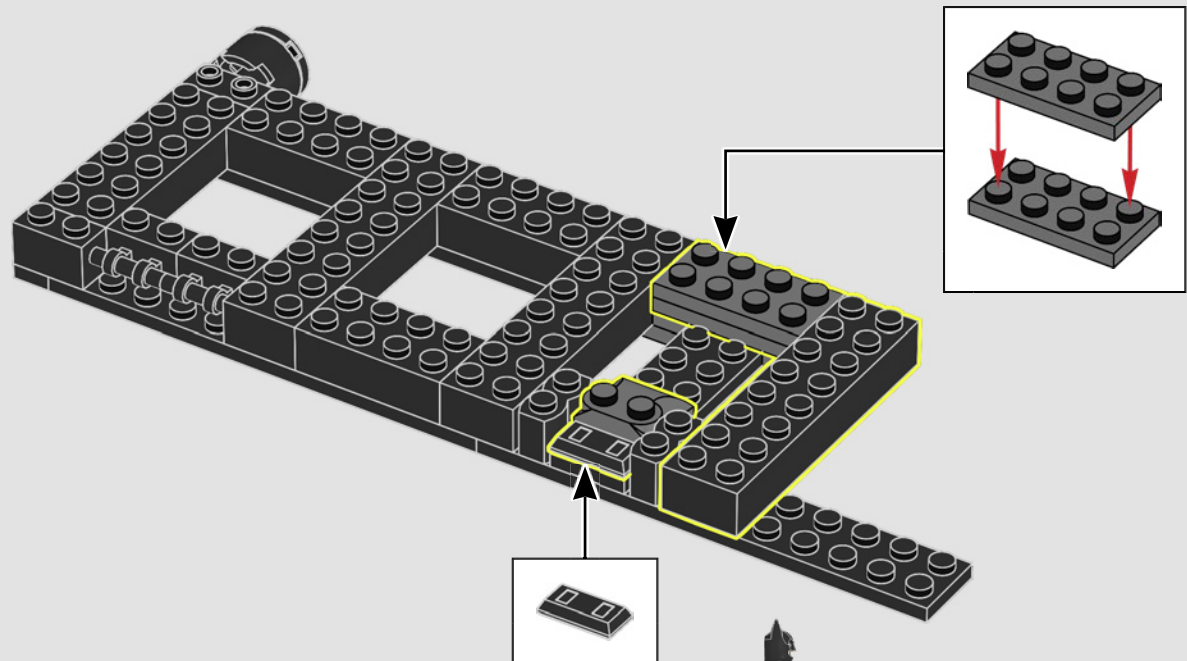

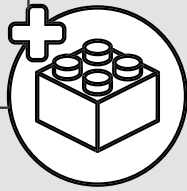
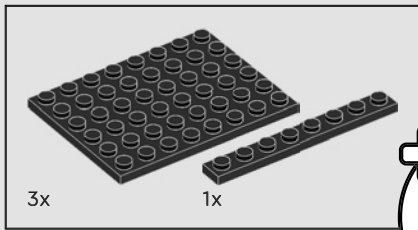

110

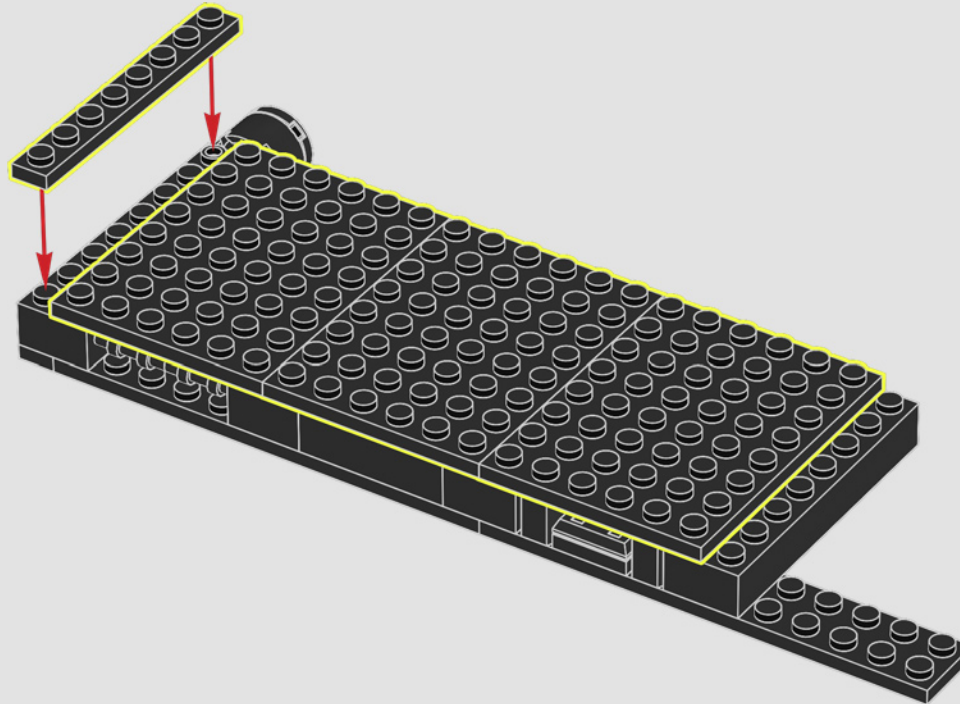

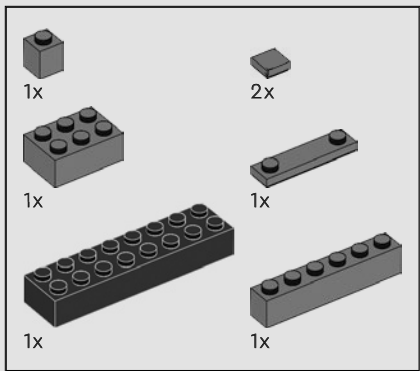

111

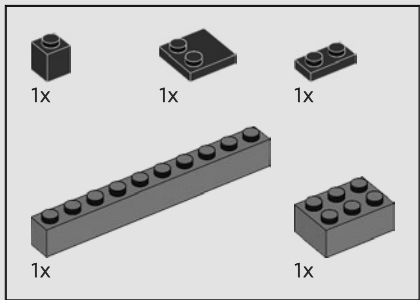
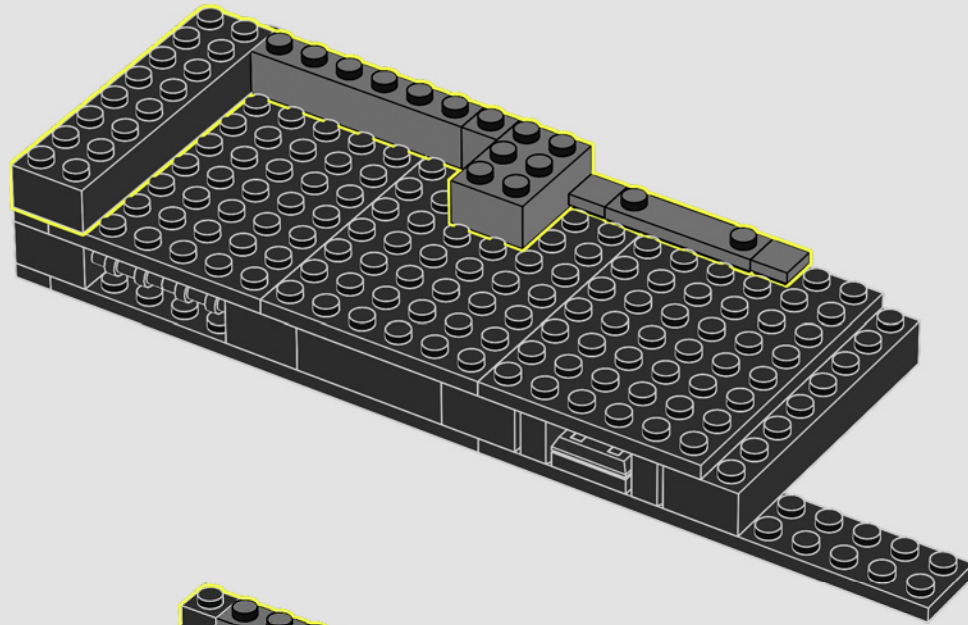

112

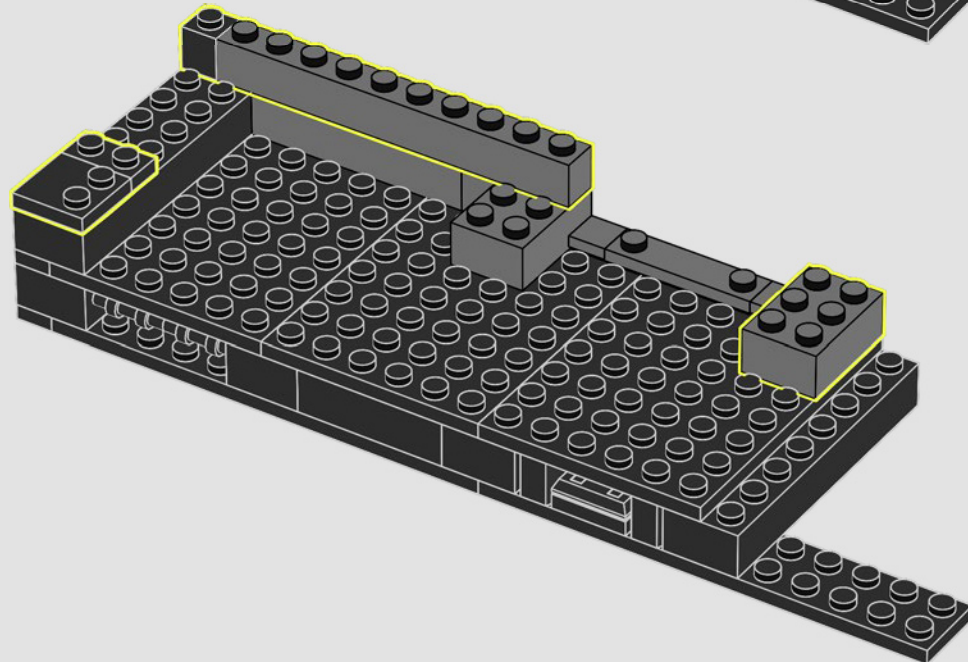



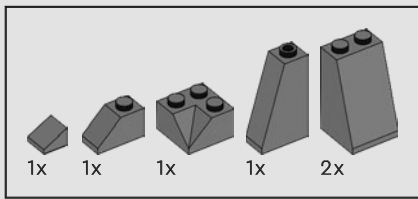

113

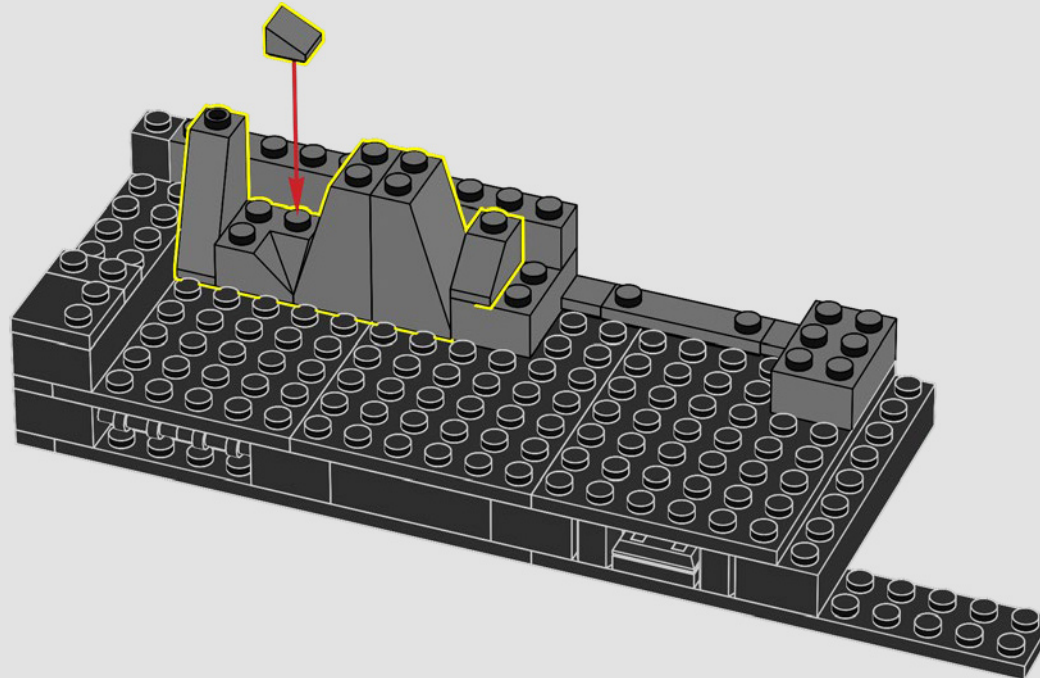

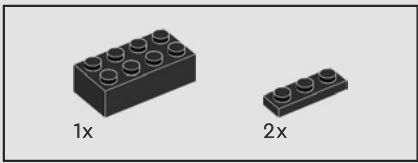

114

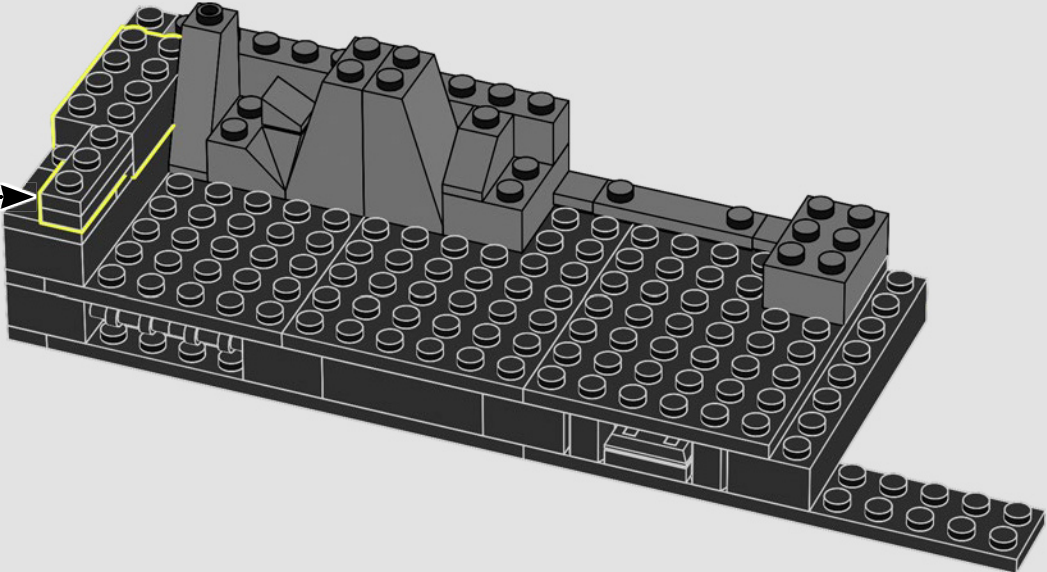
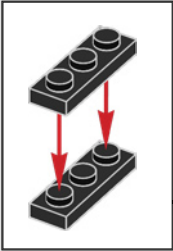

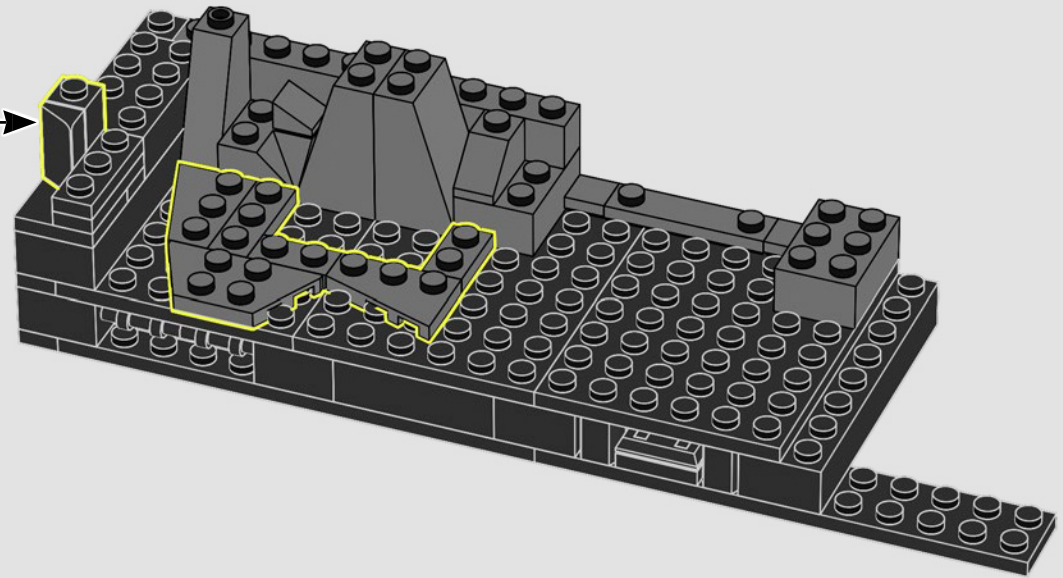
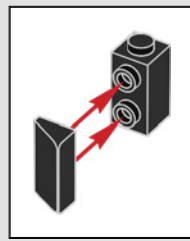
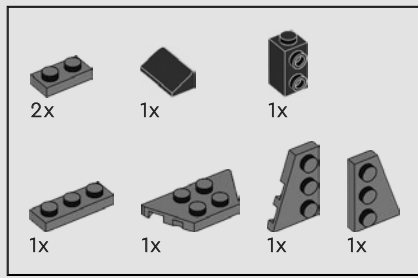

115

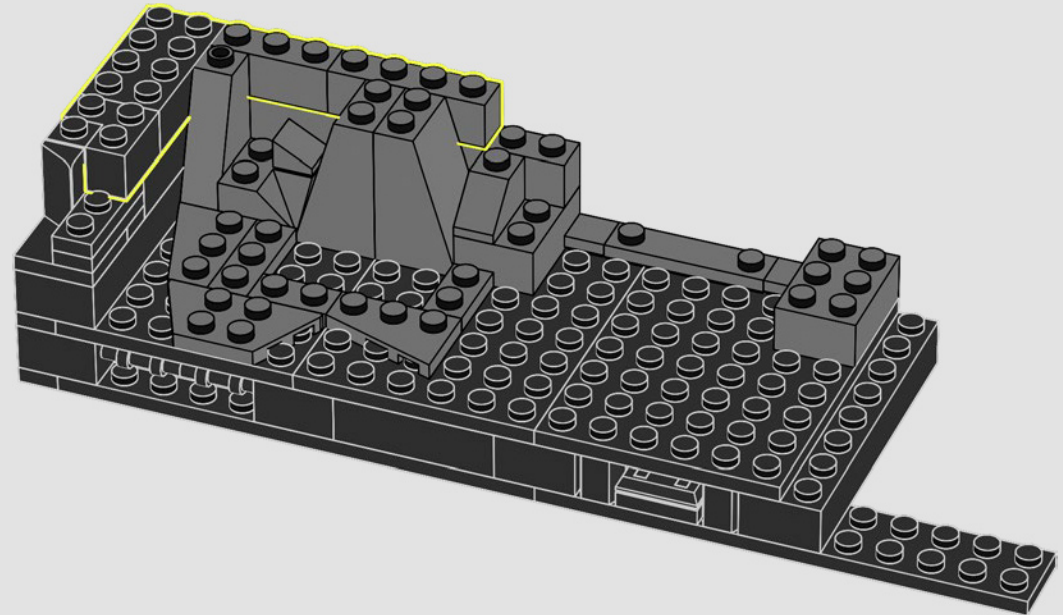
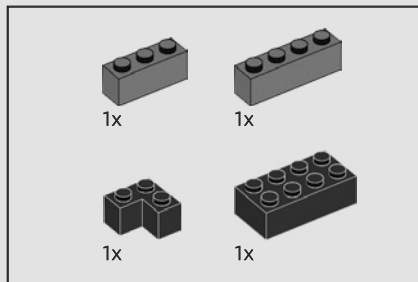

116

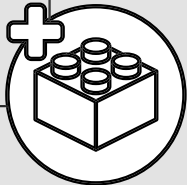
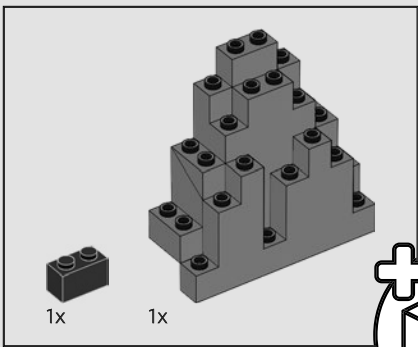

117

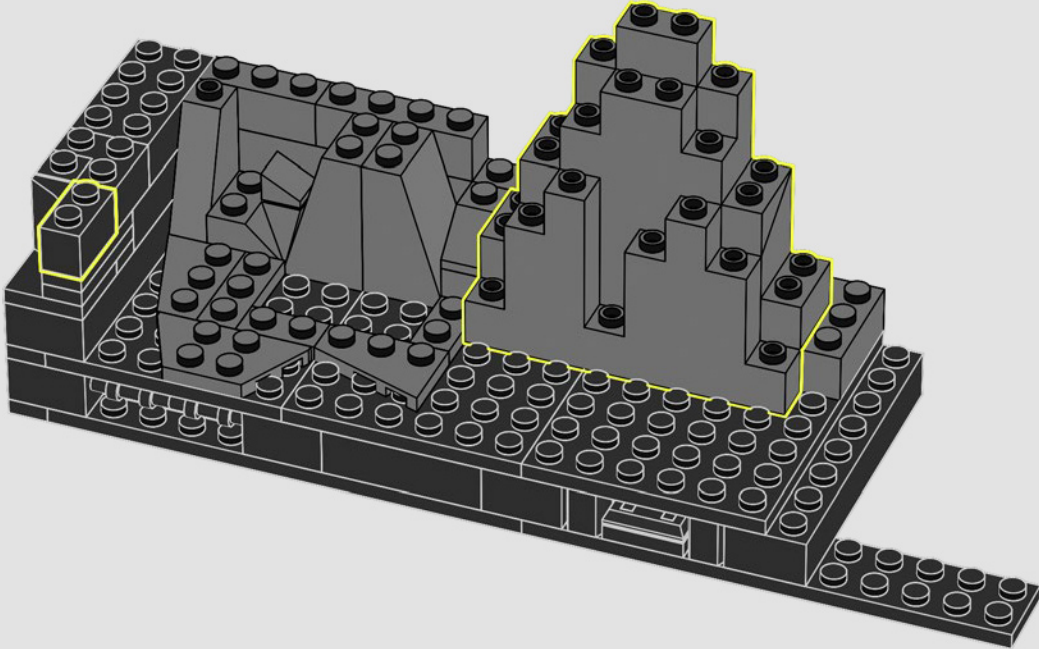

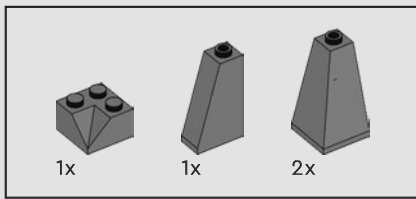

118

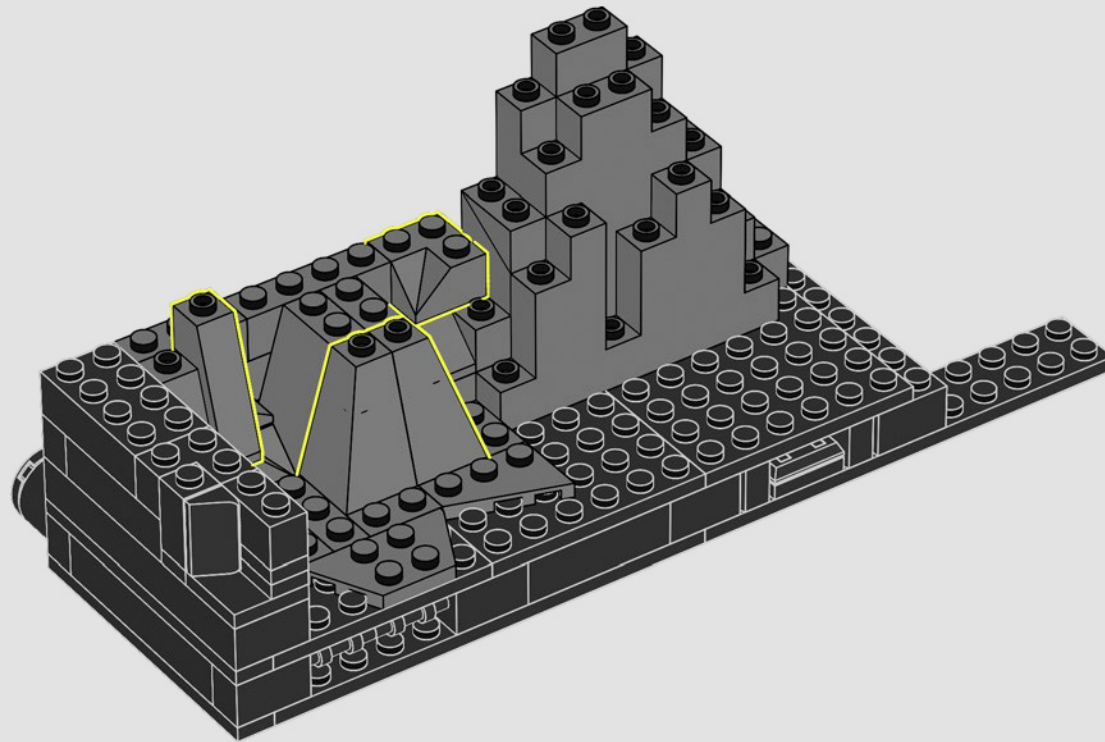



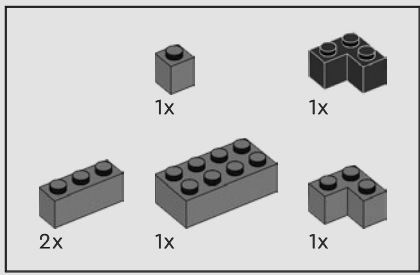

119

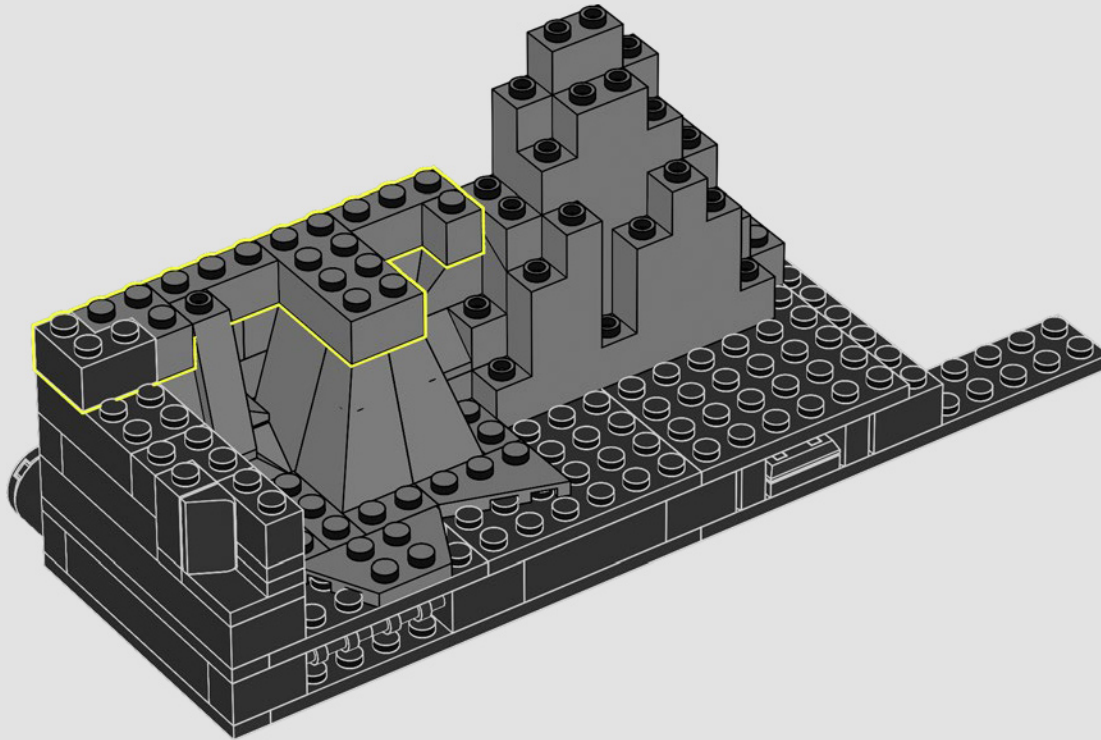

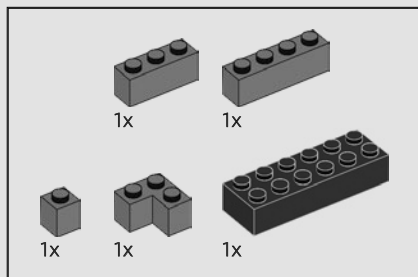

120

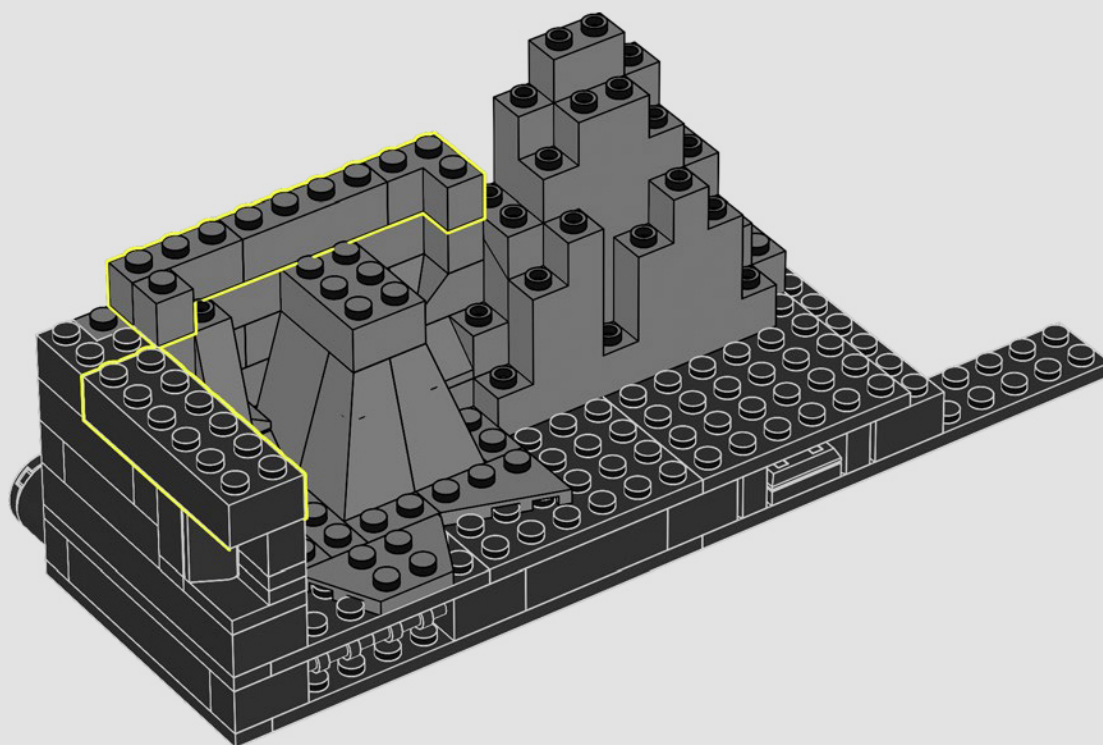

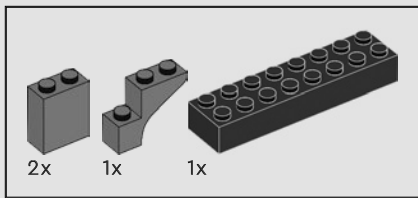

121

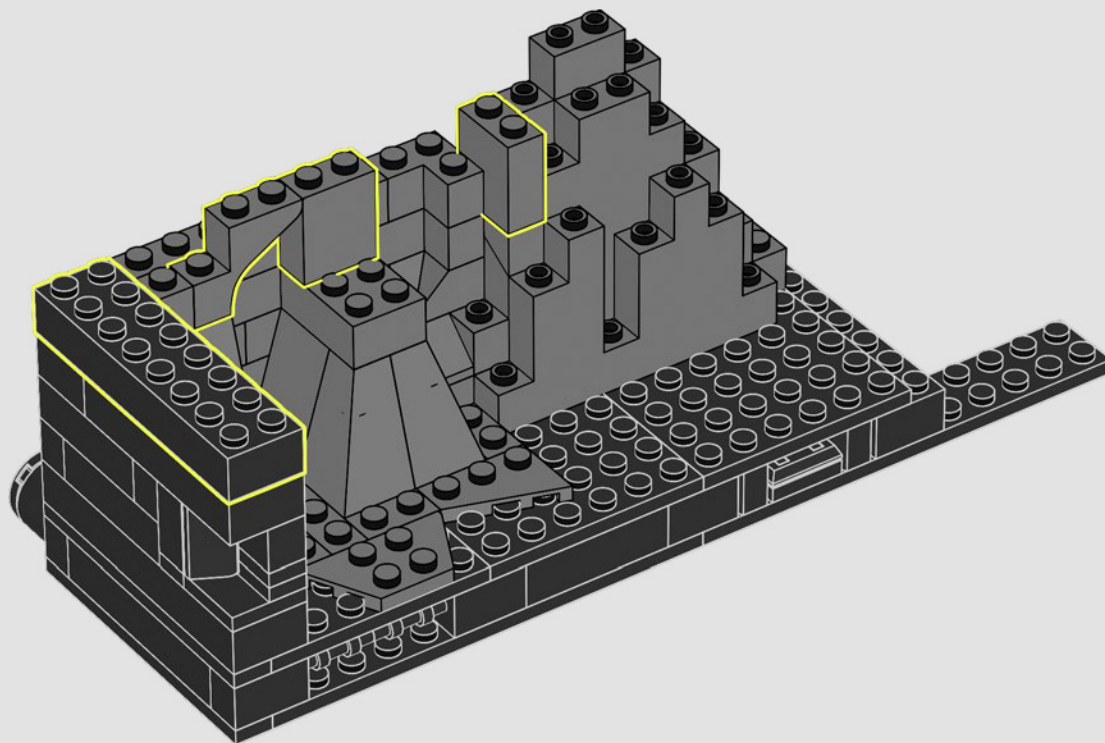

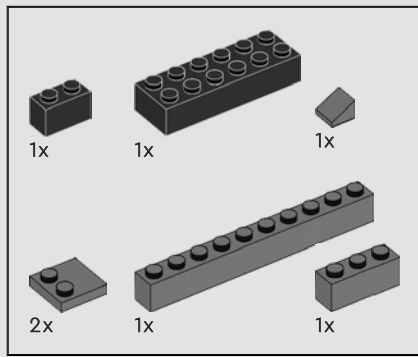

122

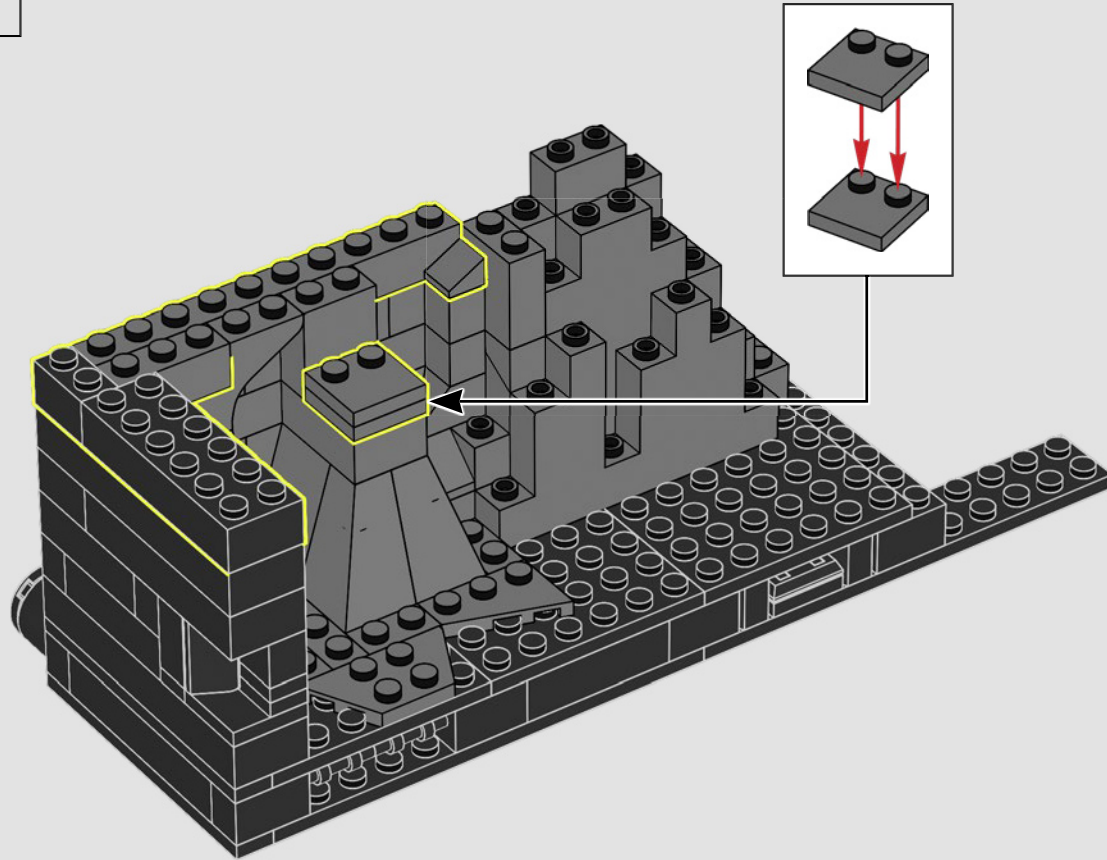

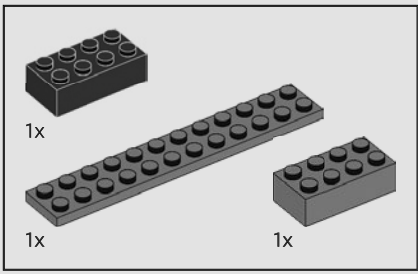

123

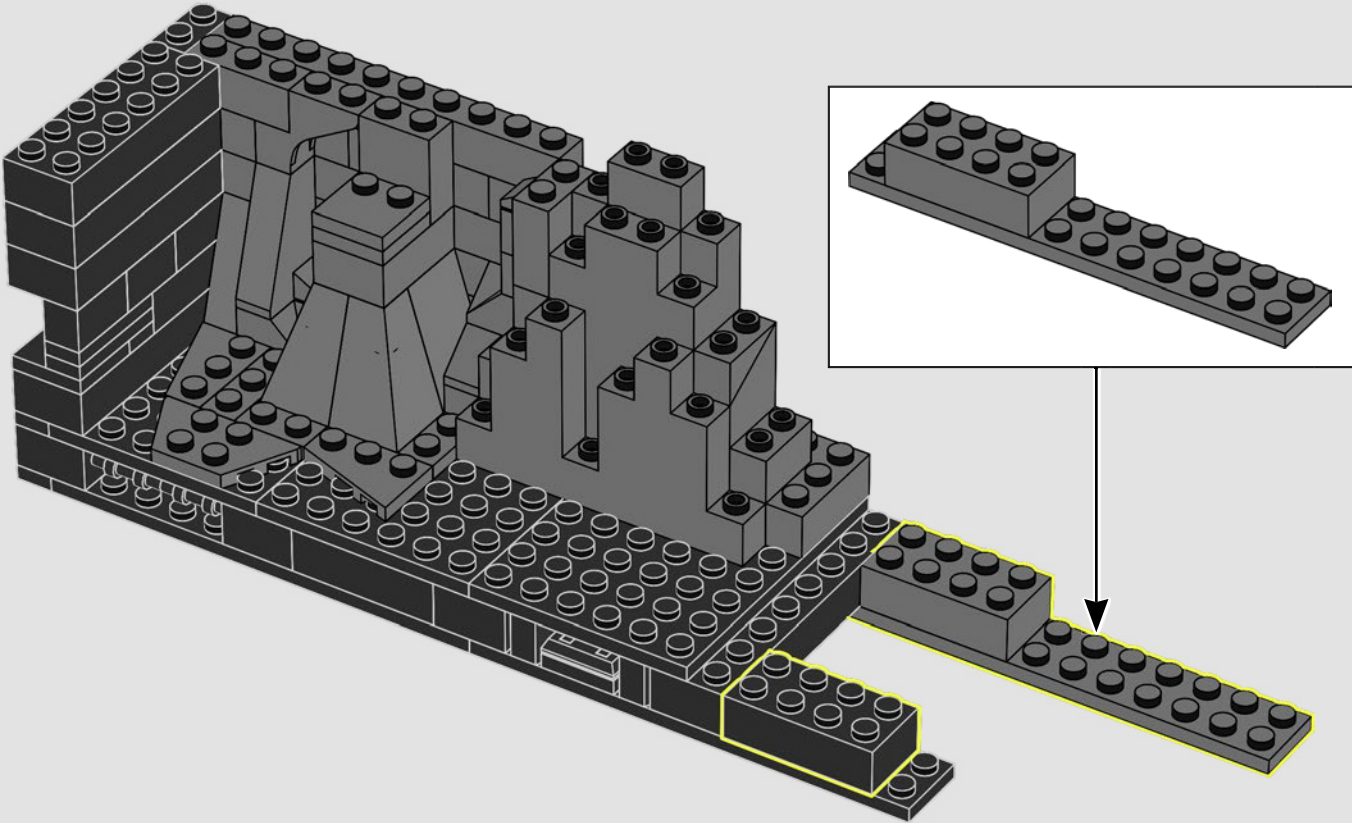



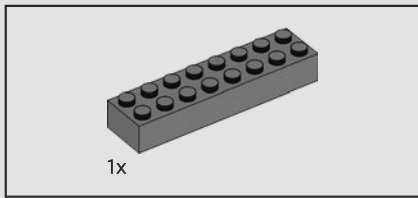

124

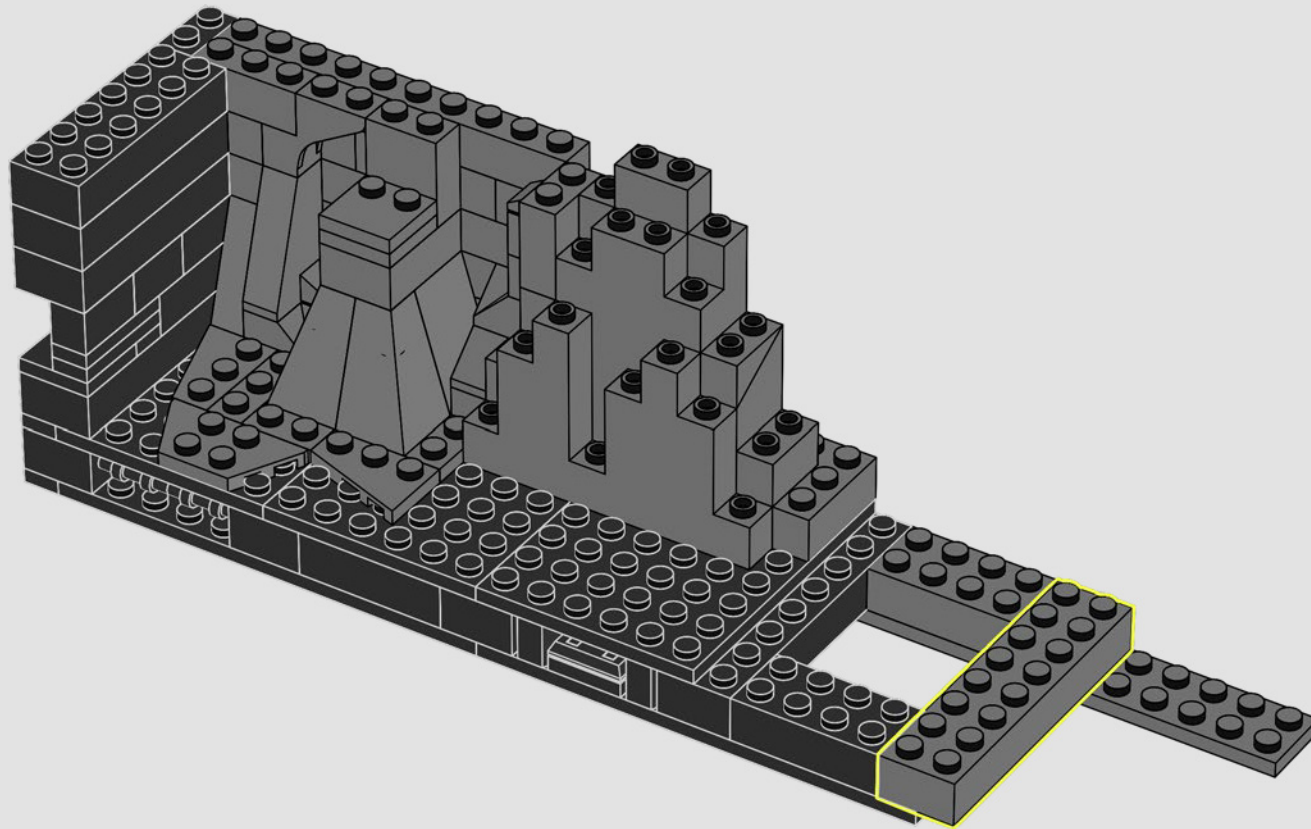

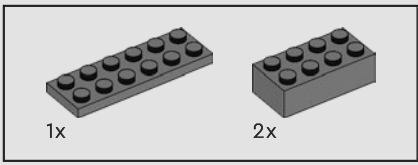

125

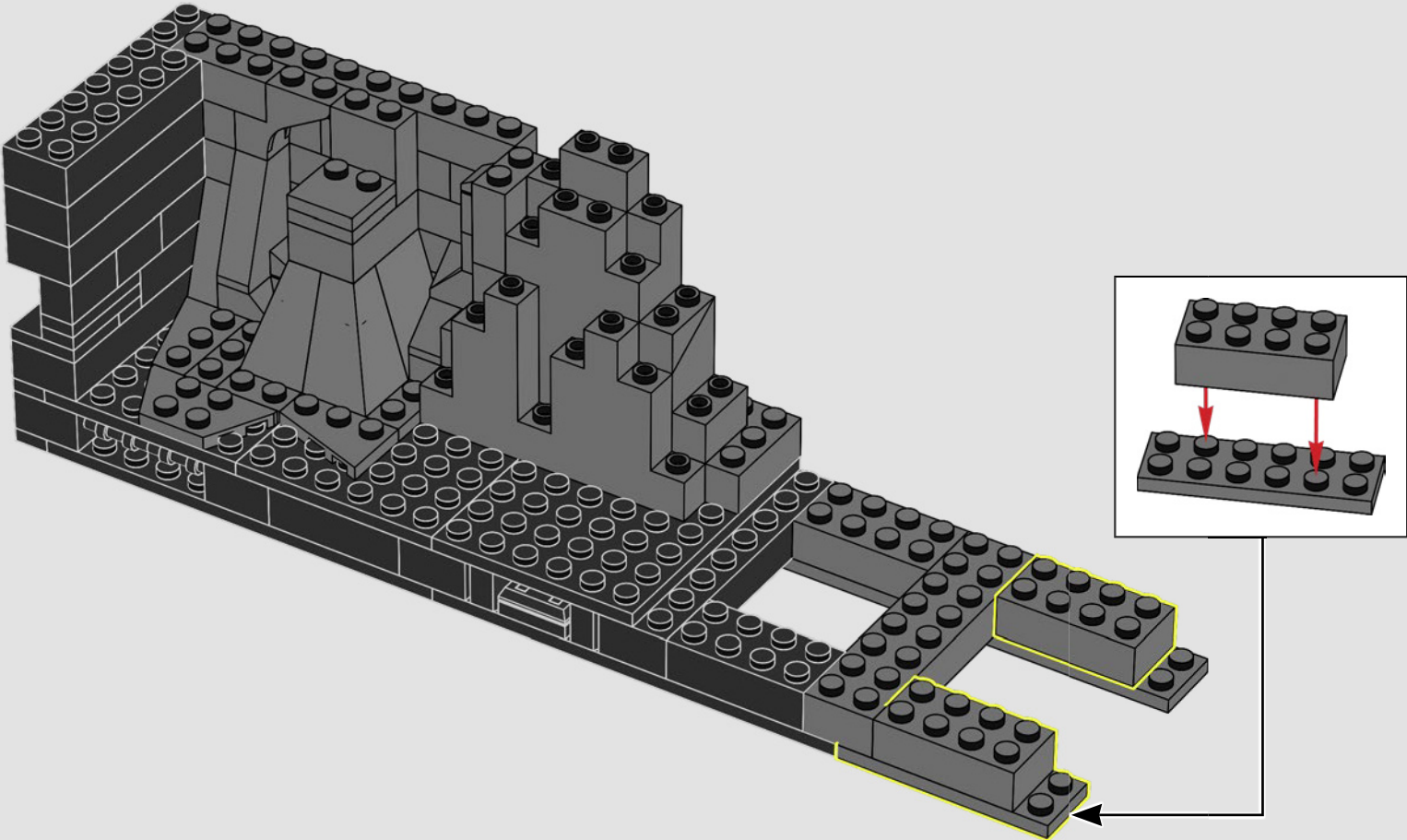

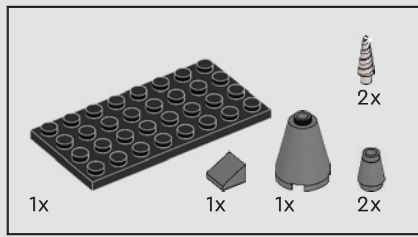

126

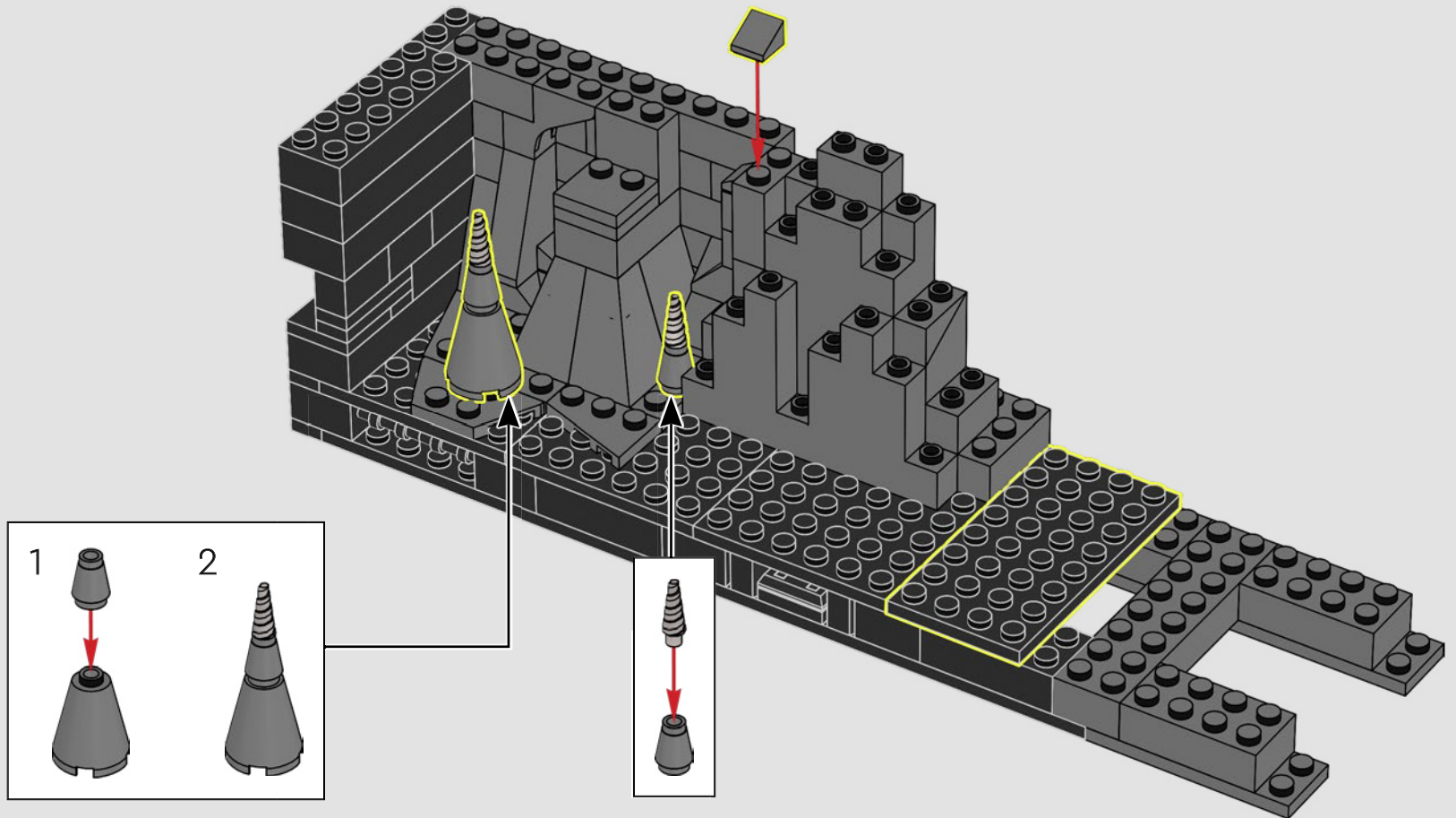

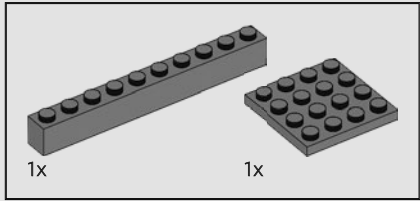
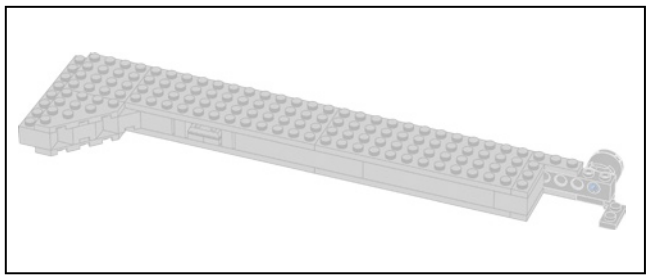

127

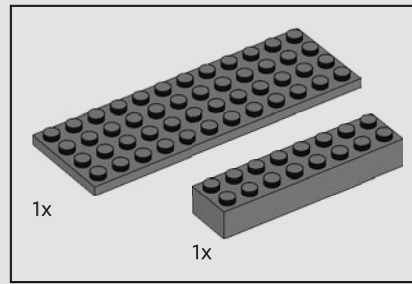
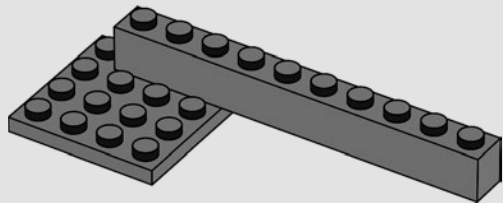

128

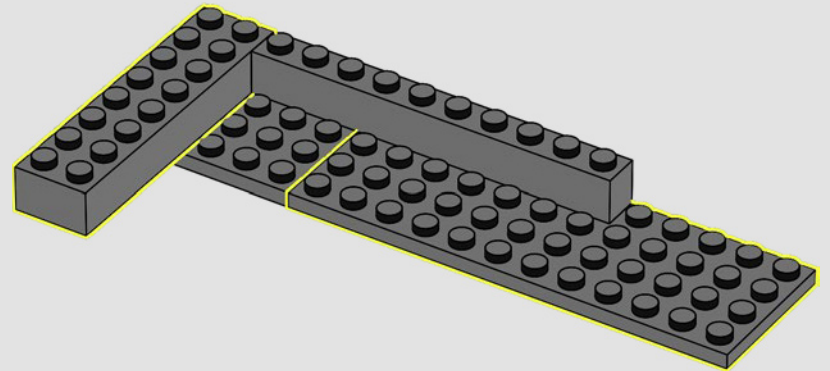

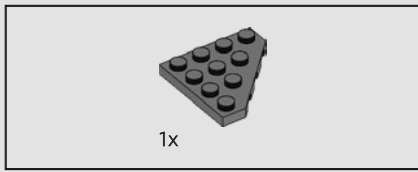

129

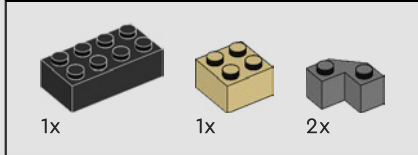
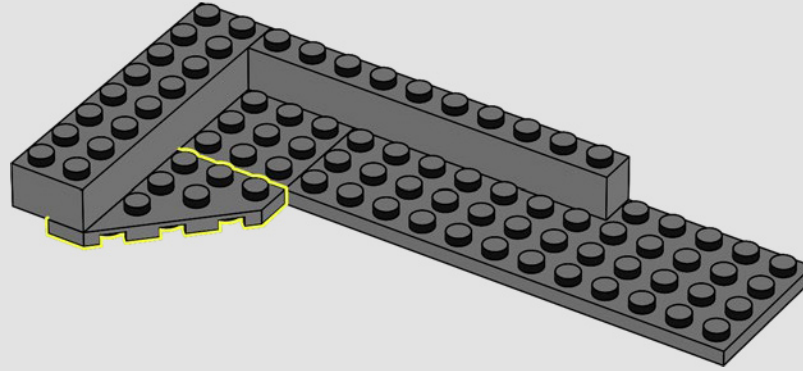

130

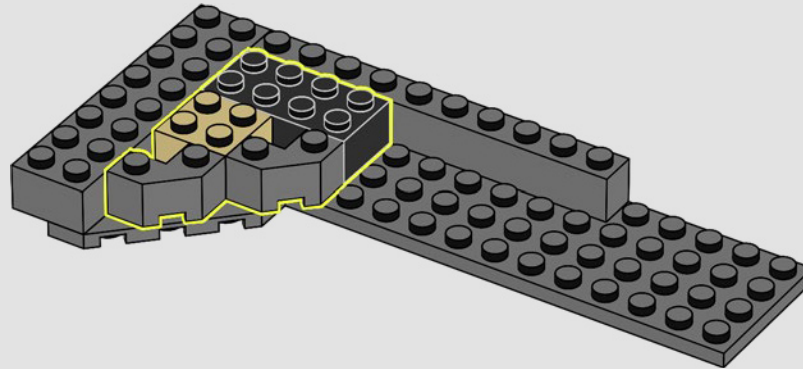



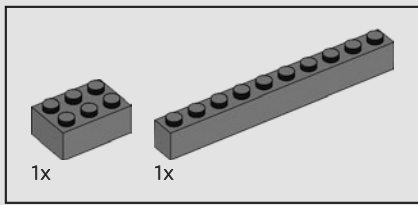

131

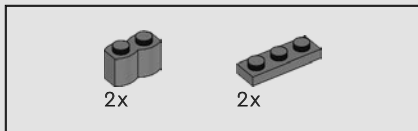
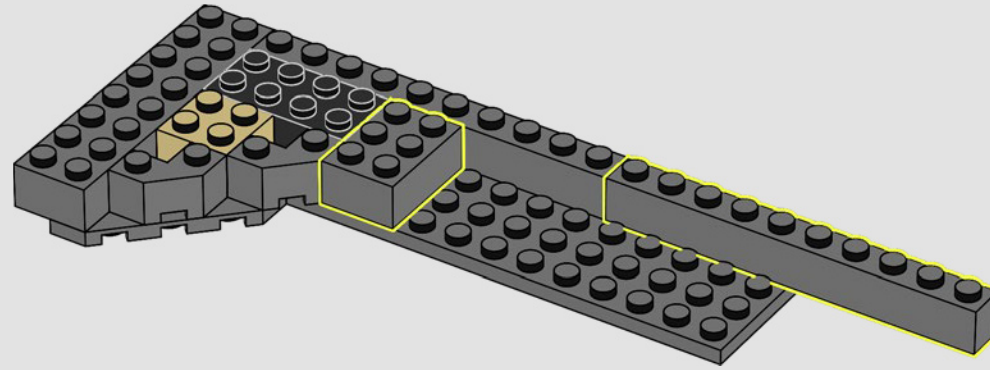

132

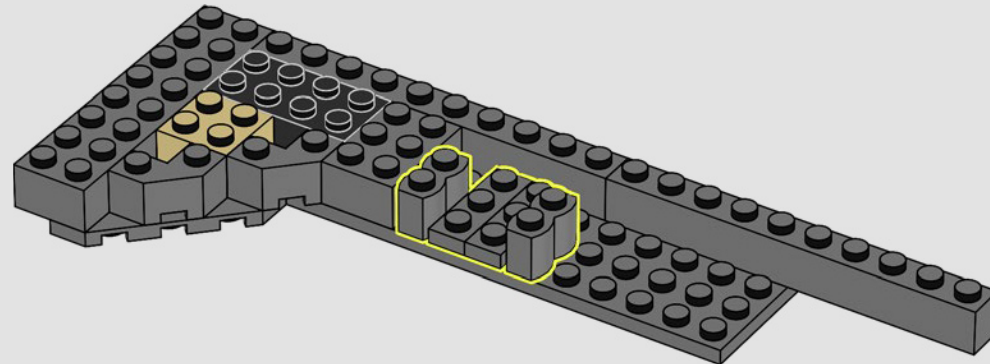

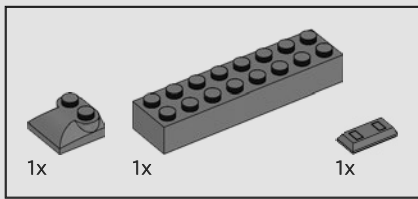

133

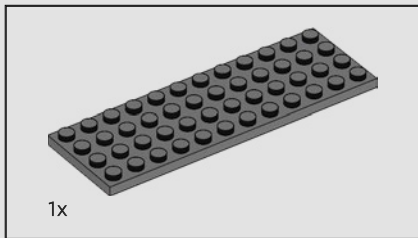
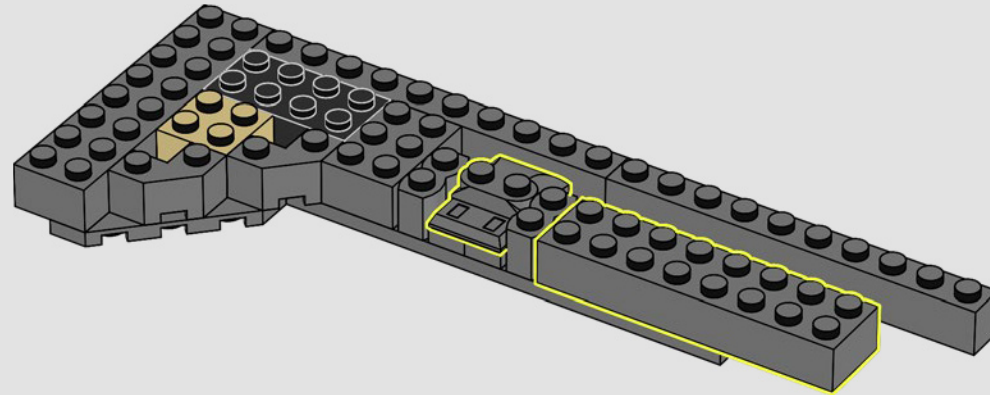

134

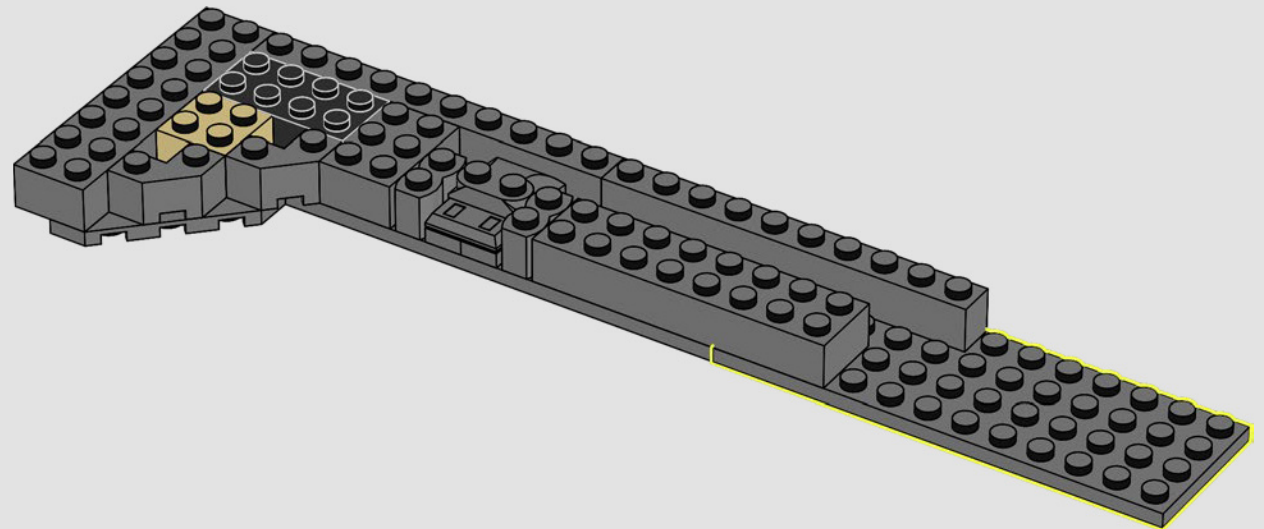

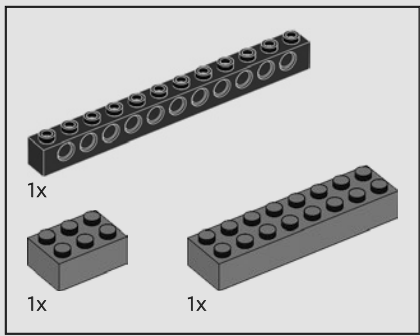

135

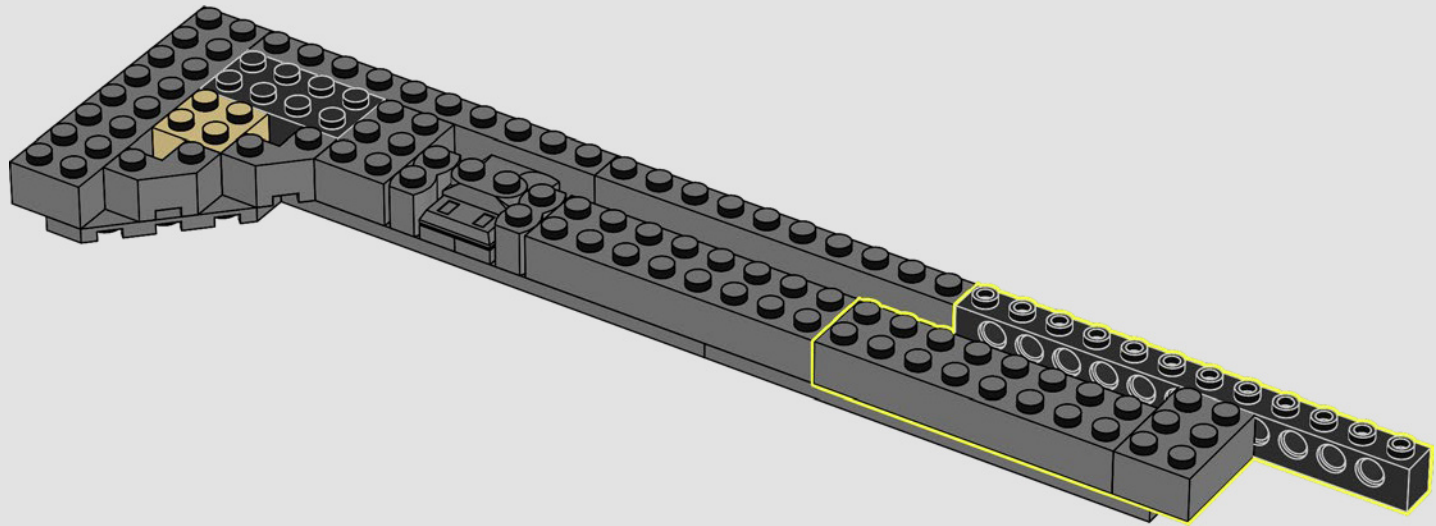

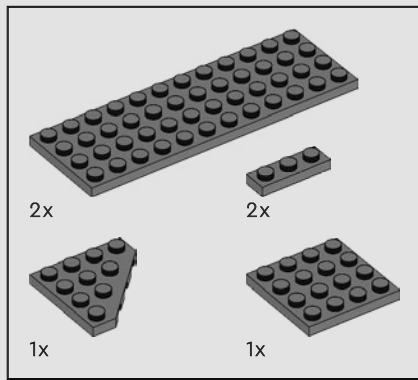

136

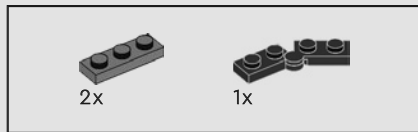
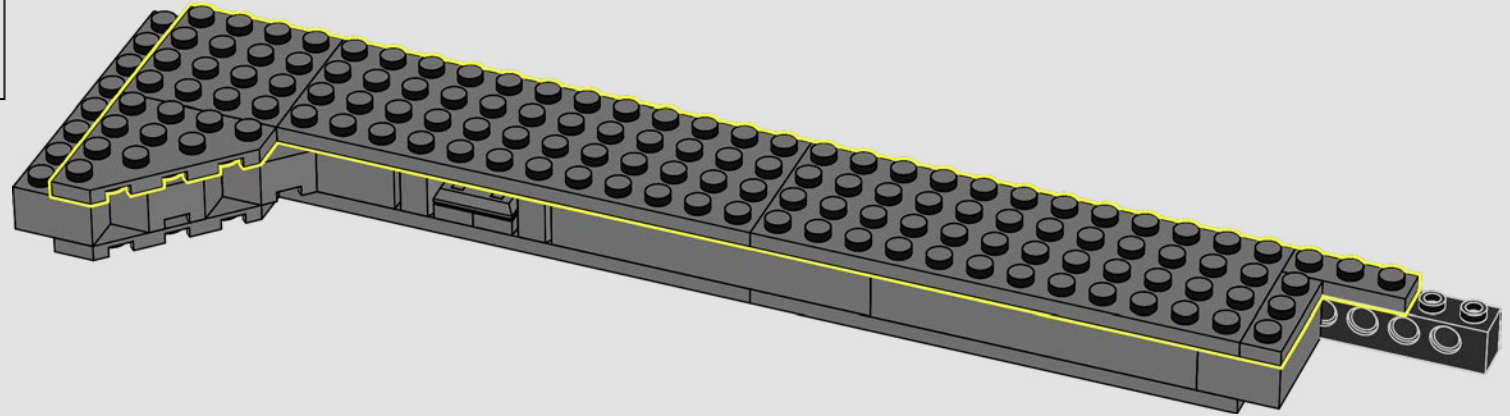

137

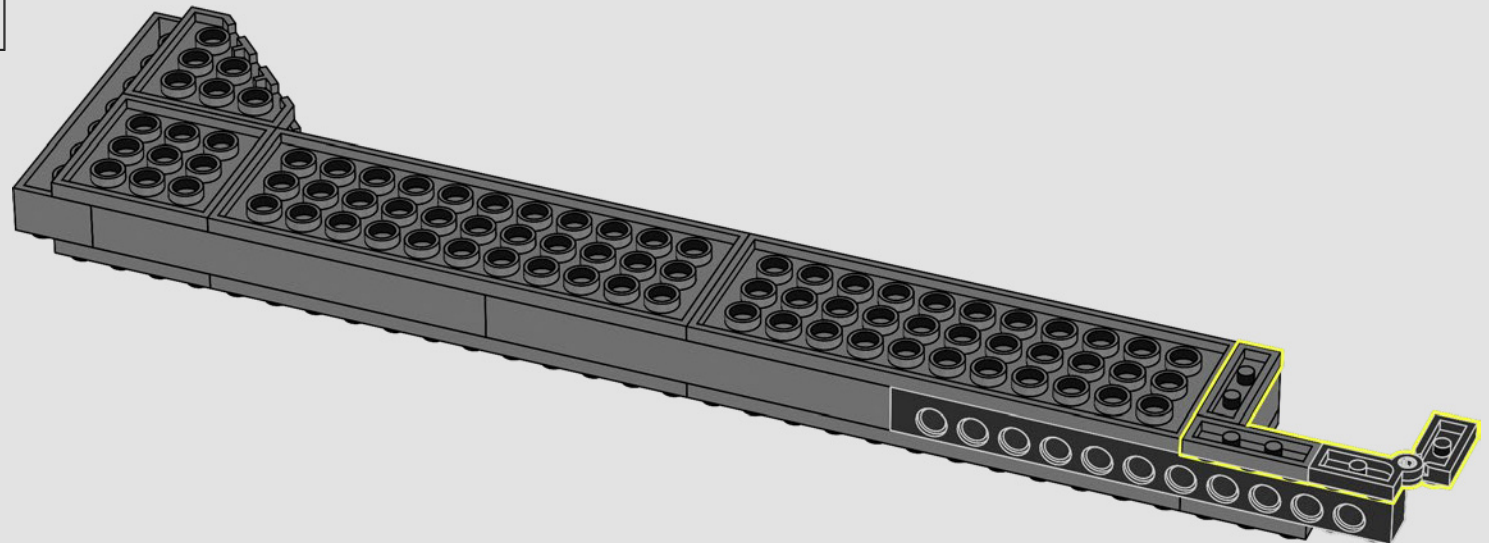

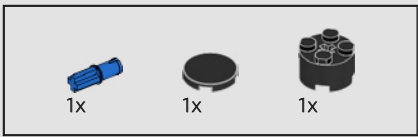

138

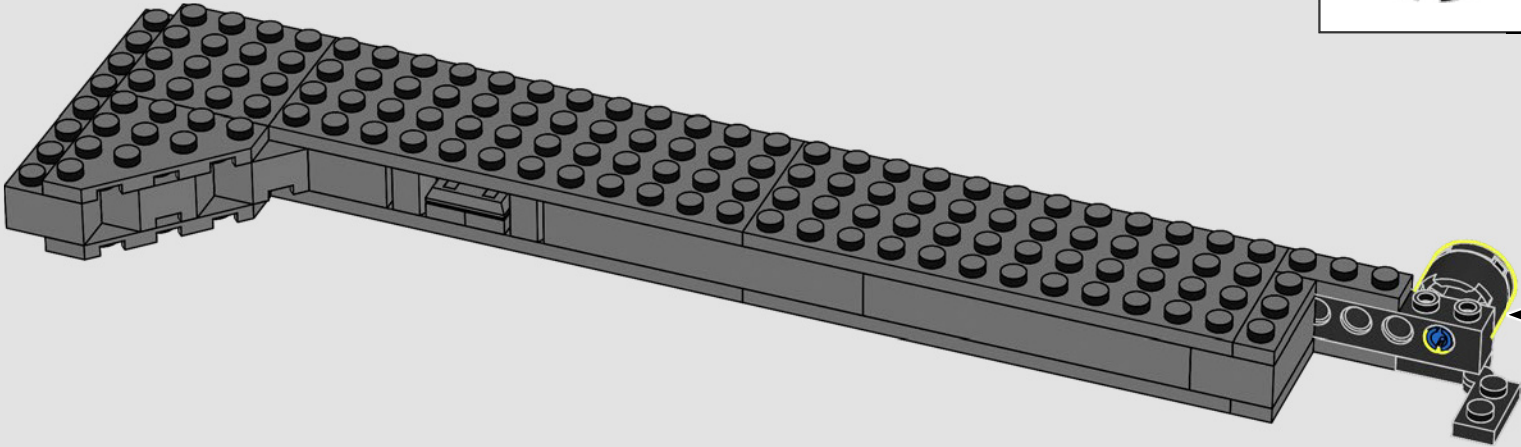
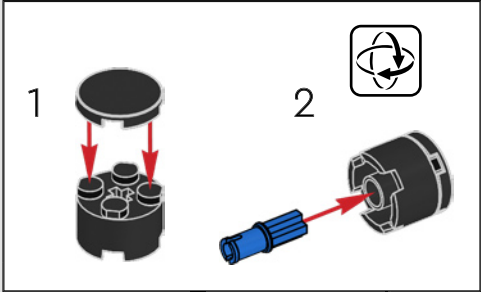



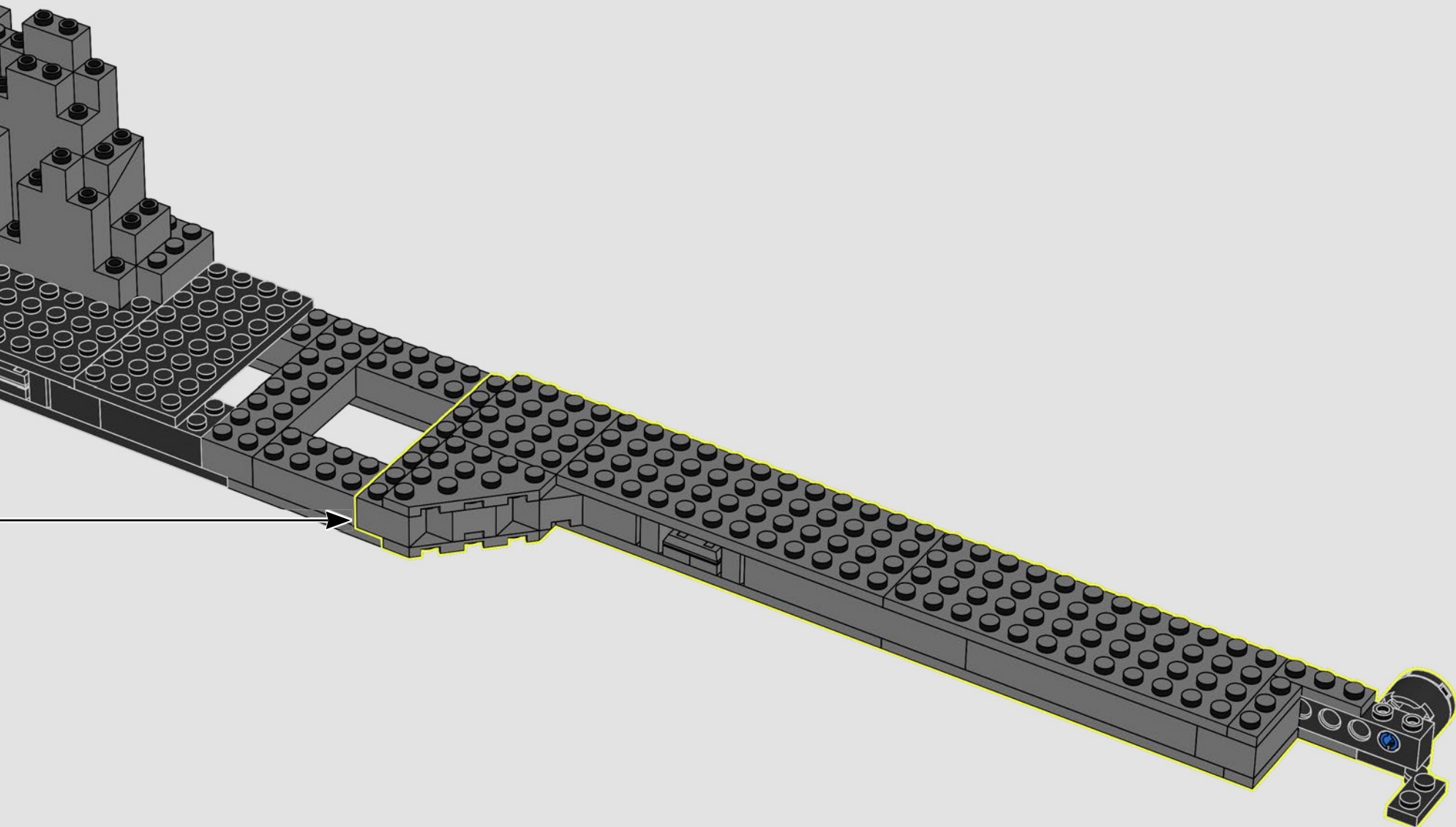

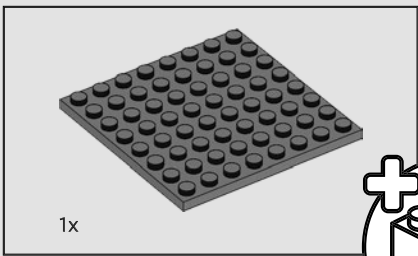

1x

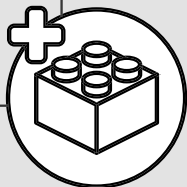

140

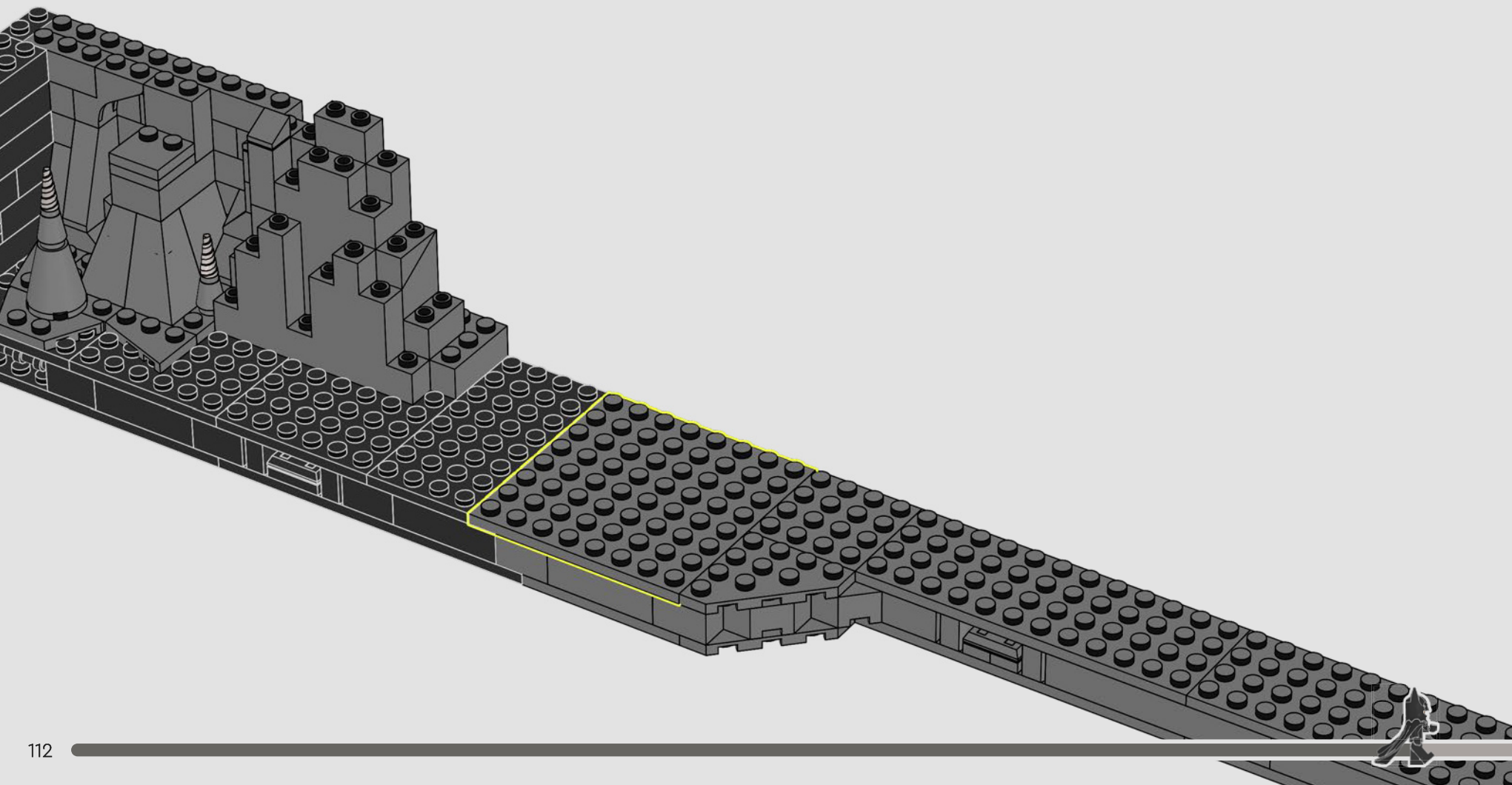



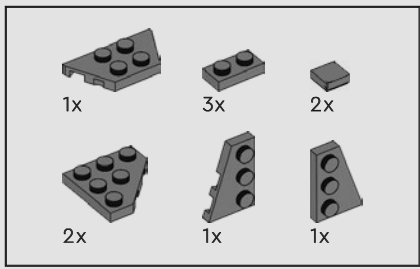

141

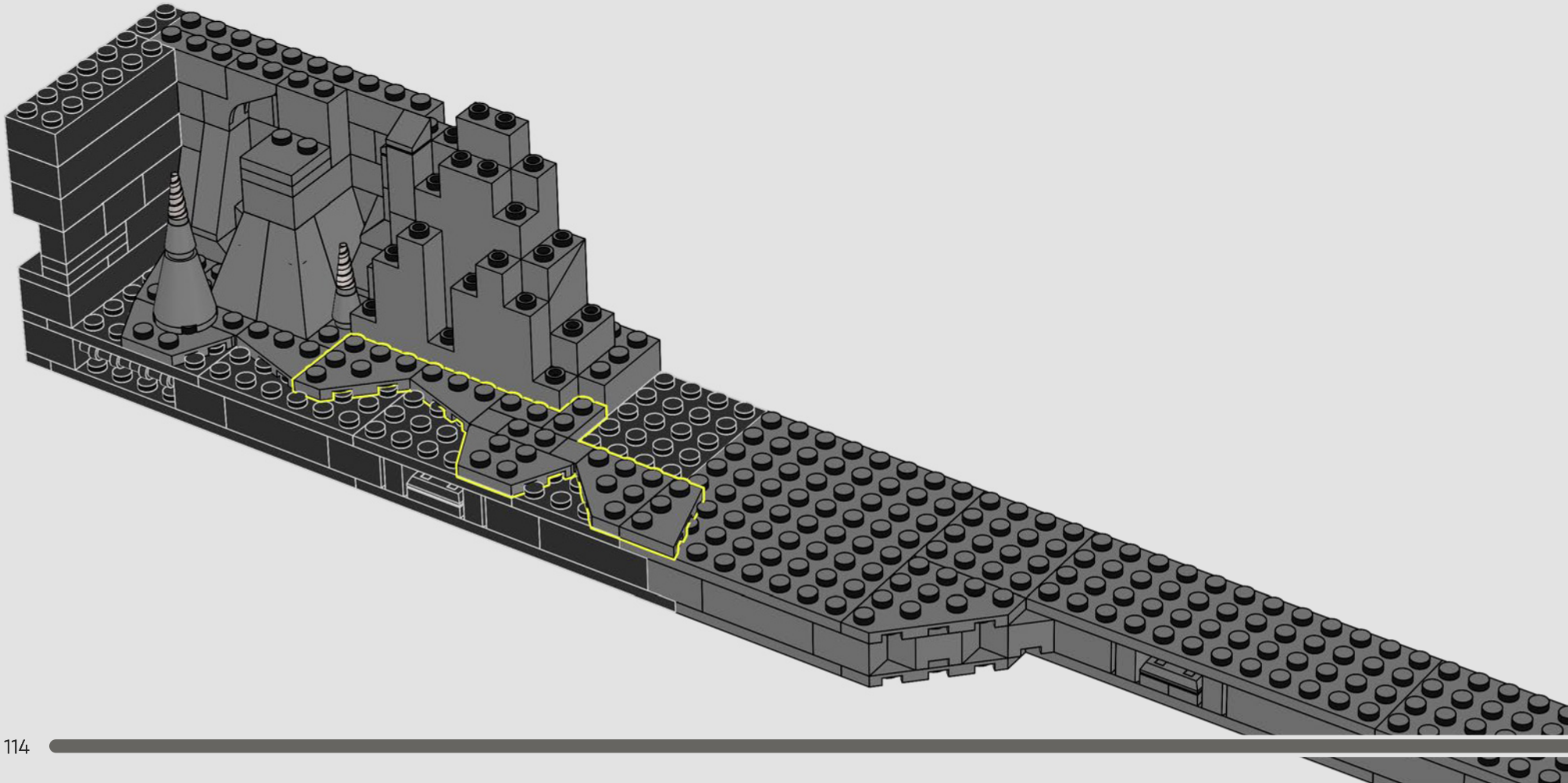

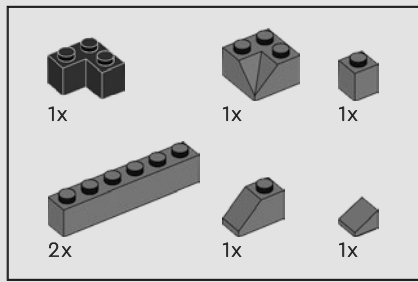

142

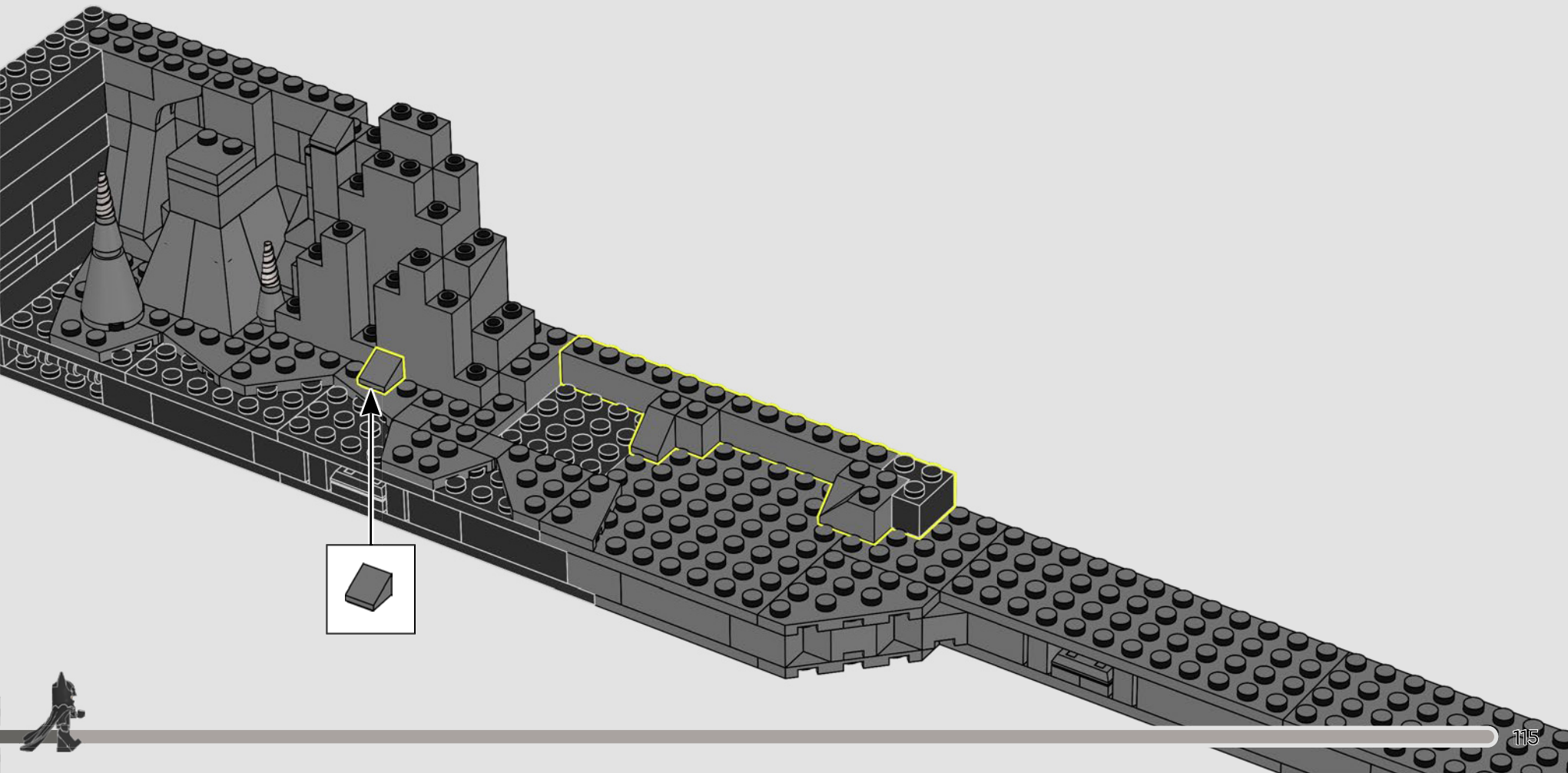



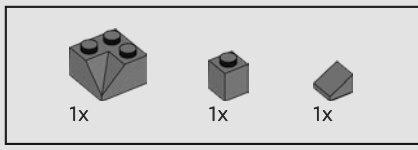

143

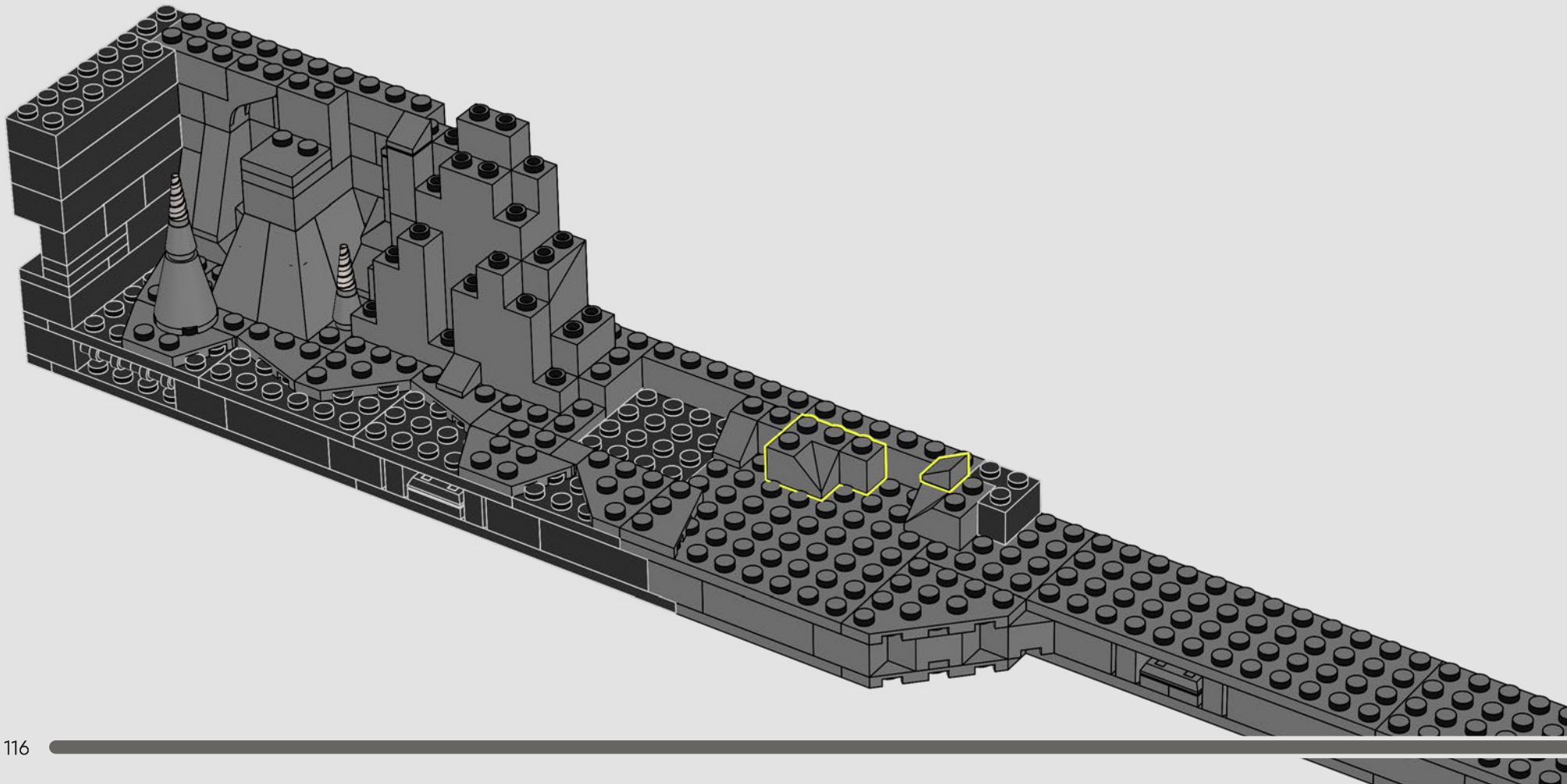

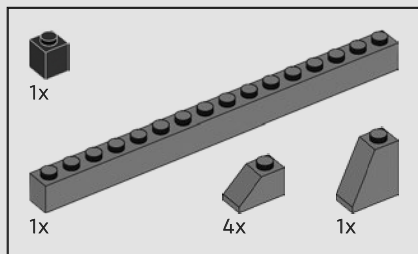

144

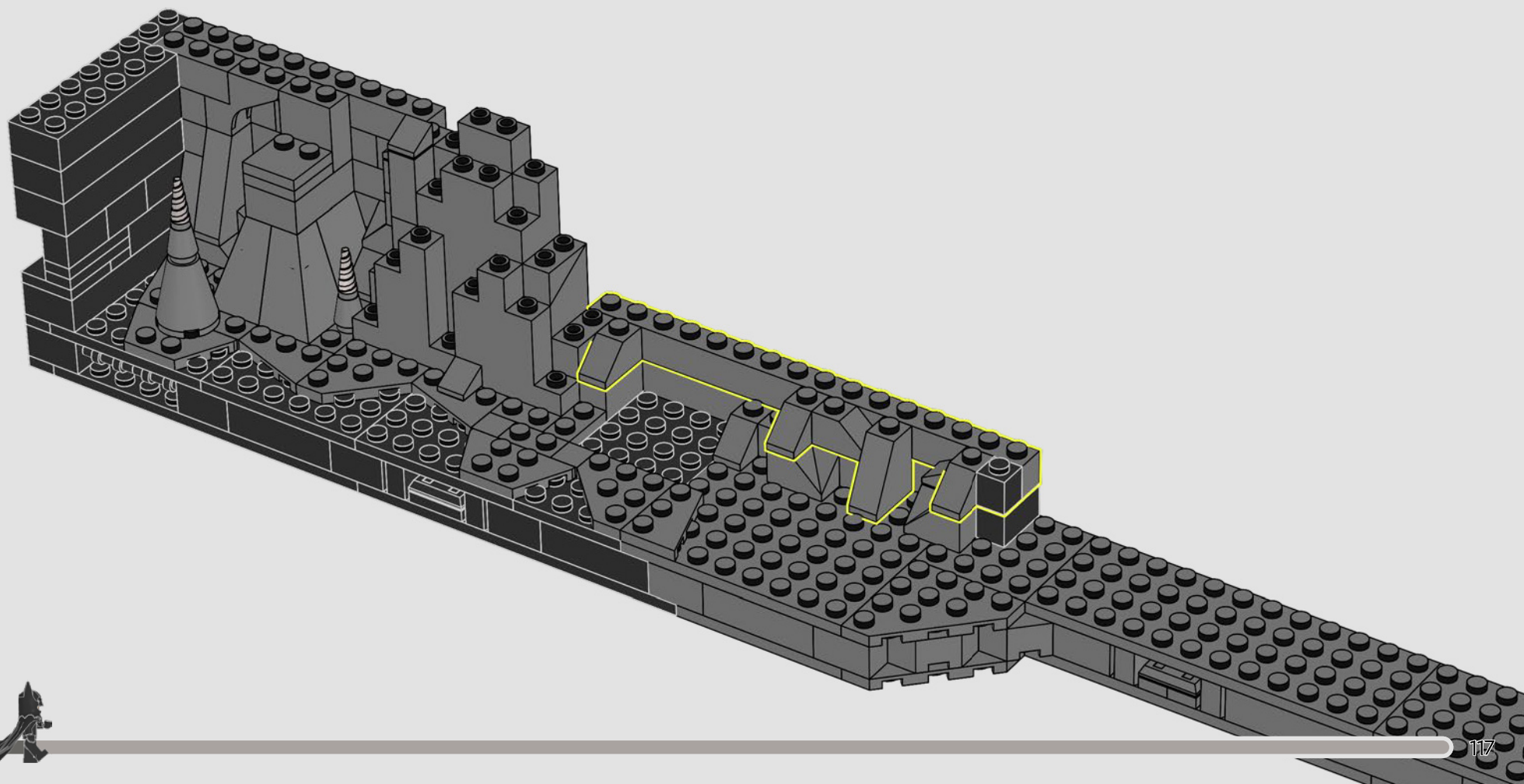

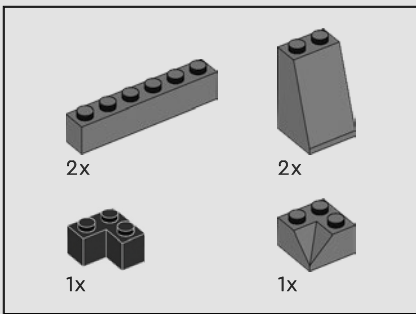

145

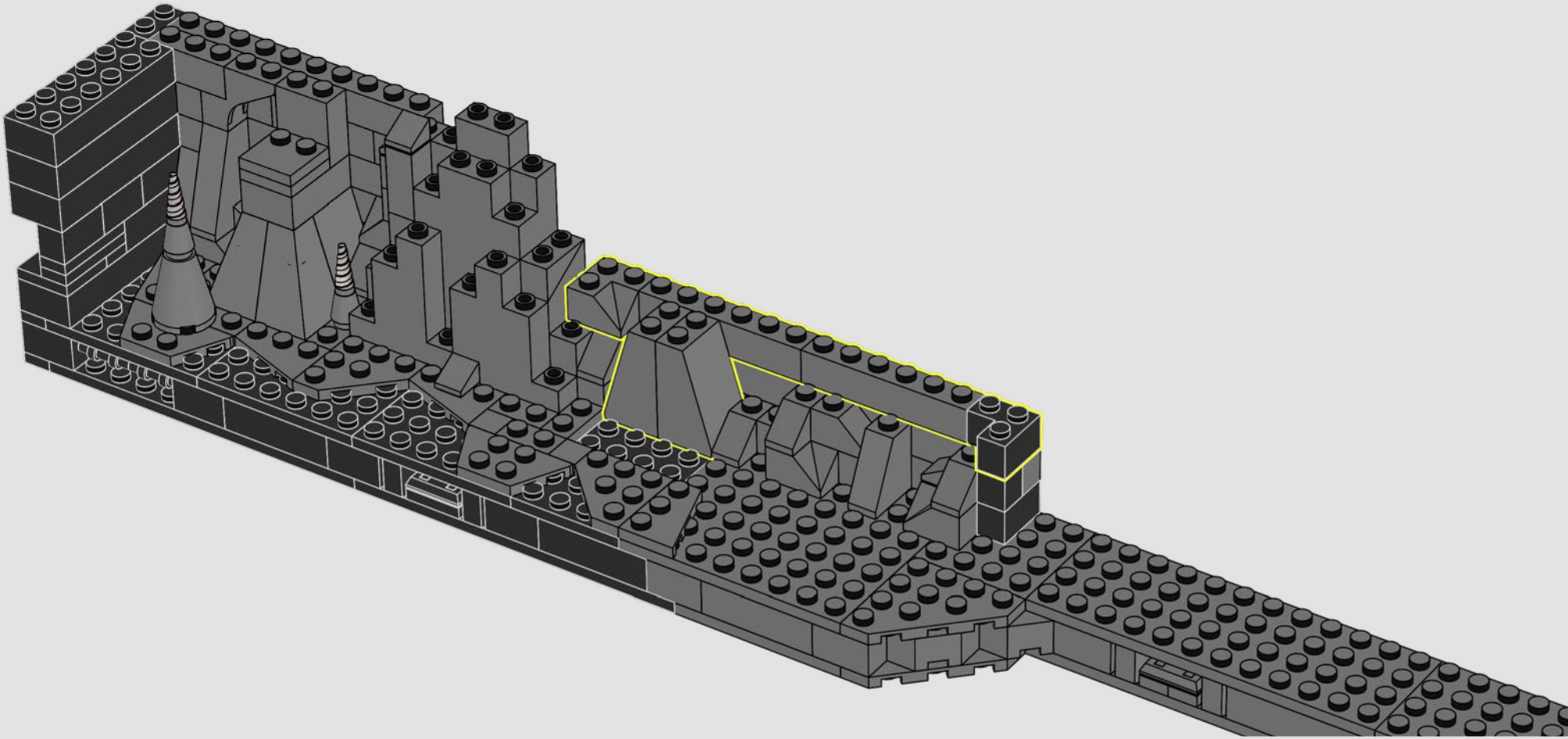

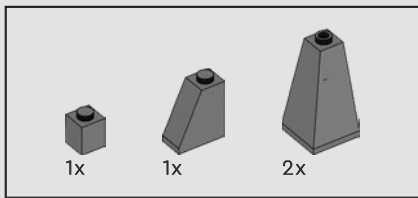

146

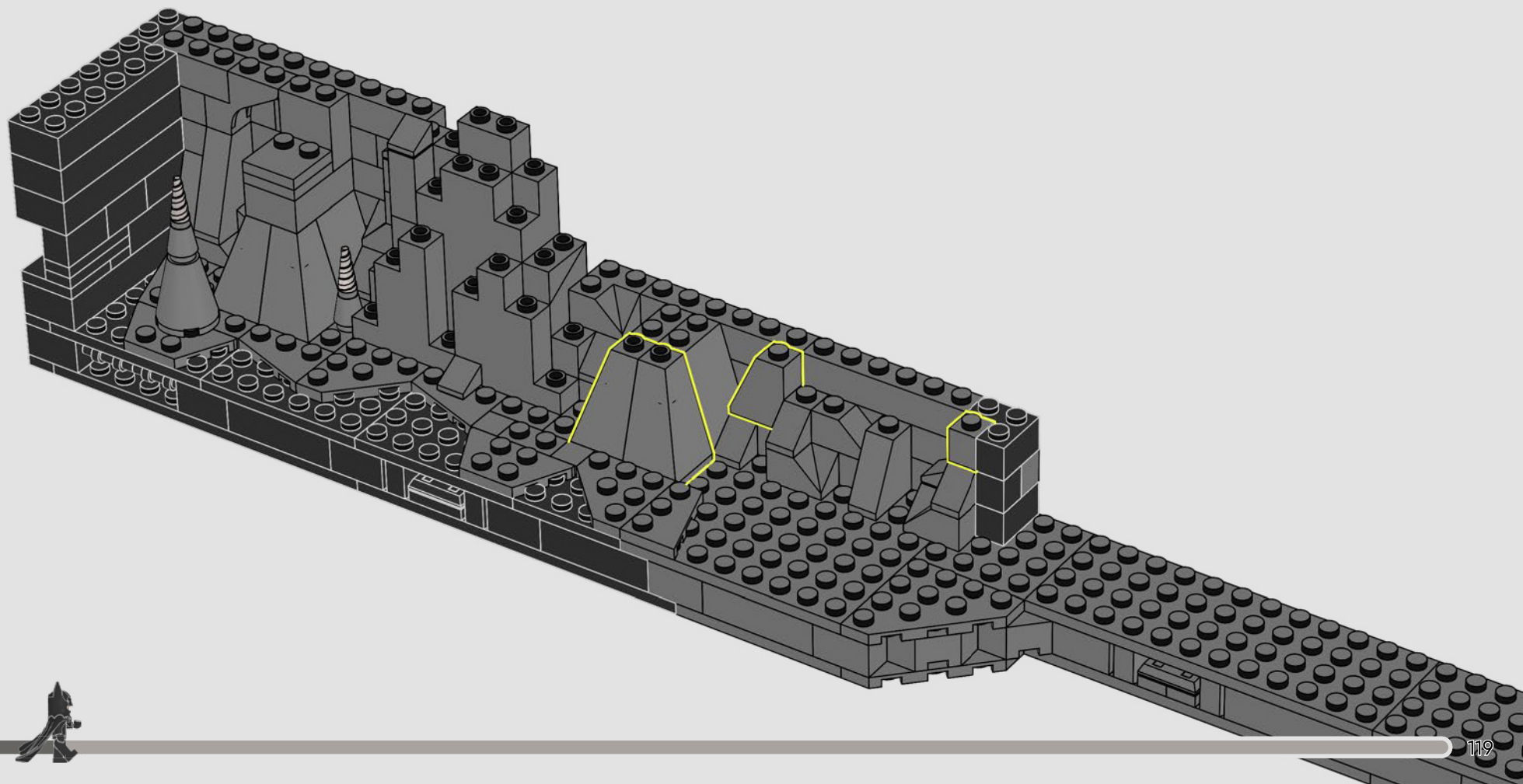



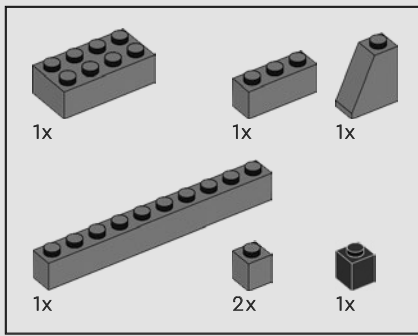

147

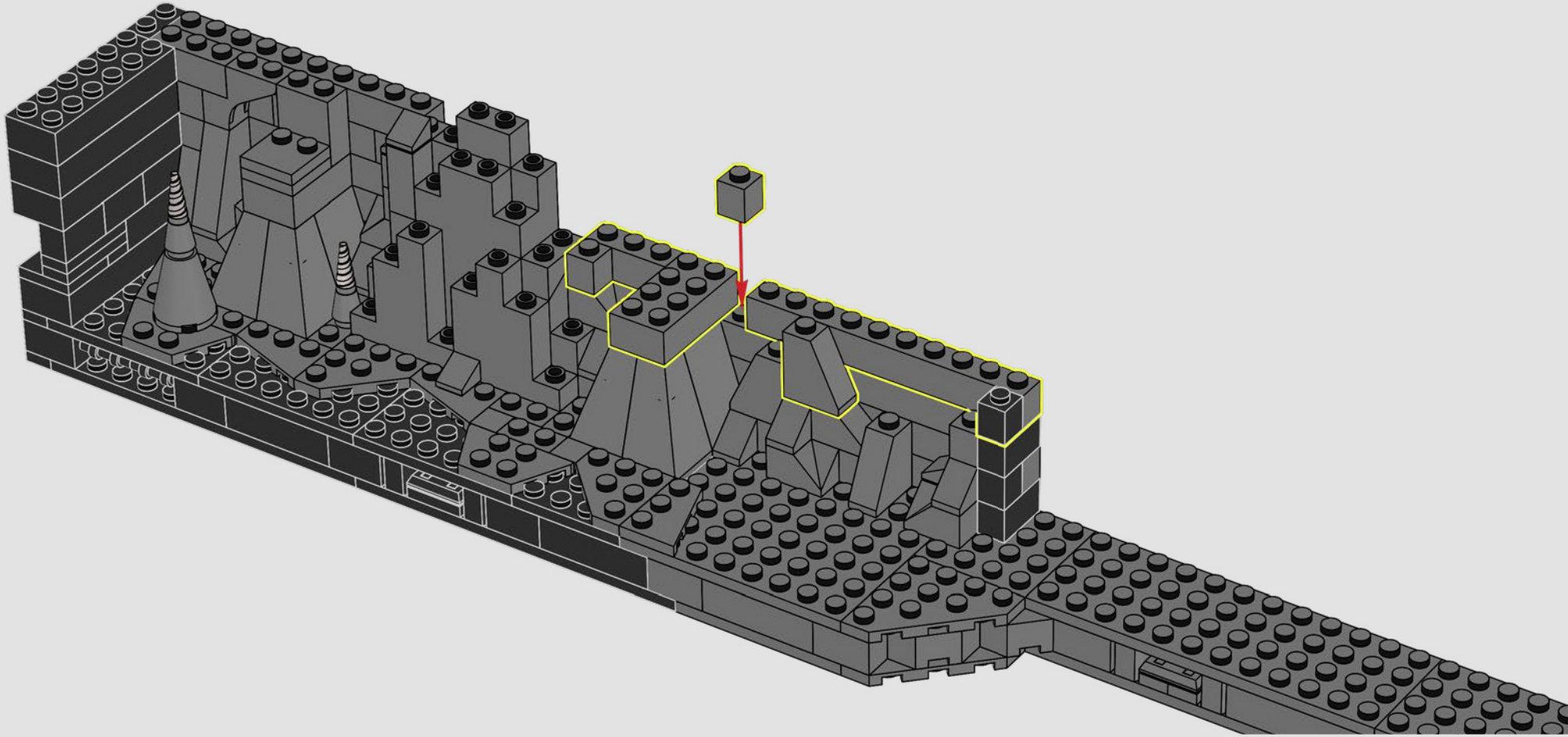



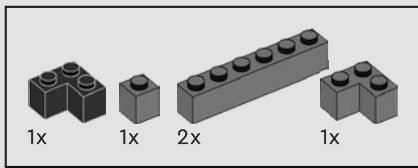

148

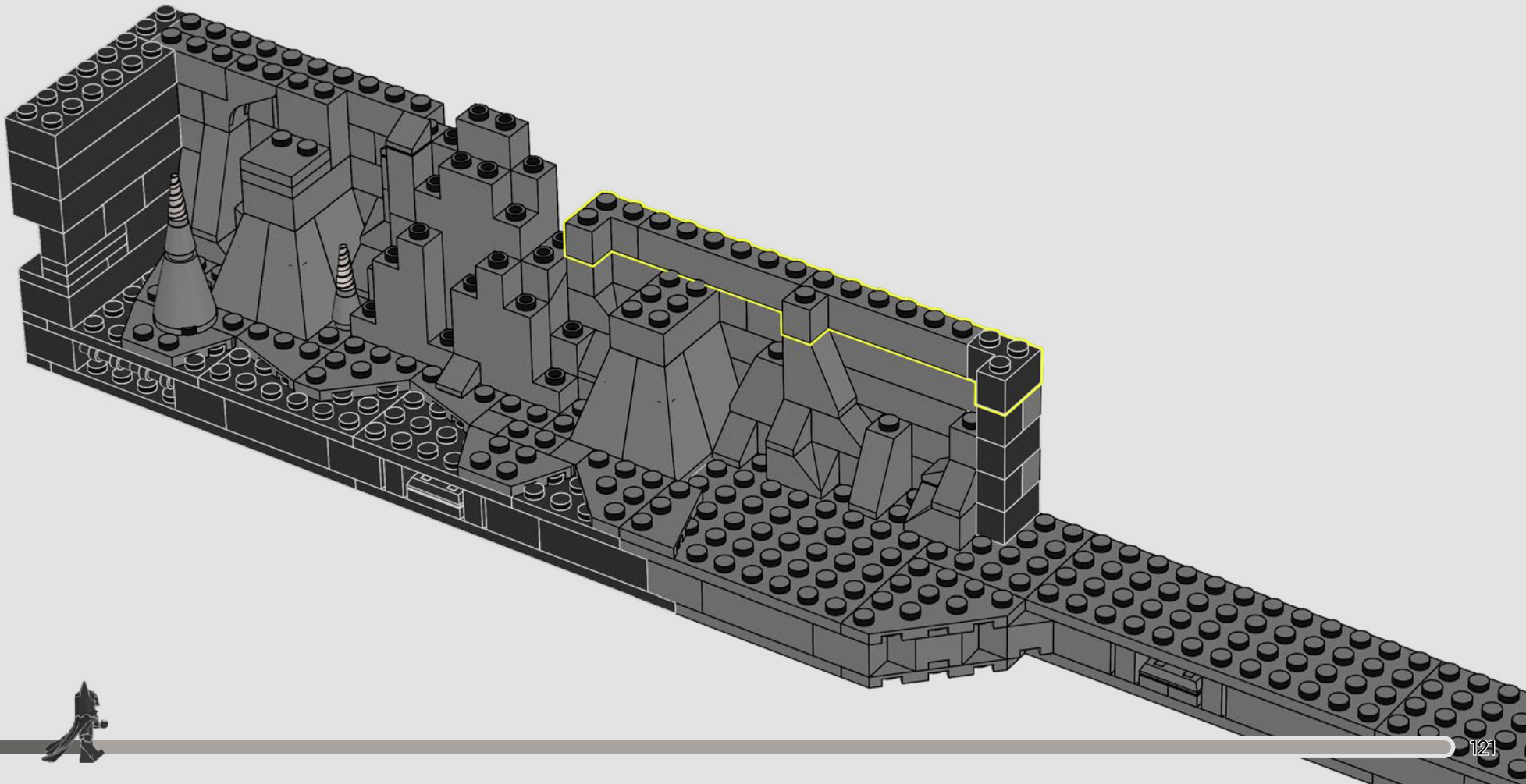

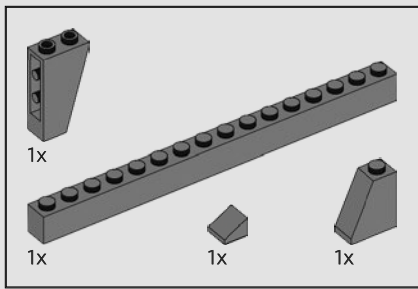

149

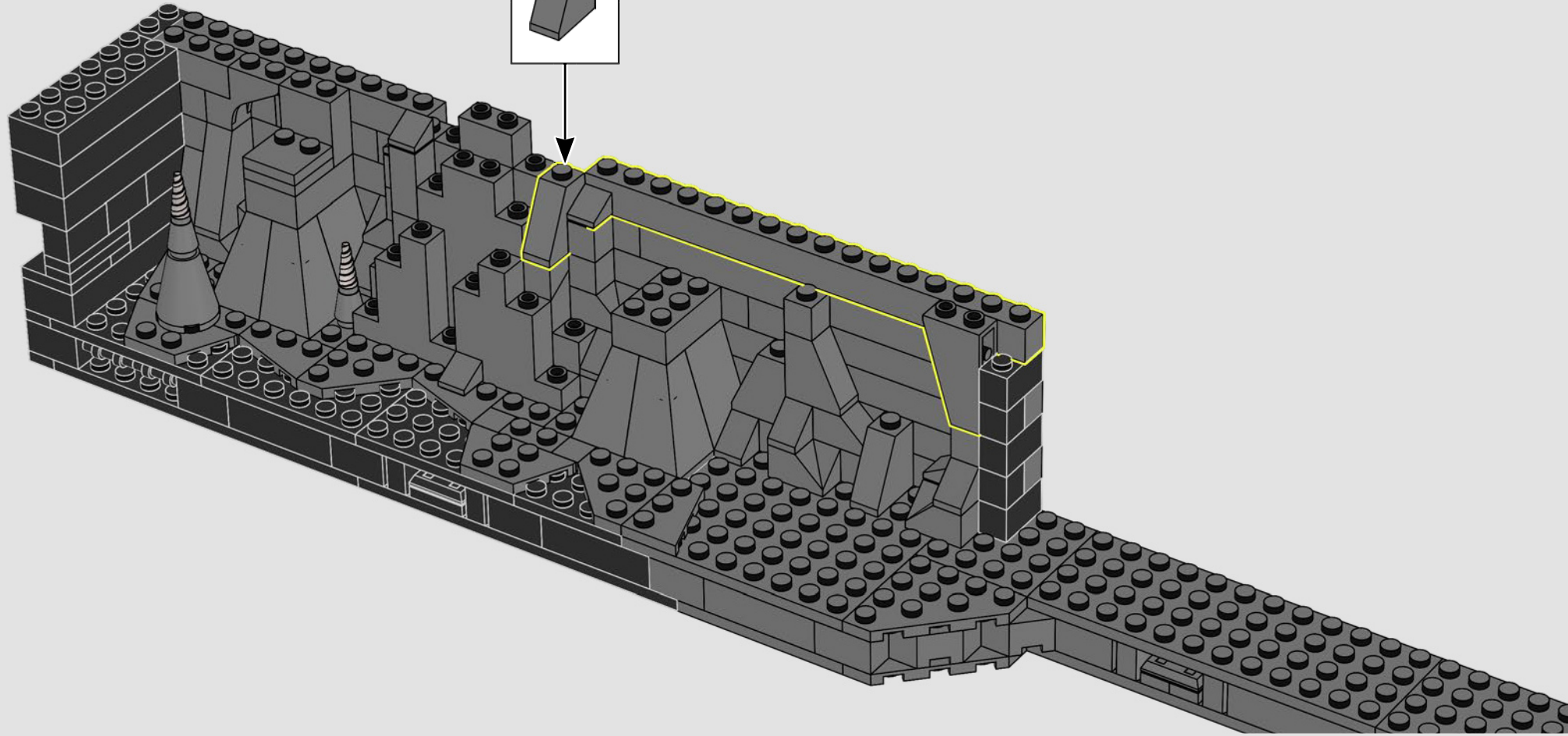
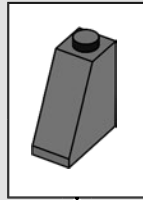

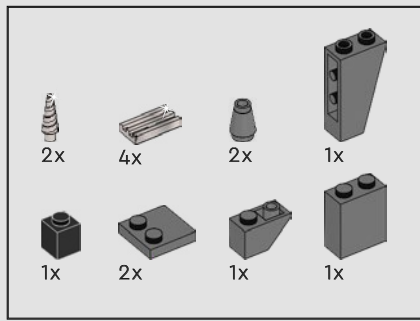

150

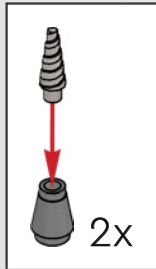
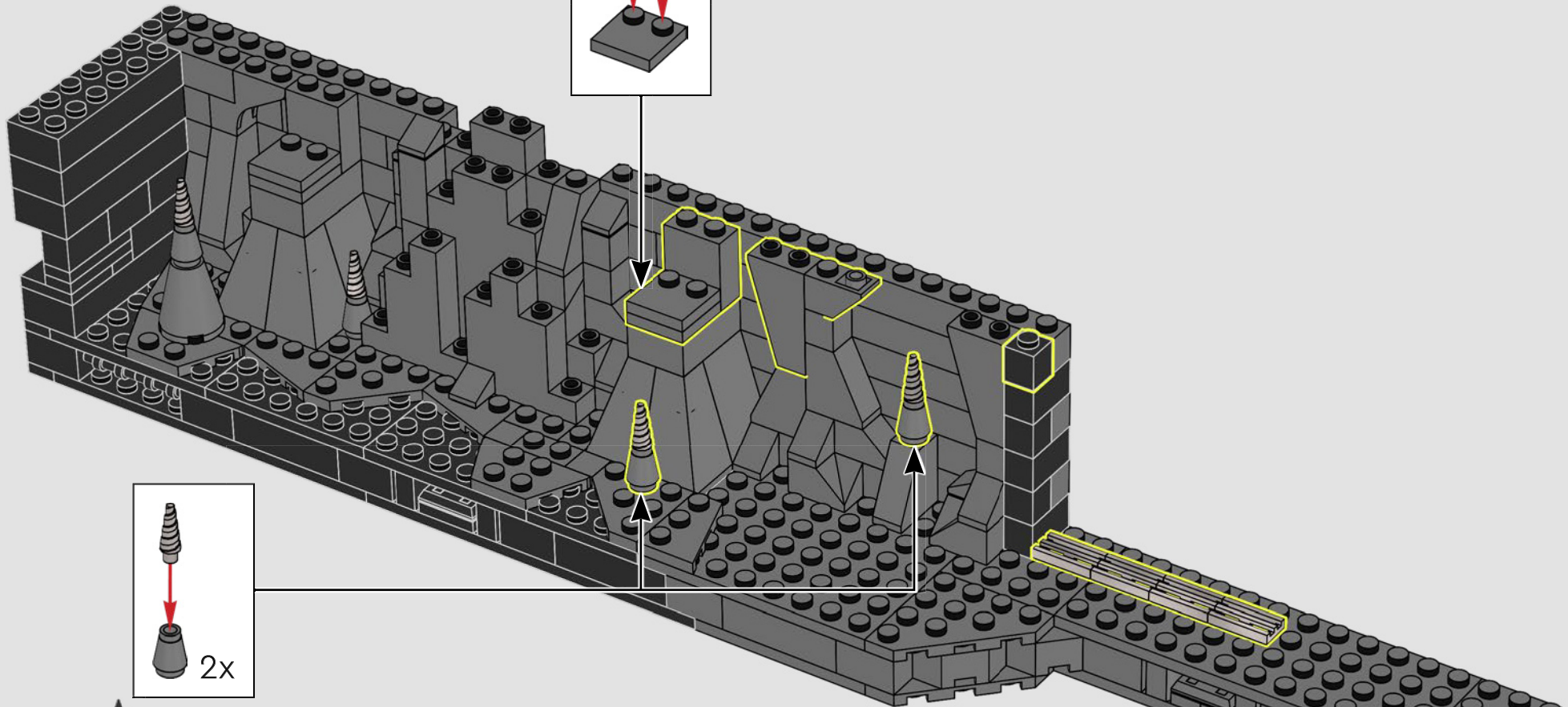
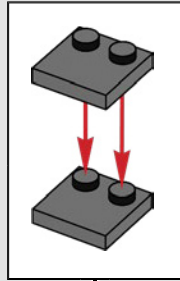



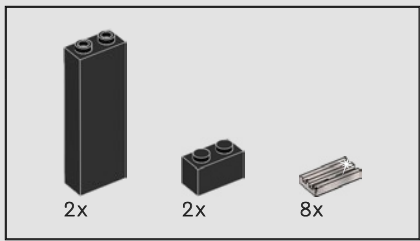

151

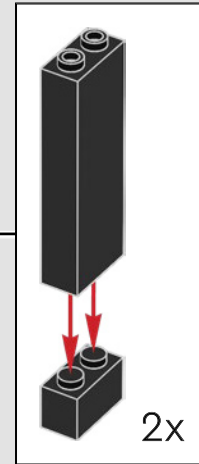
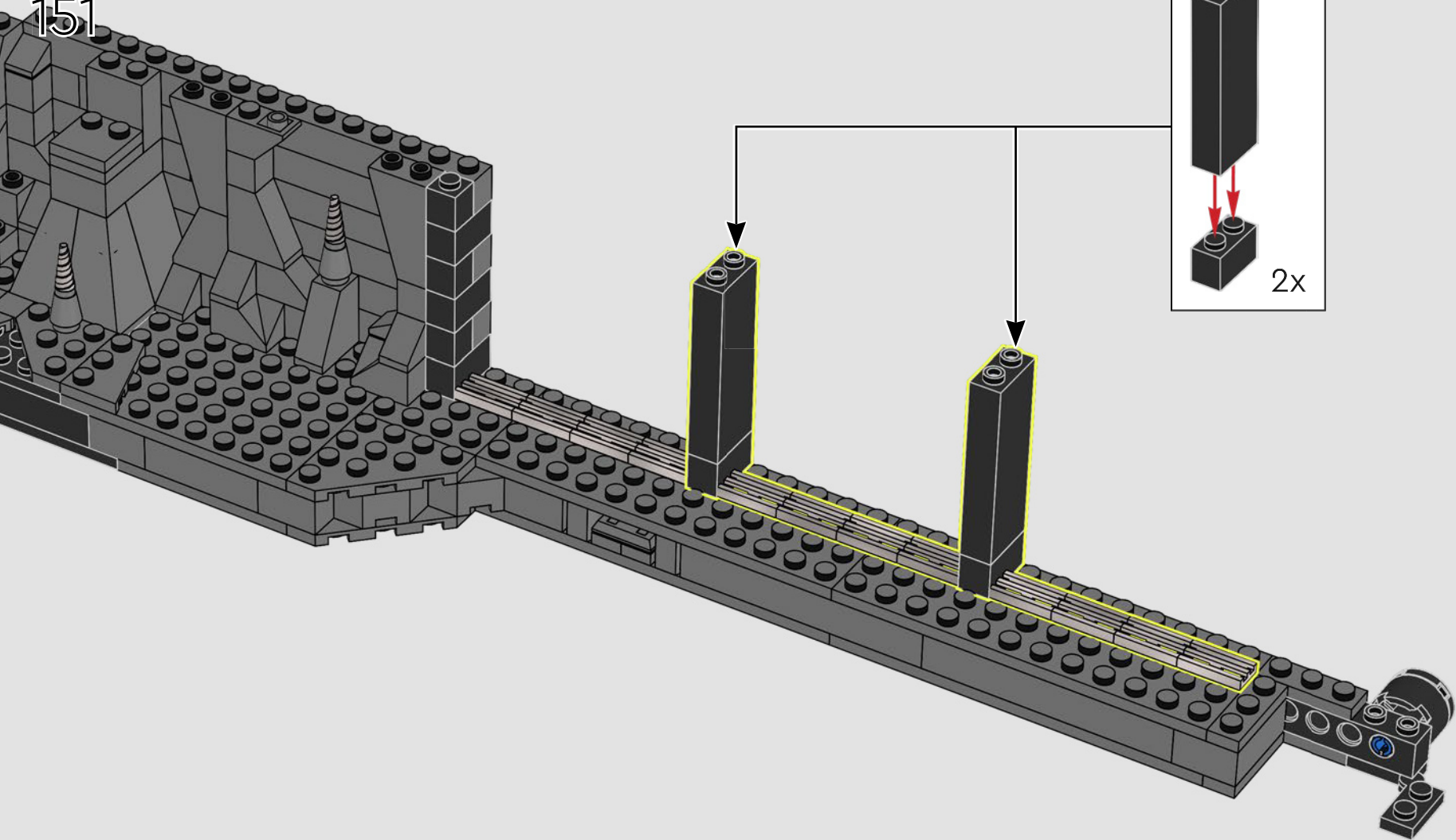

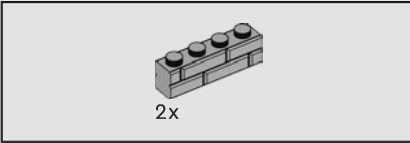
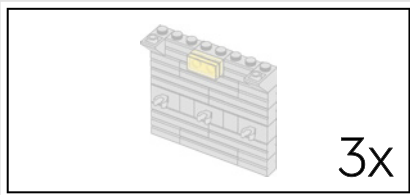

152

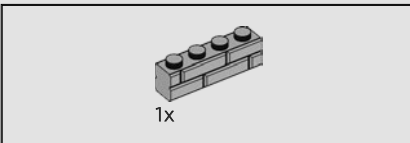
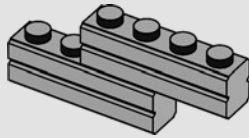

153

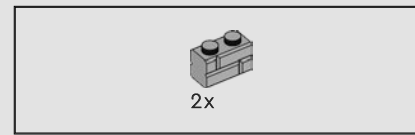
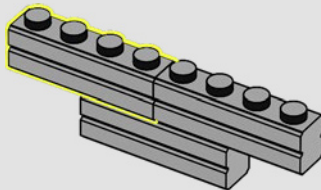

154

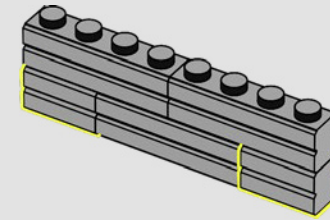

155

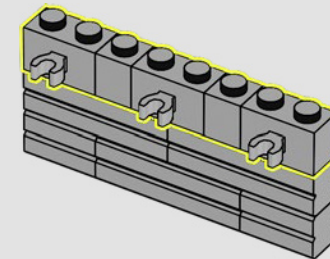



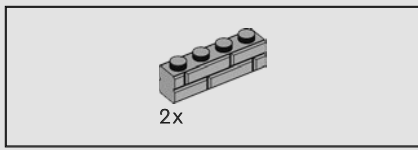

156

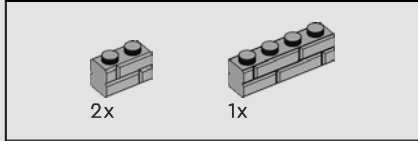
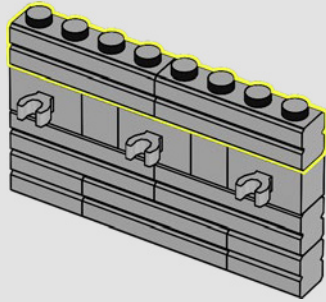

157

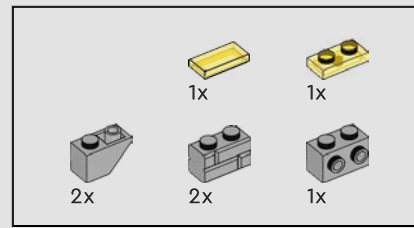
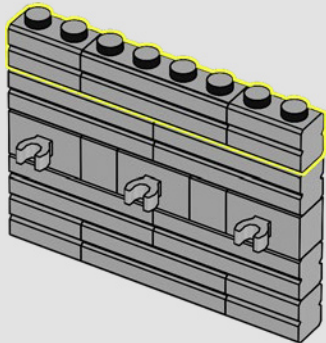

158

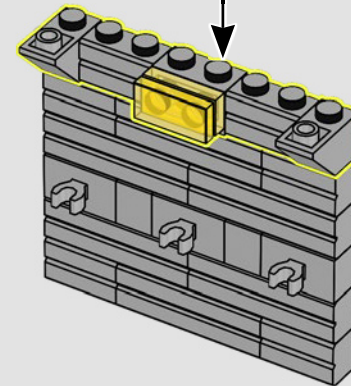
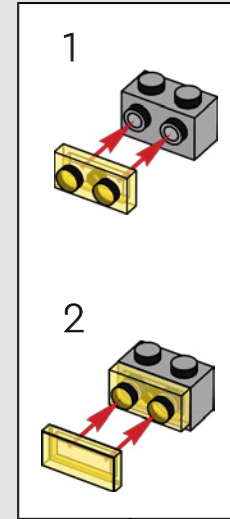

3x

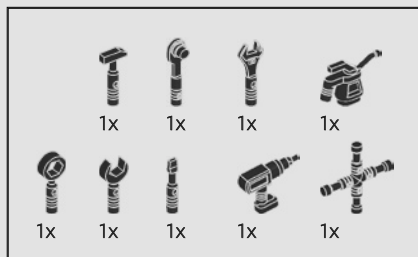

159

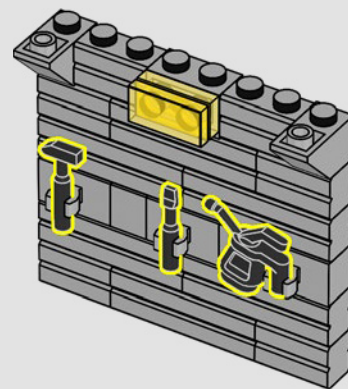
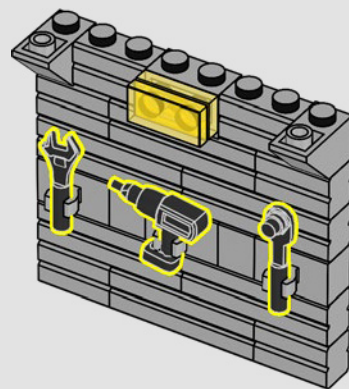
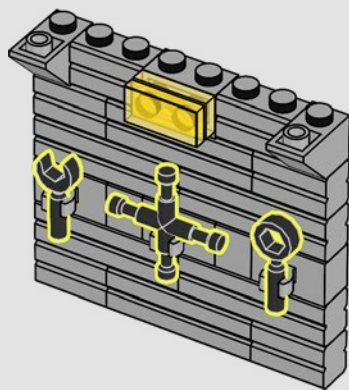

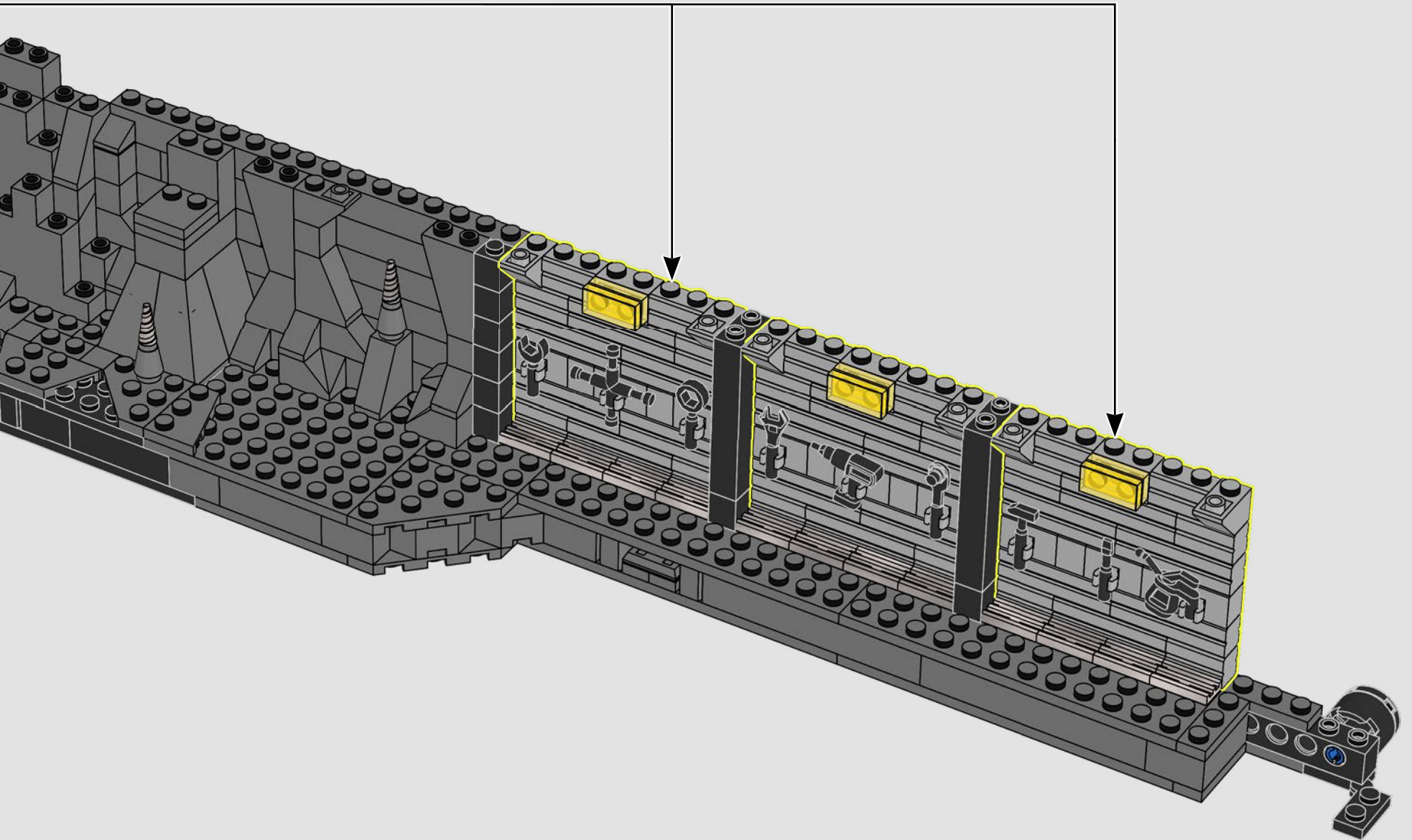

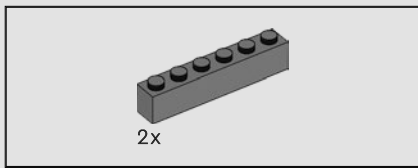

161

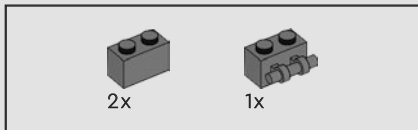
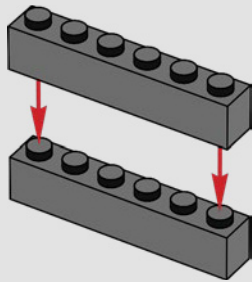

162

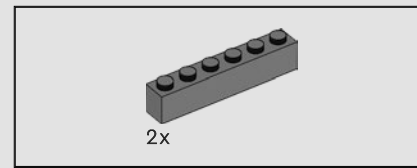
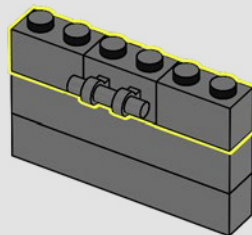

163

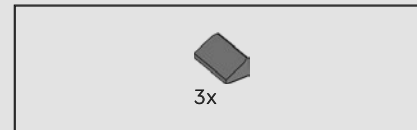
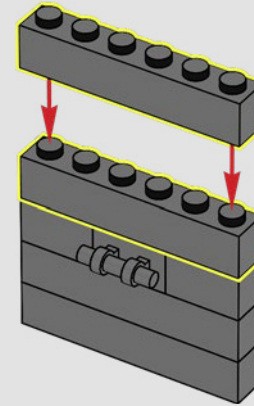

164

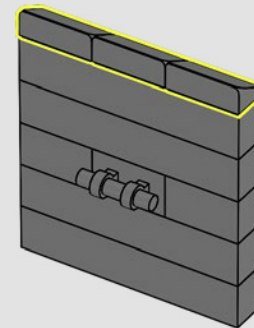

165

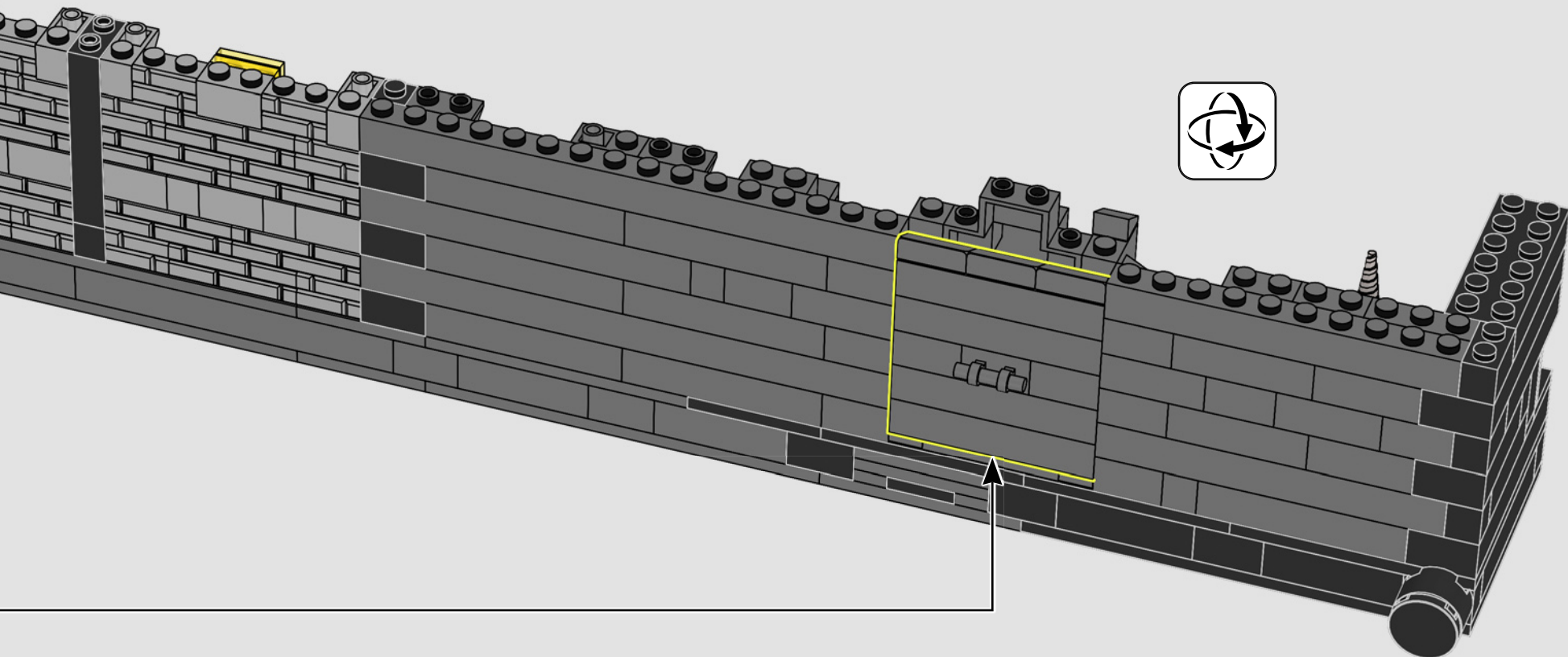



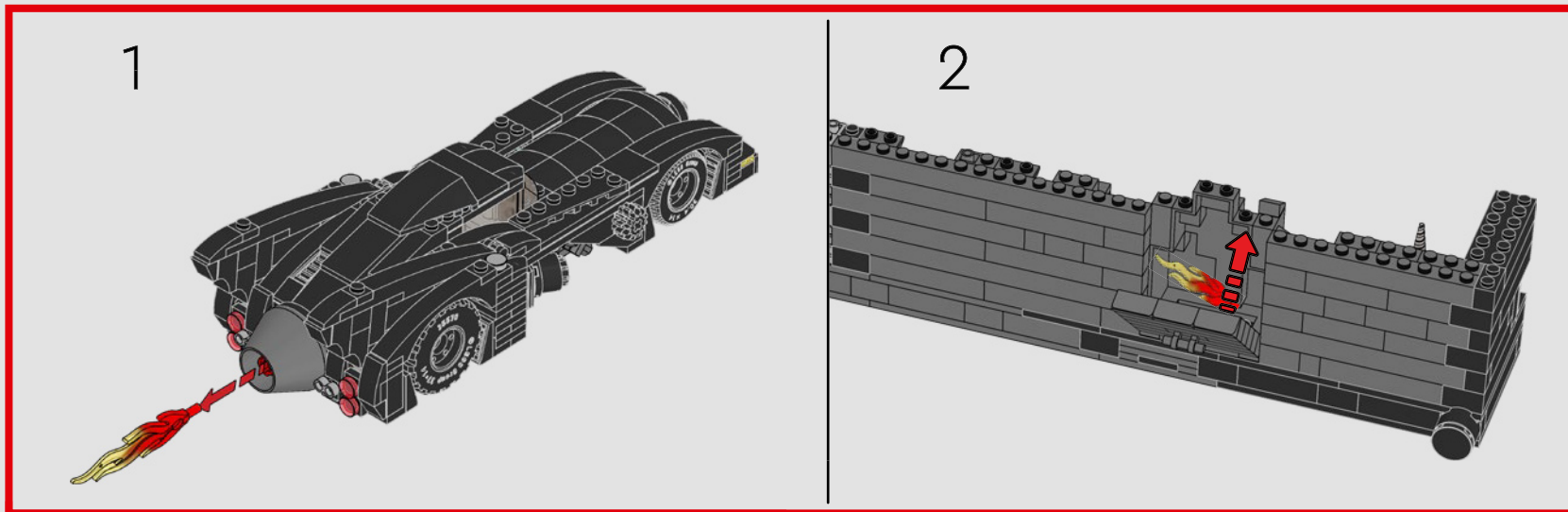

## 秘密储物空间

甚至这款蝙蝠洞影盒的外观上也有秘密。找到秘密存储空间，您可以在不使用蝙蝠战车尾焰组件时将其隐藏起来。



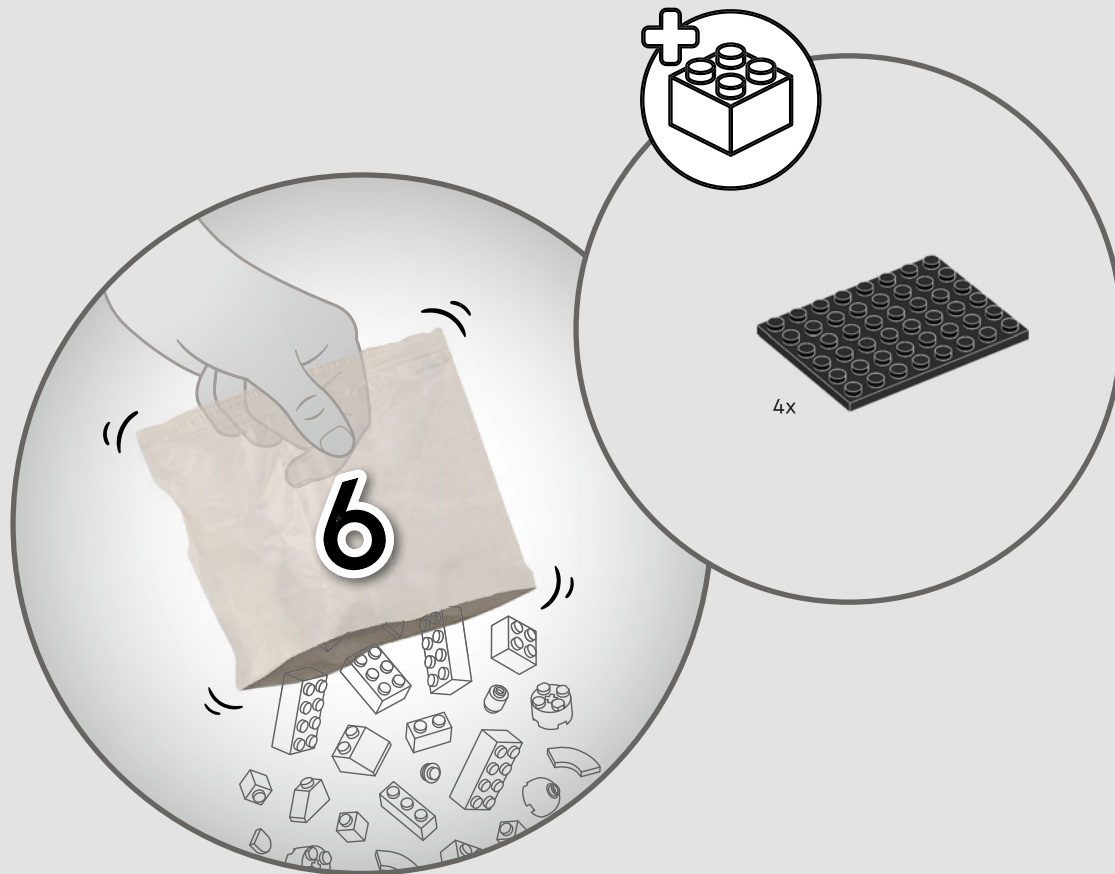

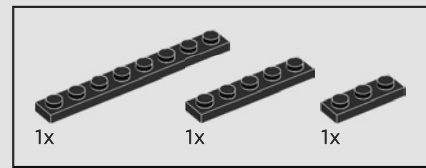
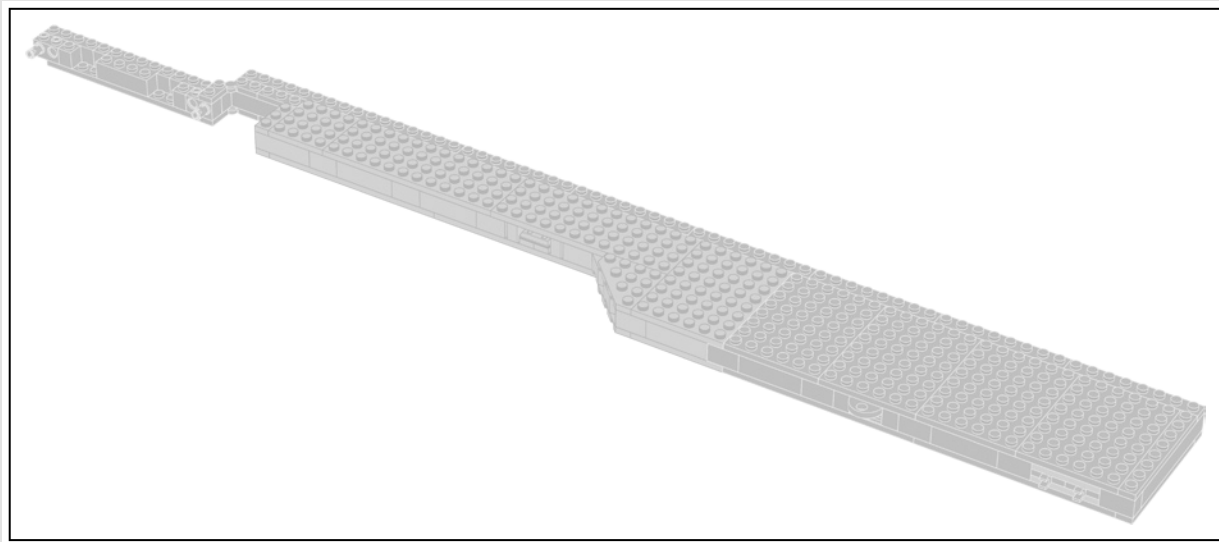

167

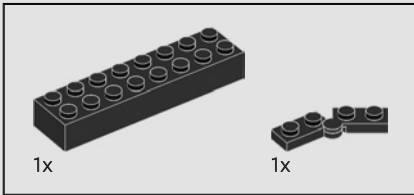

166

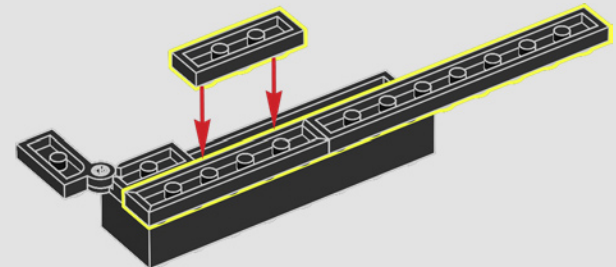
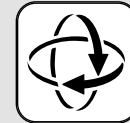
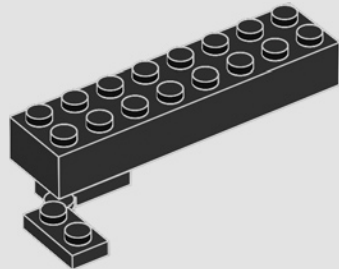

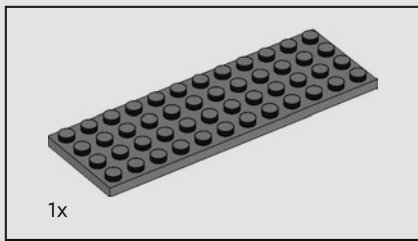

168

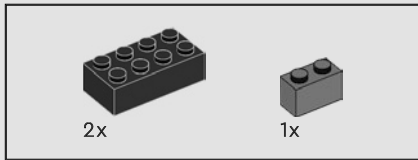
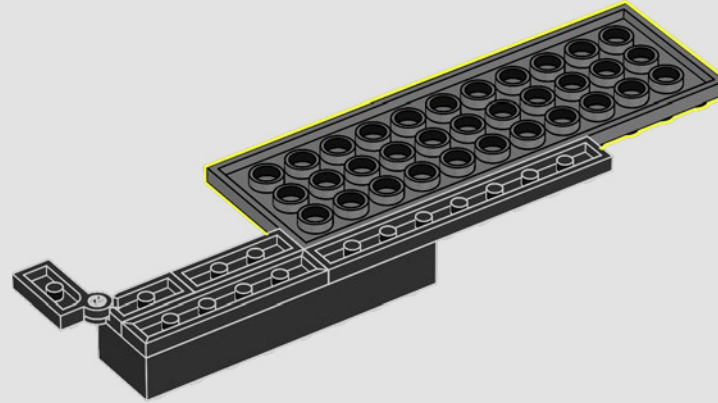

169

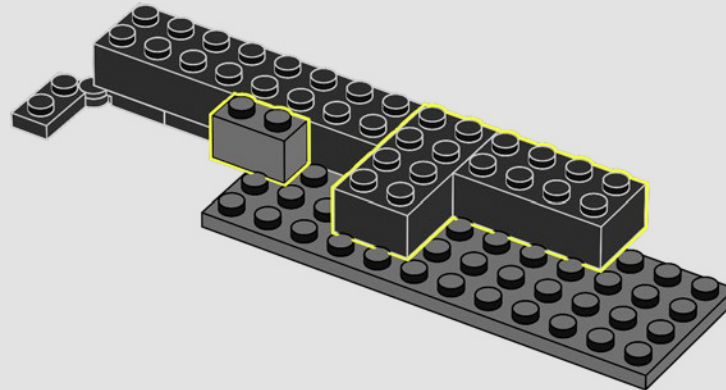

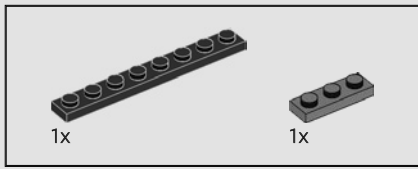

170

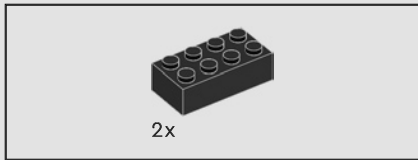
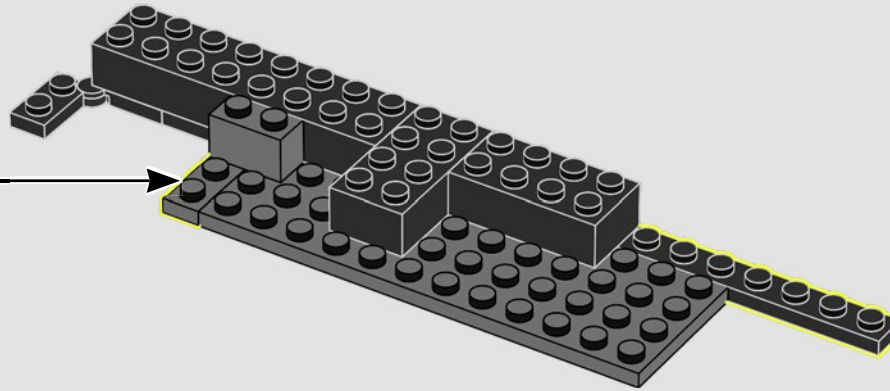
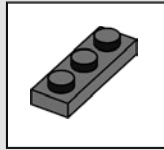

171

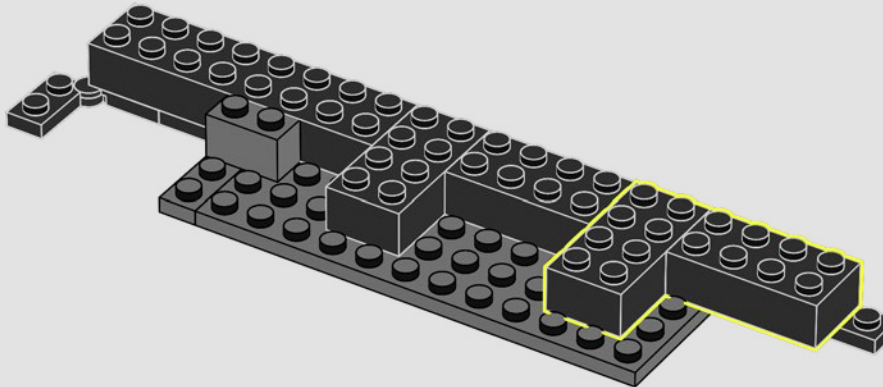



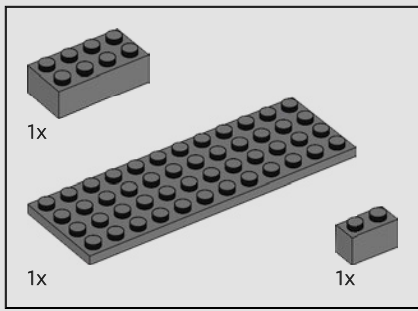

172

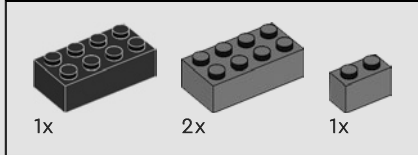
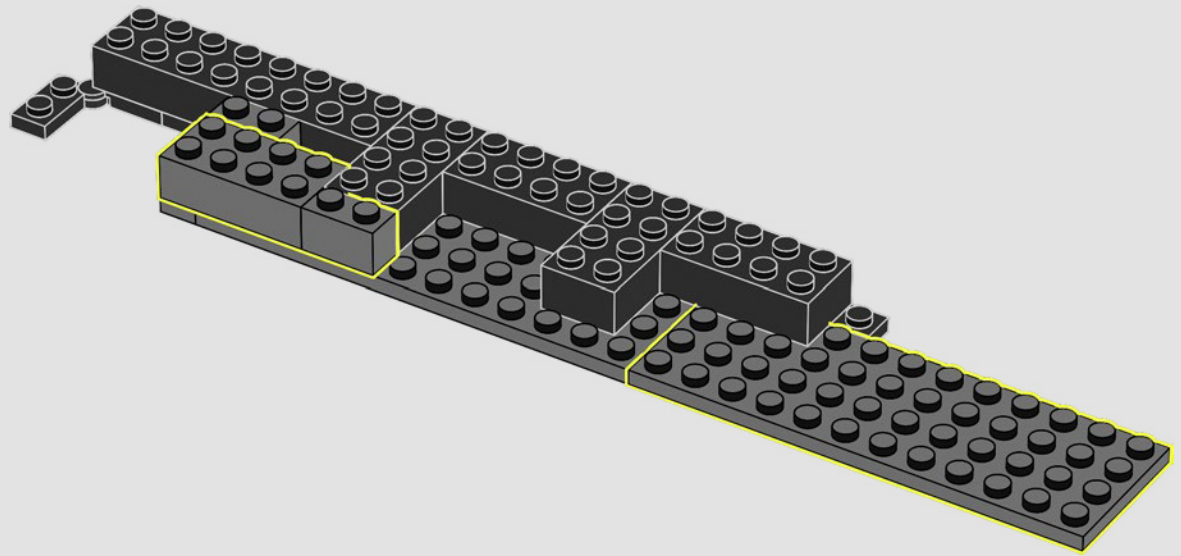

173

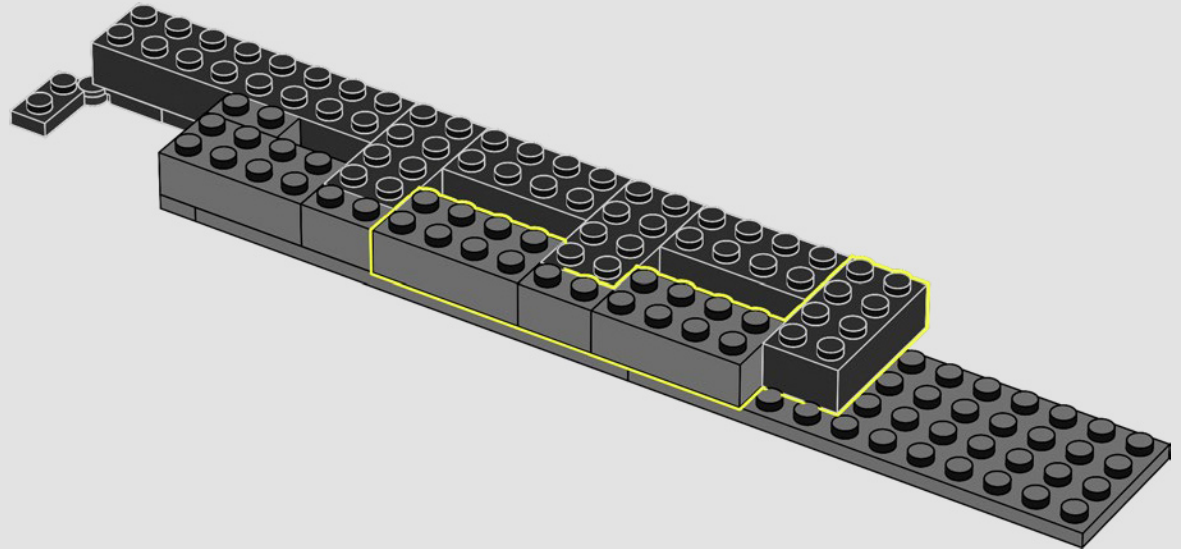

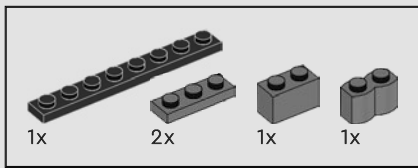

174

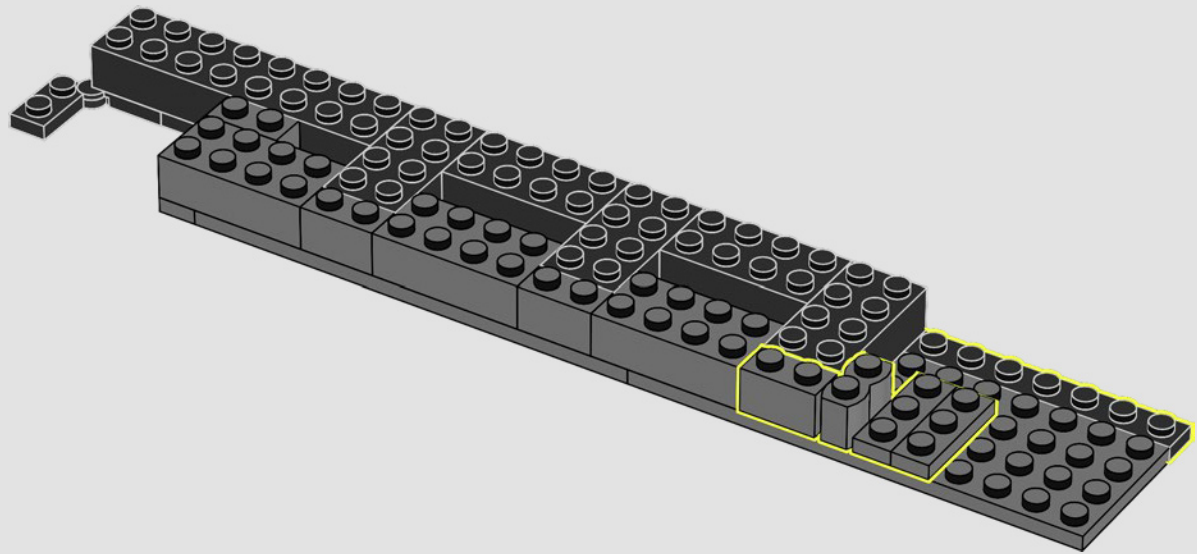

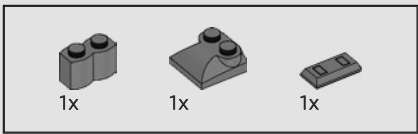

175

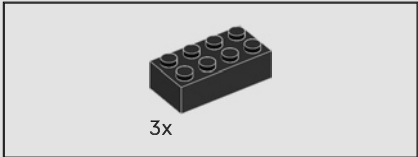
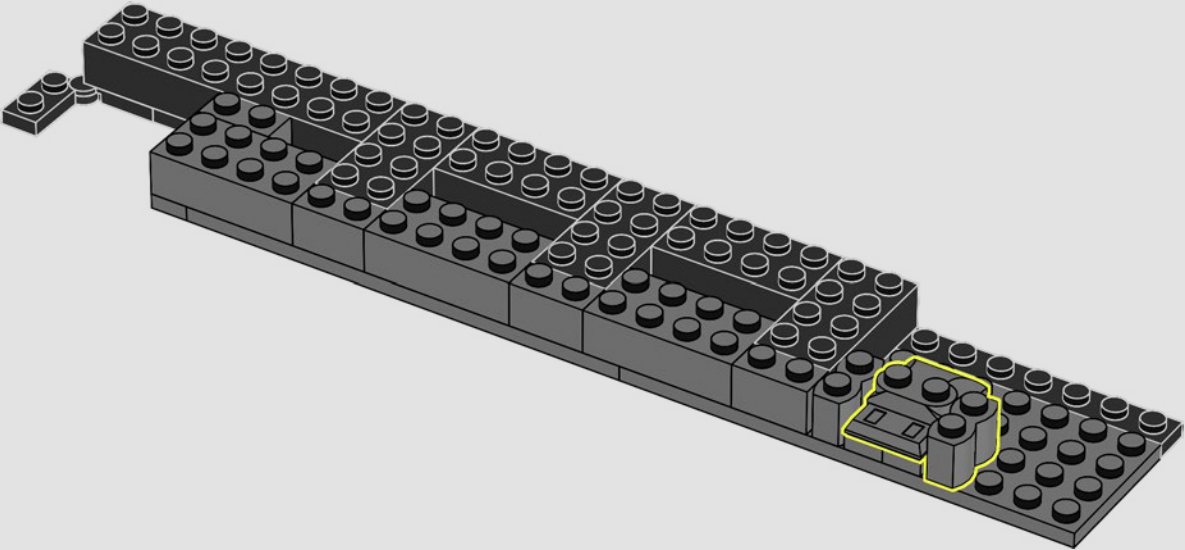

176

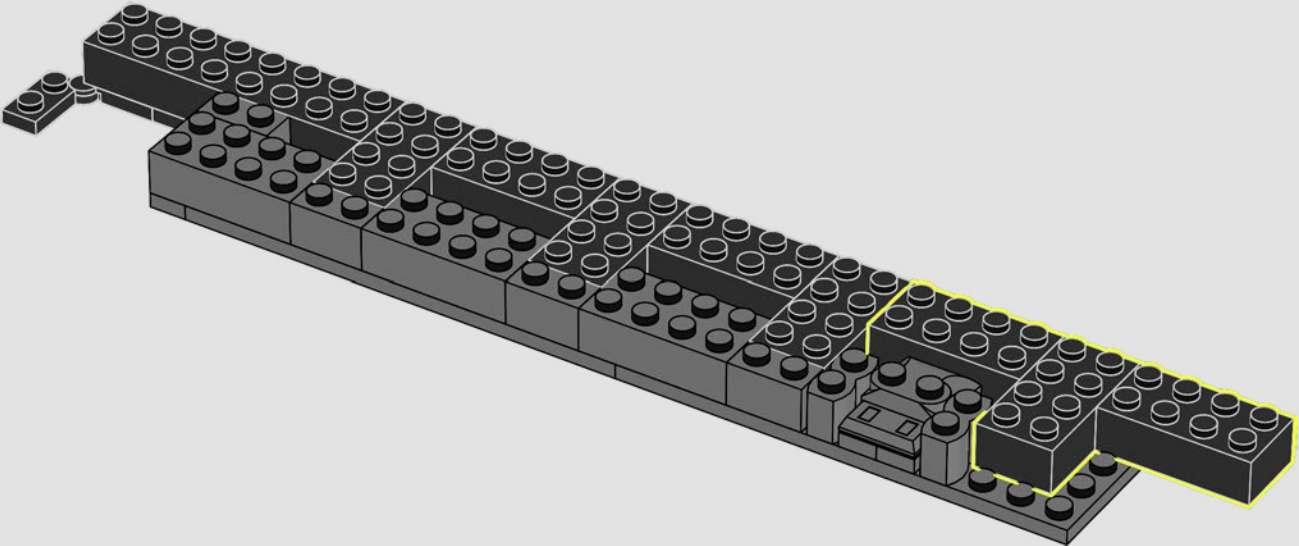

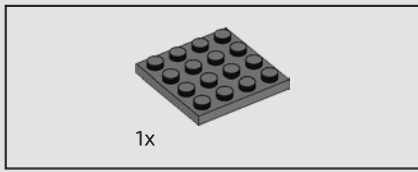

177

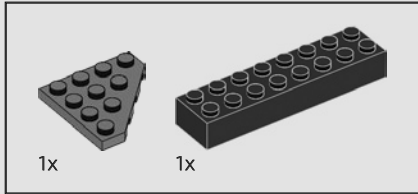
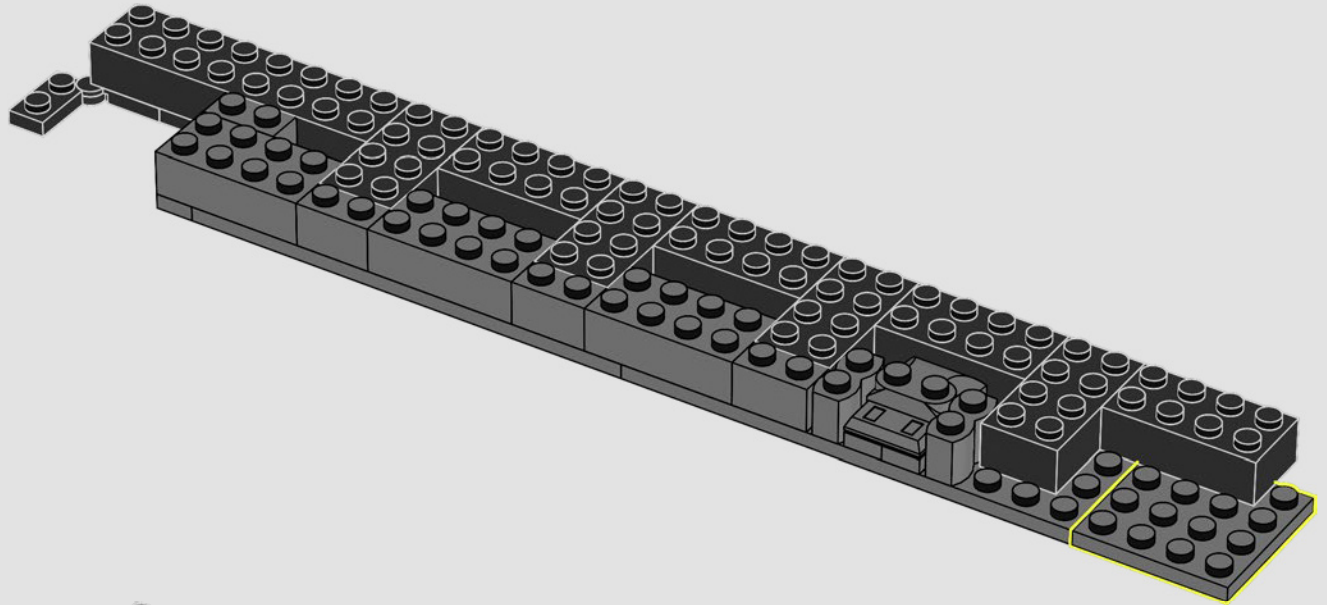

178

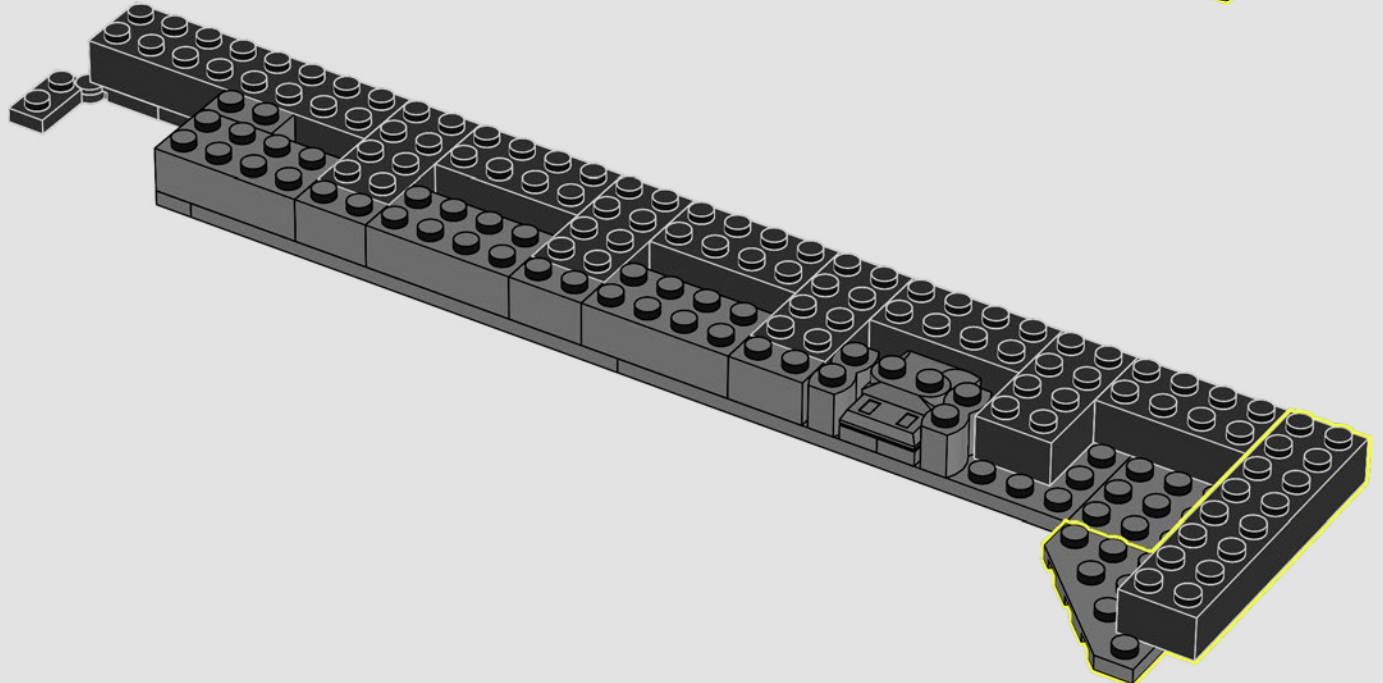



179

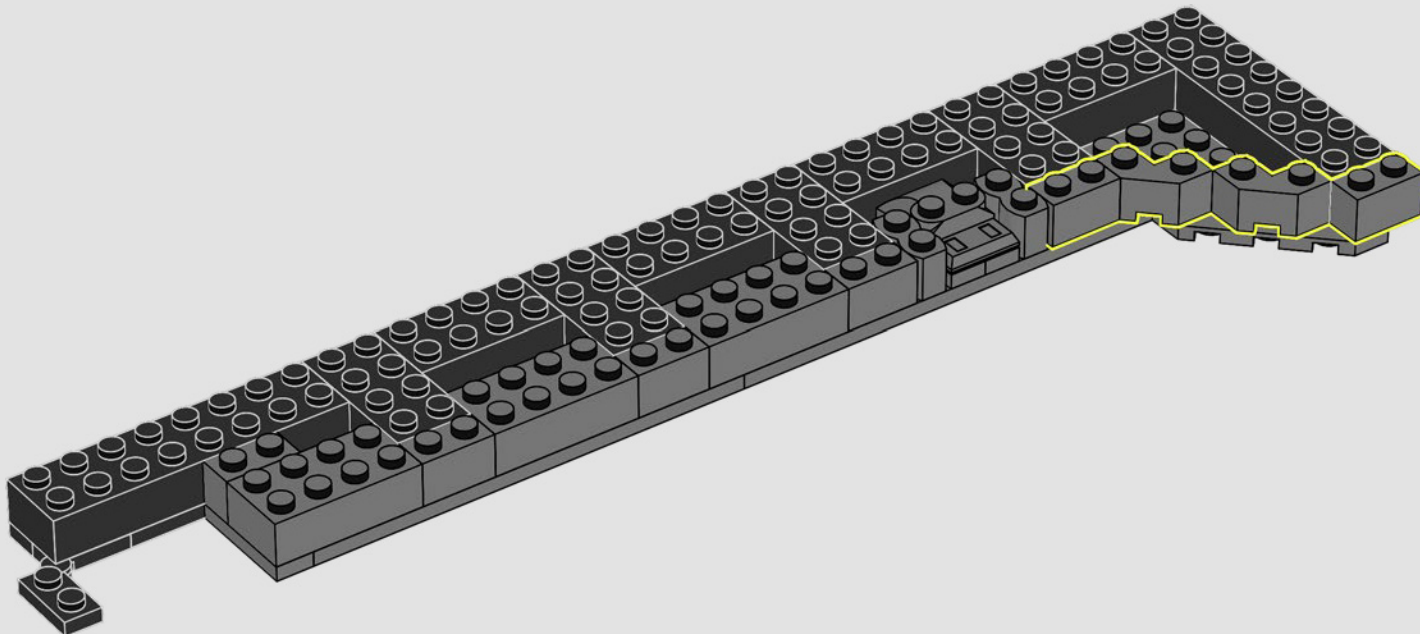



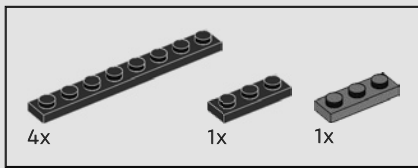

180

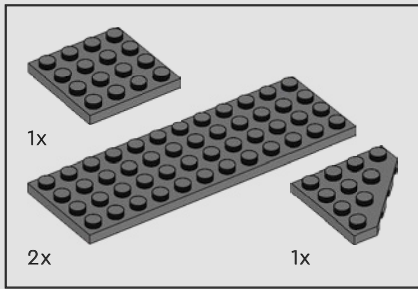
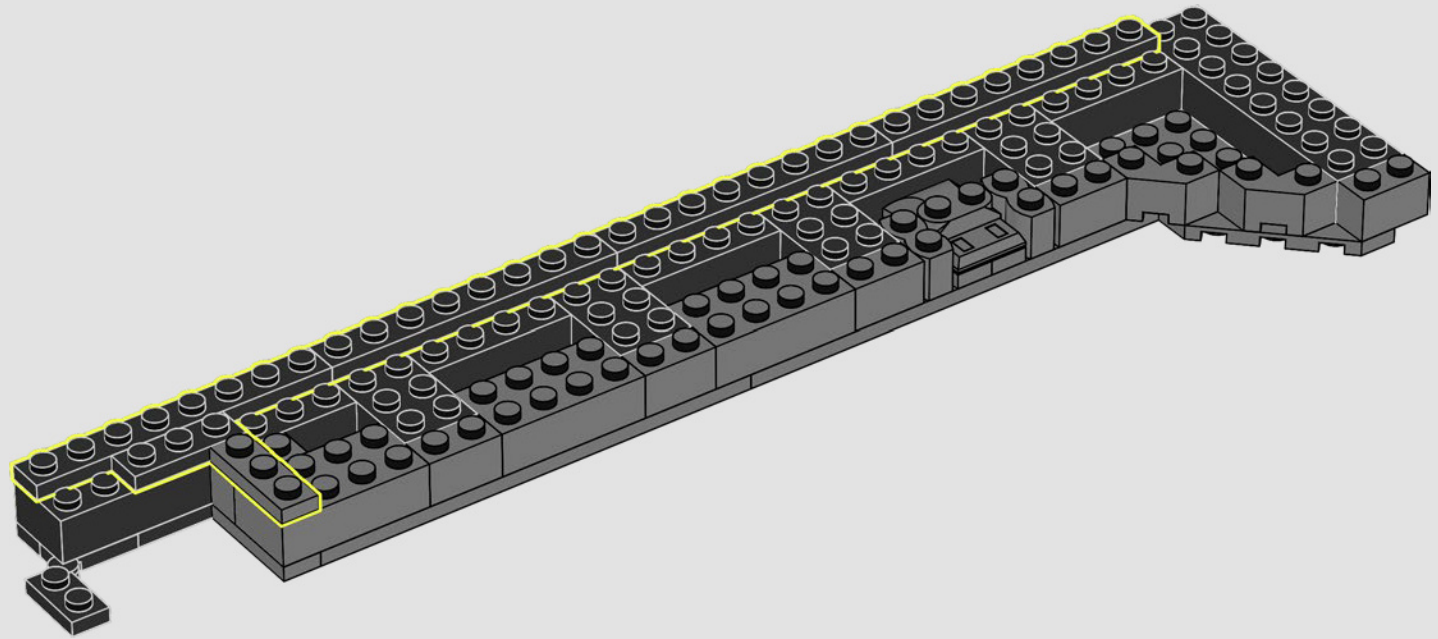

181

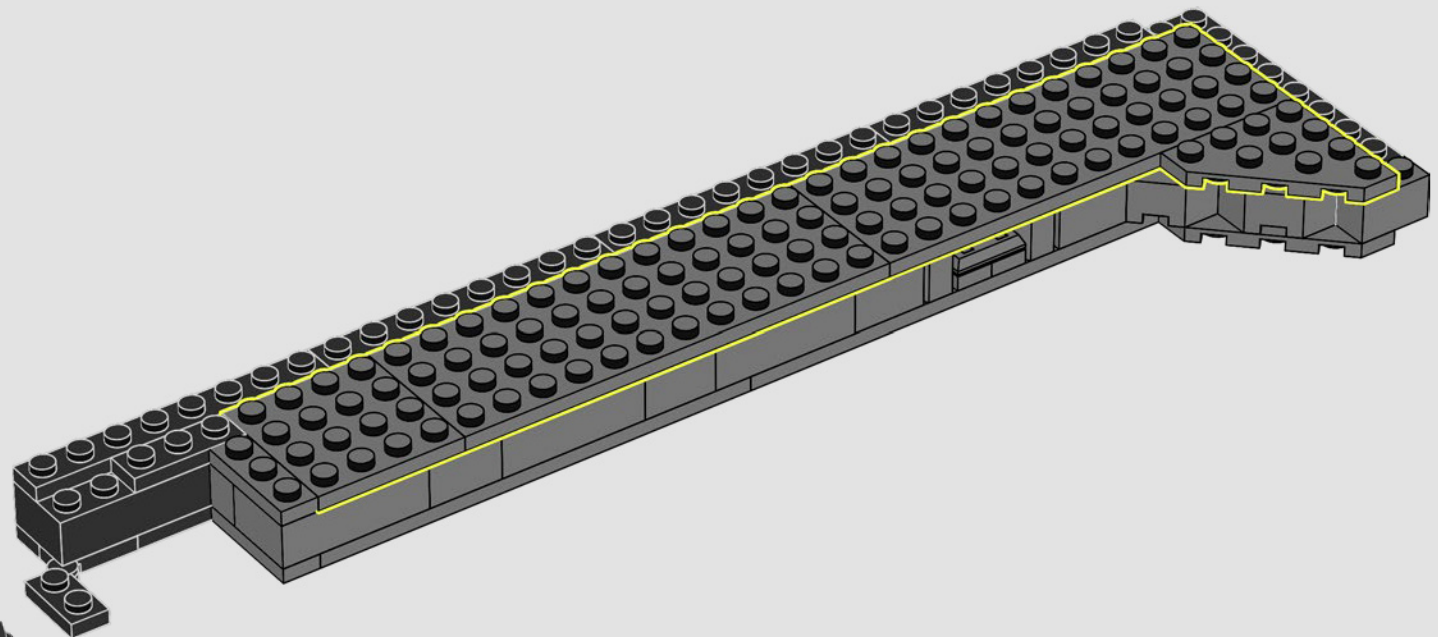

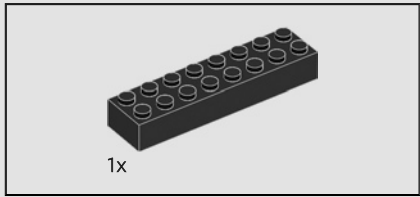
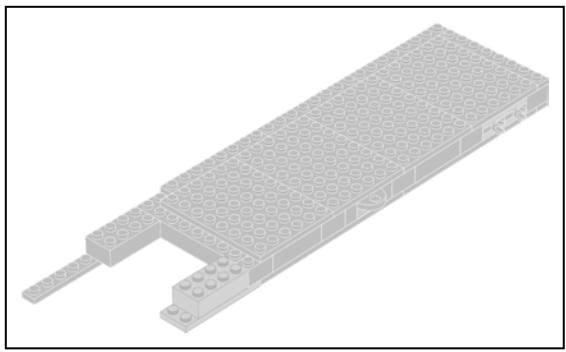

182

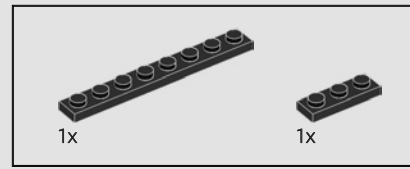
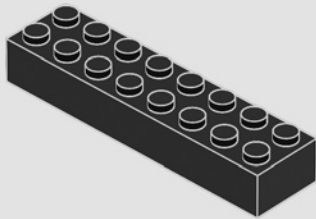

183

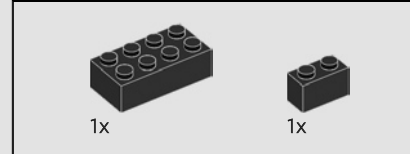
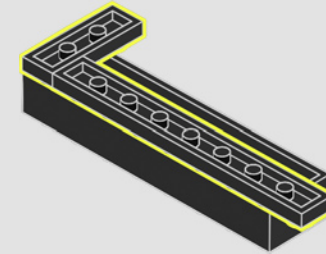
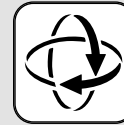

184

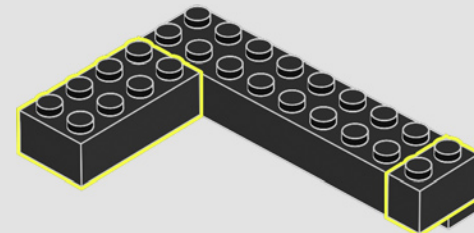
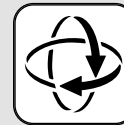

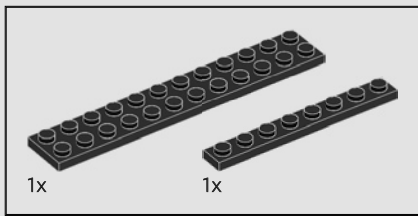

185

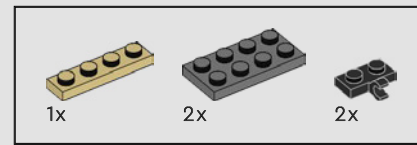
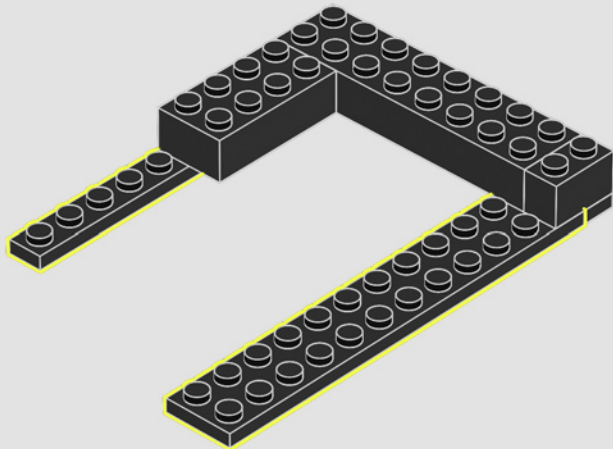

186

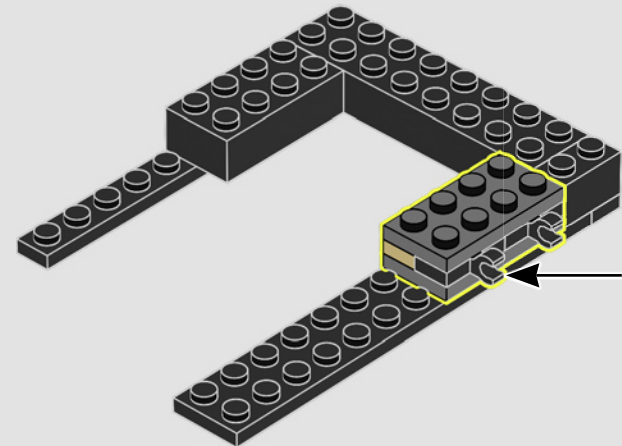
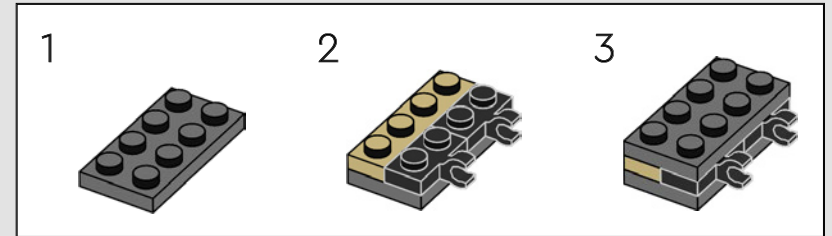

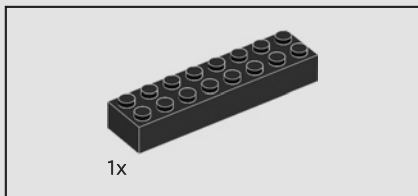

187

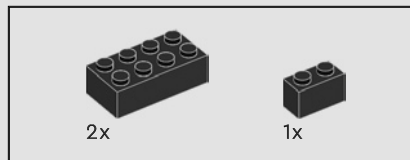
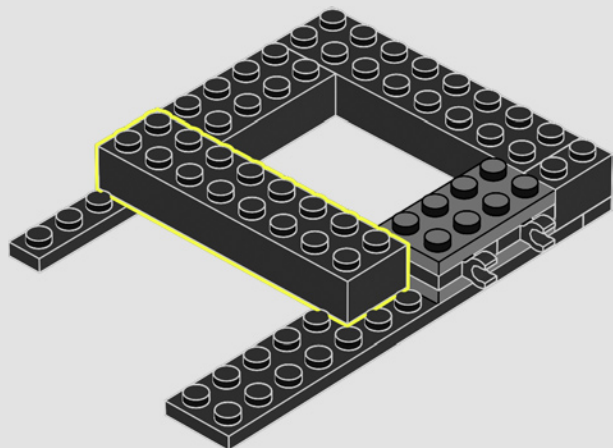

188

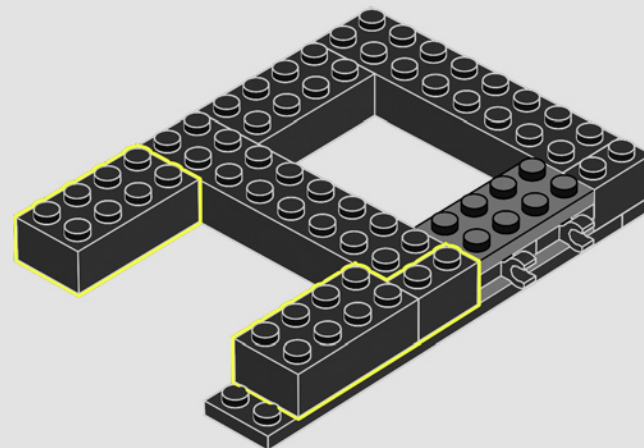

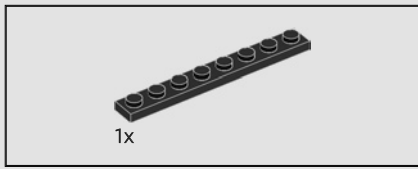

189

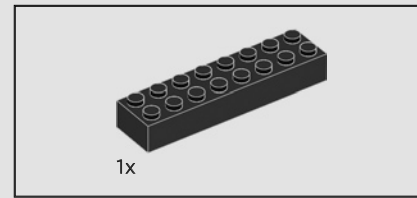
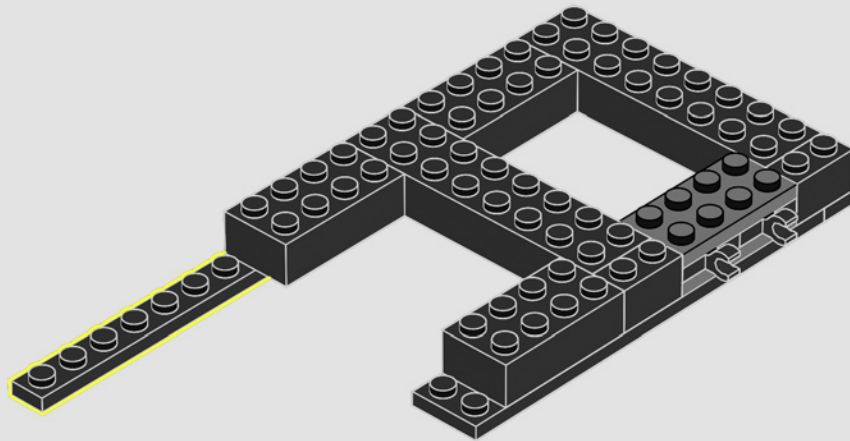

190

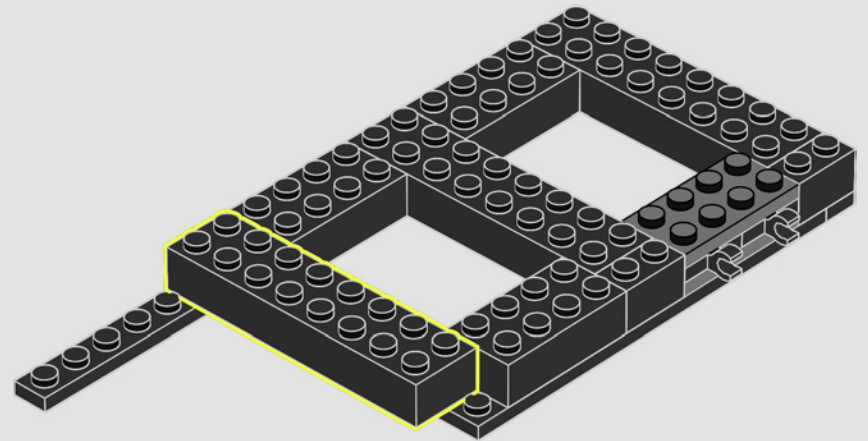



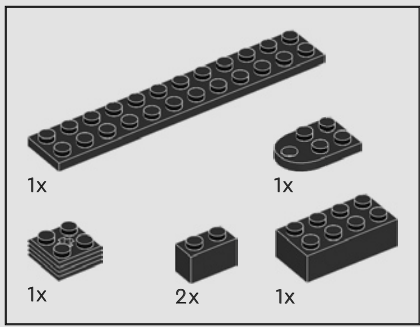

191

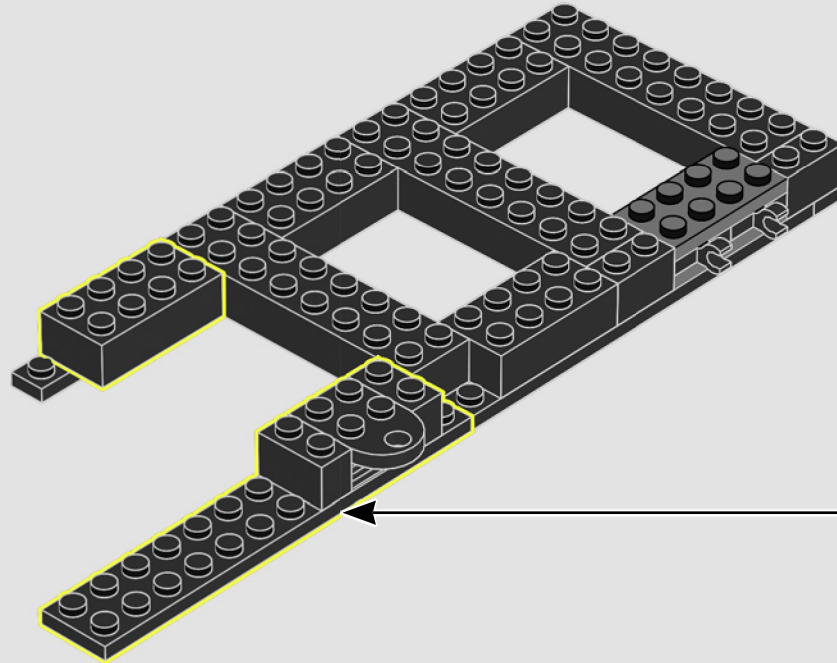
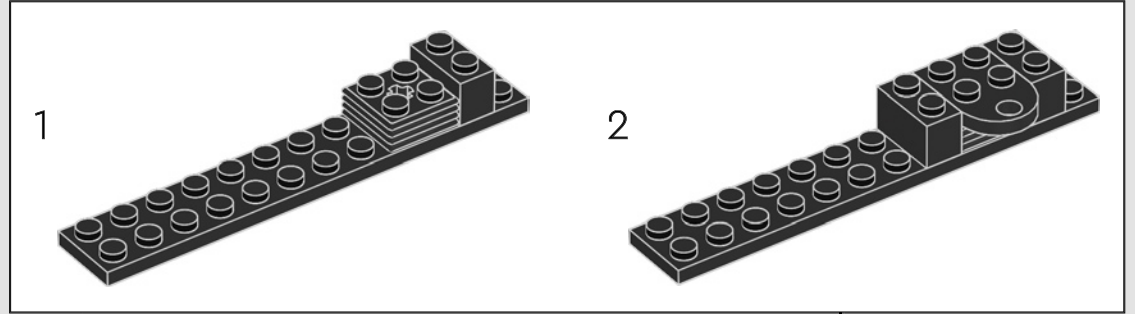

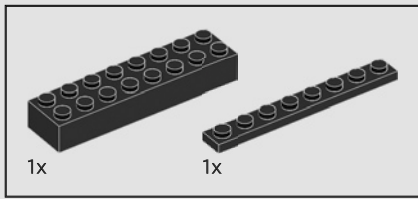

192

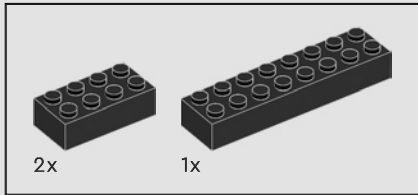
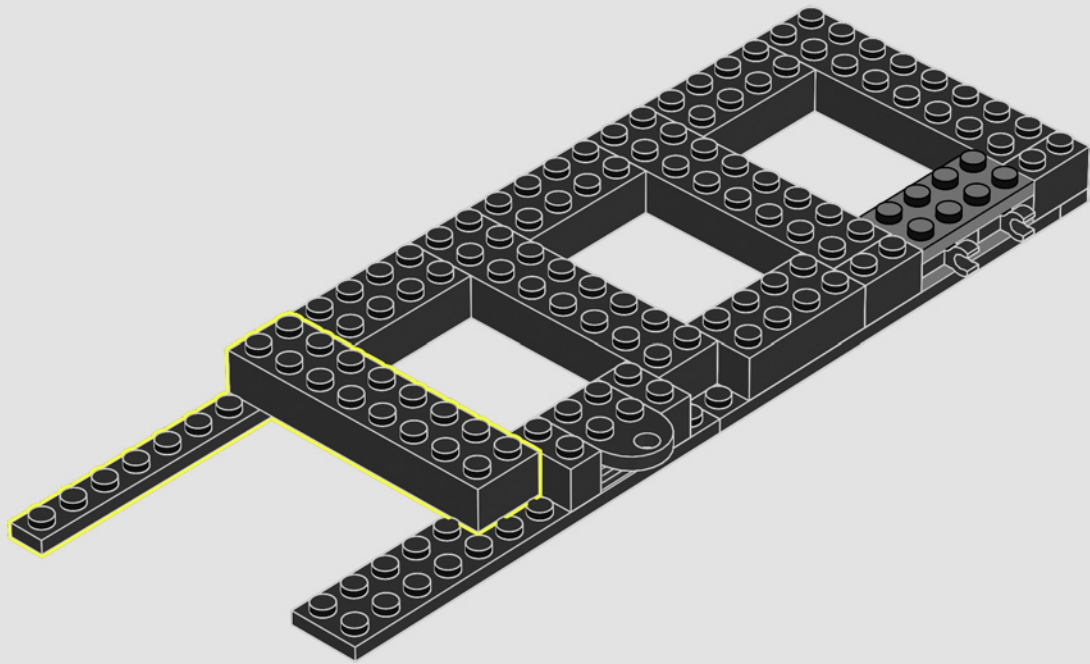

193

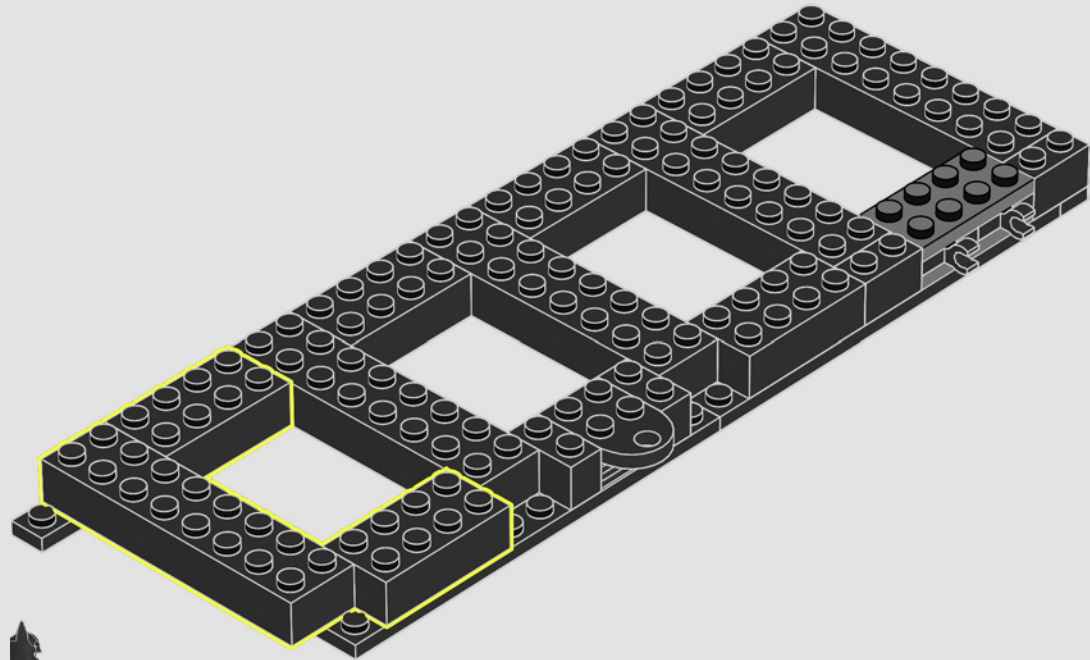

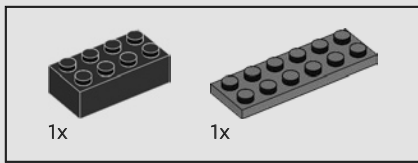

194

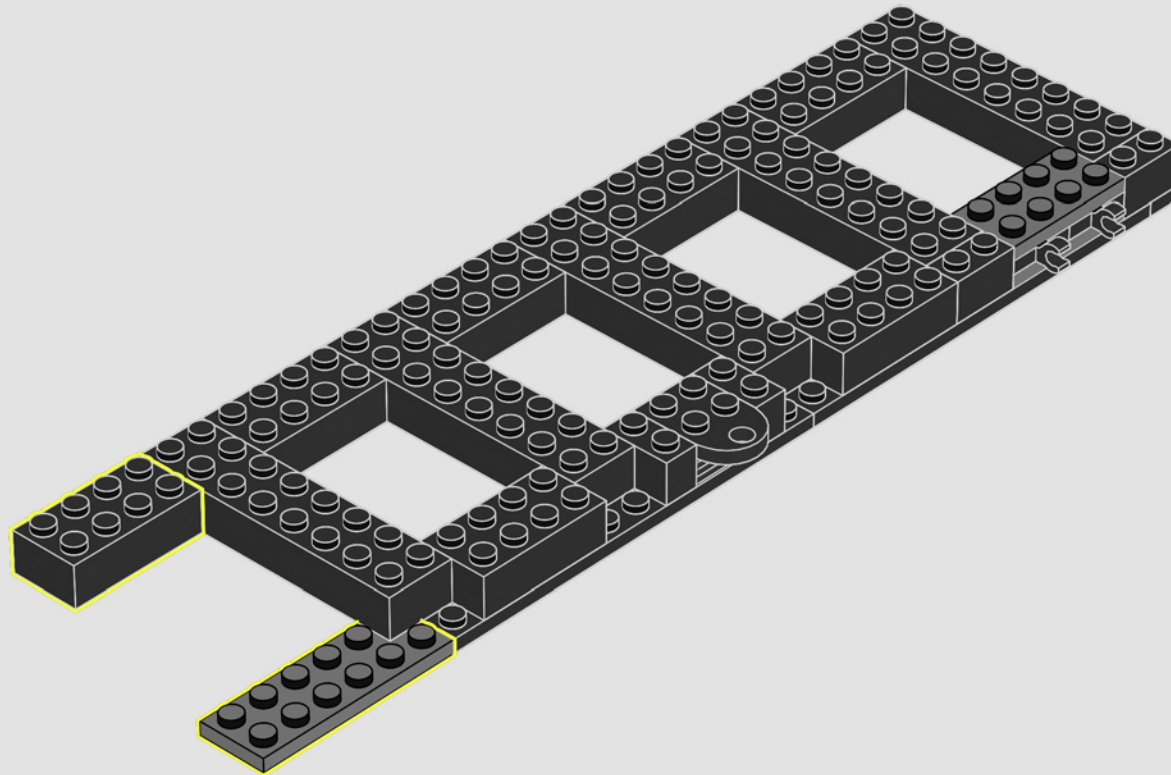

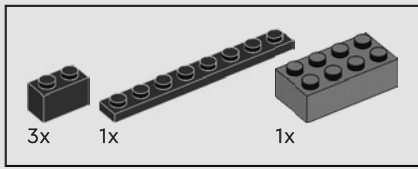

195

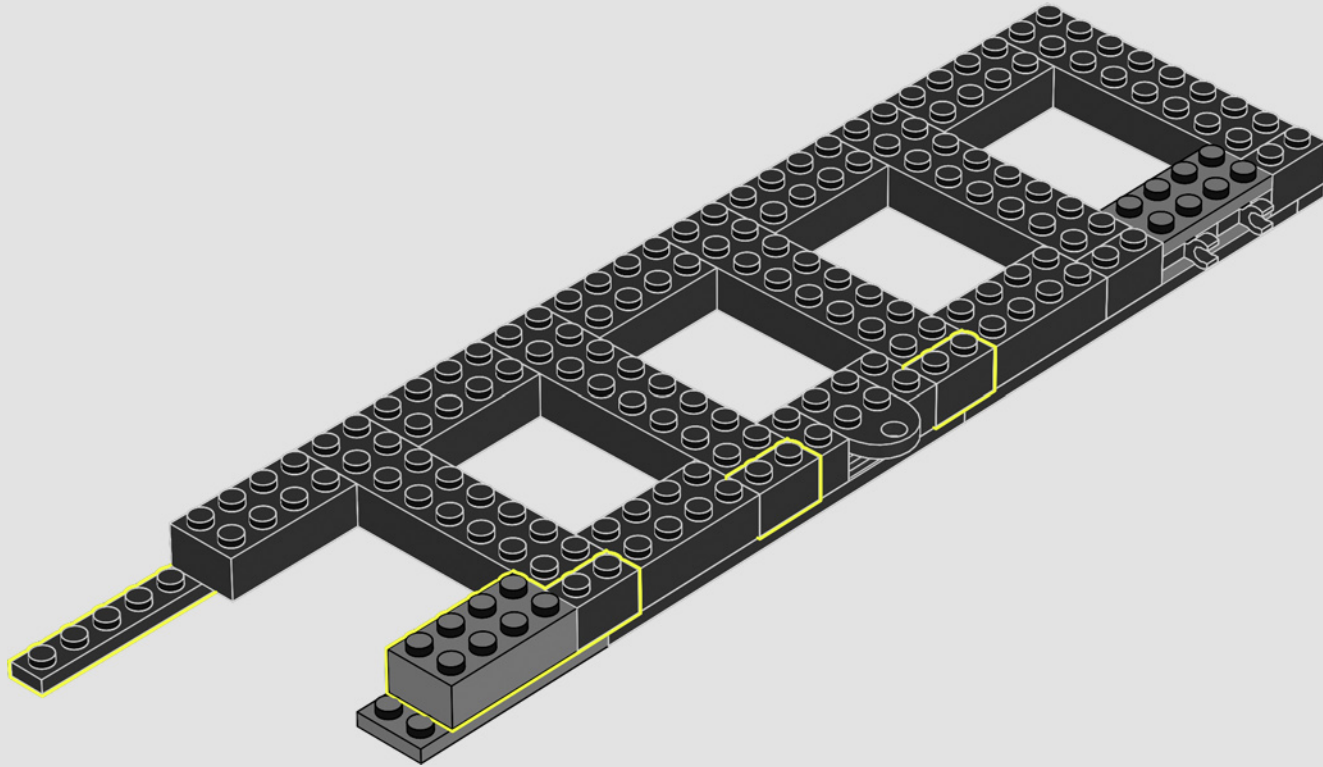

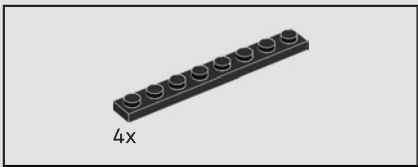

196

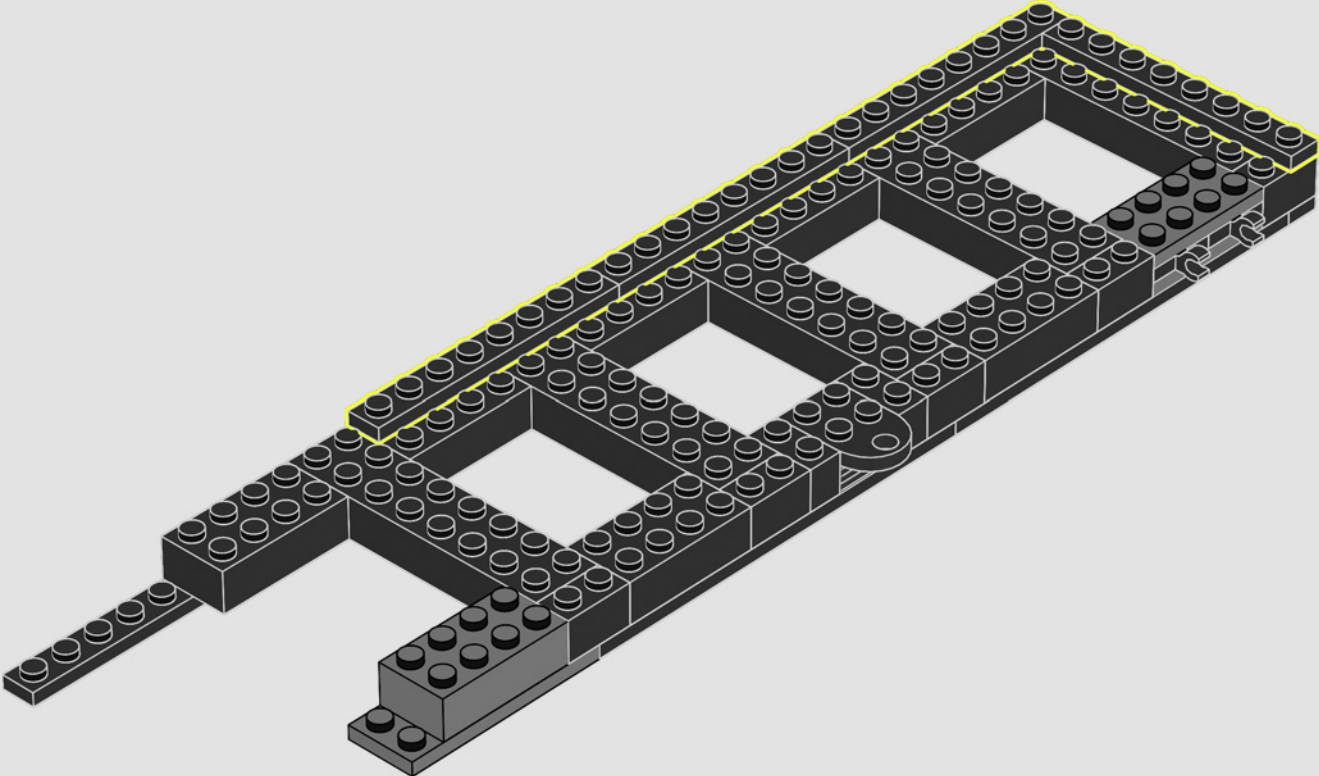



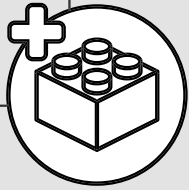
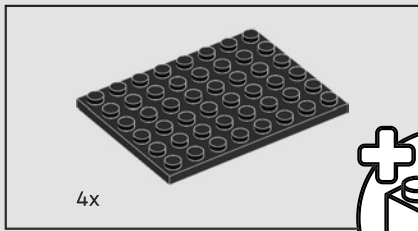

197

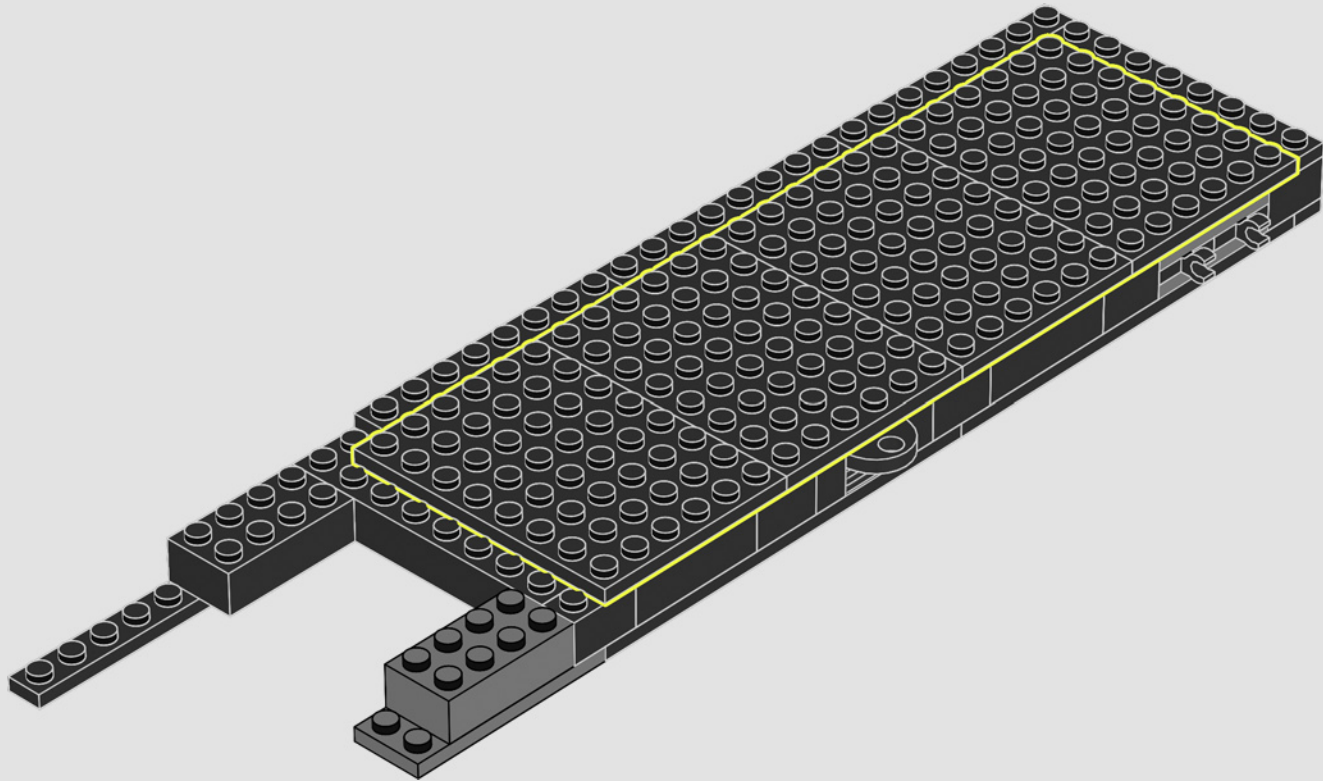

198

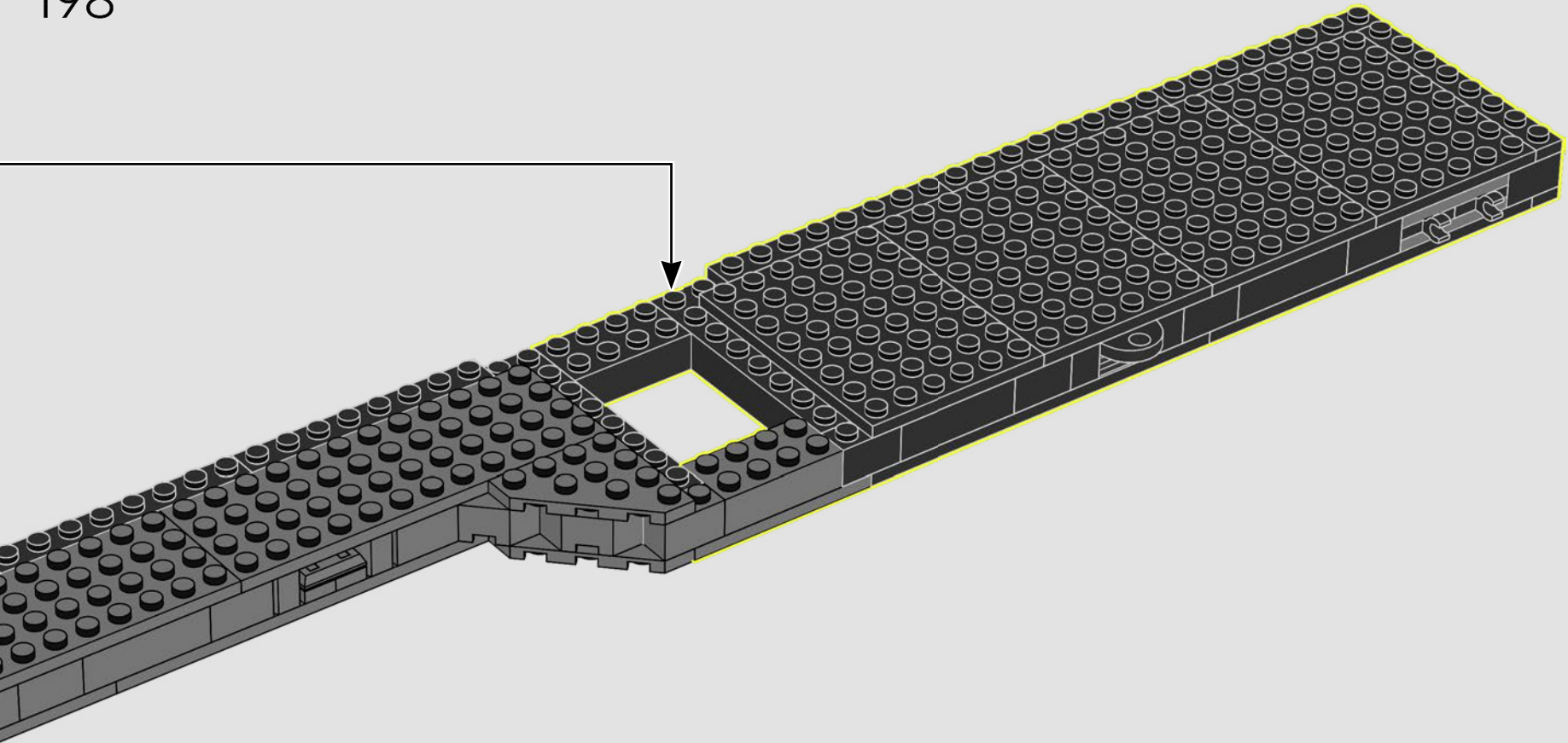

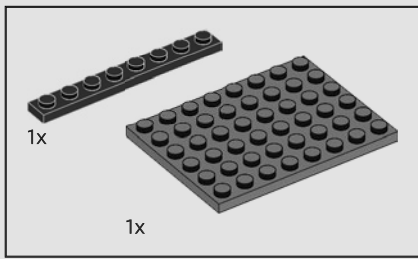

199

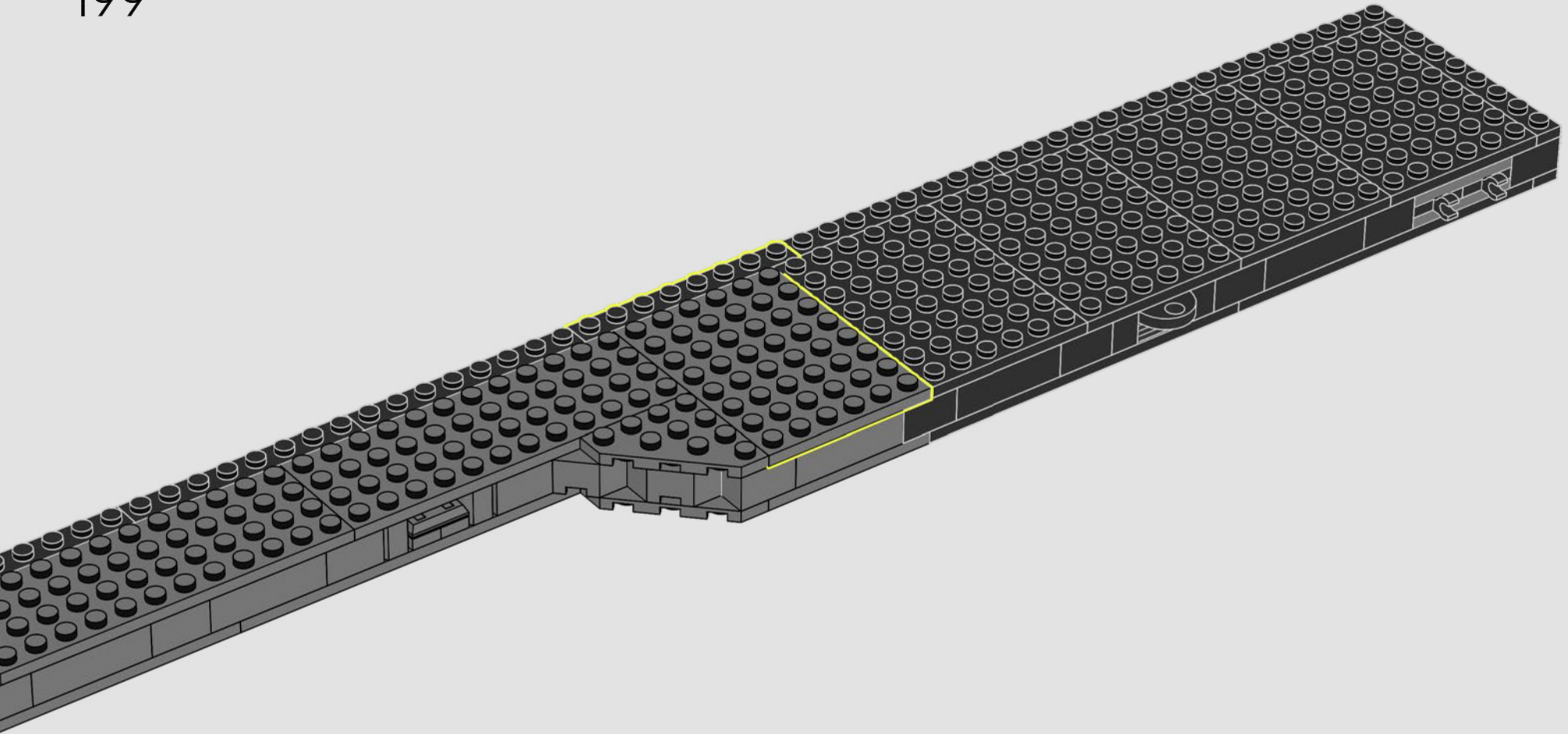

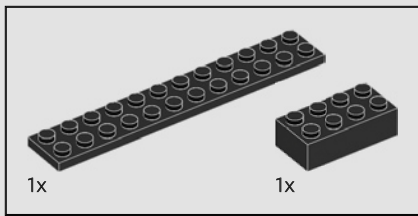

200

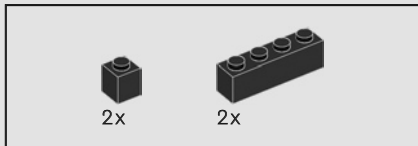
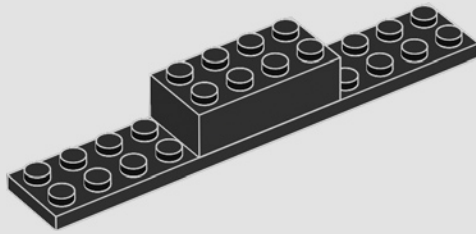

201

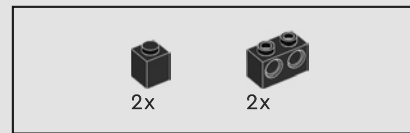
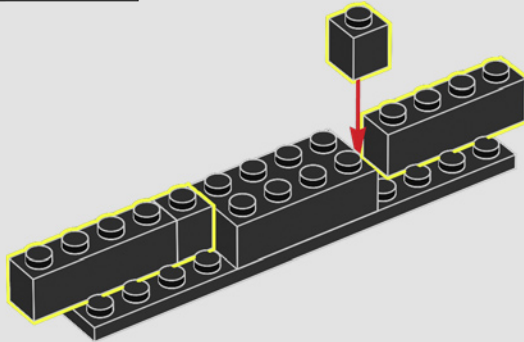

202

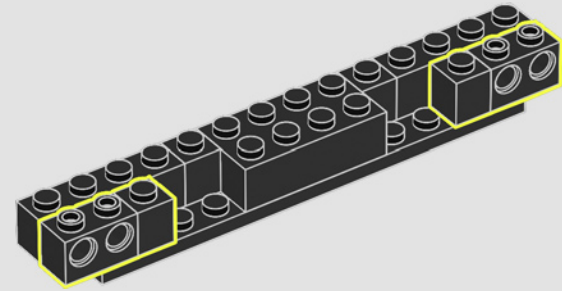

203

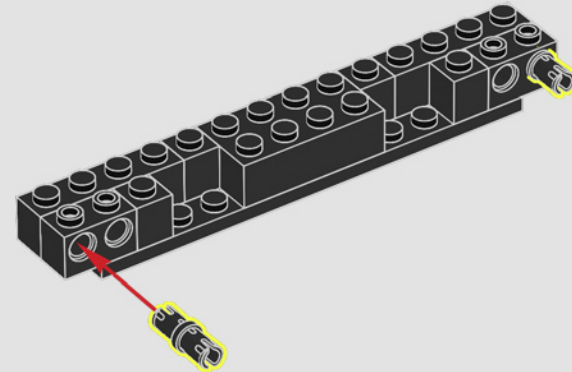

204

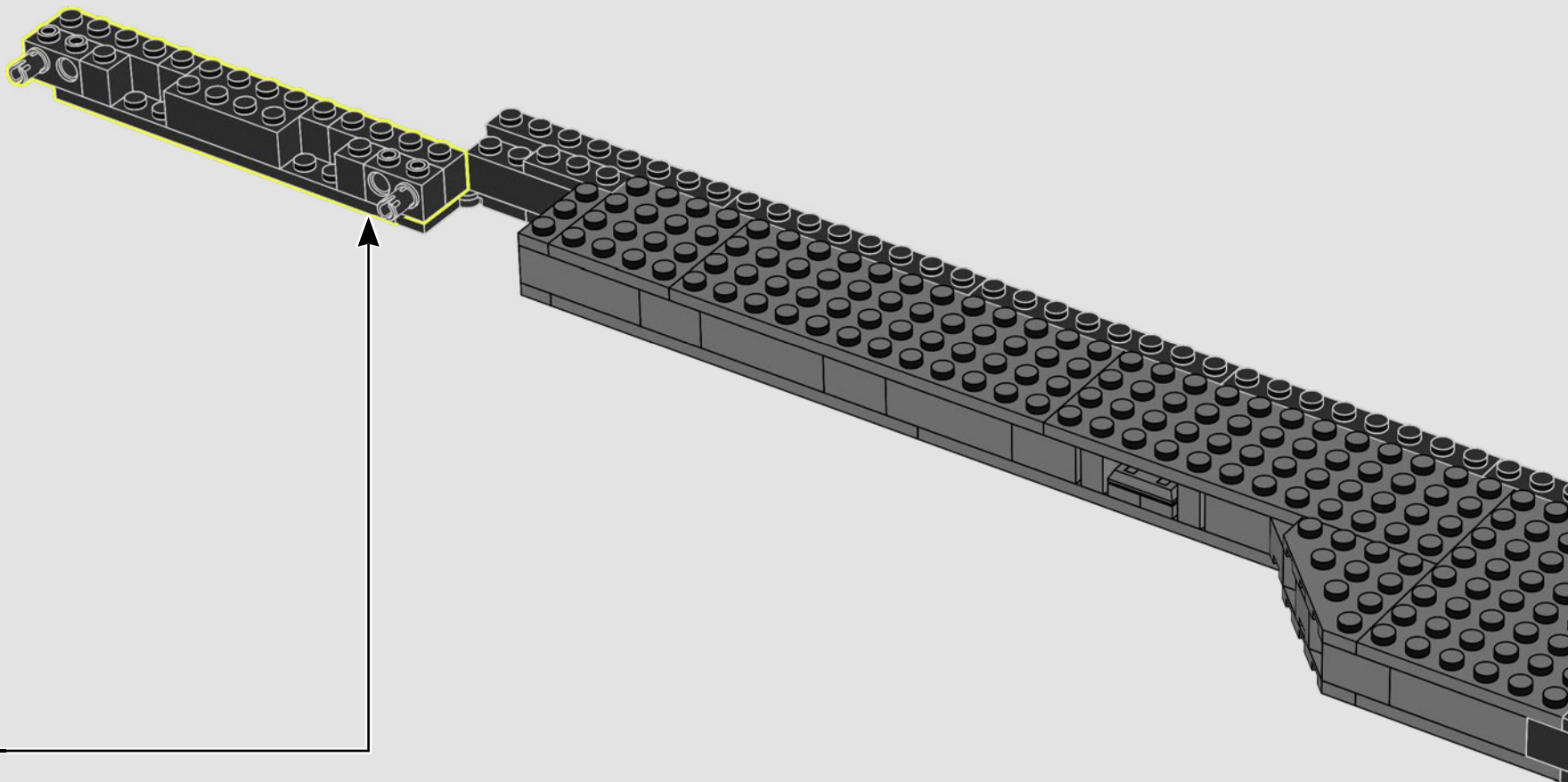



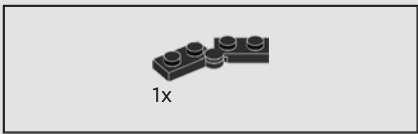

205

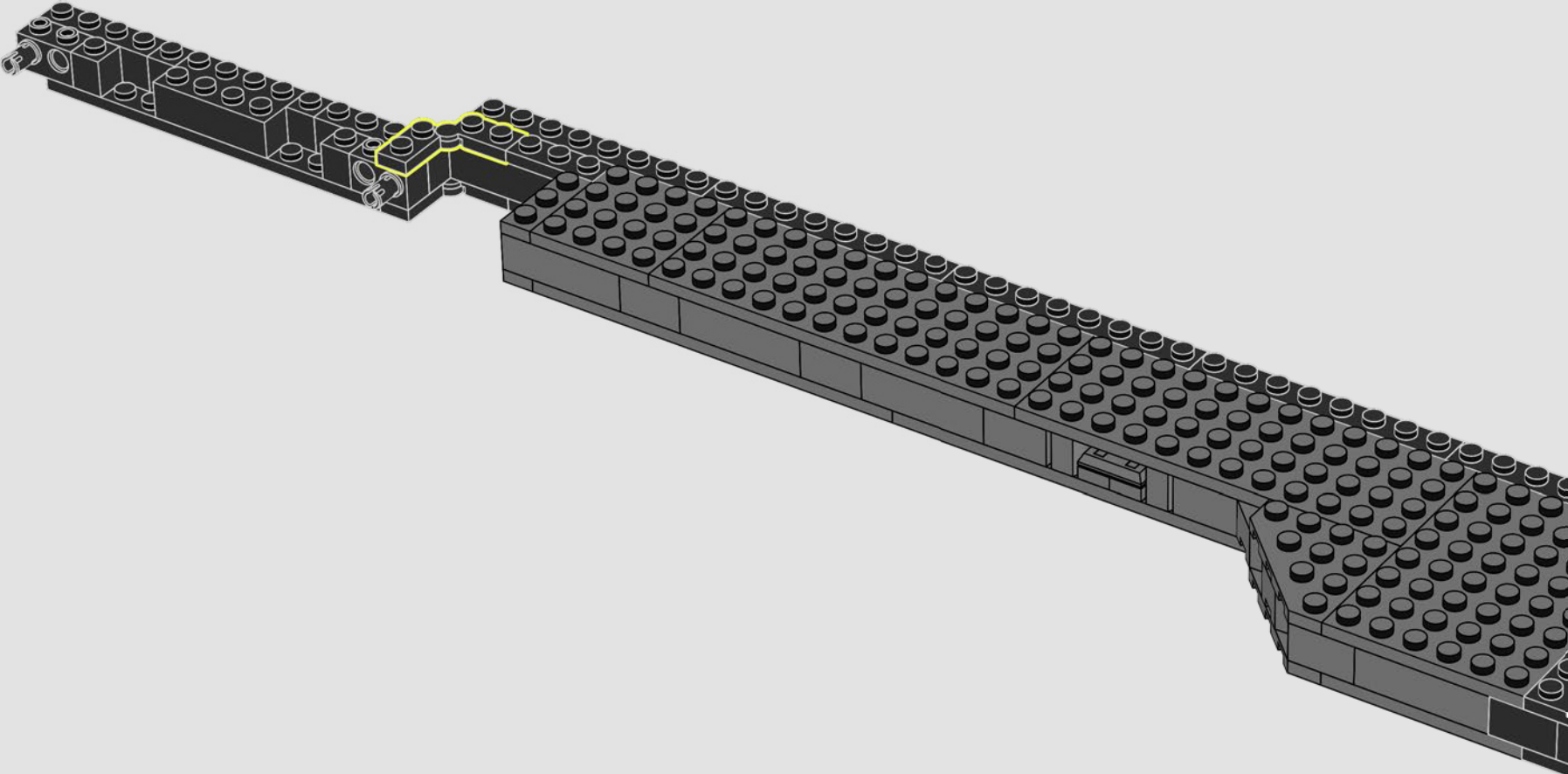

206

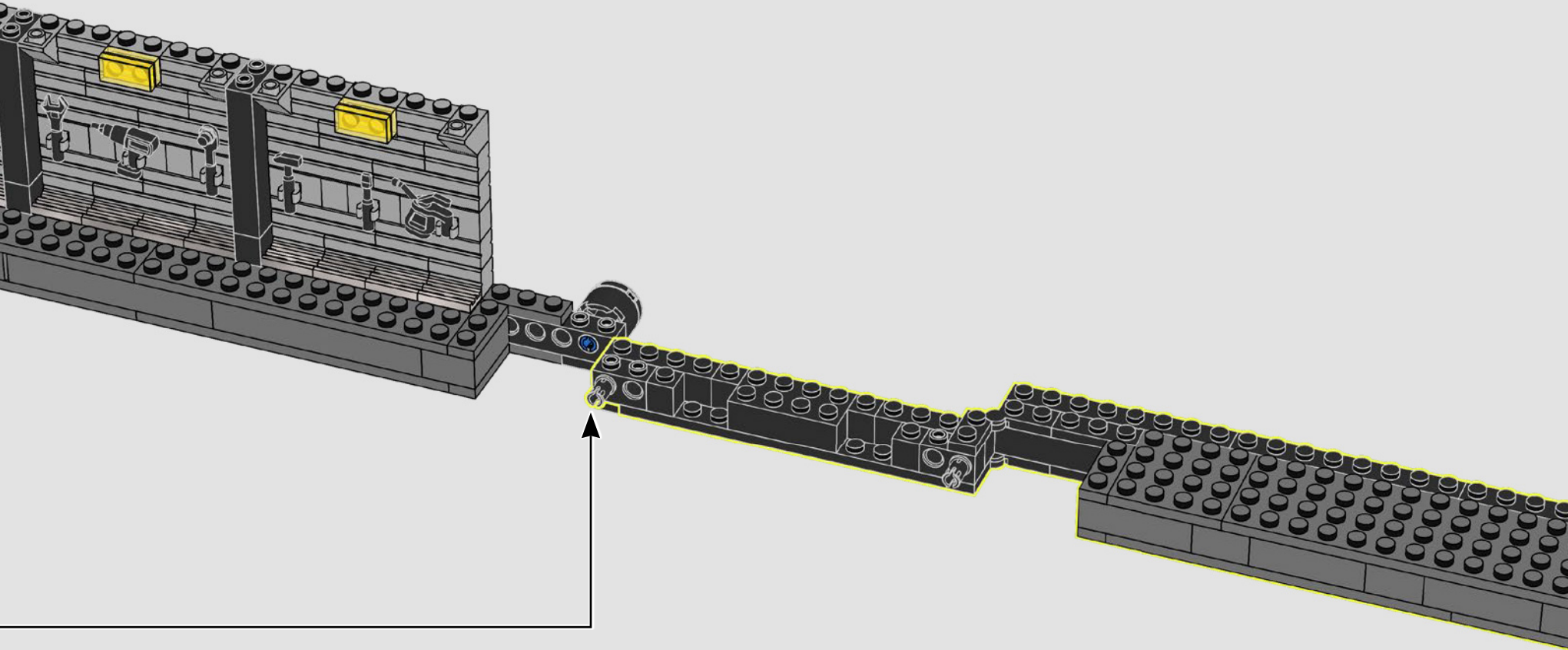

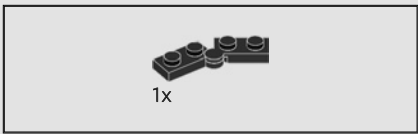

207

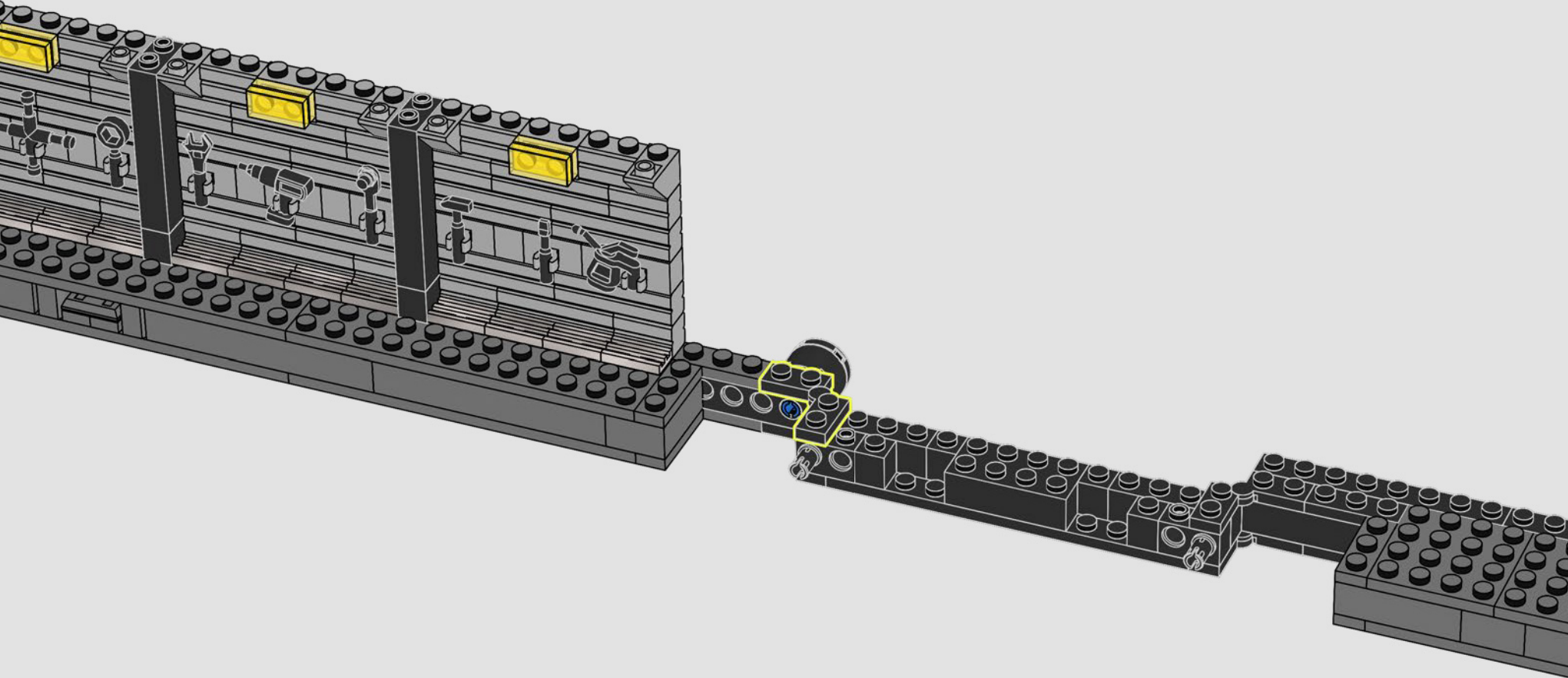



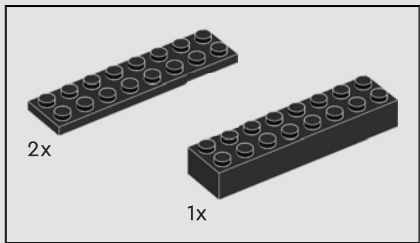
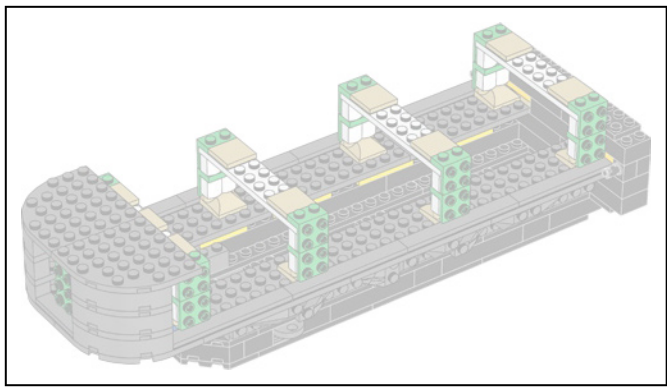

208

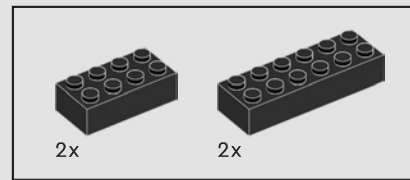
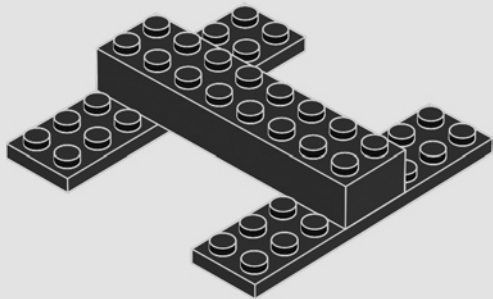

209

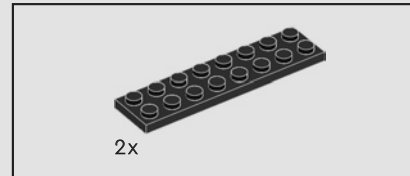
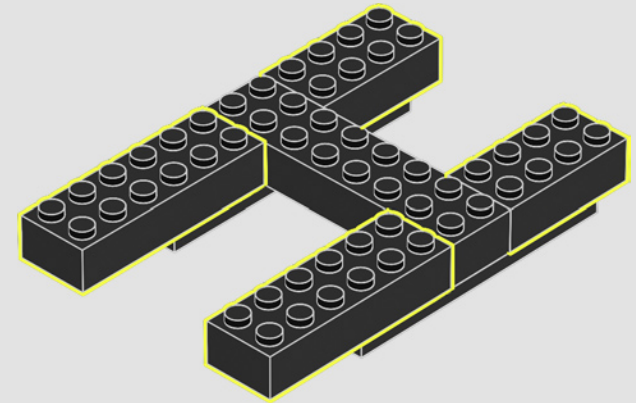

210

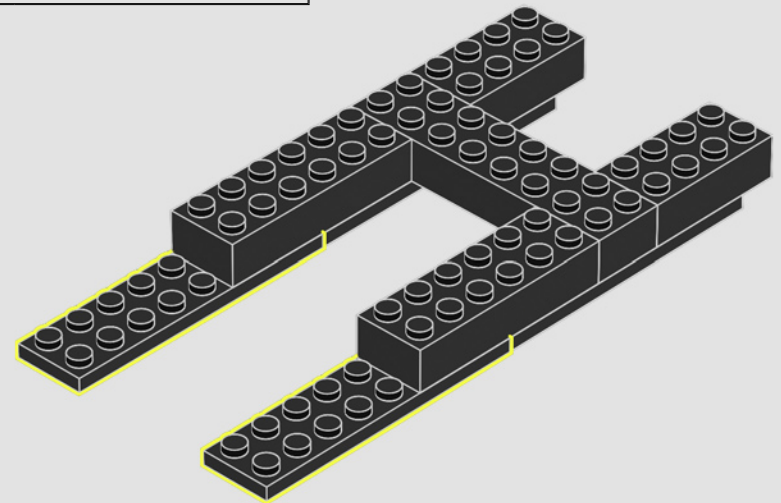



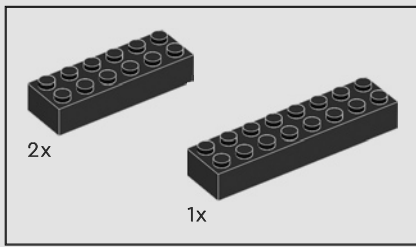

211

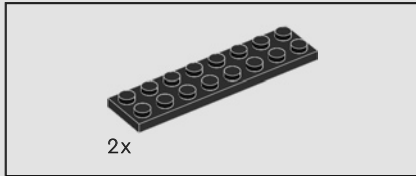
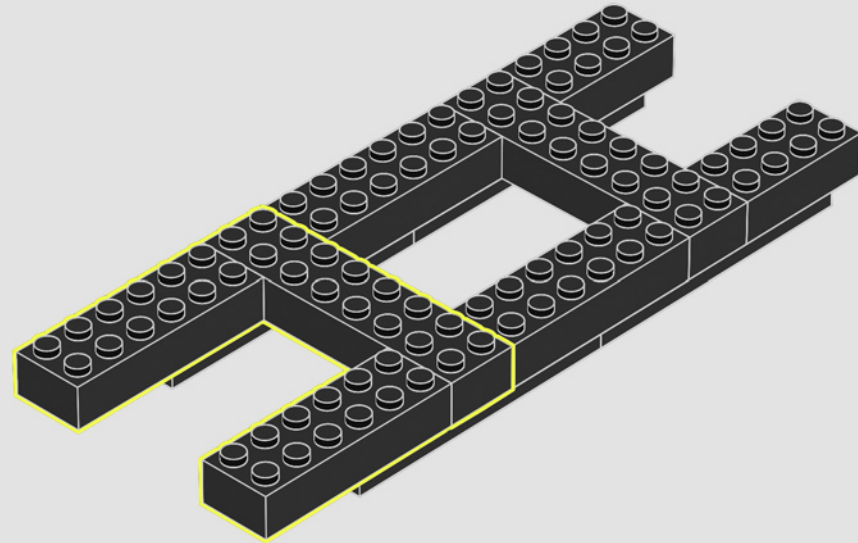

212

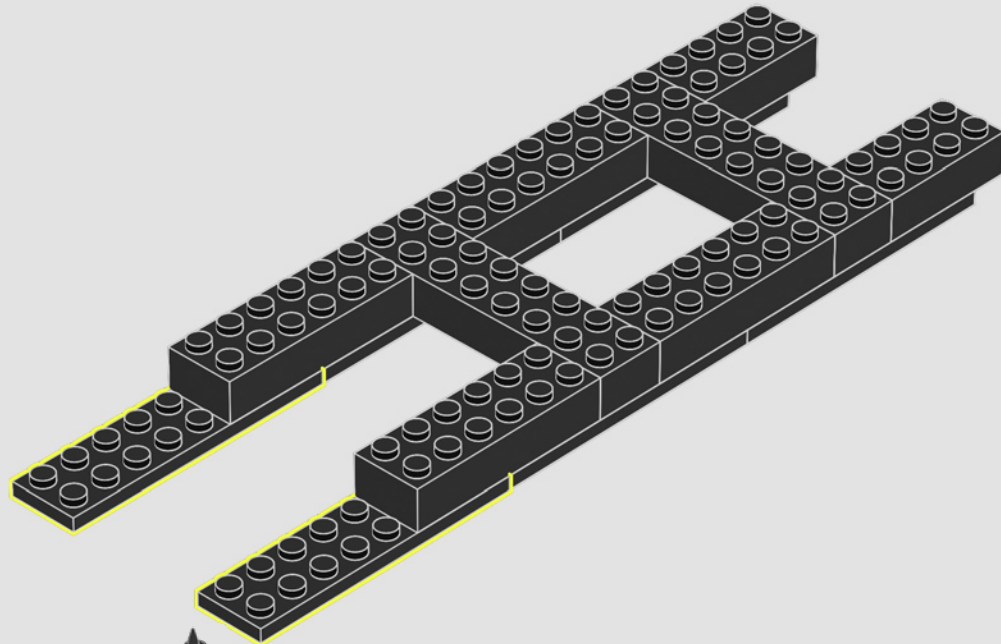

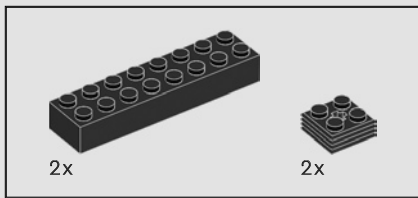

213

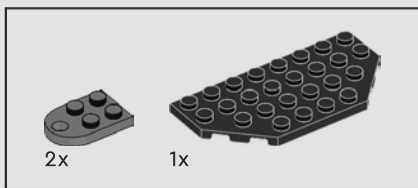
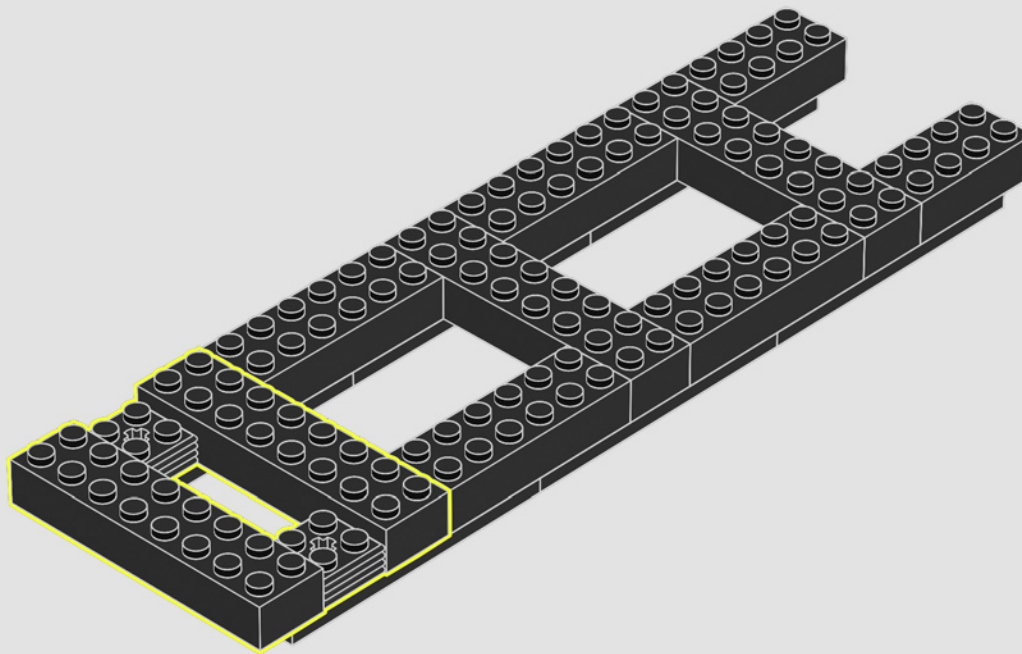

214

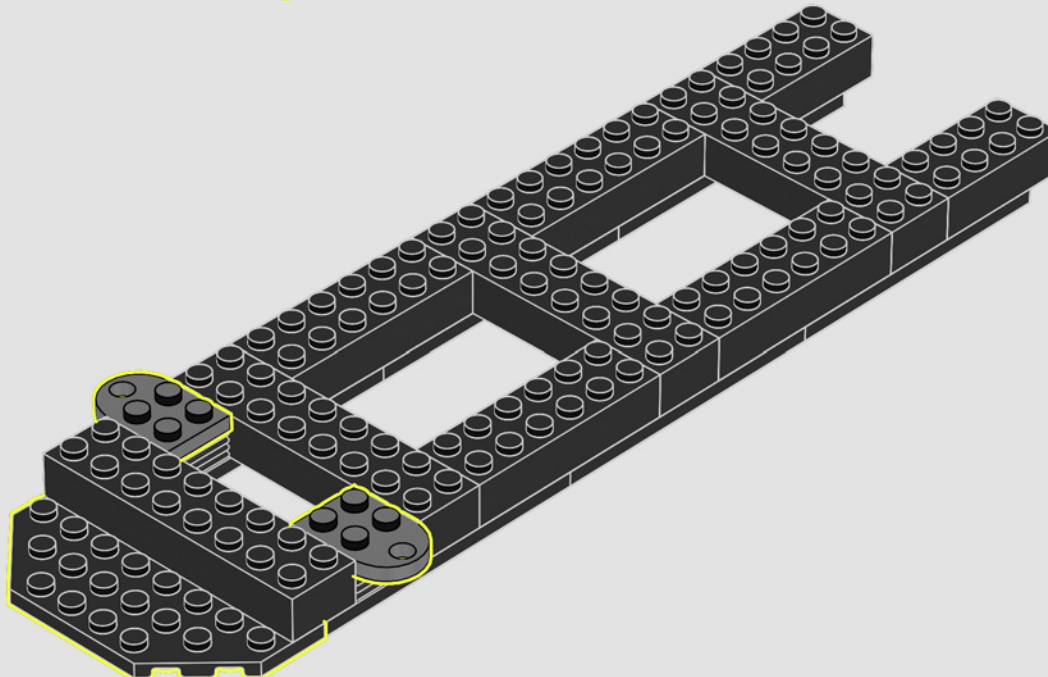

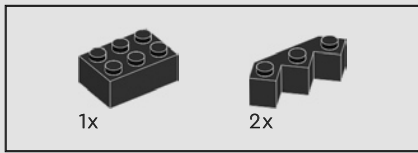

215

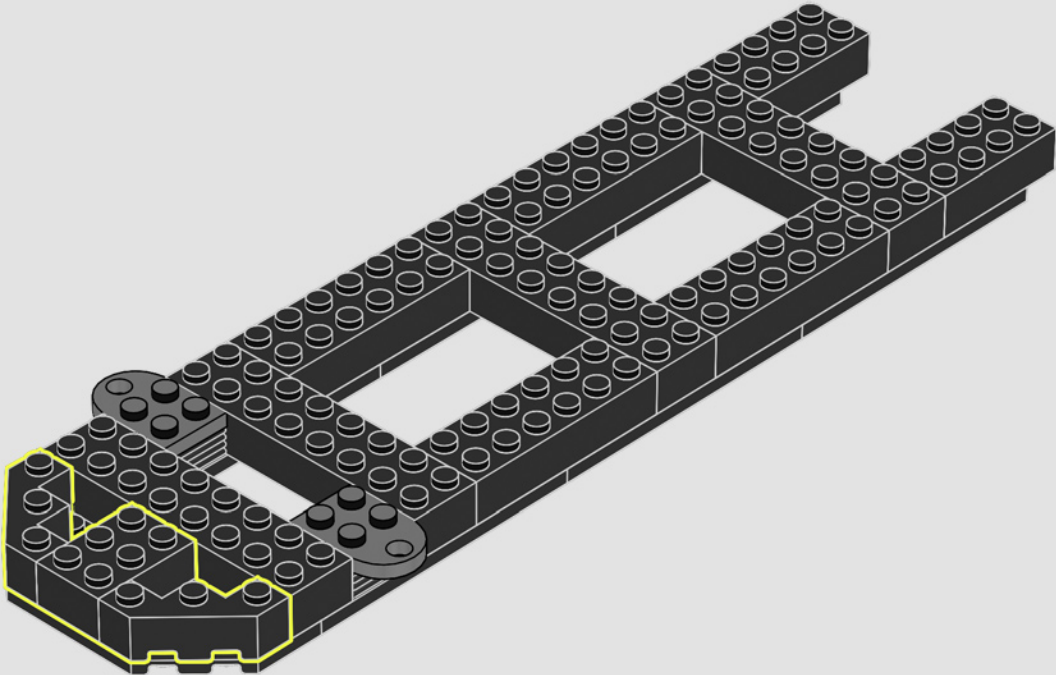

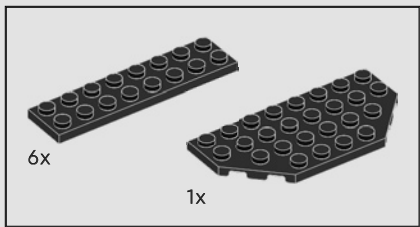

216

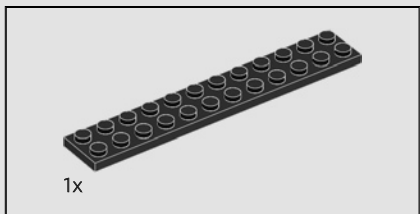
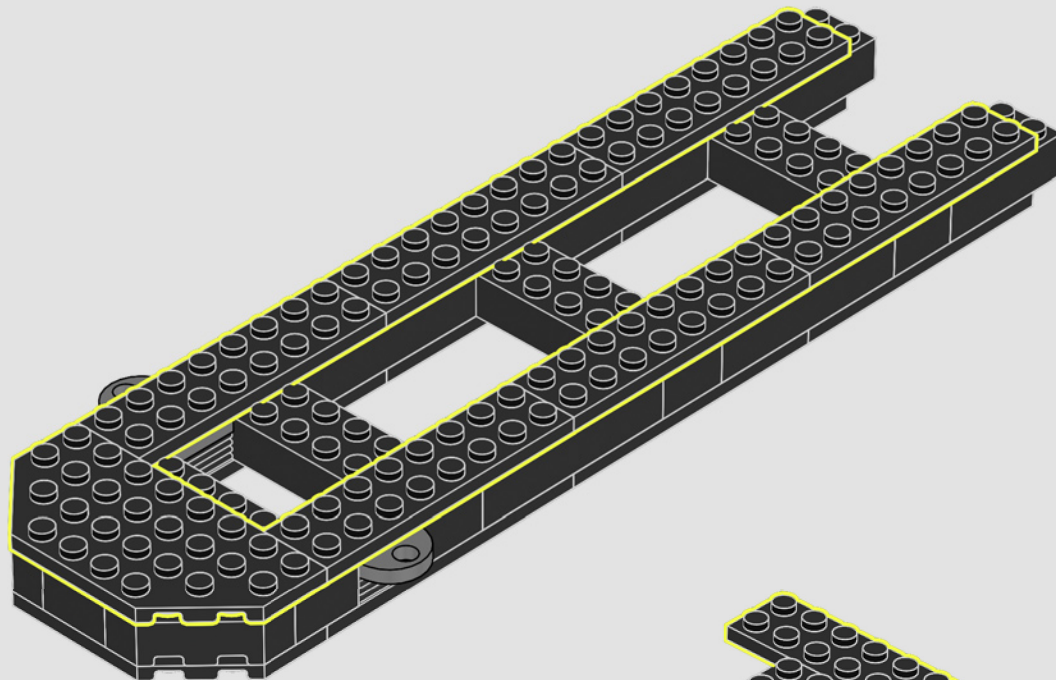

217

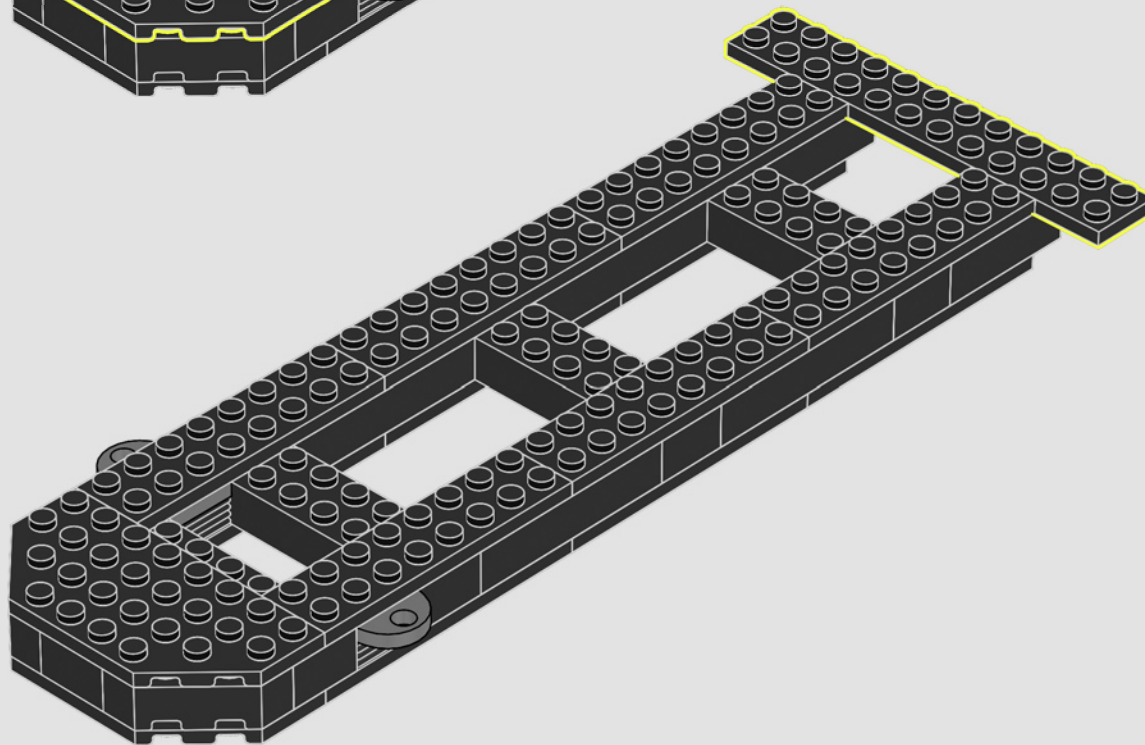

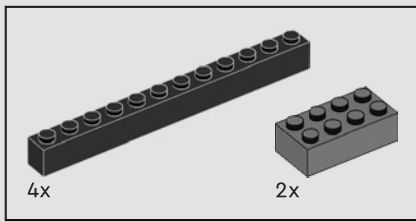

218

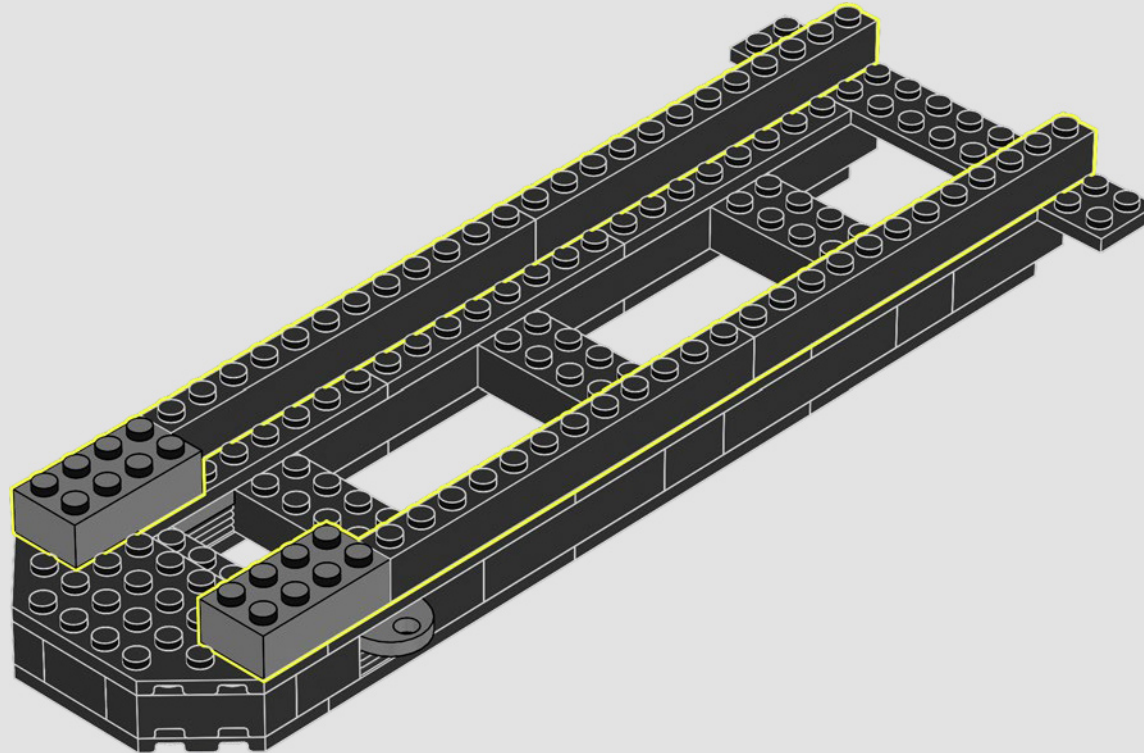



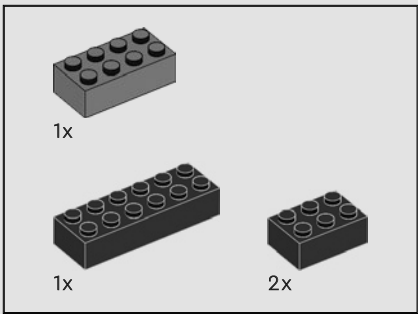

219

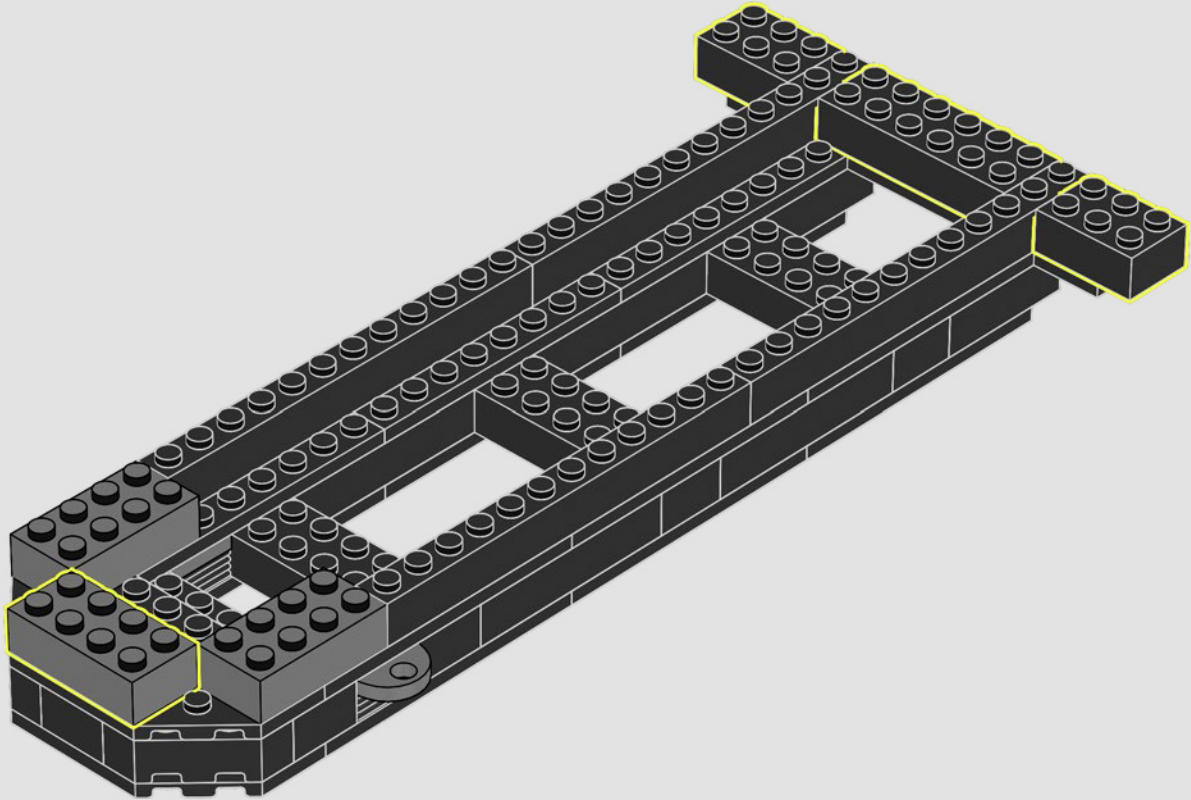

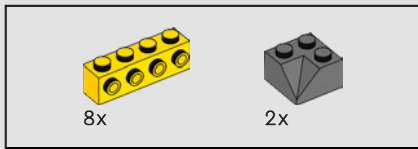

220

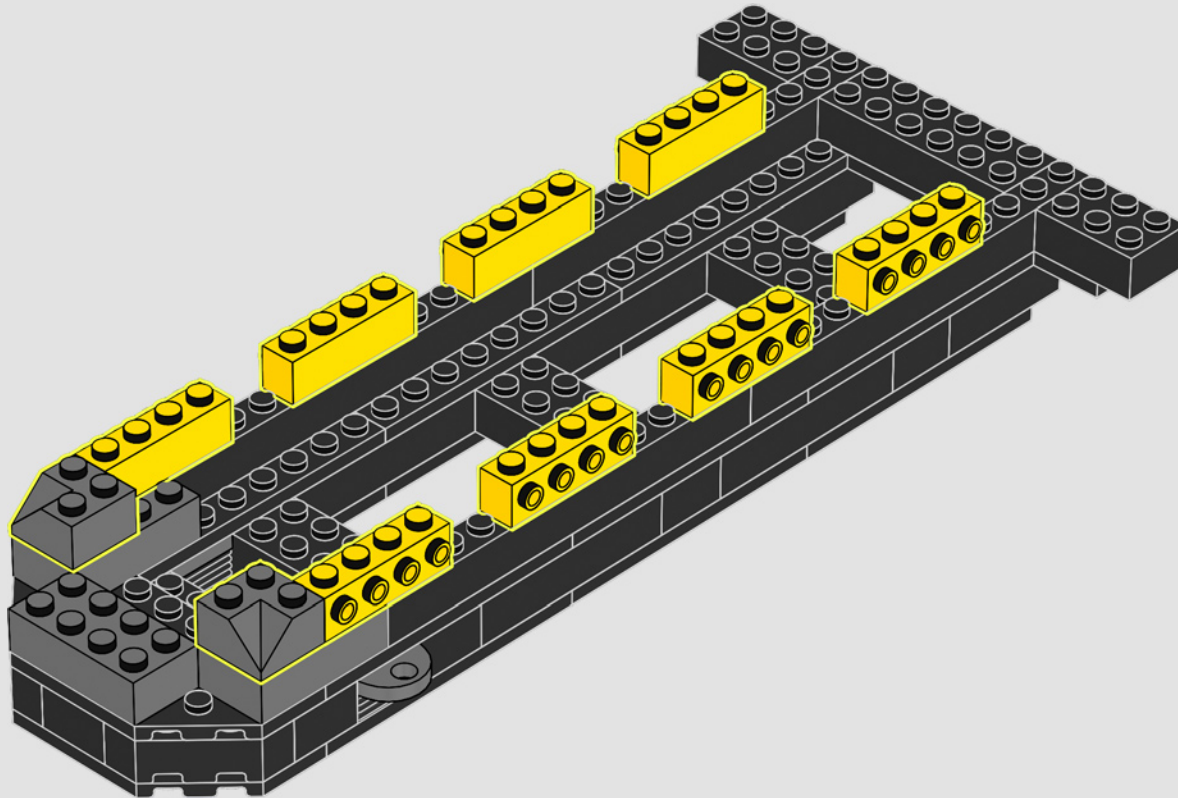

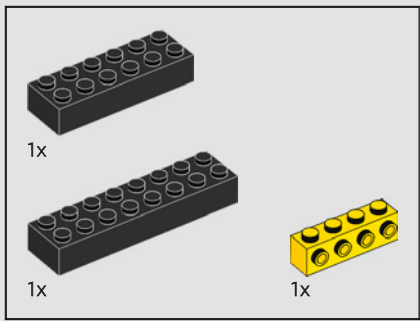

221

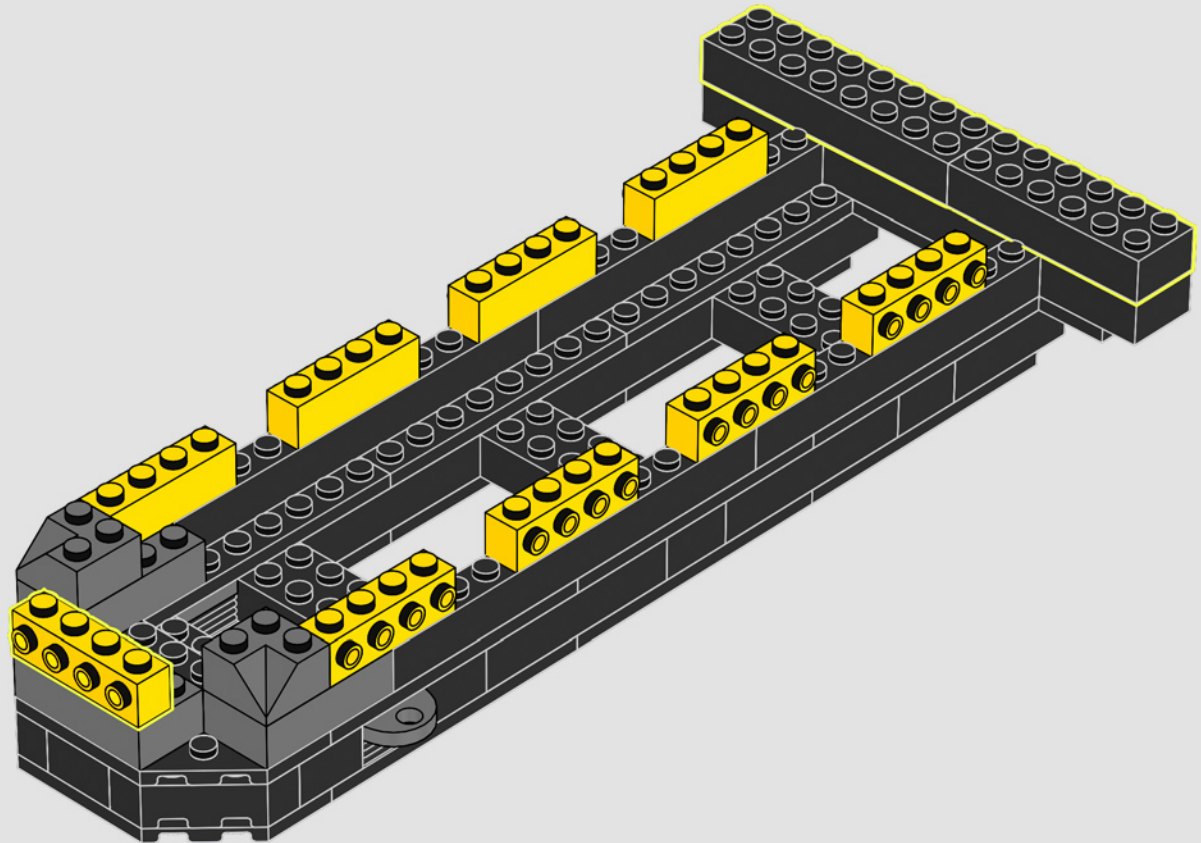

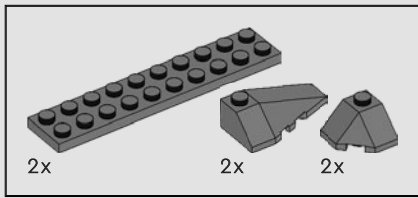

222

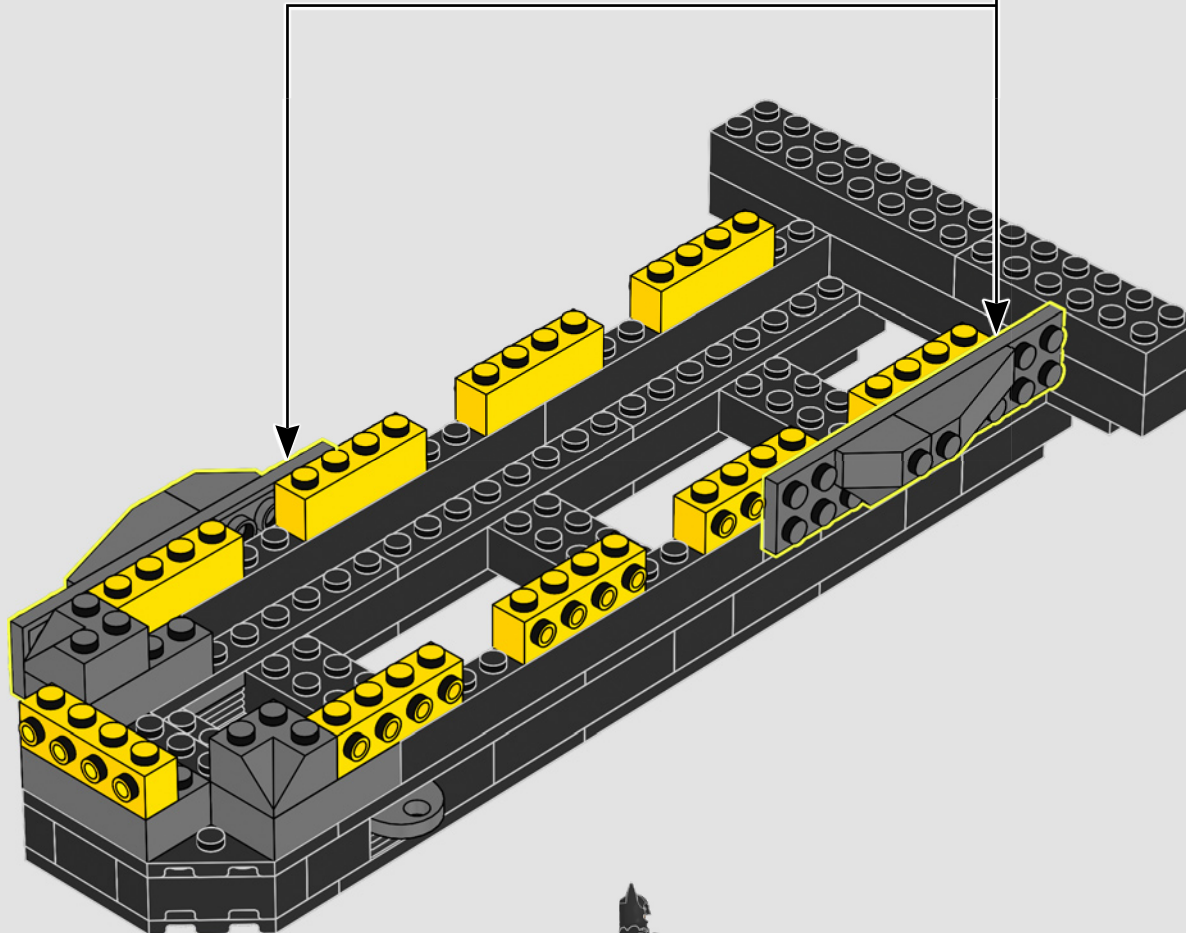
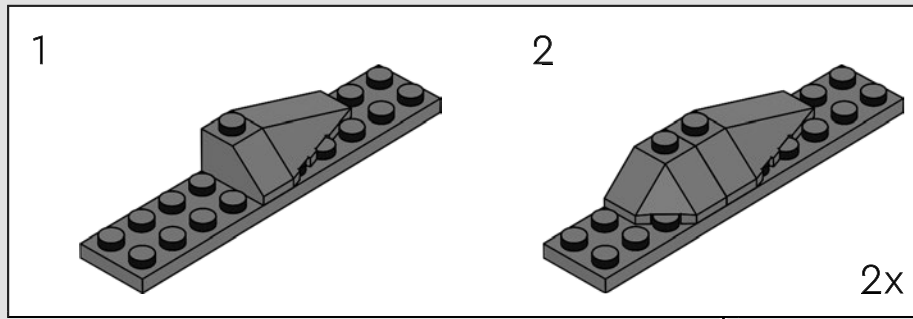

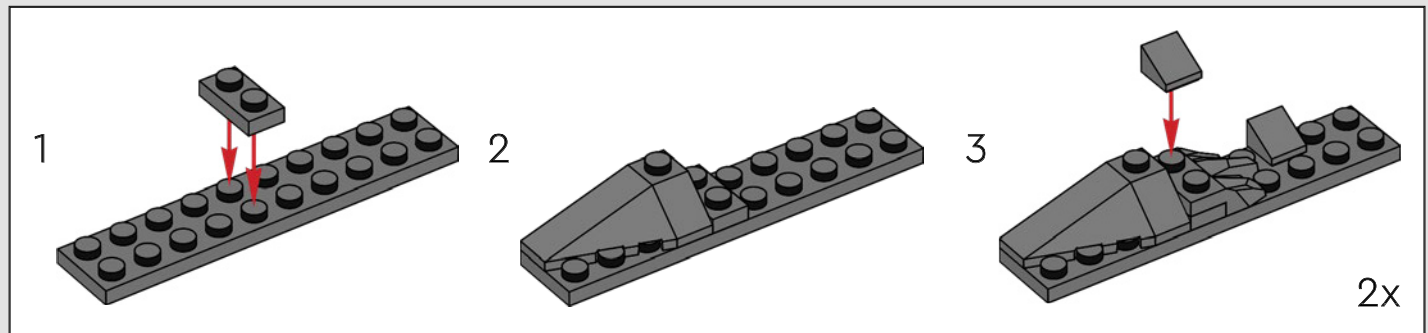
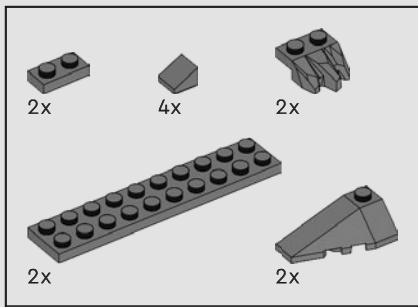

223

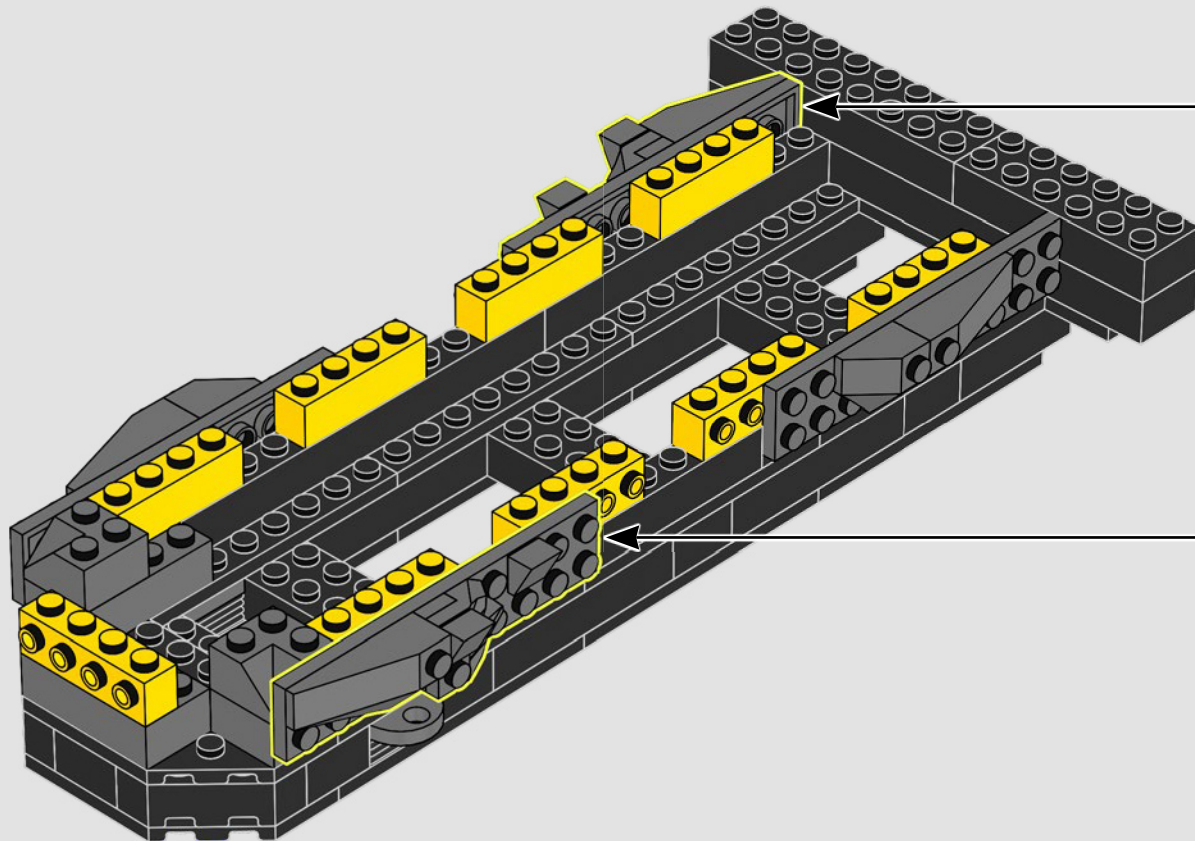



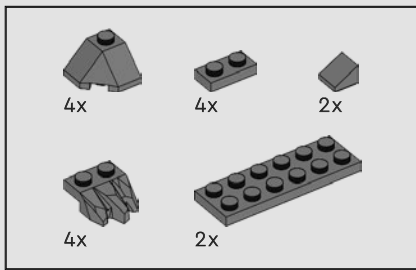

224

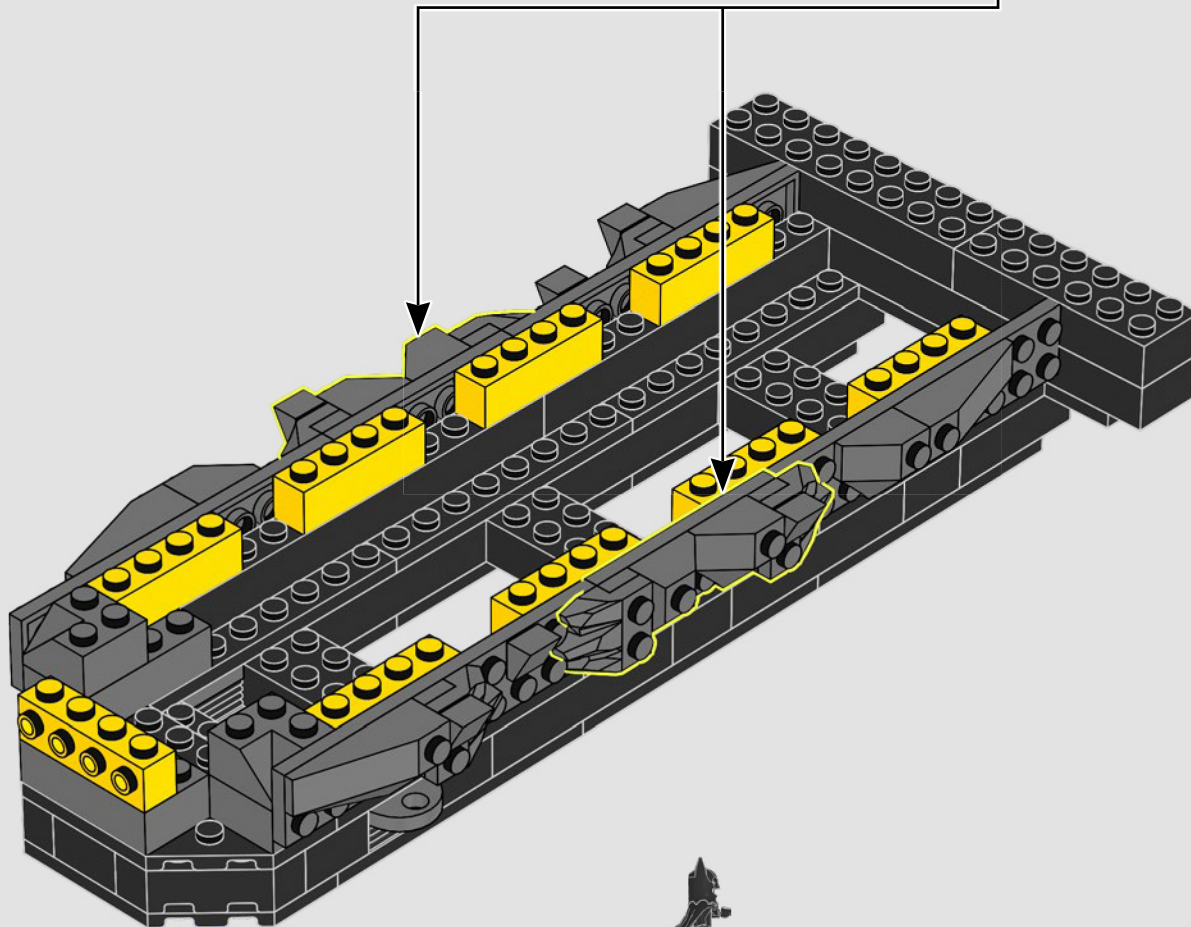
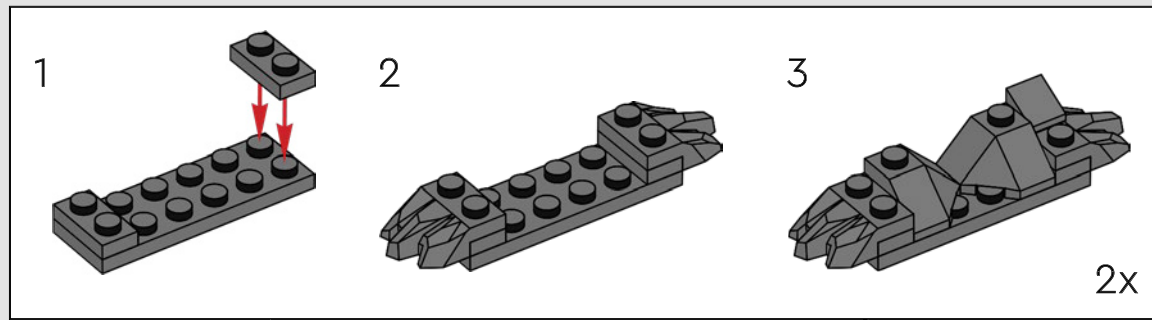



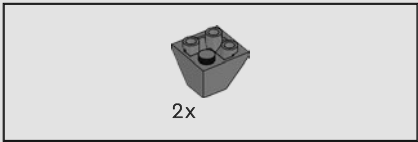

225

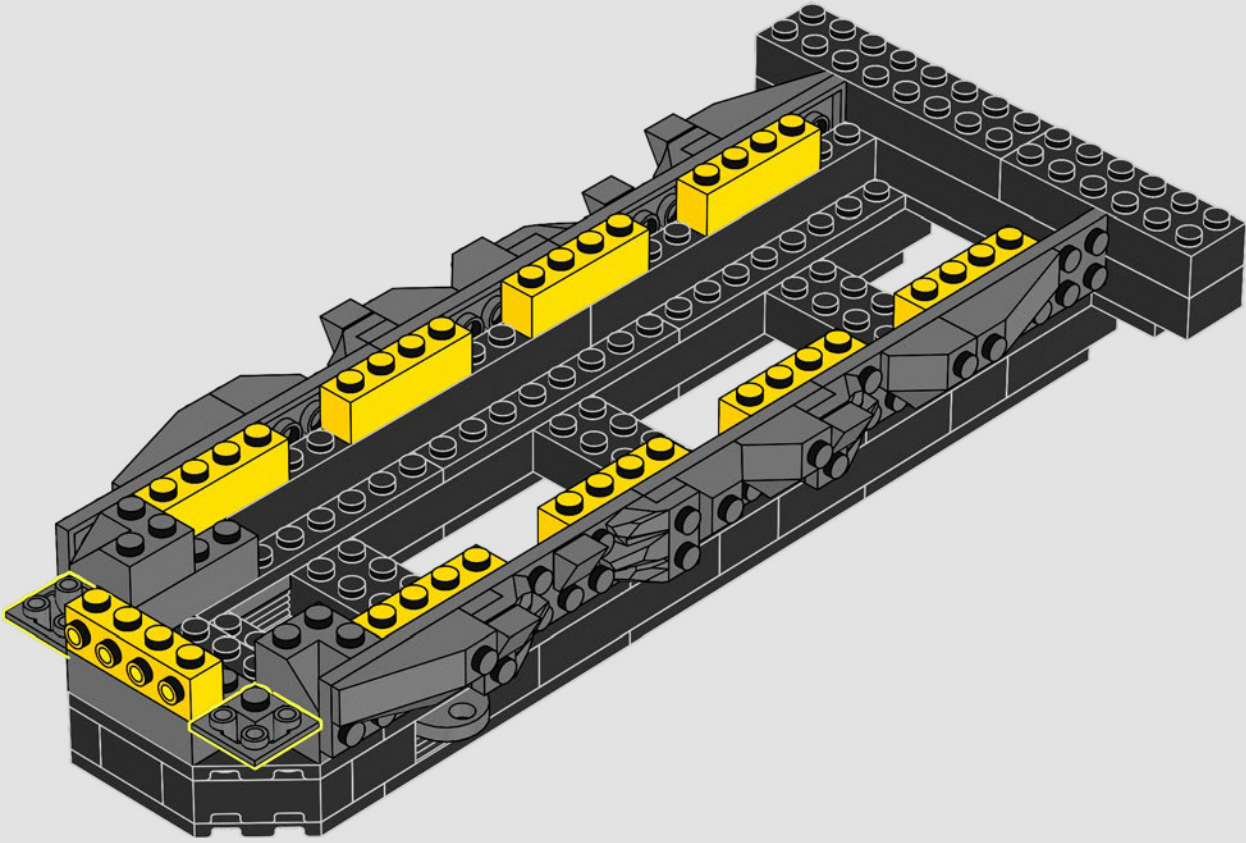

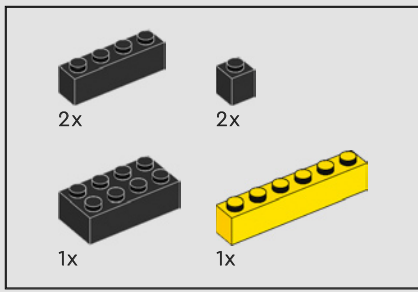

226

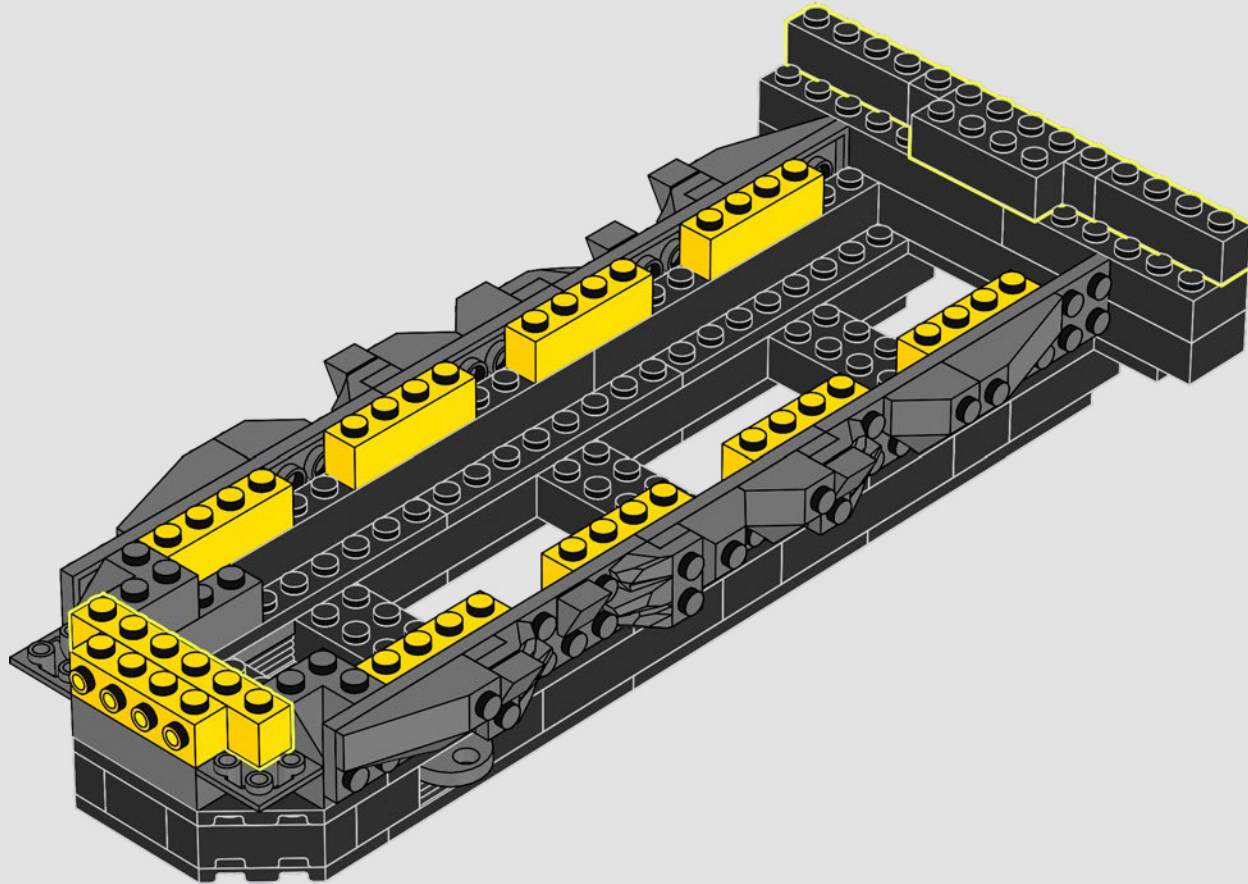



227

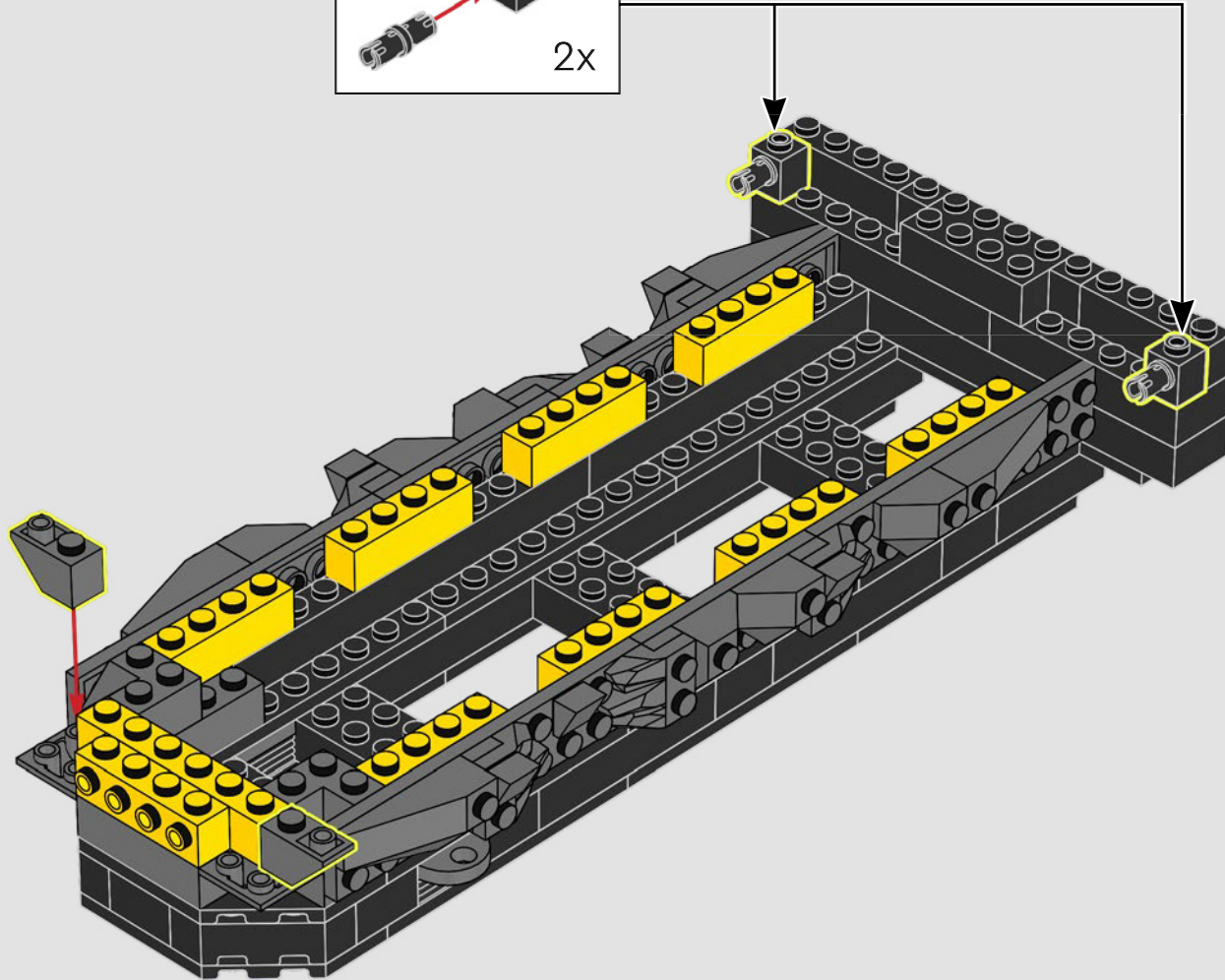
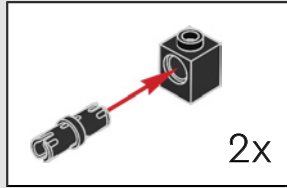



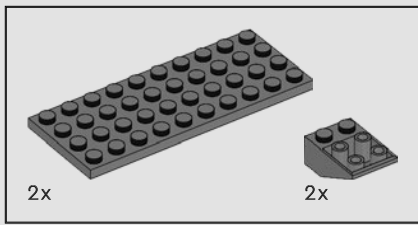

228

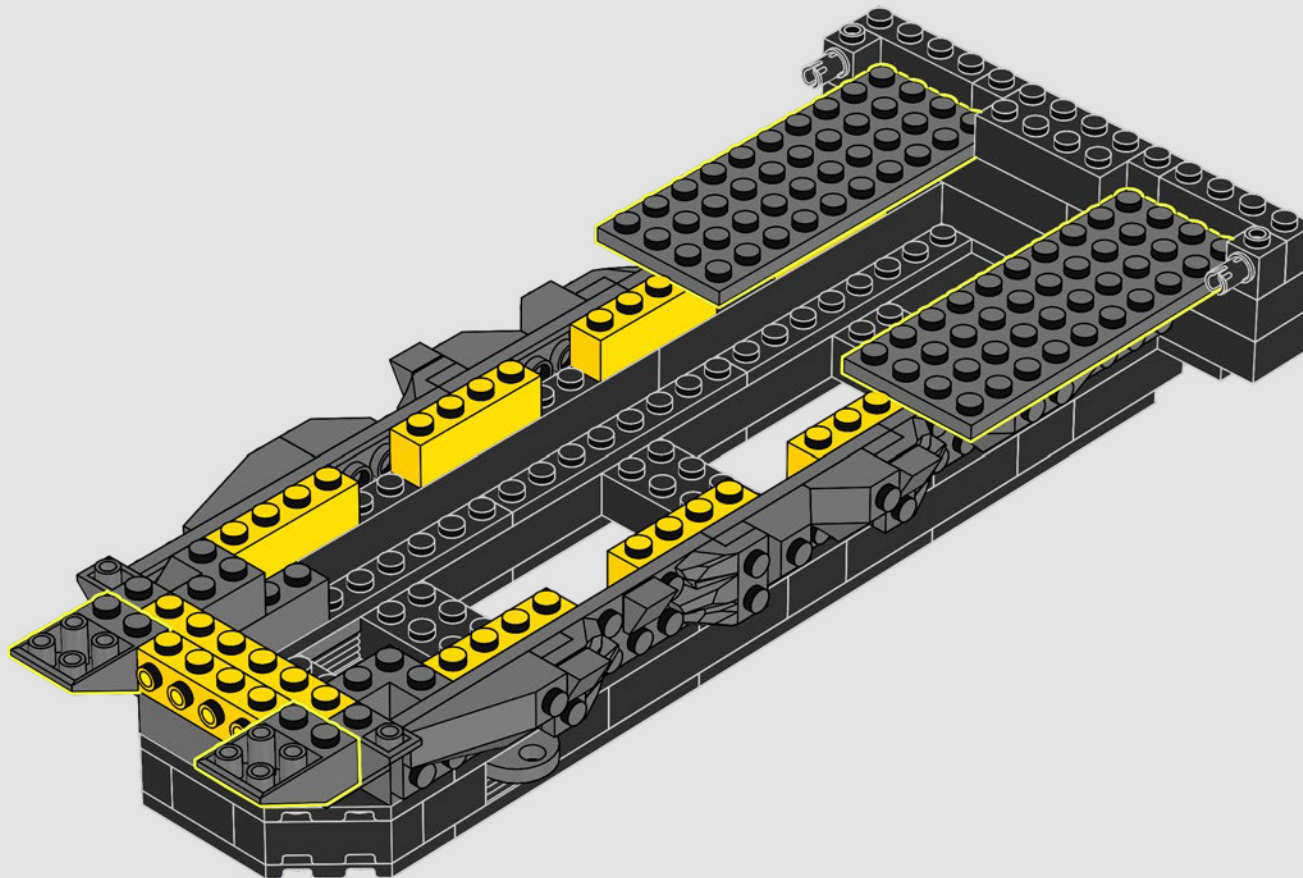

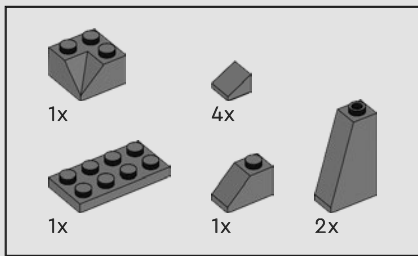

229

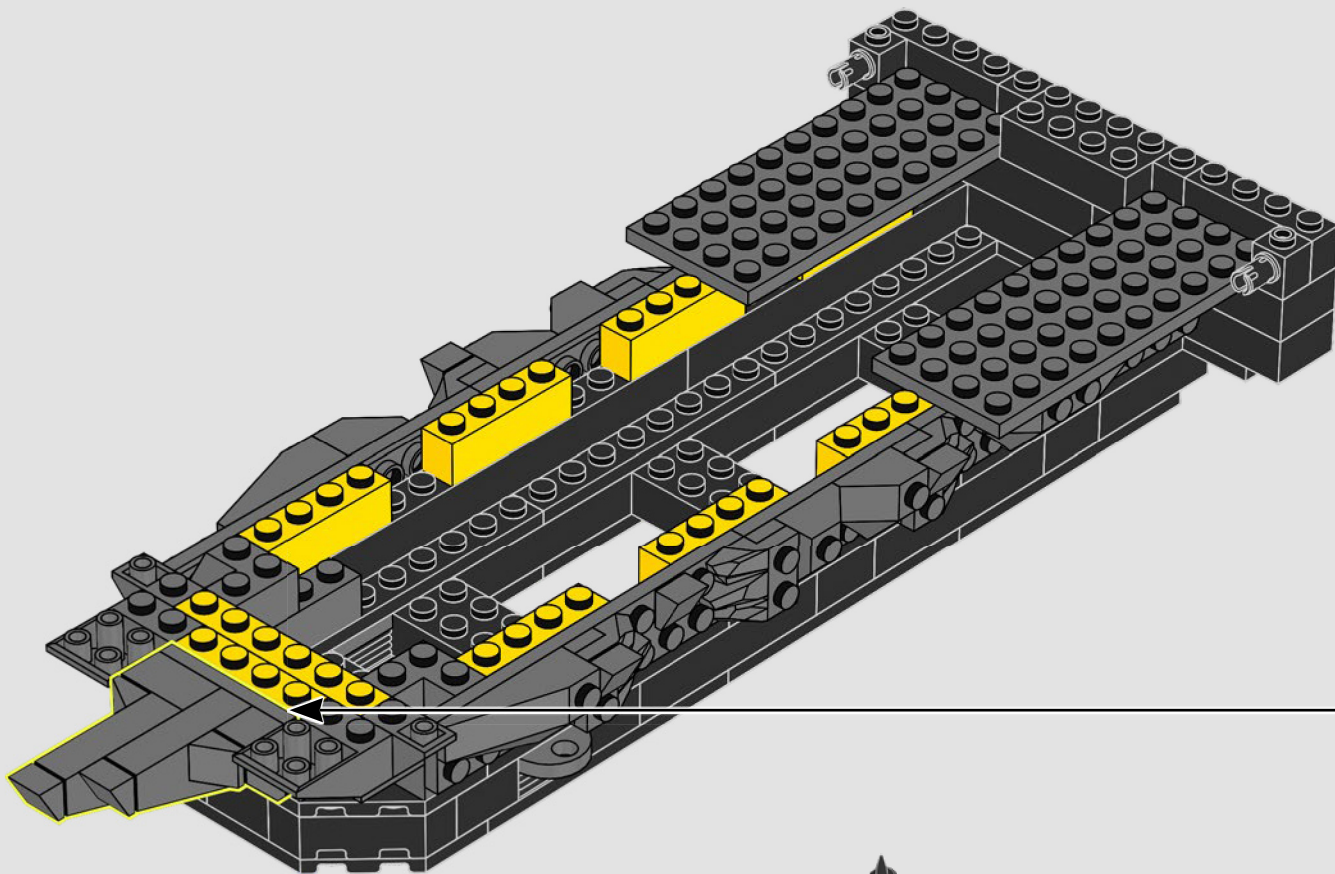
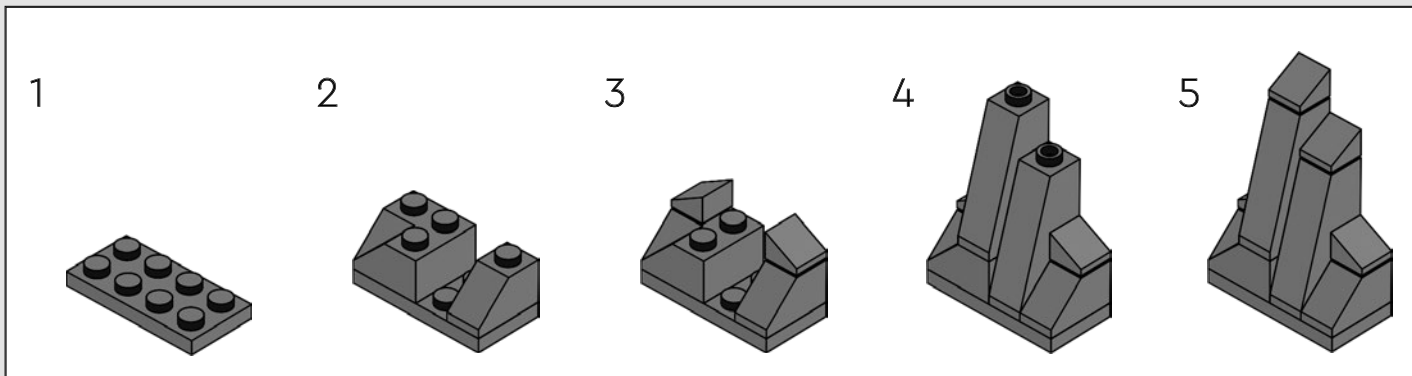

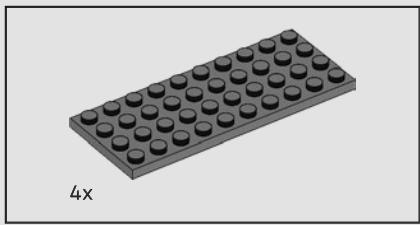

230

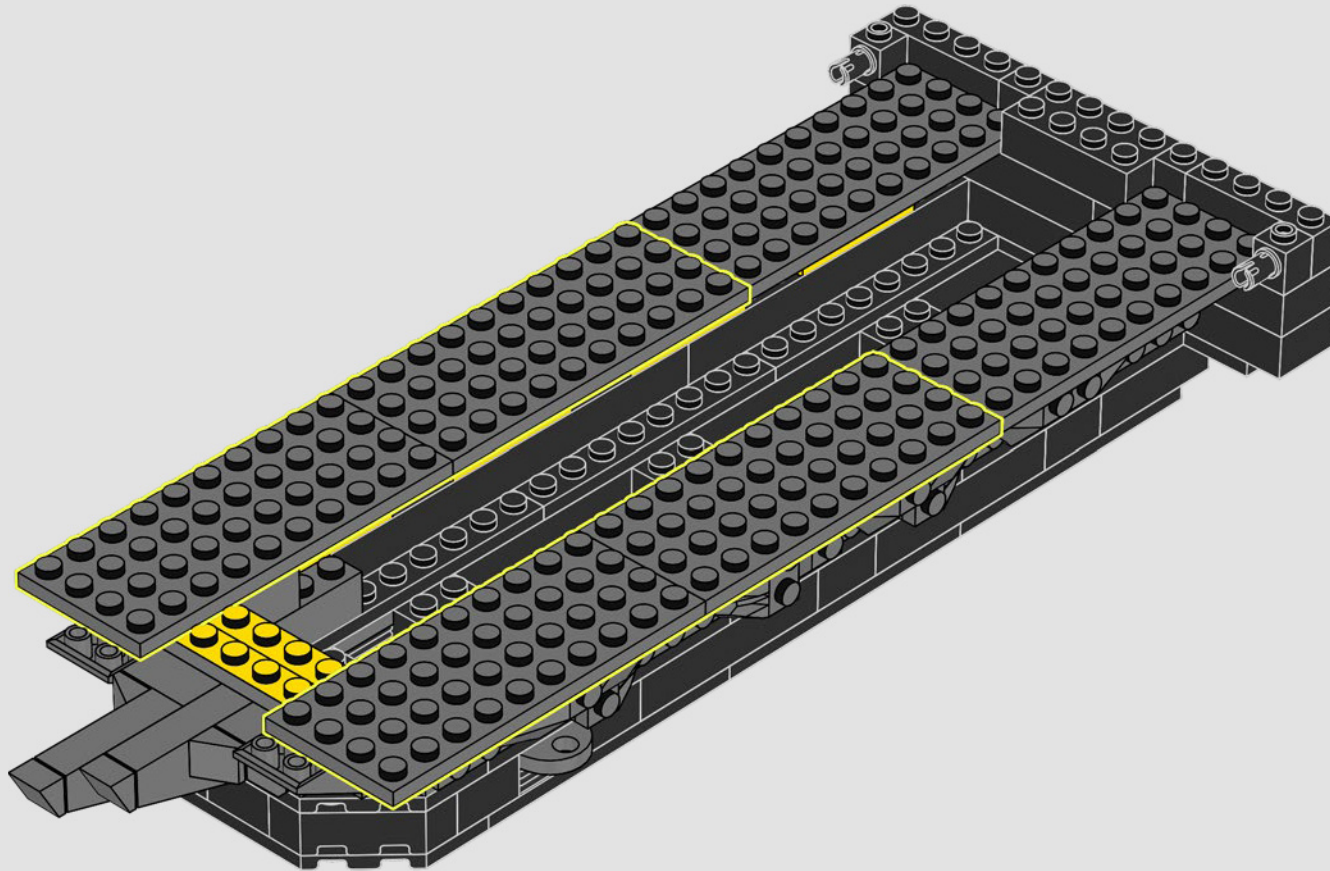

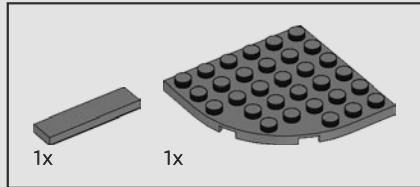
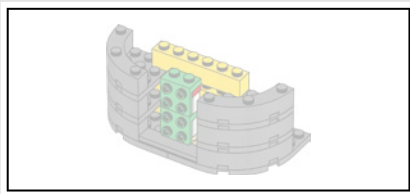

231

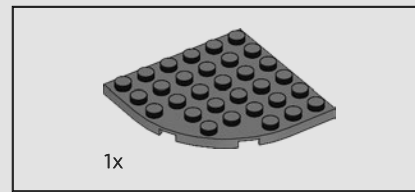
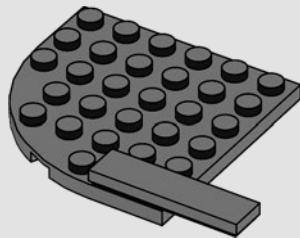

232

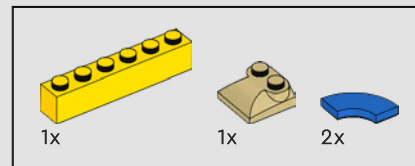
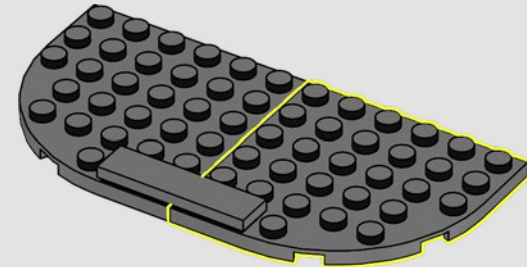

233

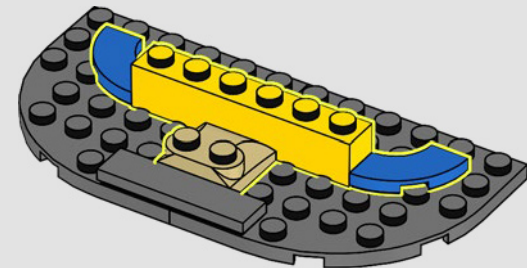



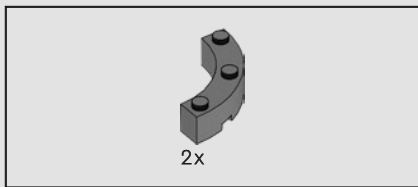

234

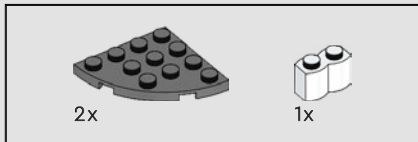
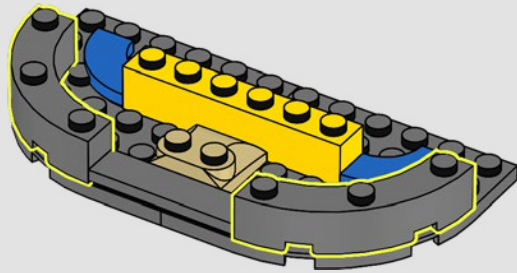

235

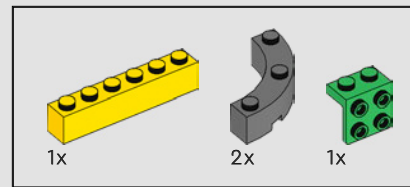
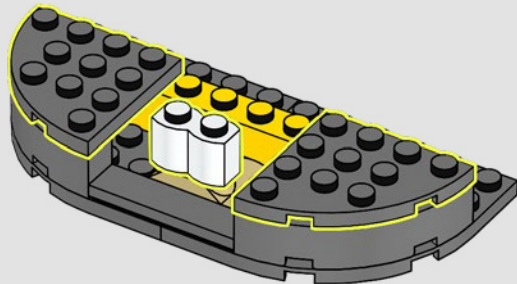

236

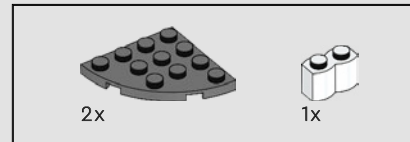
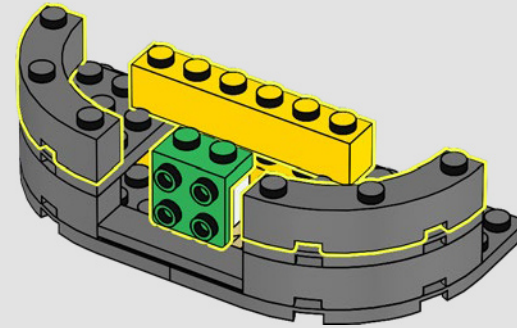

237

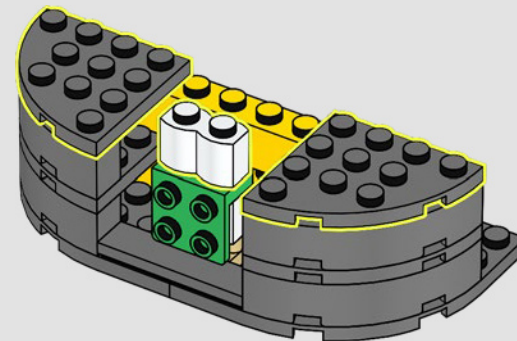



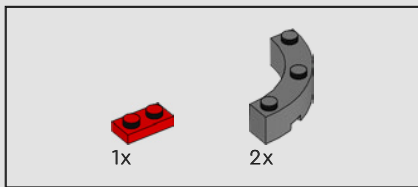

238

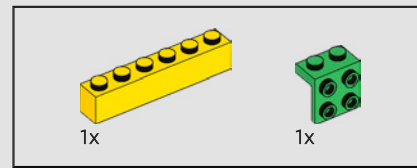
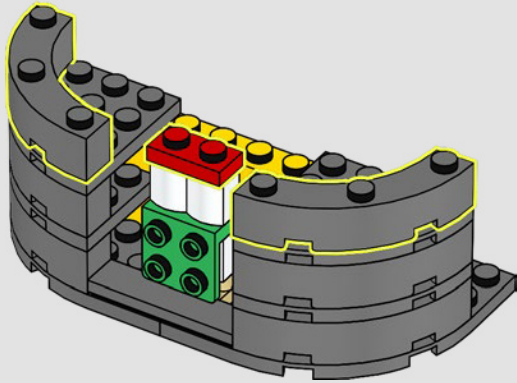

239

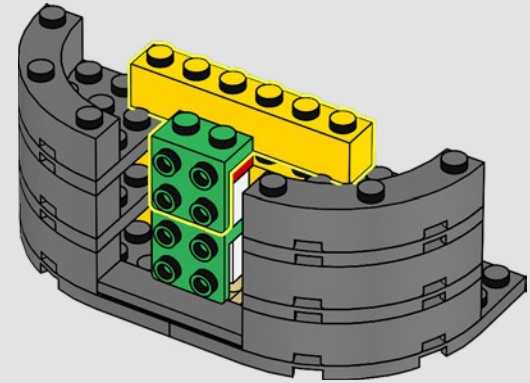

240

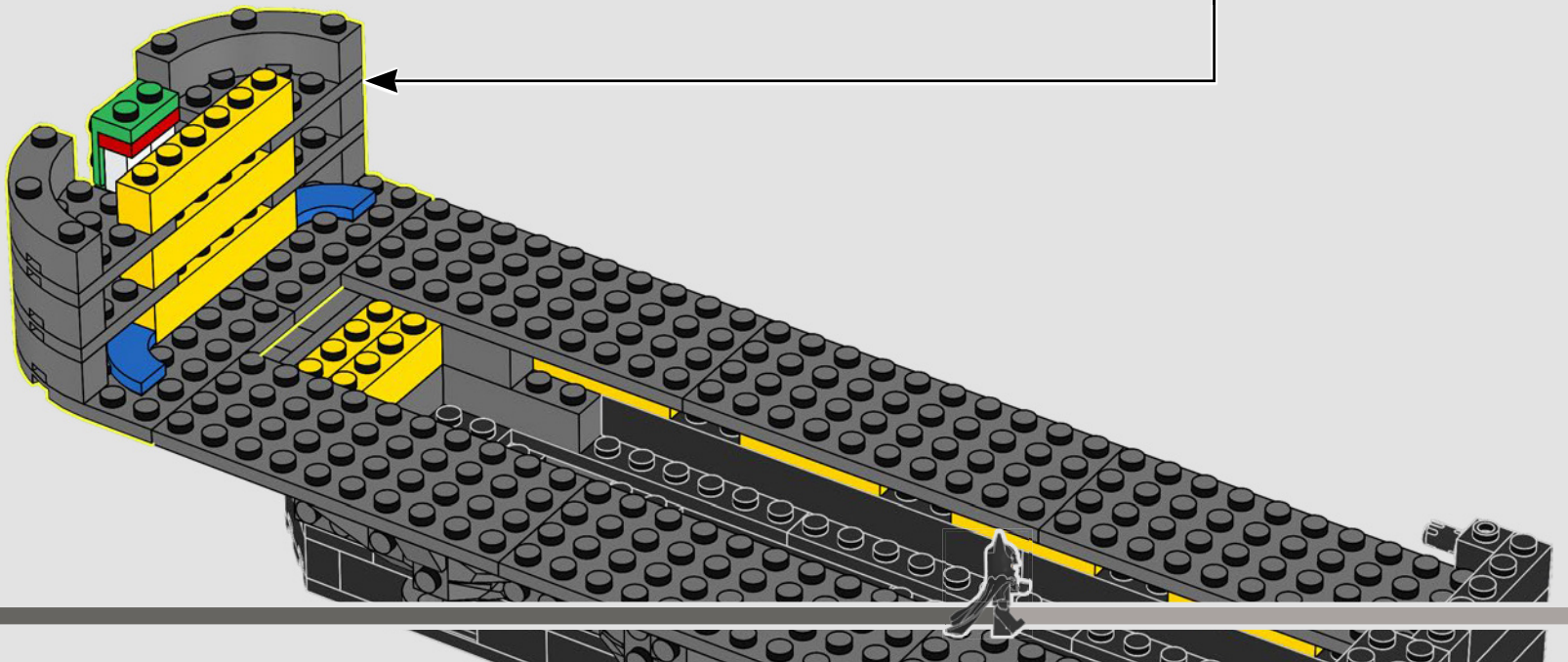

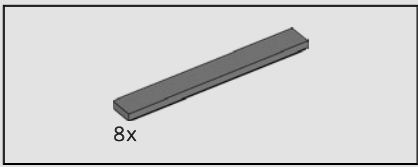

241

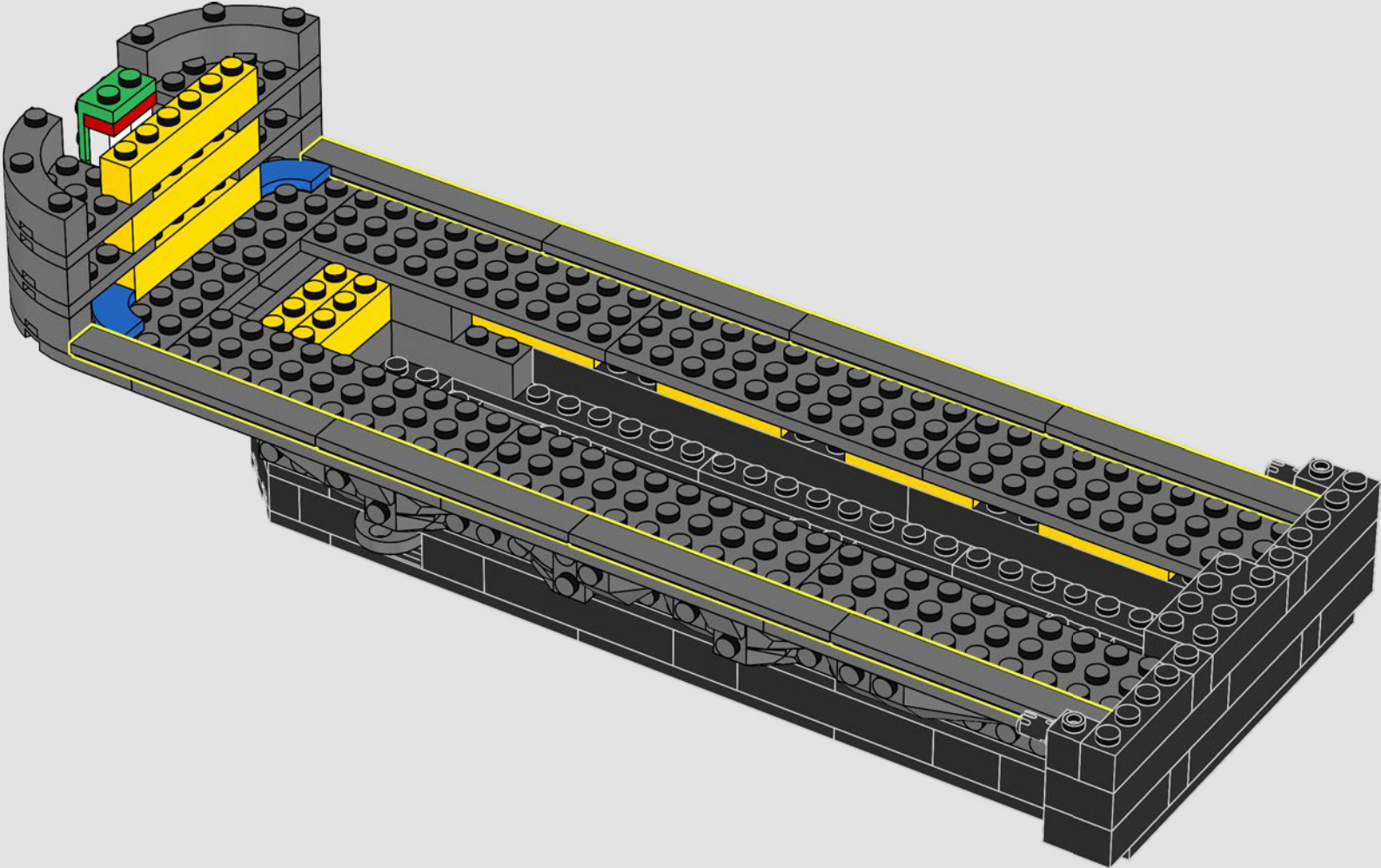

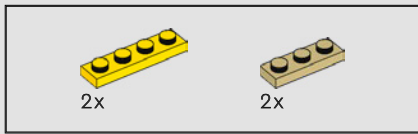

242

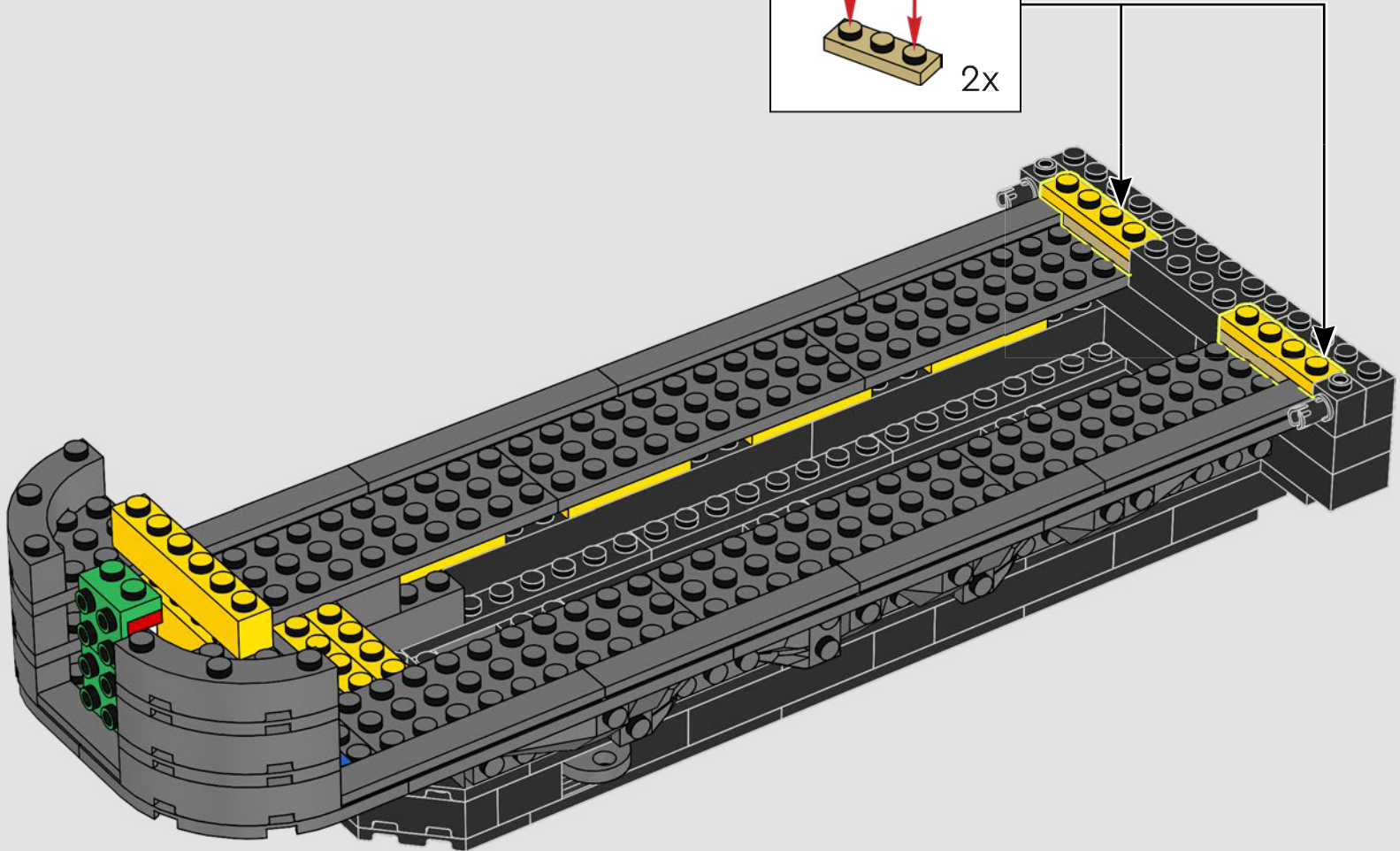
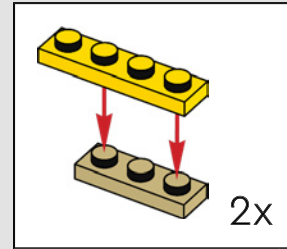



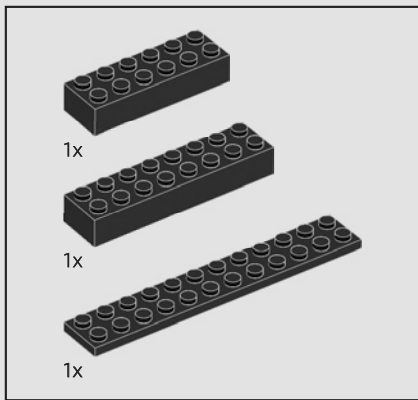

243

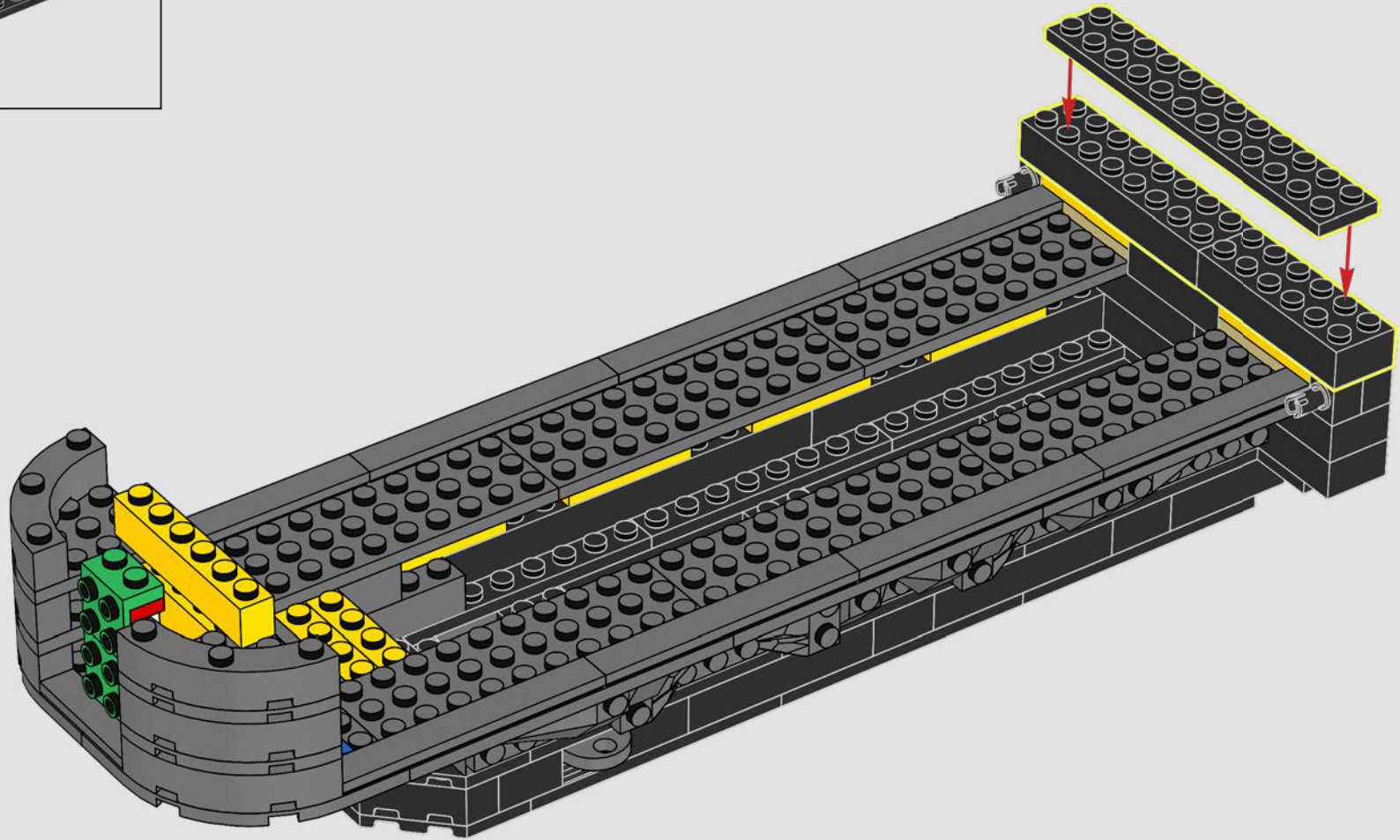

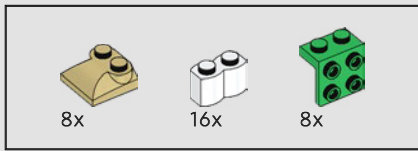

244

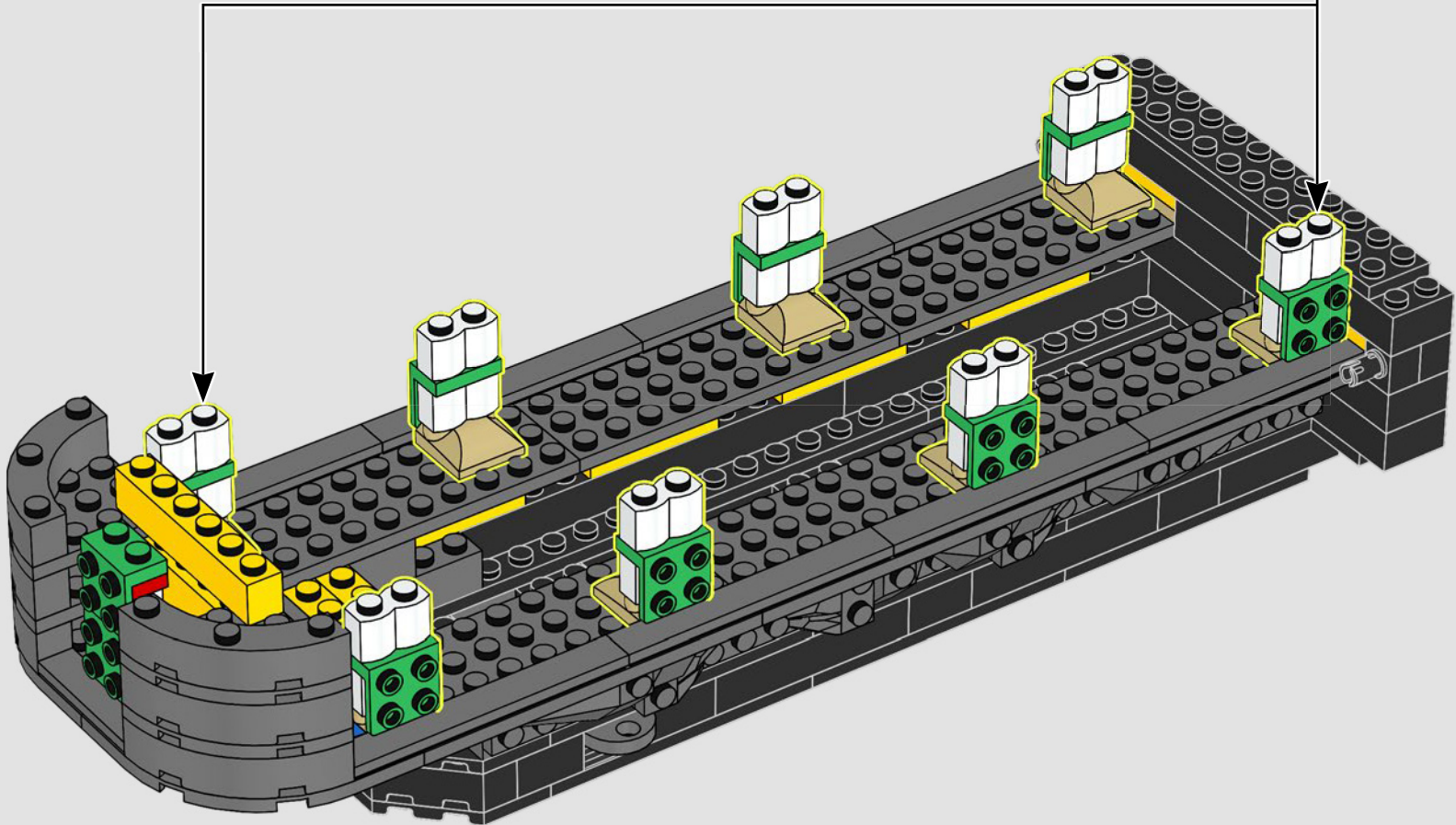
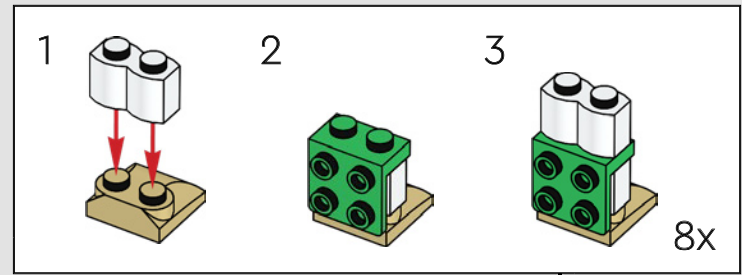



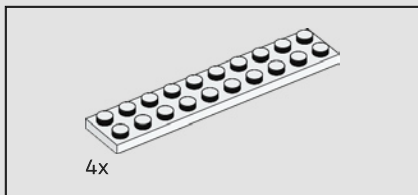

245

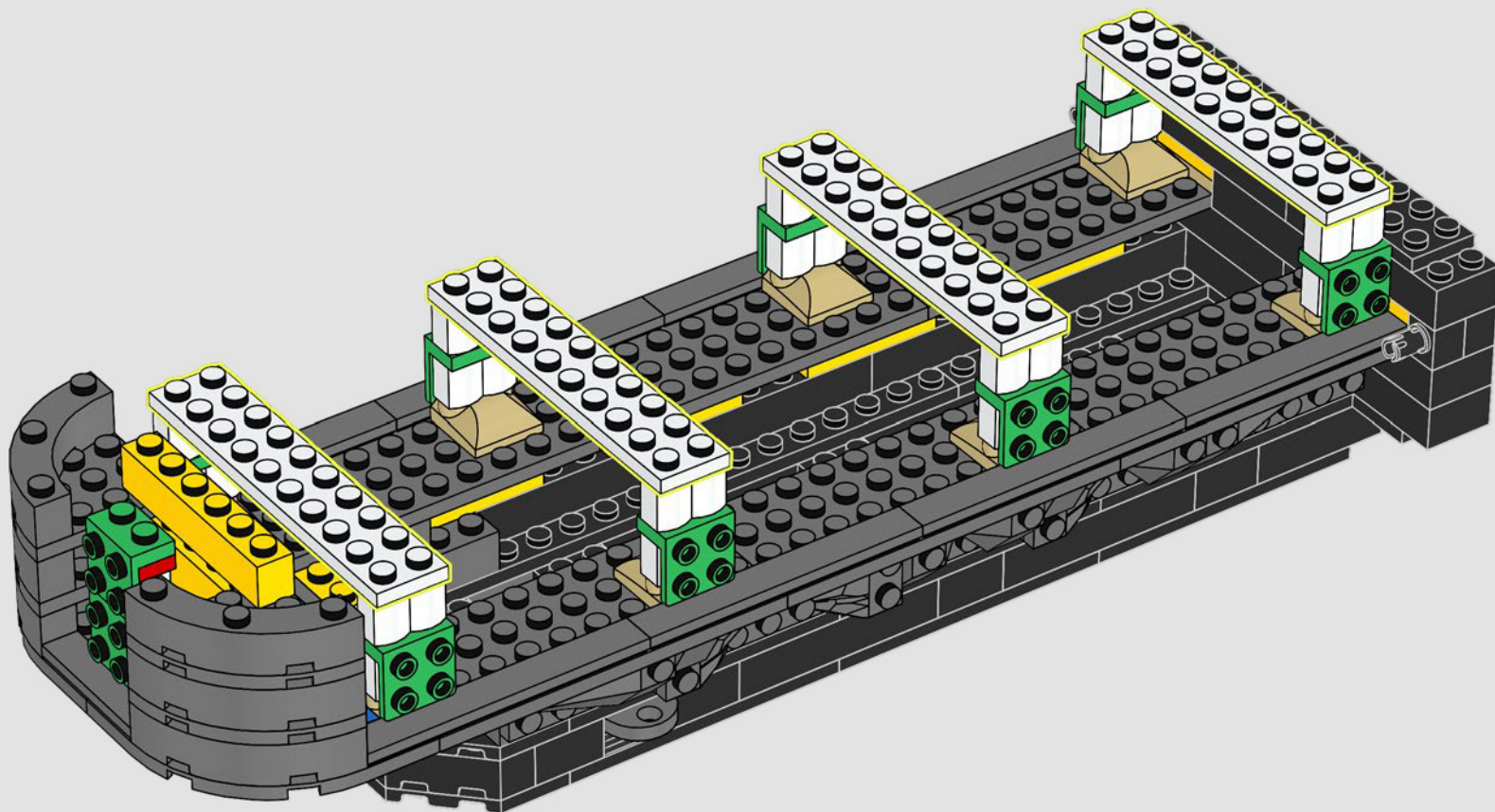

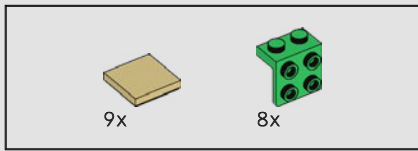

246

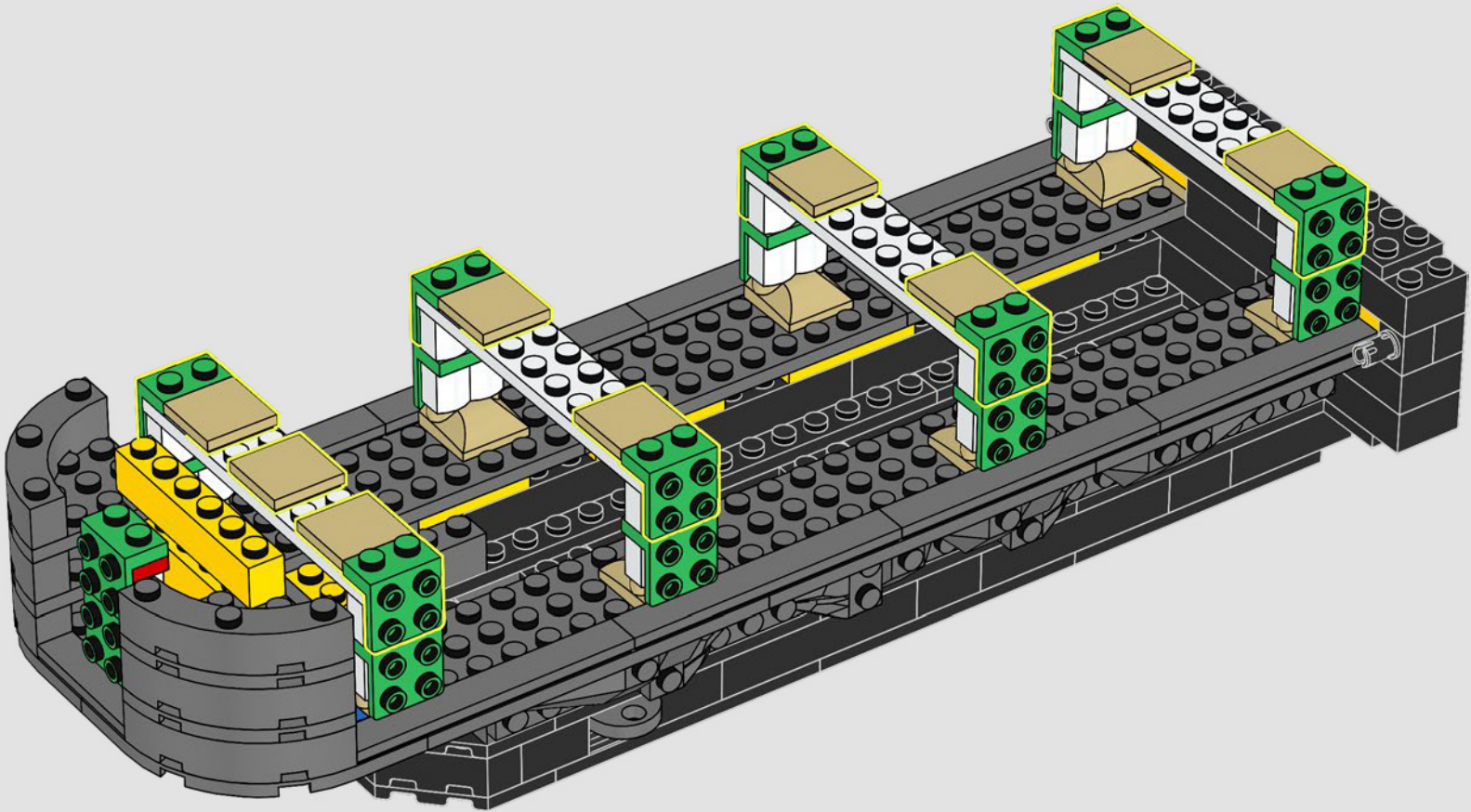

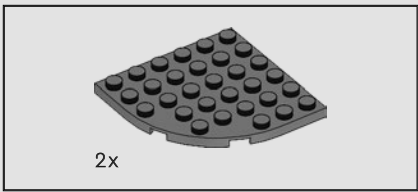

247

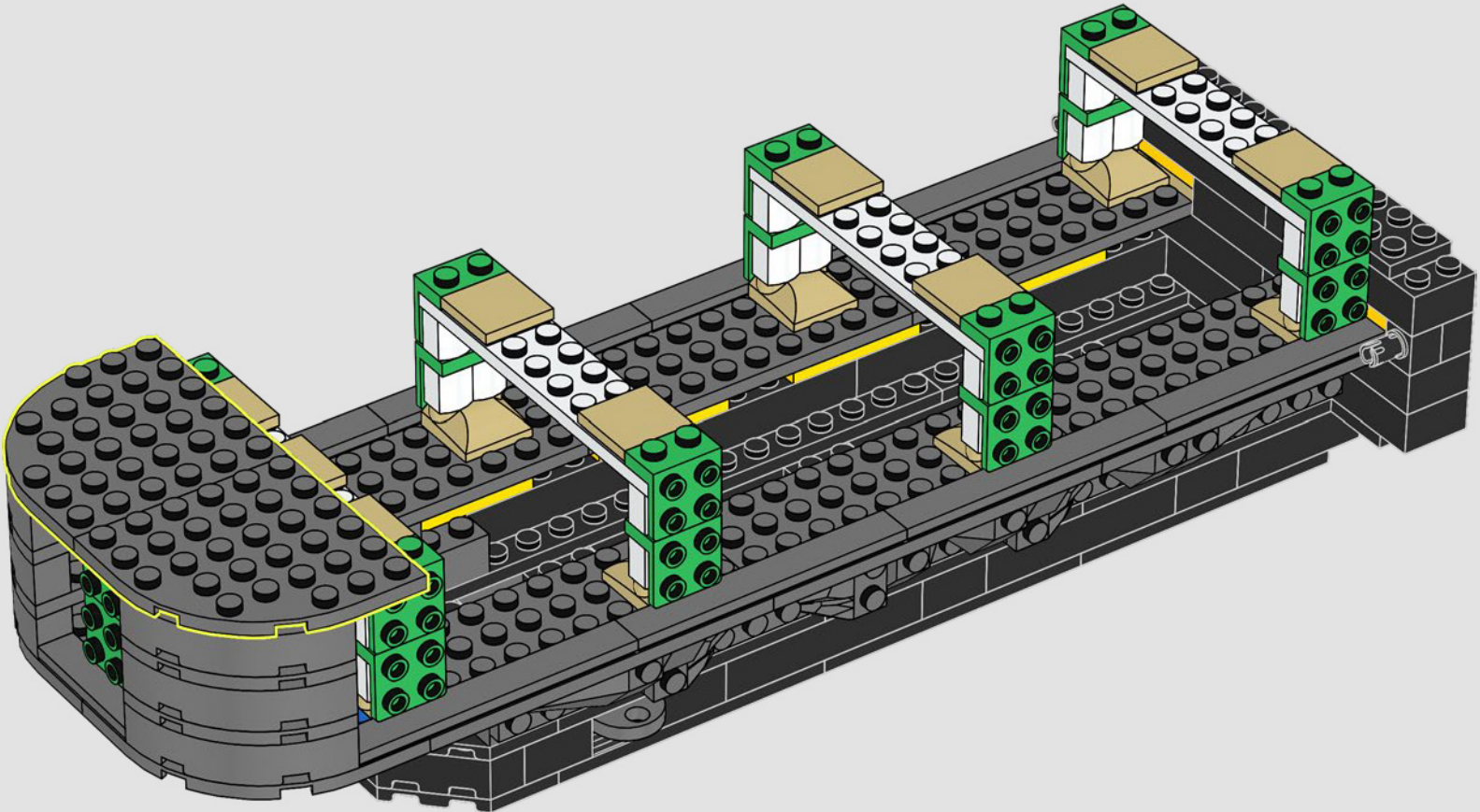



248

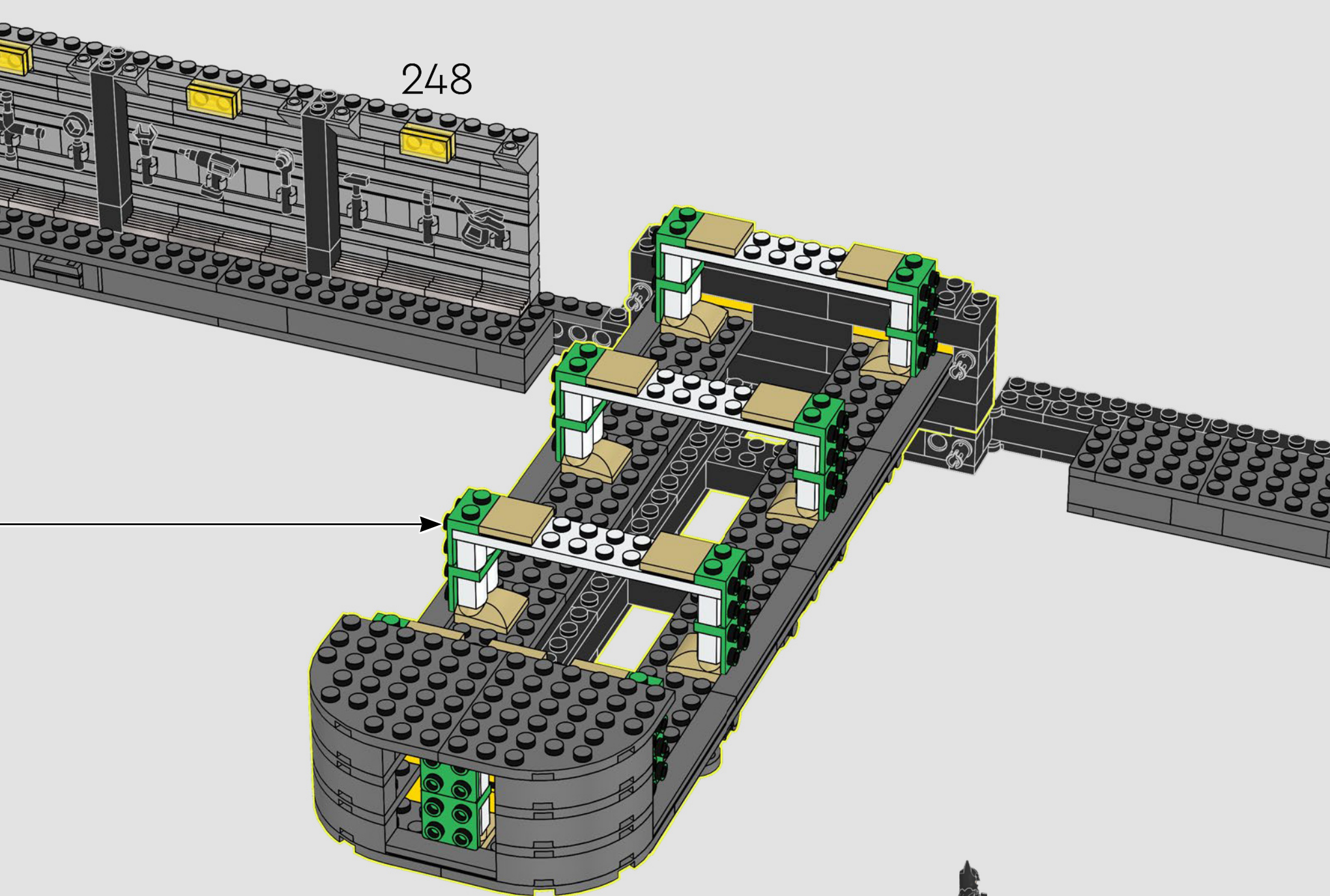

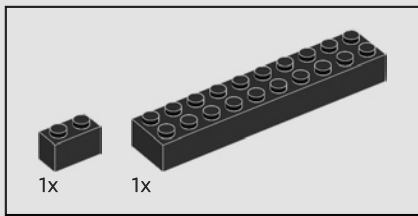

249

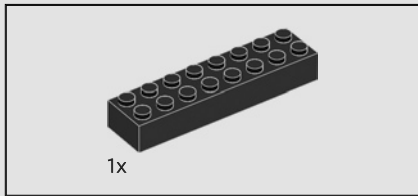
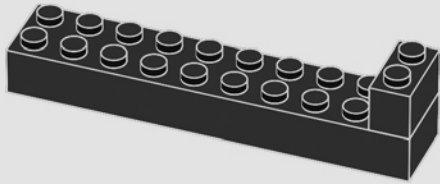

250

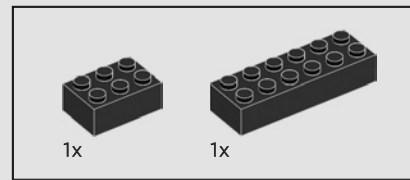
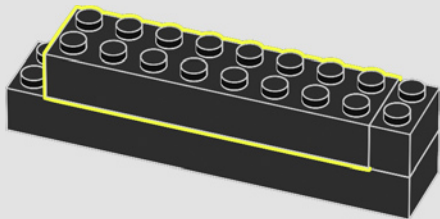

251

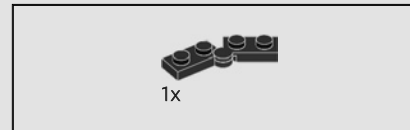
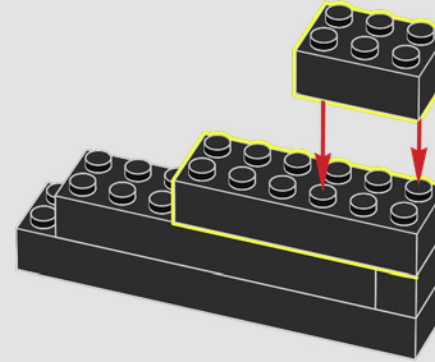

252

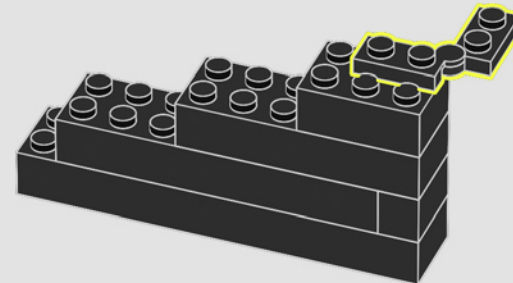



253

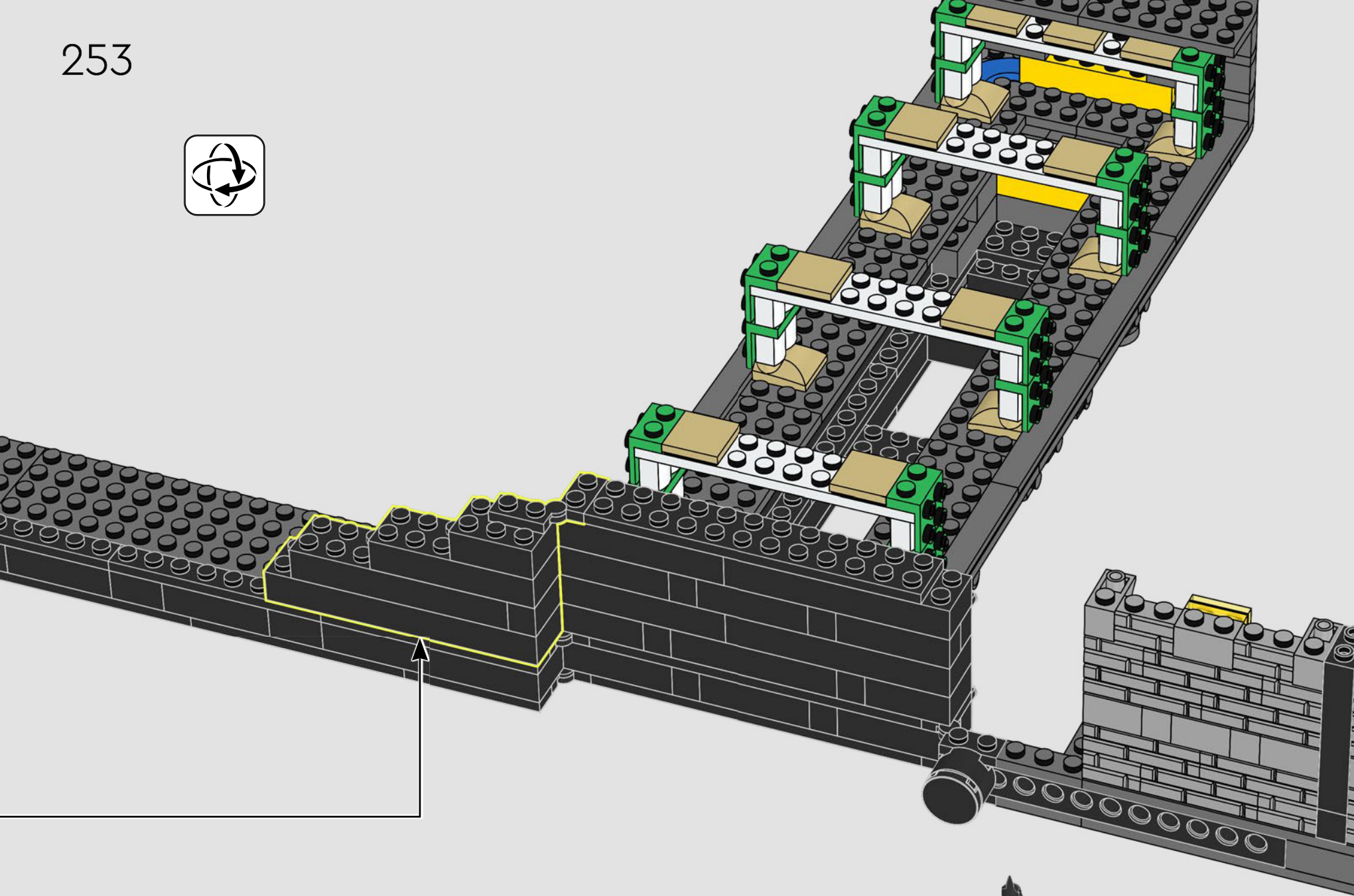

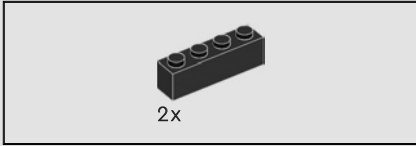
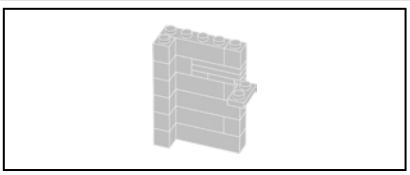

254

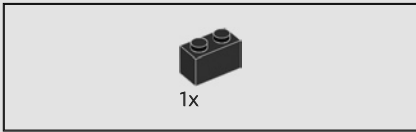
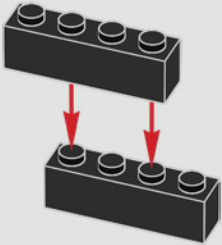

255

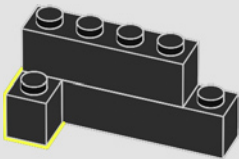

256

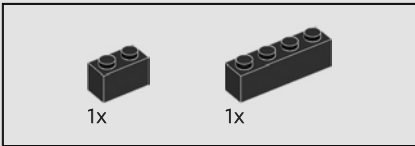
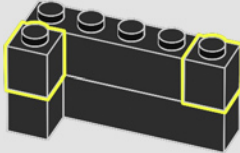

257

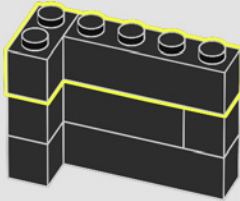

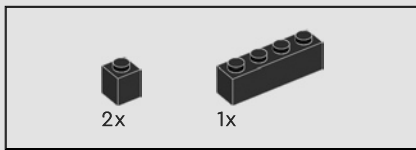

258

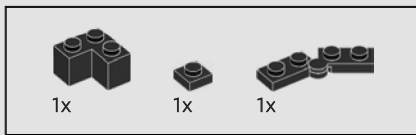
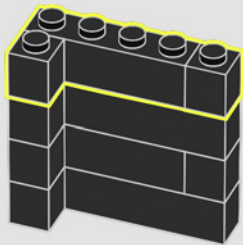

259

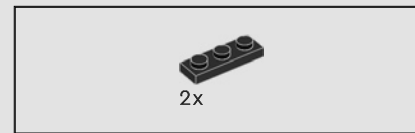
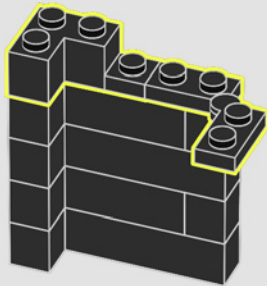

260

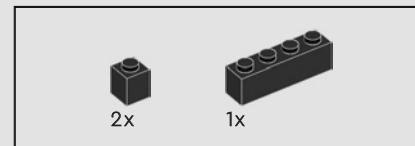
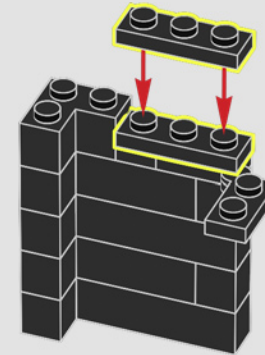

261

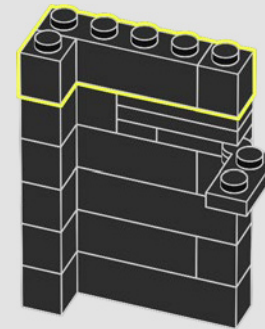

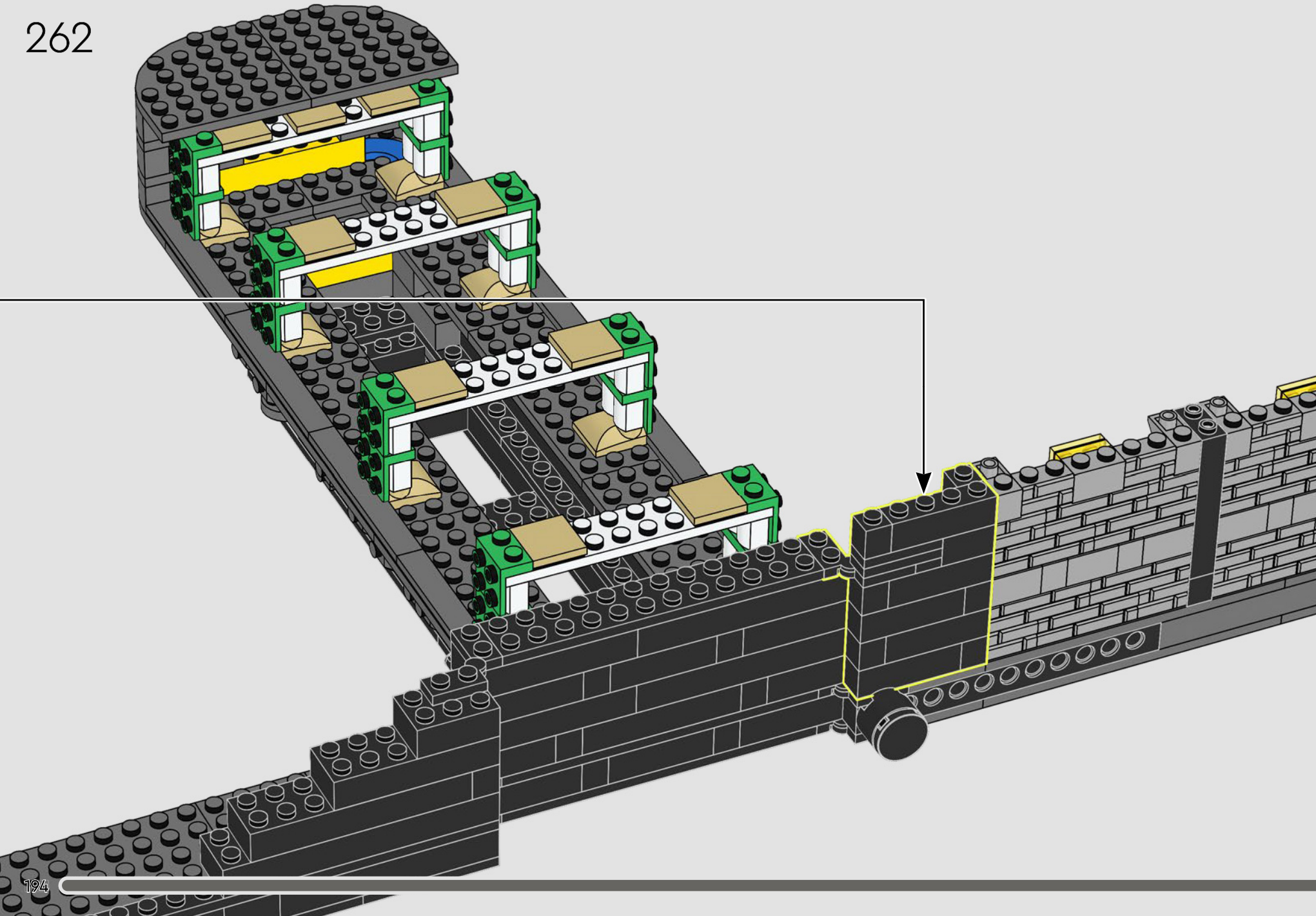



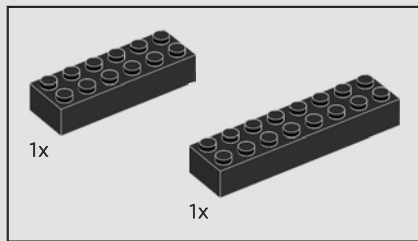

263

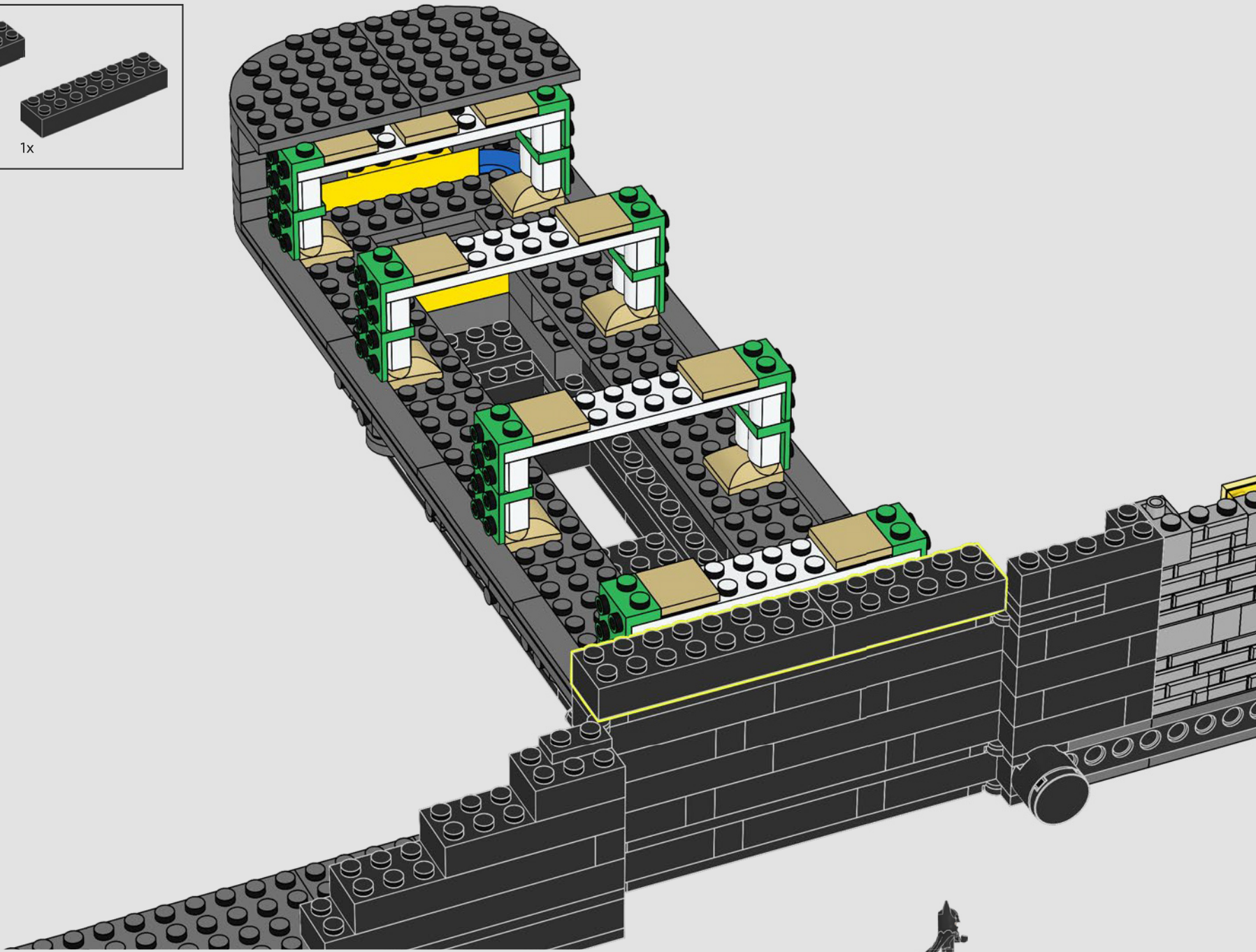



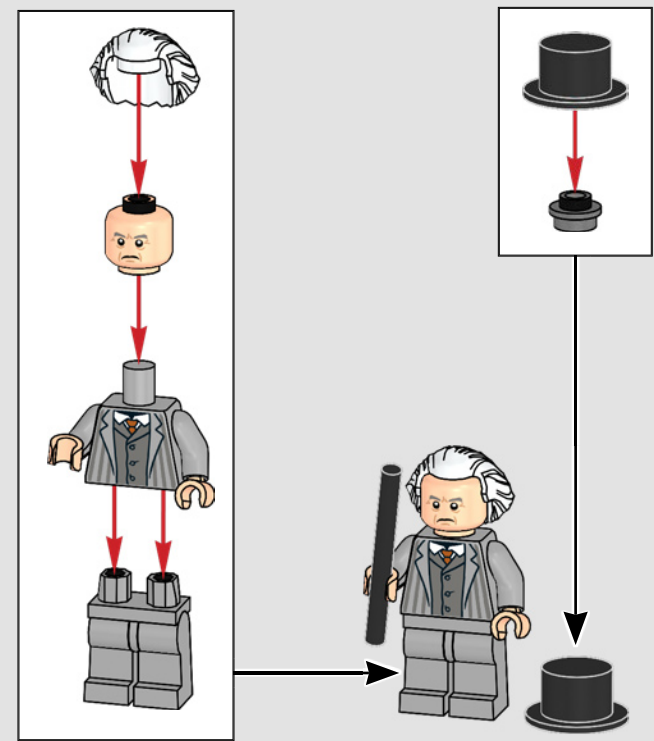
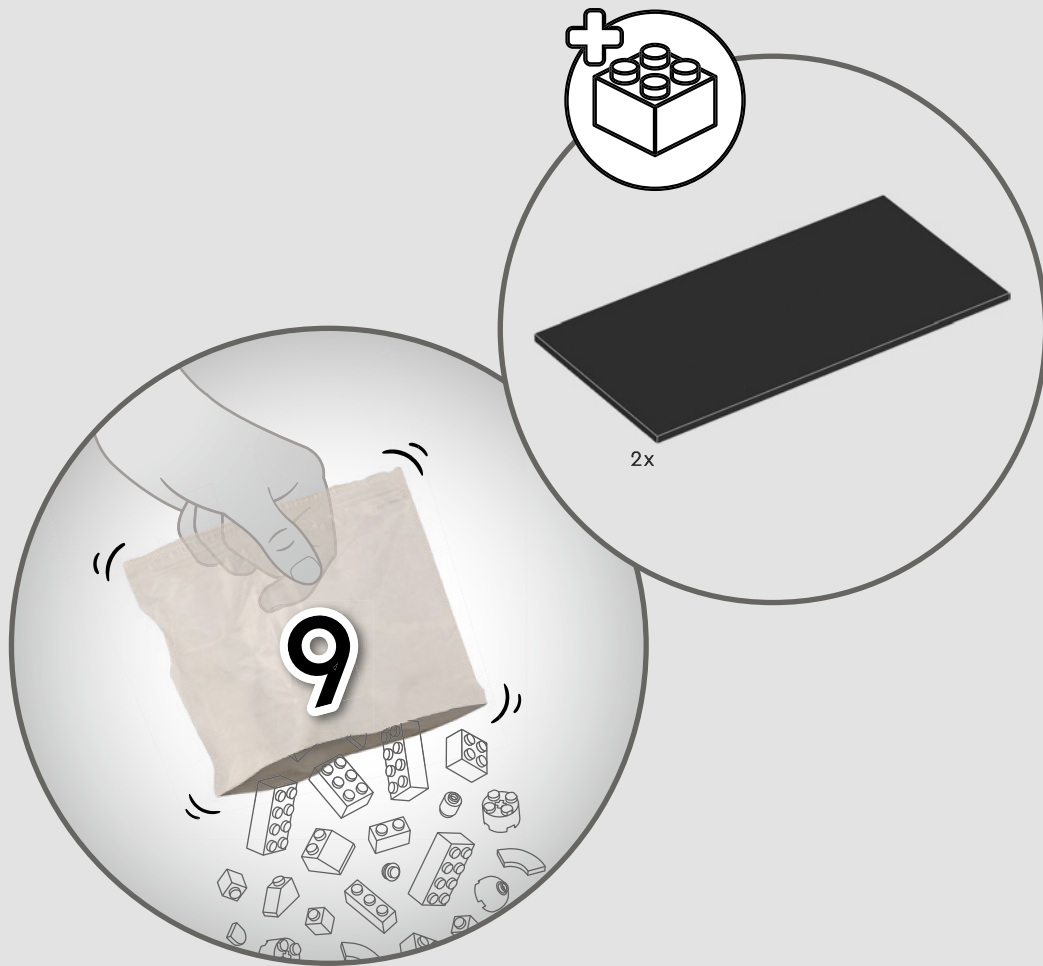



## 马克斯·史莱克

马克斯·史莱克是一个冷血的商业大亨，品行不端，拥有非常强烈的自我保护意识。为了统治哥谭市，他与奥斯瓦尔德·科波特（企鹅）合作，进行了一场腐败的市长竞选。在此过程中，他从自己胆小的助手塞琳娜·凯尔身上制造了一个意料之外的克星。



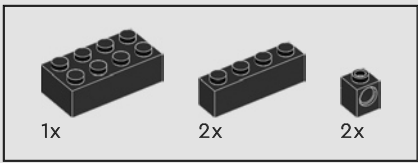

264

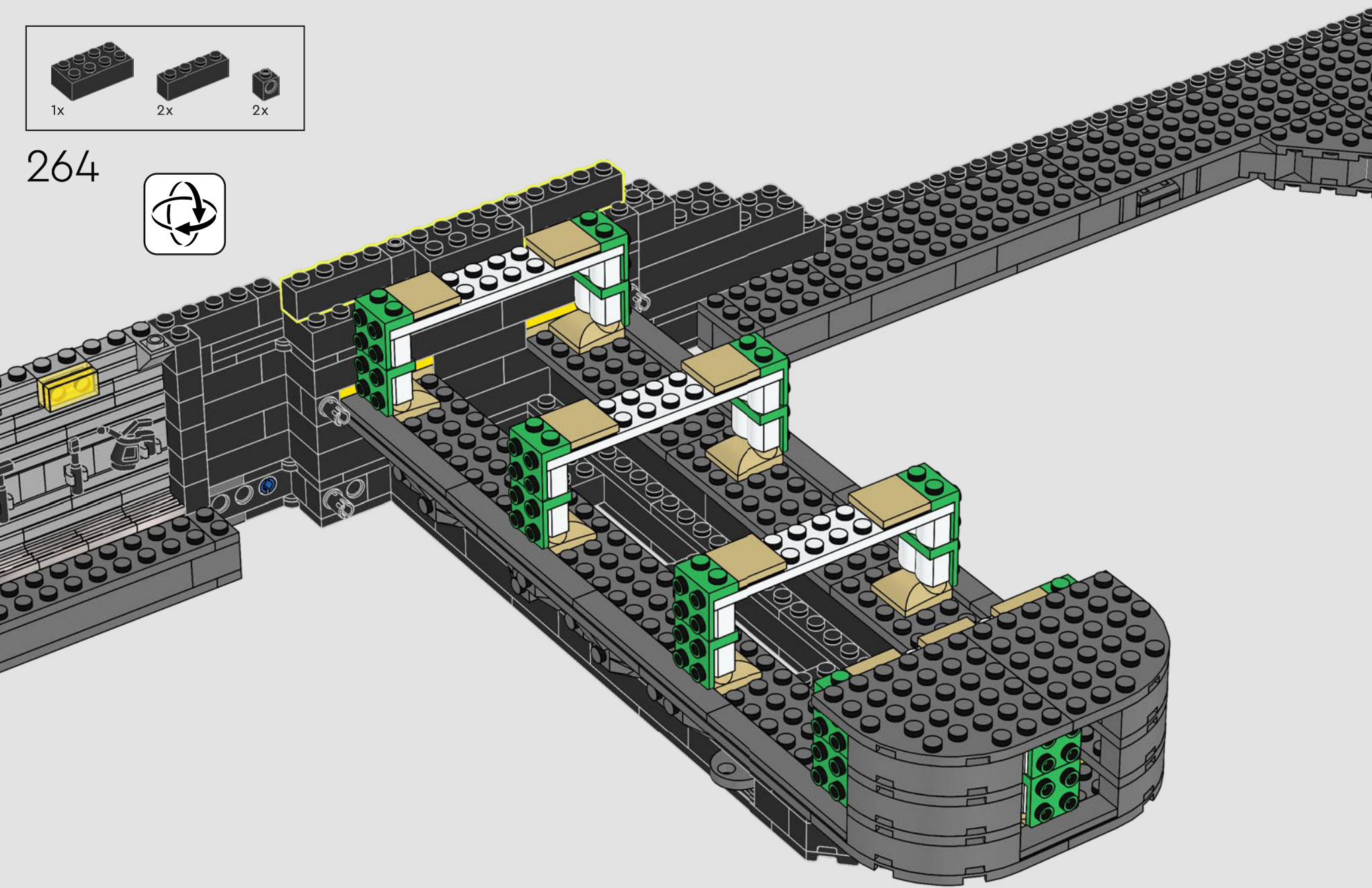



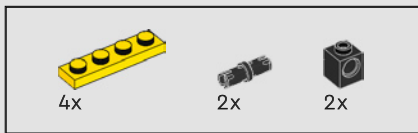

265

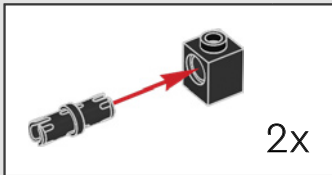
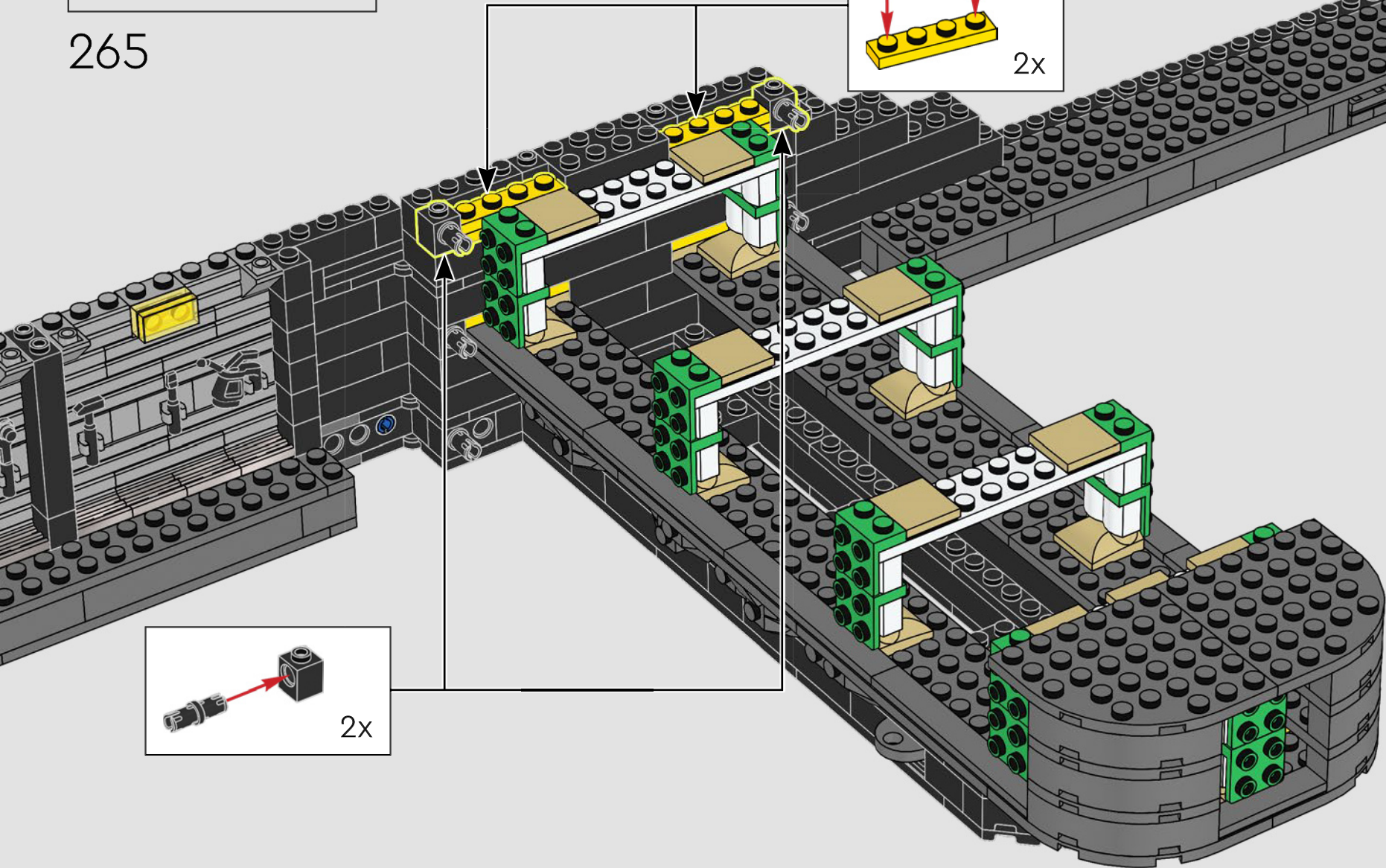
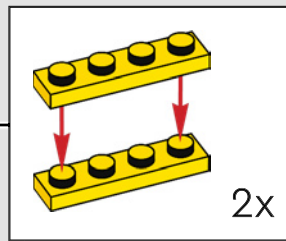

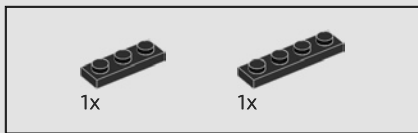

266

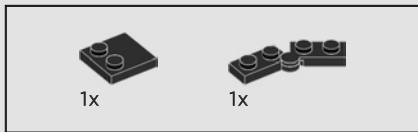
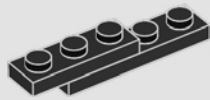

267

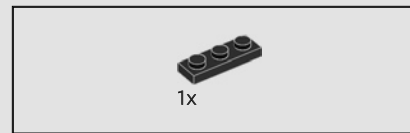
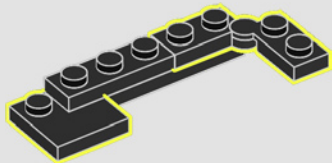

268

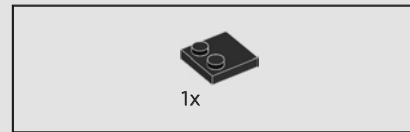
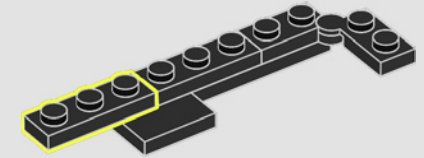

269

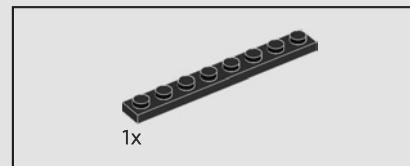
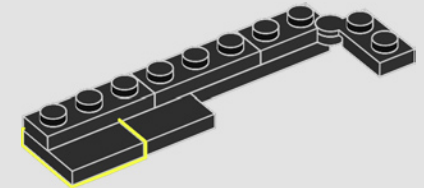

270

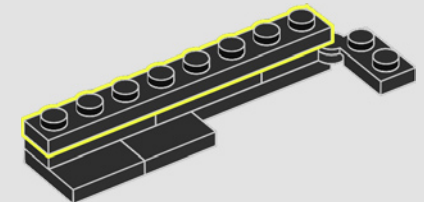



271

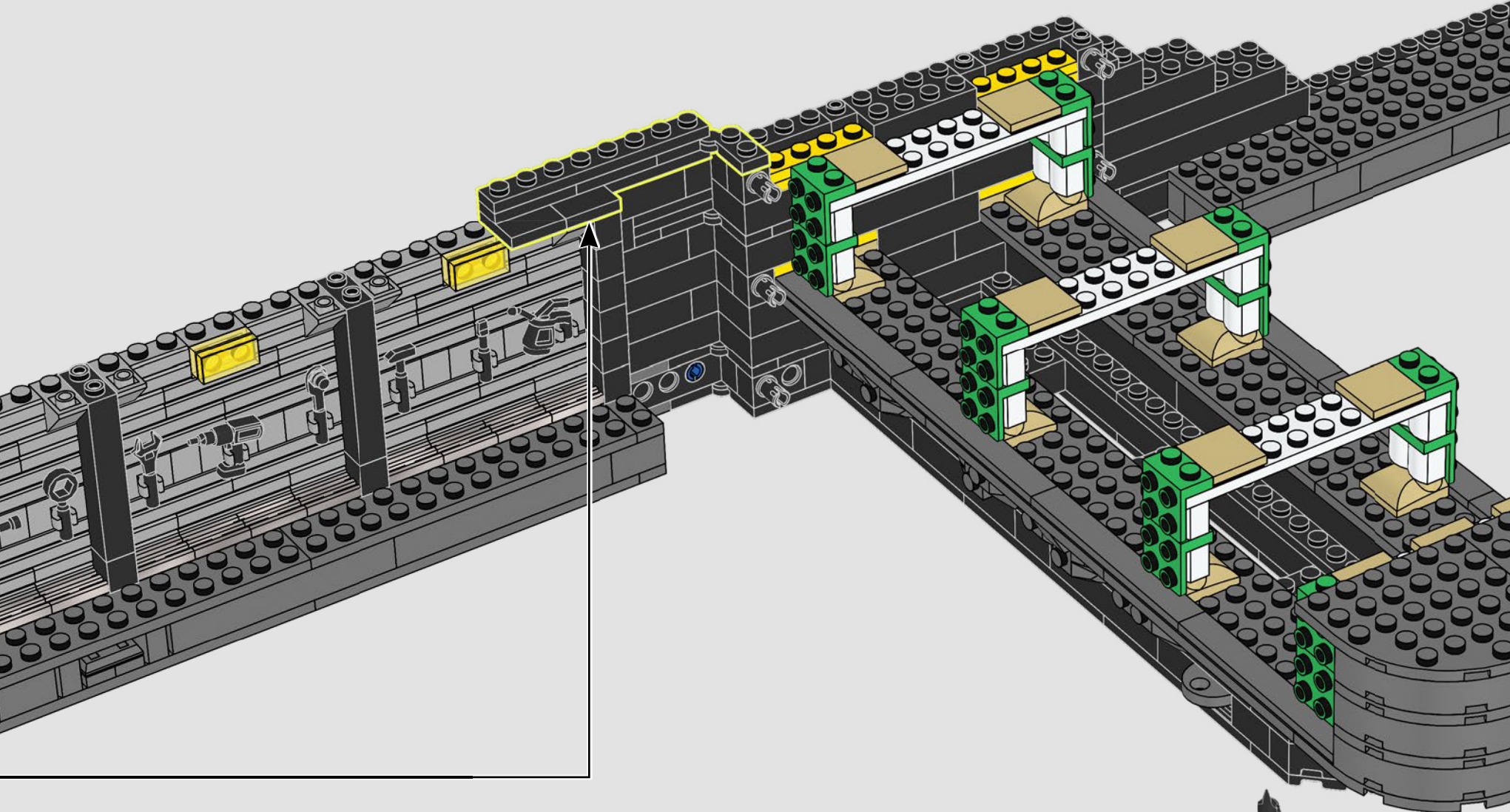

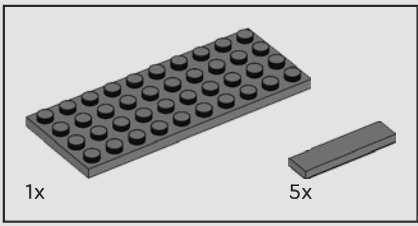

272

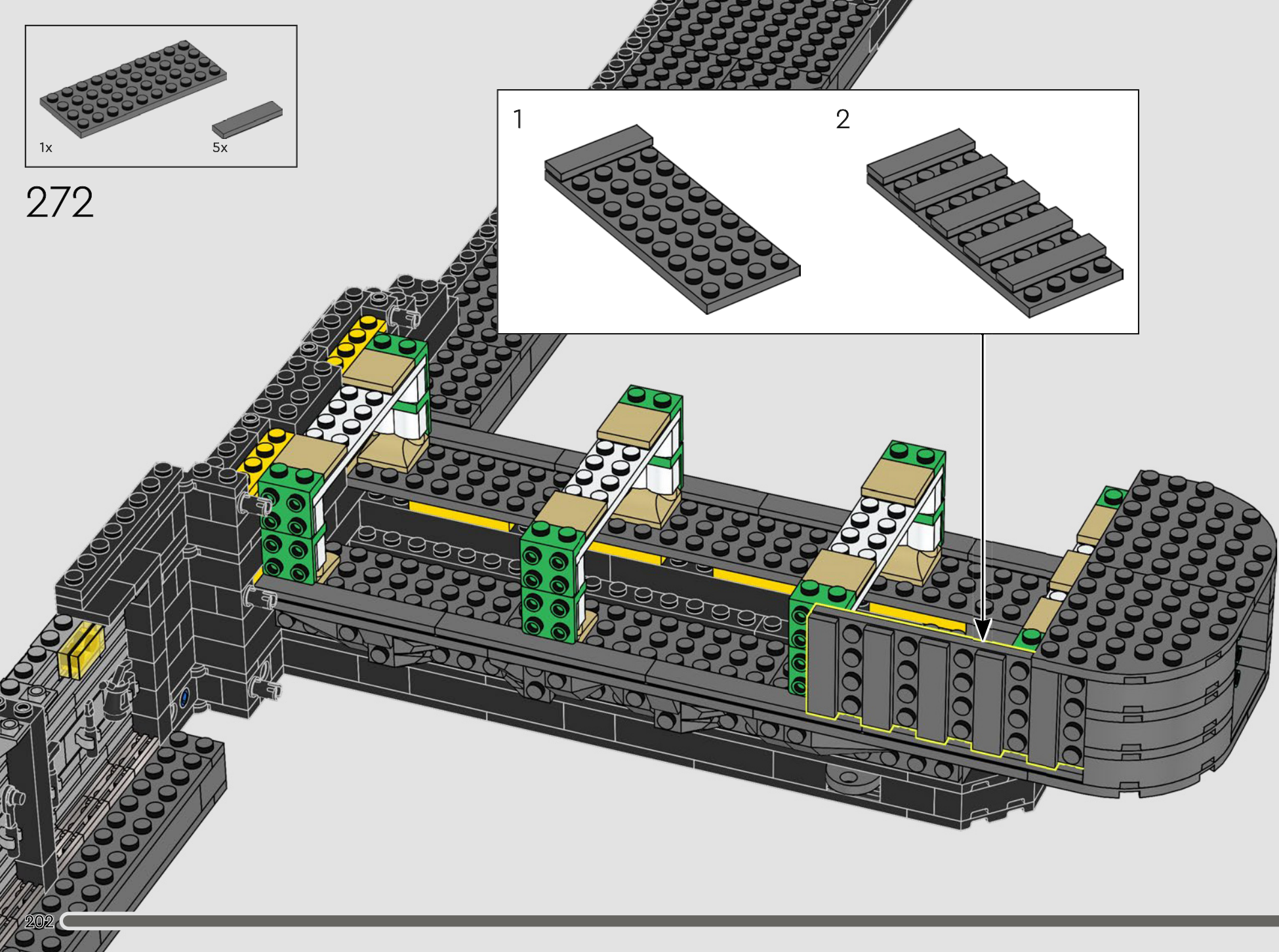
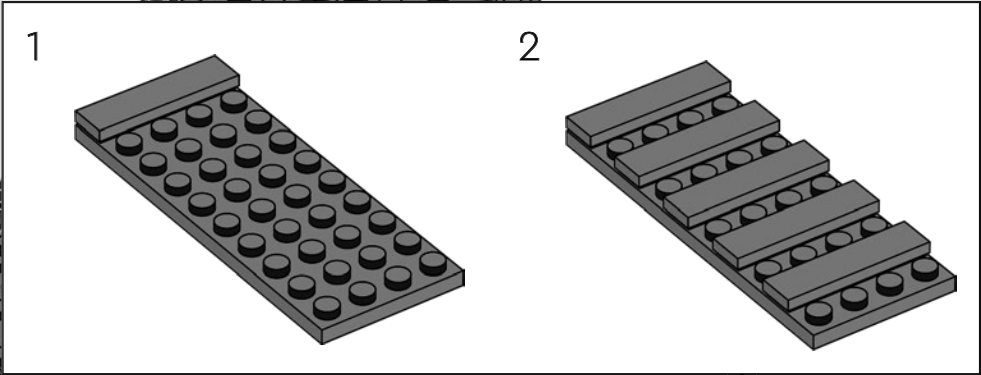



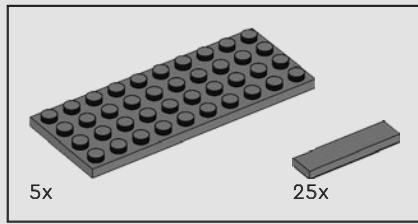

273

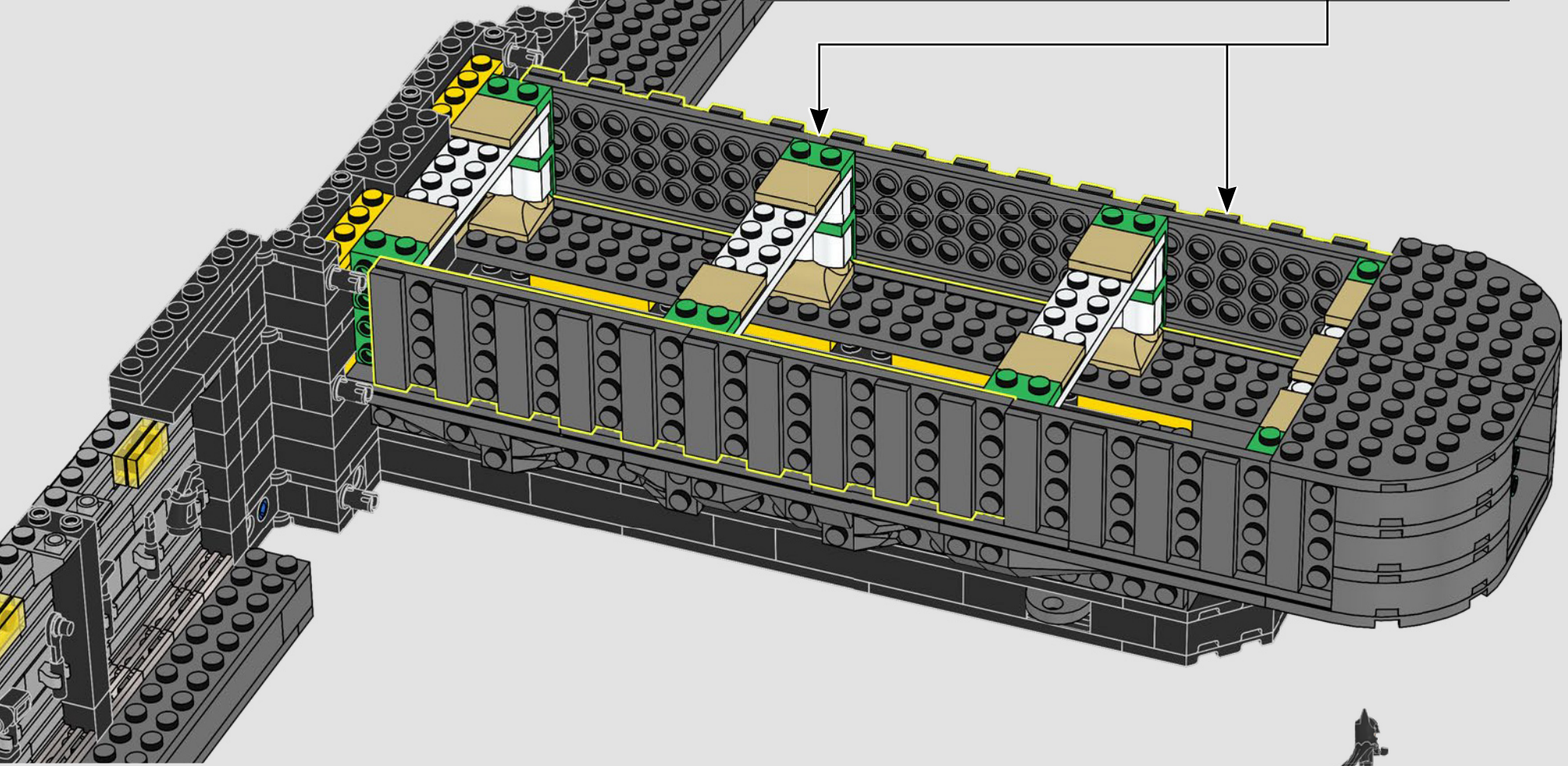
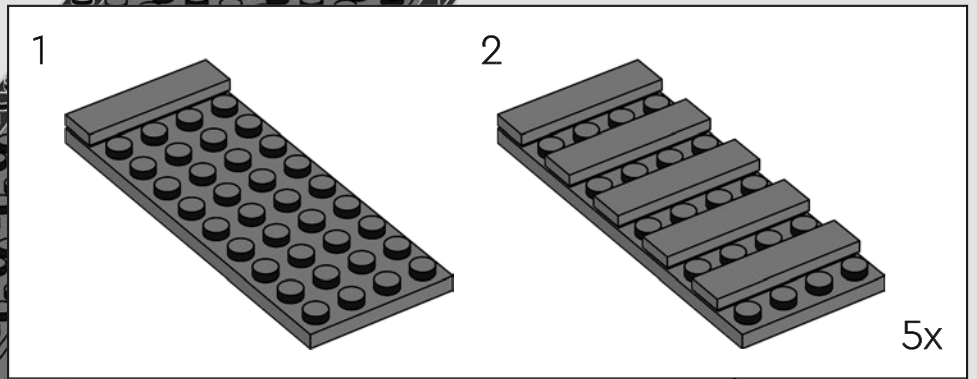

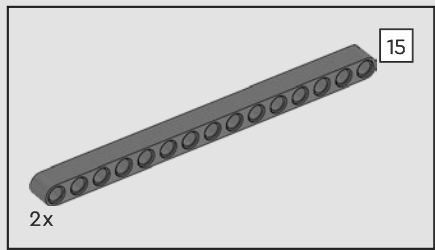

274

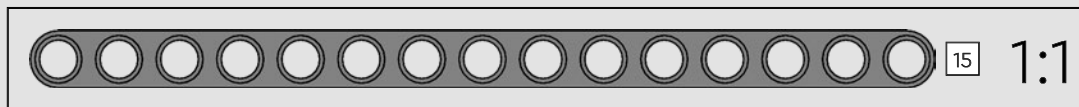
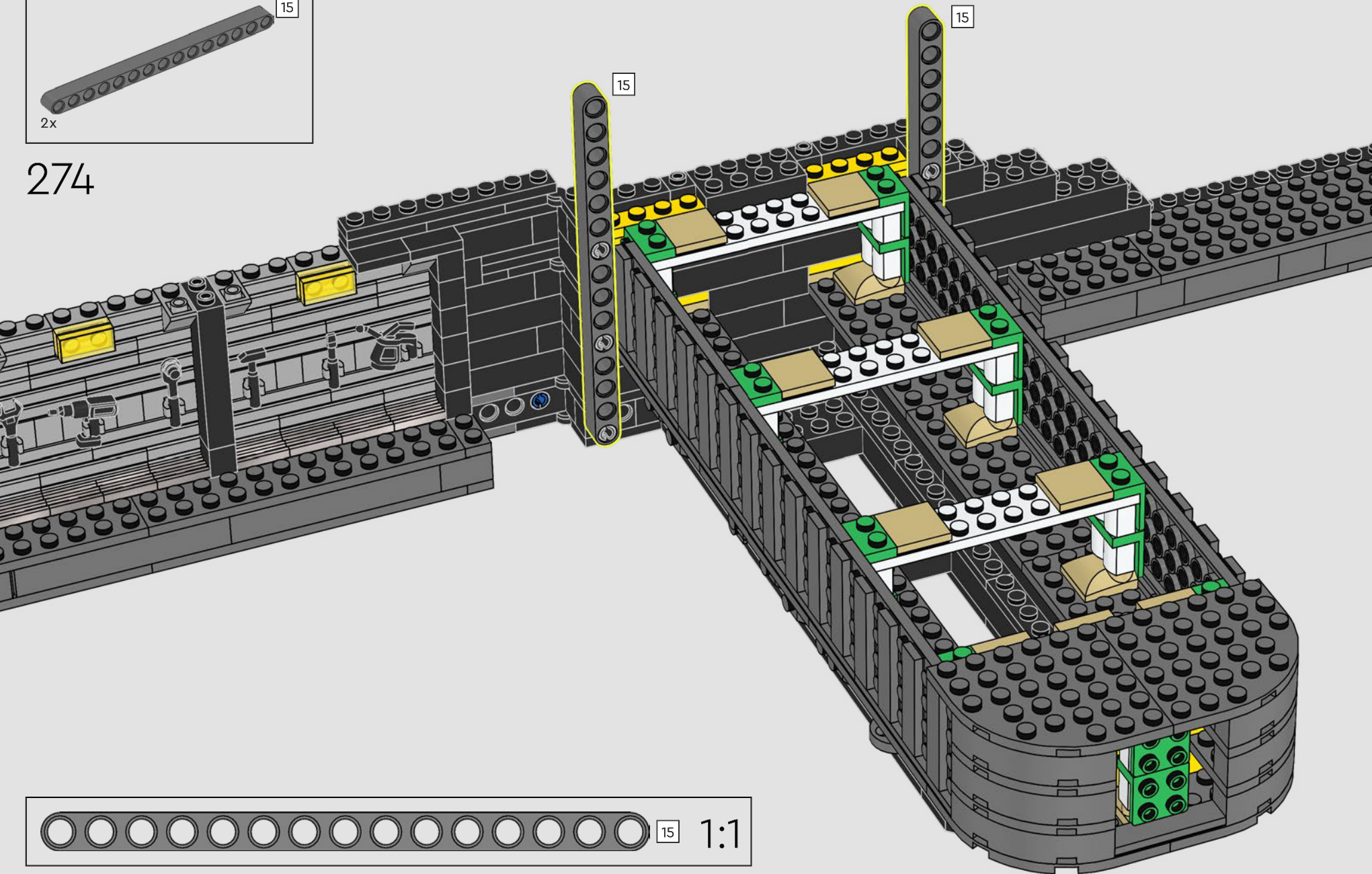



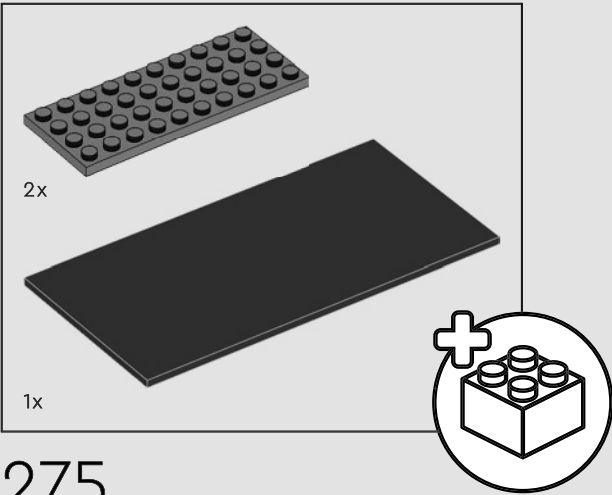
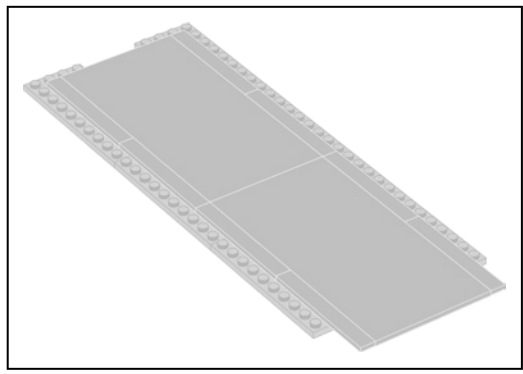

275

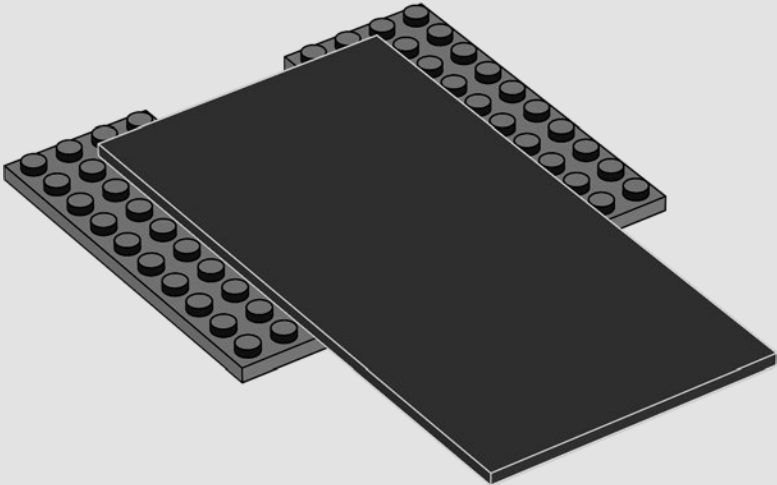



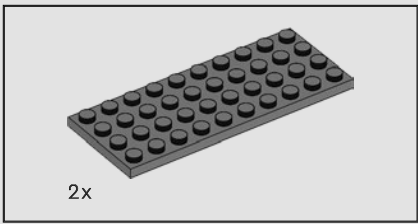

276

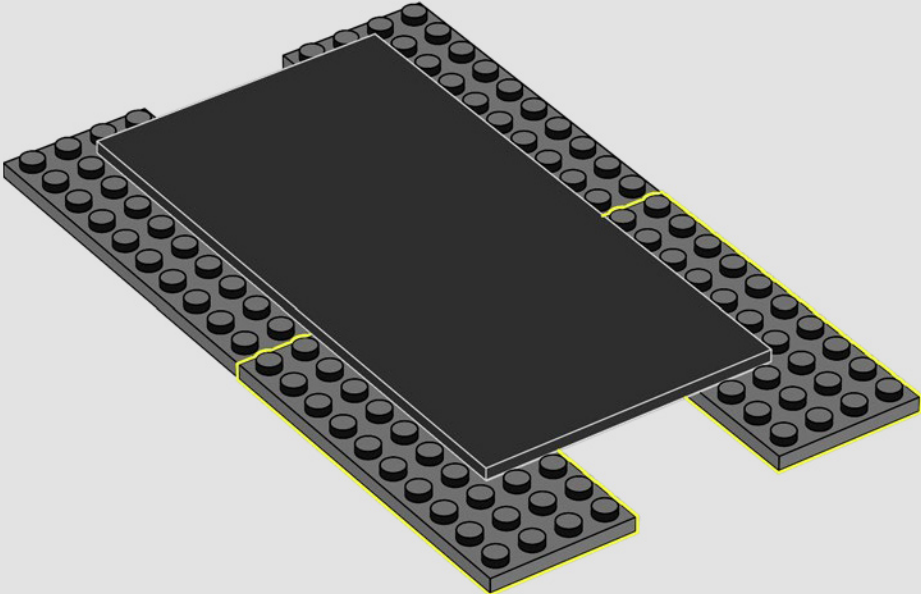

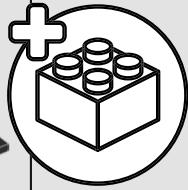
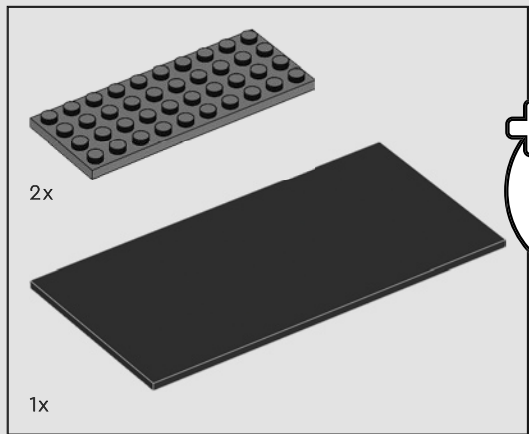

277

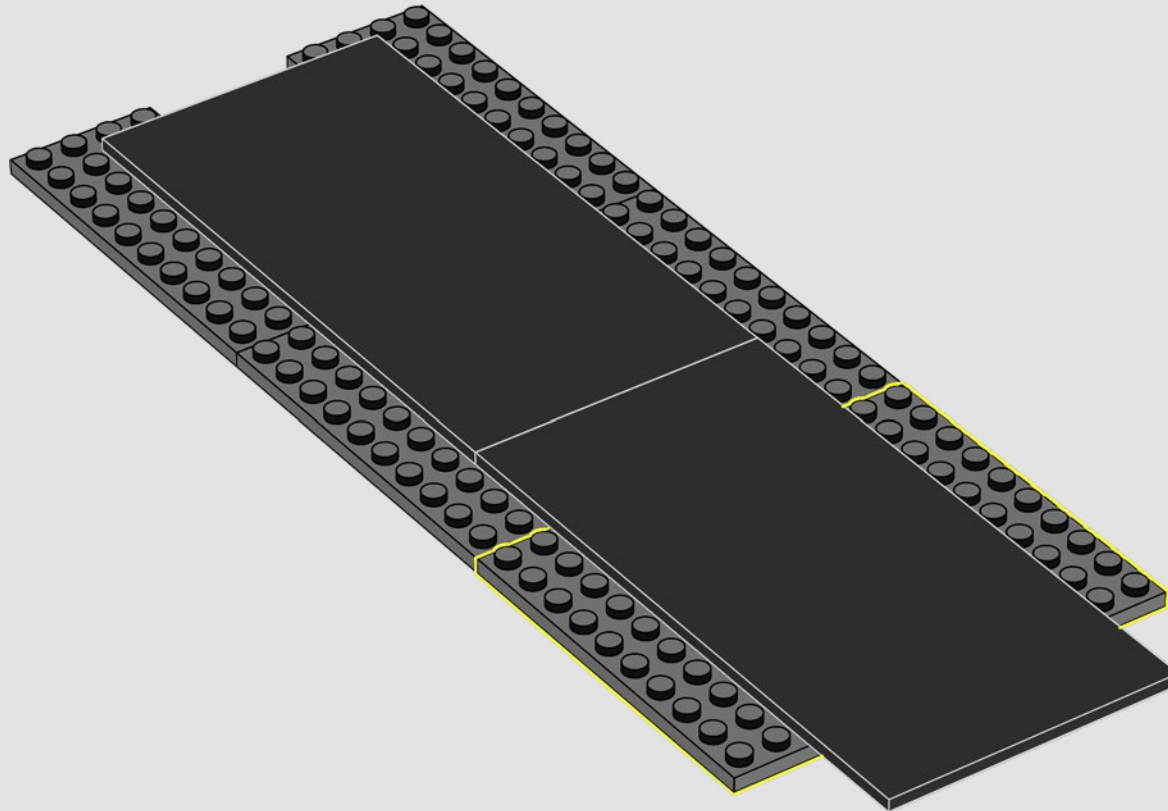

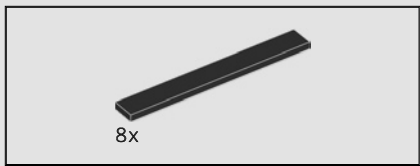

278

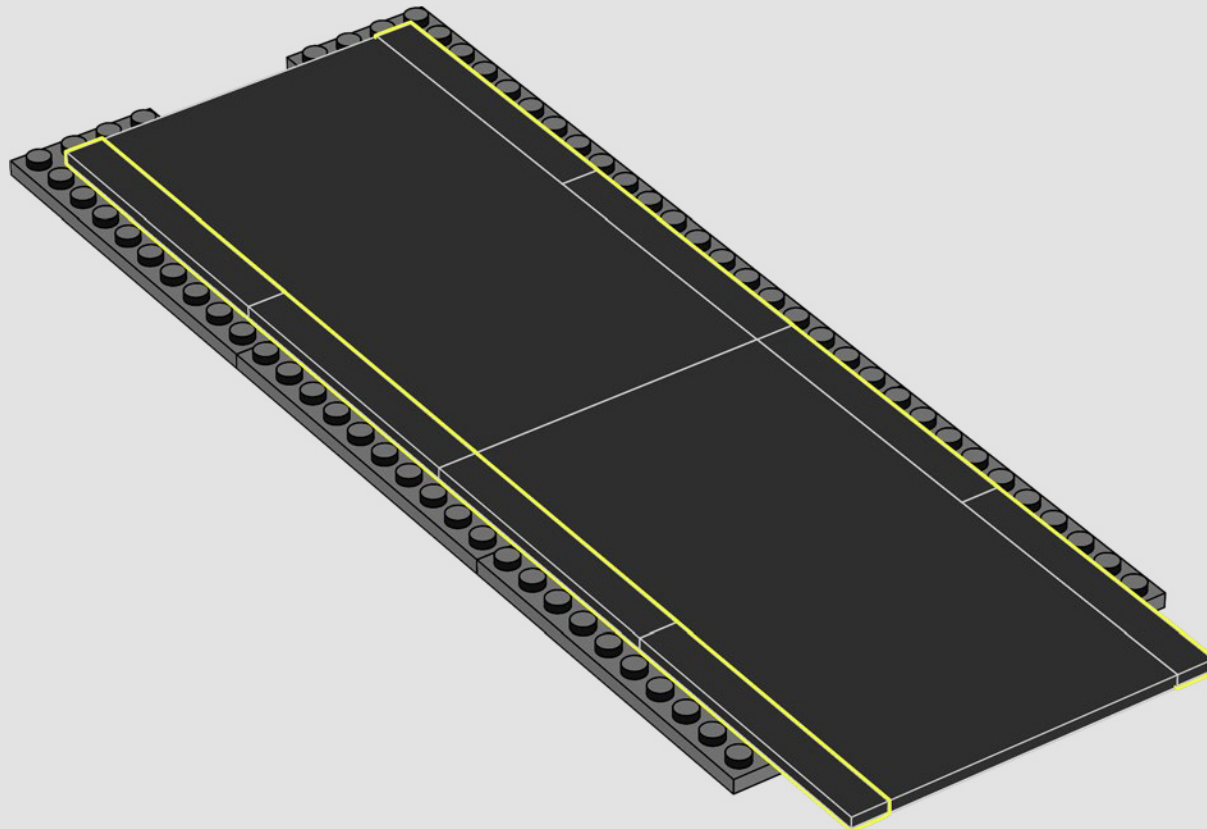

279

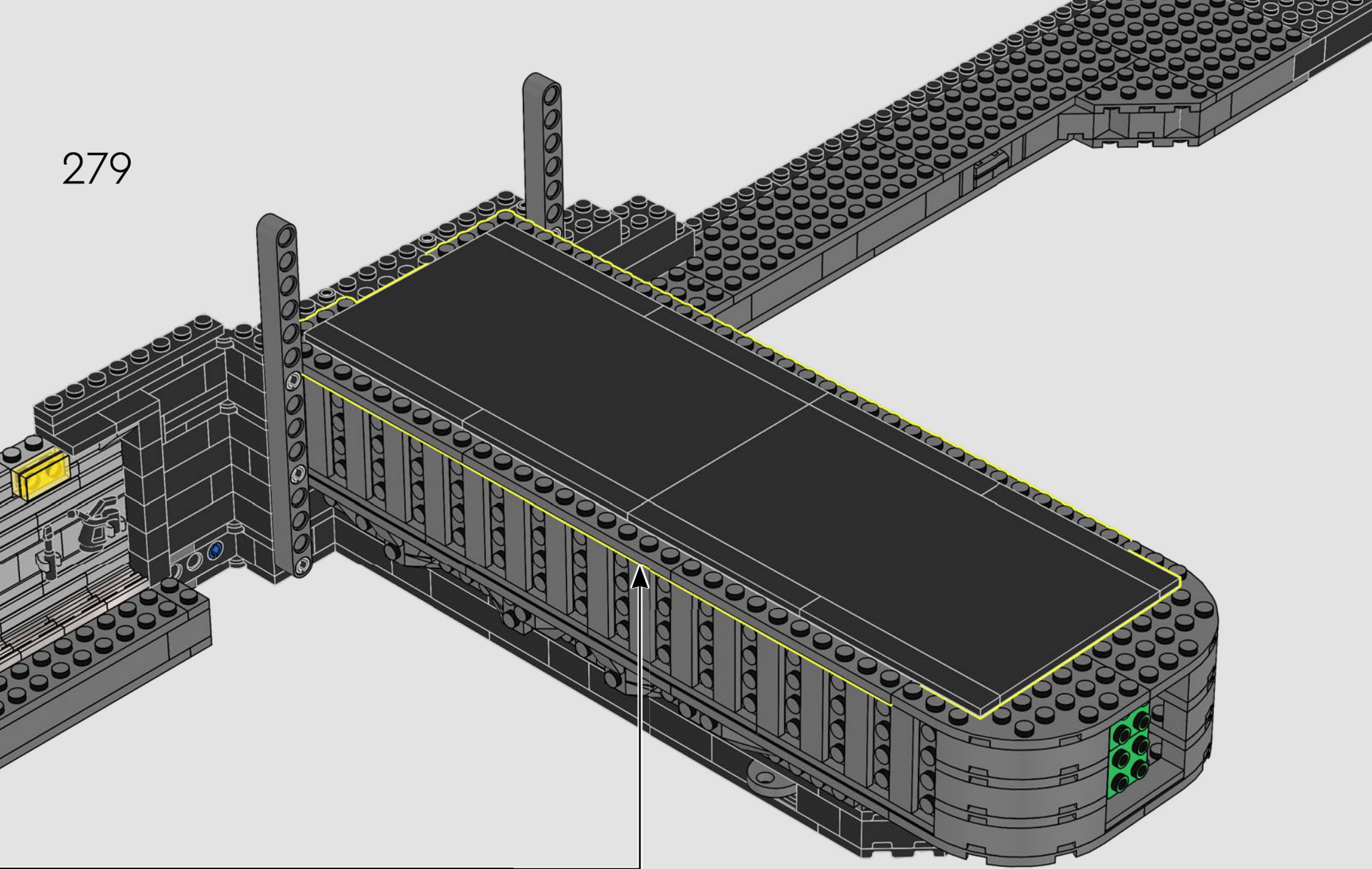



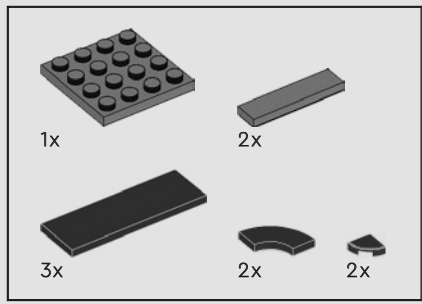

280

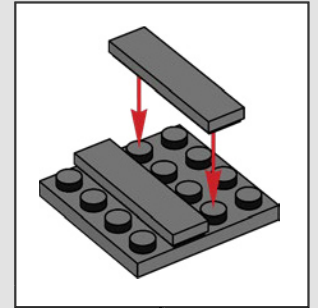
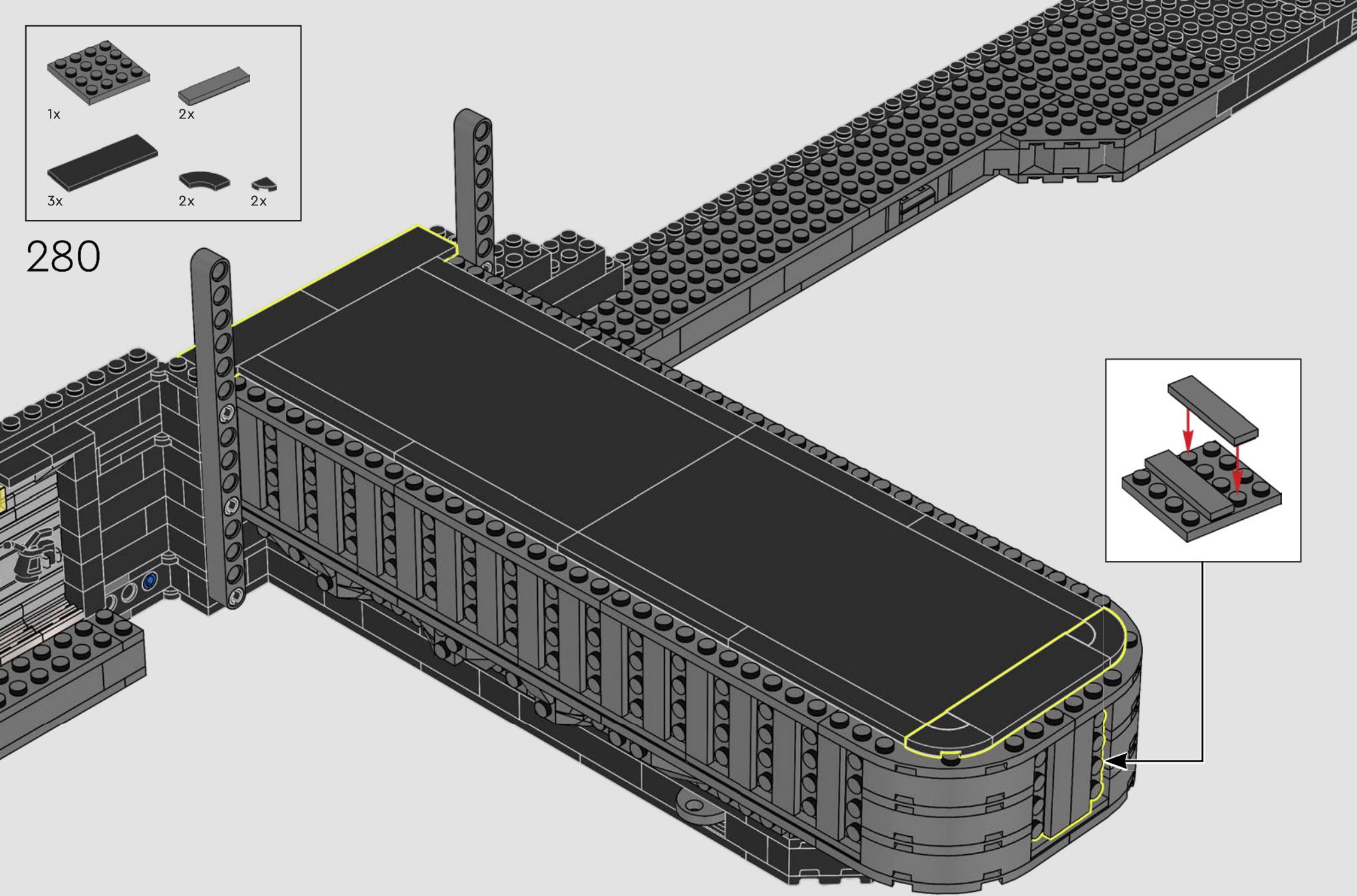



14x 14x

281

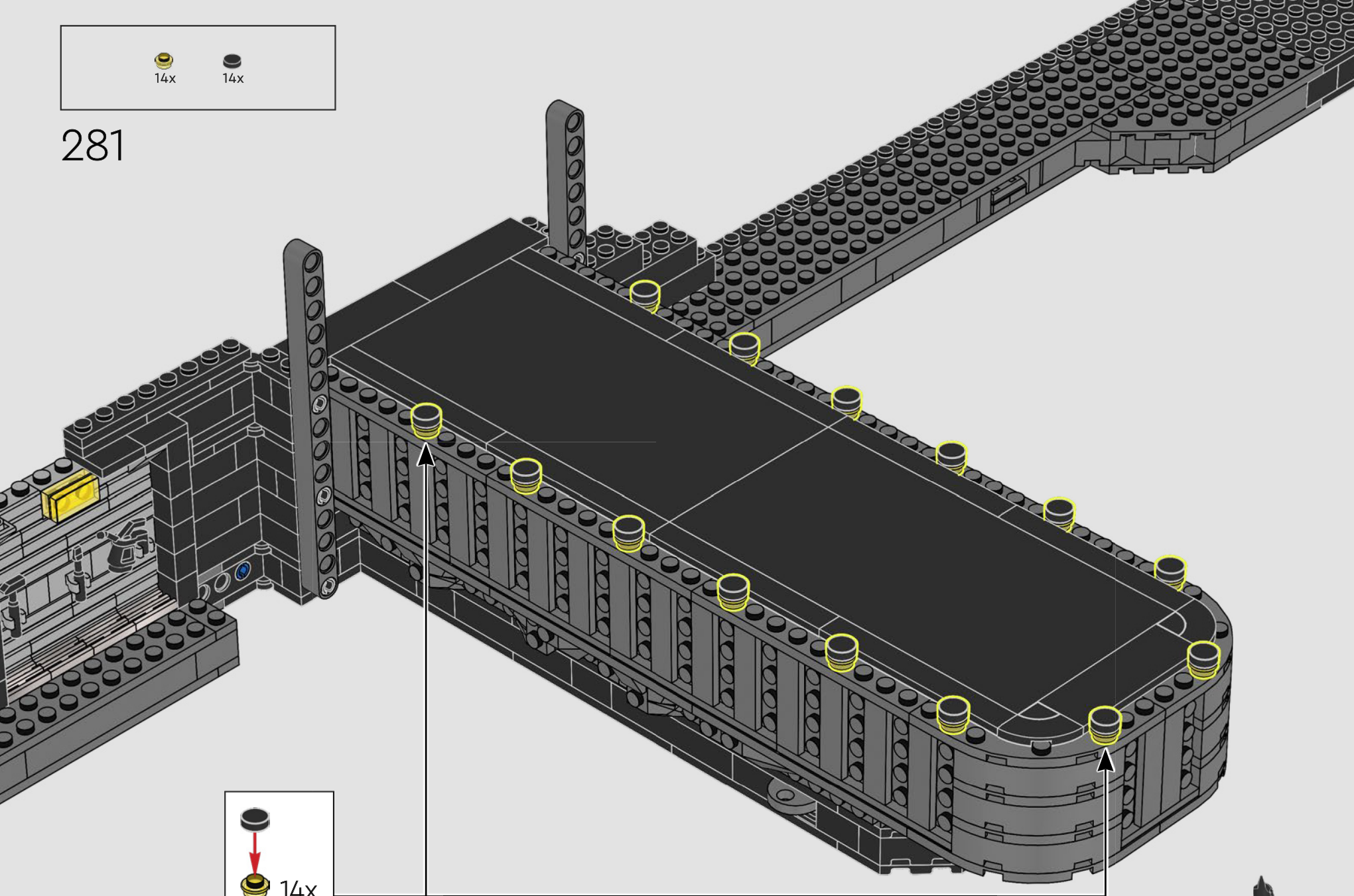

14x



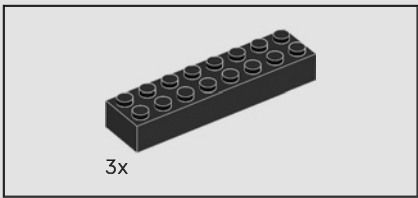

282

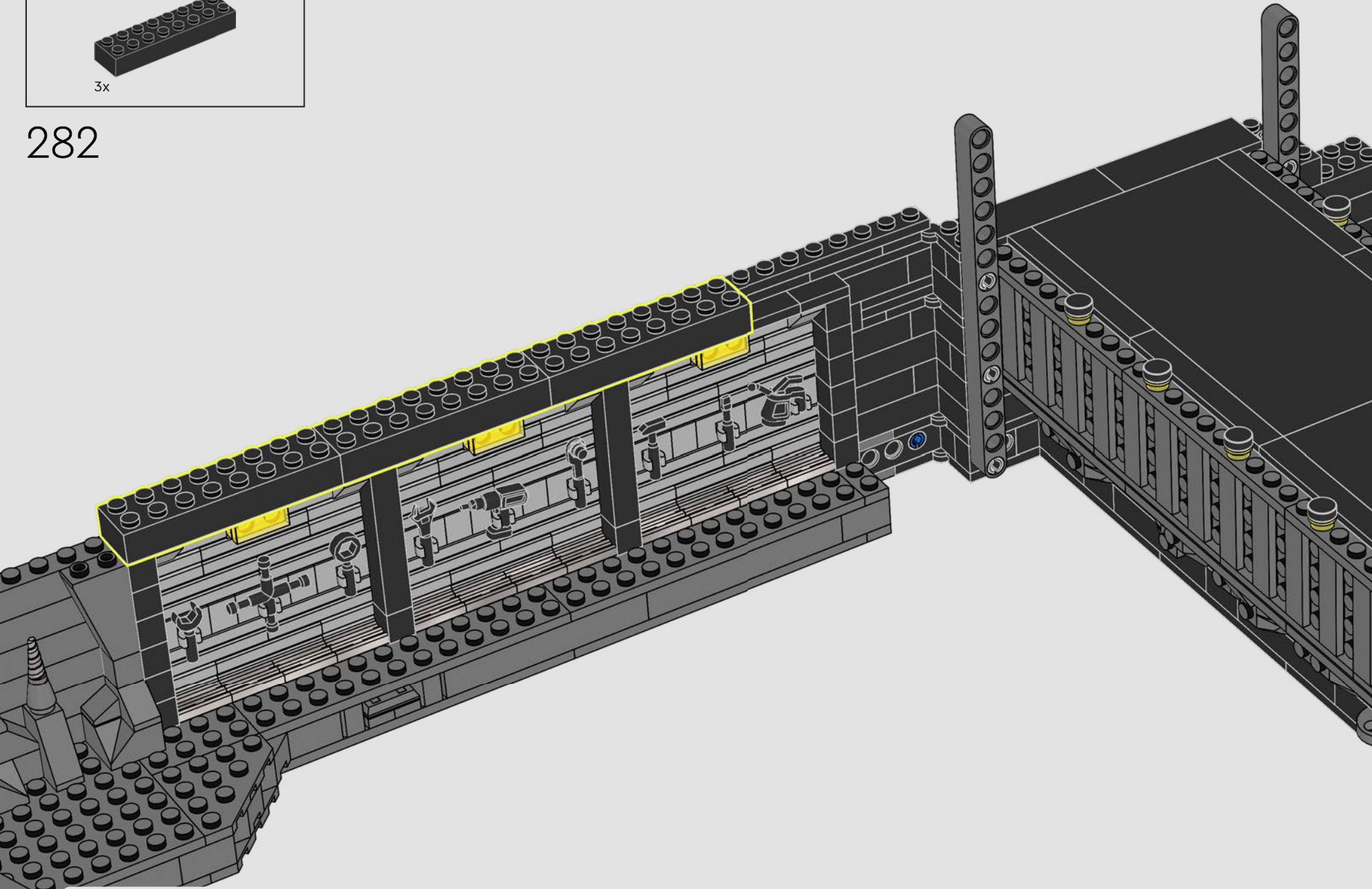



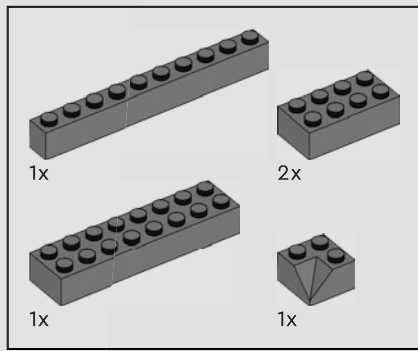

283

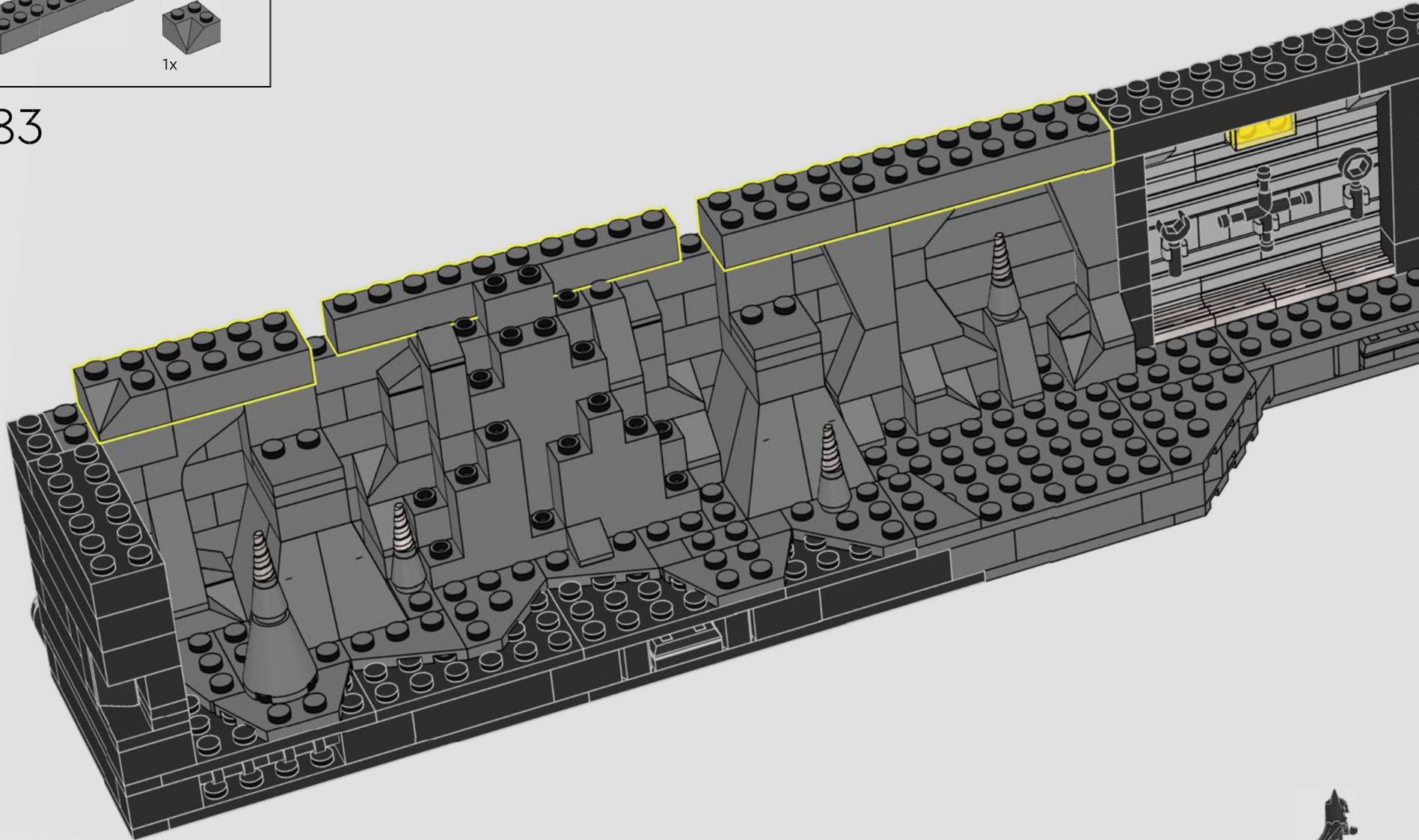

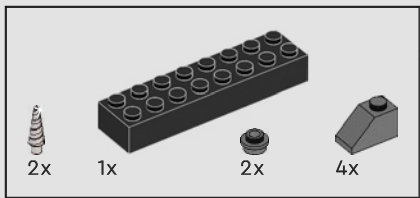

284

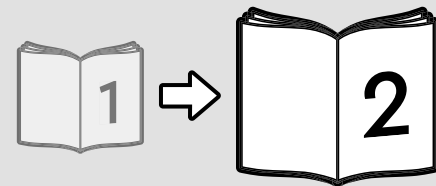
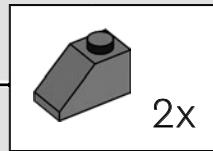
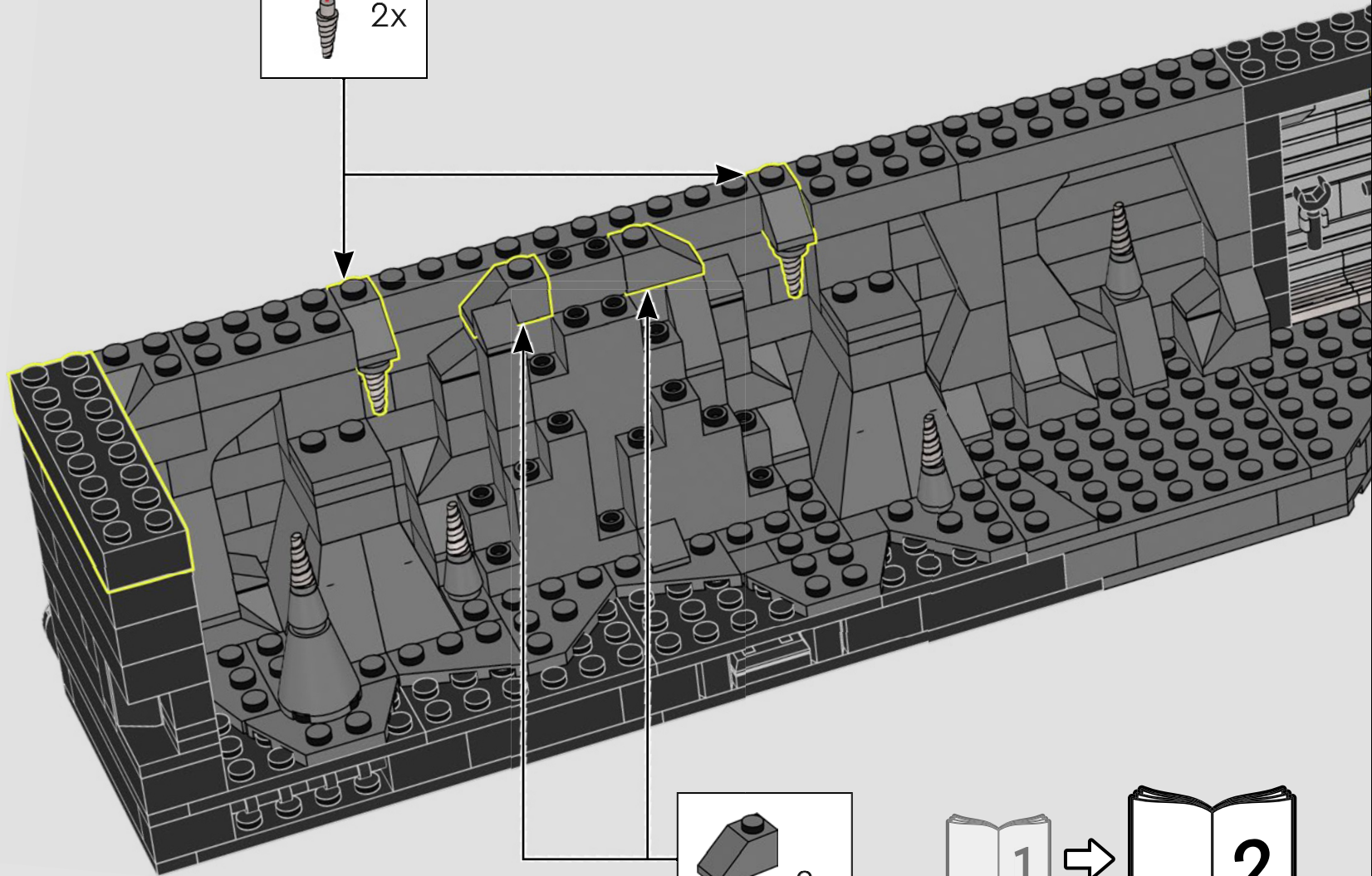
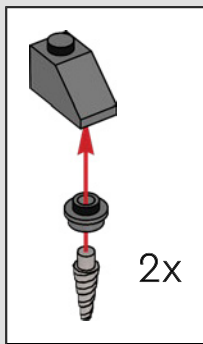



# YOU COULD WIN



## YOU COULD WIN

Your feedback will help shape the future development of this product series.

Visit:

## DU KÖNNTEST GEWINNEN

Dein Feedback trägt zur Weiterentwicklung dieser Produktreihe bei.

Geh auf:

## VOUS POURRIEZ GAGNER

Vos commentaires nous aideront à concevoir les futurs produits de cette gamme.

Visitez :

## POTRESTI VINCERE TU

La tua opinione ci aiuterà a migliorare la creazione futura di questa linea di prodotti.

Visita:

## PUEDES GANAR

Tu opinión contribuirá al futuro de esta serie de productos.

Visita:

## 轻松获奖

您的反馈将有助于我们在今后改进本产品系列。

请访问:

---

**[LEGO.com/productfeedback](https://LEGO.com/productfeedback)**

---

You also have the chance to win a LEGO® set.

Terms and conditions apply.\*

Außerdem hast du die Chance, ein LEGO® Set zu gewinnen.

Es gelten die Teilnahmebedingungen.\*

Vous pourriez également gagner un ensemble LEGO®.

Des conditions s'appliquent.\*

Hai anche la possibilità di vincere un set LEGO®.

Termini e condizioni sono applicabili.\*

También tienes la oportunidad de ganar un set LEGO®.

Aplican términos y condiciones.\*

您还有机会赢取乐高®套装。

条款和条件适用。\*

\*[LEGO.com/productfeedback-terms](https://LEGO.com/productfeedback-terms)



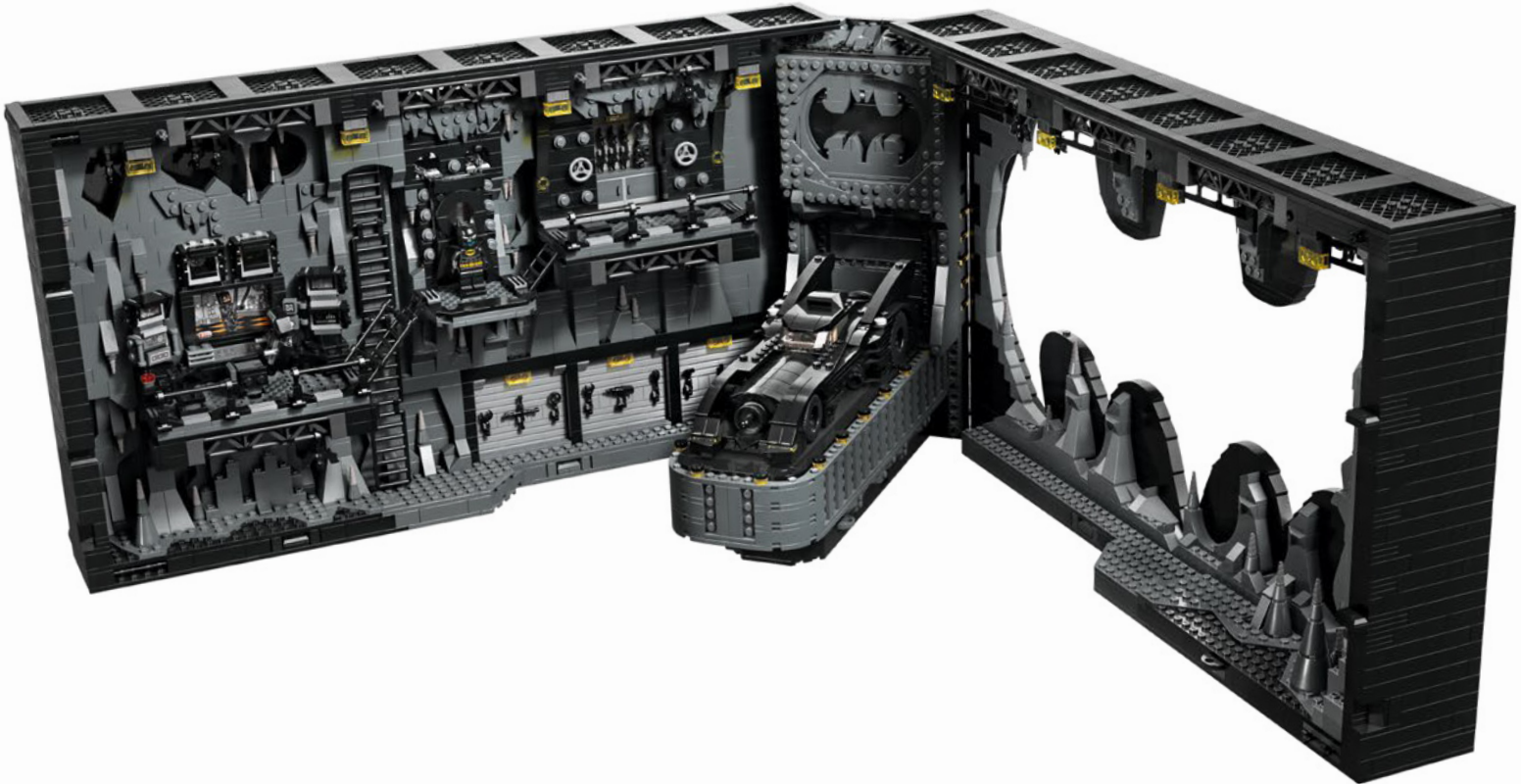

## 76252

LEGO and the LEGO logo are trademarks of the LEGO Group. ©2023 The LEGO Group.  
BATMAN RETURNS and all related characters and elements © & ™ DC and Warner Bros. Entertainment Inc. (s23)

