



Harry Potter

WIZARDING
WORLD

76432



Q LEGO® Builder



LEGO.com/sustainable-packaging



 ^{FR} **DONNEZ**
OU
RECYCLEZ

 OU  OU 

ASSOCIATION MAGASIN DÉCHÈTERIE

Adresses sur quefairedemesdechets.fr

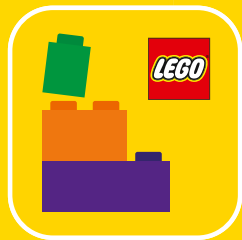

Q LEGO® Builder

BUILDER



Apple and the Apple logo are trademarks of Apple Inc., registered in the U.S. and other countries and regions. App Store is a service mark of Apple Inc. Google Play and the Google Play logo are trademarks of Google LLC. Tencent and the Tencent logo are trademarks of Tencent Inc.

Q LEGO.com/devicecheck

EN Ask parents' permission before going online | DE Eltern um Erlaubnis bitten, bevor du online gehst | FR Demande l'autorisation d'un parent avant d'aller en ligne | IT Chiedi il permesso ai tuoi genitori prima di andare online | ES Pídeles permiso a tus papás antes de conectarte a Internet | PT Pede autorização aos pais antes de acederes online | ZH 上网前应先征得父母的同意 | PL Poproś rodziców o zgodę, zanim wejdiesz do Internetu | CS Než půjdeš na internet, požádej rodiče o svolení | SK Skôr než pôjdeš na internet, vypýtaj si povolenie od rodičov | HU Kérj szülői engedélyt, mielőtt online csatlakoznál! | RO Cere permisiunea părinților înainte de a te conecta online | BG Поискайте разрешение от родител, преди да влезете онлайн | LV Pirms došanās tiešsaistē palūdz atļauju vecākiem | ET Enne Interneti kasutamist küsi vanematelt luba | LT Prieš prisijungdami prie interneto, atsiklauskite tėvų



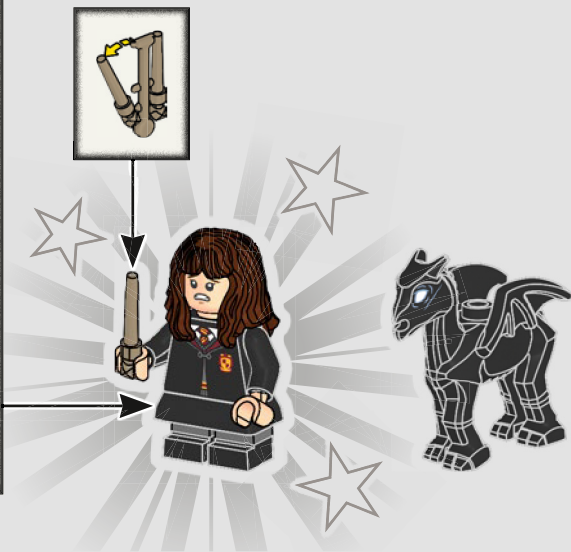
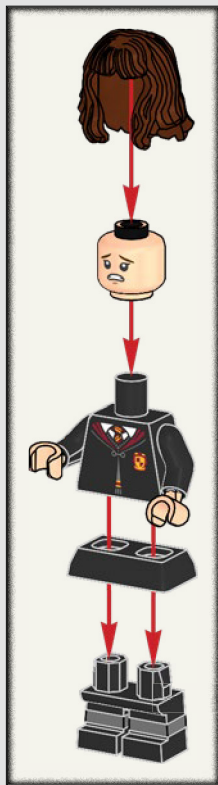

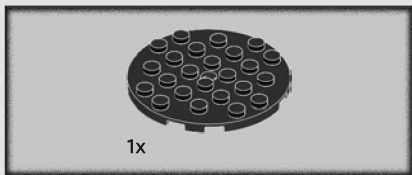
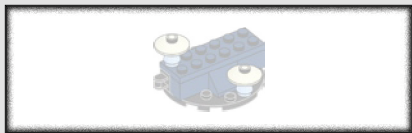

1x

1

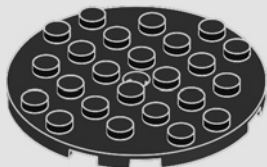

2x

2

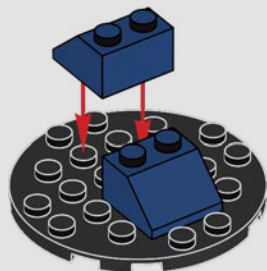

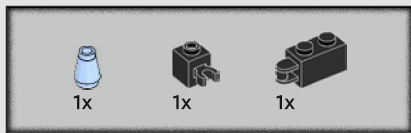

3

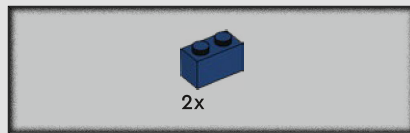
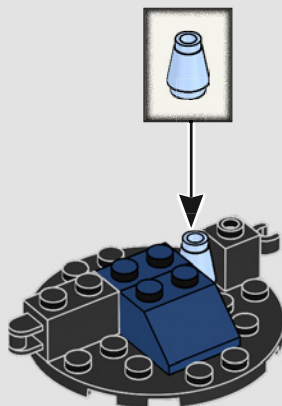

4

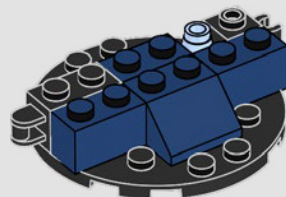

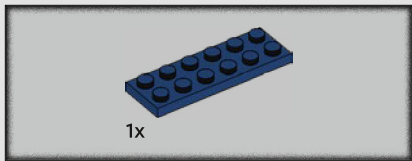

5

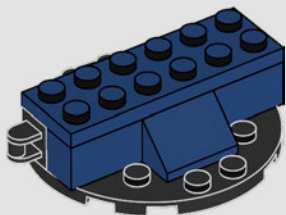

8



6

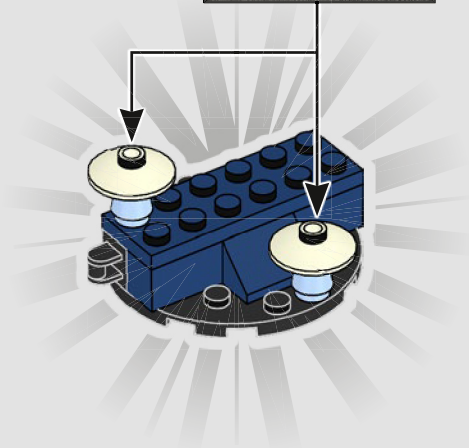
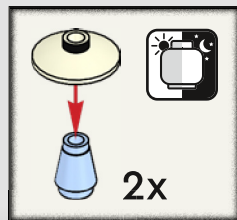

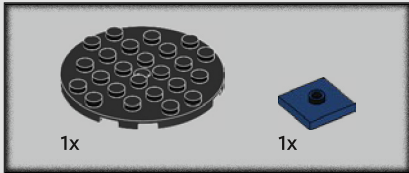
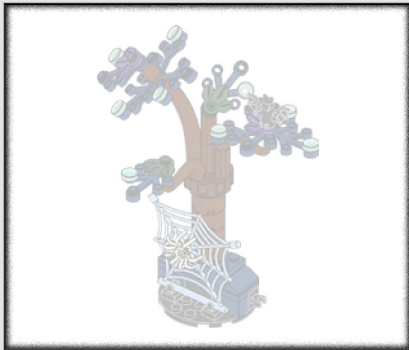

1

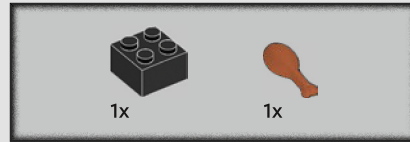
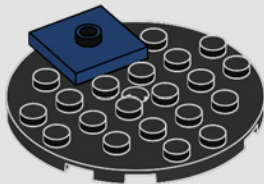

2

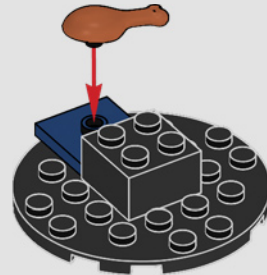

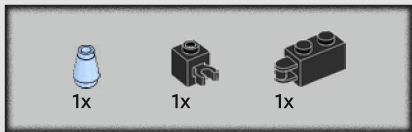

3

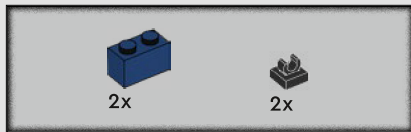
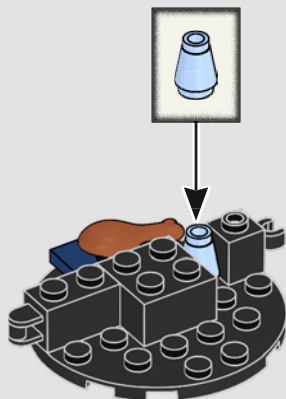

4

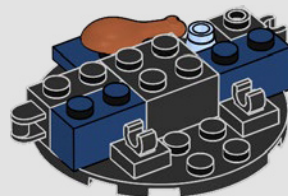

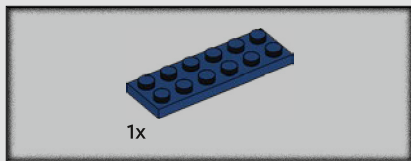

5

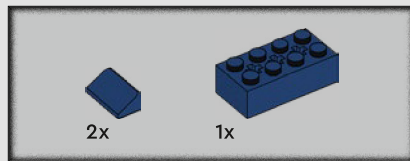
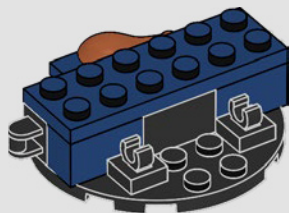

6

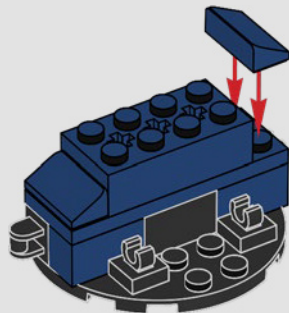

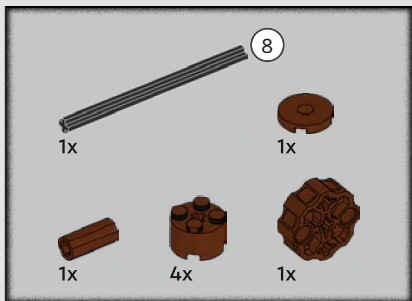
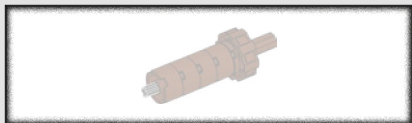

7

1

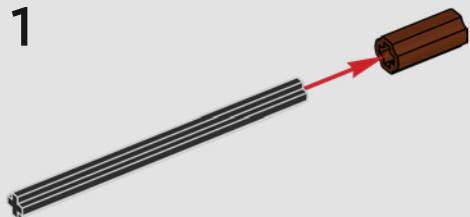

2

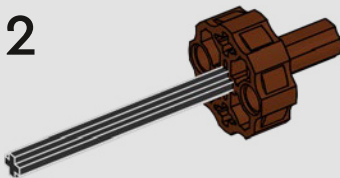

3

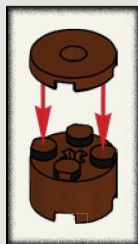
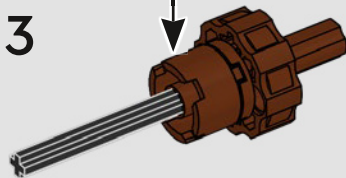

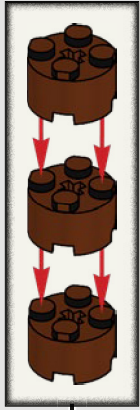

4

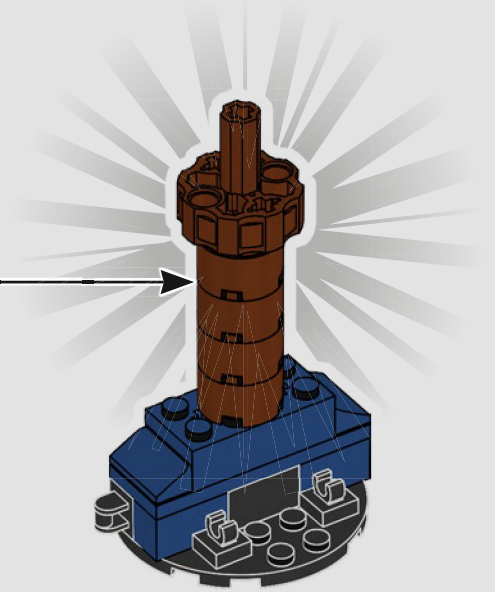
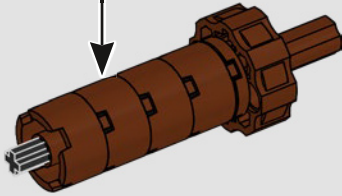

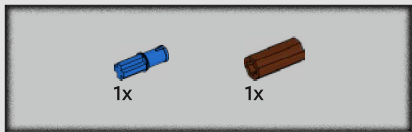

8

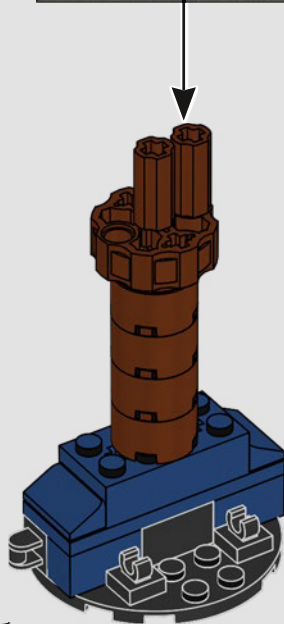
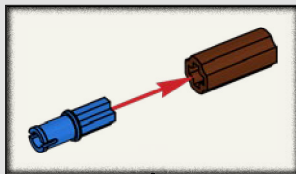

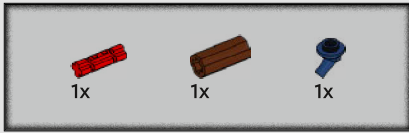

9

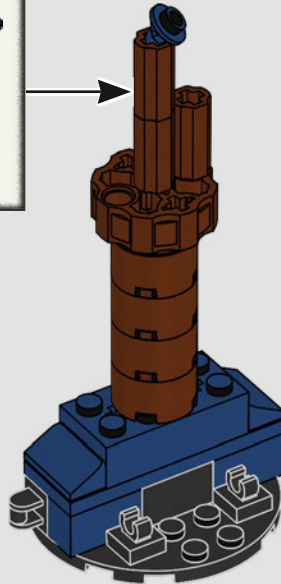
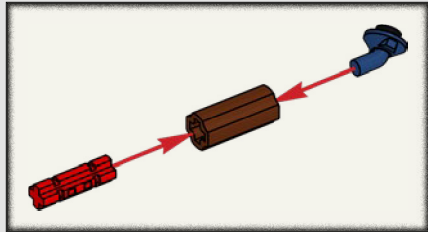

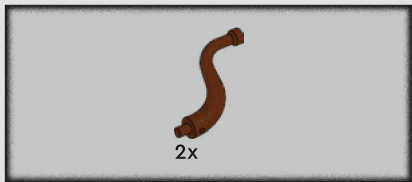

10

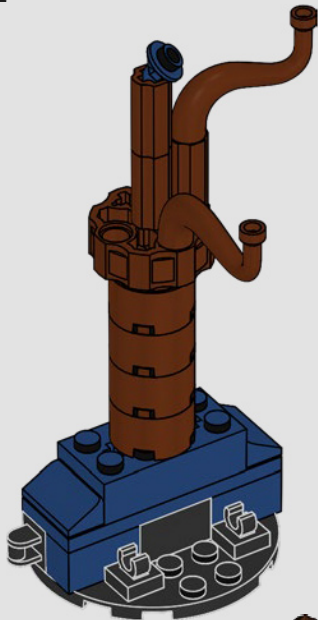

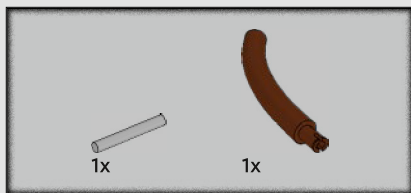

11

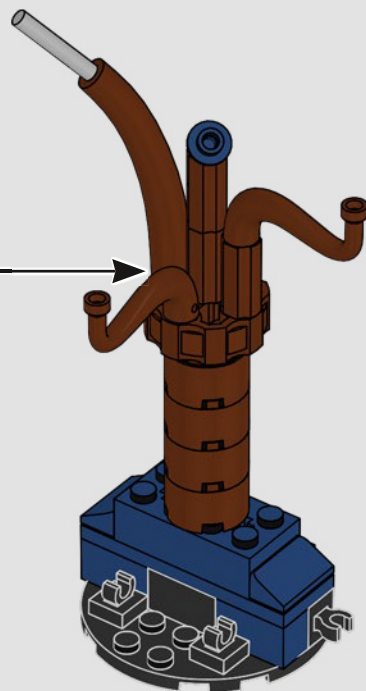
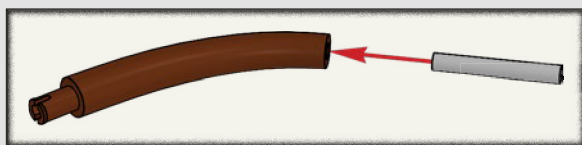



12

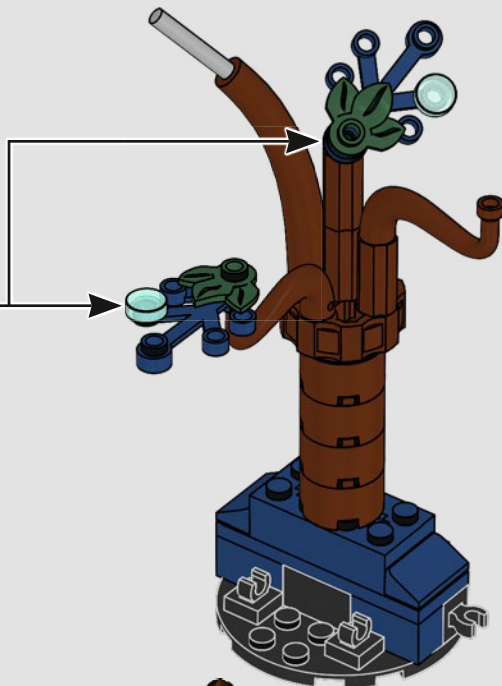
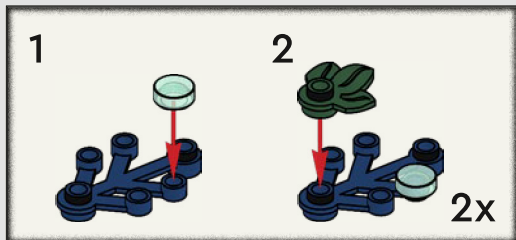

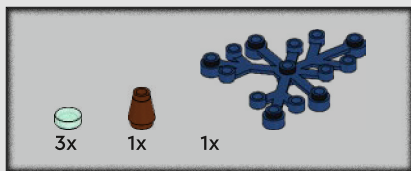

13

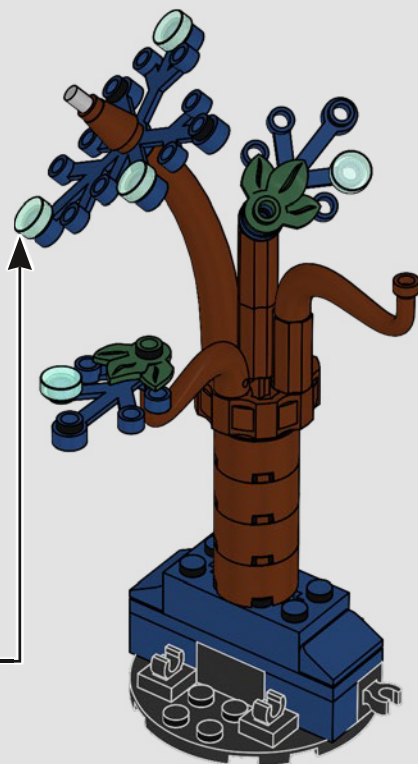
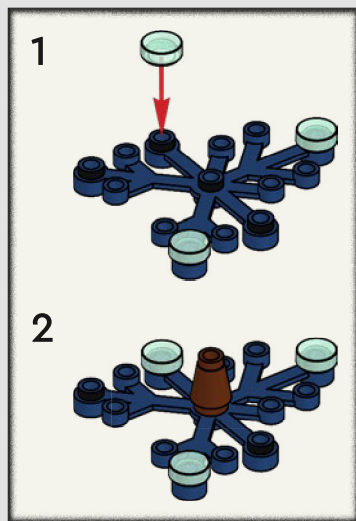



14

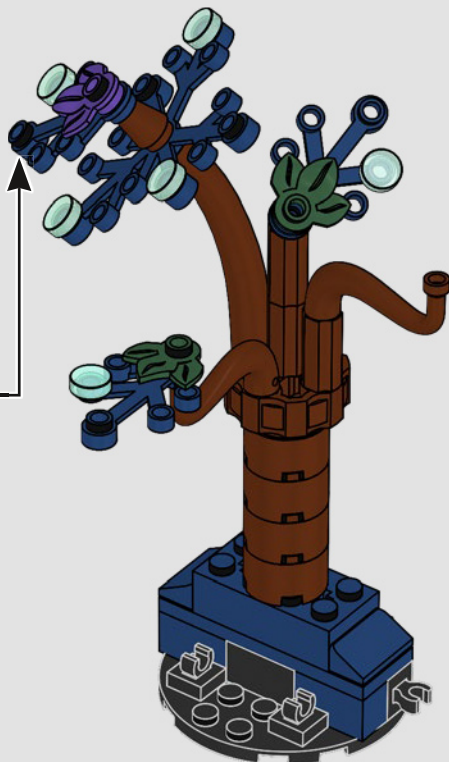
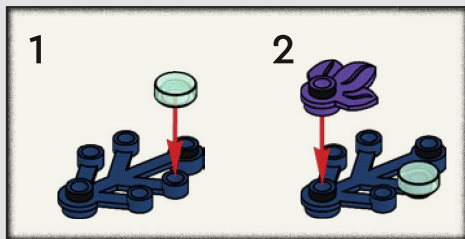

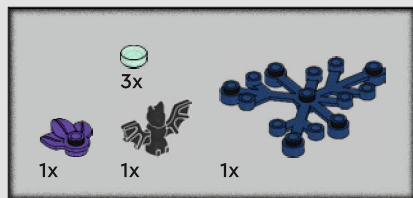

15

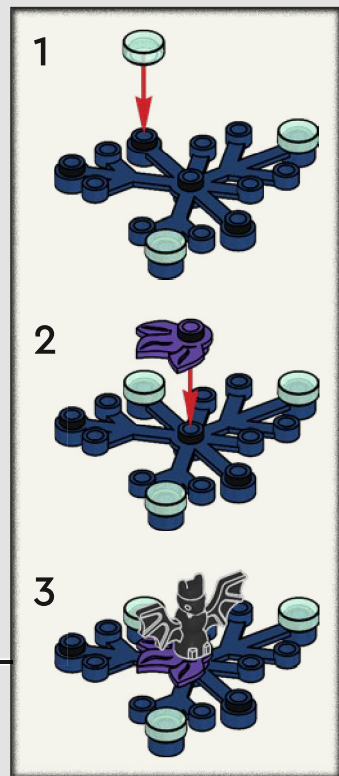
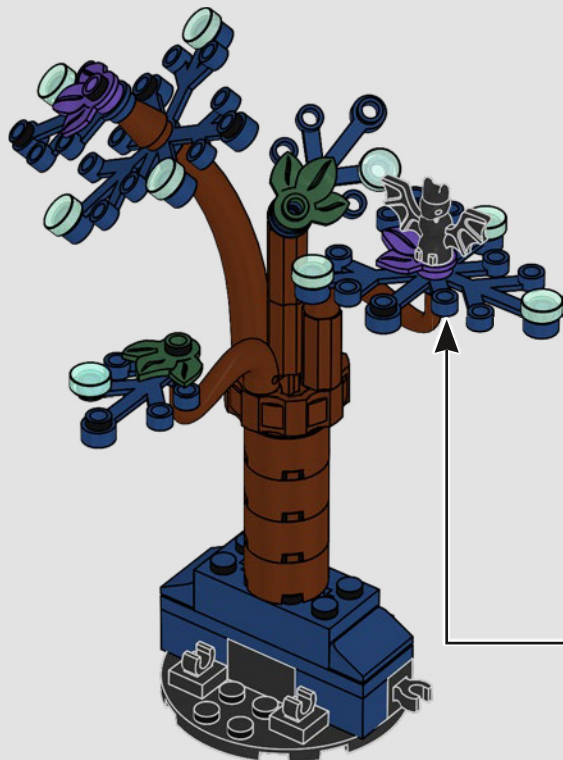

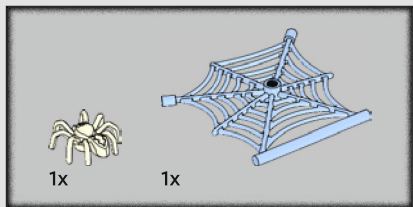

16

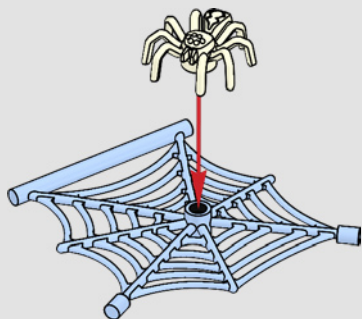

17

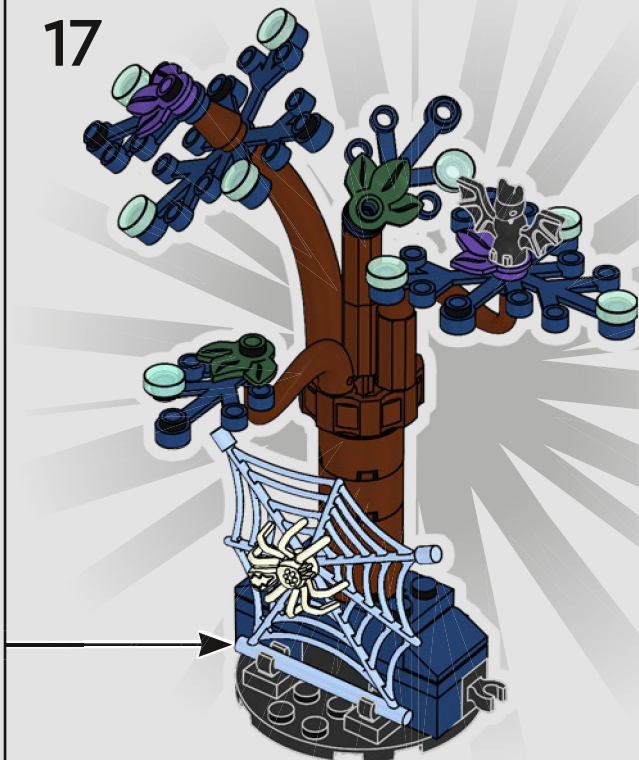

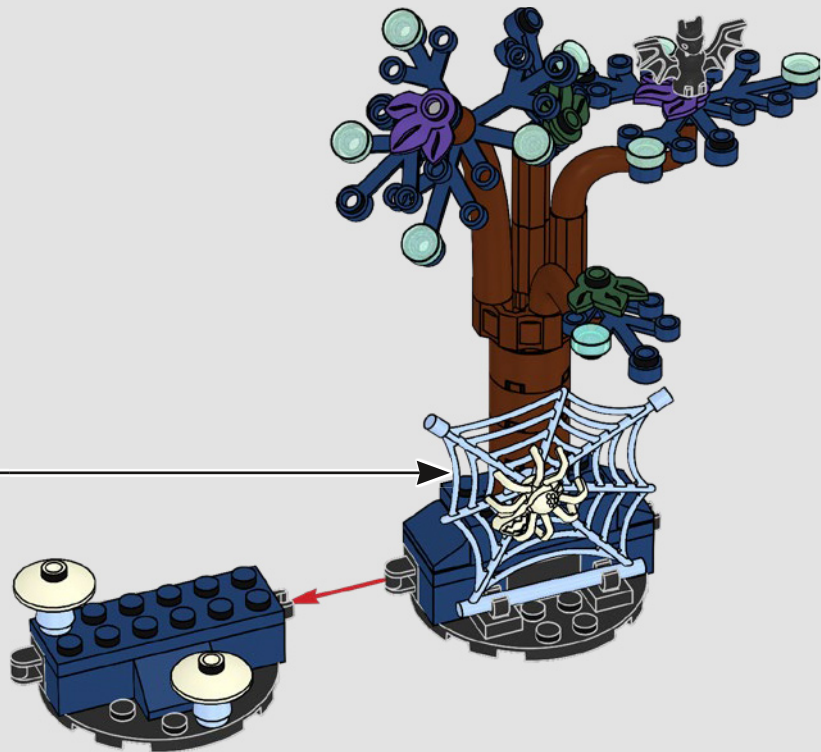

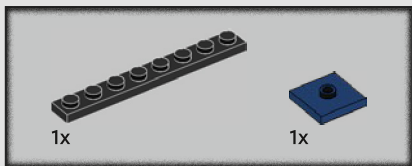
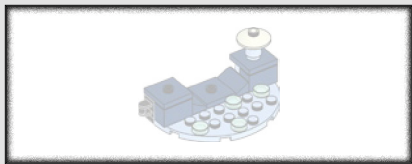

1

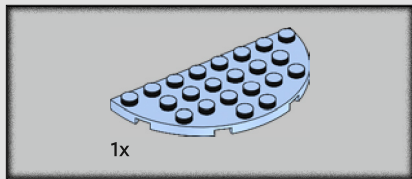
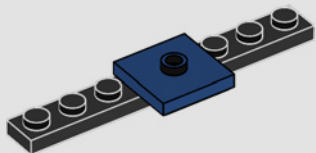

2

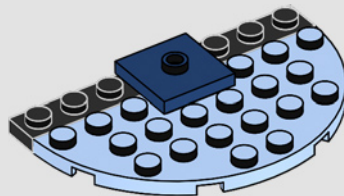

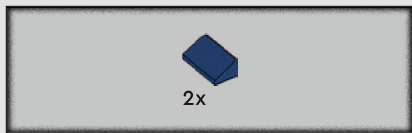

3

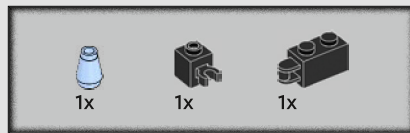
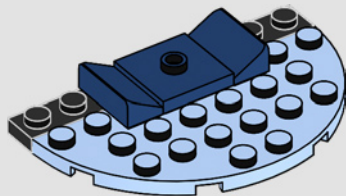

4

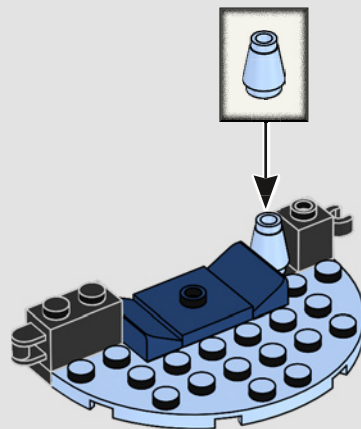

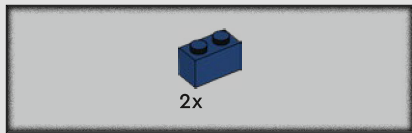

5

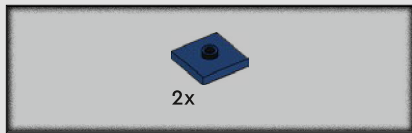
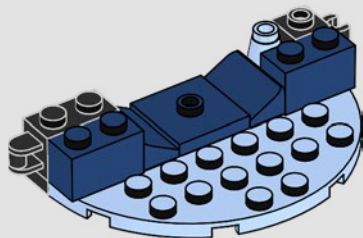

6

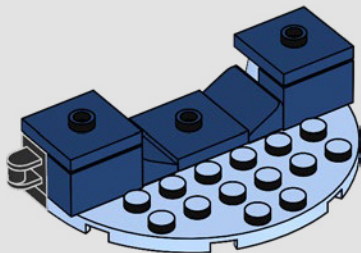

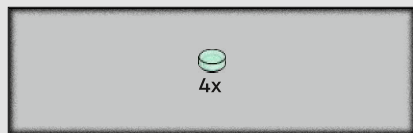

7

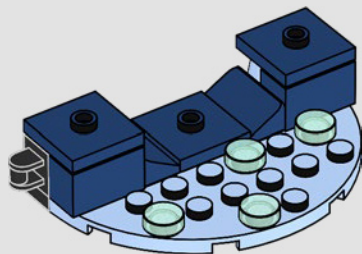

8

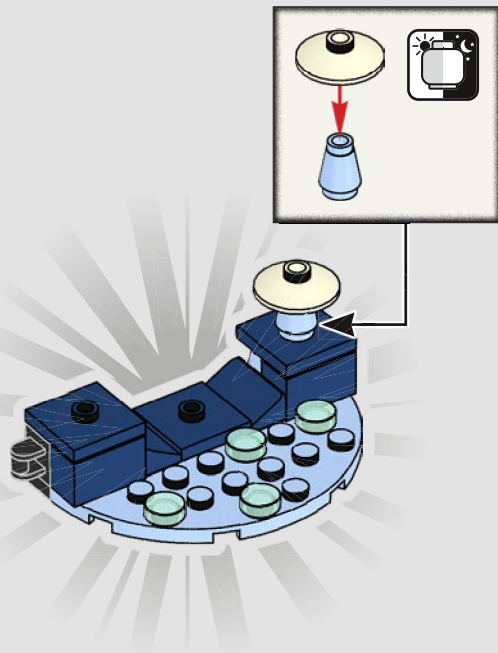

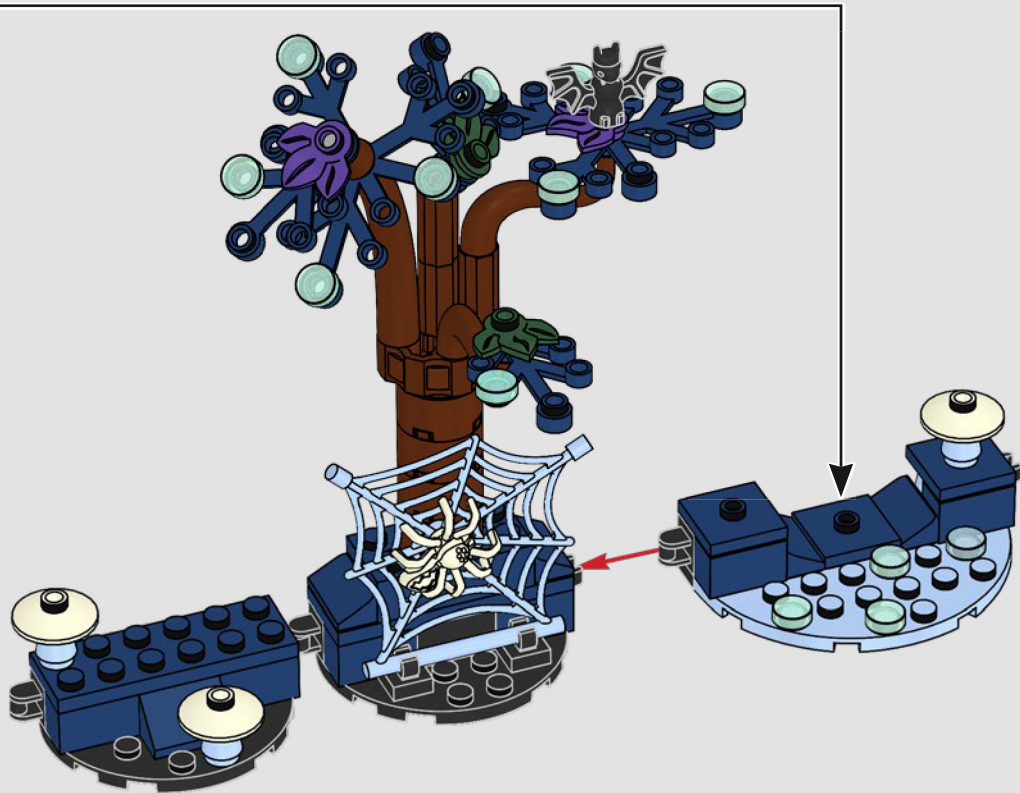

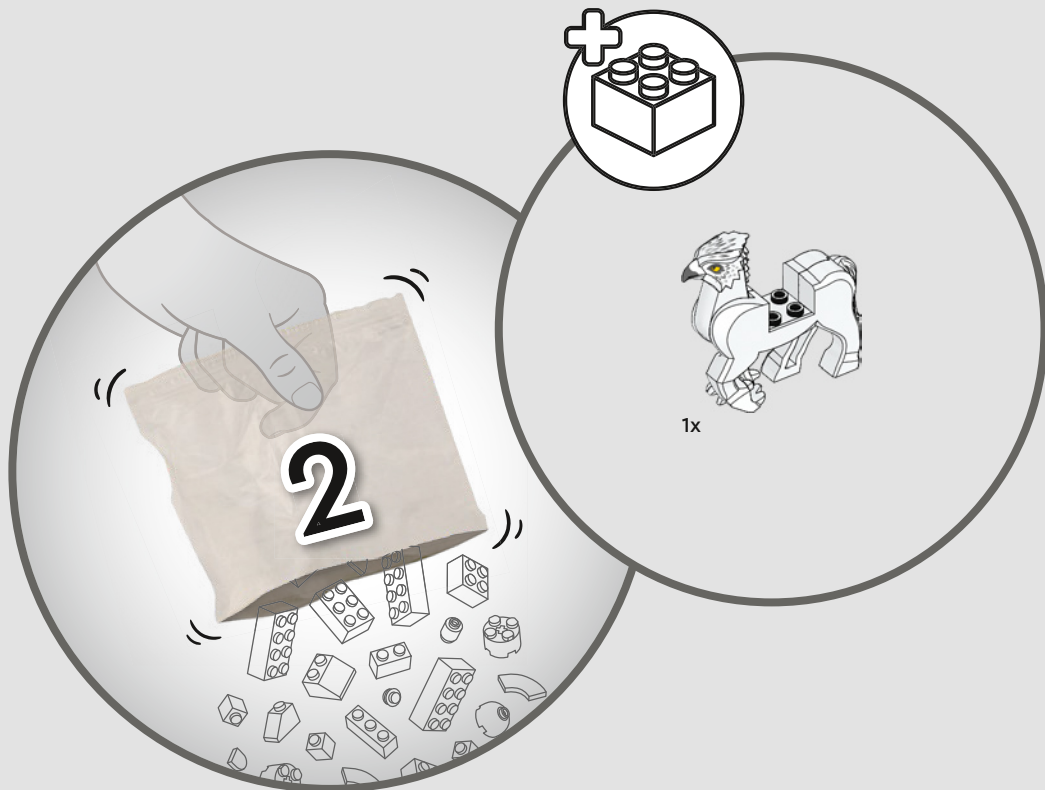

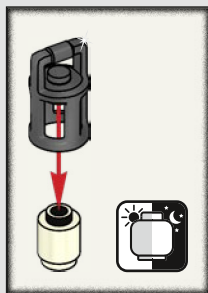
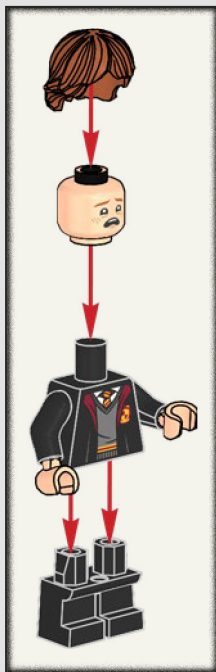

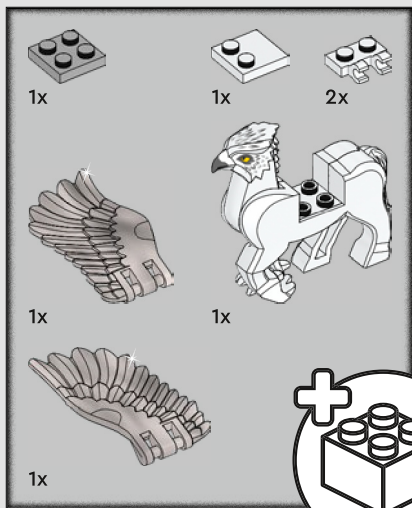

1

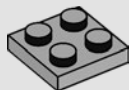

2

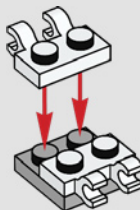

3

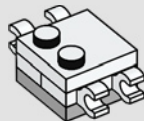

4

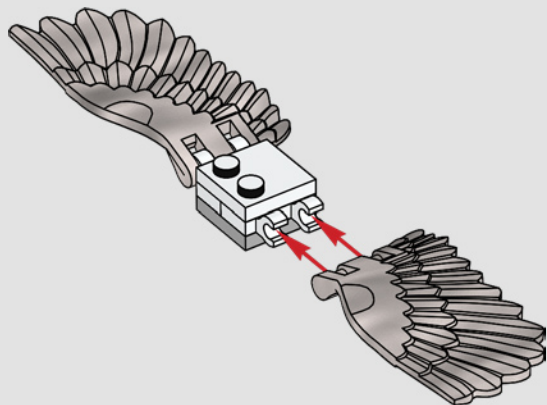

5

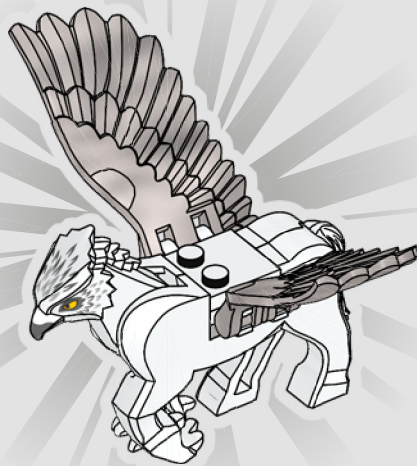

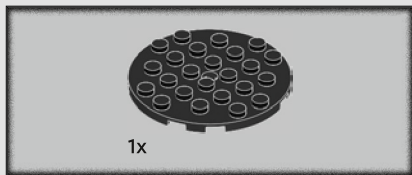
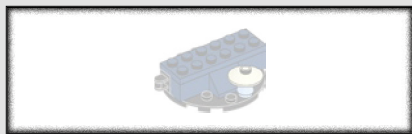

1

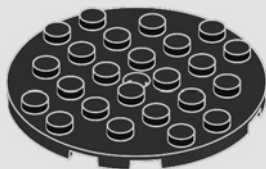

2

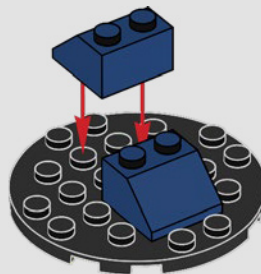

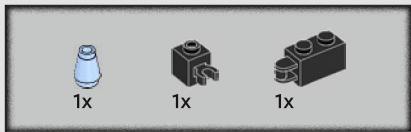

3

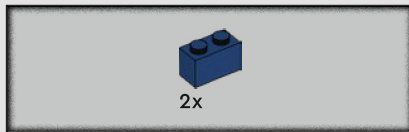
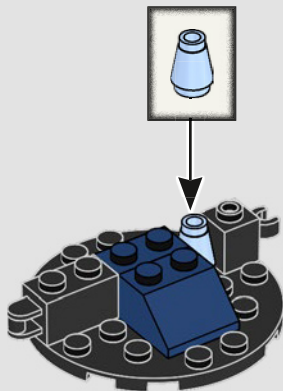

4

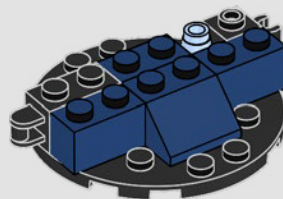

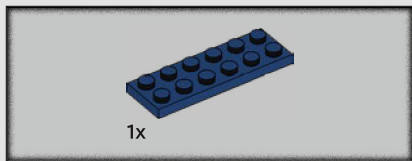

5

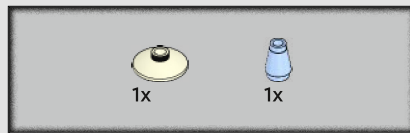
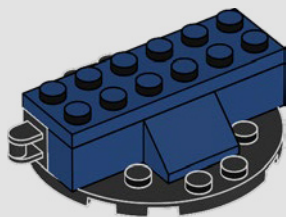

6

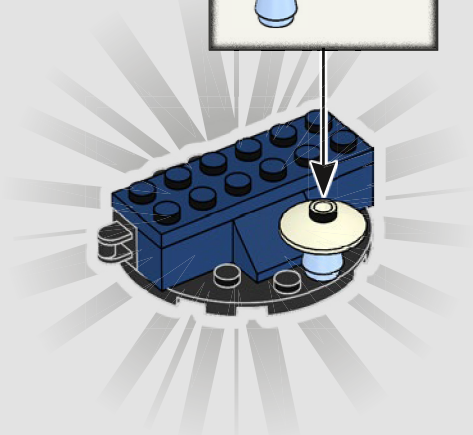
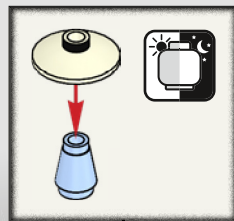

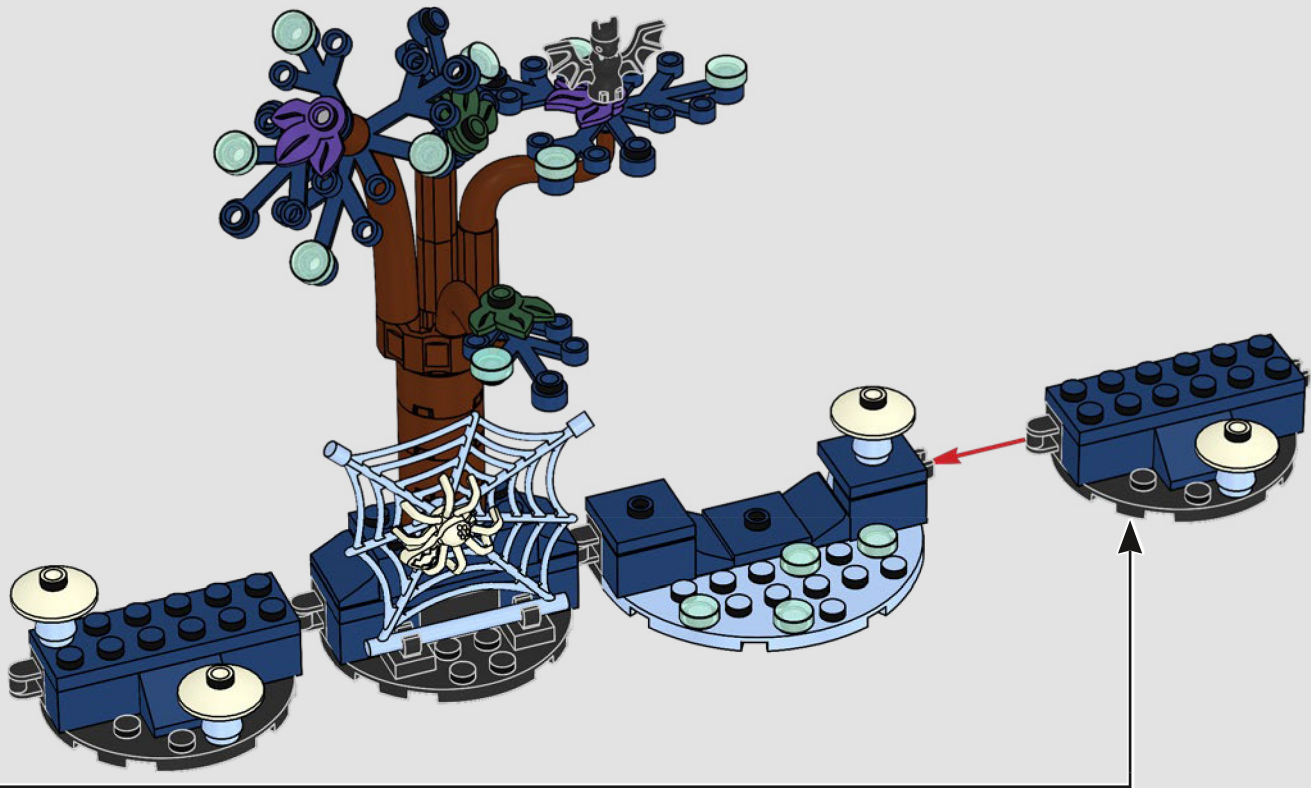

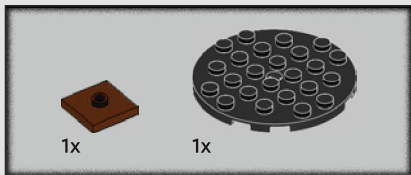

1

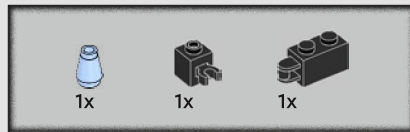
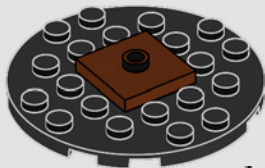

2

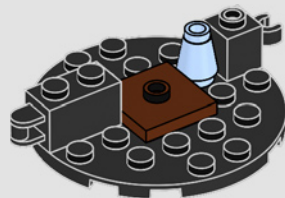

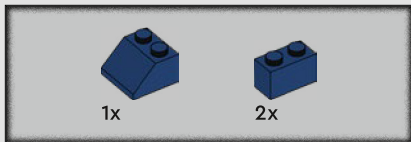

3

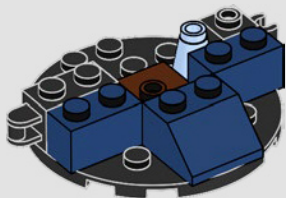

4



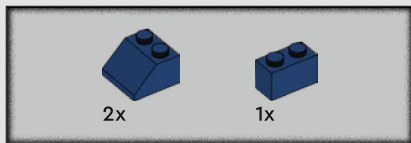

5

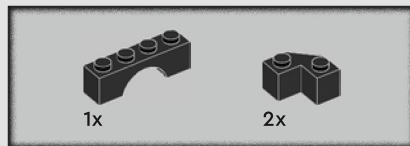
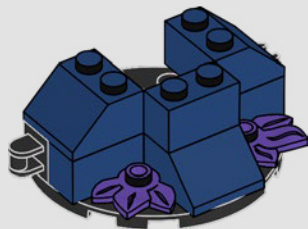

6

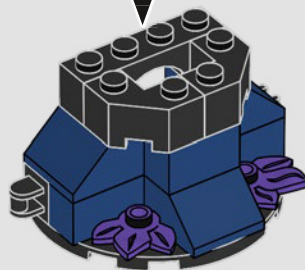
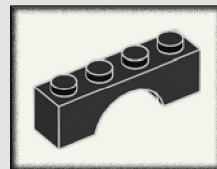

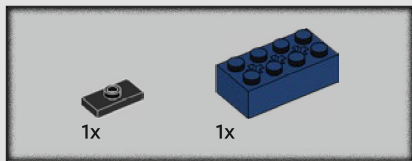

7

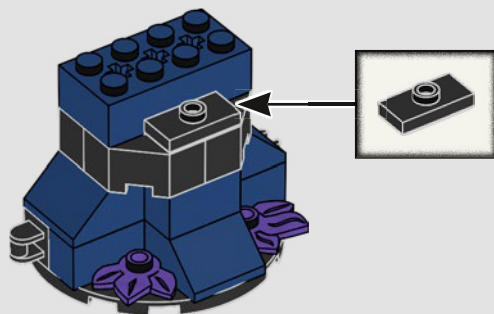

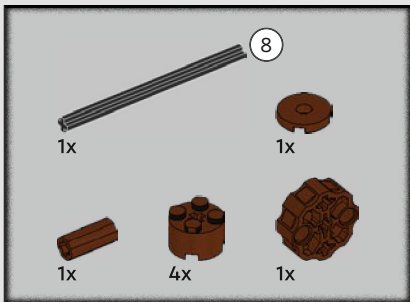
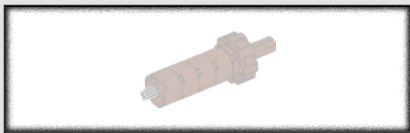

8

1

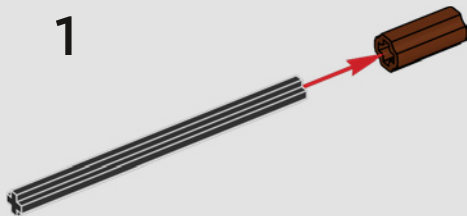

2

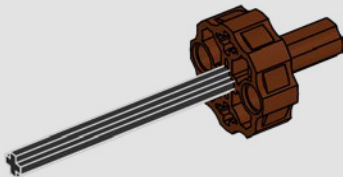

3

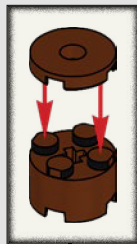
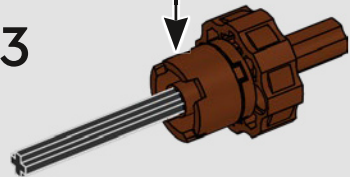

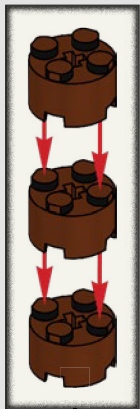

4

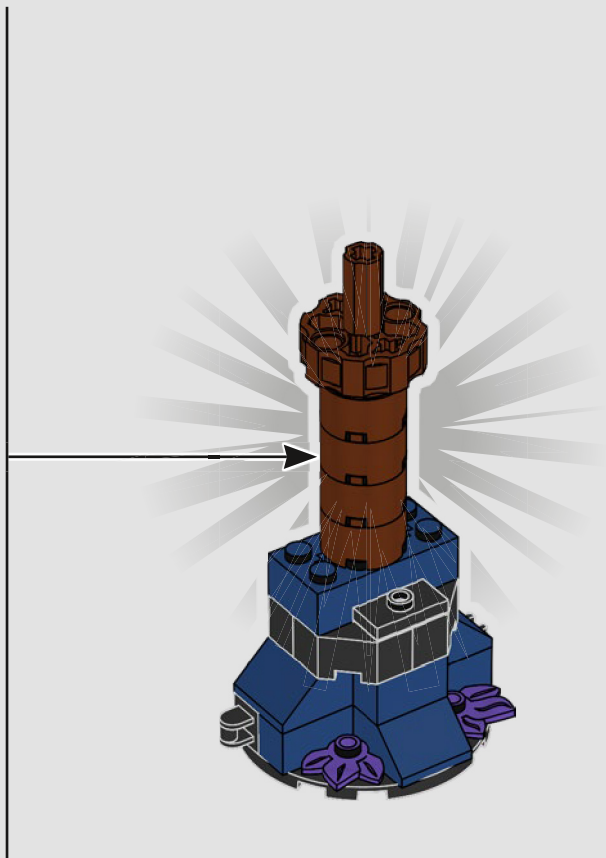
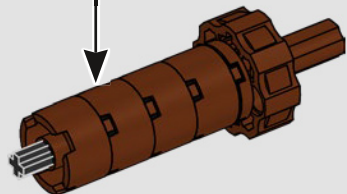

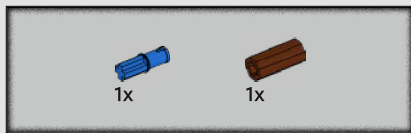

9

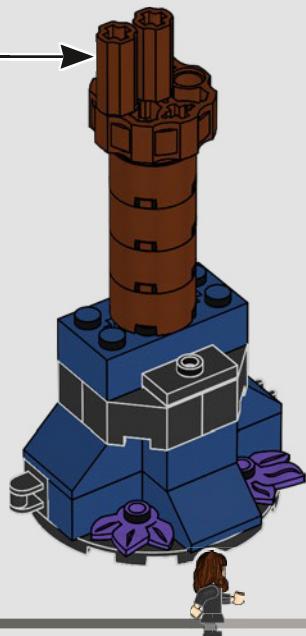
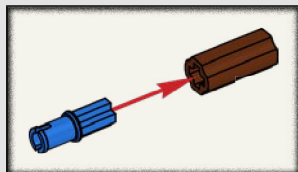

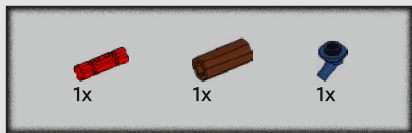

10

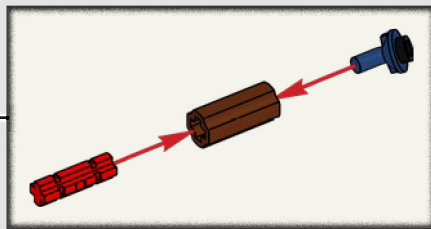
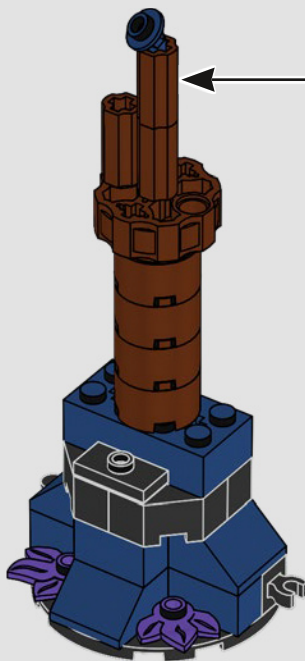



11

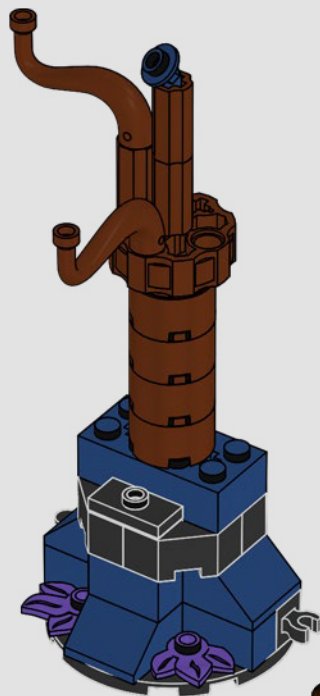

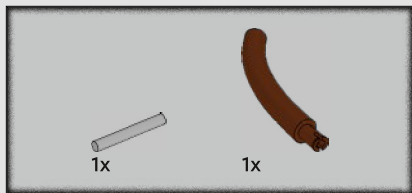

12

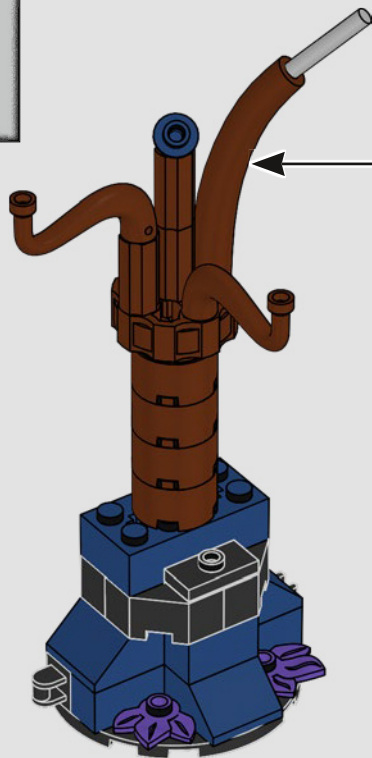



13

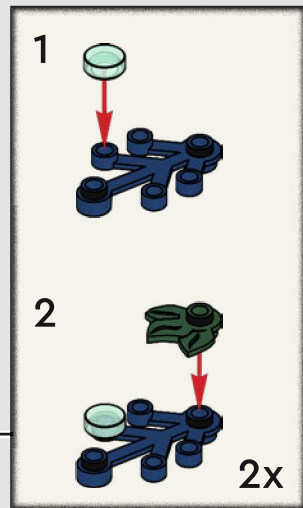
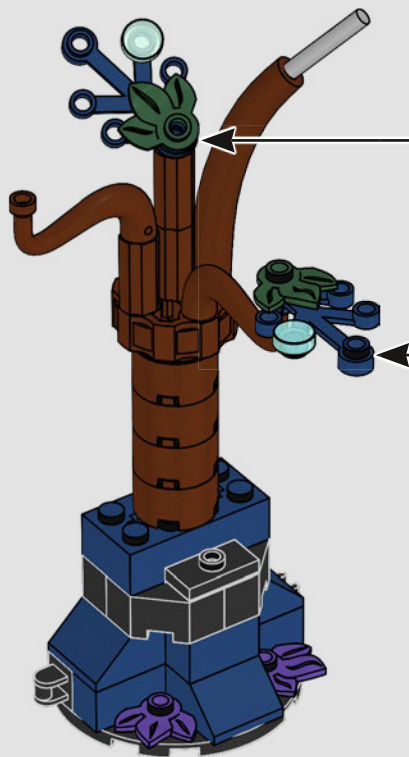

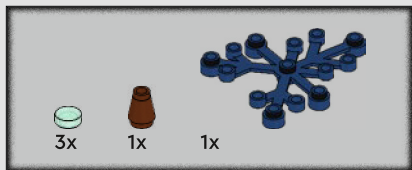

14

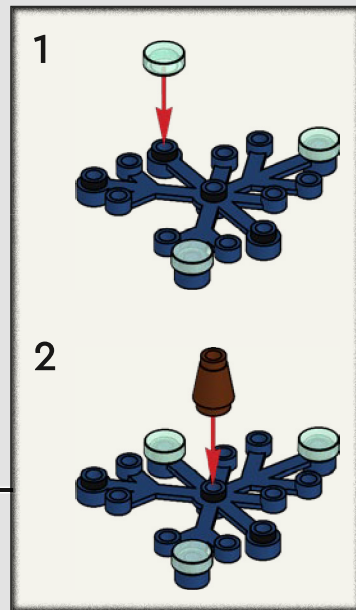
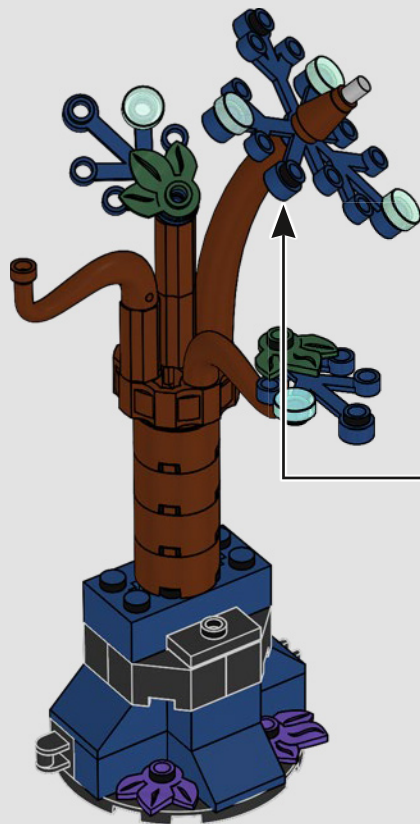



15

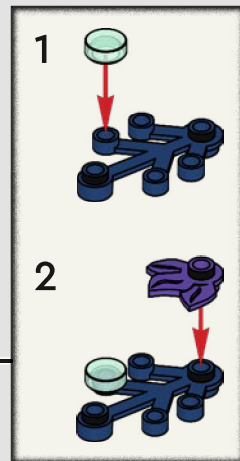
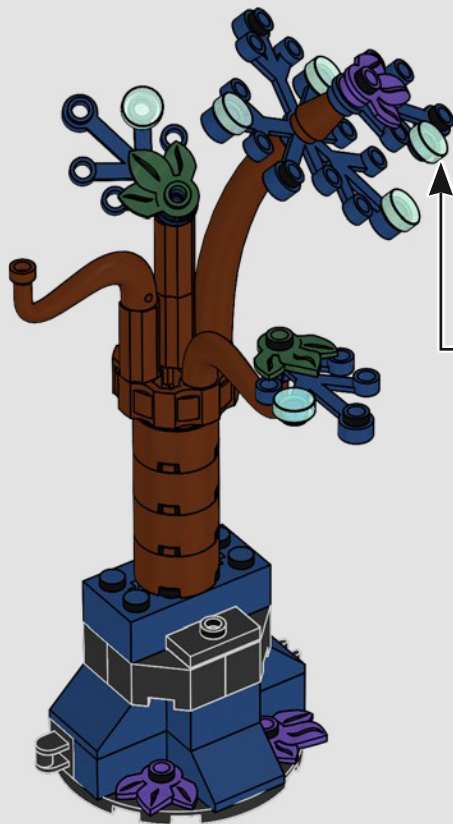

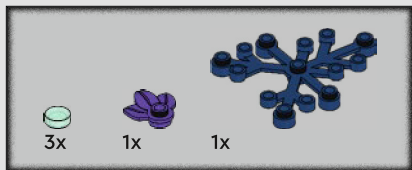

16

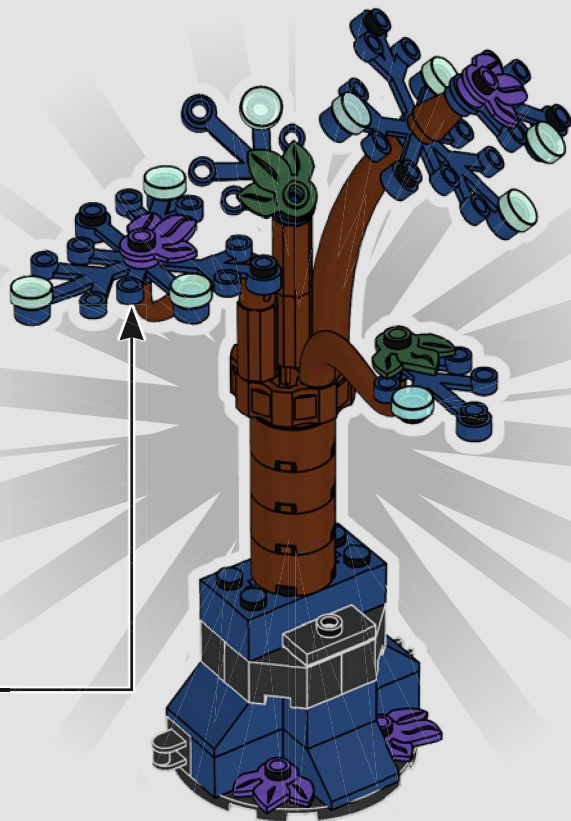
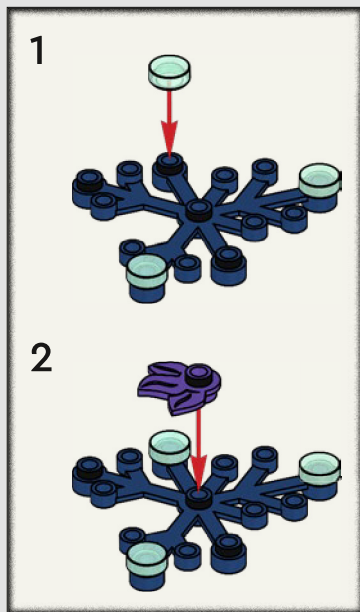

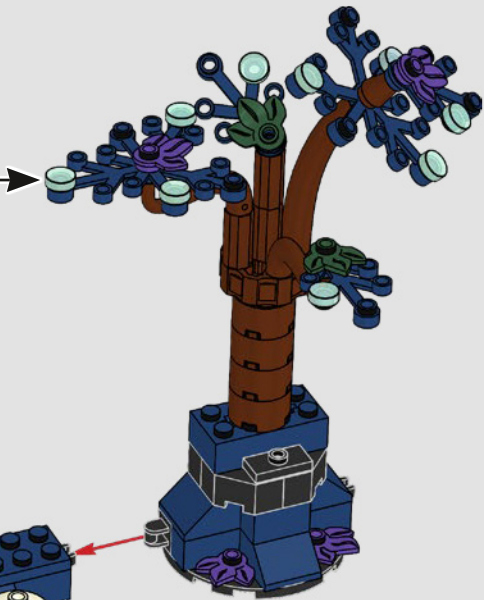





Harry Potter



Build the most detailed HOGWARTS™ CASTLE



76426



76430



Baue das detailreiche Schloss Hogwarts™ / Construisez le château de Poudlard le plus détaillé / Costruisci il Castello di Hogwarts™ più dettagliato di sempre / Construye el Castillo de Hogwarts™ más detallado / Construa o mais detalhado Castelo de Hogwarts™ / 拼搭精美的霍格沃茨™城堡 / Zbuduj najbardziej szczegółowy zamek Hogwarts™ / Postavte si ten najdetailnejší Bradavický hrad / Postavte si najdetailnejší Rokfortský hrad / Építsd meg a legrészletgazdagabb Roxfort™ kastélyt! / Construíește cel mai detaliat Castel Hogwarts™ / Постройте нај-детайлната версия на замъка Хогвортс / Uzbūvē visdetailizētāko Cūkkārpas pili / Pane kokku kõige üksikasjalikum Sigatüüka™ loss / Sukonstruokite nepaprastai detalią Hogwartso pilį

Each set sold separately and available for different periods of time / Jedes Set ist separat und in unterschiedlichen Zeiträumen erhältlich. / Chaque set est vendu séparément et sera disponible à des périodes différentes. / Ogni set è venduto separatamente ed è disponibile per periodi di tempo diversi. / Cada set se vende por separado y está disponible durante un cierto período de tiempo. / Os sets são vendidos separadamente e estão disponíveis por diferentes períodos de tempo. / 每款套装于不同时间段单独出售。 / Zestawy są sprzedawane osobno i są dostępne w różnym czasie / Každá stavebnice se prodává samostatně a je k dispozici v různých časových obdobích / Každá stavebnice sa predáva samostatne a je k dispozícii v rôznych časových obdobiach / Minden egyes készlet külön-külön és más-más időszakban kapható. / Seturile se vând separat și sunt disponibile pentru perioade diferite de timp / Всеки комплект се продава отделно и е наличен за различен период от време. / Kats komplekts tiek pārdots atsevišķi, un to pieejamības periodi atšķiras. / Kõik komplektid on müügil eraldi ja saadaval erinevates ajavahemikes. / Kiekvienas rinkinys parduodamas atskirai ir tik ribotą laiką



Rebuild
the
world™





 [LEGO.com/service](https://www.LEGO.com/service)



YOU COULD
WIN



Scan this QR code or go to
LEGO.COM/PRODUCTFEEDBACK and give
us your short feedback about this LEGO® set
for a chance to win a cool LEGO prize.

Terms and Conditions apply*

EN: YOU COULD WIN. Terms and Conditions apply* **DE: Du könntest GEWINNEN.** Es gelten die Teilnahmebedingungen* **FR: Tu pourrais GAGNER.** Des conditions s'appliquent* **IT: Potresti VINCERE tu.** Termini e condizioni sono applicabili* **ES: Puedes GANAR.** Aplican términos y condiciones* **PT: Poderá GANHAR.** Aplicam-se termos e condições* **ZH: 轻松获奖. 条款和条件适用*** **PL: Szansa na WYGRANĄ.** Obowiązują warunki korzystania* **CS: Máte šanci VYHRÁT.** Platí všeobecné smluvní podmínky* **SK: Máte šancu VYHRAŤ.** Platia všeobecné zmluvné podmienky* **HU: TE IS NYERHETSZ.** Felhasználási feltételek érvényesek* **RO: Ai putea CÂȘTIGA.** Se aplică termeni și condiții* **BG: Можете да СПЕЧЕЛИТЕ.** Има определени правила и условия* **LV: Tu vari LAIMĒT.** Ir spēkā noteikumi un nosacījumi.* **ET: Sul on võimalus VÕITA.** Kehtivad tingimused* **LT: Jūs galite LAIMĖTI.** Taikomos sąlygos*

*[LEGO.com/productfeedback-terms](https://www.lego.com/productfeedback-terms)

LEGO and the LEGO logo are trademarks of the LEGO Group. ©2024 The LEGO Group.

WIZARDING WORLD and all related trademarks, characters, names, and indicia are © & ™ Warner Bros. Entertainment Inc. Publishing Rights © JKR. (s24)

6507088