



80111





LEGO.com/sustainable-packaging

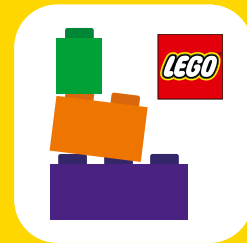

BUILDER



Apple and the Apple logo are trademarks of Apple Inc., registered in the U.S. and other countries and regions. App Store is a service mark of Apple Inc. Google Play and the Google Play logo are trademarks of Google LLC. Tencent and the Tencent logo are trademarks of Tencent Inc.

Q [LEGO.com/devicecheck](https://www.lego.com/devicecheck)

EN Ask parents' permission before going online | **DE** Eltern um Erlaubnis bitten, bevor du online gehst | **FR** Demande l'autorisation d'un parent avant d'aller en ligne | **IT** Chiedi il permesso ai tuoi genitori prima di andare online | **ES** Pídeles permiso a tus papás antes de conectarte a Internet | **PT** Peça autorização aos pais antes de acederes online | **JA** オンラインになる前に ほか者の方のきょかをもらおう | **ZH** 上网前应先征得父母的同意 | **KO** 온라인 접속 전에 보호자 동의가 필요합니다 | **RU** Спроси разрешения у родителей, прежде чем заходить в интернет | **PL** Poproś rodziców o zgodę, zanim wejdiesz do Internetu | **CS** Než půjdeš na internet, požádej rodiče o svolení | **SK** Skôr než pôjdeš na internet, vypýtaj si povolenie od rodičov | **HU** Kérj szülői engedélyt, mielőtt online csatlakoznál! | **RO** Cere permisiunea părinților înainte de a te conecta online | **BG** Поискайте разрешение от родител, преди да влезете онлайн | **LV** Pirms došanās tiešsaistē palūdz atļauju vecākiem | **ET** Enne Interneti kasutamist küsi vanematelt luba | **LT** Prieš prisijungdami prie interneto, atsilkauskite tėvų





Build Together
Gemeinsam bauen
Construire ensemble
Costruiamo insieme
Construye en compañía
Construir juntos

一起来拼搭
Собирайте вместе
Wspólne budowanie
Stavíme společně
Staviame spoločne
Építsetek együtt!

Construim împreună
Да строим заедно
Korrigai būvēšanai
Ehitame koos
Konstruokite kartu

The Spring Festival
Das Frühlingsfest
La fête du Printemps
La Festa di Primavera
Fiesta de la Primavera
O Festival da Primavera

春节
Праздник весны
Festiwal Wiosny
Jarní festival
Jarný festival
Tavaszi Fesztivál

Festivalul Primăverii
Пролетният фестивал
Pavasara svētki
Kevadfestival
Pavasario šventė

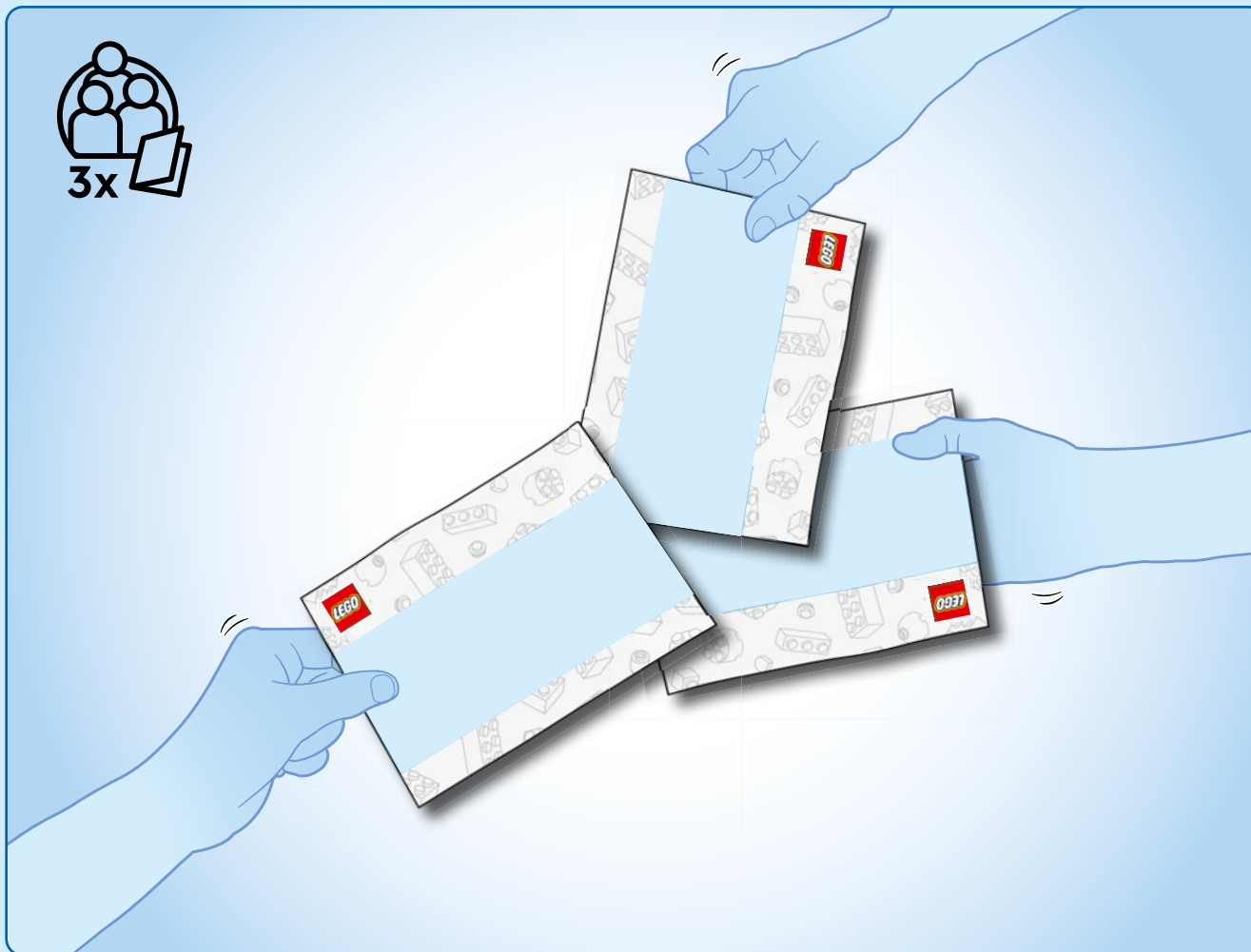

Chinese Festival
Chinesisches Fest
Nouvel An chinois
Festa di Primavera
Fiestas de China:
Festival Chinês

中国节日
Китайские праздники
Čhiński festival
Čínský festival
Čínske slávnosti
Kínai Fesztivál

Festivalul chinezesc
Китайски фестивал
Kíniesu svētki
Hiina festivali
Kinų šventė

Special edition
Sonderedition
Édition spéciale
Edizione Speciale
Edición especial
Edição Especial

特別版
Особое издание
Edycja specjalna
Speciální edice
Špeciálna edícia
Különleges kiadás

Ediție specială
Специално издание
Īrašais izdevums
Eriväljaanne
Specialus leidimas

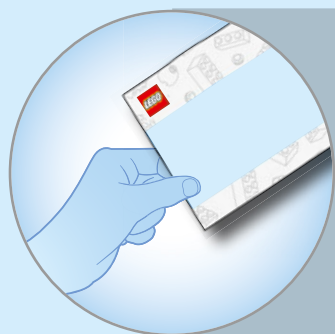
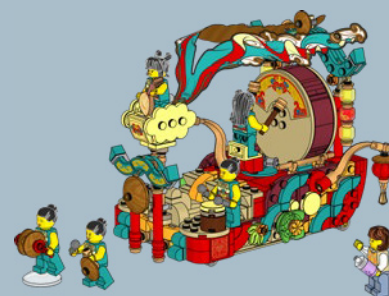
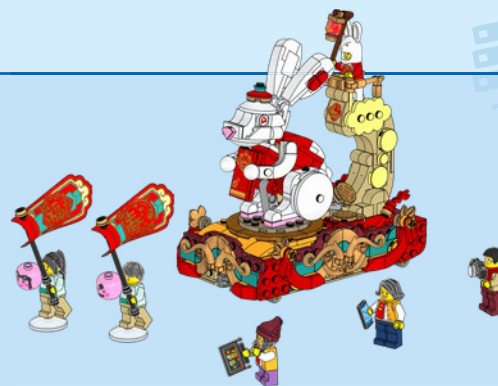

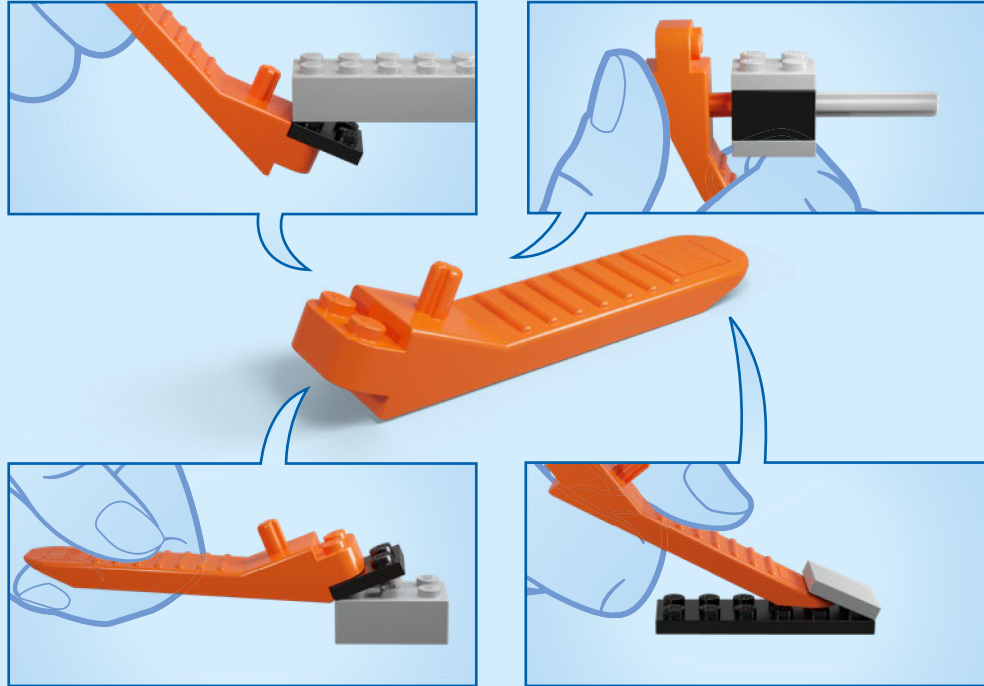

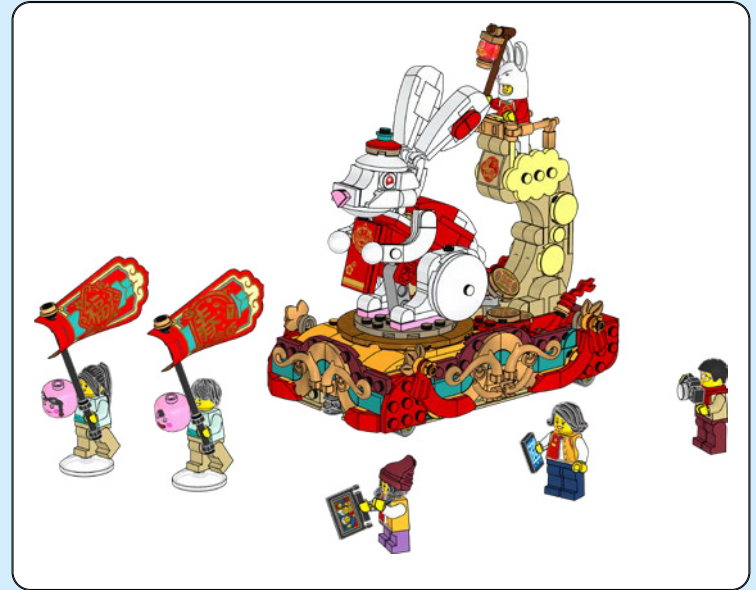

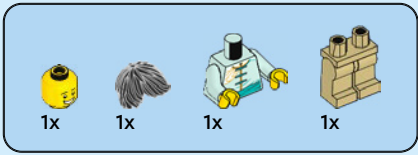

1

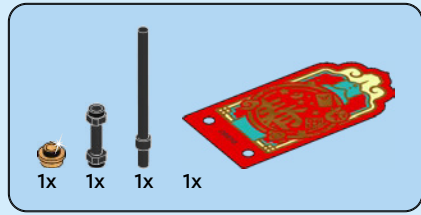
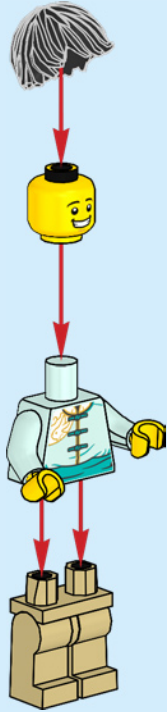

2

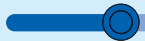



3



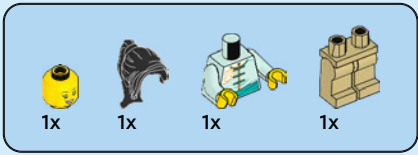

1

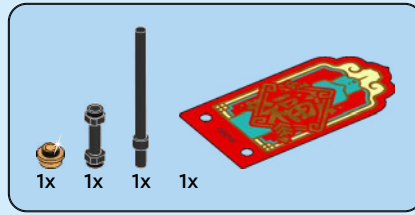
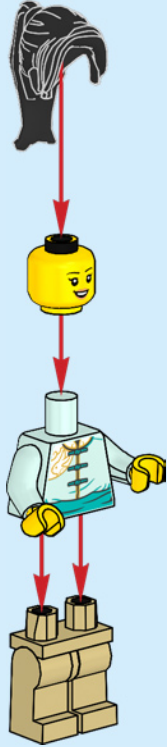

2

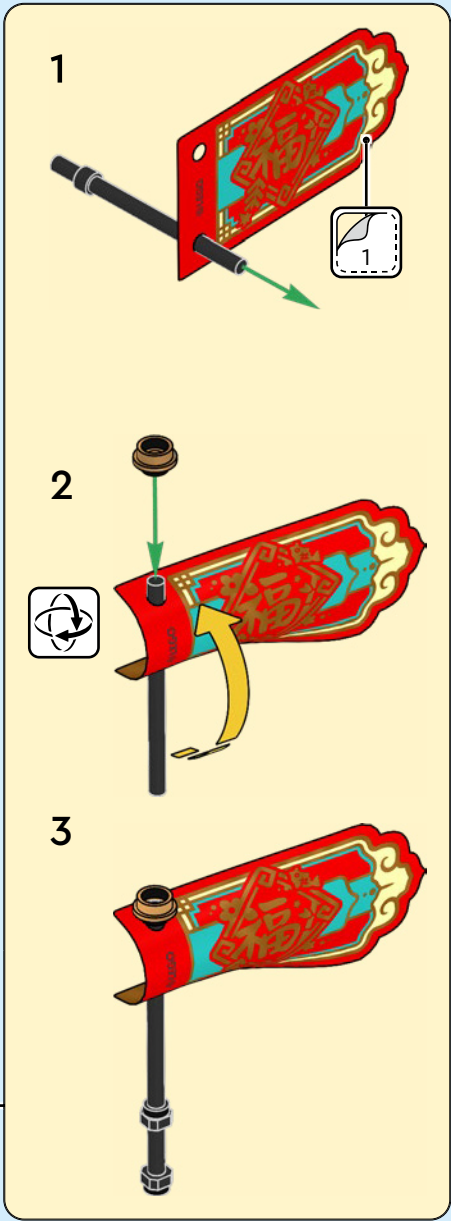



3



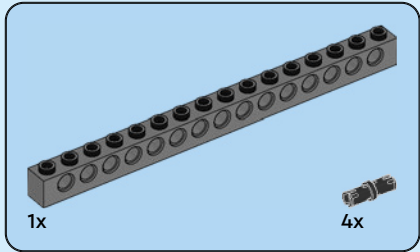
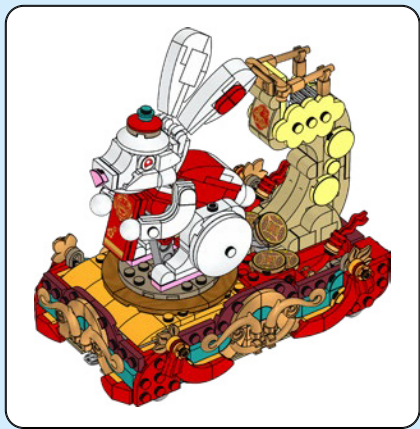

1

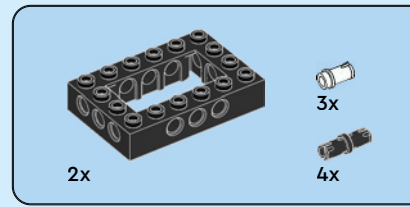
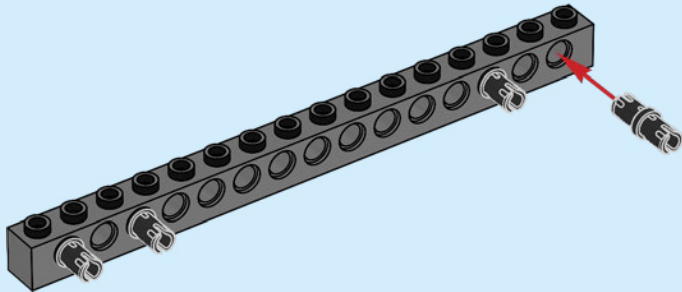

2

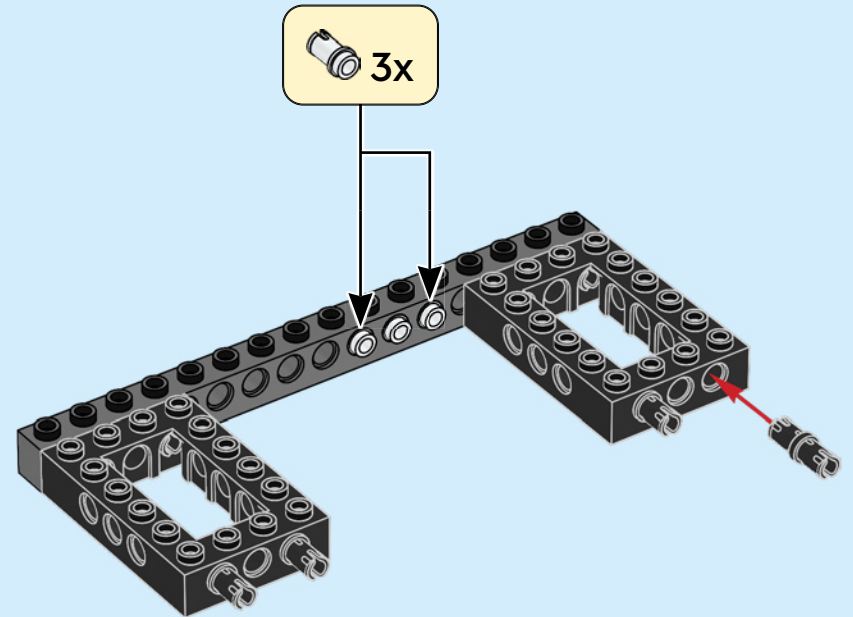

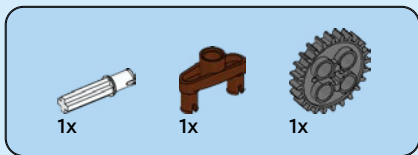

3

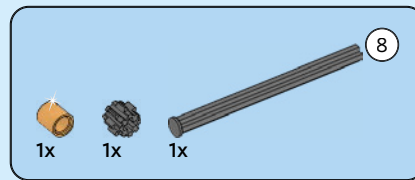
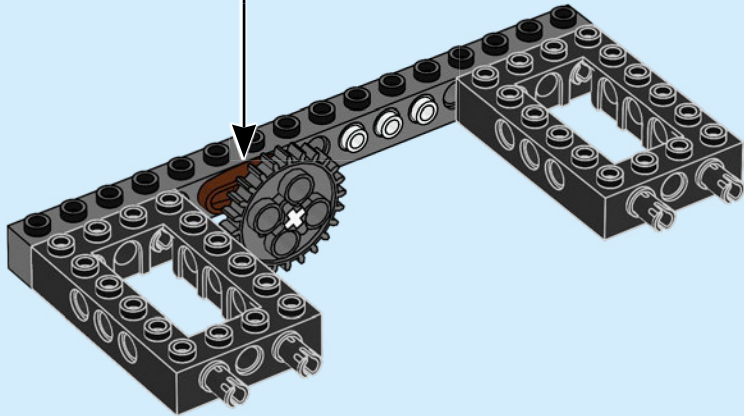
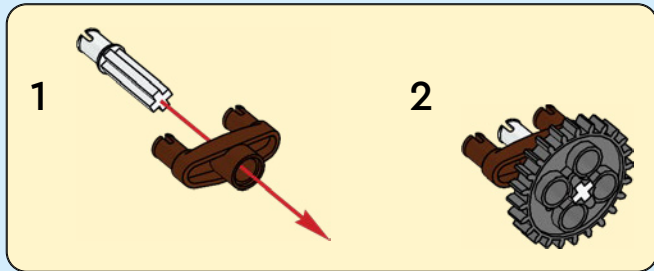

4

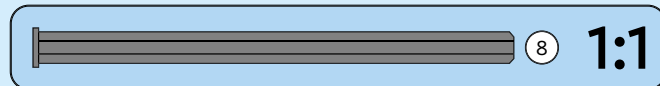
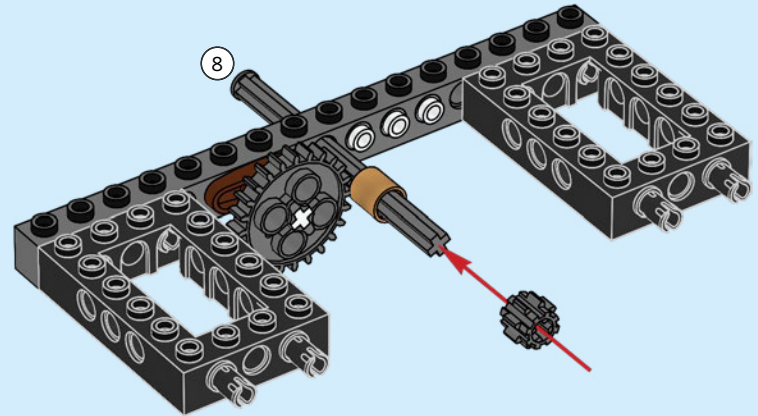



1x



1x

5

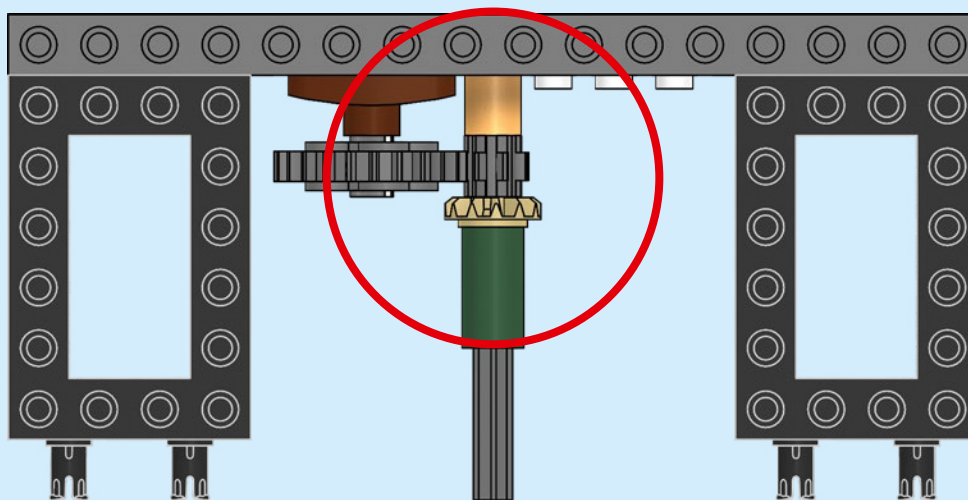
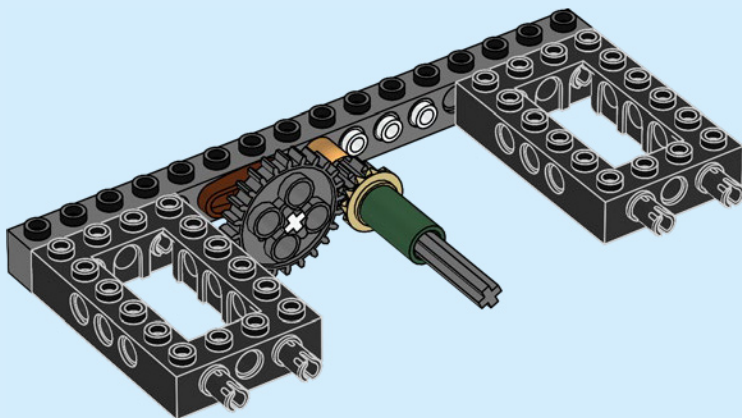

1:1

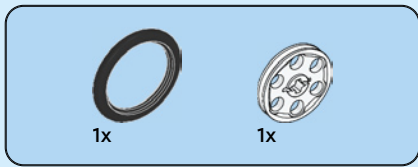

6

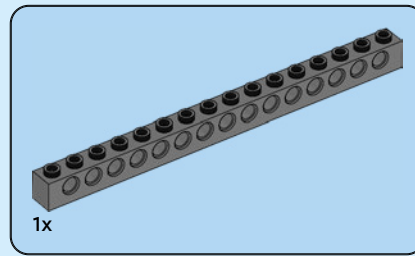
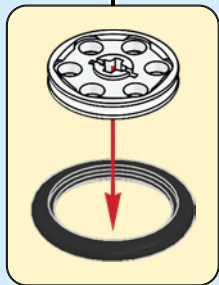
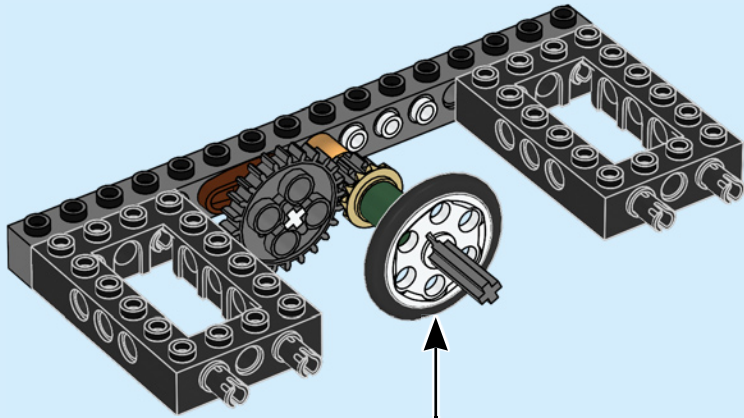

7

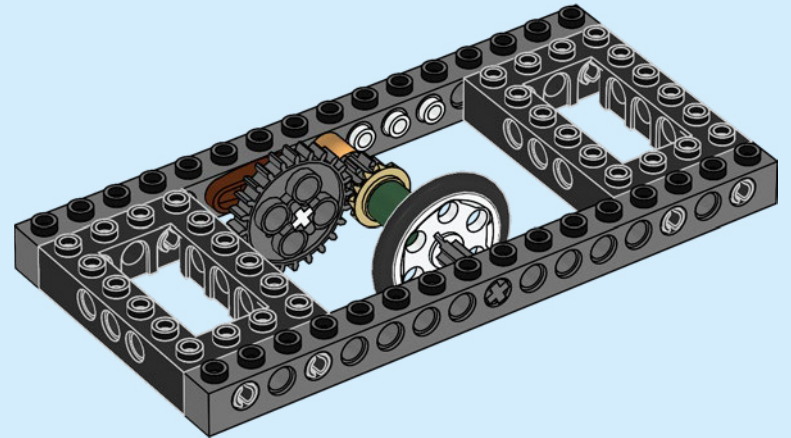



4x

8

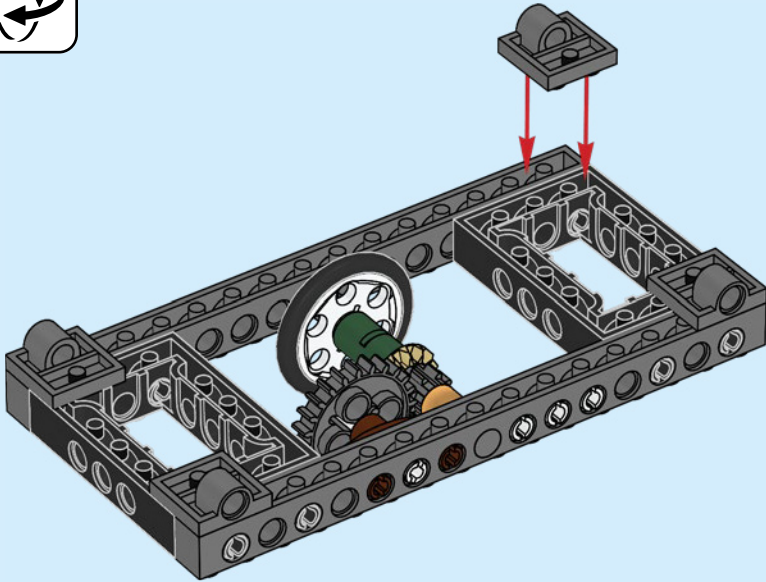

2x



2x



4x



2x

9

1

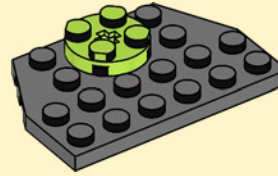

2

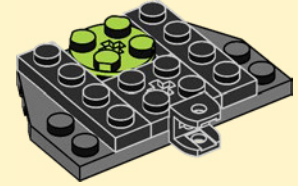

2x

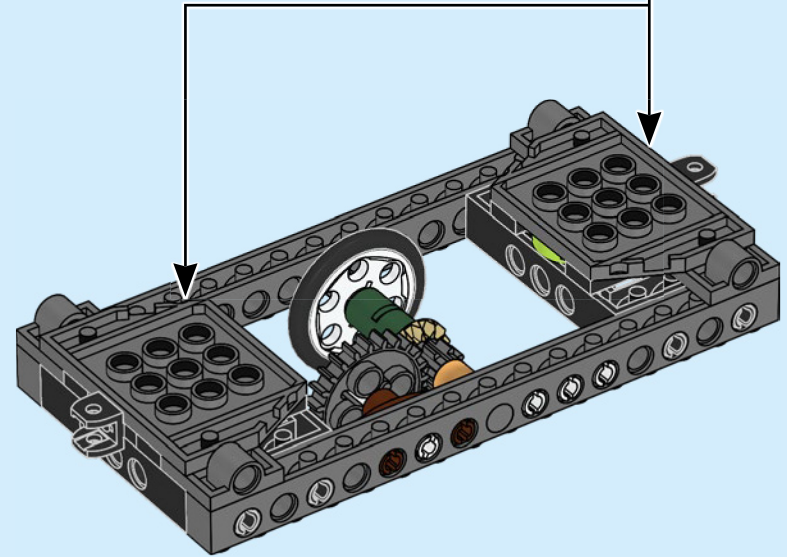

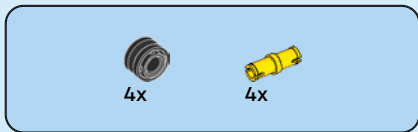

10

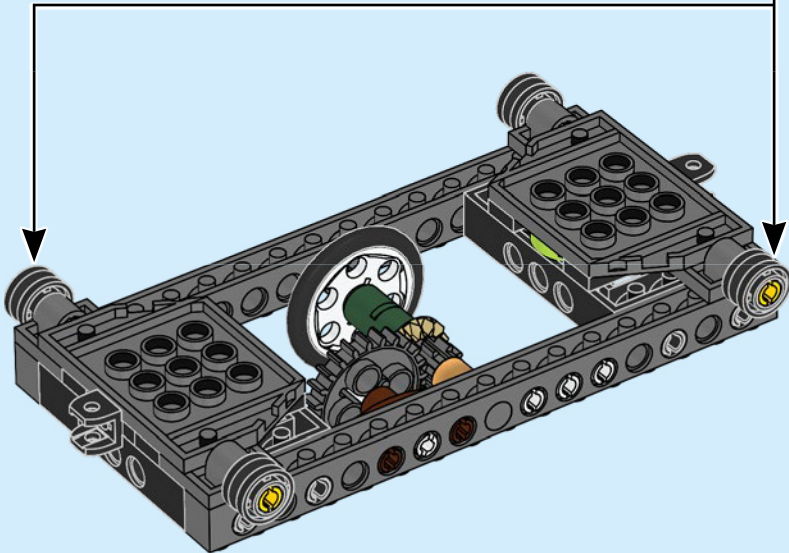
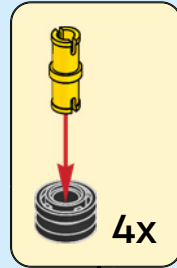

11

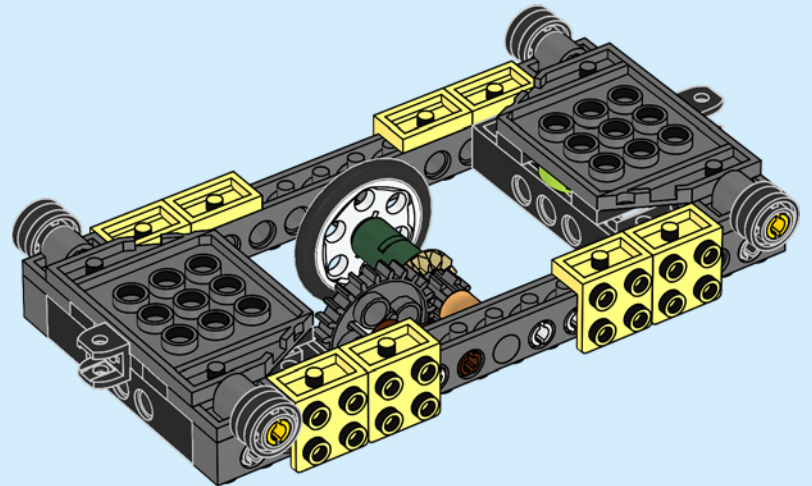

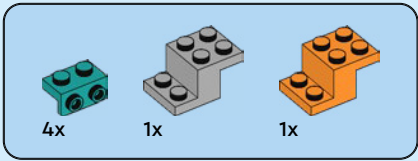

12

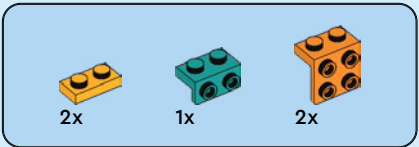
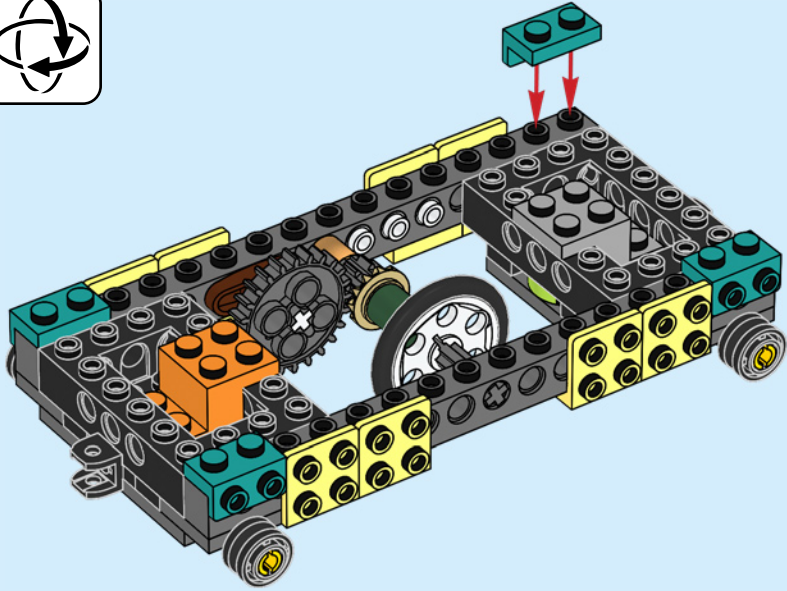

13

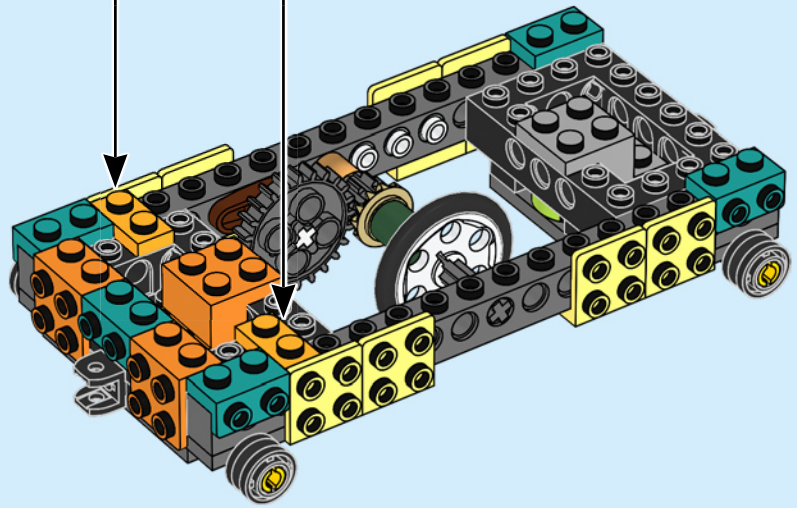
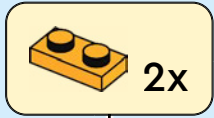

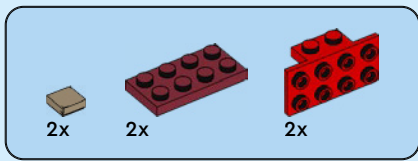

14

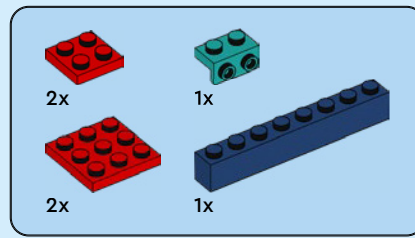
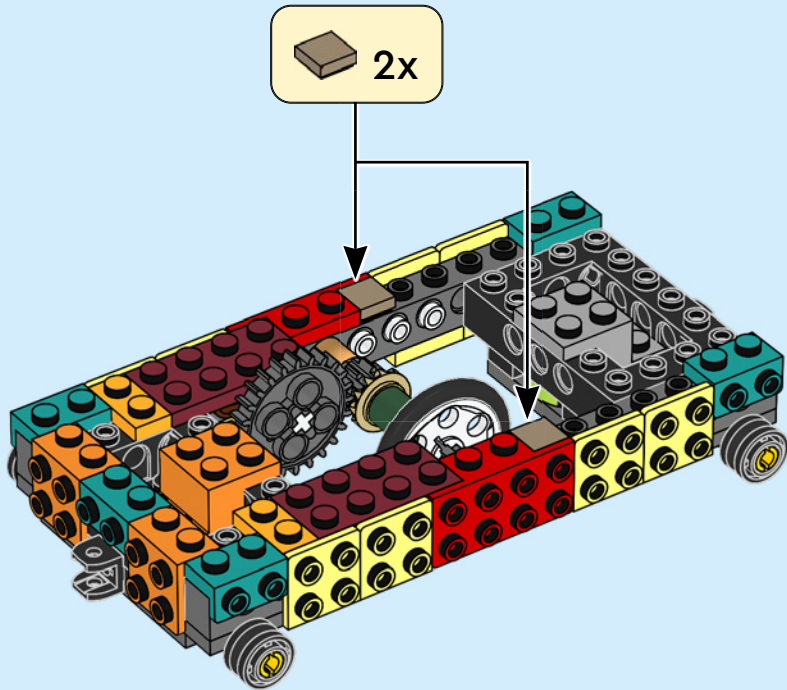

15

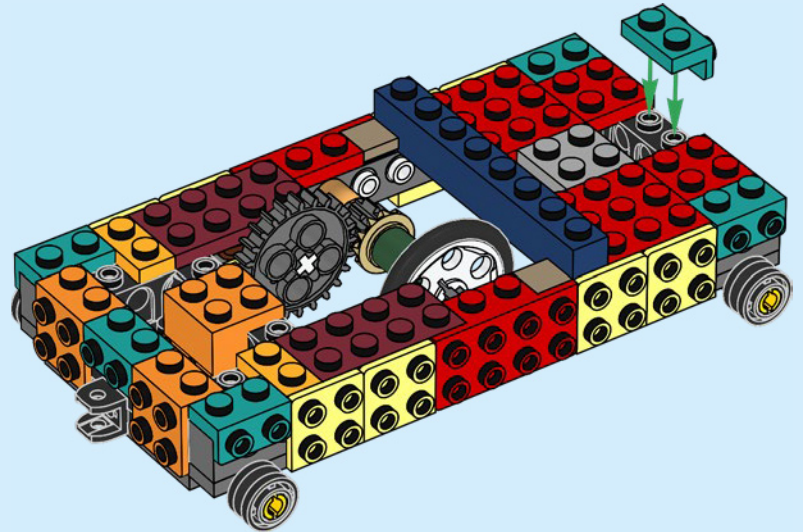

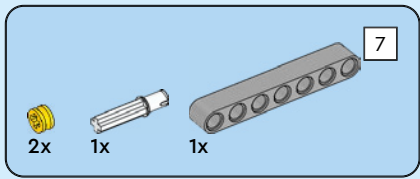

16

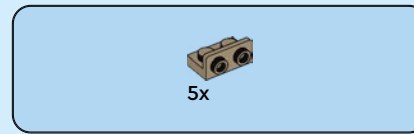
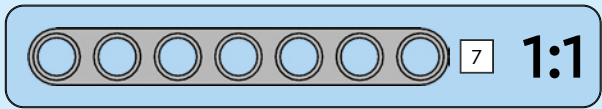
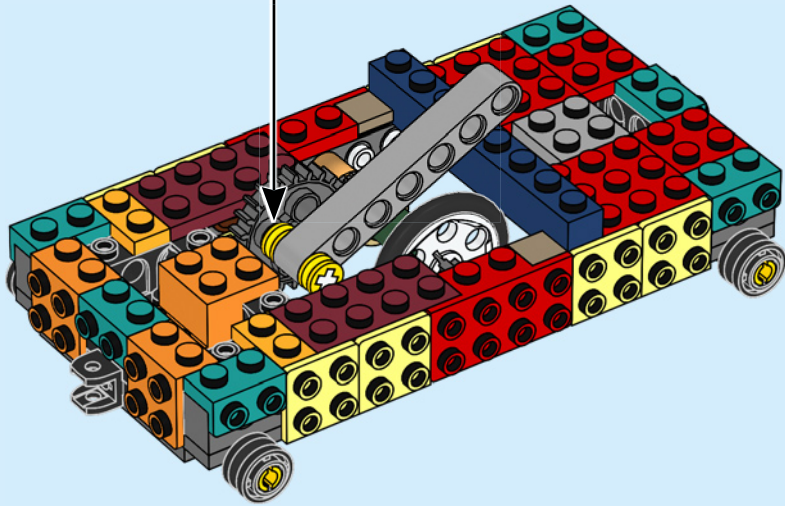
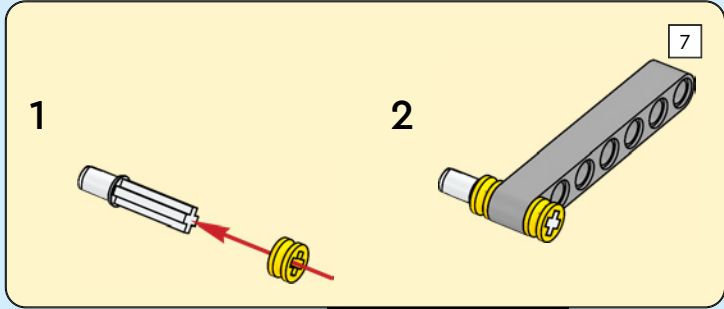

17

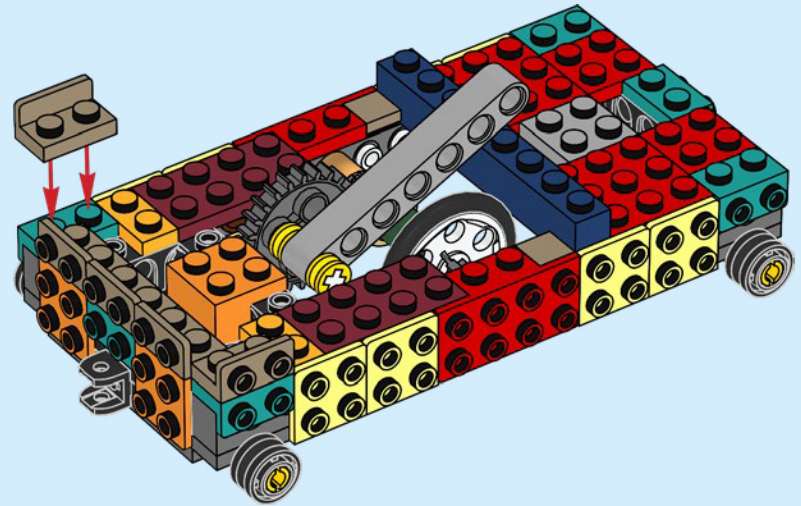

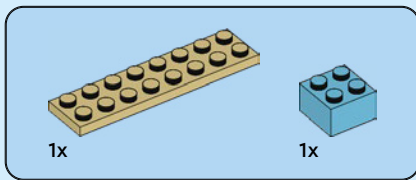

18

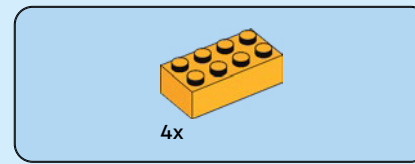
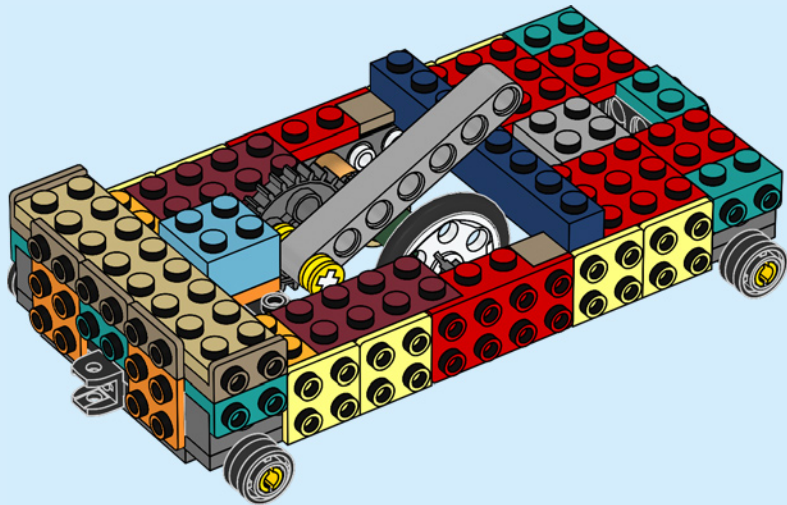

19

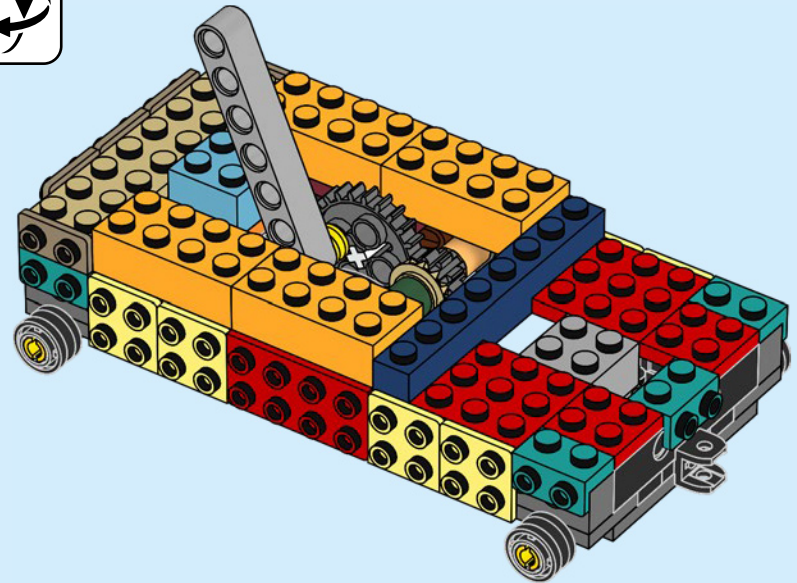
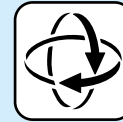

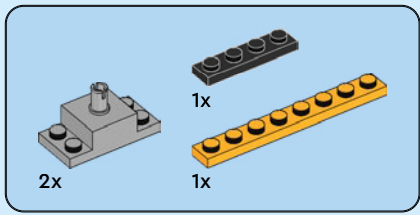

20

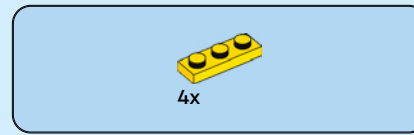
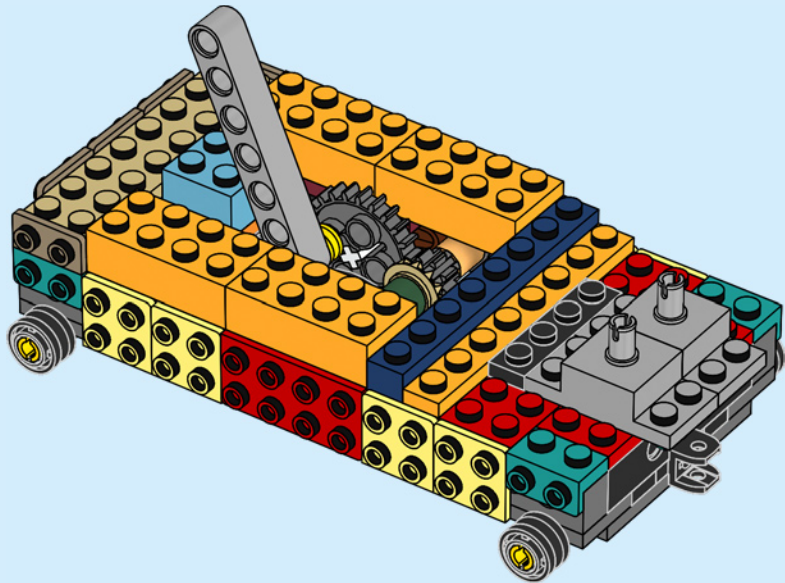

21

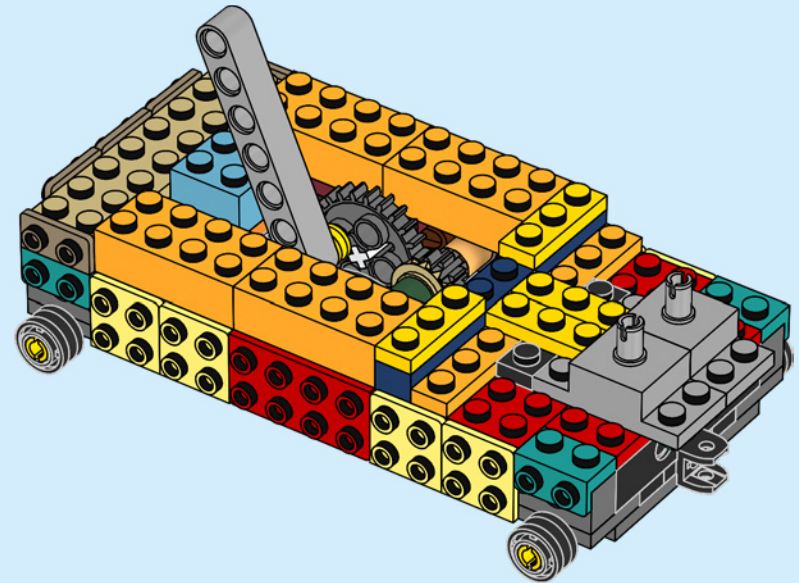

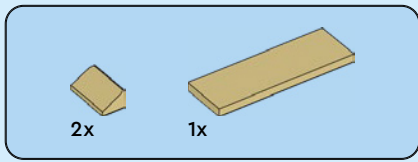

22

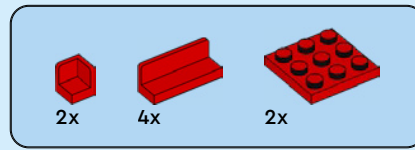
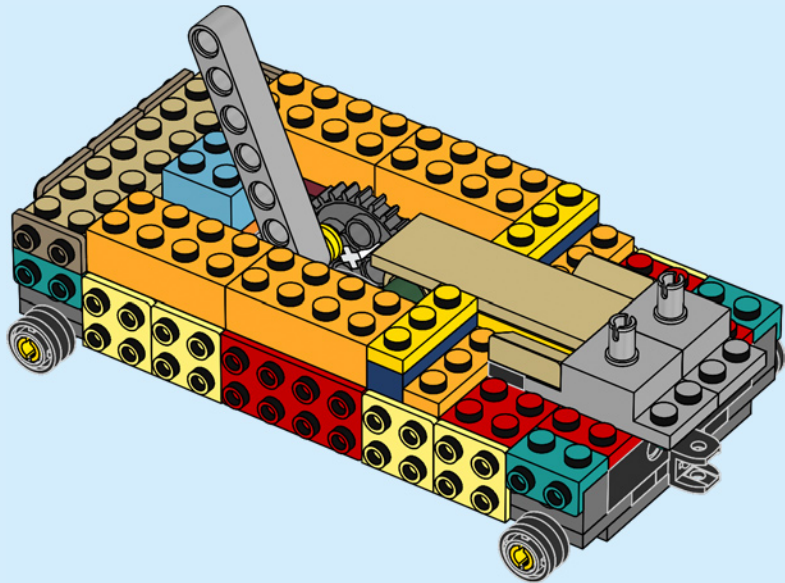

23

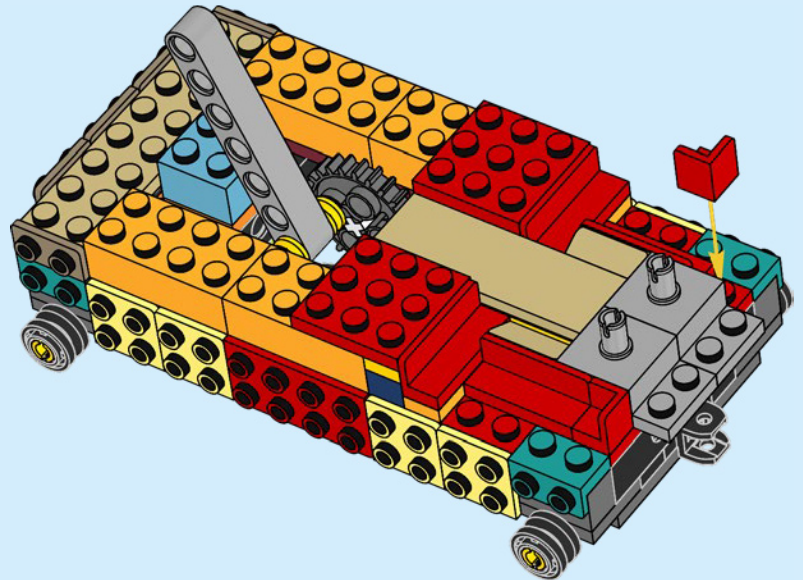

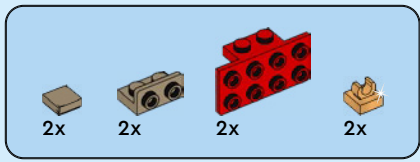

24

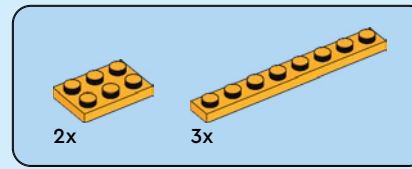
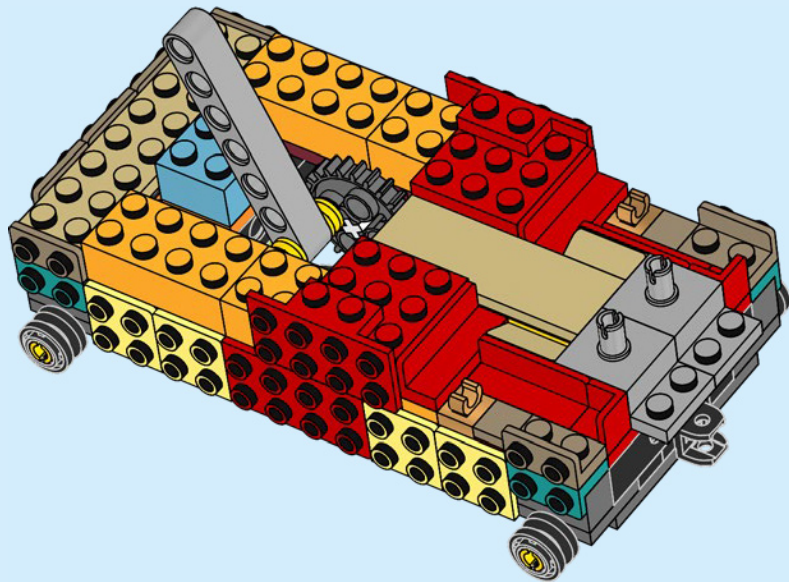

25

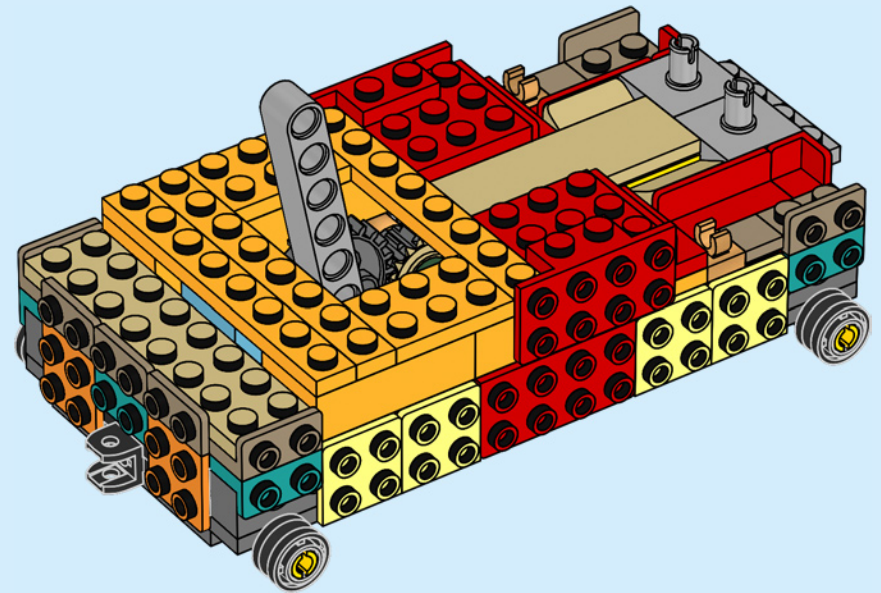

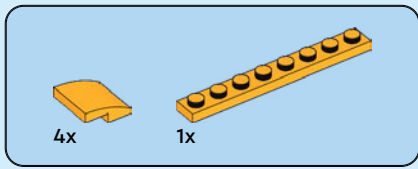

26

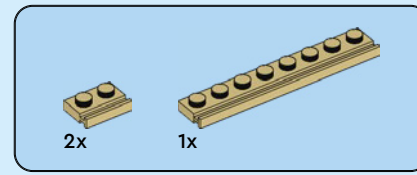
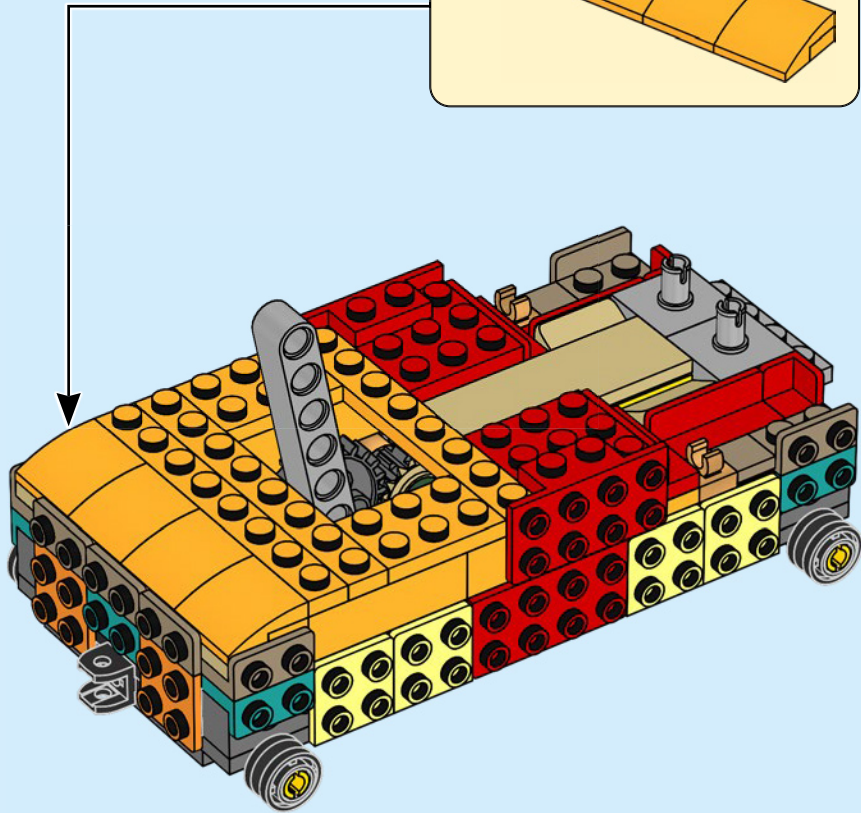
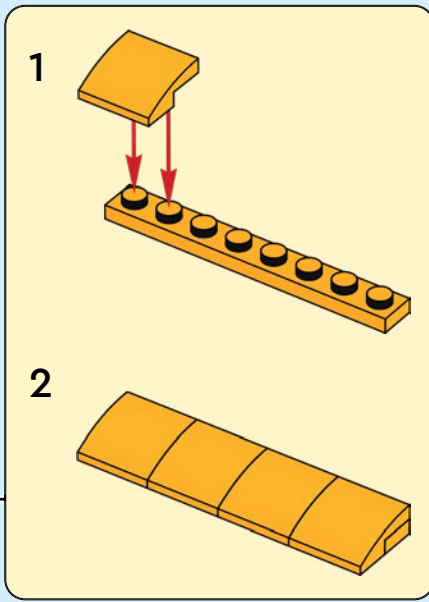

27

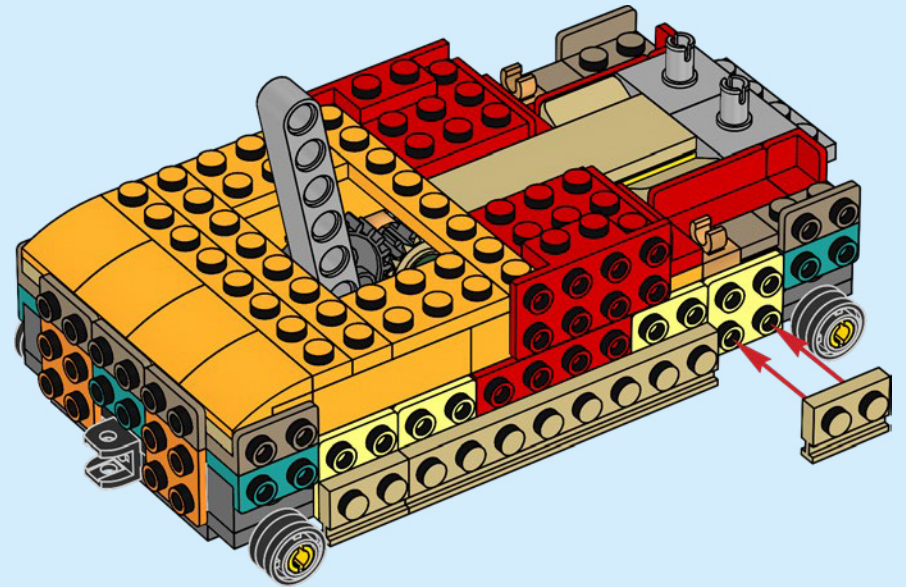

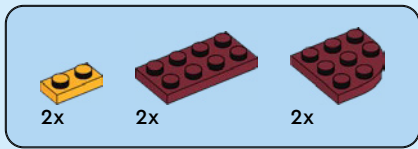

28

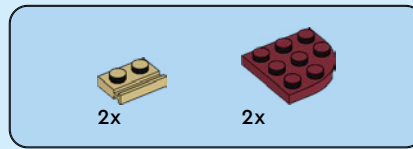
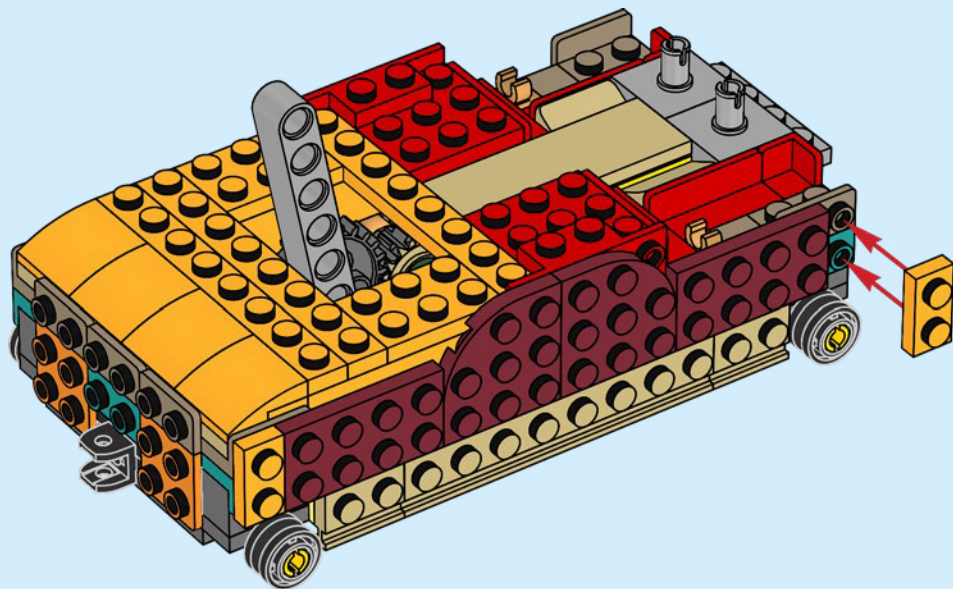

29

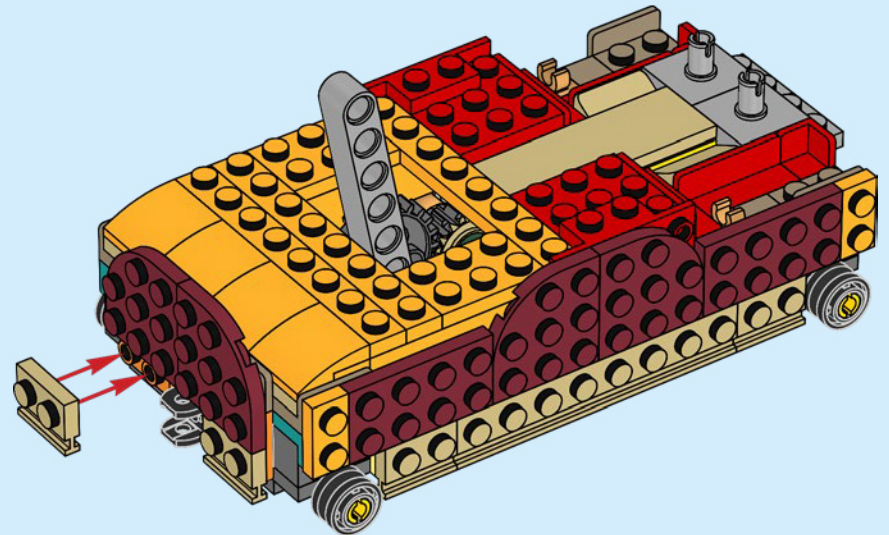

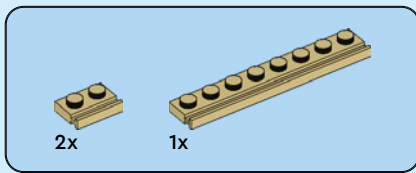

30

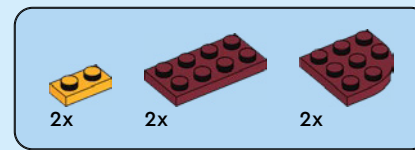
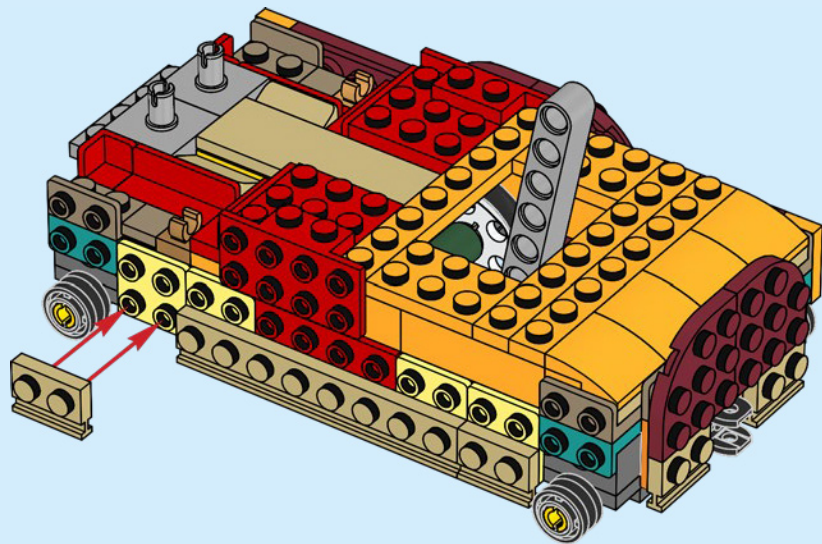

31

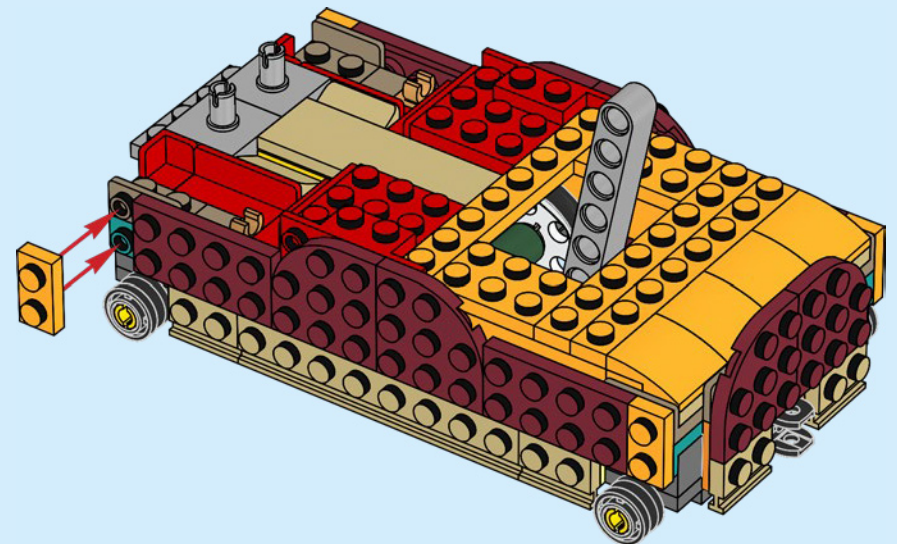



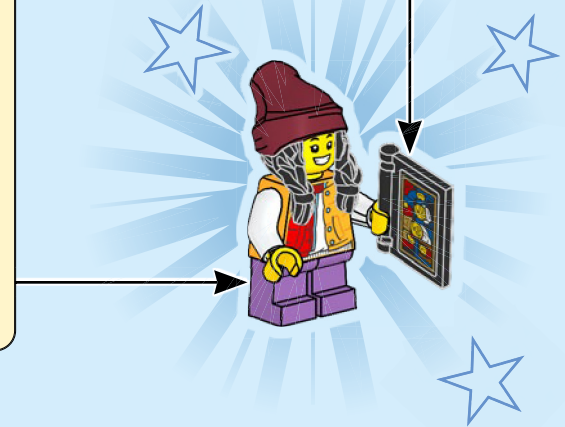
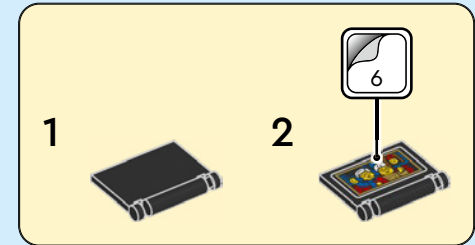
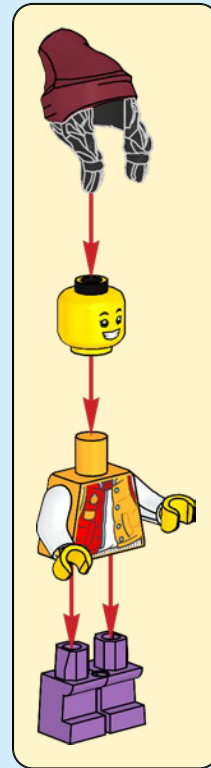
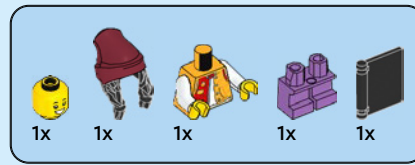
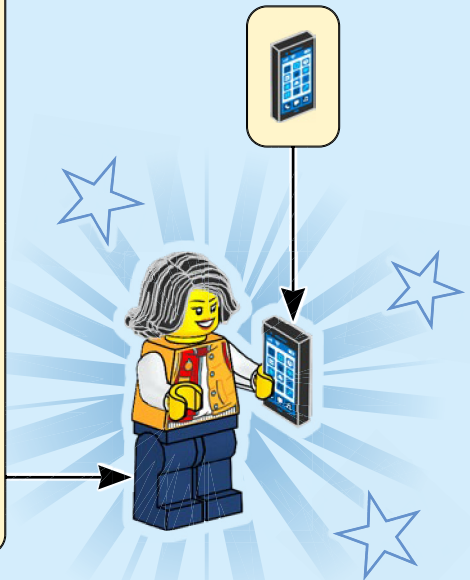
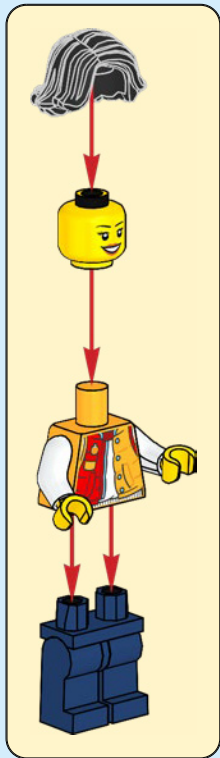

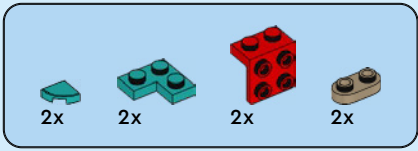

32

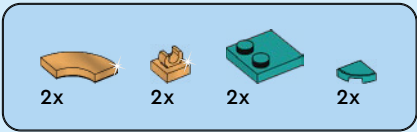
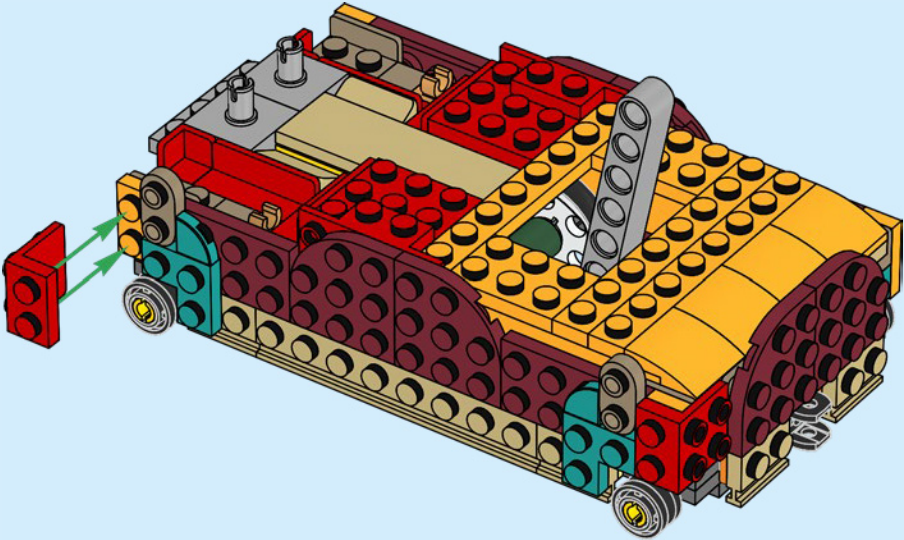

33

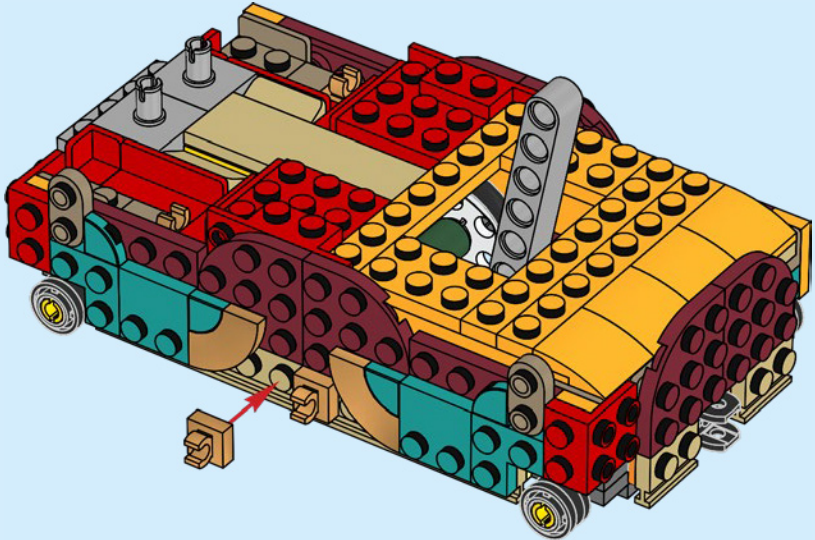

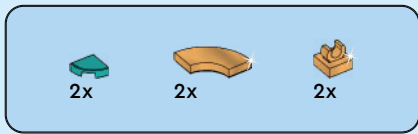

34

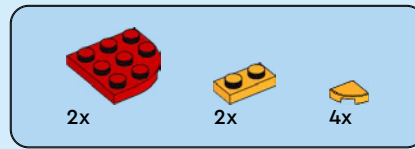
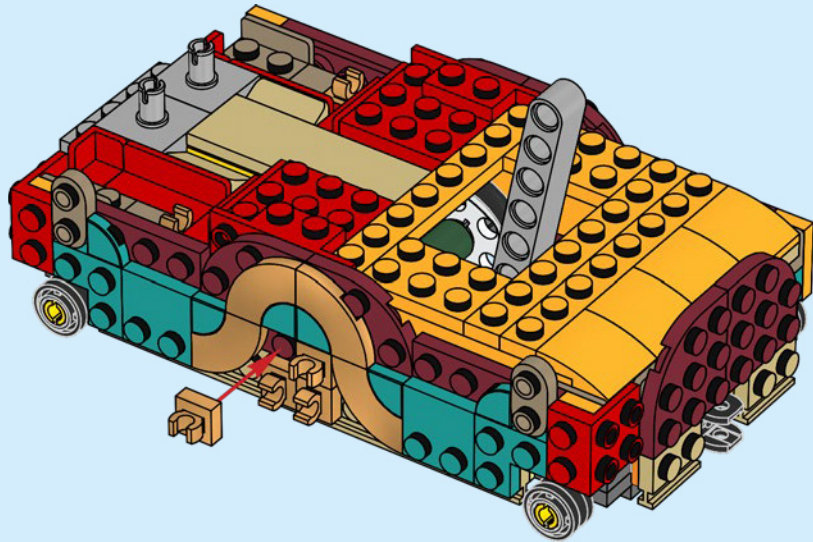

35

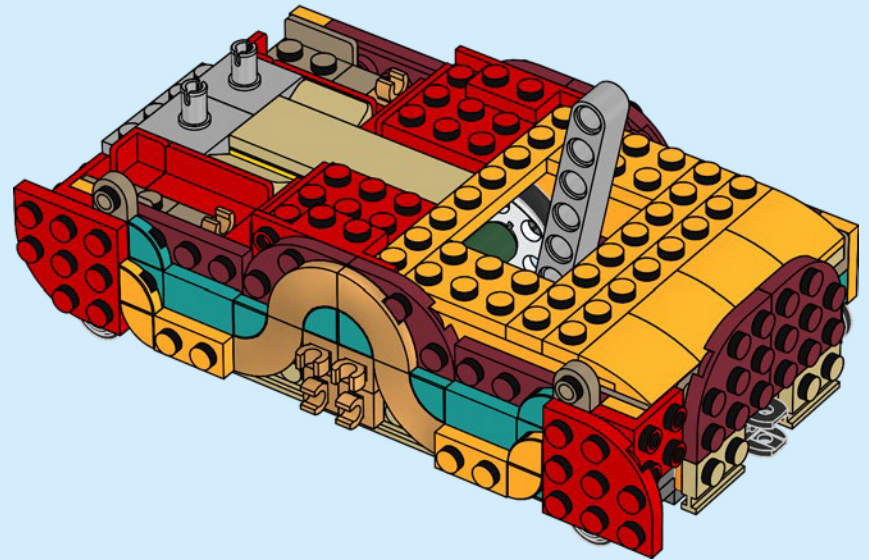

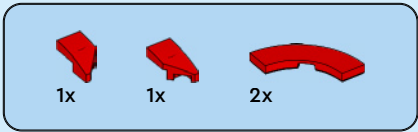

36

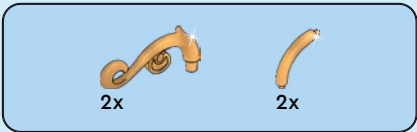
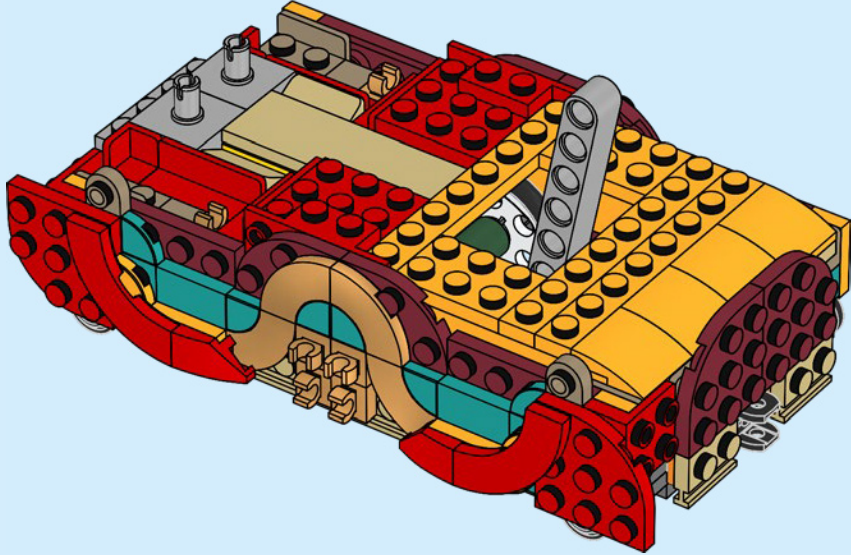

37

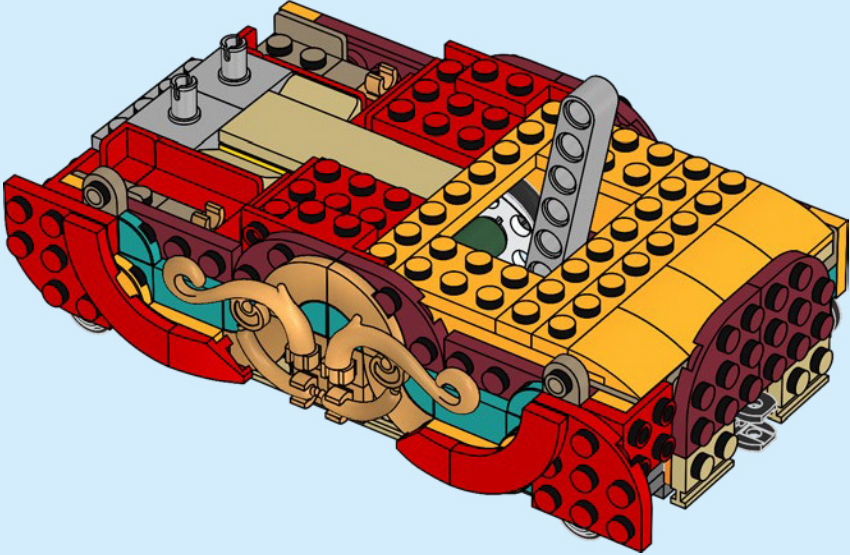

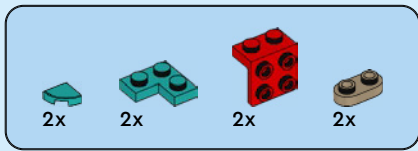

38

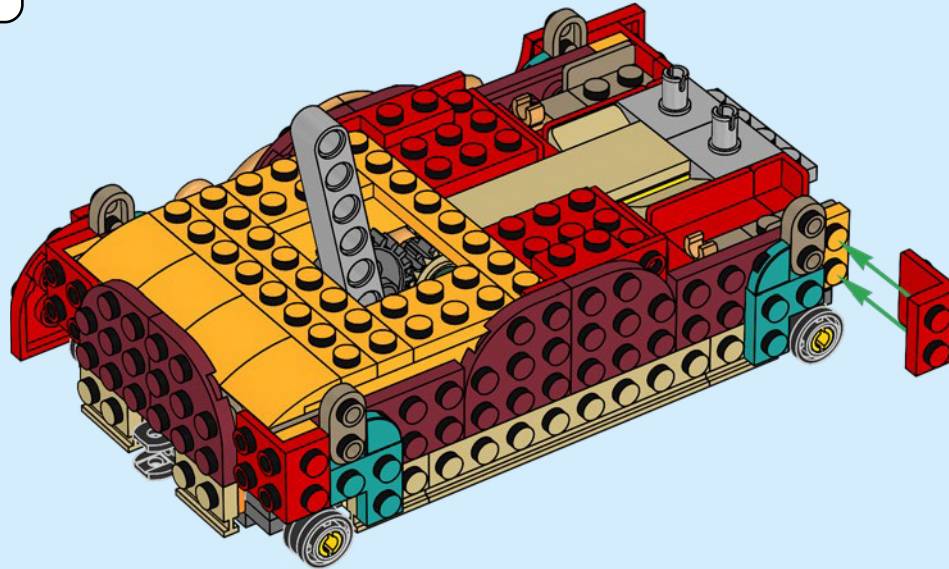

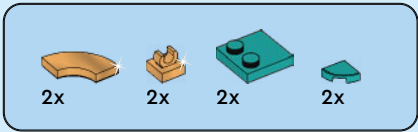

39

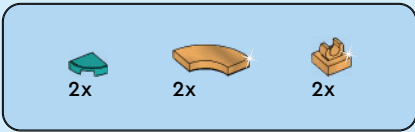
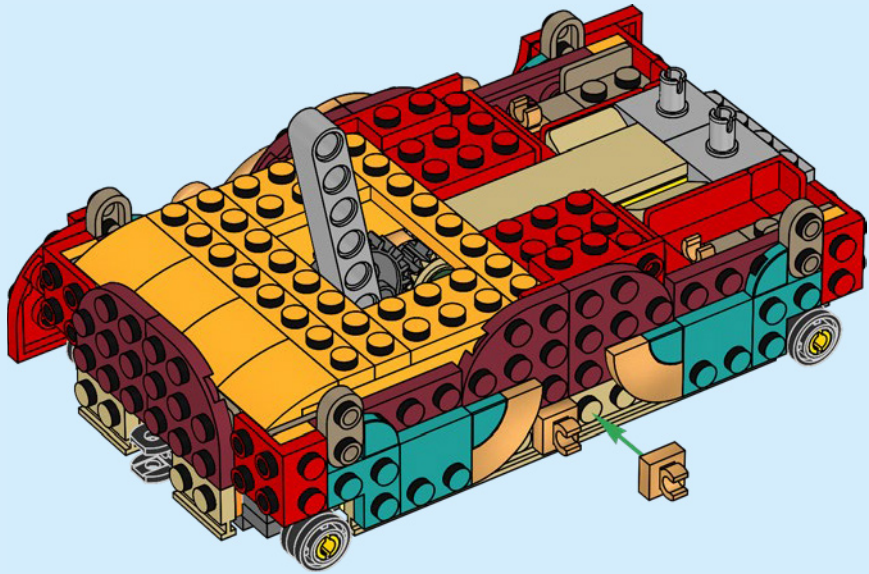

40

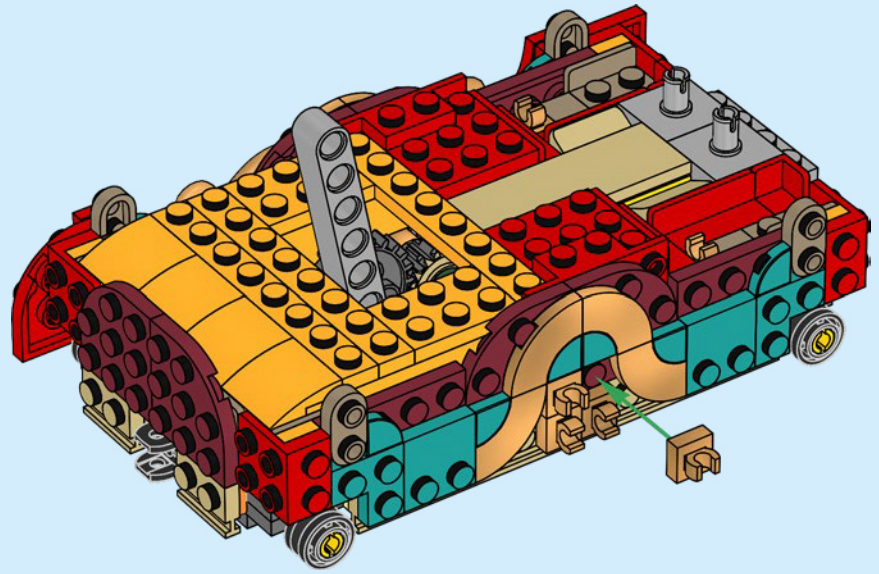

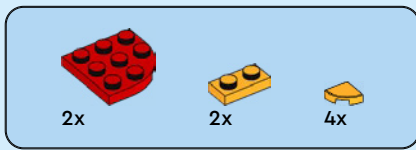

41

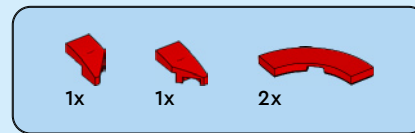
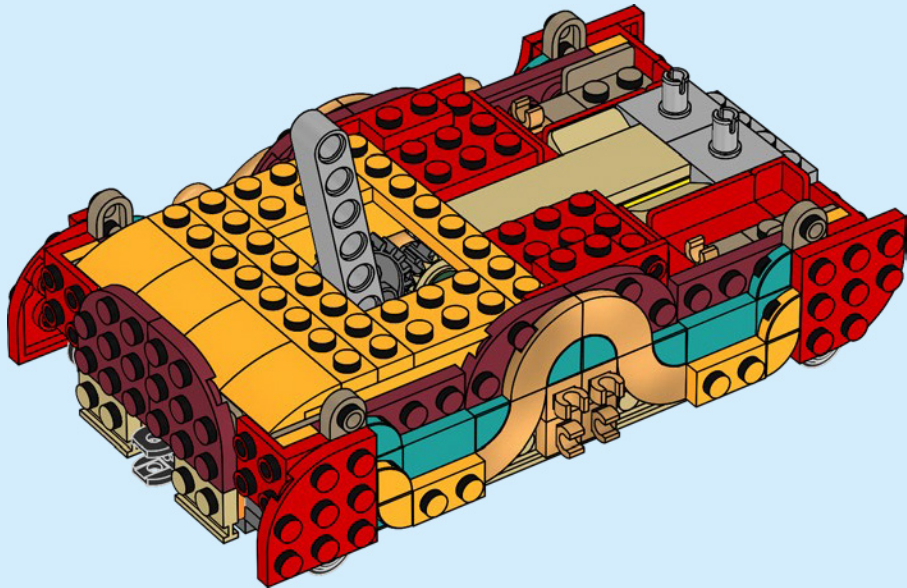

42

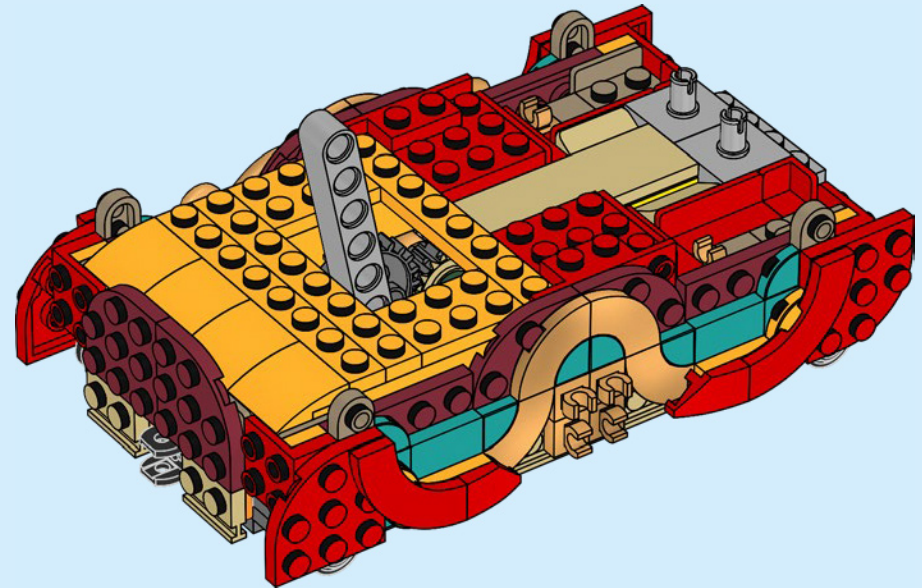

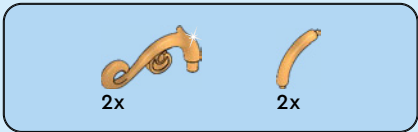

43

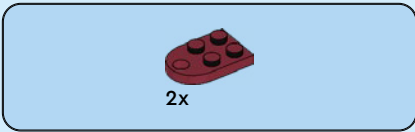
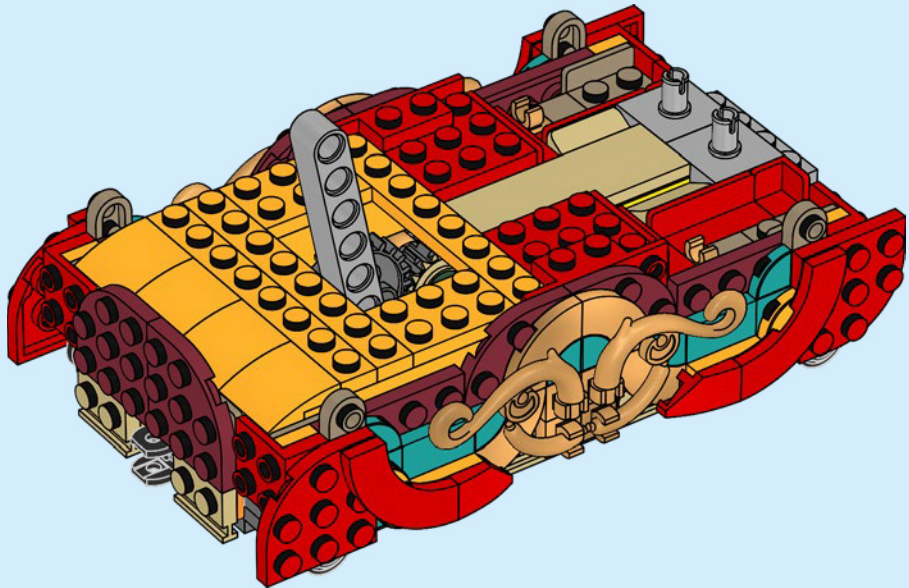

44

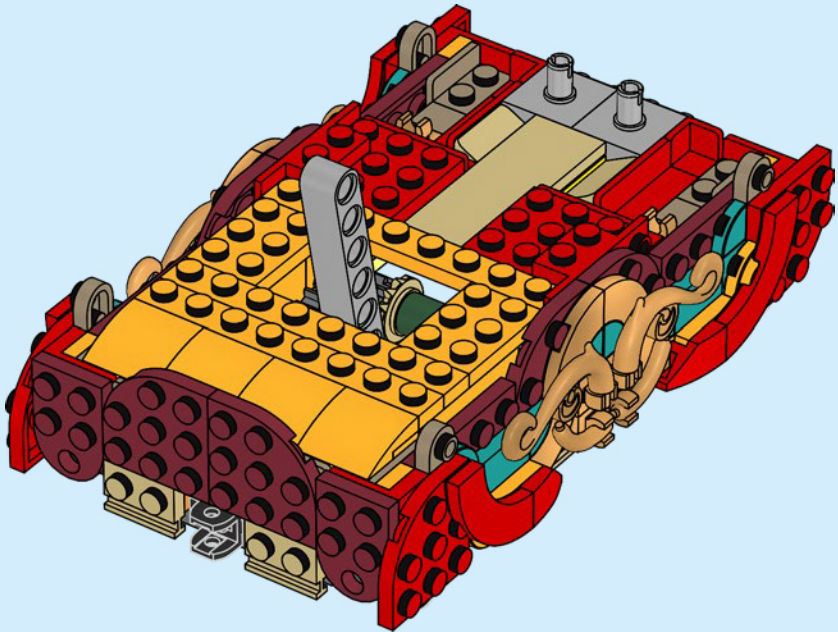

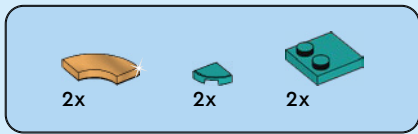

45

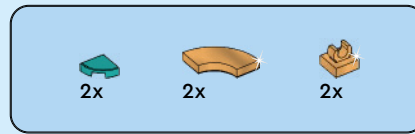
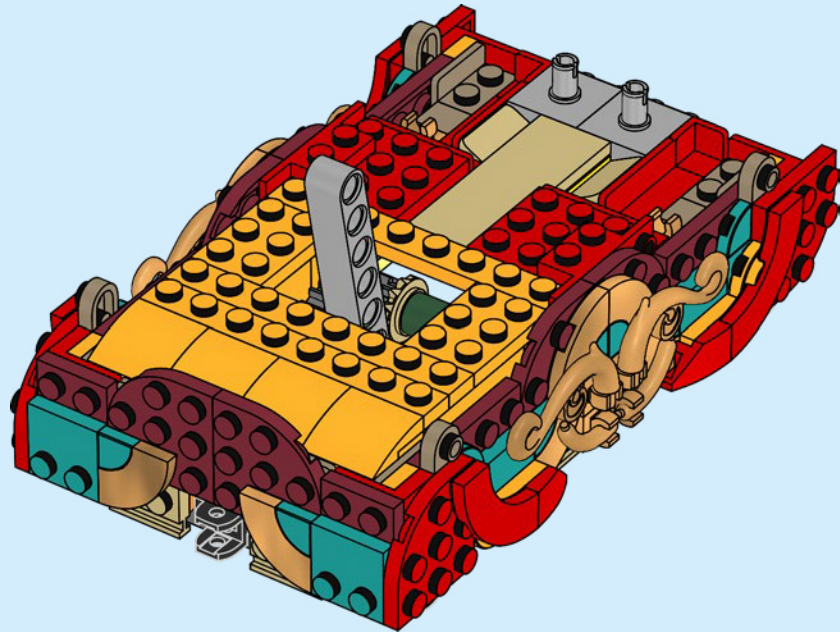

46

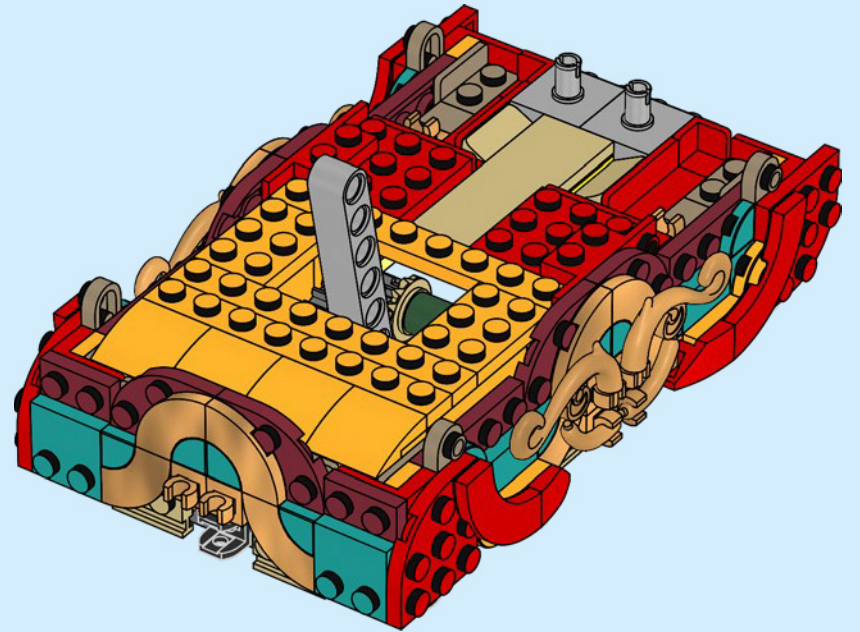

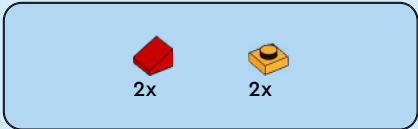

47

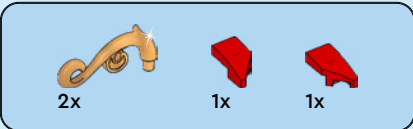
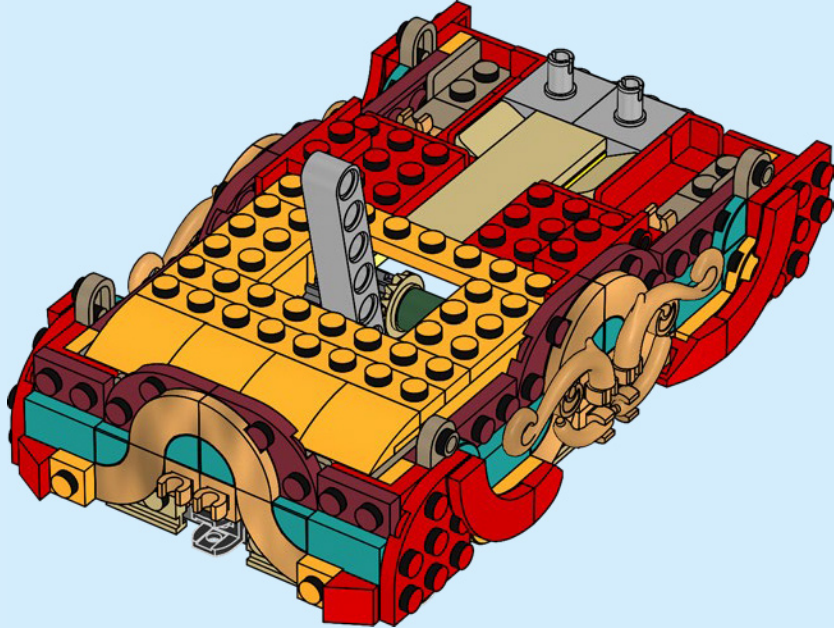

48

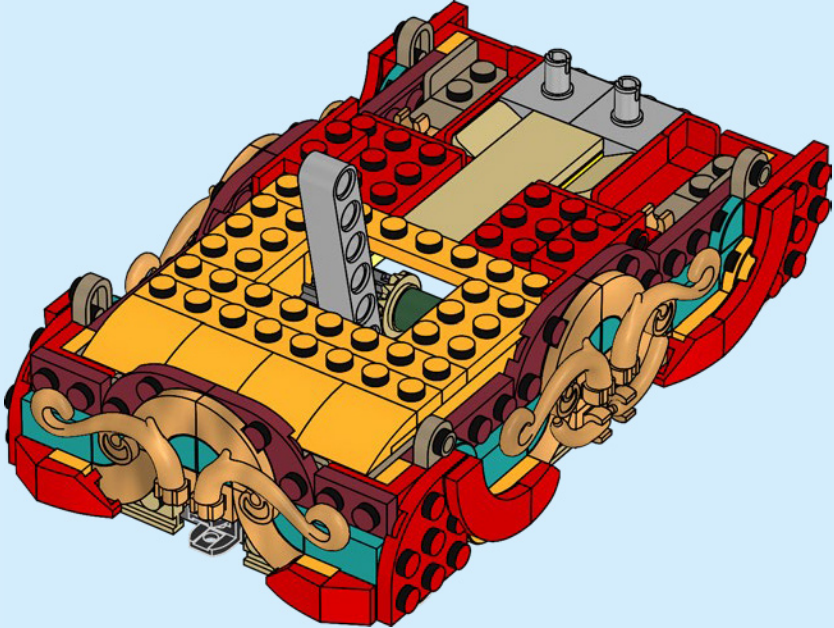

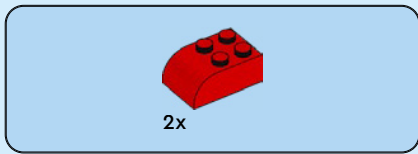

49

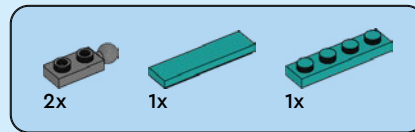
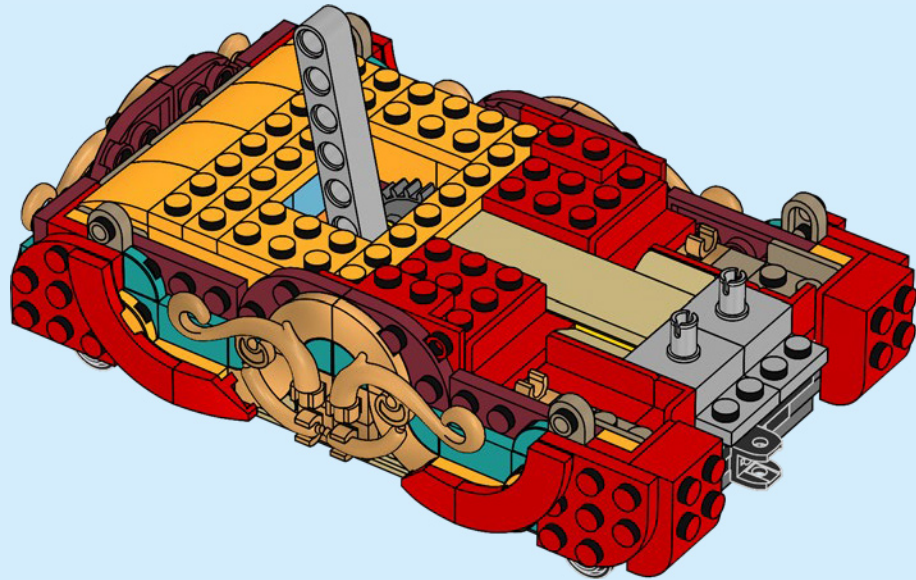

50

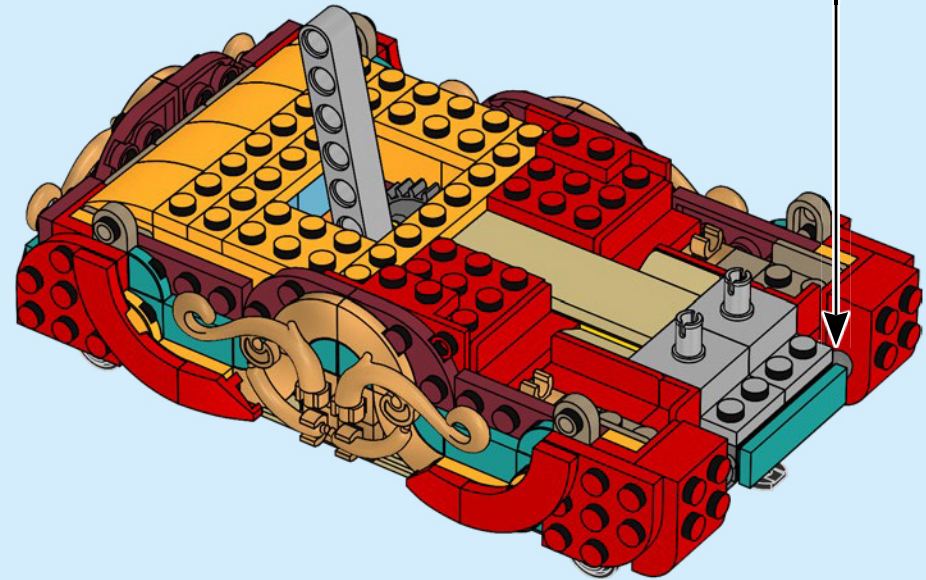
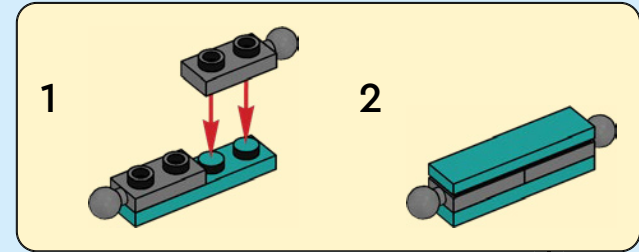

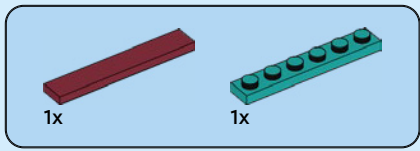

51

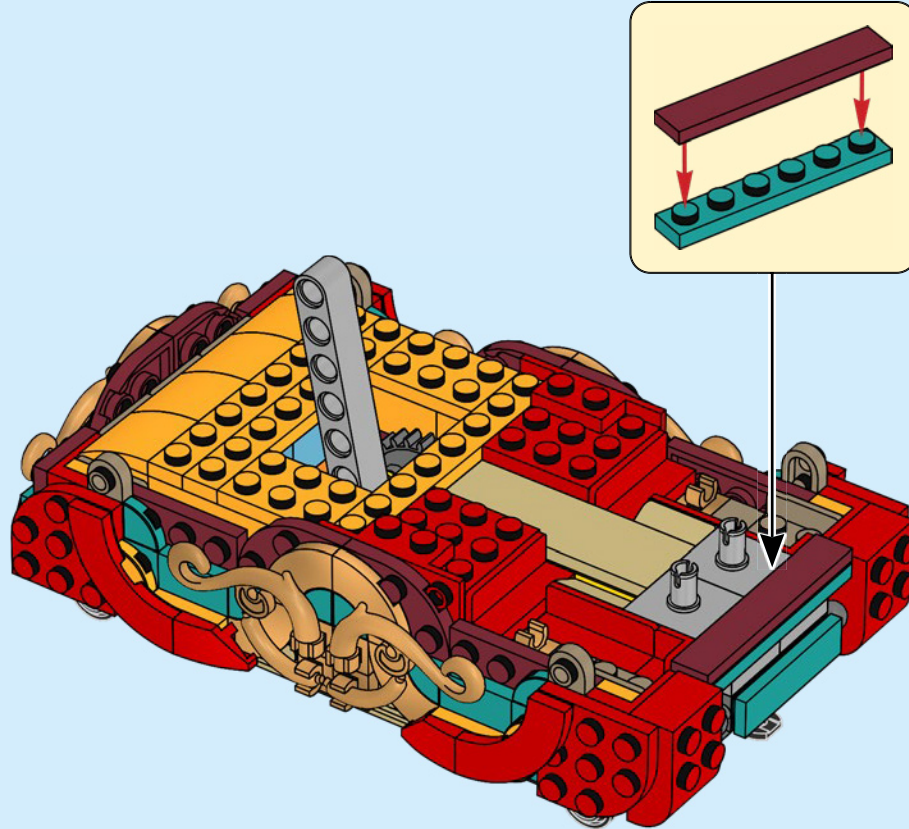

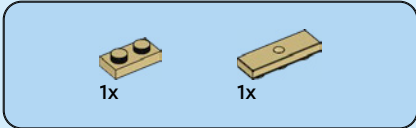
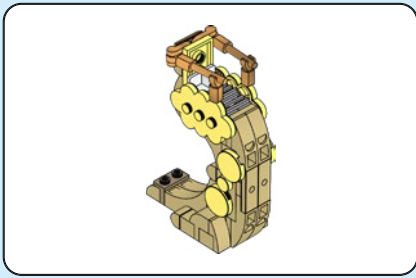

52

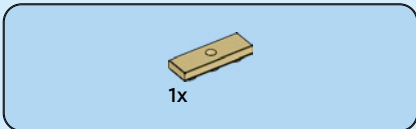
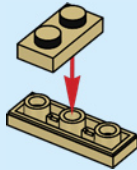

53

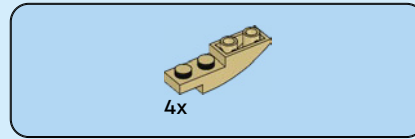
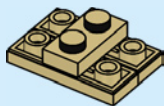

54

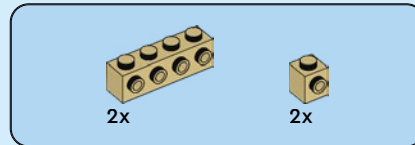
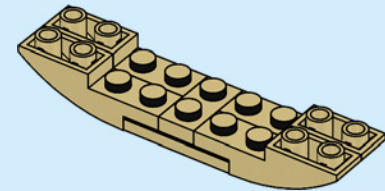

55

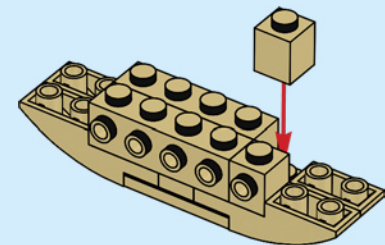

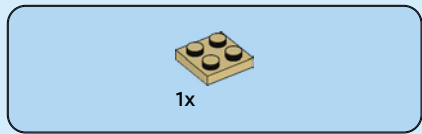

56

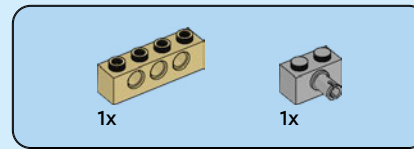
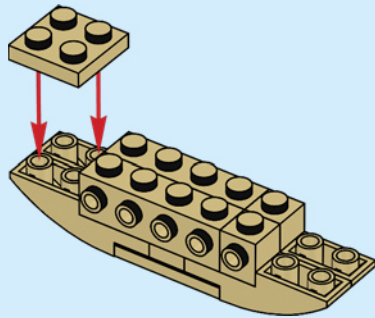

57

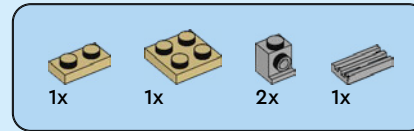
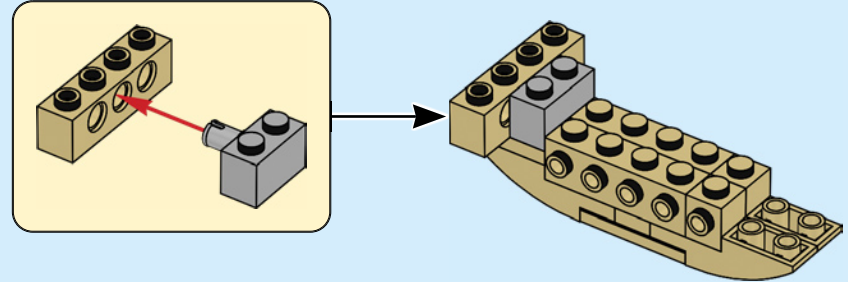

58

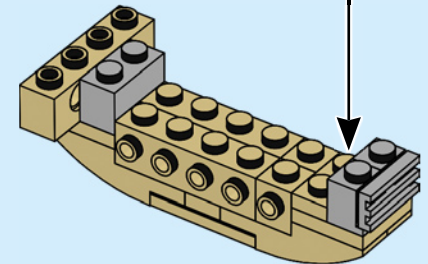
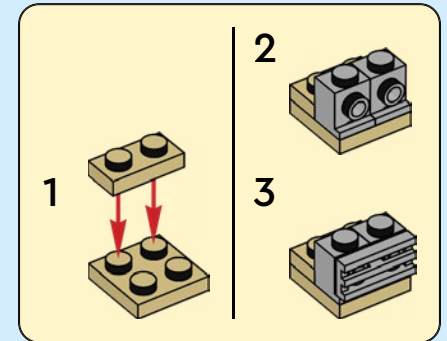

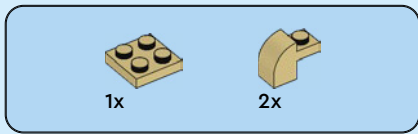

59

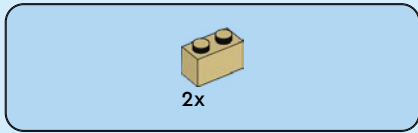
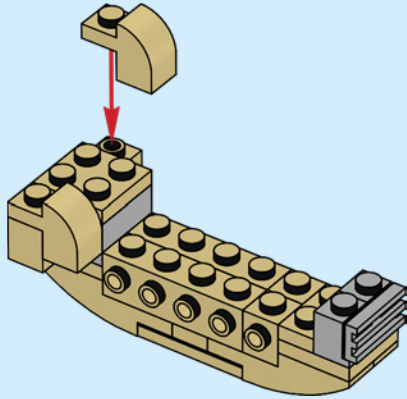

60

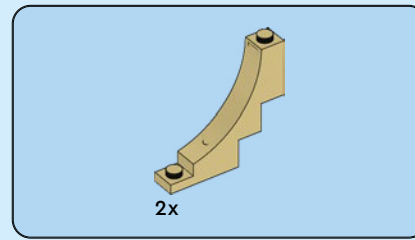
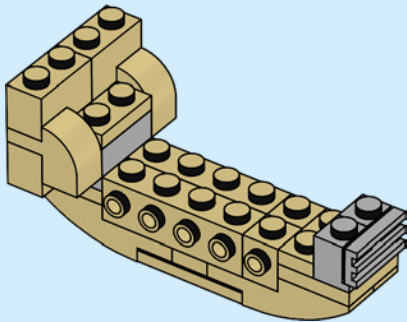

61

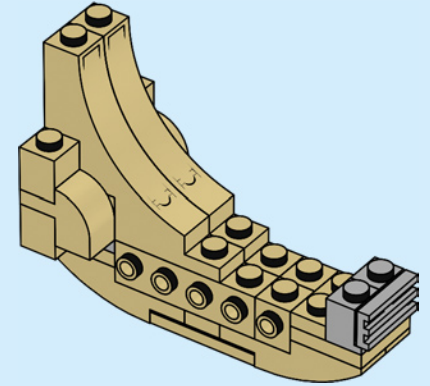

62

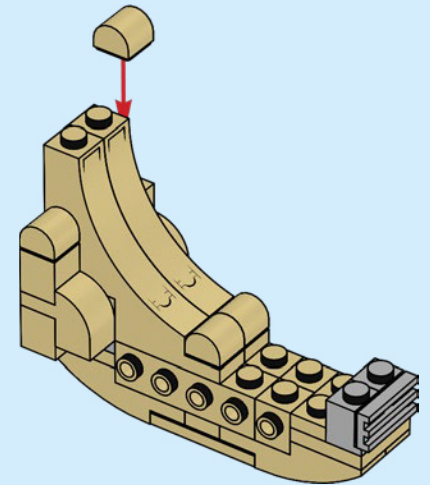

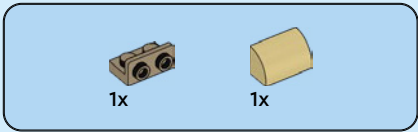

63

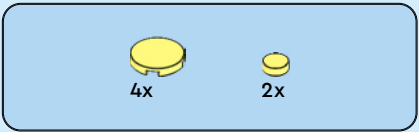
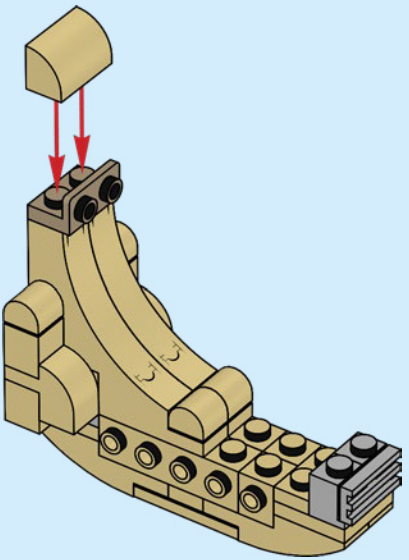

64

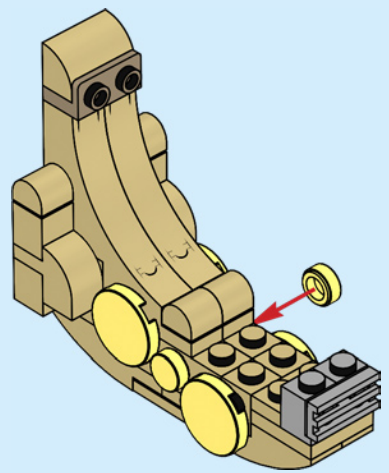

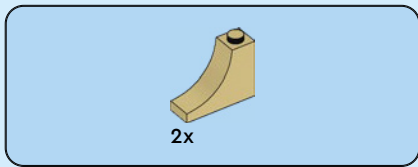

65

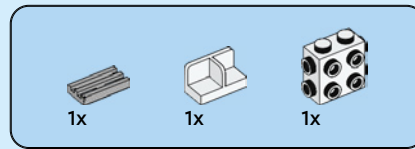
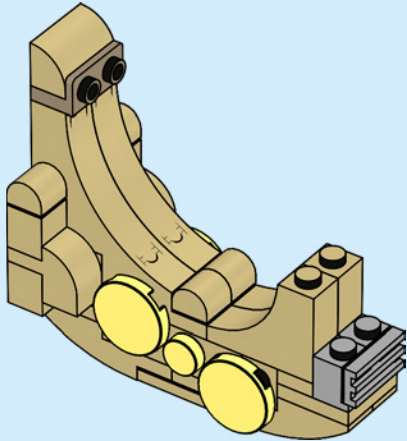

66

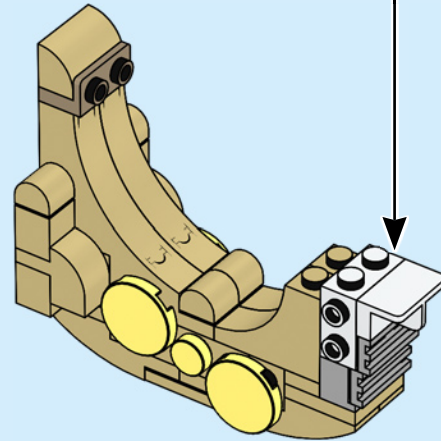
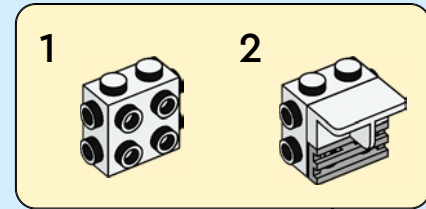

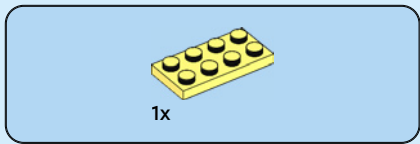

67

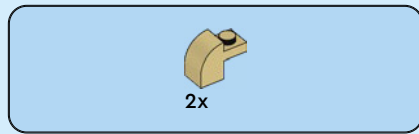
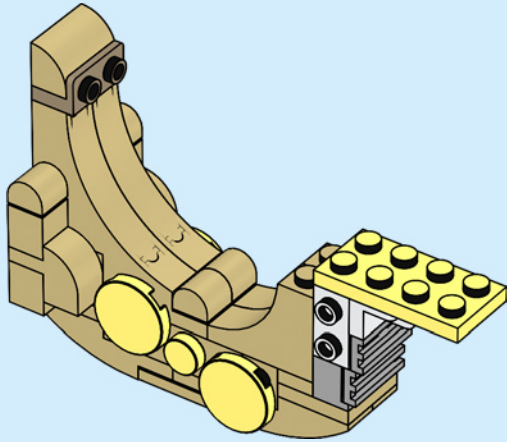

68

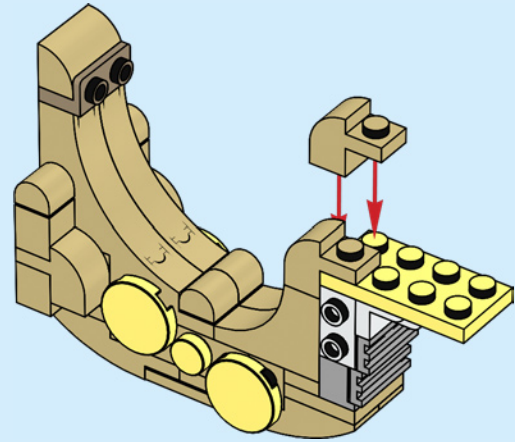

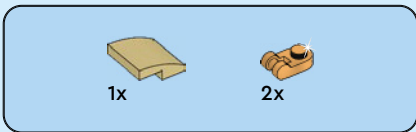

69

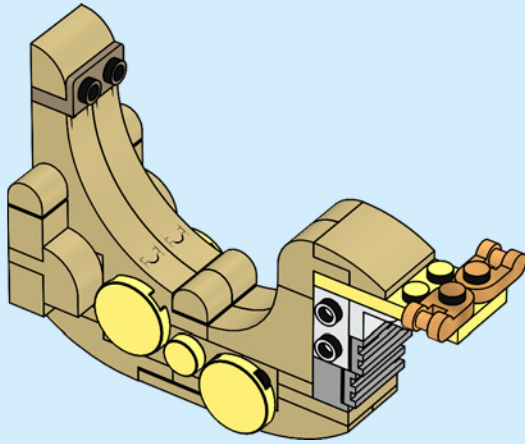

70

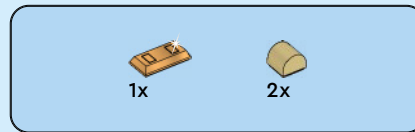
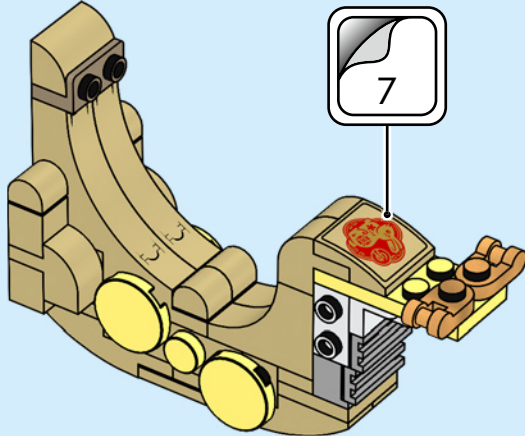

71

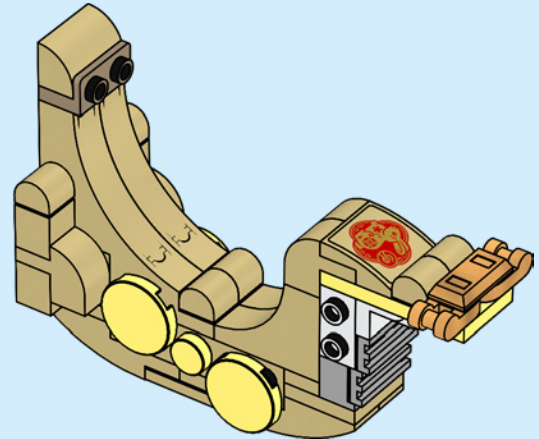



2x

72

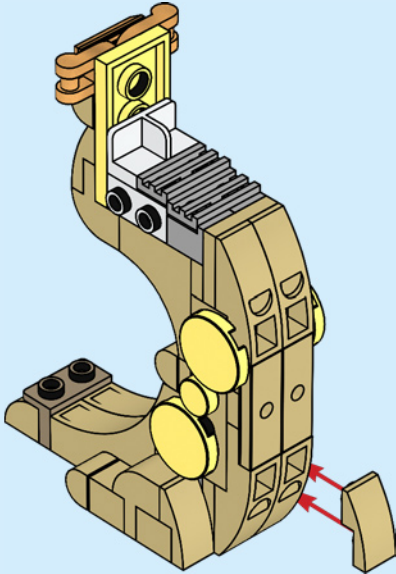

2x

73

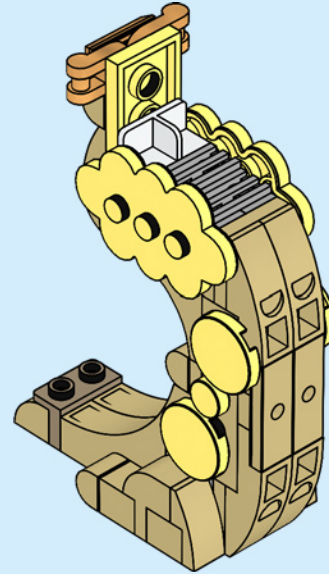

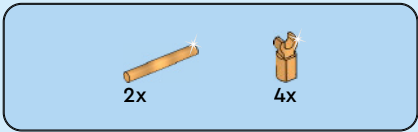

74

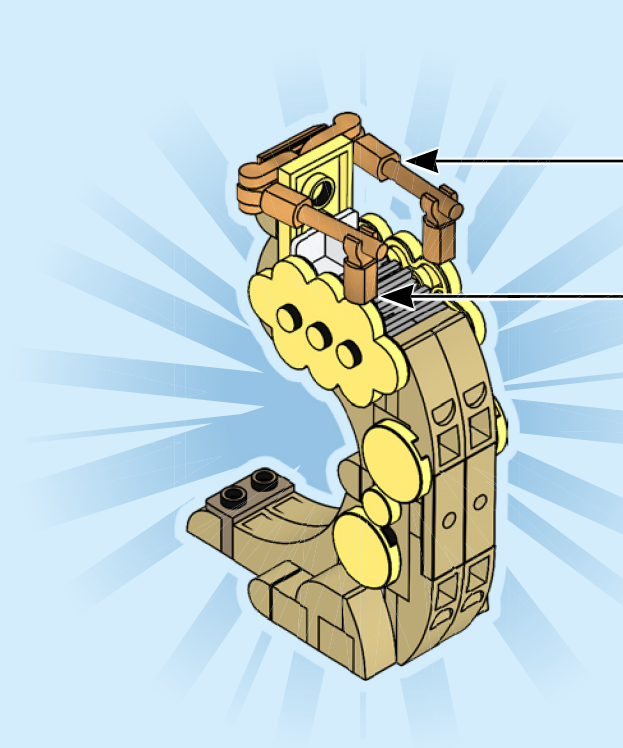
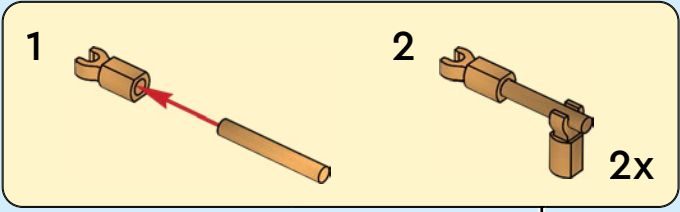

75

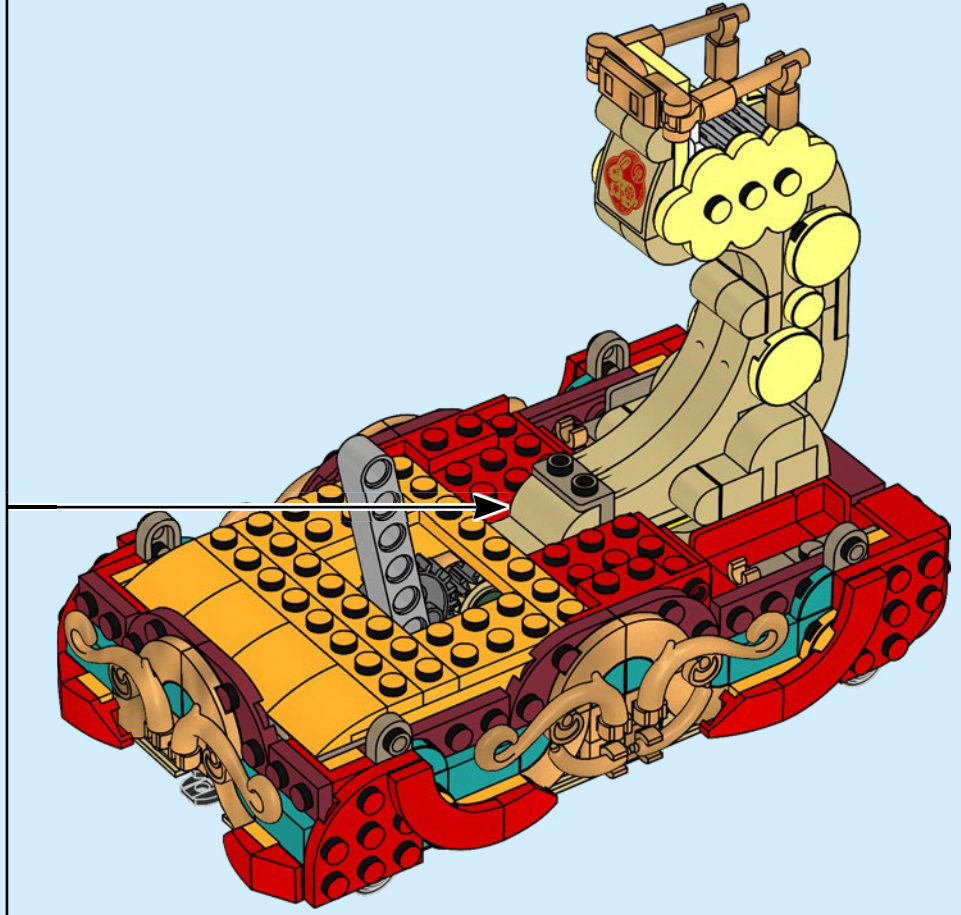

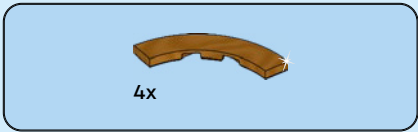

76

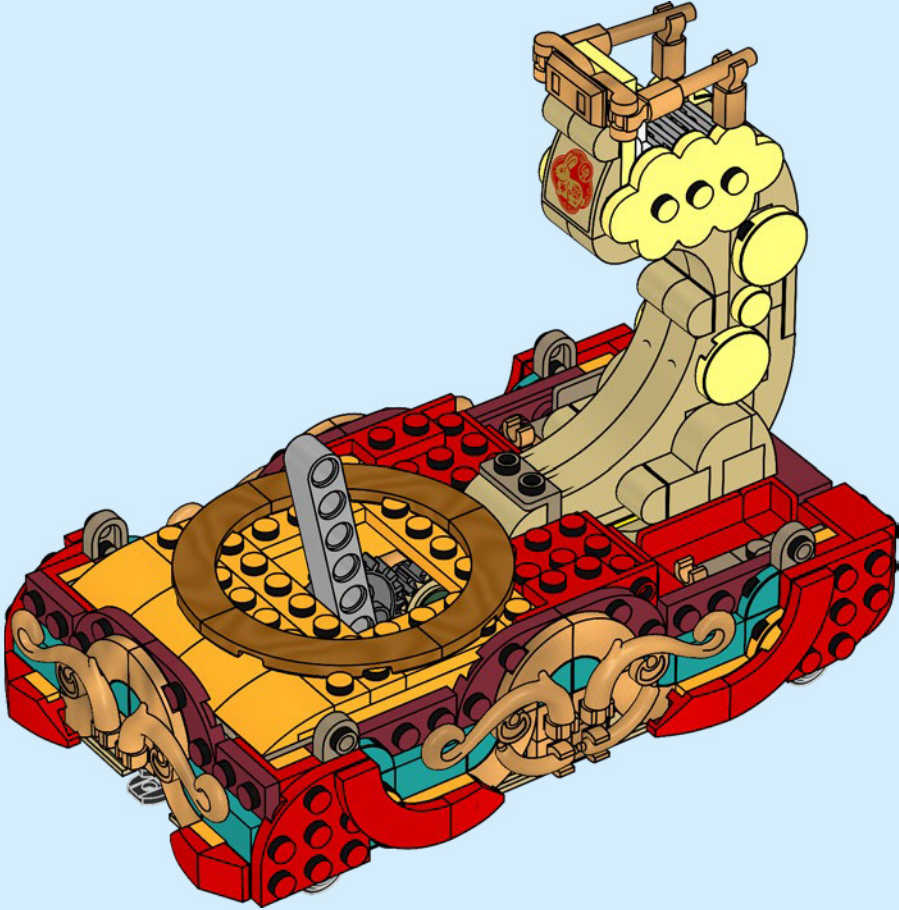

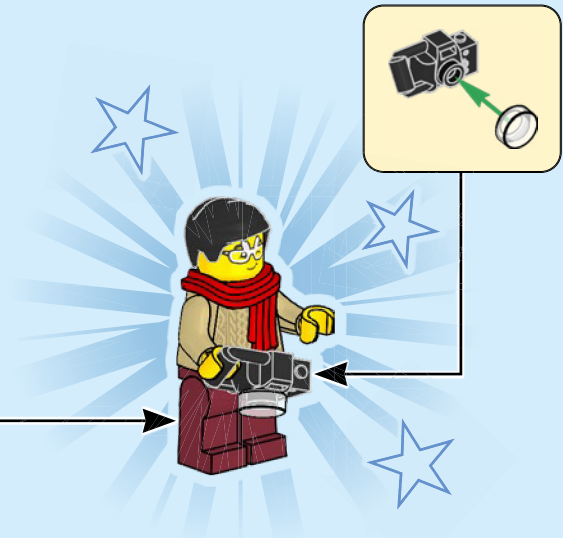
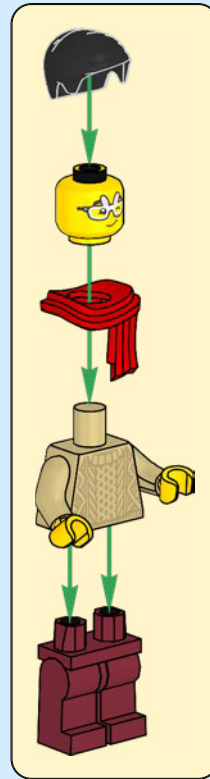
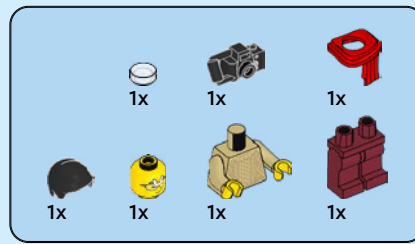

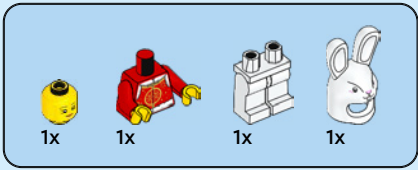

1

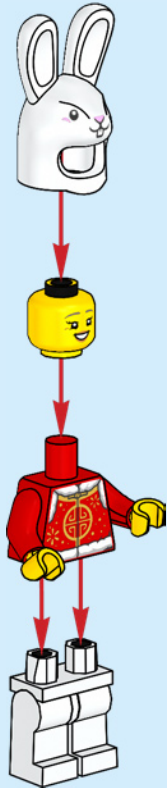

2

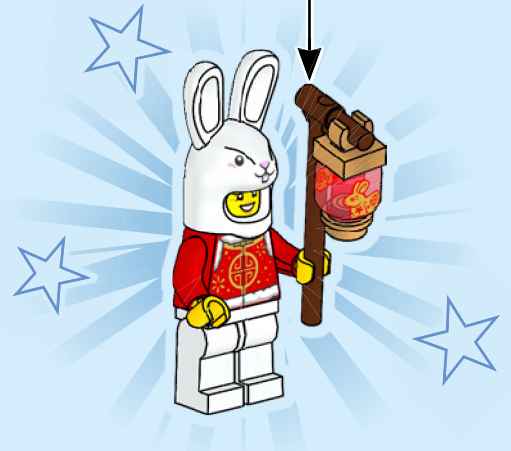
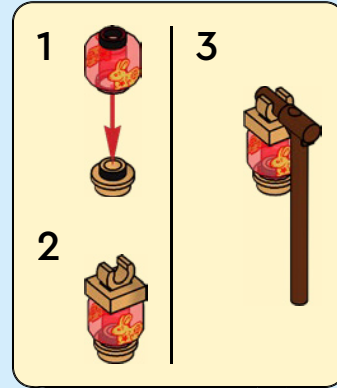

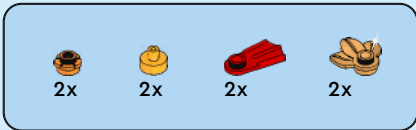

77

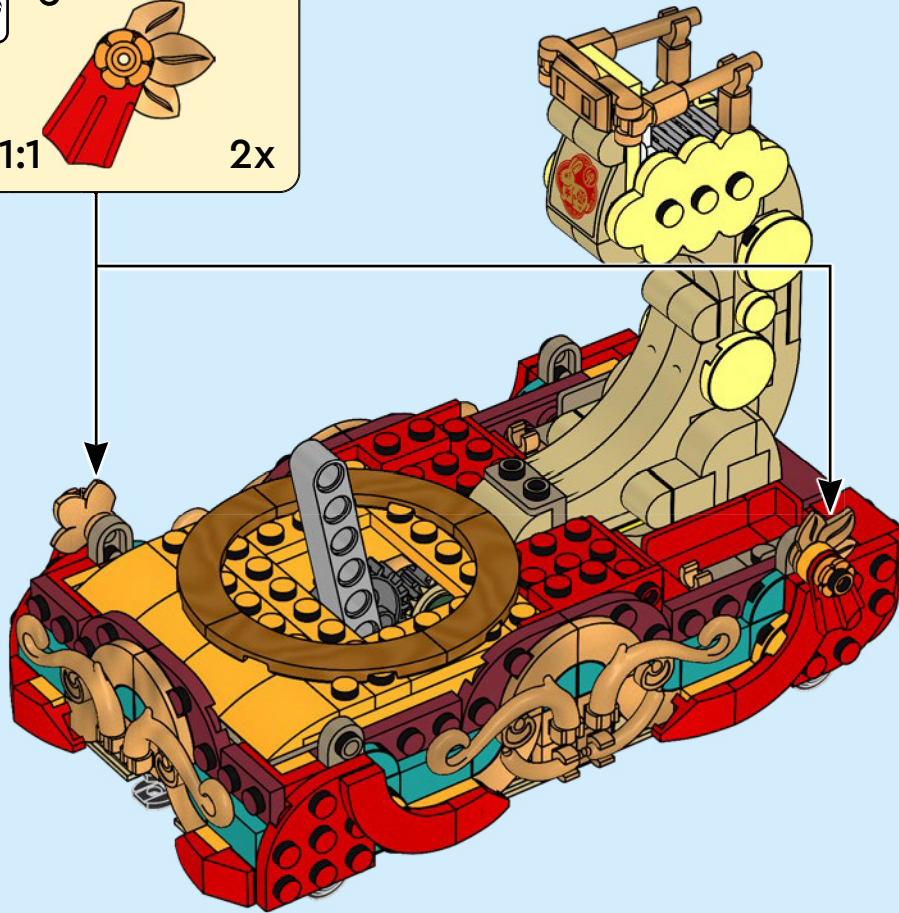
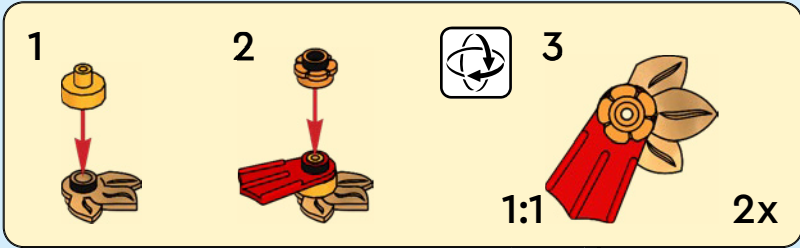

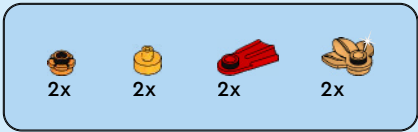

78

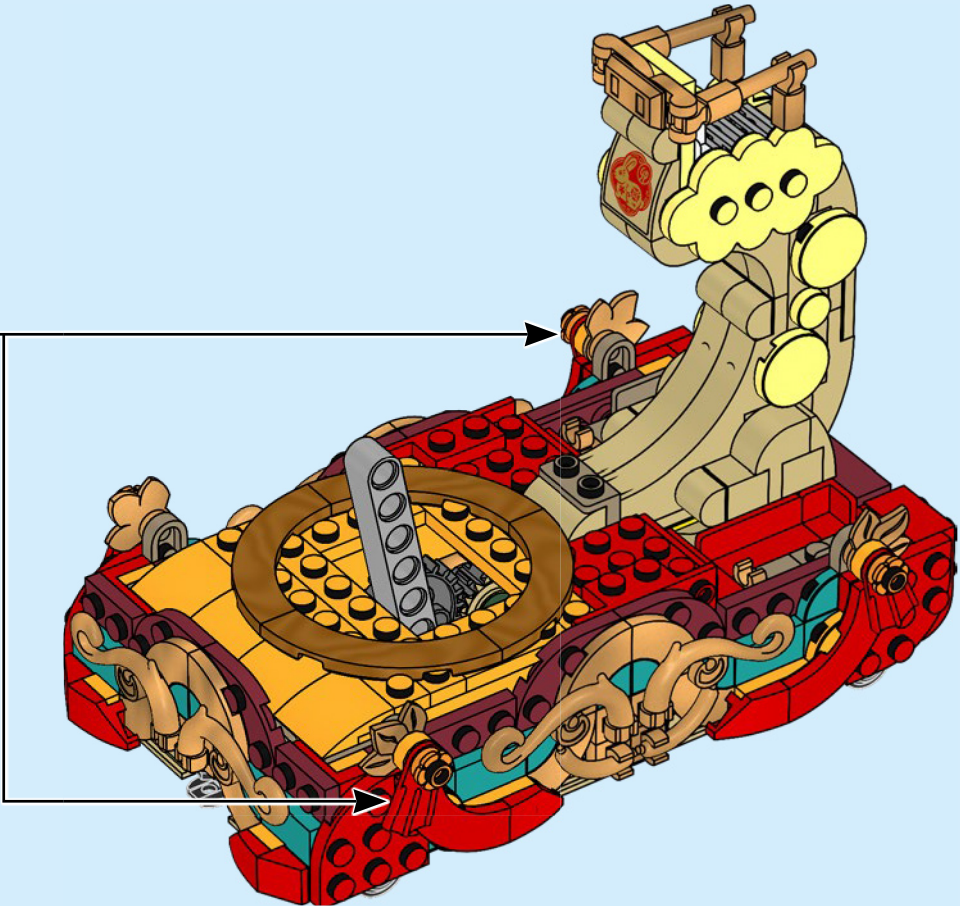
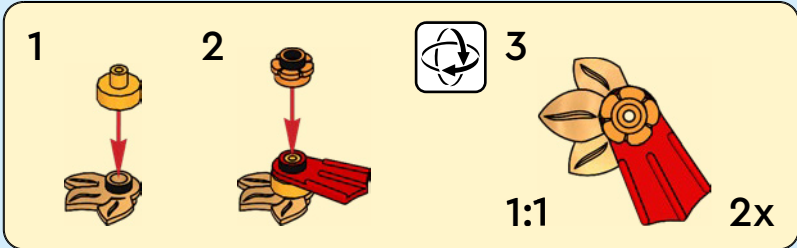

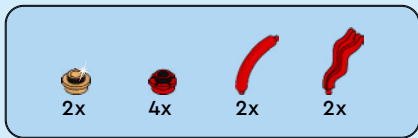

79

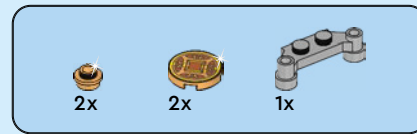
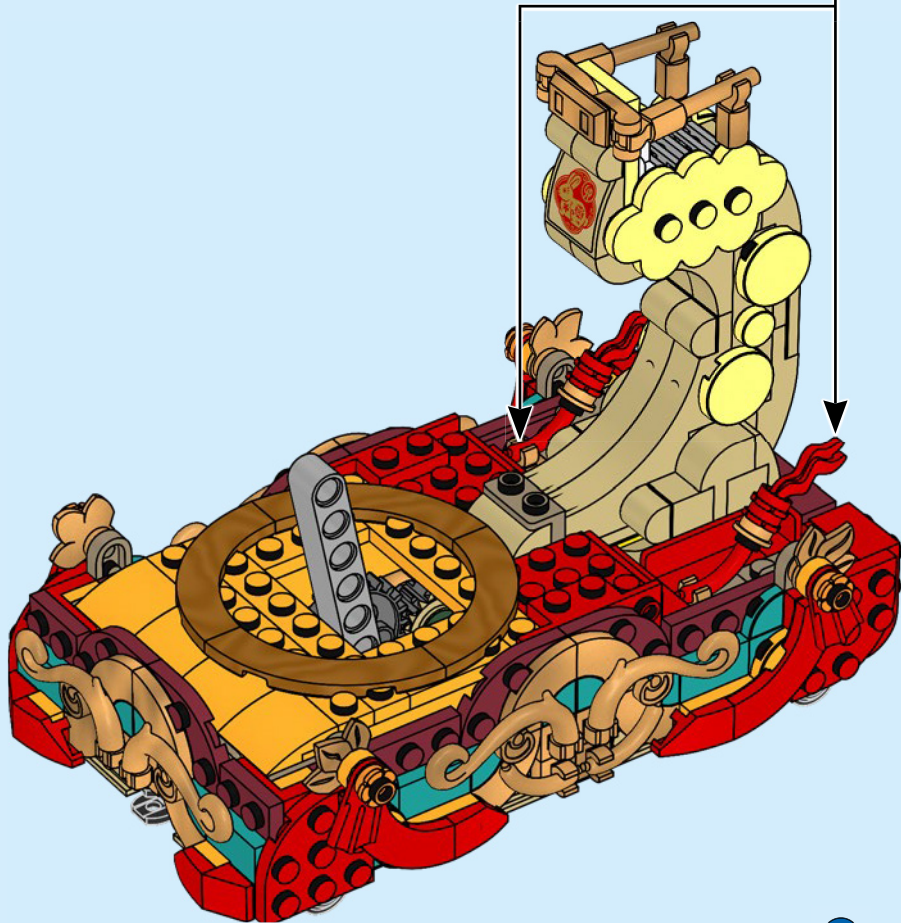
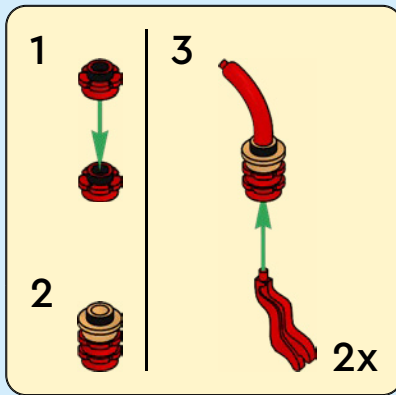

80

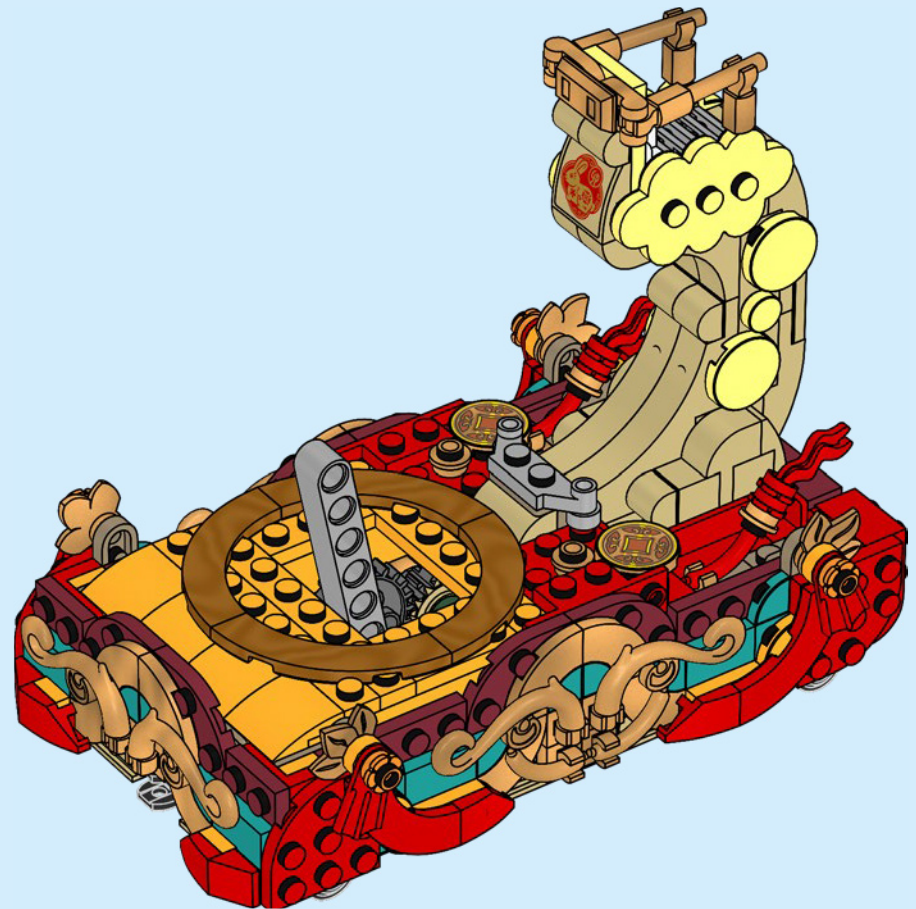



3x

81

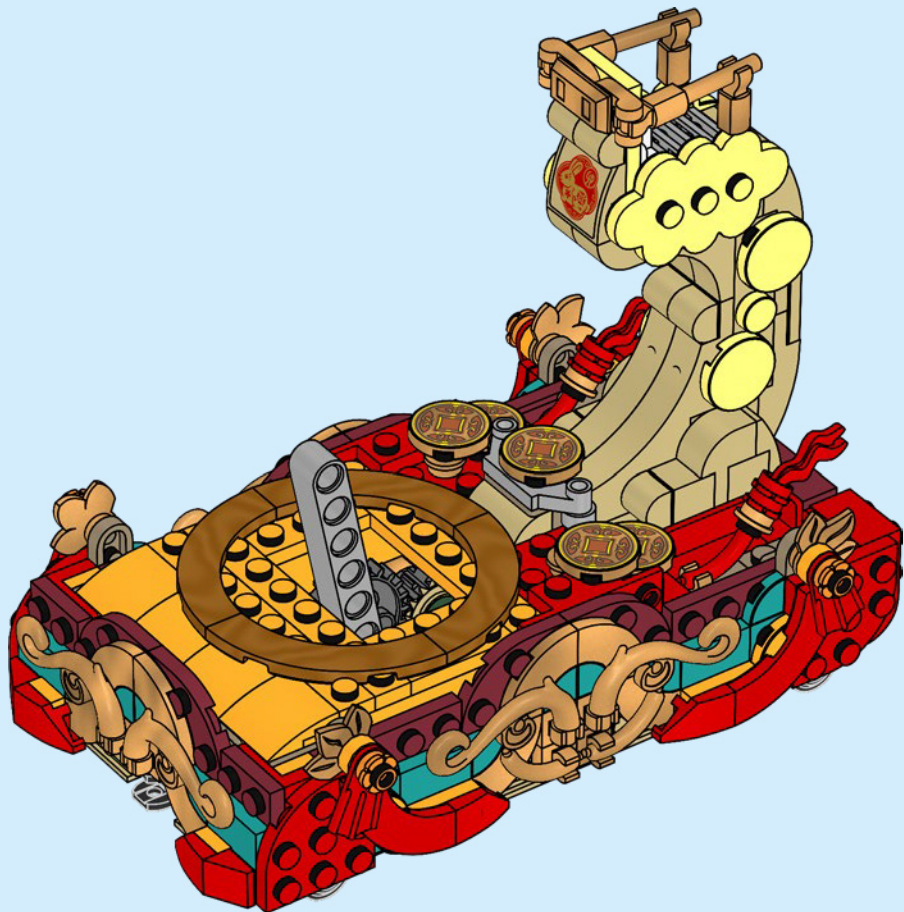

2x



2x



2x

82

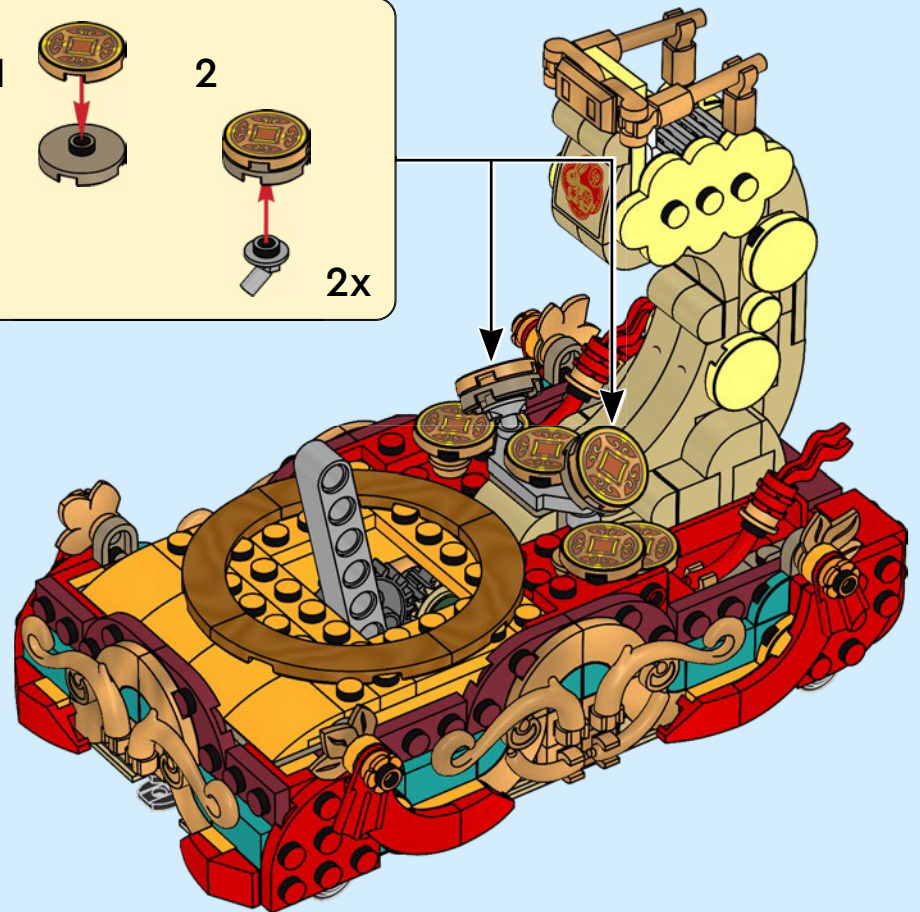
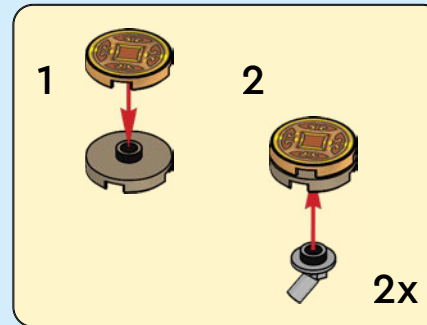

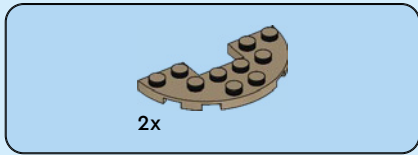
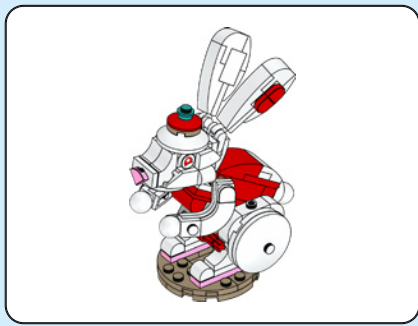

83

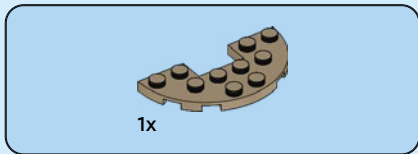
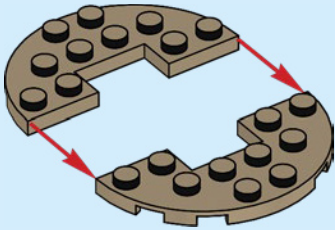

84

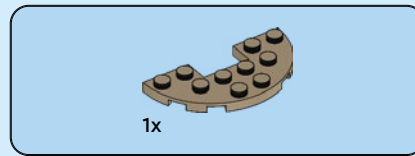
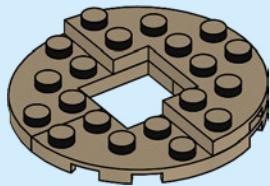

85

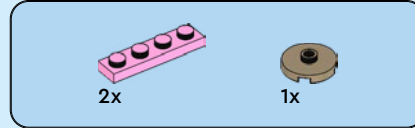
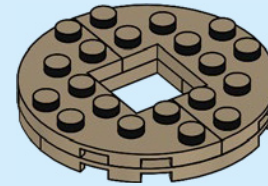

86

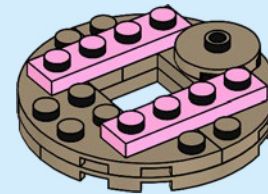



2x



2x

87

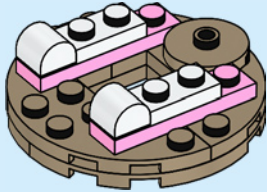

2x



1x



2x



2x

88

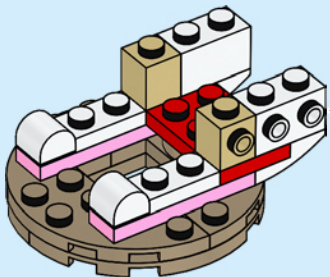
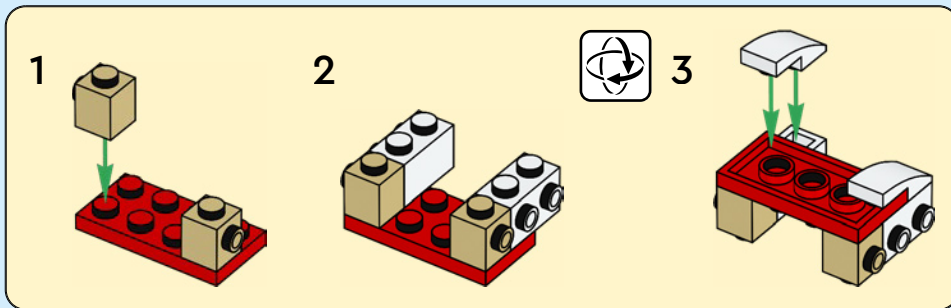

2x



2x

89

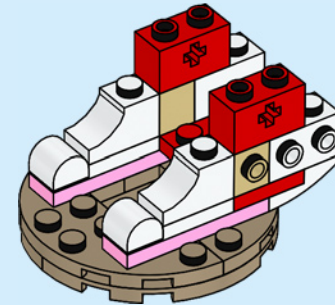

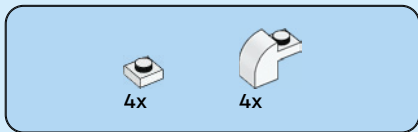

90

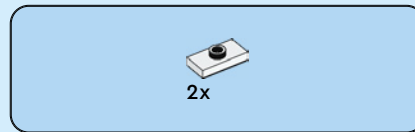
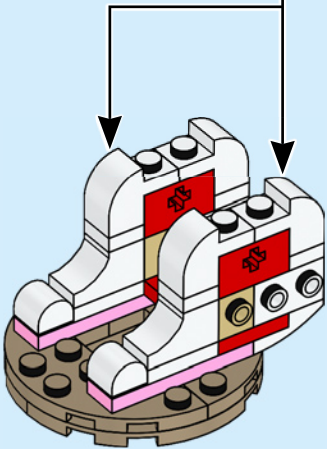
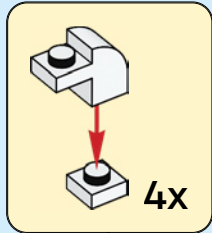

91

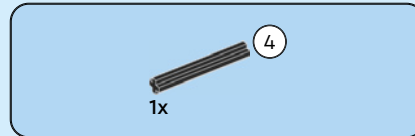
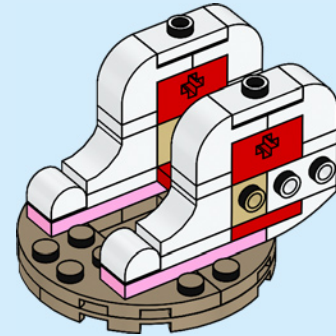

92

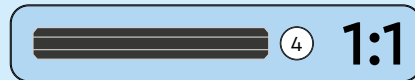
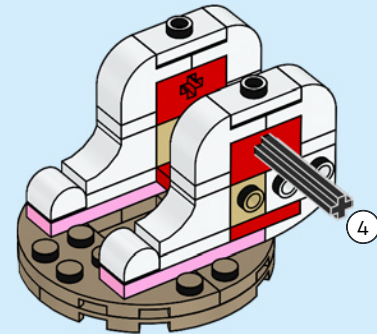

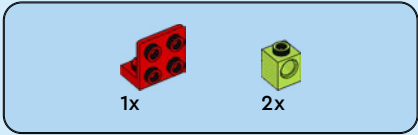
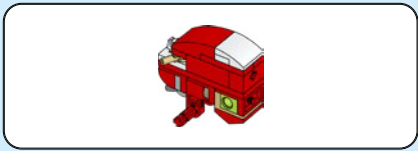

93

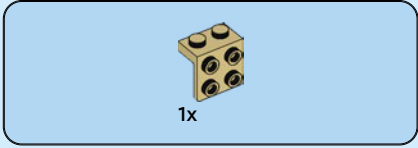
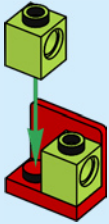

94

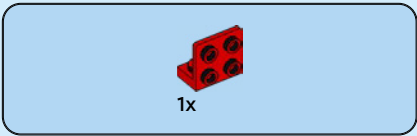

95



96



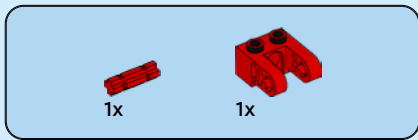

97

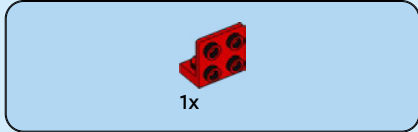
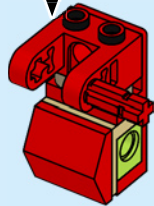
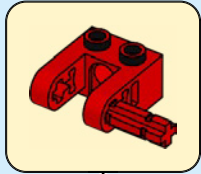

98

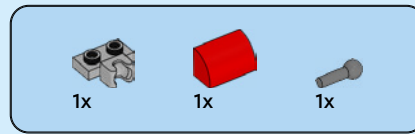
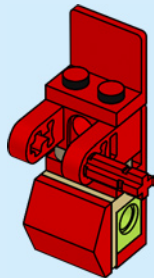

99

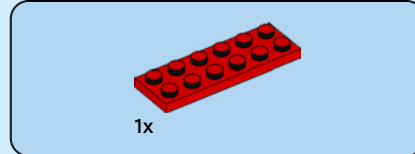
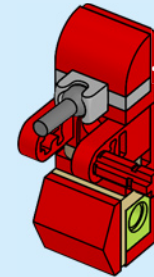
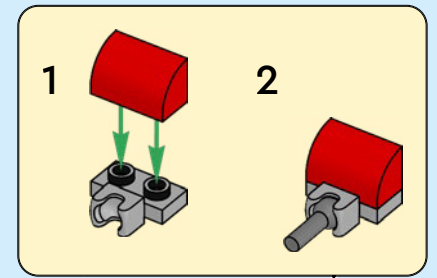

100

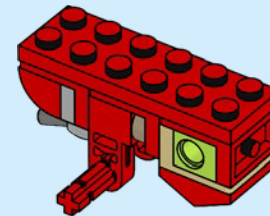
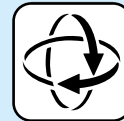

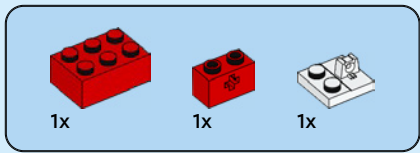

101

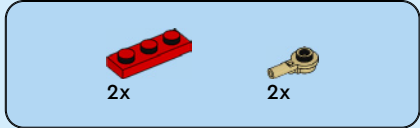
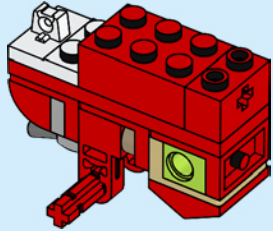

102

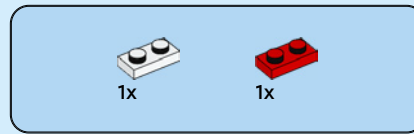
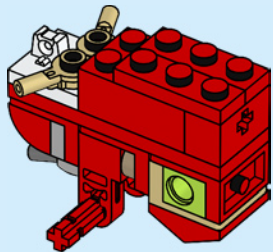

103

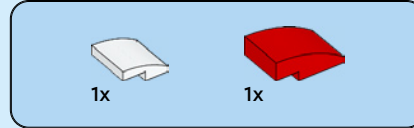
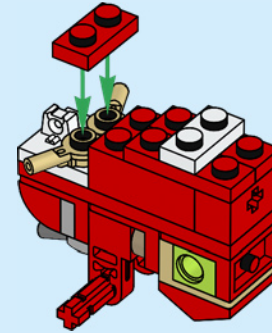

104

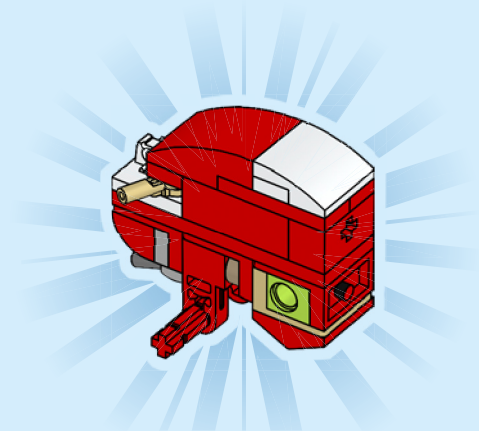

105

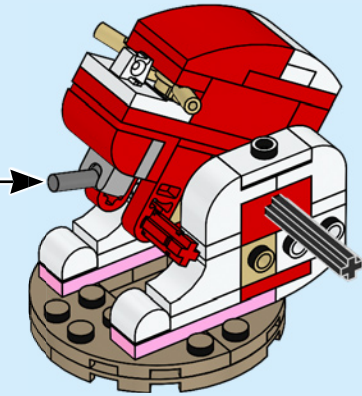

106

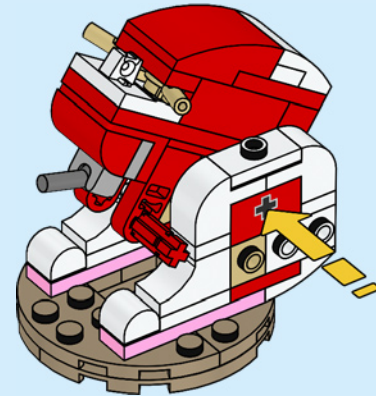

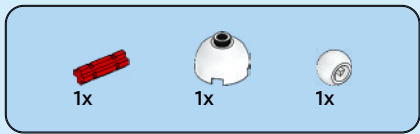

107

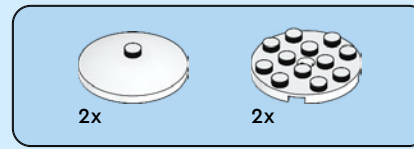
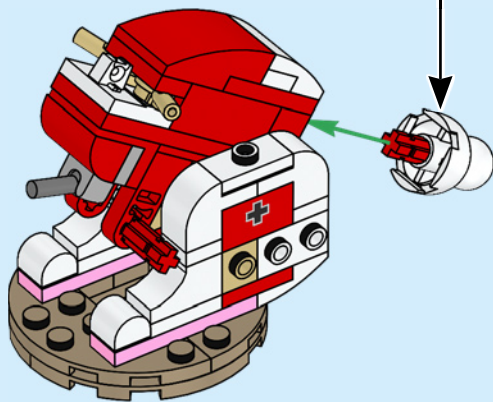
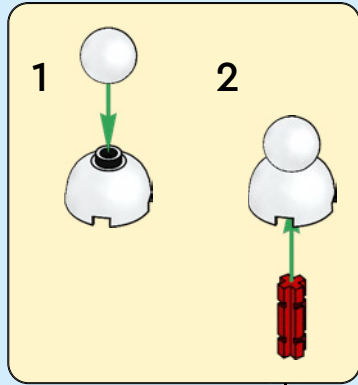

108

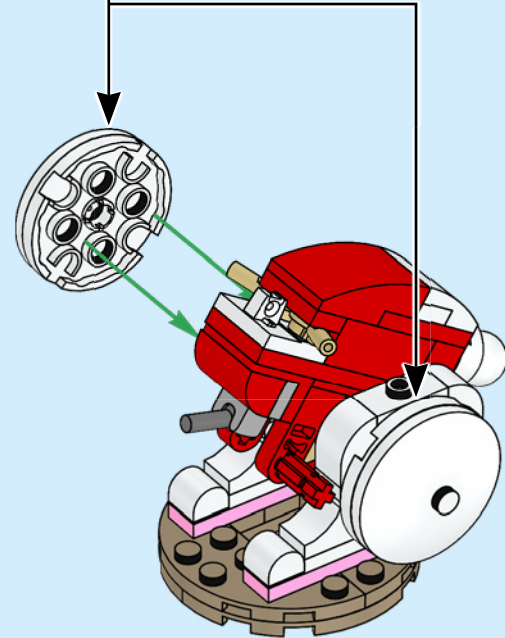
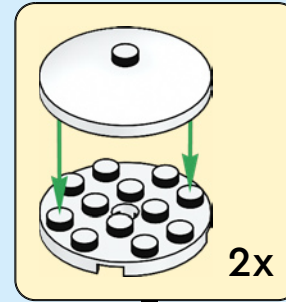

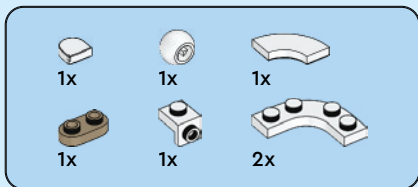

109

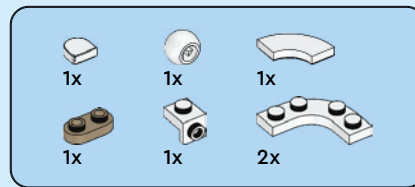
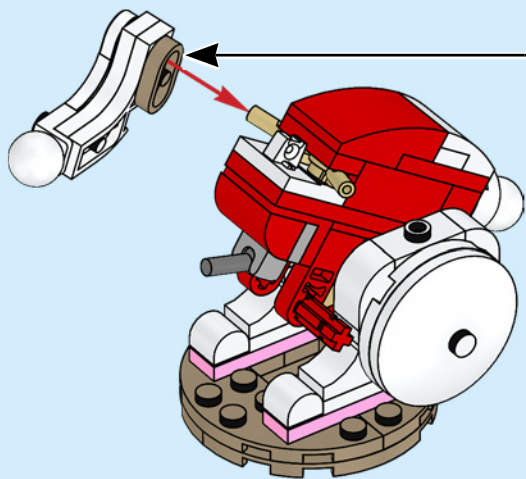
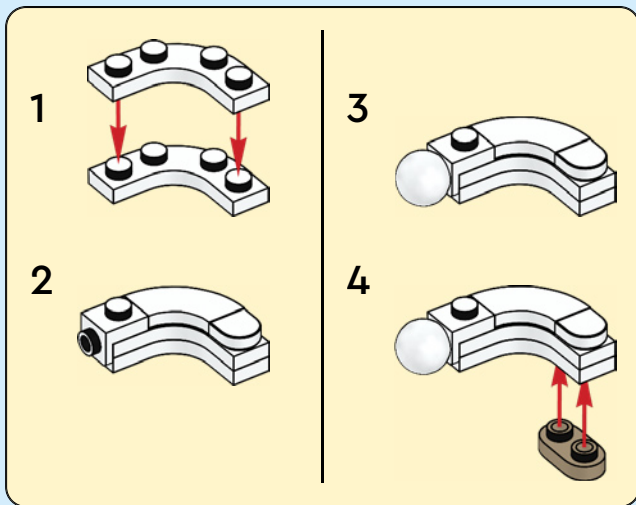

110

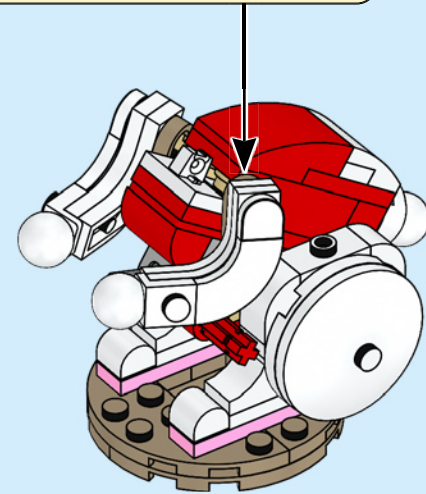
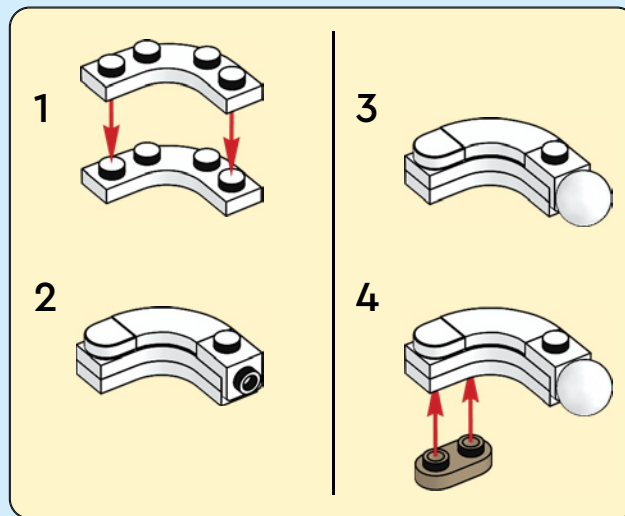

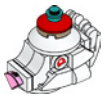

111

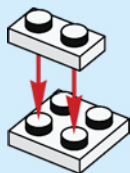

112

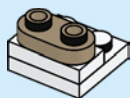

113

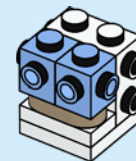

114

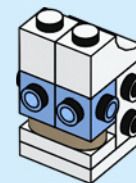

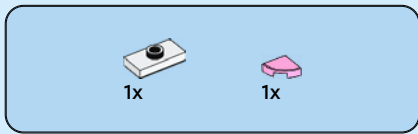

115

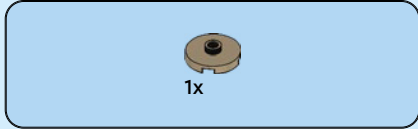

116

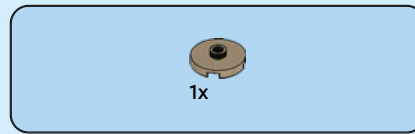
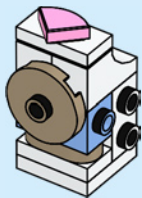

117

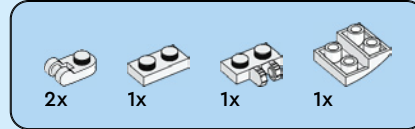
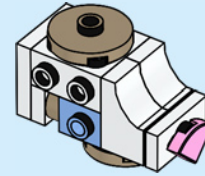
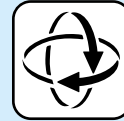

118

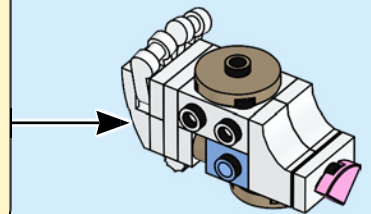
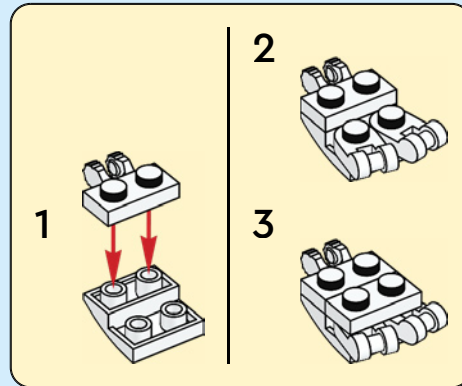



119

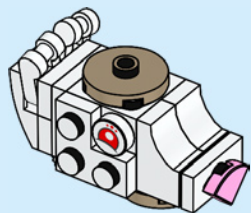

121

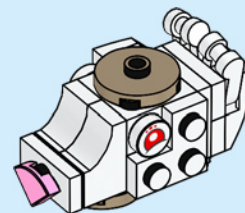
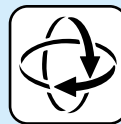

120

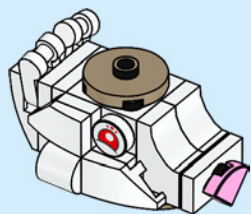

122

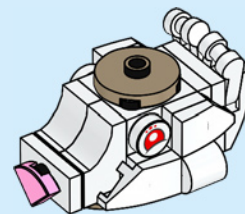

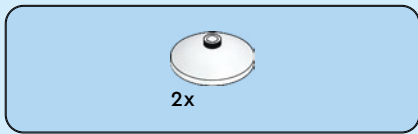

123

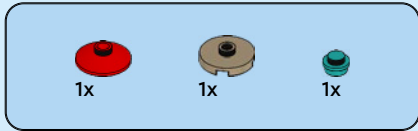
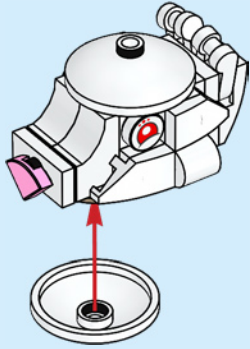

124

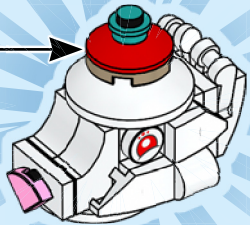
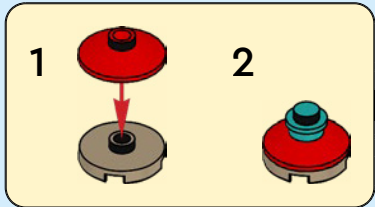

125

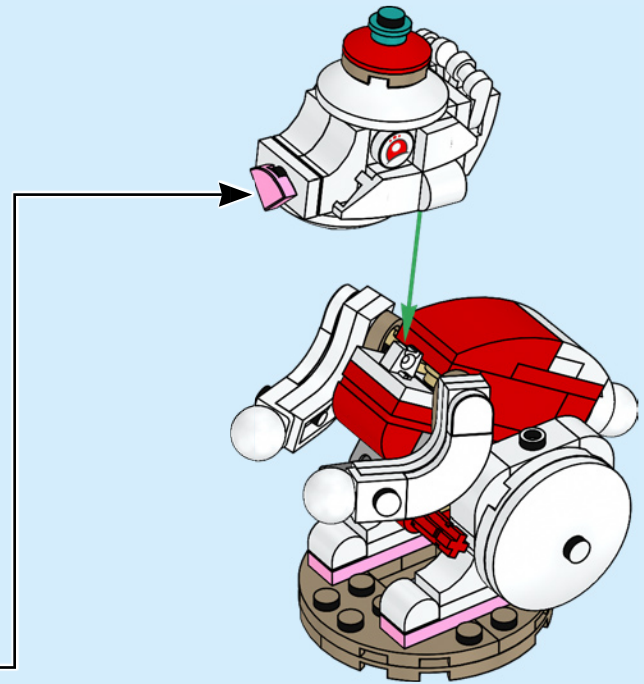

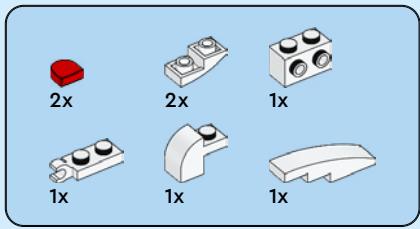

126

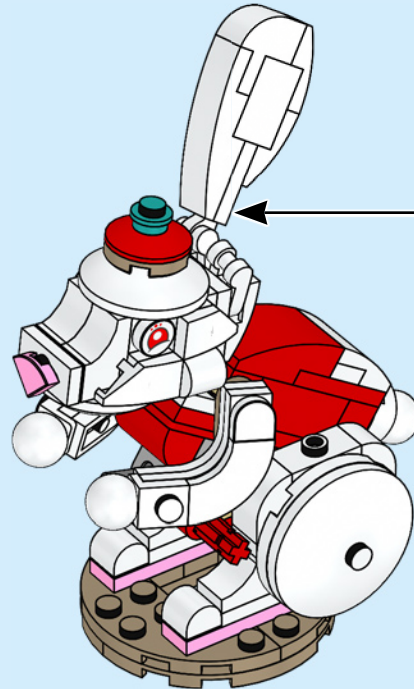
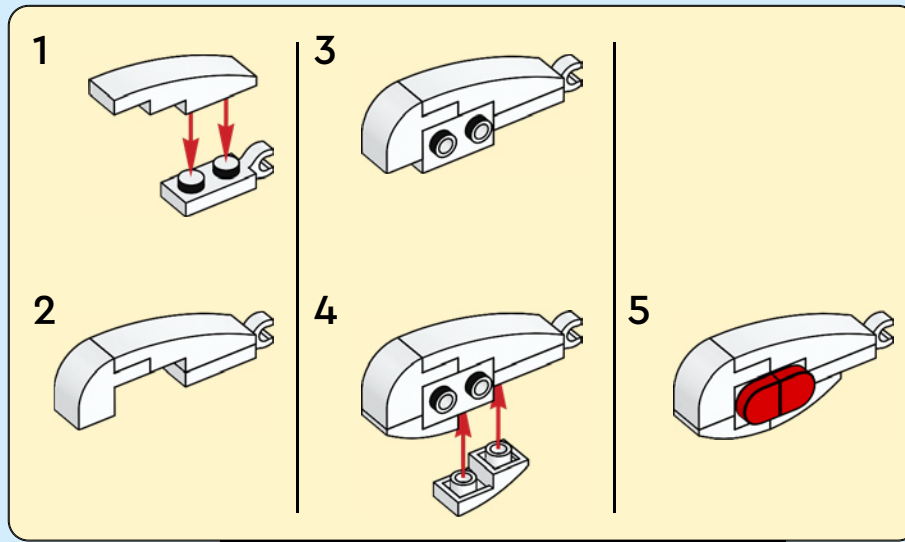

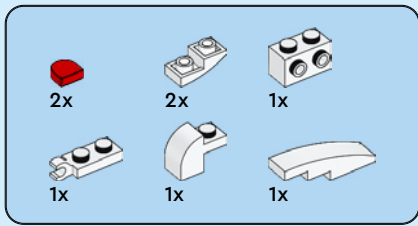

127

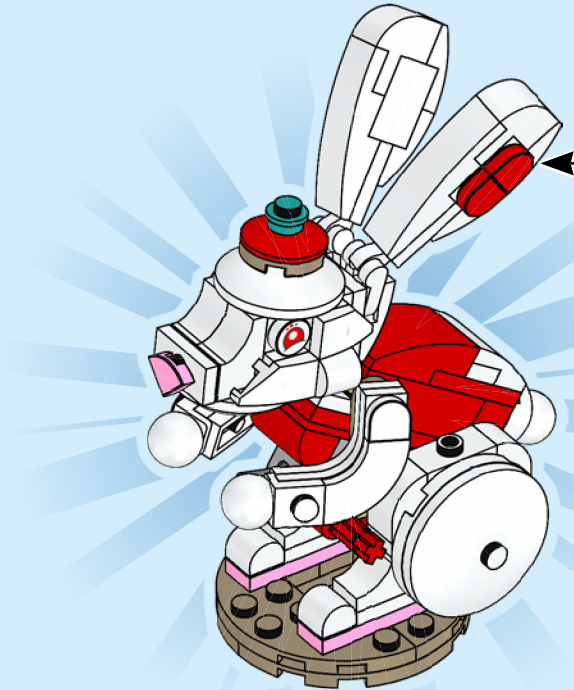
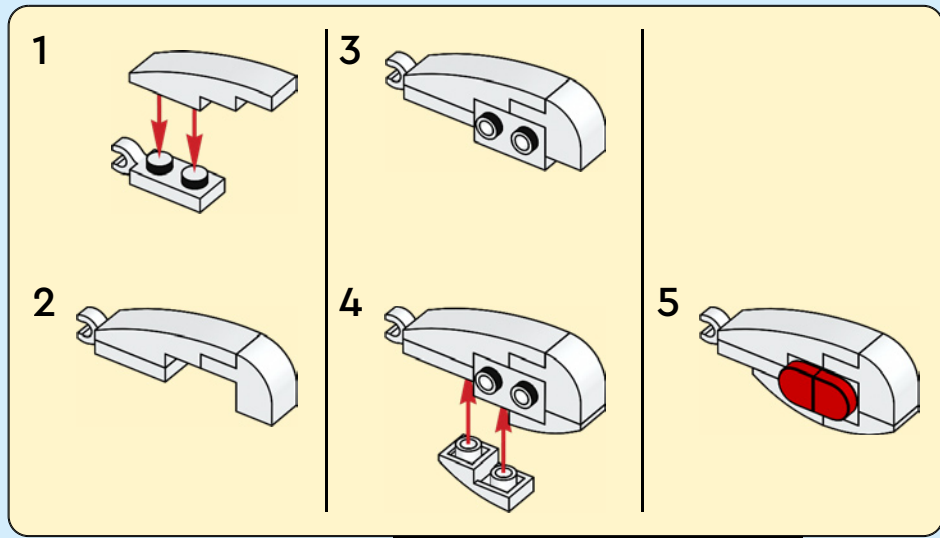

128

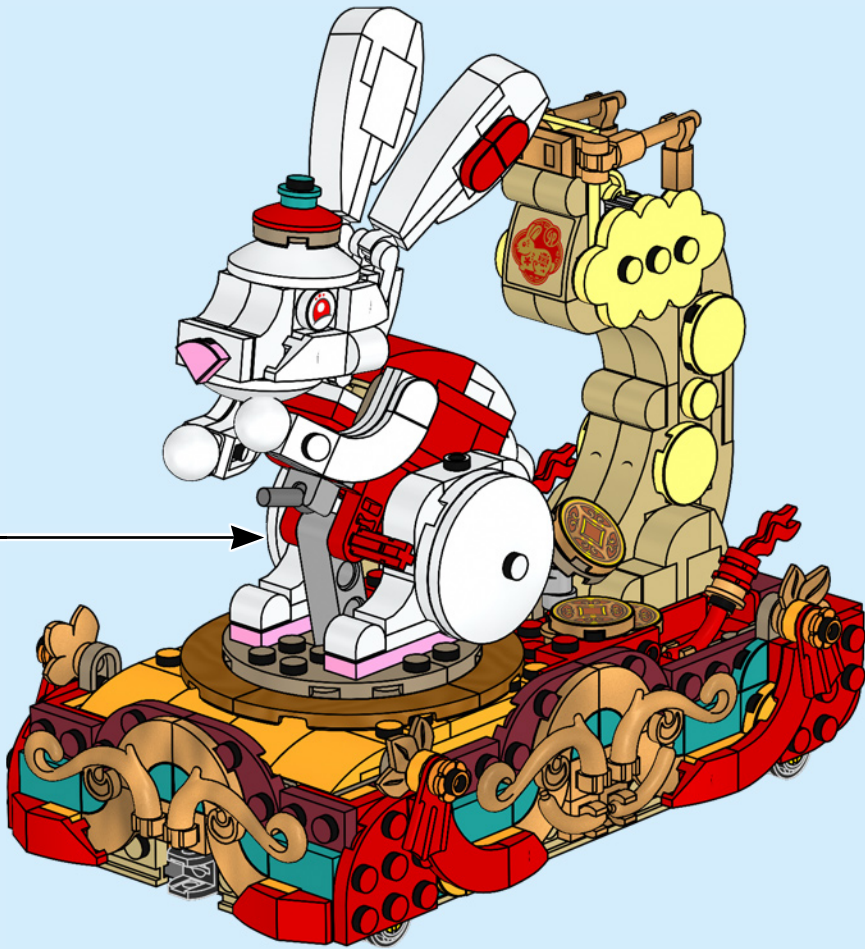

129

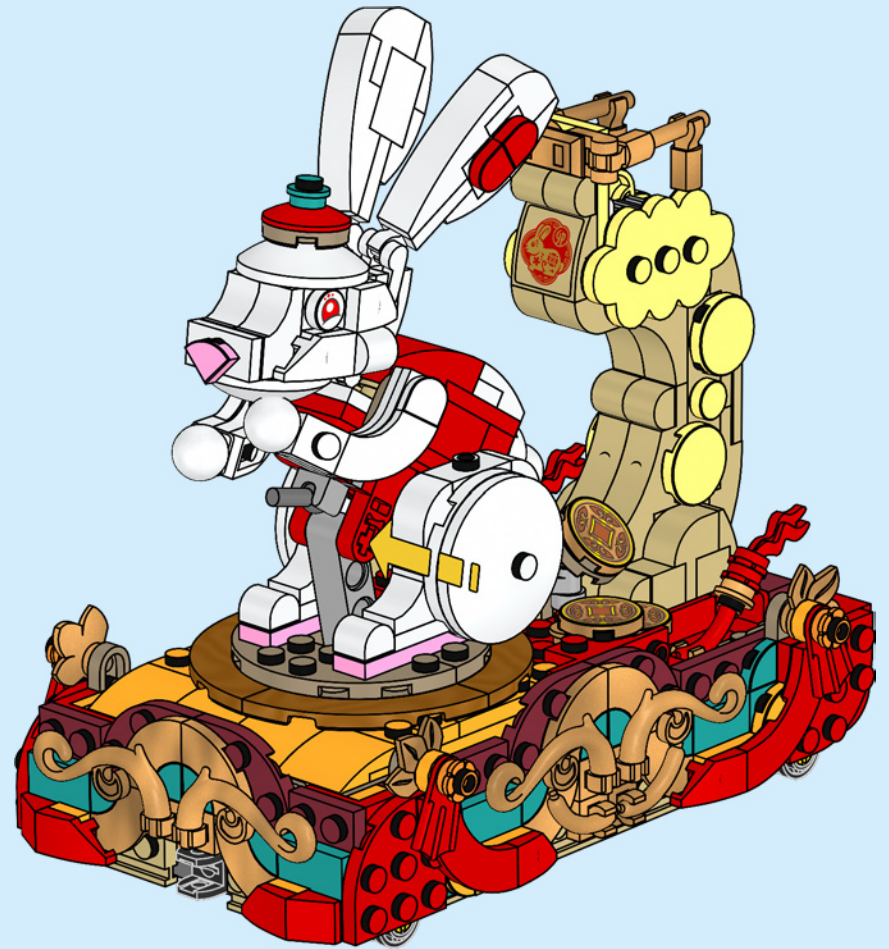

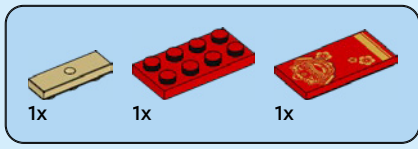

130

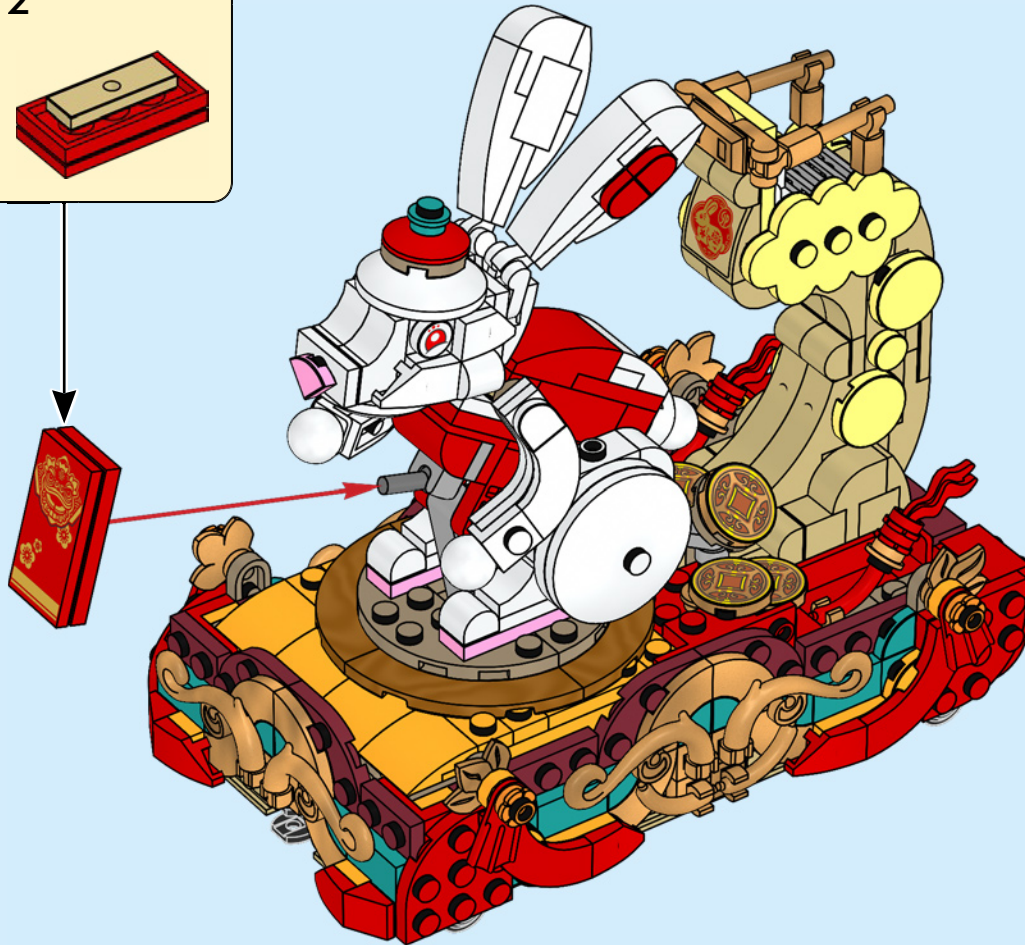
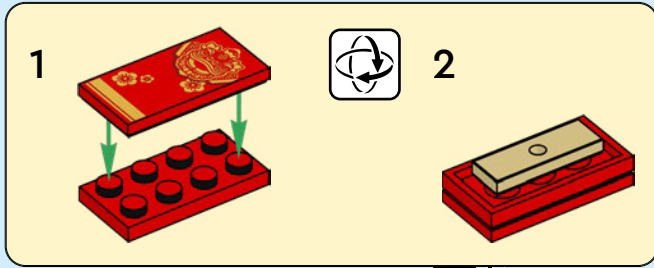



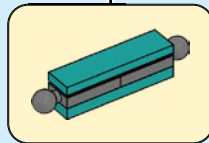
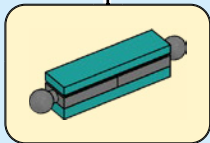
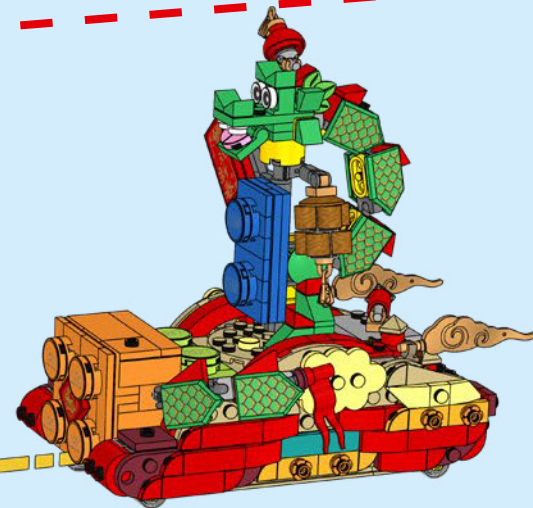
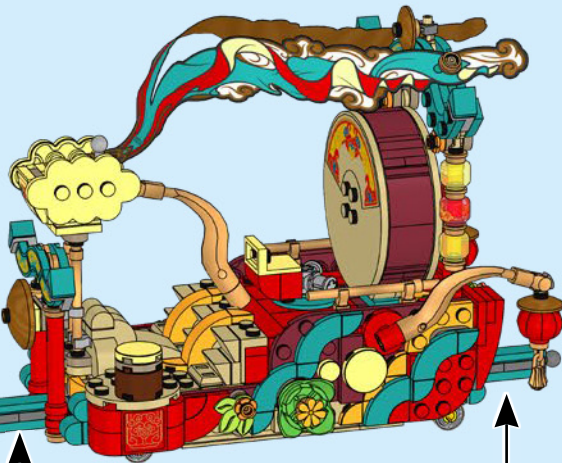
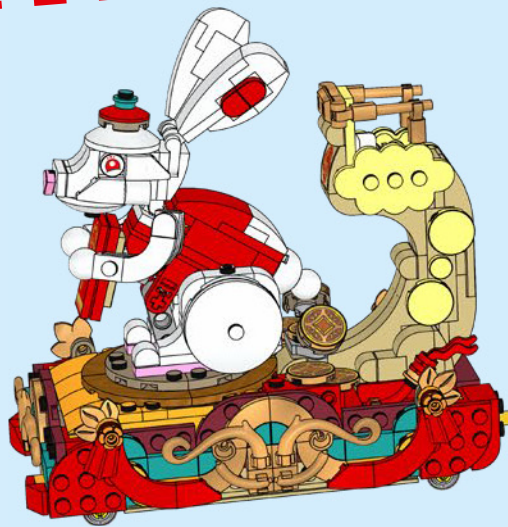
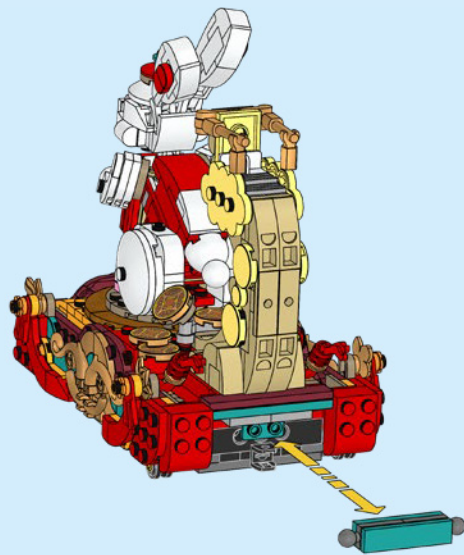
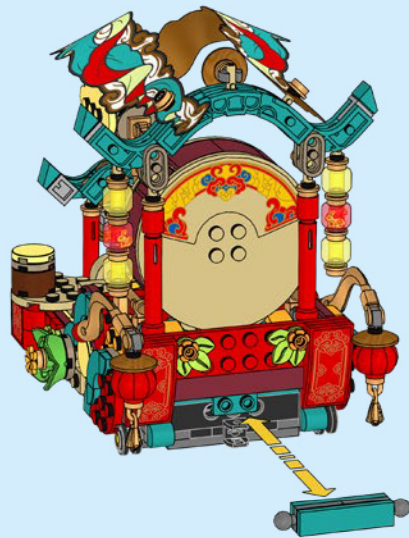
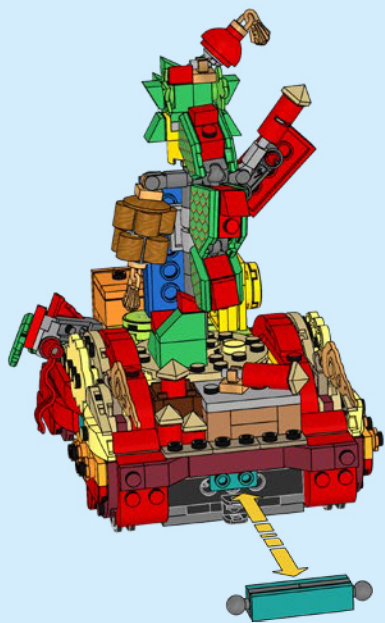



MONKIE KID 悟空小侠™



80040



80043



80045



80041

COMBINE 80036+80044

Combine 80036 + 80044
 Kombinierbar mit 80036 und 80044
 Combinez les sets 80036 et 80044
 Combina 80036 + 80044
 可将 80036 和 80044 组合玩乐
 Объедините наборы 80036 + 80044
 Połącz 80036 + 80044
 Zkombinujte stavebnice 80036 a 80044
 Skombinujte stavebnice 80036 a 80044
 Kombinál a 80036-os és 80044-es szettel!
 Combină 80036 + 80044
 Комбинируйте 80036 + 80044
 Savieno komplektus 80036 un 80044
 Sobita kokku komplektid 80036 ja 80044
 Sujunkite 80036 + 80044





Rebuild
the
world™



YOU COULD **WIN** 

Scan this QR code or go to **LEGO.COM/PRODUCTFEEDBACK** and give us your short feedback about this LEGO® set for a chance to win a cool LEGO prize.

Terms and Conditions apply*



DE: Du könntest GEWINNEN. Es gelten die Teilnahmebedingungen* **FR: Tu pourrais GAGNER.** Des conditions s'appliquent* **IT: Potresti VINCERE tu.** Termini e condizioni sono applicabili* **ES: Puedes GANAR.** Aplican términos y condiciones* **PT: Poderá GANHAR.** Aplicam-se termos e condições* **JA: プレゼント付き! 利用規約が適用されます*** **ZH: 轻松获奖. 条款和条件适用*** **KO: 상품의 주인이 되어보세요. 소정의 약관이 적용됩니다*** **RU: Вы можете ВЫИГРАТЬ.** Действуют положения и условия* **PL: Szansa na WYGRANĄ.** Obowiązują warunki korzystania* **CS: Máte šanci VYHRÁT.** Platí všeobecné smluvní podmínky* **SK: Máte šancu VYHRAŤ.** Platia všeobecné zmluvné podmienky* **HU: TE IS NYERHETSZ.** Felhasználási feltételek érvényesek* **RO: Ai putea CÂȘTIGA.** Se aplică termeni și condiții* **BG: Можете да СПЕЧЕЛИТЕ.** Има определени правила и условия* **LV: Tu vari LAIMĒT.** Ir spēkā noteikumi un nosacījumi.* **ET: Sul on võimalus VÕITA.** Kehtivad tingimused* **LT: Jūs galite LAIMĖTI.** Taikomos sąlygos*

*[LEGO.com/productfeedback-terms](https://www.lego.com/productfeedback-terms)