

1

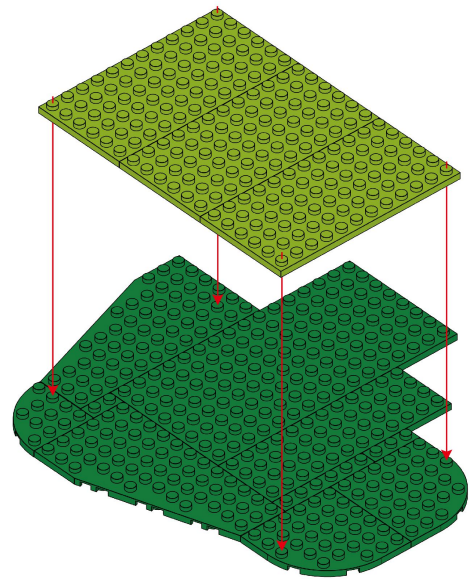

=2=

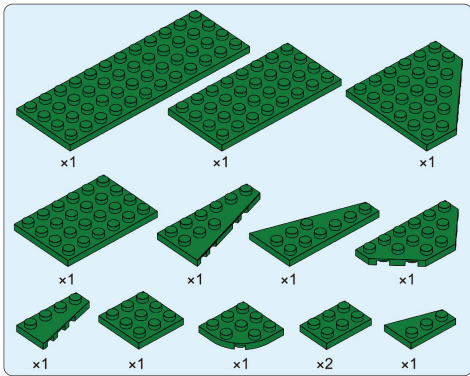

2

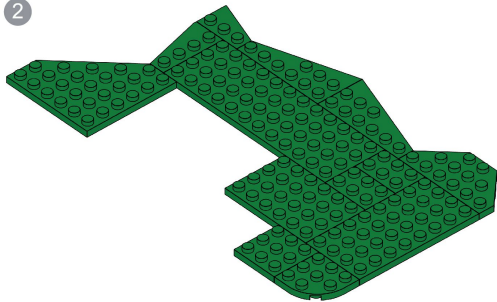

=3=

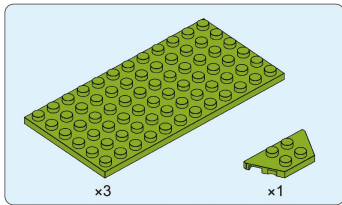

3

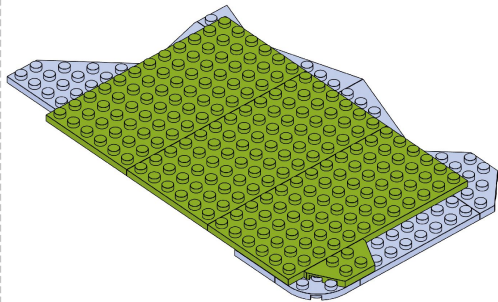

4

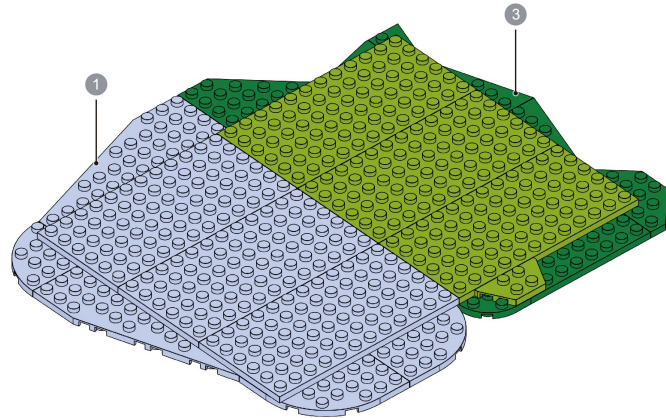

=4=

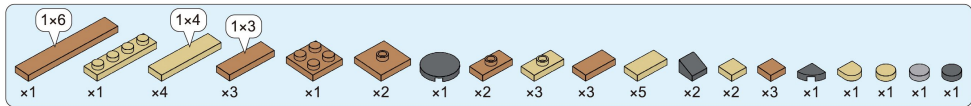

5

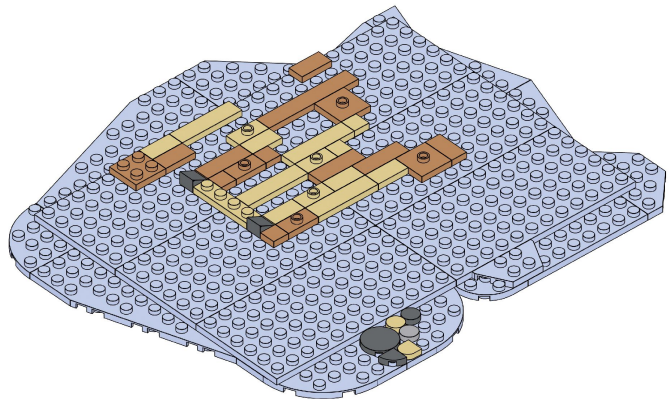

=5=

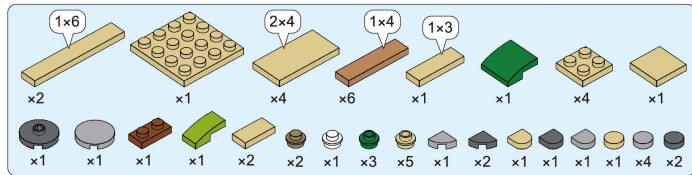

6

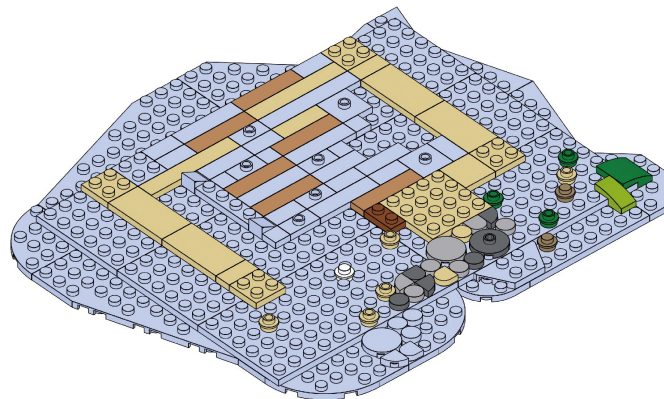

=6=



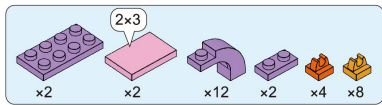

11

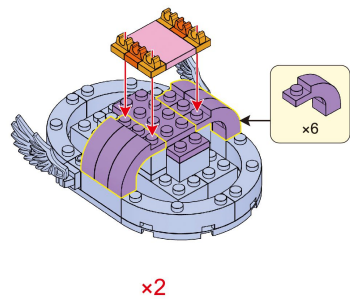

=9=

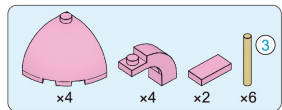

12

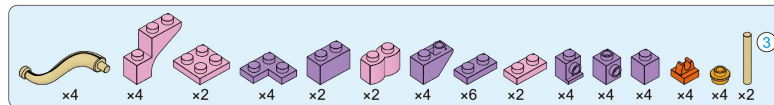
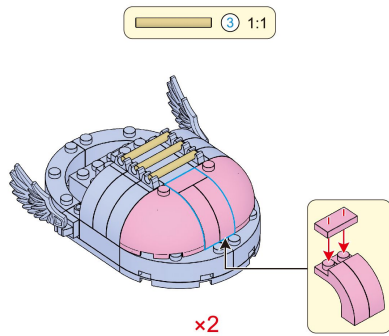

13

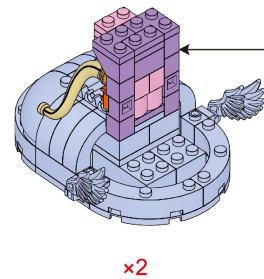

=10=

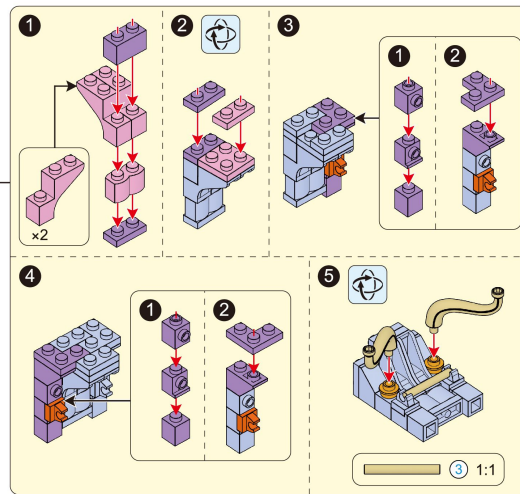

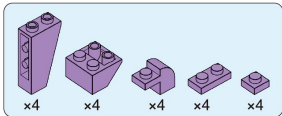

14

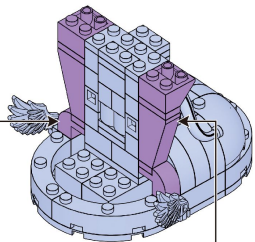

x2

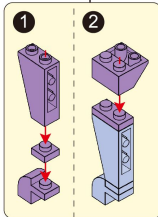

2

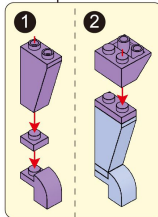
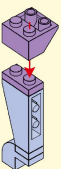

2

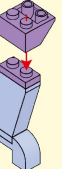

=11=

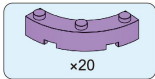

x20

15

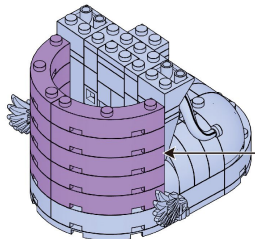

x2

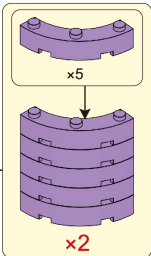

x5

x2

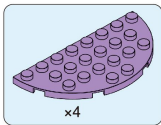

x4

16

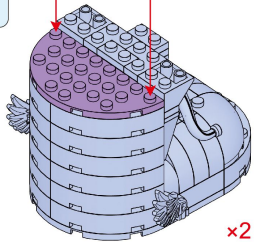
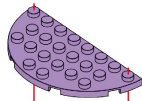

x2

17

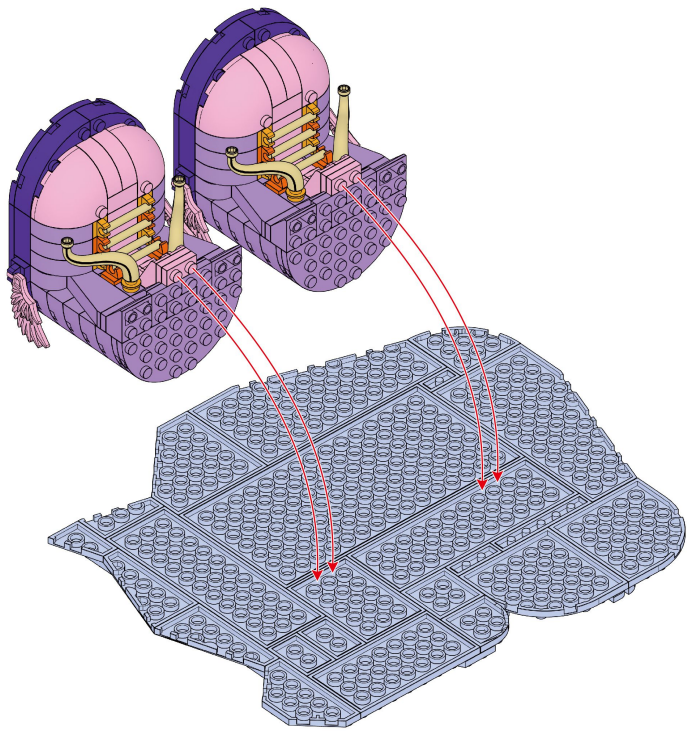

=12=

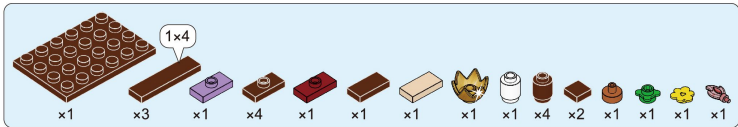

18

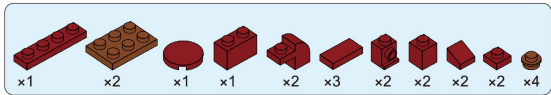
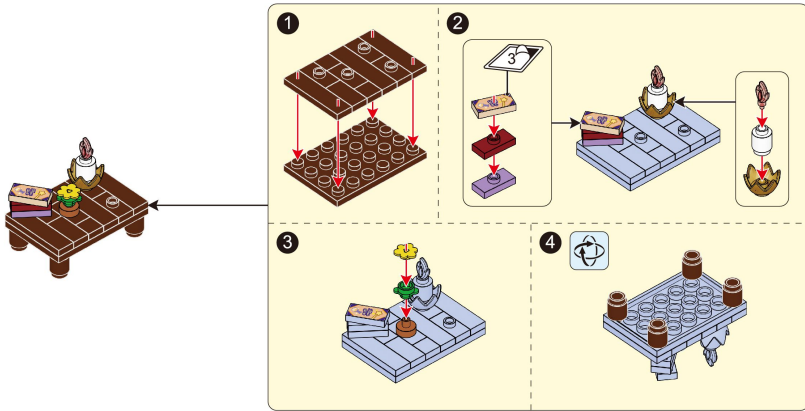

19

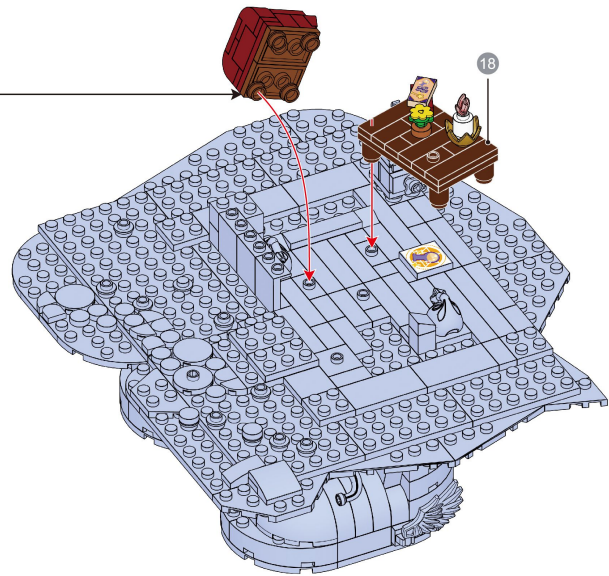
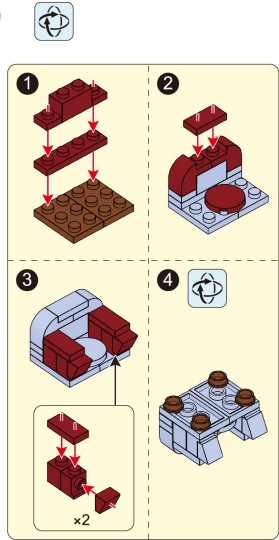

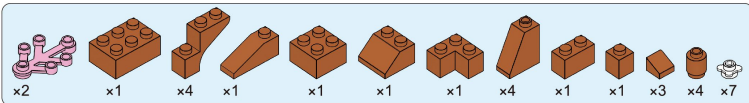

20

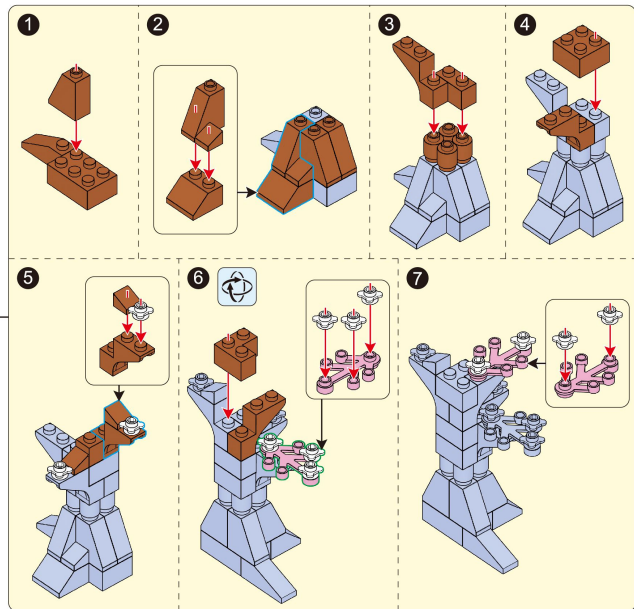
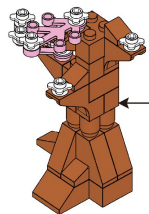

=15=

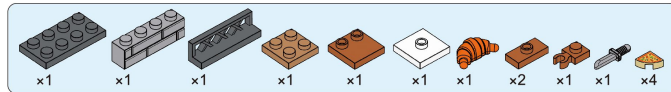

21

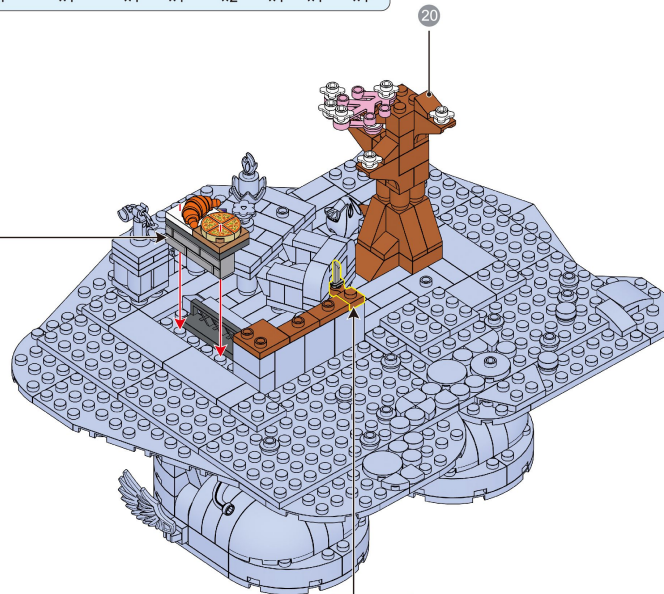
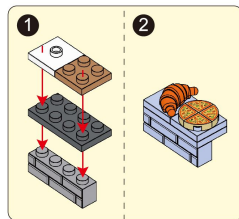

=16=



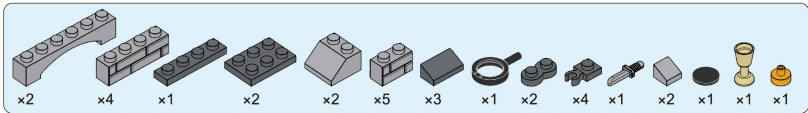

22

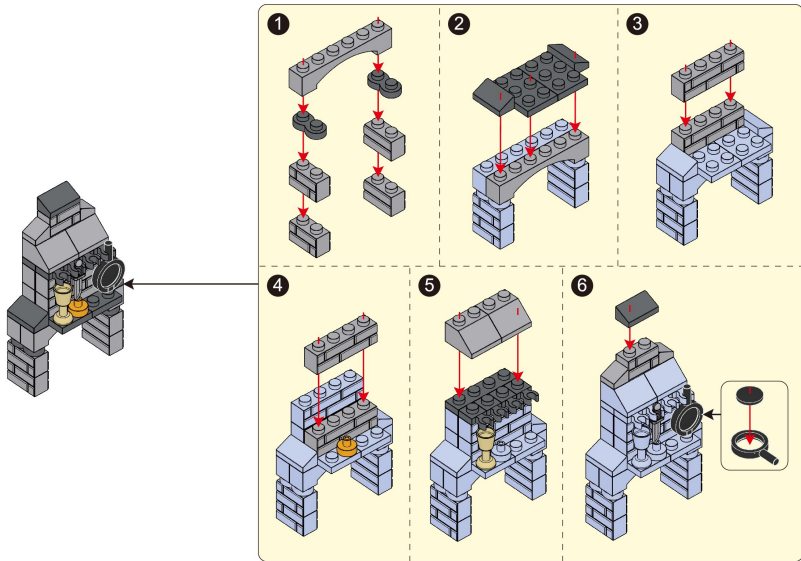

=17=

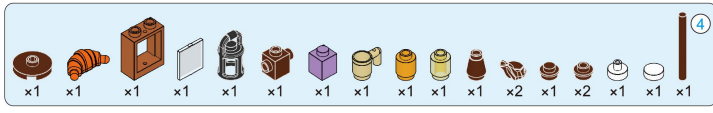

23

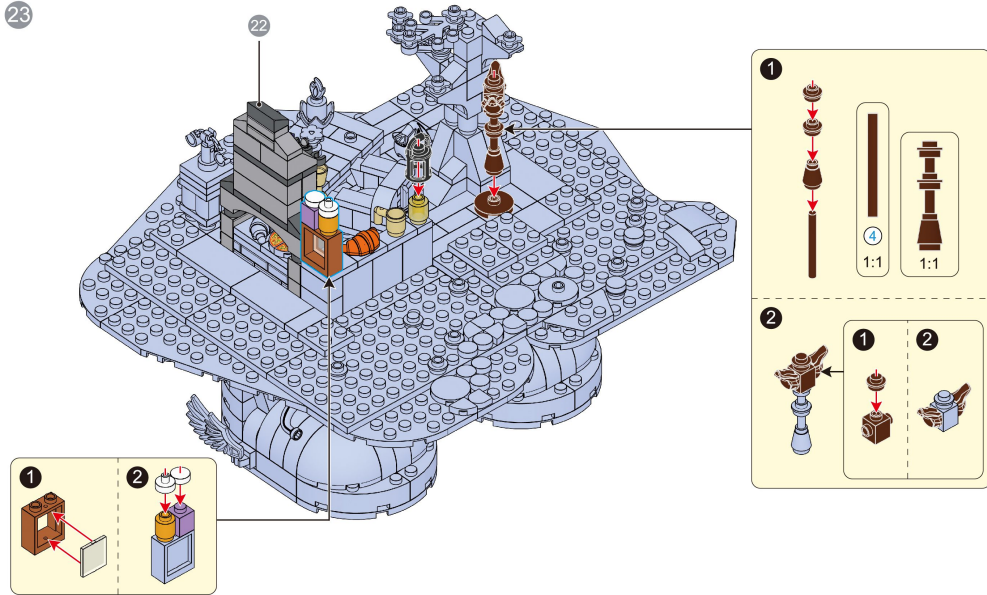

=18=

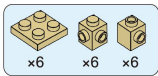

24

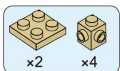
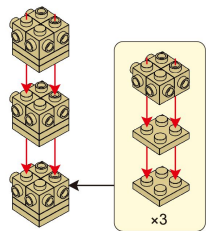

25

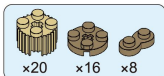
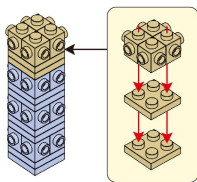

26

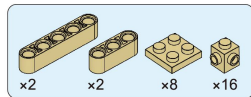
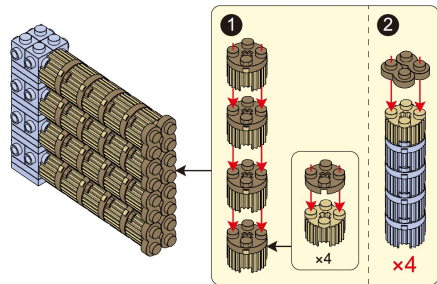

27

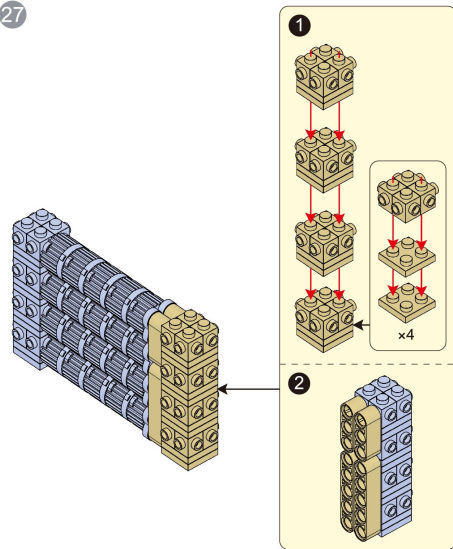

28

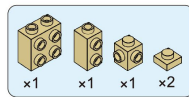
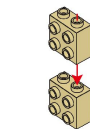

29

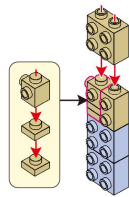

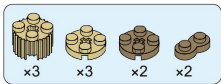

30

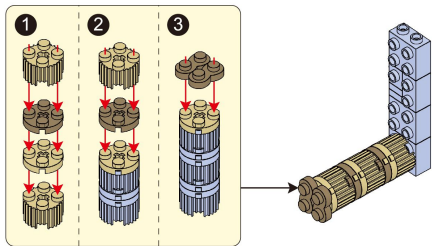

=21=

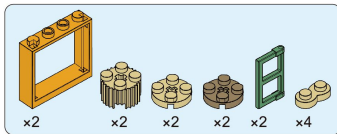

31

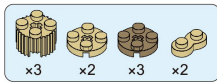
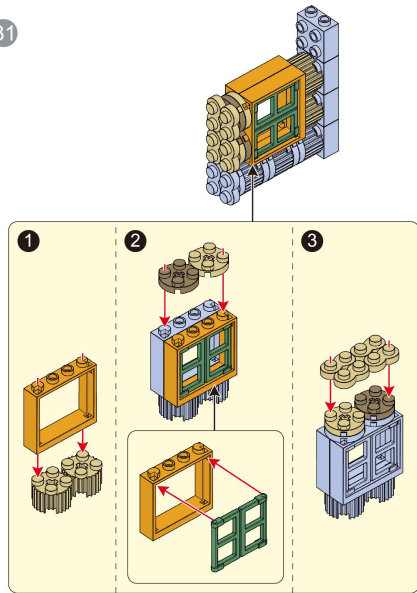

32

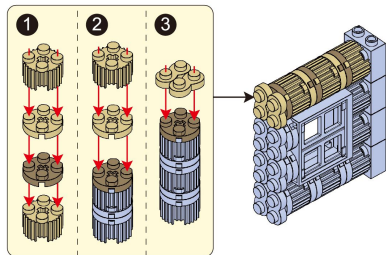

=22=

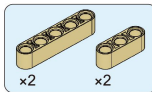

33

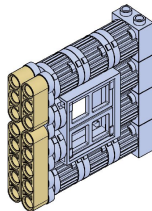

34

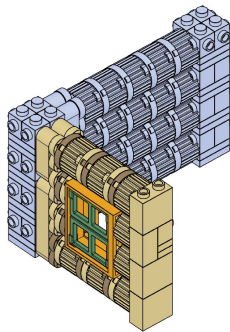

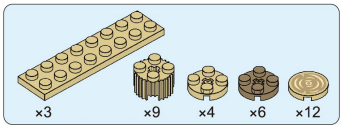

35

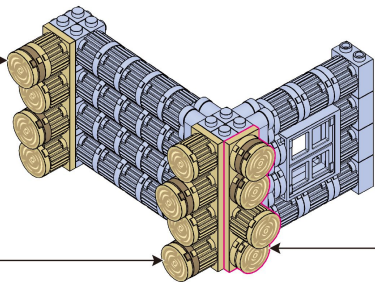
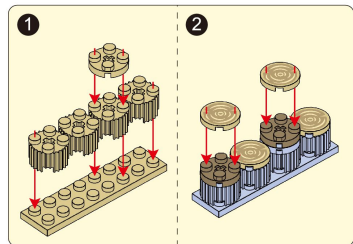
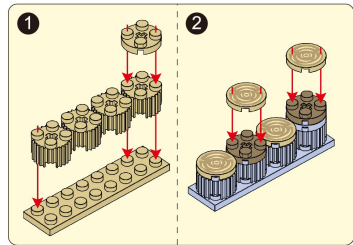

=23=

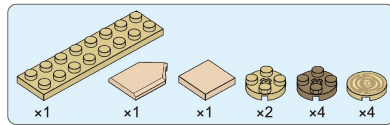
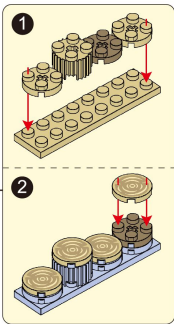

36

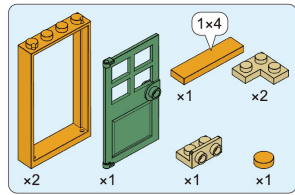
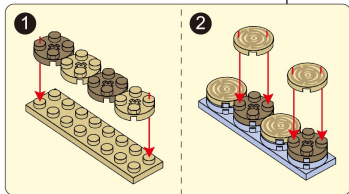
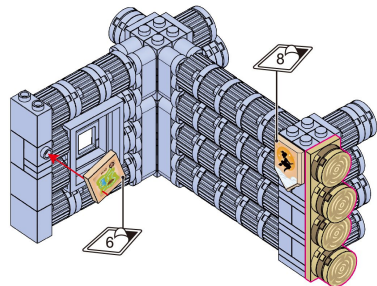

37

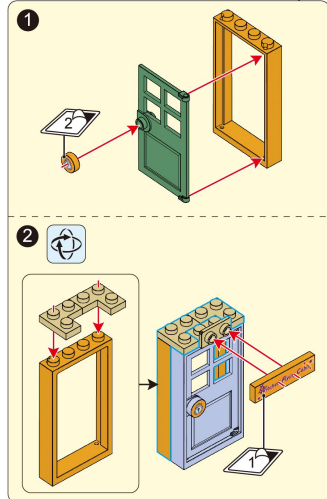

=24=

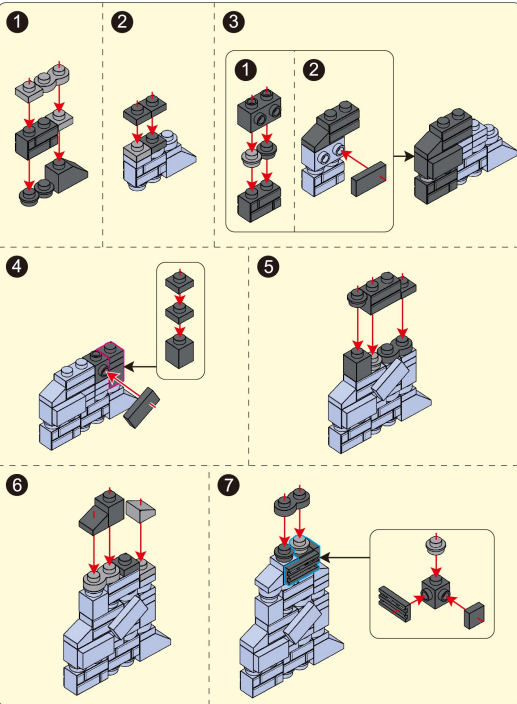
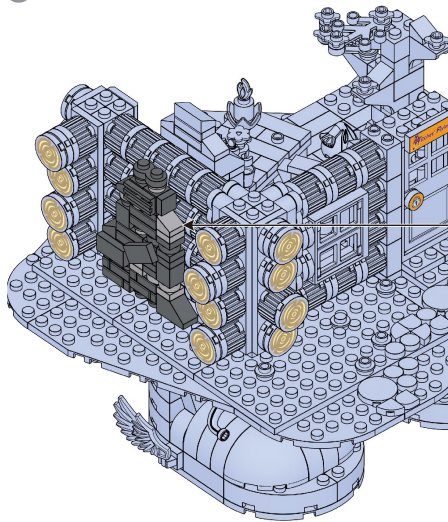
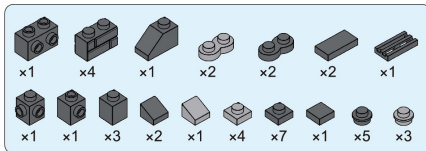
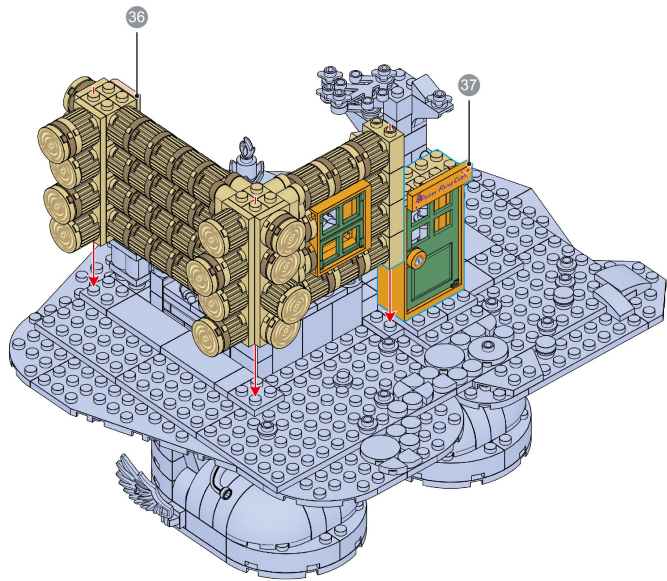

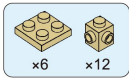

40

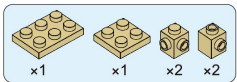
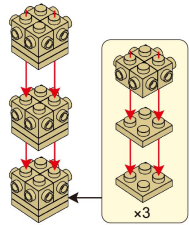

41

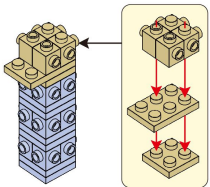

=27=

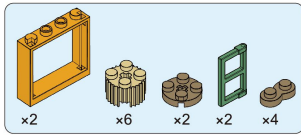

42

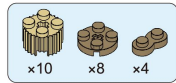
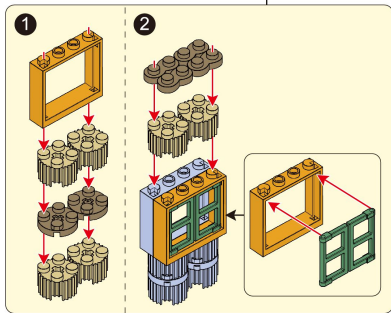
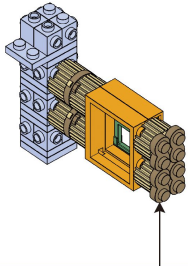

43

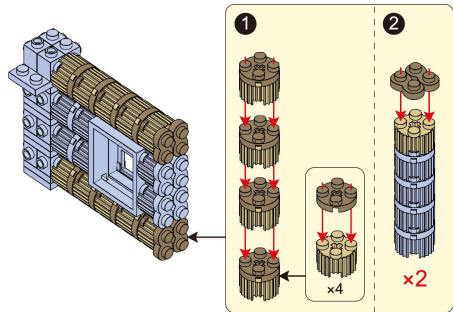

=28=

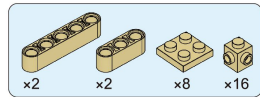

44

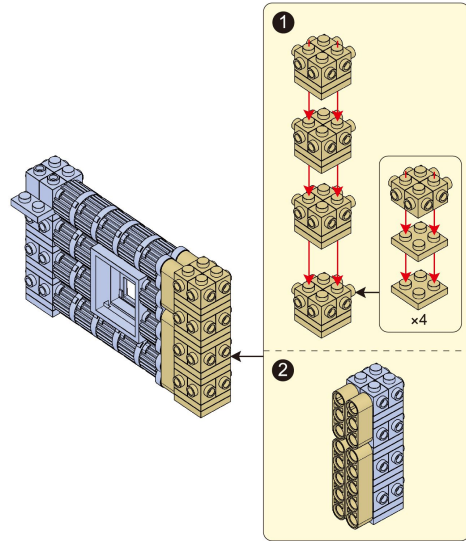

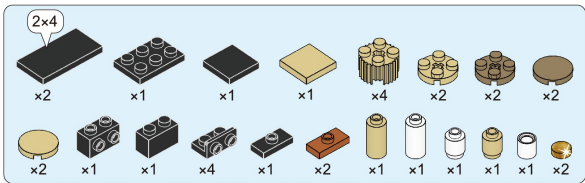

45

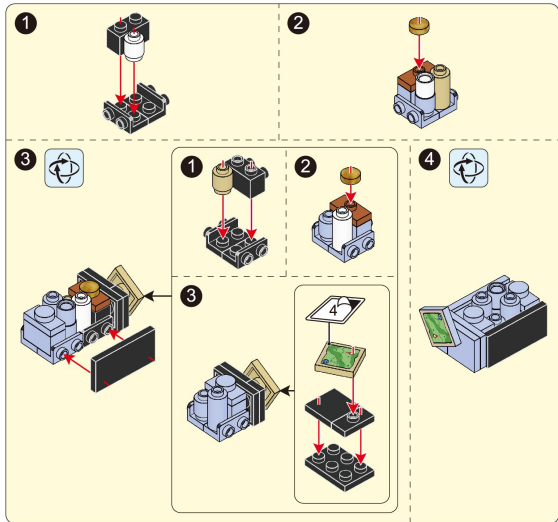

=29=

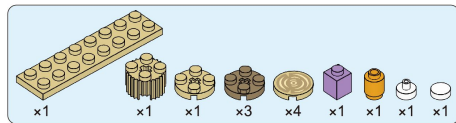
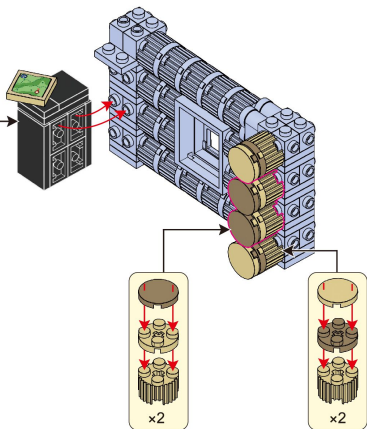

46

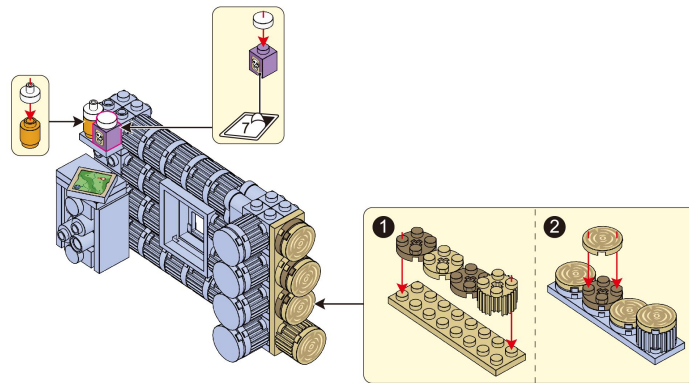

=30=

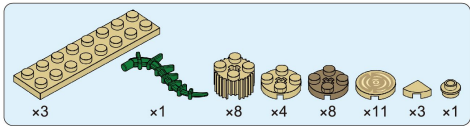

47

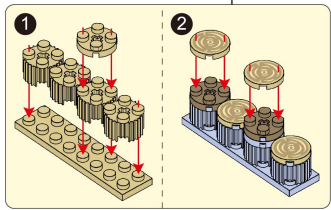
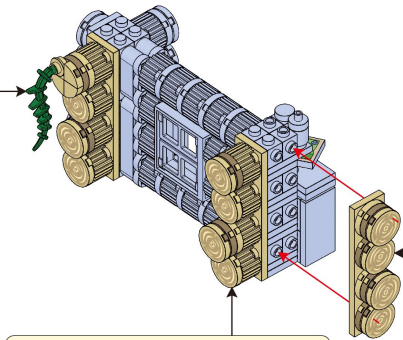
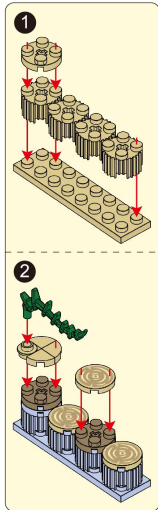

=31=

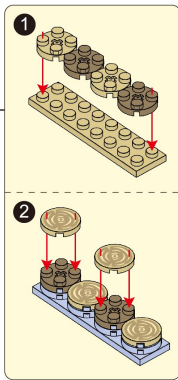

48

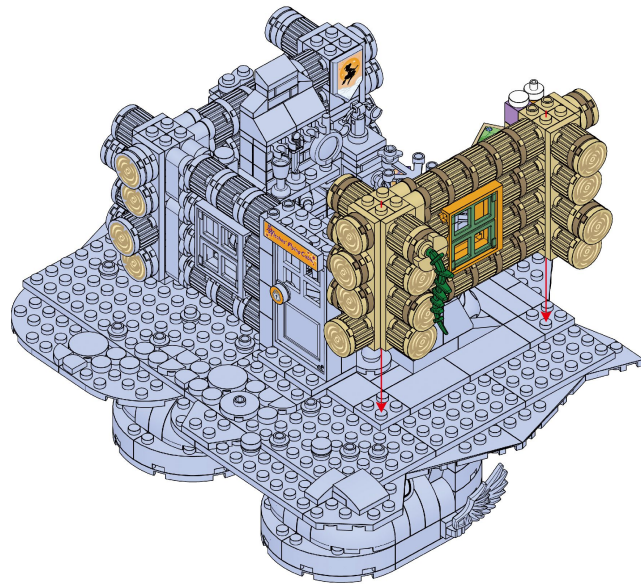

=32=



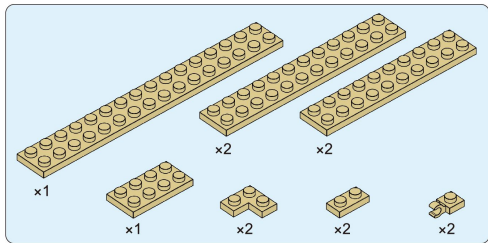

49

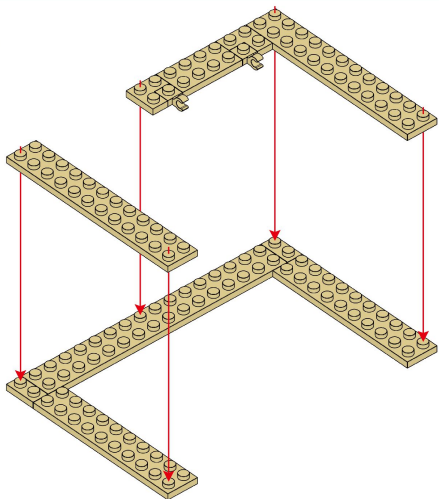

=33=

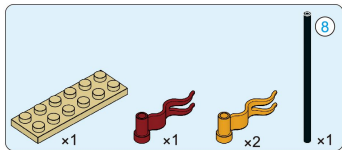

50

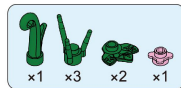
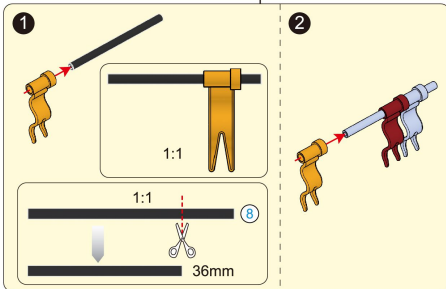
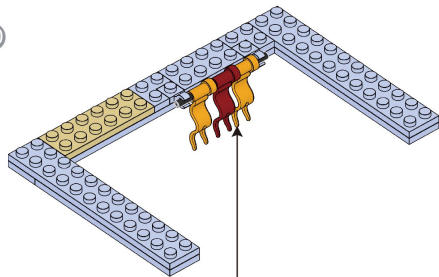

51

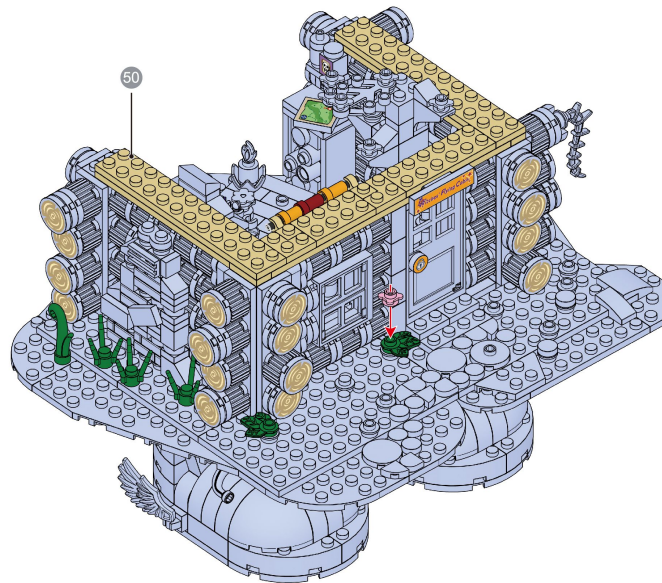

=34=

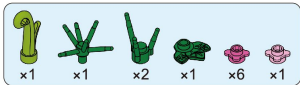

52

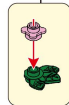
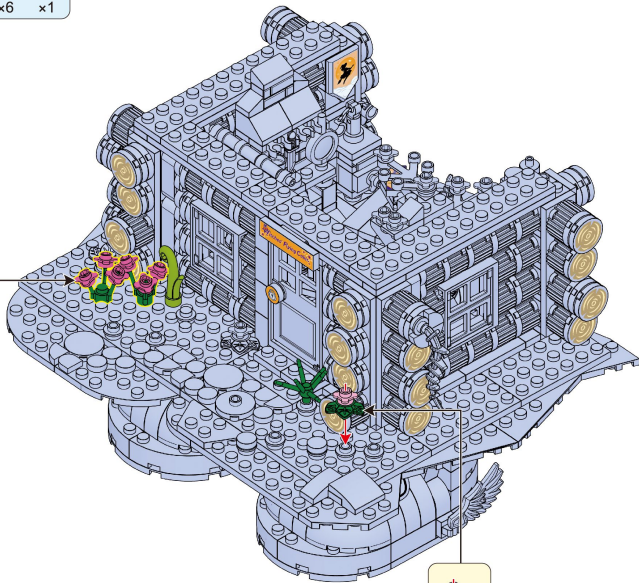
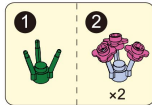

=35=

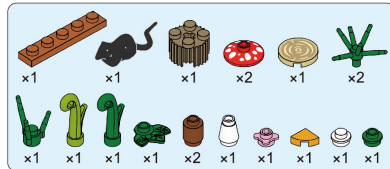

53

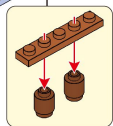
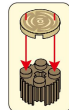
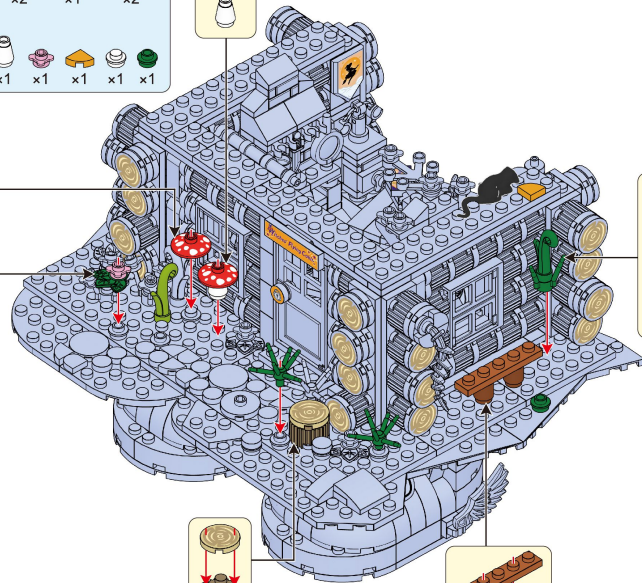
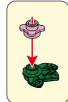

=36=

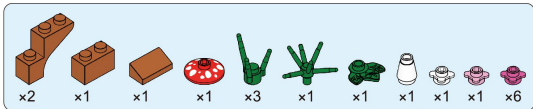

54

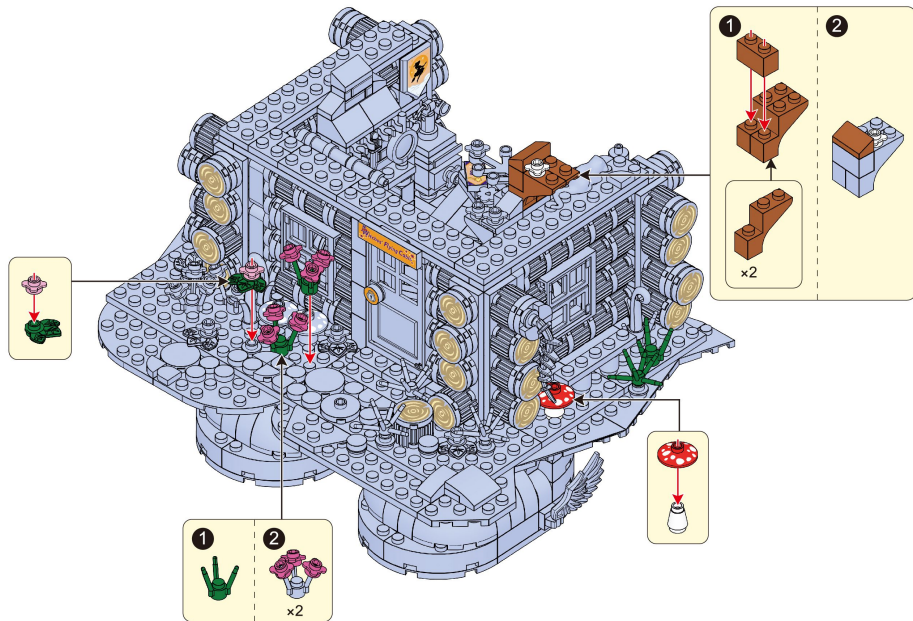

=37=

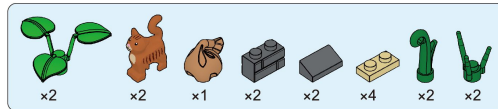

55

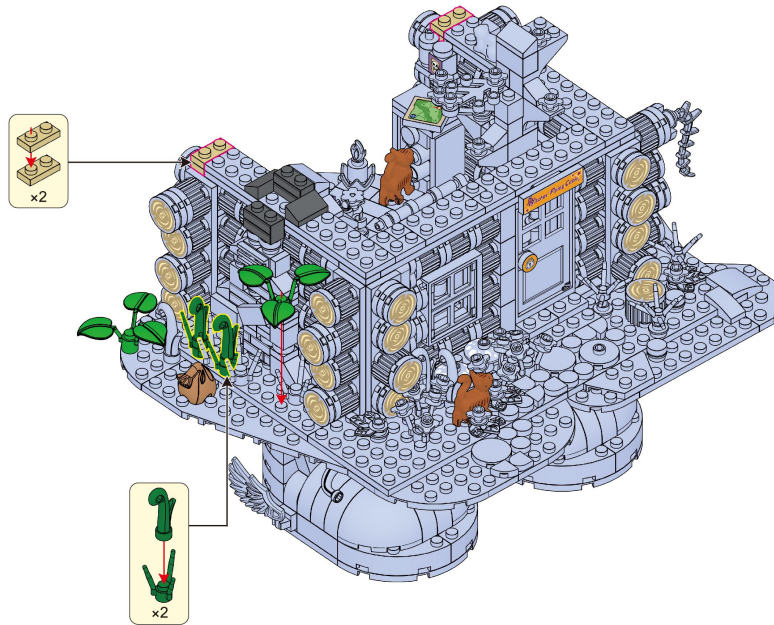

=38=



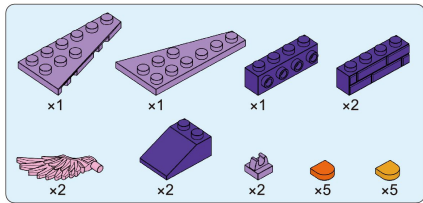

58

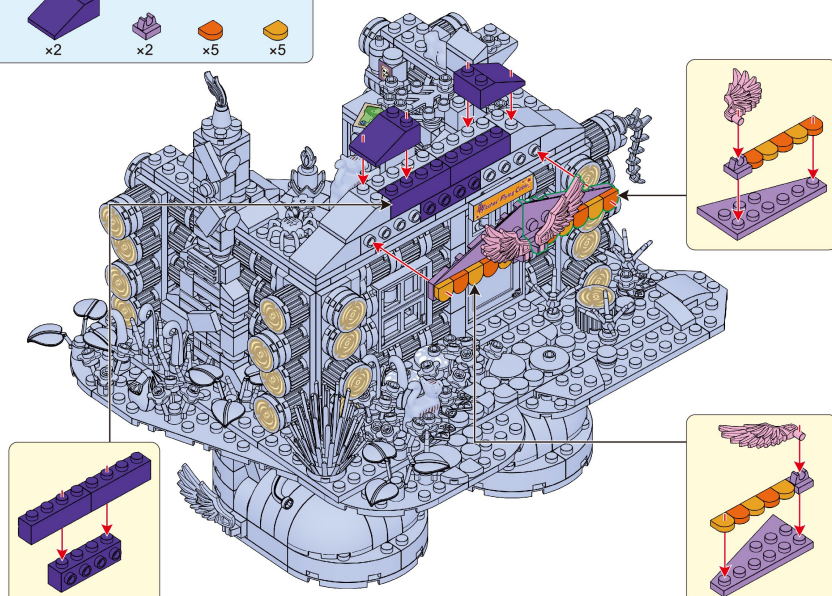

=41=

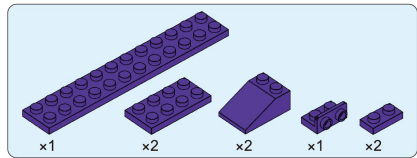

59

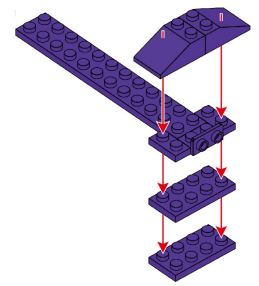

=42=

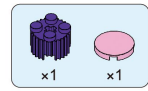

60

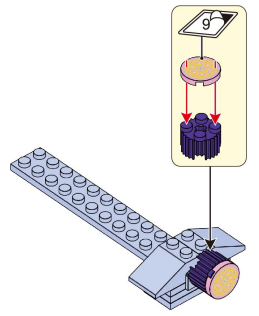

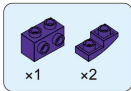

61

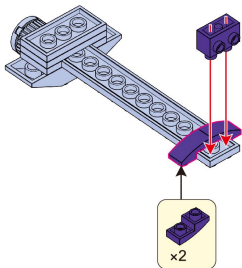

=43=



62

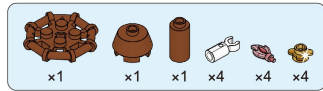
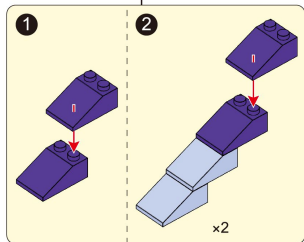
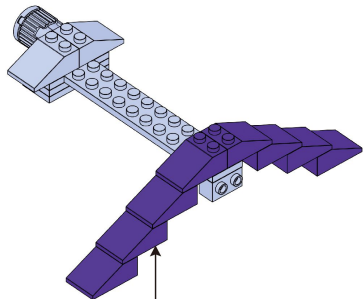

63

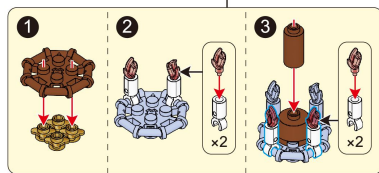
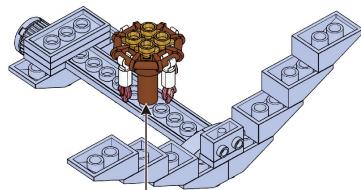

=44=

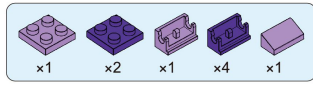

64

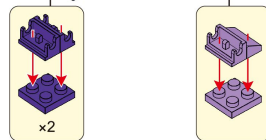
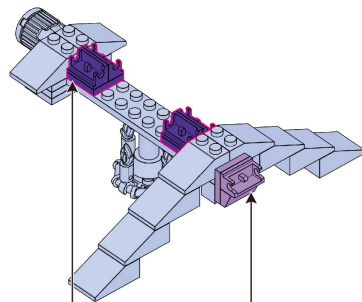

65

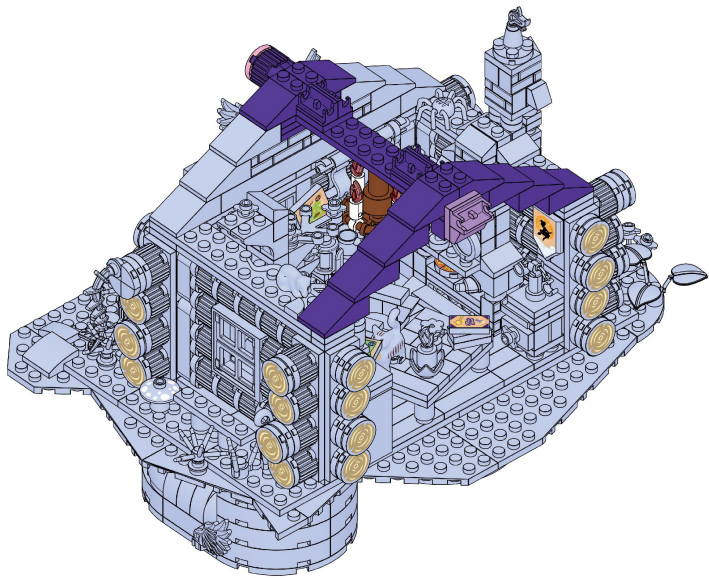

=45=

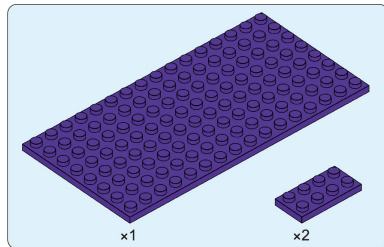

66

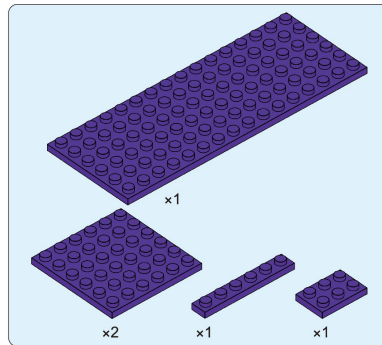
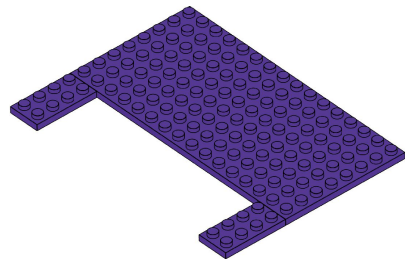

67

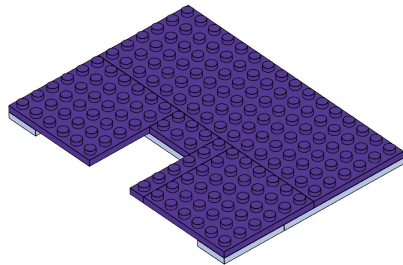

=46=

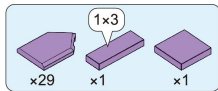

68

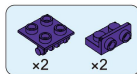
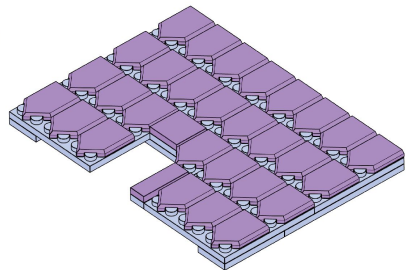

69

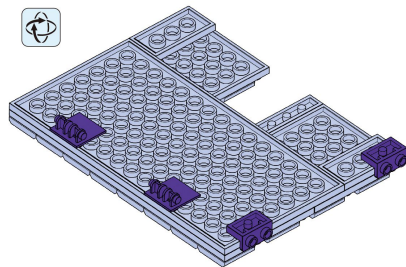

=47=

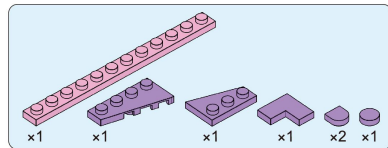

70

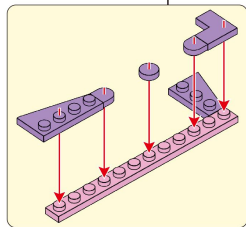
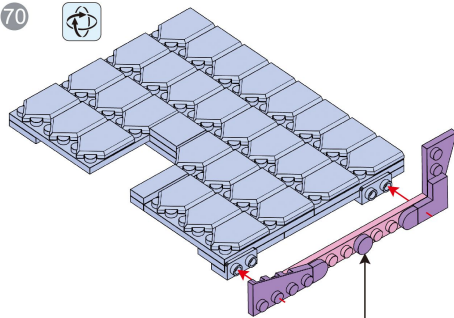

71

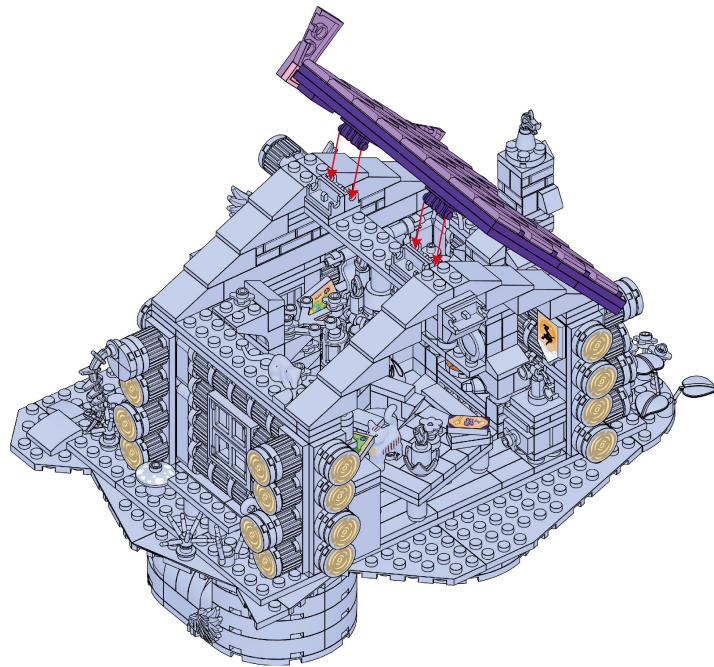

=48=



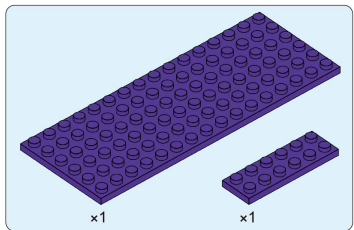

72

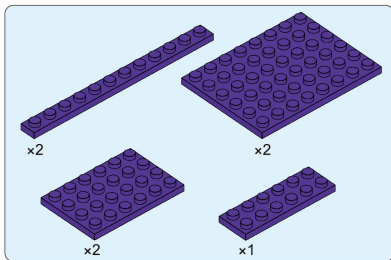
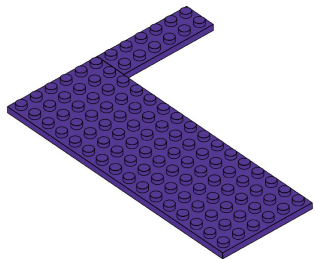

73

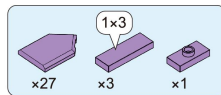
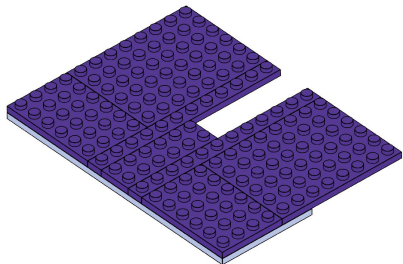

74

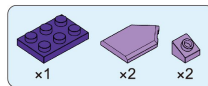
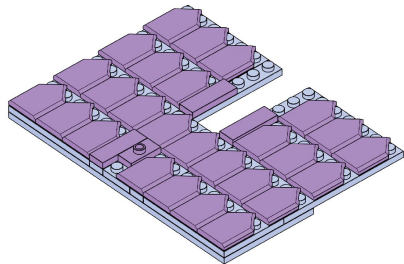

75

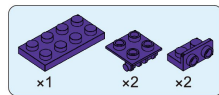
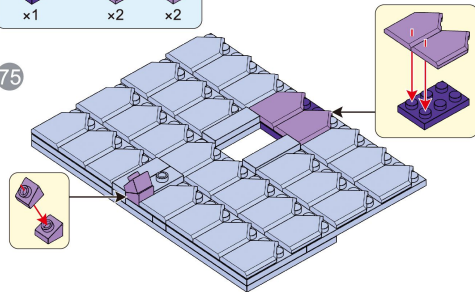

76

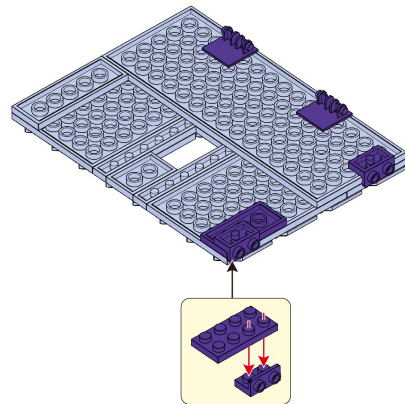

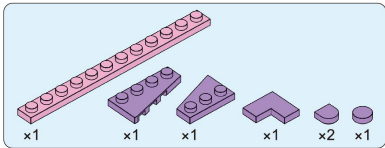

77

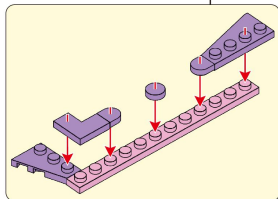
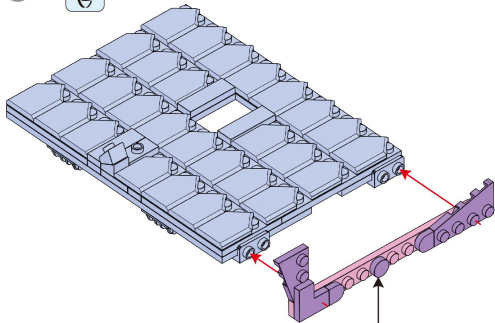

=51=

78

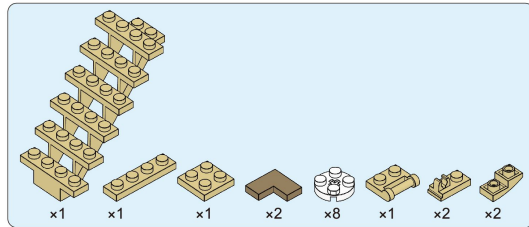
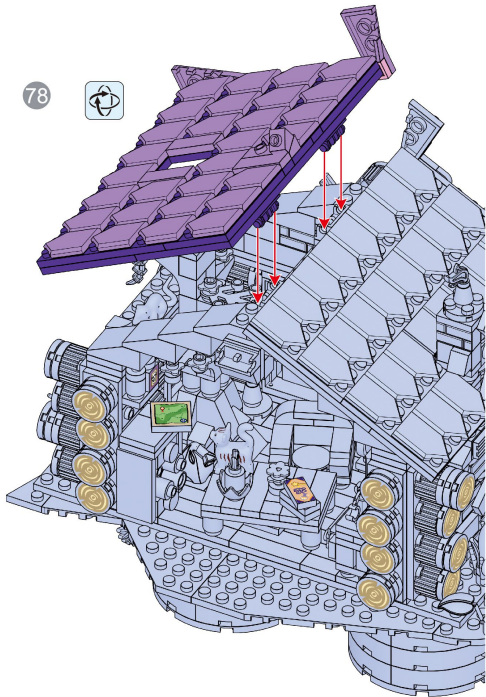

79

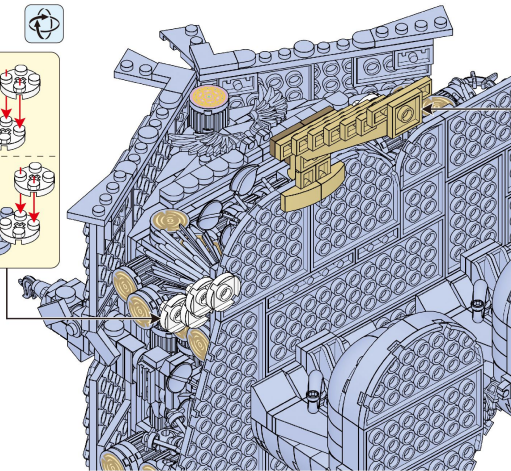
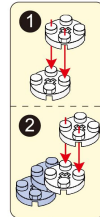

=52=

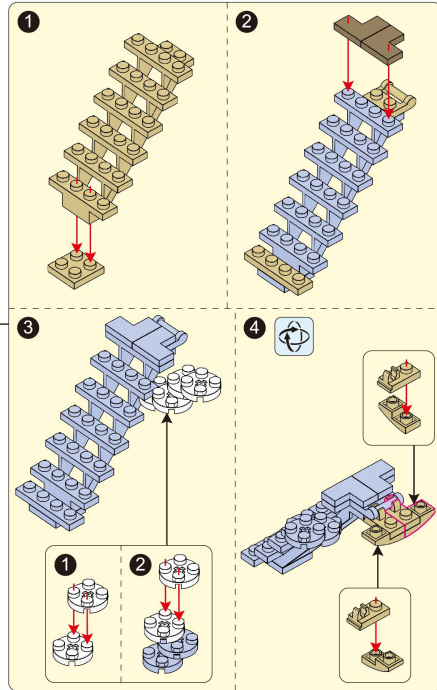

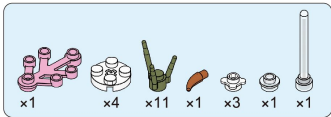

80

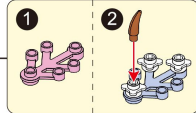
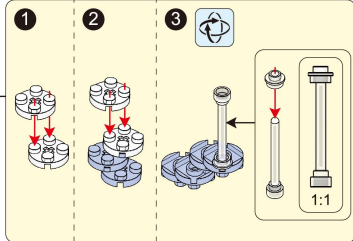
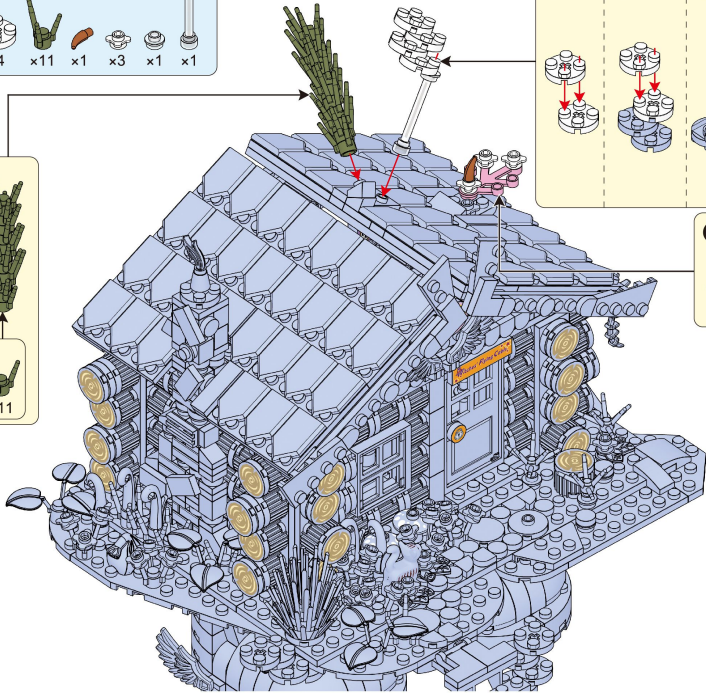
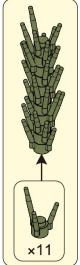

=53=

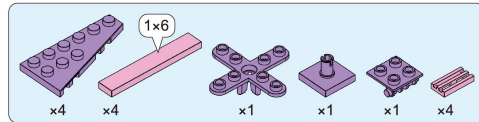

81

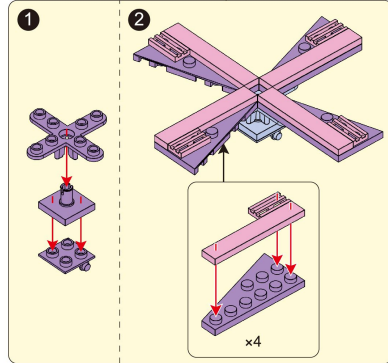
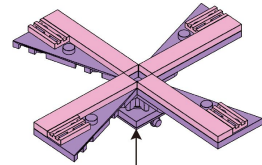

=54=

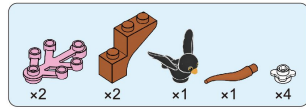

82

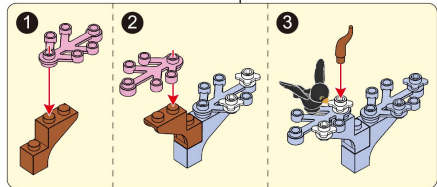
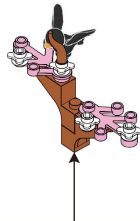

83

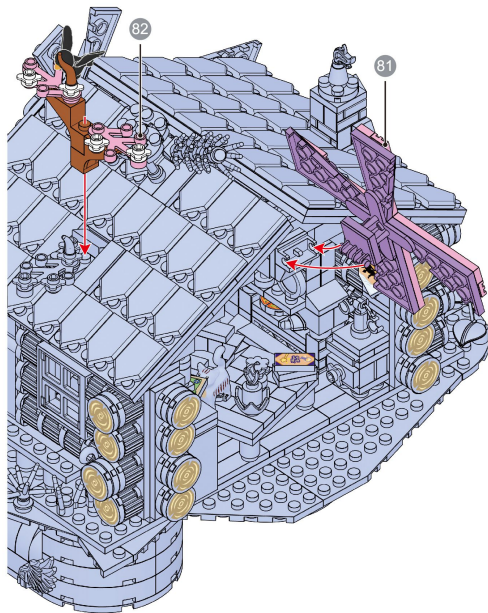

=55=

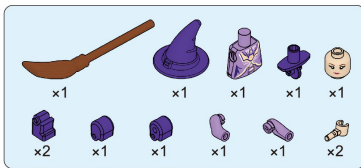

84

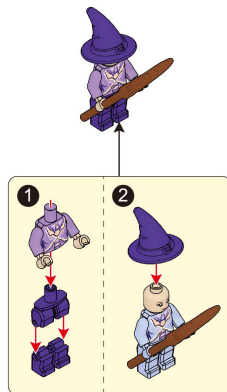

85



=56=

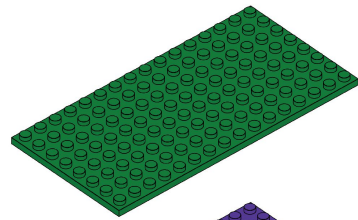

x1

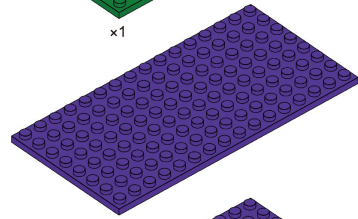

x1

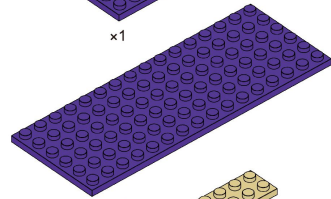

x2

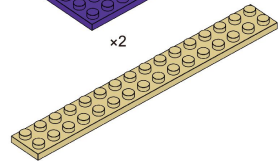

x1

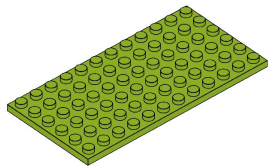

x6

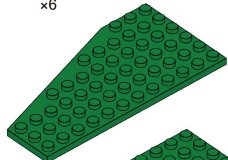

x2

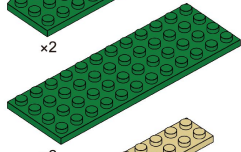

x2

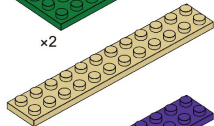

x2

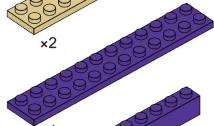

x1

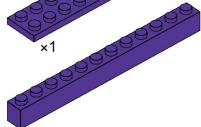

x1

=57=

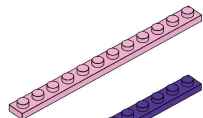

x2

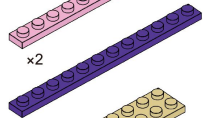

x2

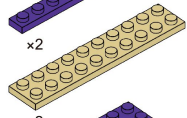

x2

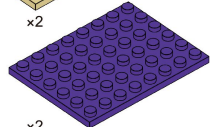

x2

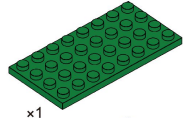

x1

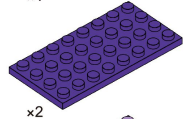

x2

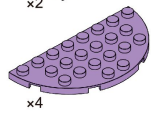

x4

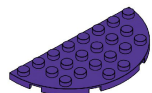

x4

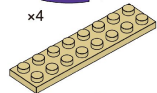

x8

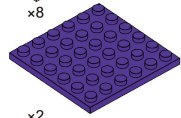

x2

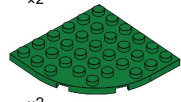

x2

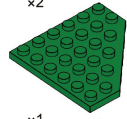

x1

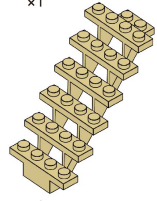

x1



x1

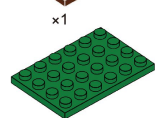

x1

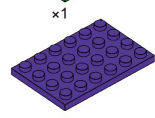

x2

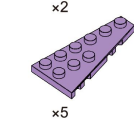

x5

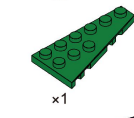

x1

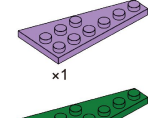

x1



x1

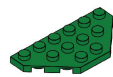

x1

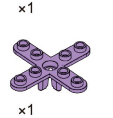

x1

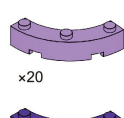

x8

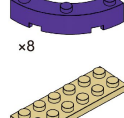

x1

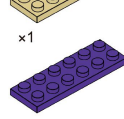

x2

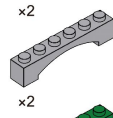

x2

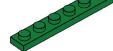

x1

=58=

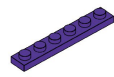

x1

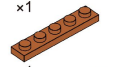

x1

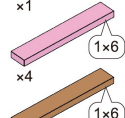

1x6



x4



1x6



x2

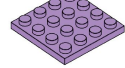

x1

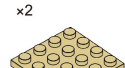

x2

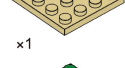

x1



x1



x3



x1

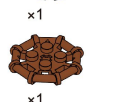

x1



x1

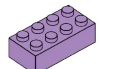

x12



x6



x5



x2

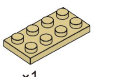

x1

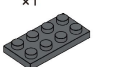

x1

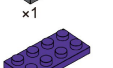

x5



x2



2x4

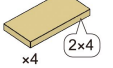

2x4

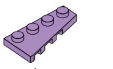

x1

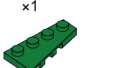

x1

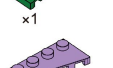

x1



x1

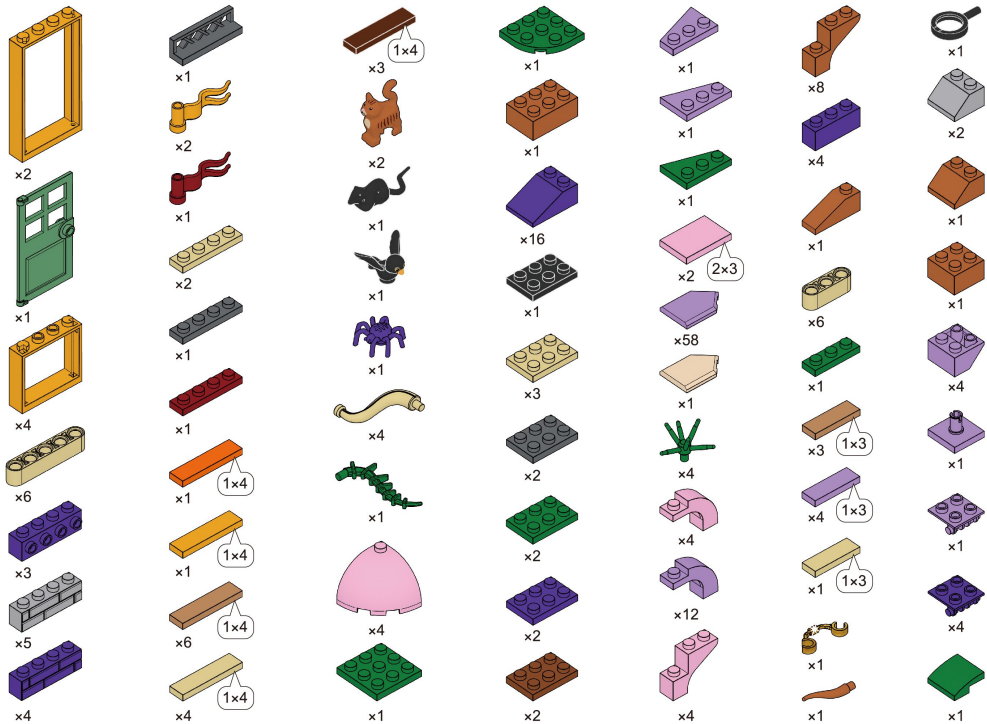

=59=



=60=



=61=

