

CALL OF DUTY

COLLECTOR CONSTRUCTION SETS

HOVERCRAFT
AÉROGLISSEUR

06859

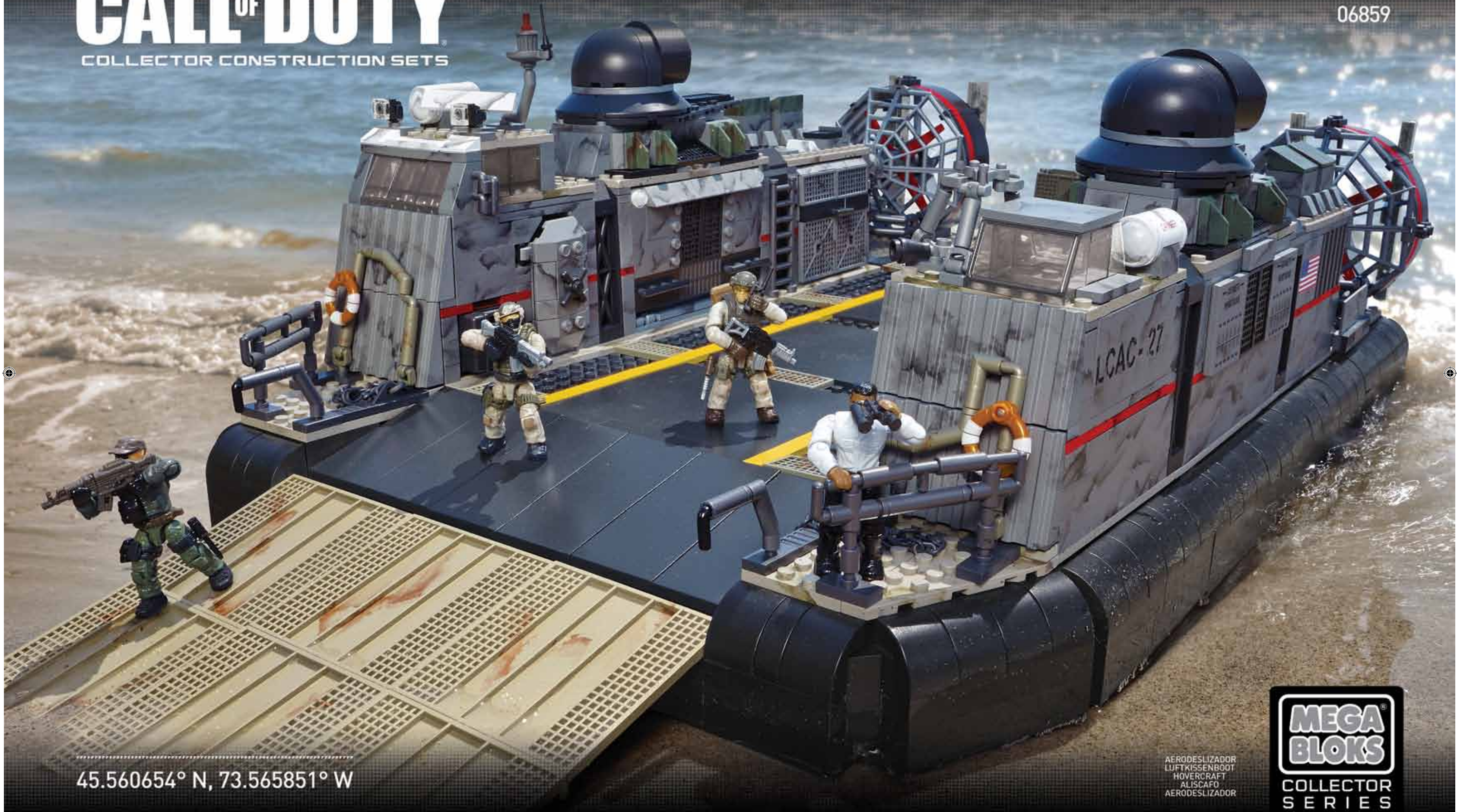

45.560654° N, 73.565851° W

AERODESLIZADOR
LUFTKISSENBOOT
HOVERCRAFT
ALISCAFO
AERODESLIZADOR



LCAC HOVERCRAFT

Conflicts arise in some of the most difficult and remote terrains. A military hovercraft is an amphibious vessel that can venture where no other boat or vehicle can go. It is uniquely equipped to travel across water, mud or even land. The hovercraft features two massive fans that create pressurized air that causes the vehicle to lift and float above the surface. At high speed, the vehicle does not leave a wake, therefore, making it stealth and difficult to detect during the night. It features a large platform hull that's used to deliver troops, equipment and supplies. The vessel functions as an ideal surveillance platform and mobile command post.

AERODESLIZADOR LCAC

Los conflictos pueden surgir en lugares difíciles y remotos. Un aerodeslizador militar es una nave anfibia que puede aventurarse donde ningún otro bote o vehículo haya pasado gracias a su equipamiento único para viajar por agua, barro o tierra. El aerodeslizador presenta dos ventiladores masivos que generan aire a presión, lo que hace que el vehículo se eleve y flote por encima de la superficie. A pesar de las grandes velocidades que alcanza, el vehículo no deja estela alguna, para que permanezca oculto y difícil de detectar por la noche. Presenta un amplia plataforma usada para el envío de tropas, equipos y materiales. El navío funciona asimismo como un ideal punto de vigilancia y puesto de mando móvil.

AÉROGLISSEUR LCAC

Les conflits ont lieu sur des terrains souvent difficiles et éloignés. Un aéroglisseur militaire est un véhicule amphibie qui peut s'aventurer là où aucun autre bateau ou véhicule ne peut se rendre. Il est équipé afin de pouvoir voyager autant sur l'eau que dans la boue ou sur la terre ferme. Cet aéroglisseur est muni de deux énormes ventilateurs qui créent de l'air sous pression, de manière à soulever le véhicule, qui flotte alors au-dessus de la surface. À haute vitesse, il ne laisse aucun sillage, ce qui en fait un véhicule furtif difficile à détecter pendant la nuit. Il comporte une large plateforme à coque qui sert à transporter des troupes, de l'équipement et des fournitures. Ce véhicule constitue une plateforme de surveillance idéale et est parfait comme poste de commandé mobile.

LCAC-LUFTKISSENBOOT

Konflikte werden manchmal an schwierigen und abgelegenen Stellen ausgetragen. Ein militärisches Luftkissenboot ist ein amphibisches Gefährt, das Stellen erreicht, die für andere Boote oder Fahrzeuge unzugänglich sind. Es kann sich dabei über Wasser, Schlamm und sogar Land bewegen. Das Luftkissenboot verfügt über zwei starke Ventilatoren, die Druckluft erzeugen, es anheben und über der Oberfläche schweben lassen. Bei hohen Geschwindigkeiten erzeugt das Gefährt kein Kielwasser und ist daher nachts praktisch unsichtbar. Es verfügt über eine große Plattform für Truppen, Gerät und Nachschub. Es ist ideal als Überwachungsplattform und mobiler Kommandostand geeignet.

LCAC-HOVERCRAFT

Soms ontstaan conflicten in de meest ontoegankelijke en afgelegen gebieden. Een militair luchtkussen voertuig is een amfibievoertuig dat op plaatsen kan worden ingezet waar andere boten of voertuigen niet kunnen komen. Door zijn unieke ontwerp kan het zich voortbewegen over water, in drassig gebied en zelfs over land. Het luchtkussen voertuig heeft twee grote propellers die een soort luchtkussen onder het voertuig creëren, waardoor het omhoogkomt en boven het oppervlak zweeft. Het voertuig laat bij hoge snelheid geen sporen achter, waardoor het zich 's nachts onopvallend kan voortbewegen en moeilijk te traceren is. Het heeft een groot platform voor het vervoer van troepen, apparatuur en voorraden. Het voertuig is ideaal als bewakingsplatform en als mobiele commandopost.

AEROSCAFO LCAC

I conflitti possono sorgere nei terreni più difficili e remoti. Un aliscafo militare è una nave anfibia che può avventurarsi dove nessun'altra imbarcazione o veicolo potrebbe, poiché equipaggiato in maniera unica per viaggiare su acqua, fango e terra. L'aliscafo presenta due ventole imponenti che creano aria pressurizzata, la quale consente al veicolo di sollevarsi e galleggiare sulla superficie. Ad alta velocità il veicolo non lascia alcuna scia, rendendolo poco visibile e difficile da individuare durante la notte. Dispone di un ampio scafo a piattaforma utilizzato per trasportare truppe, equipaggiamenti e dotazioni. Il veicolo funge inoltre da punto di sorveglianza e postazione di comando mobile.

AERODESLIZADOR LCAC

Conflitos surgem em alguns dos terrenos mais difíceis e remotos. Um aerodeslizador militar é um navio anfíbio que pode se aventurar onde nenhum outro barco ou veículo pode ir. Ele é especialmente equipado para viajar através da água, lodo ou até terra. O aerodeslizador apresenta dois massivos ventiladores que criam o ar pressurizado para que o veículo possa se levantar e flutuar sobre a superfície. Em alta velocidade, o veículo não deixa rastro, o que o torna furtivo e difícil de detectar durante a noite. Possui uma grande casco plataforma que é usado para fornecer tropas, equipamentos e suprimentos. A embarcação funciona como uma plataforma de vigilância ideal e um posto de comando móvel.



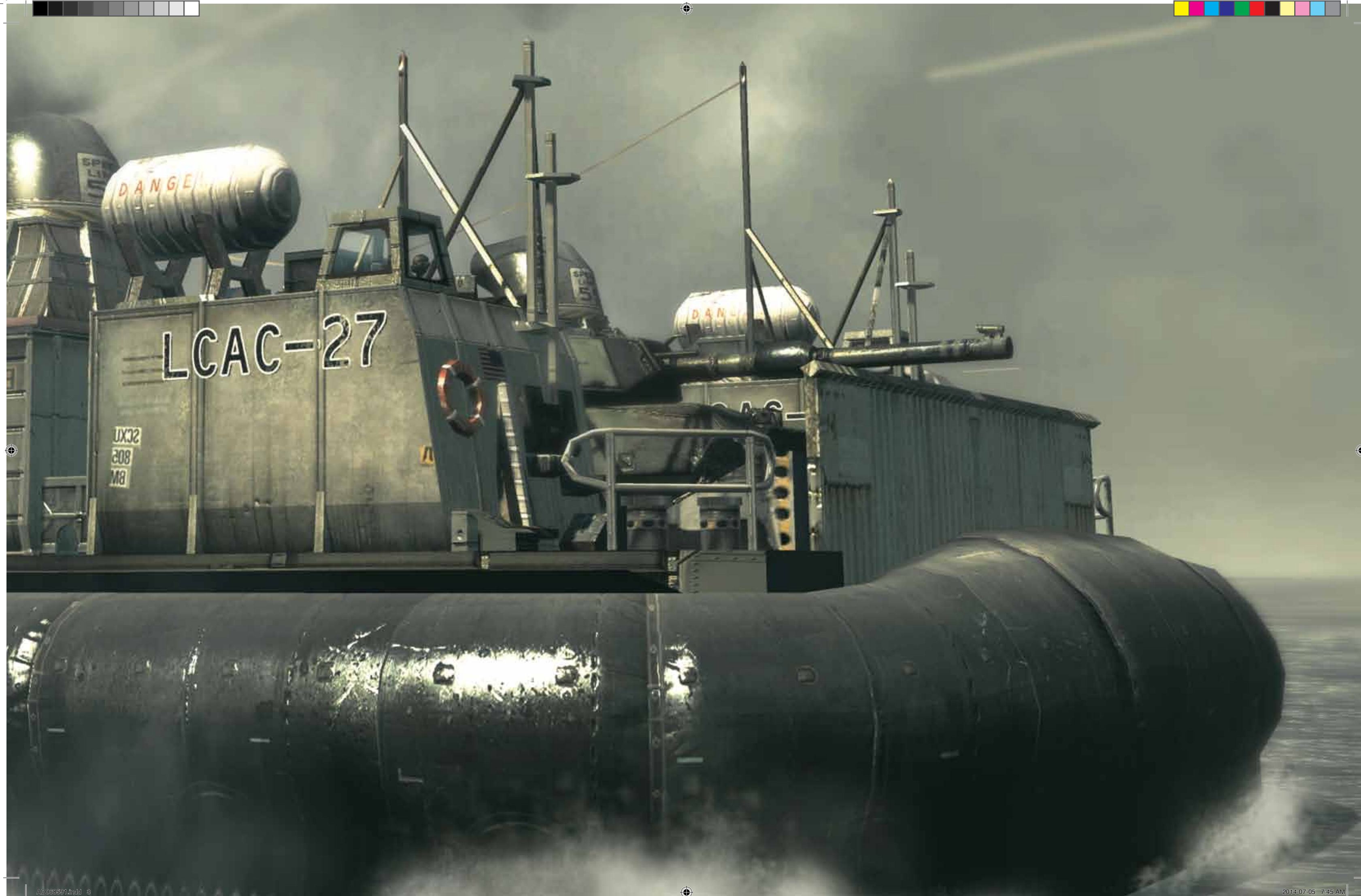





LCAC-2745138 

1

Section • Sección • Section
Abschnitt • Sectie • Sezione • Secção

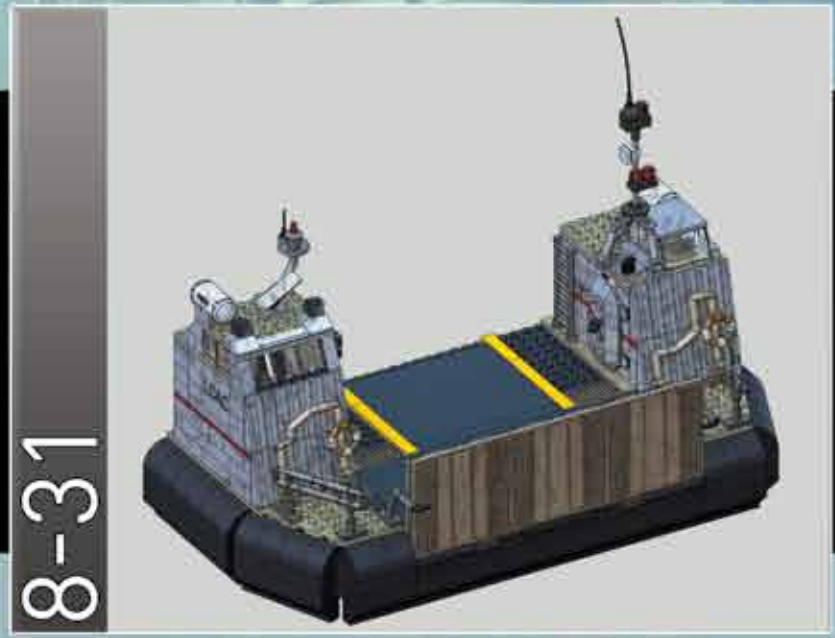

1

Section • Sección • Section
Abschnitt • Sectie • Sezione • Secção

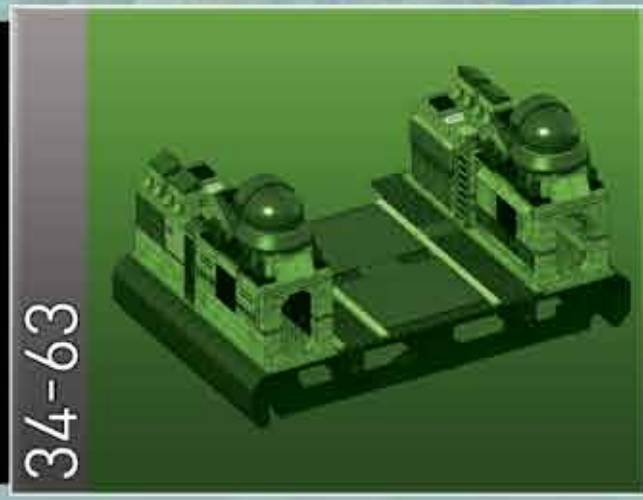

2

Section • Sección • Section
Abschnitt • Sectie • Sezione • Secção

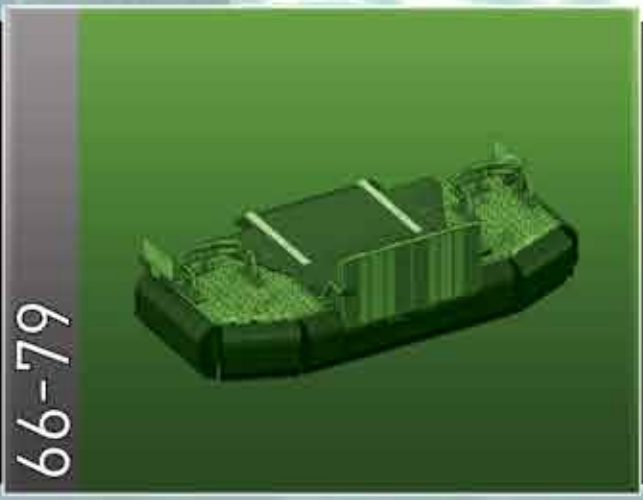

3

Section • Sección • Section
Abschnitt • Sectie • Sezione • Secção



4

Section • Sección • Section
Abschnitt • Sectie • Sezione • Secção



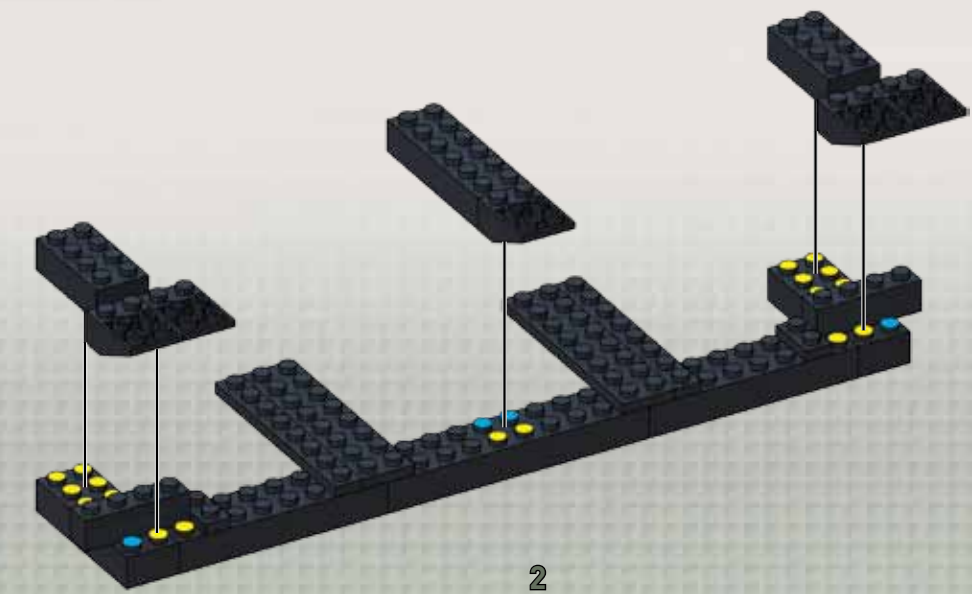
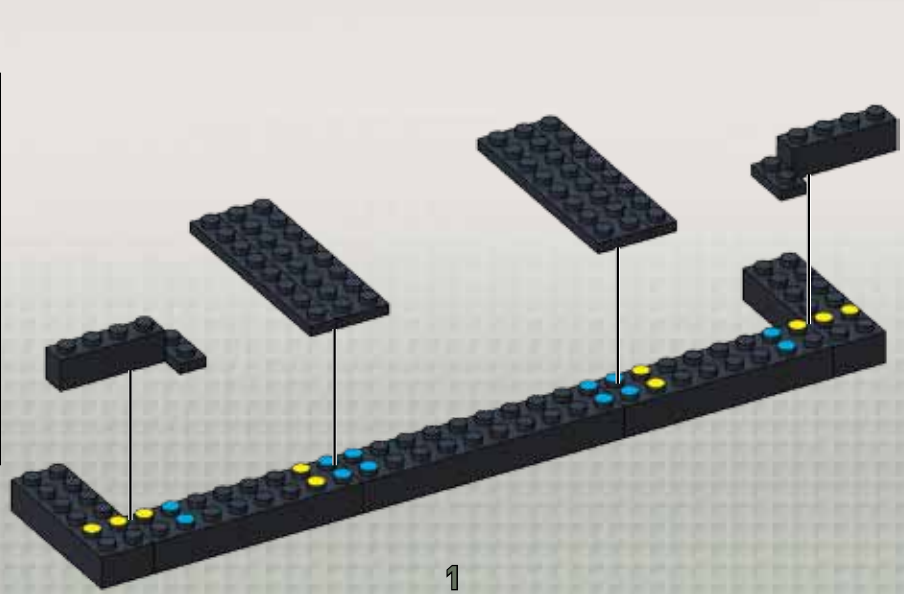
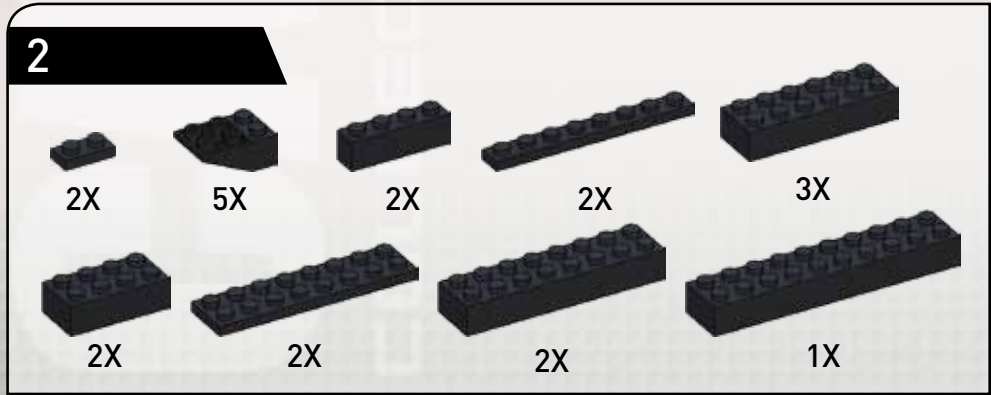
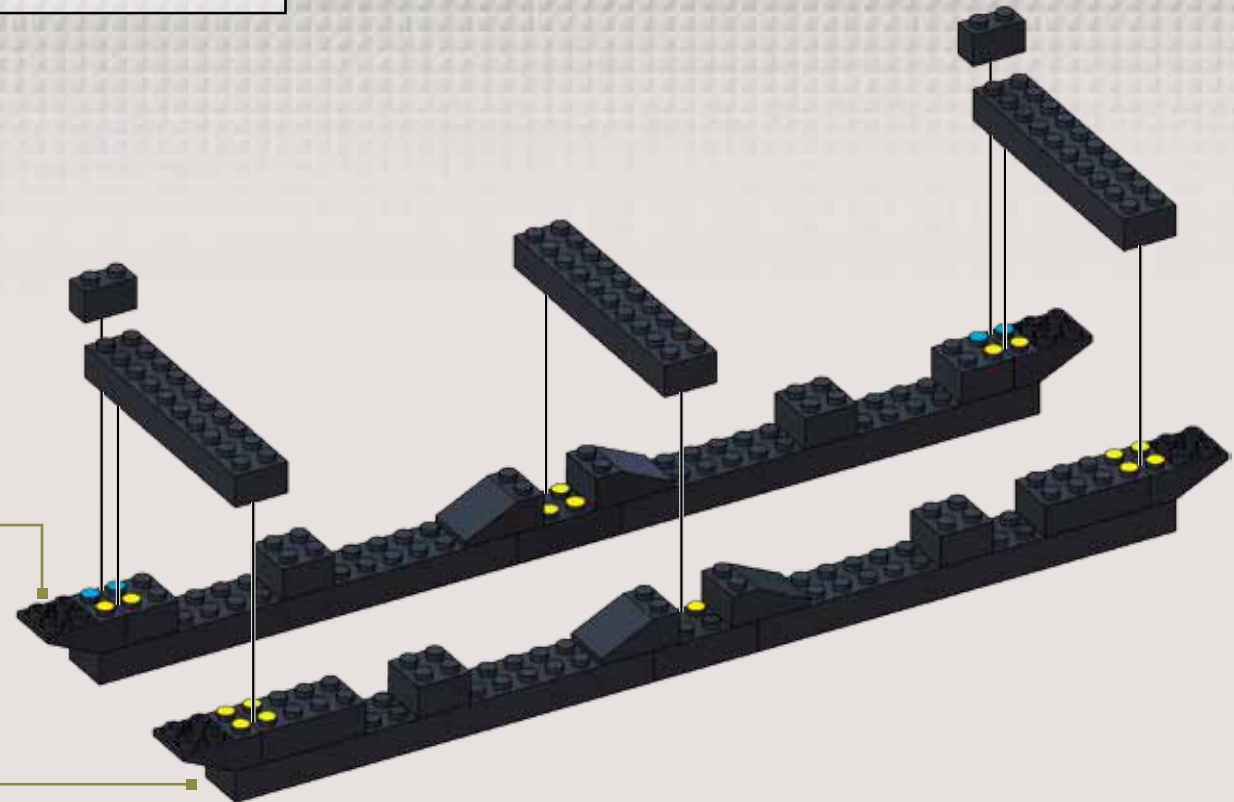
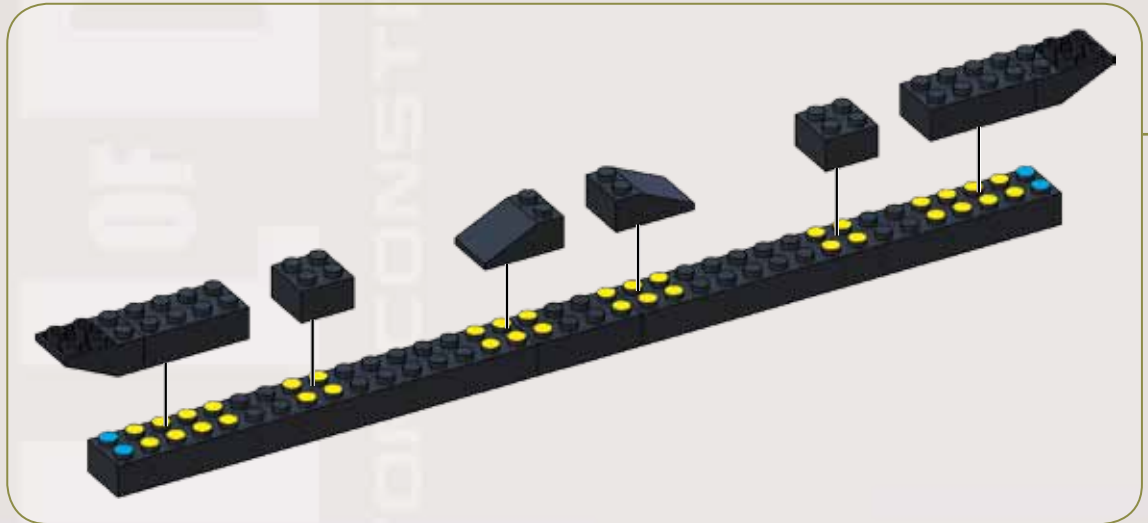
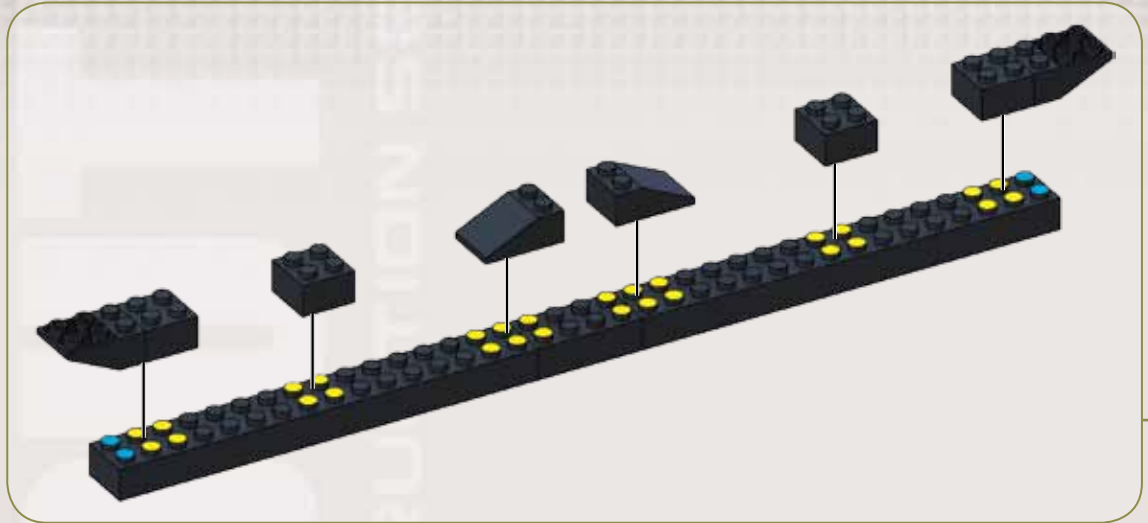
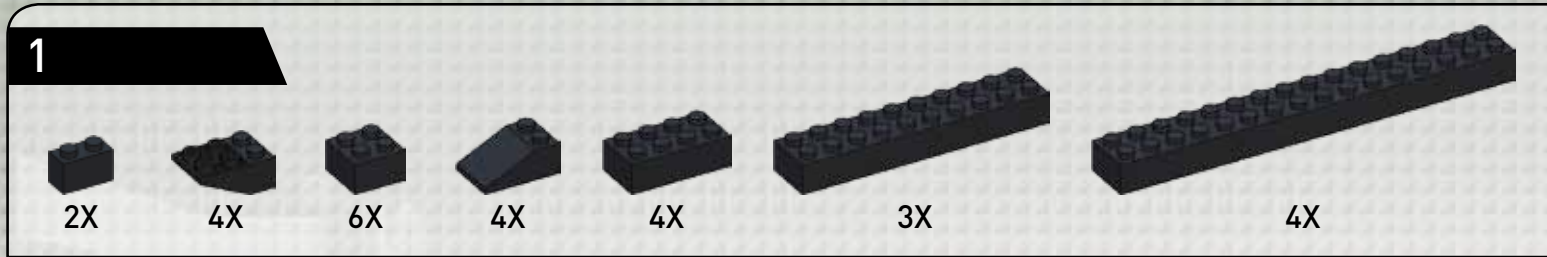

1

2



3

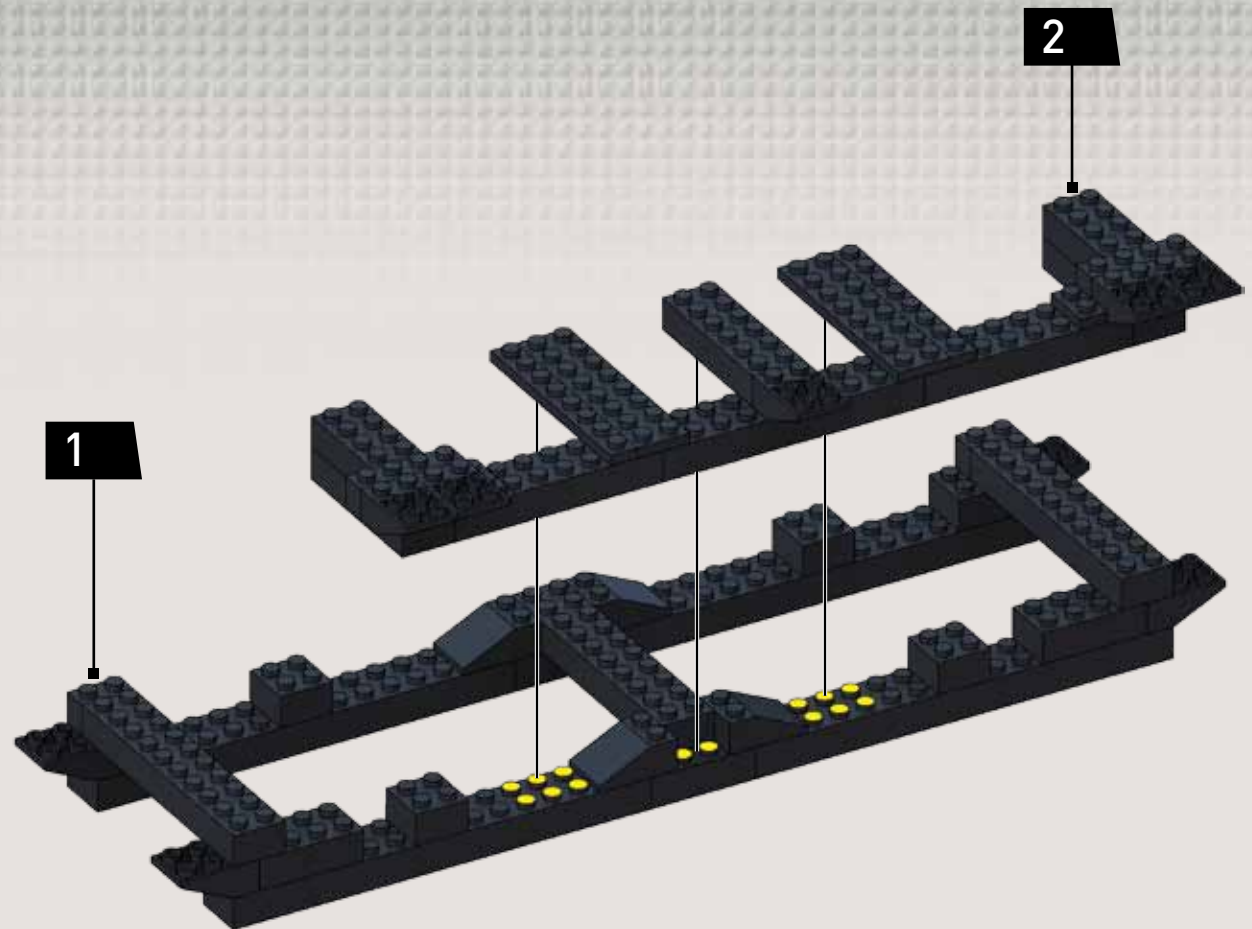

4

2X 4X 4X 2X

x2

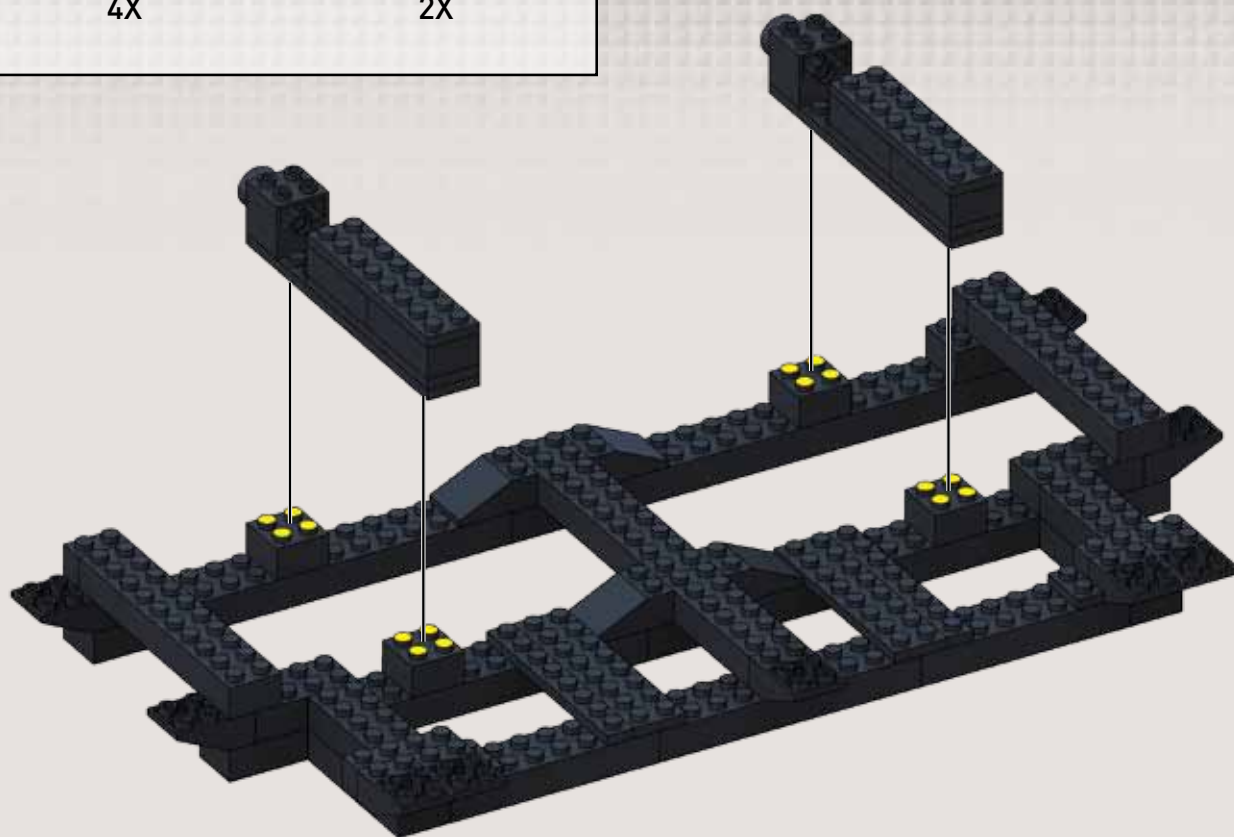

5

4X 6X 2X 2X

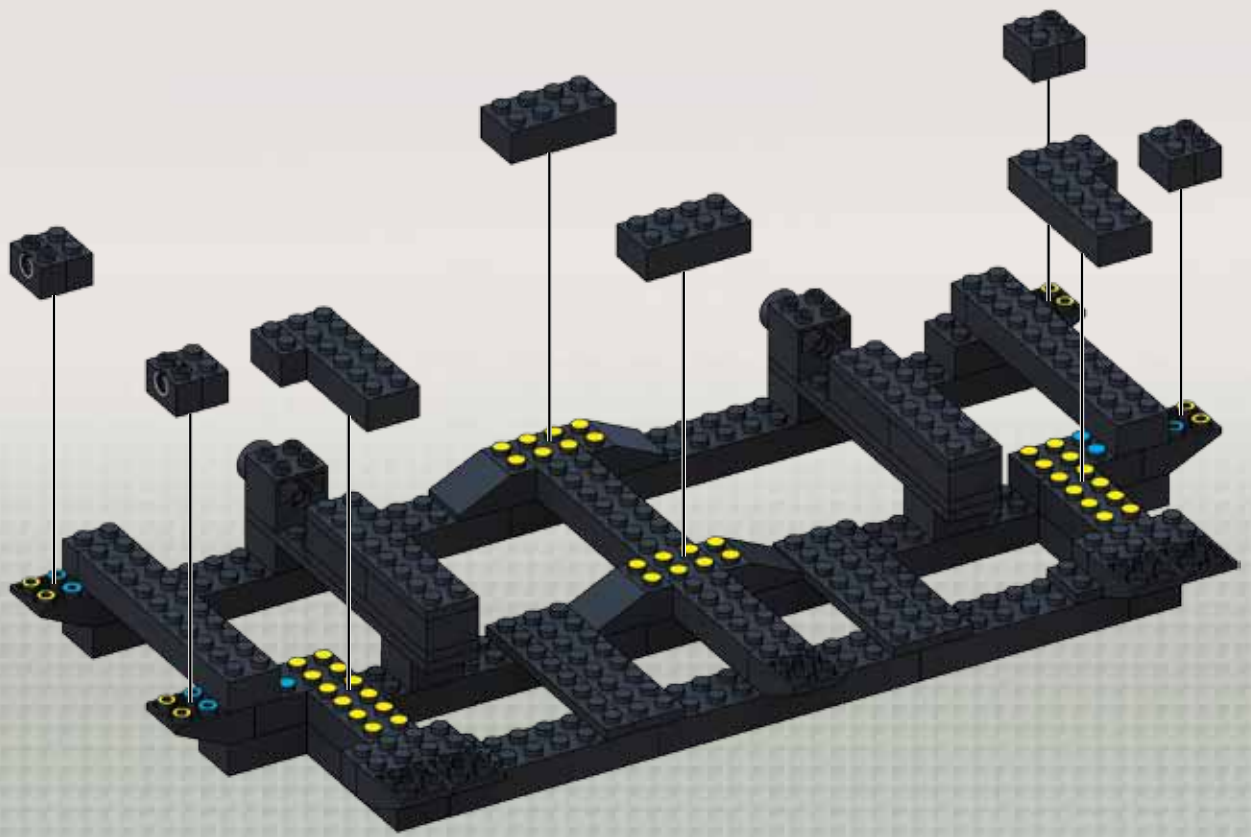

6

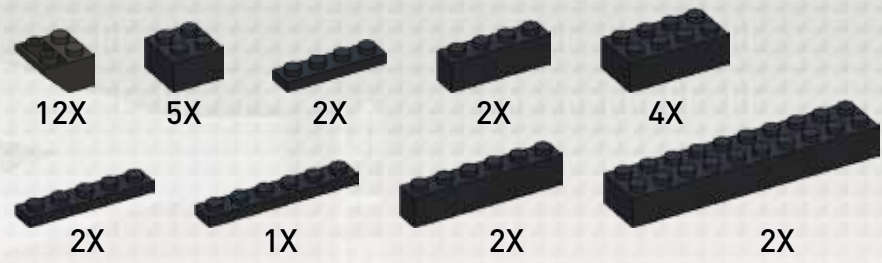

7

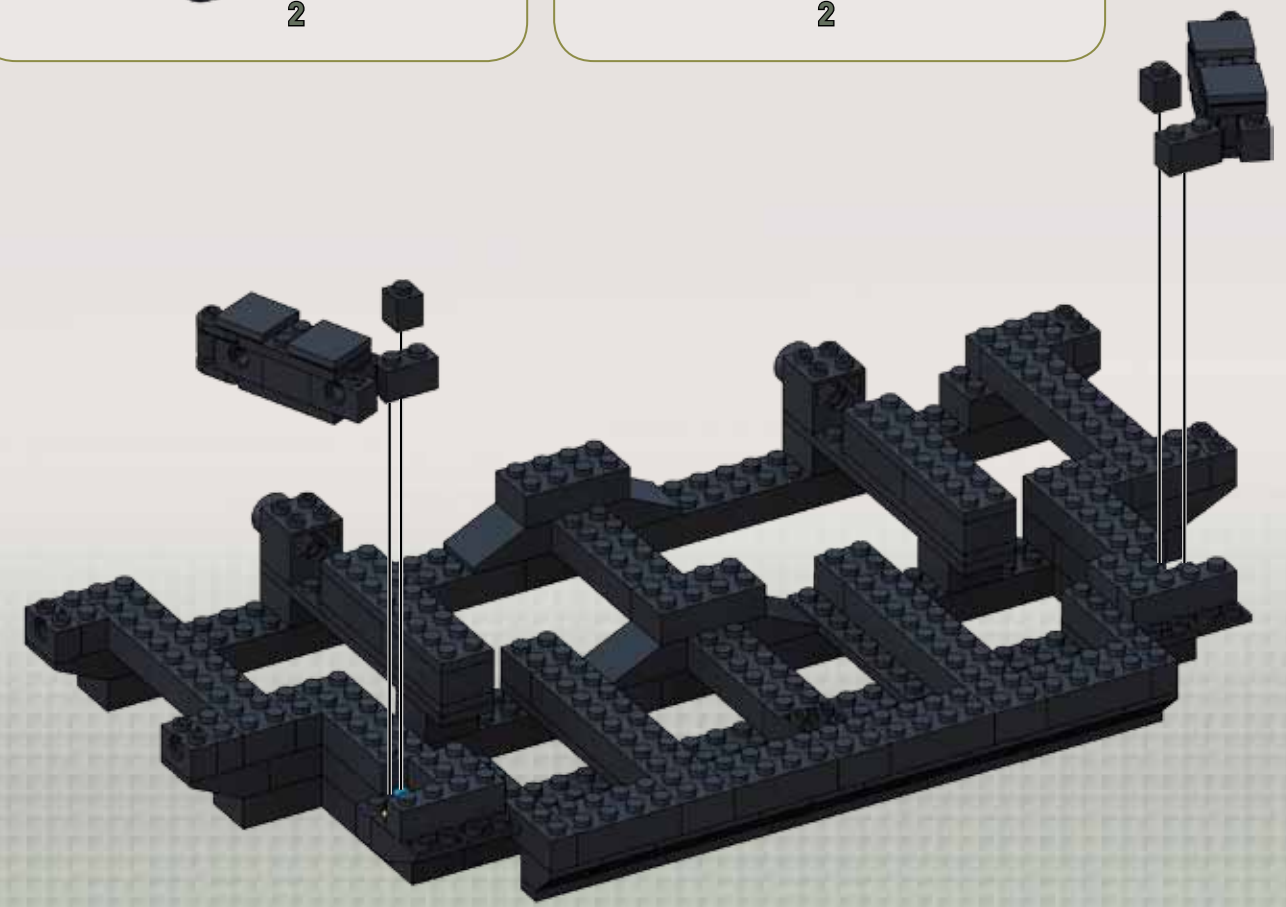
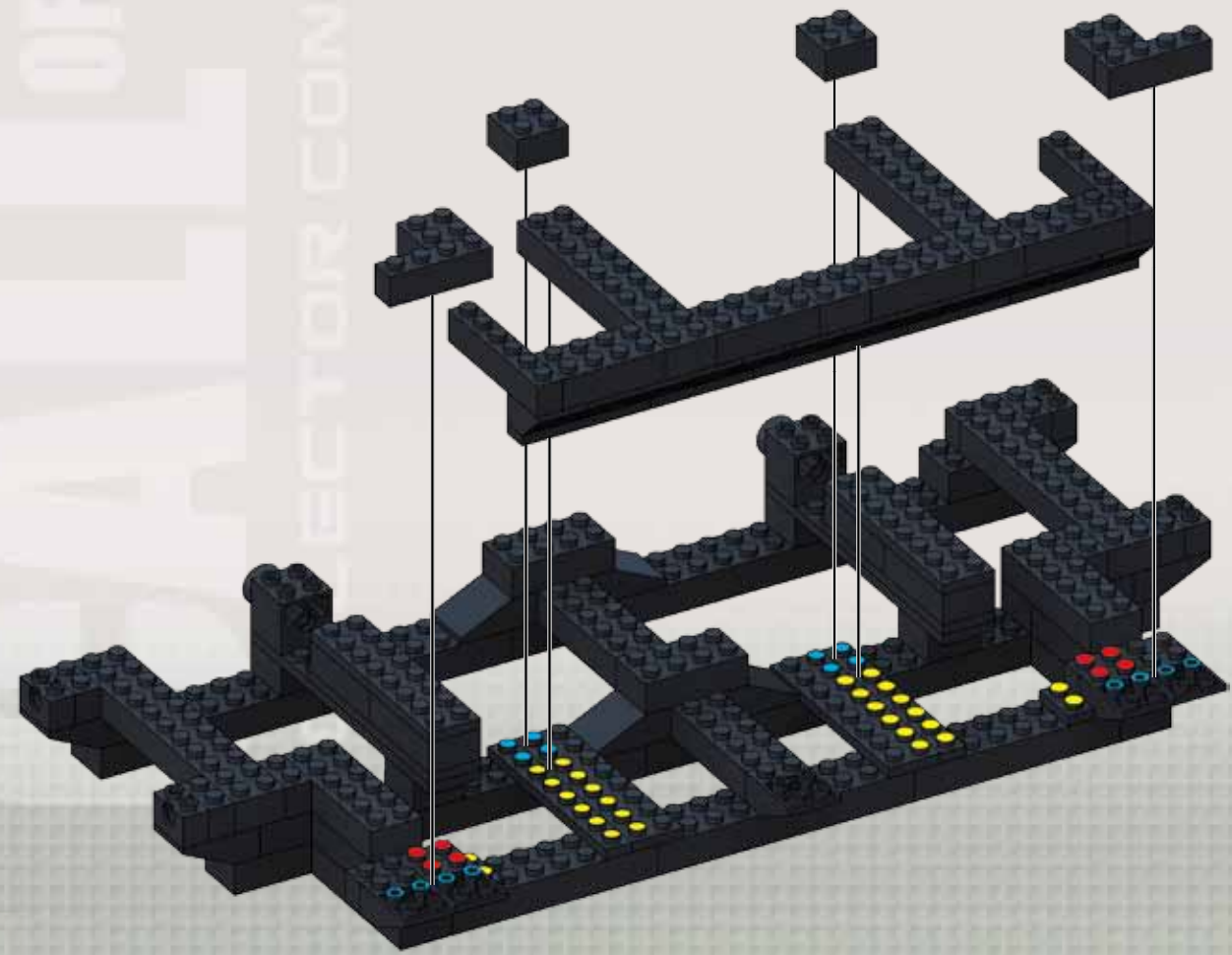
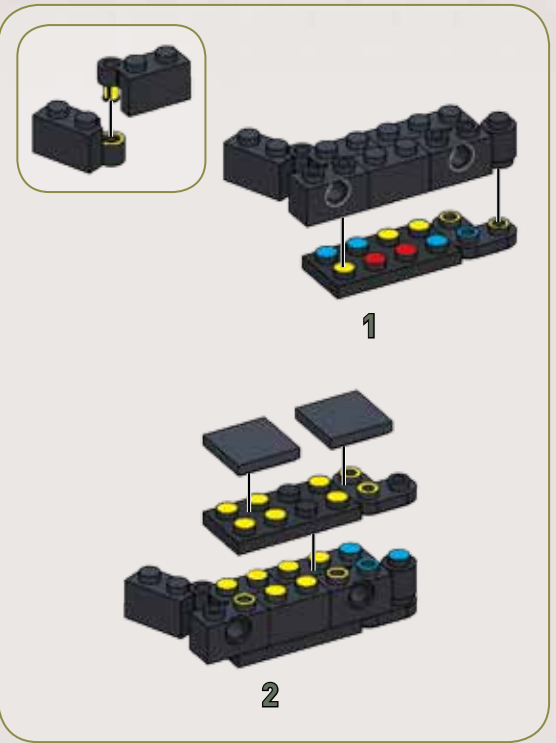
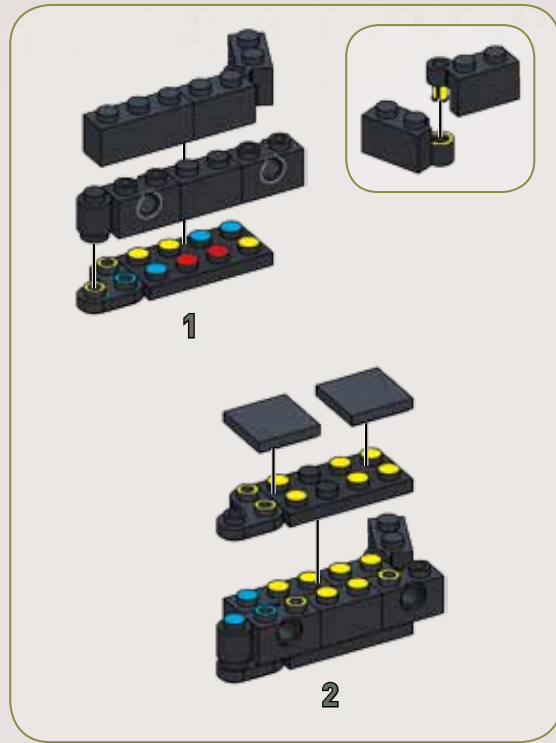
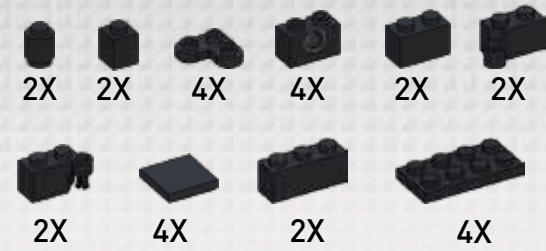



8

- 4X [1x1 brick]
- 4X [1x2 brick]
- 2X [1x3 brick]
- 1X [1x4 brick]

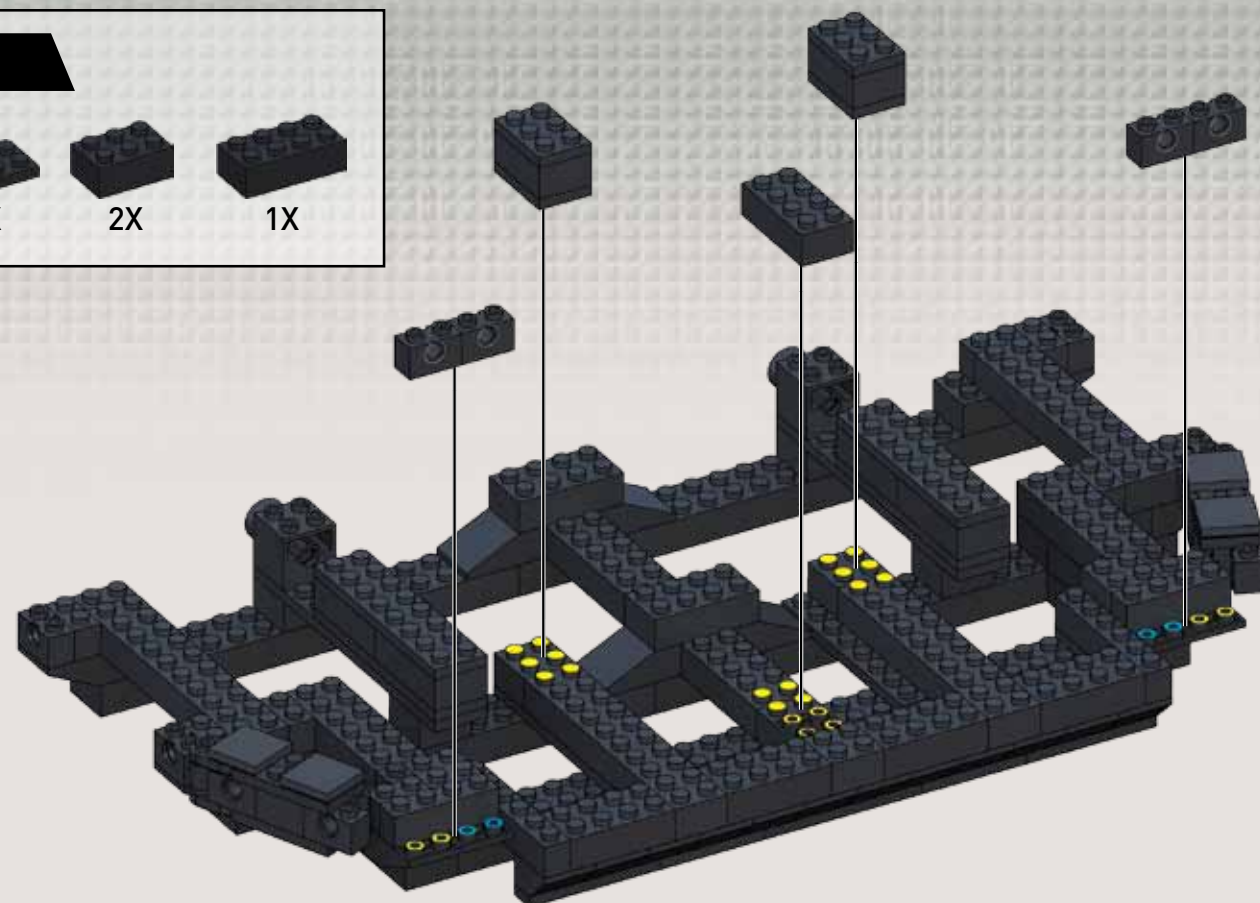
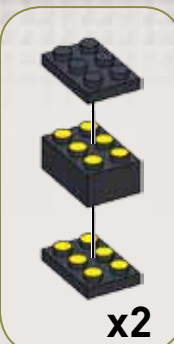

9

- 2X [1x2 brick]
- 2X [1x3 brick]
- 2X [1x7 brick]

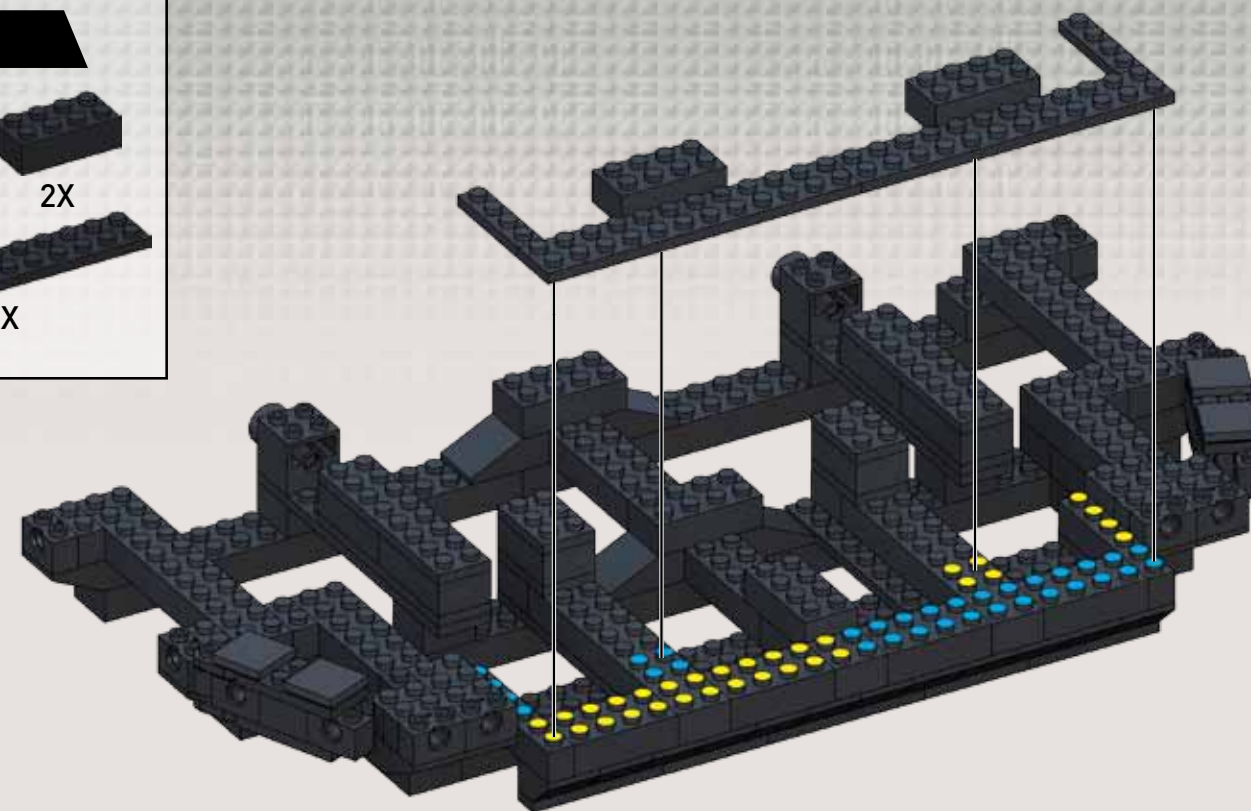

10

- 2X [1x1 brick]
- 2X [1x2 brick]
- 2X [1x3 brick]
- 3X [1x4 brick]

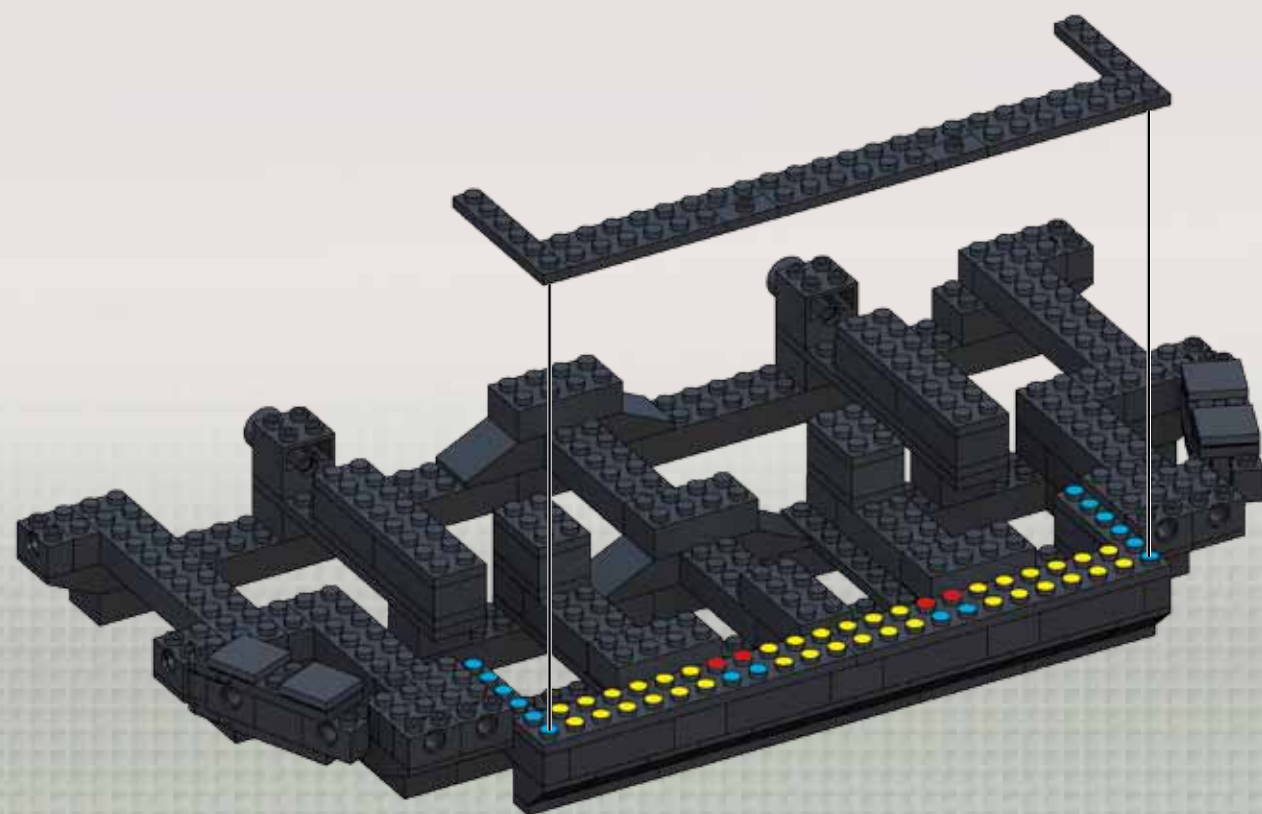

11

- 3X [1x1 brick]
- 2X [1x2 brick]
- 2X [1x3 brick]
- 4X [1x4 brick]
- 1X [1x7 brick]

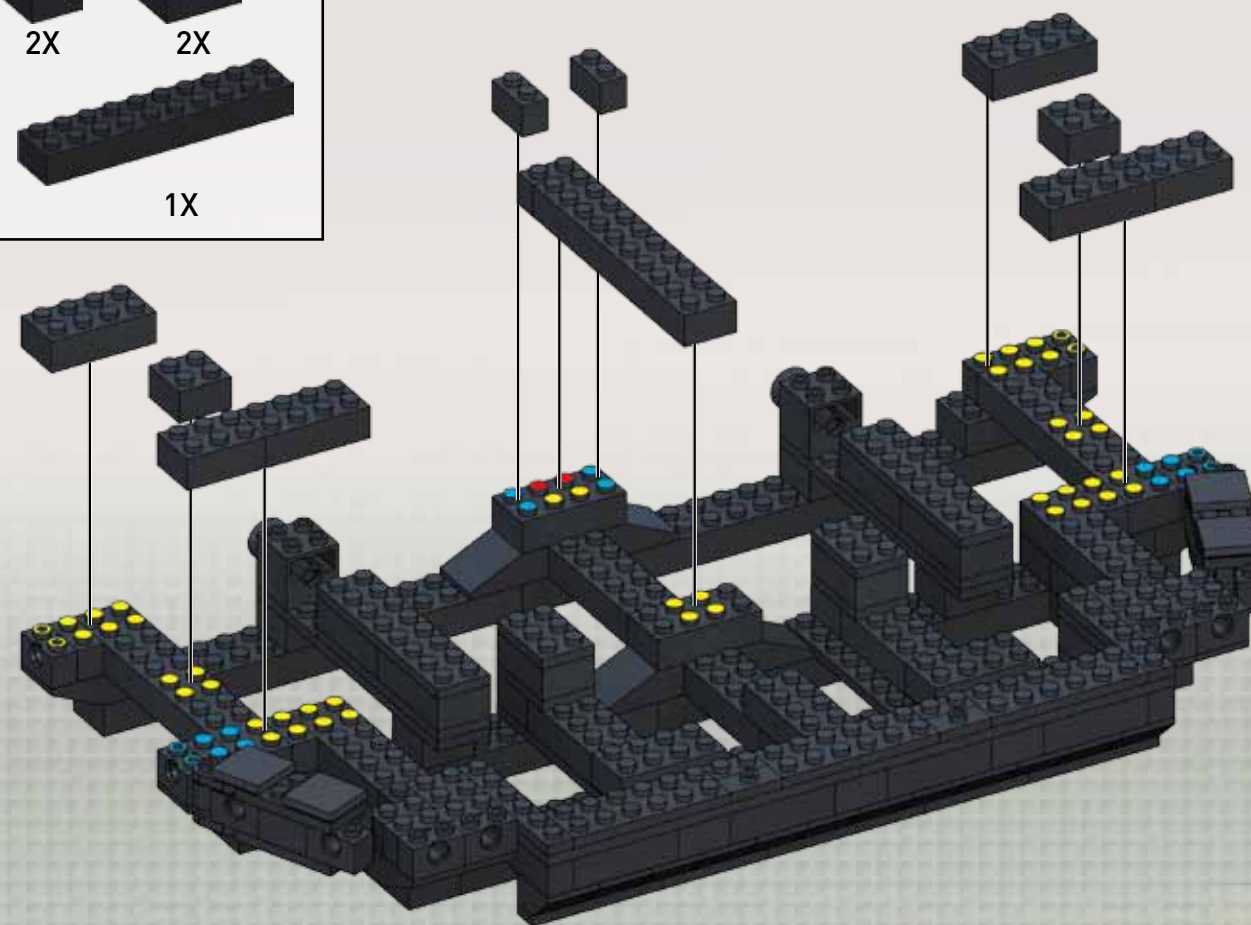

1

12

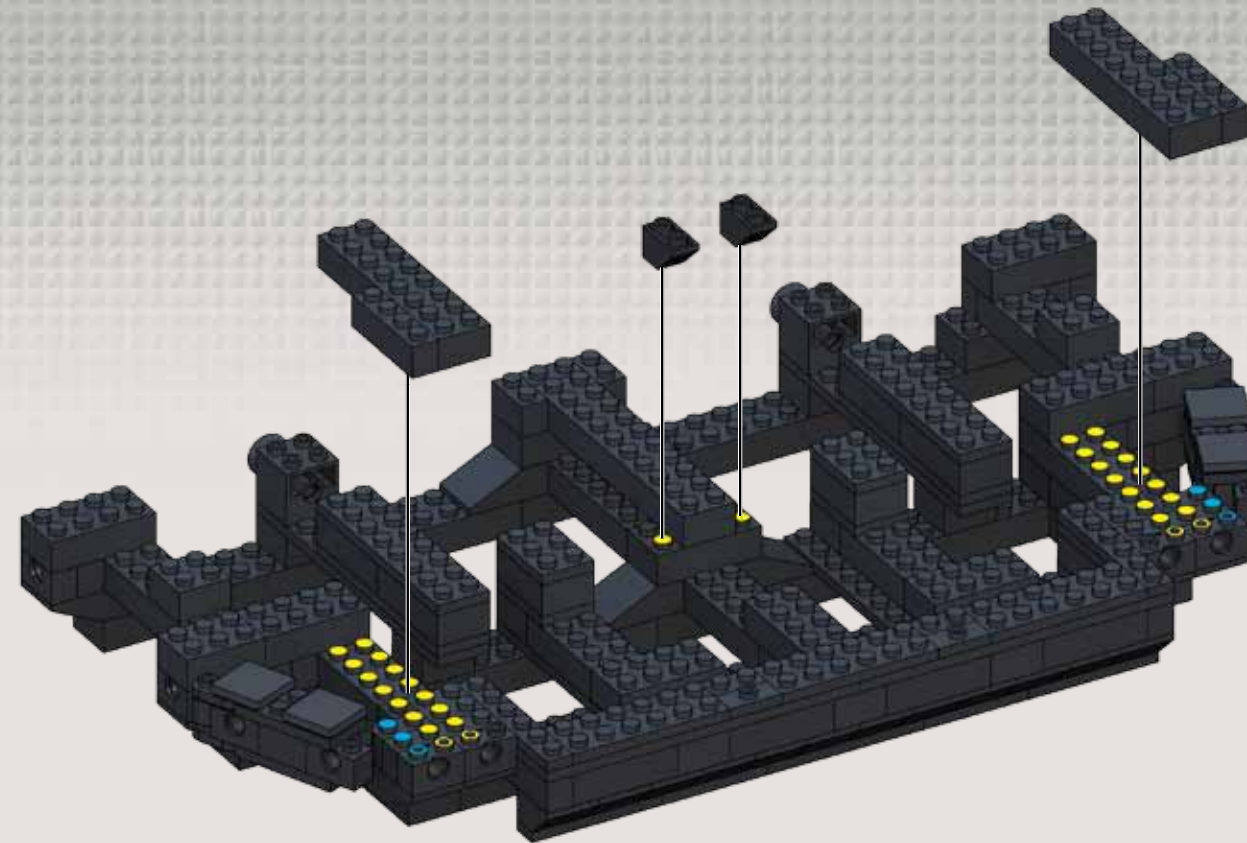

13

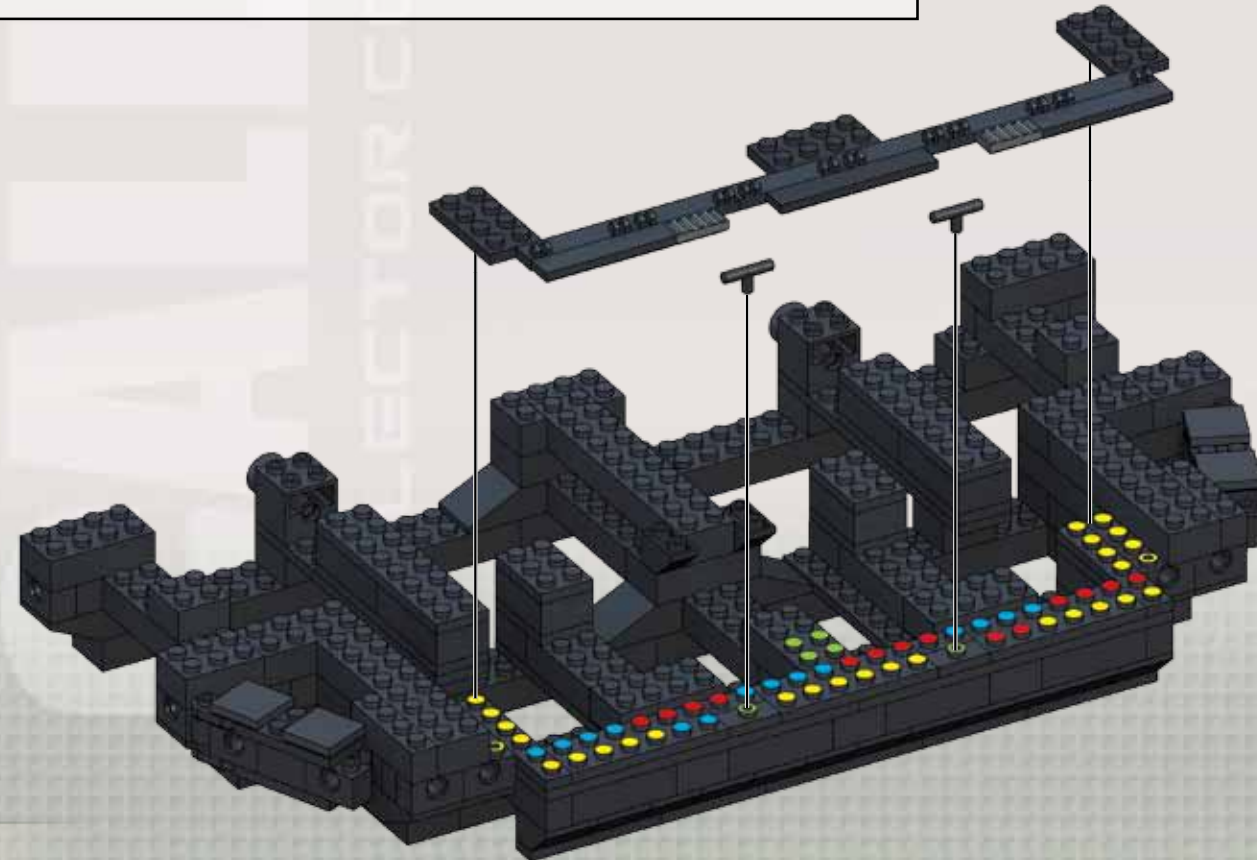

14

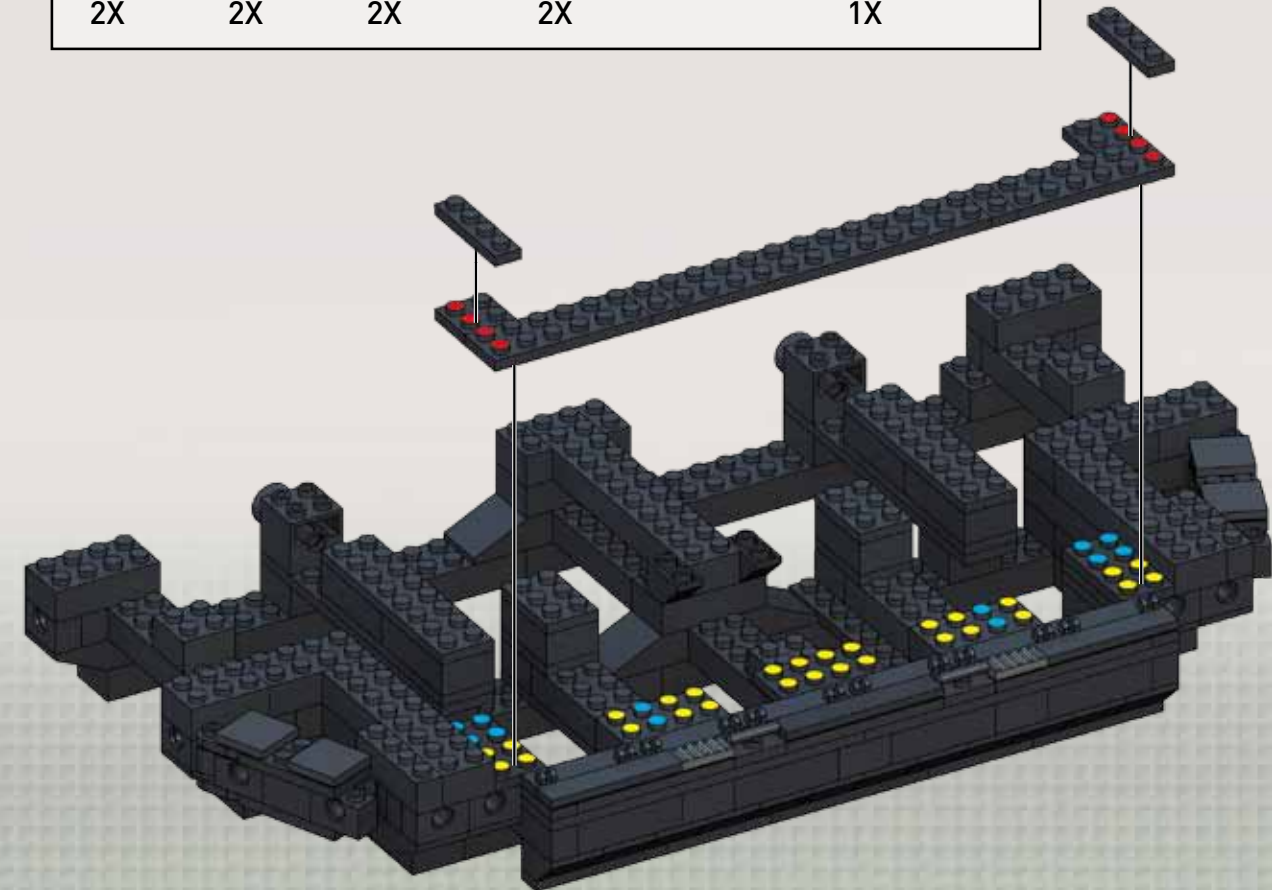



15

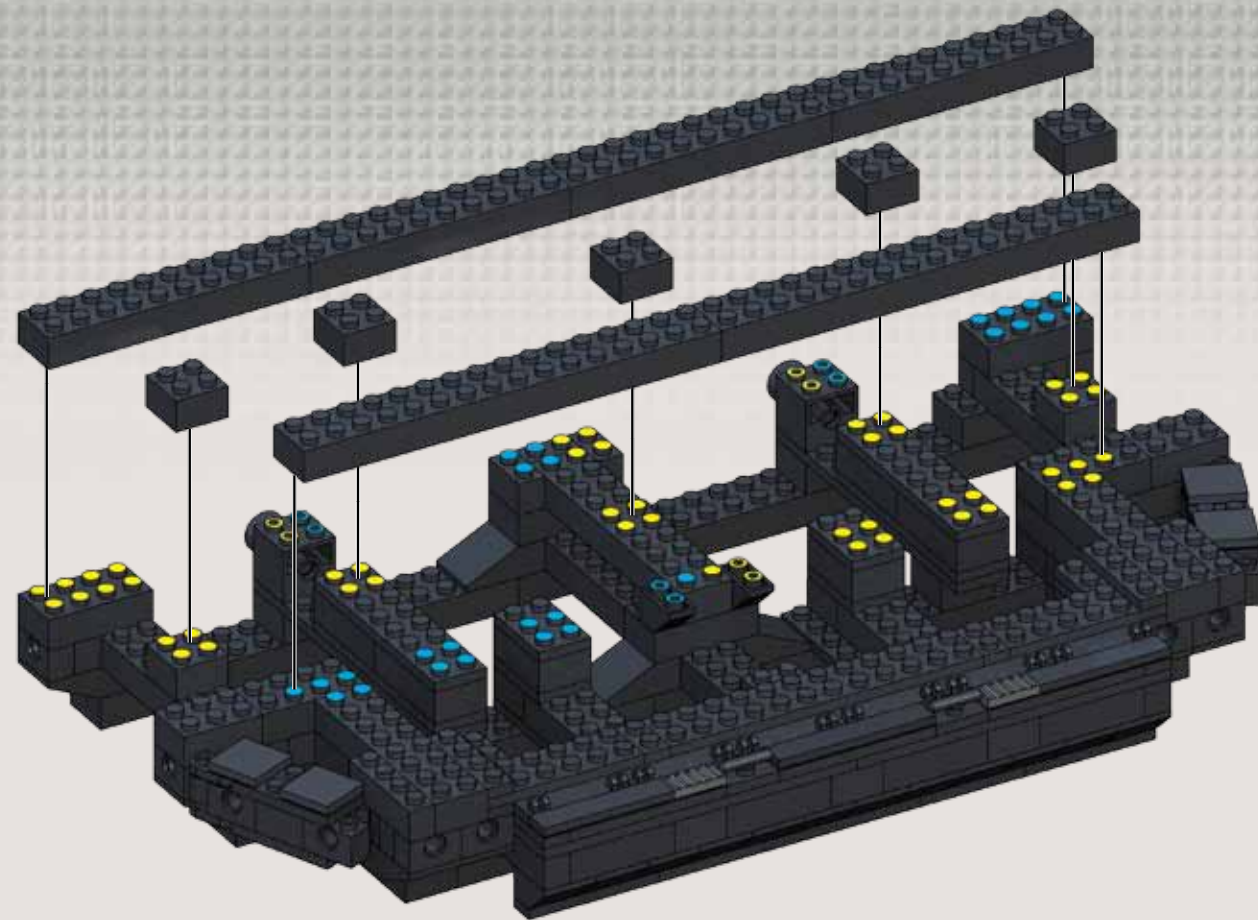
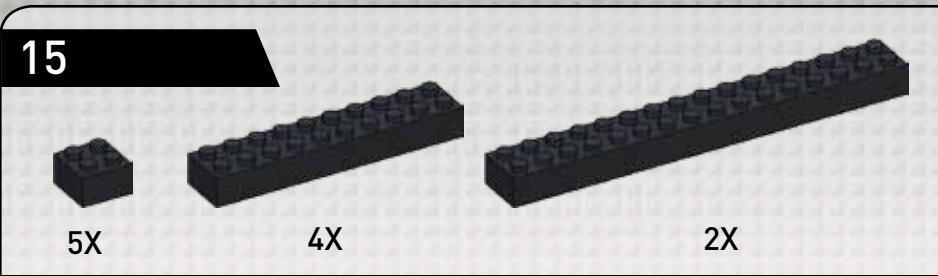

16

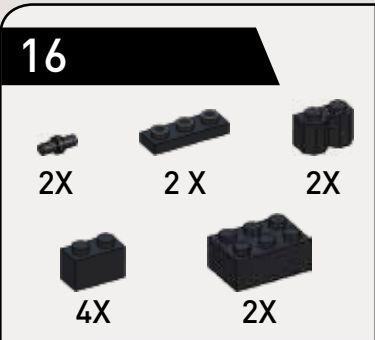

17

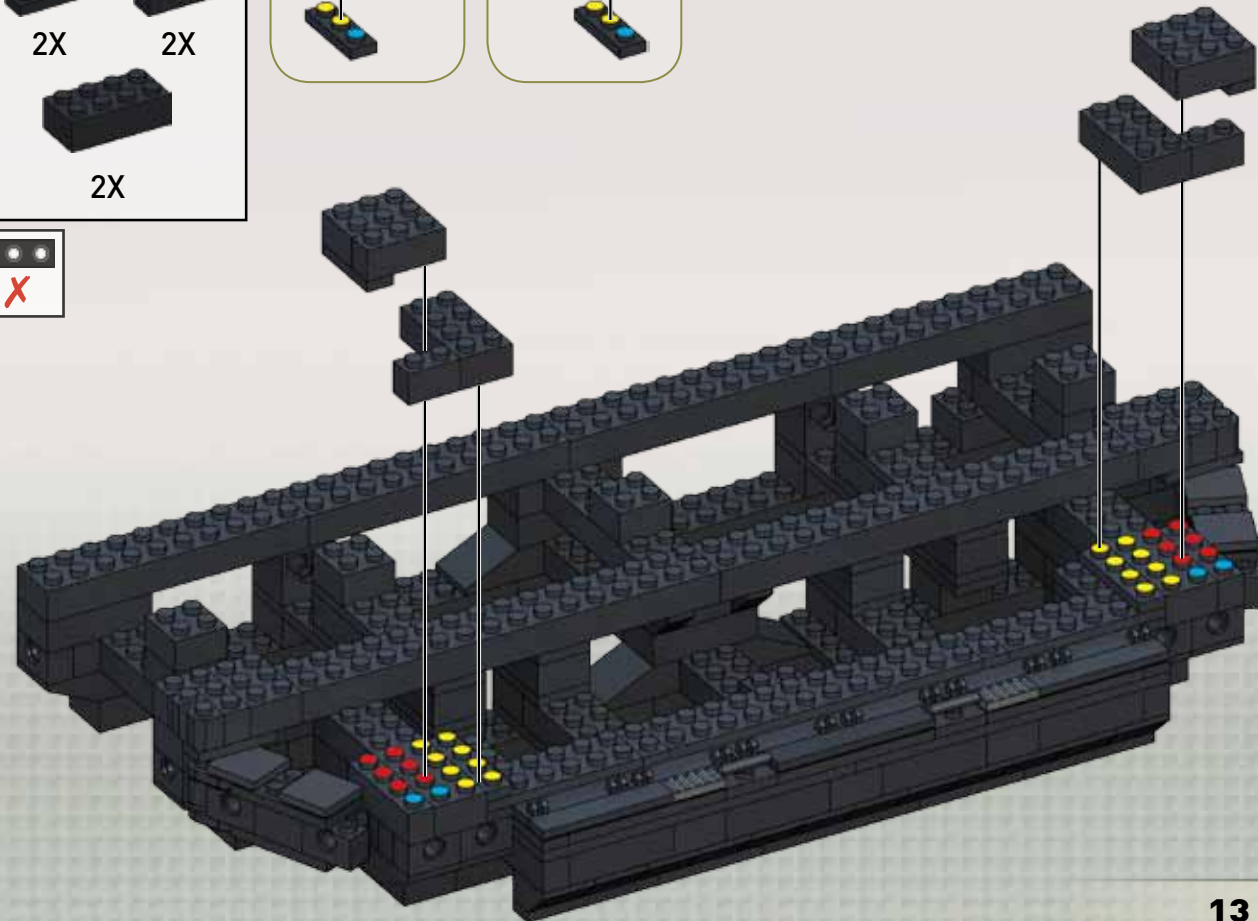
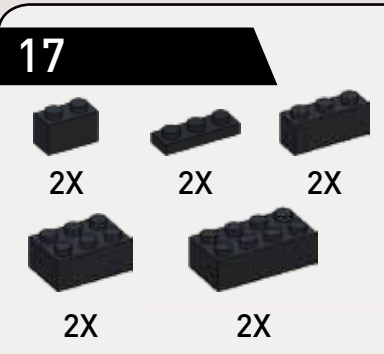

18

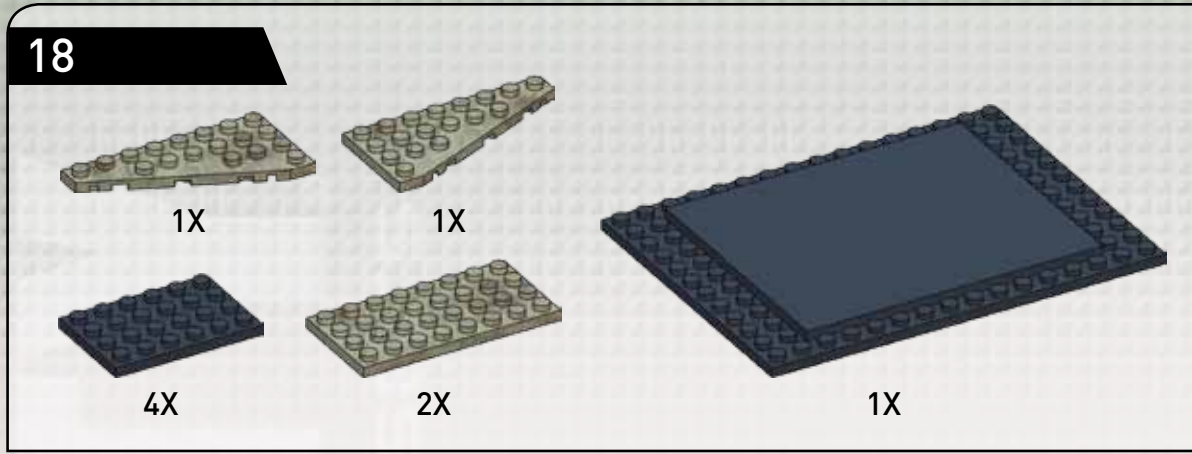

19

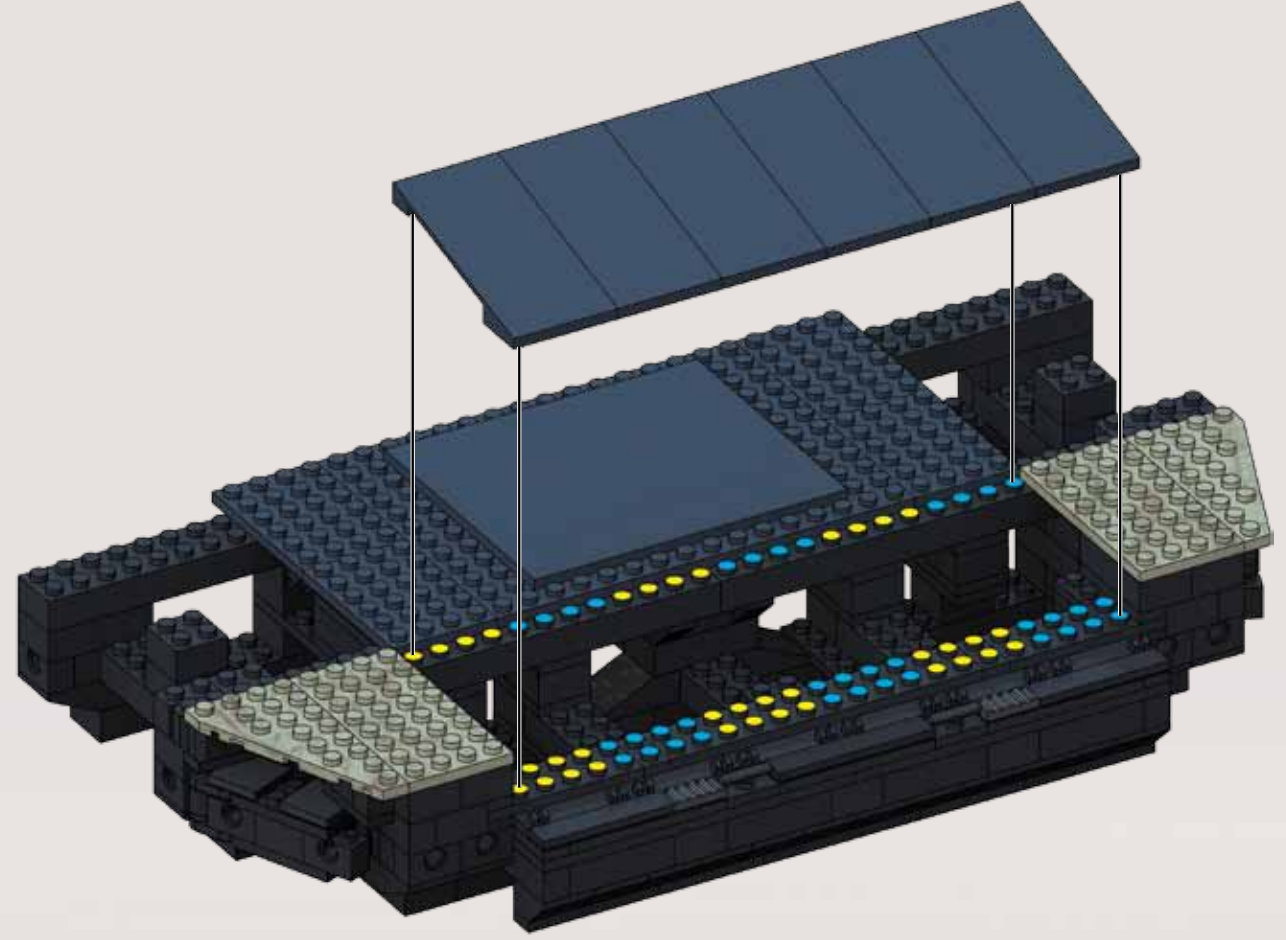
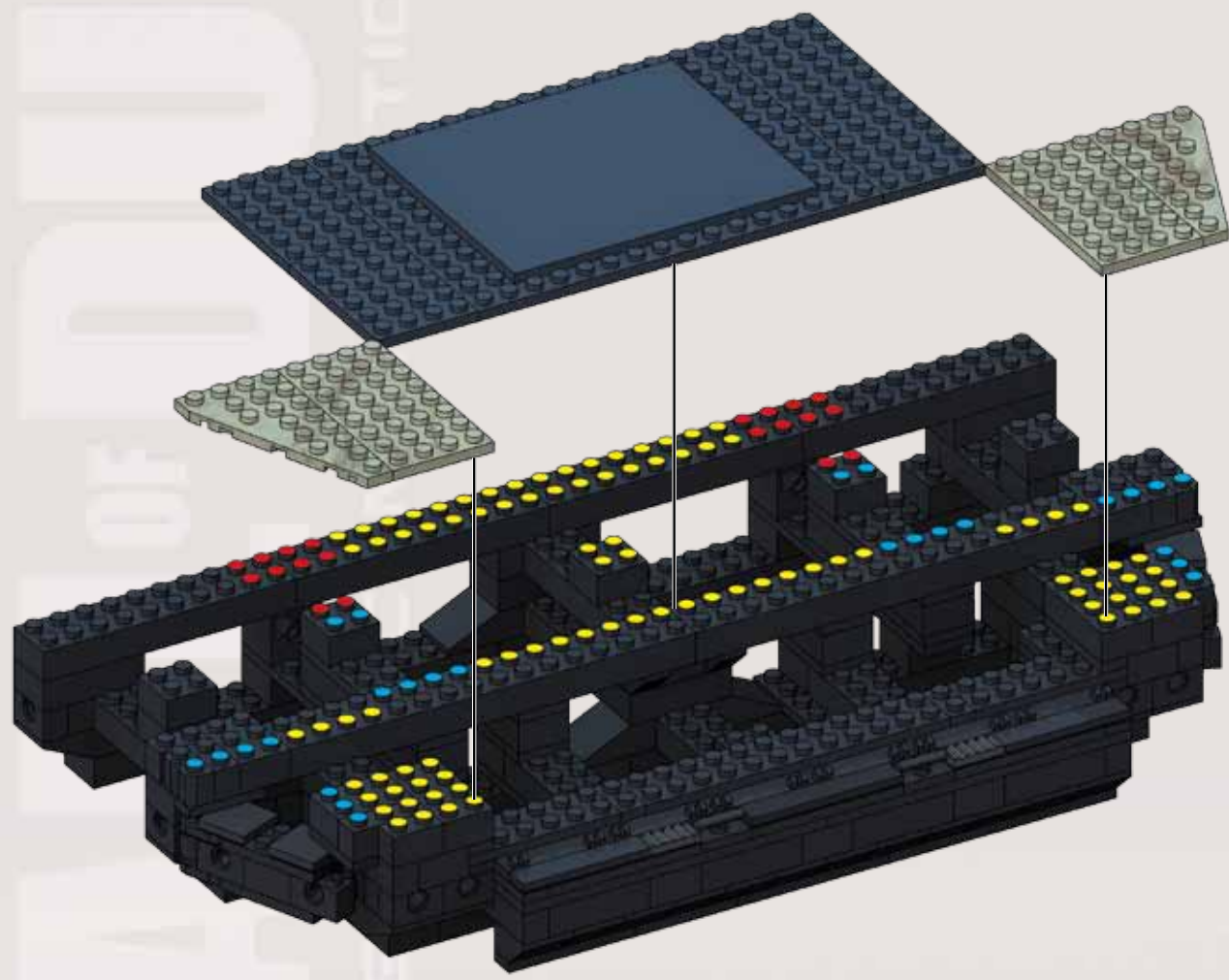
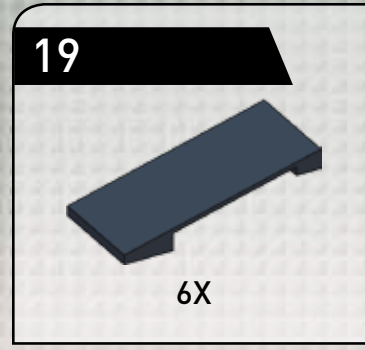



20

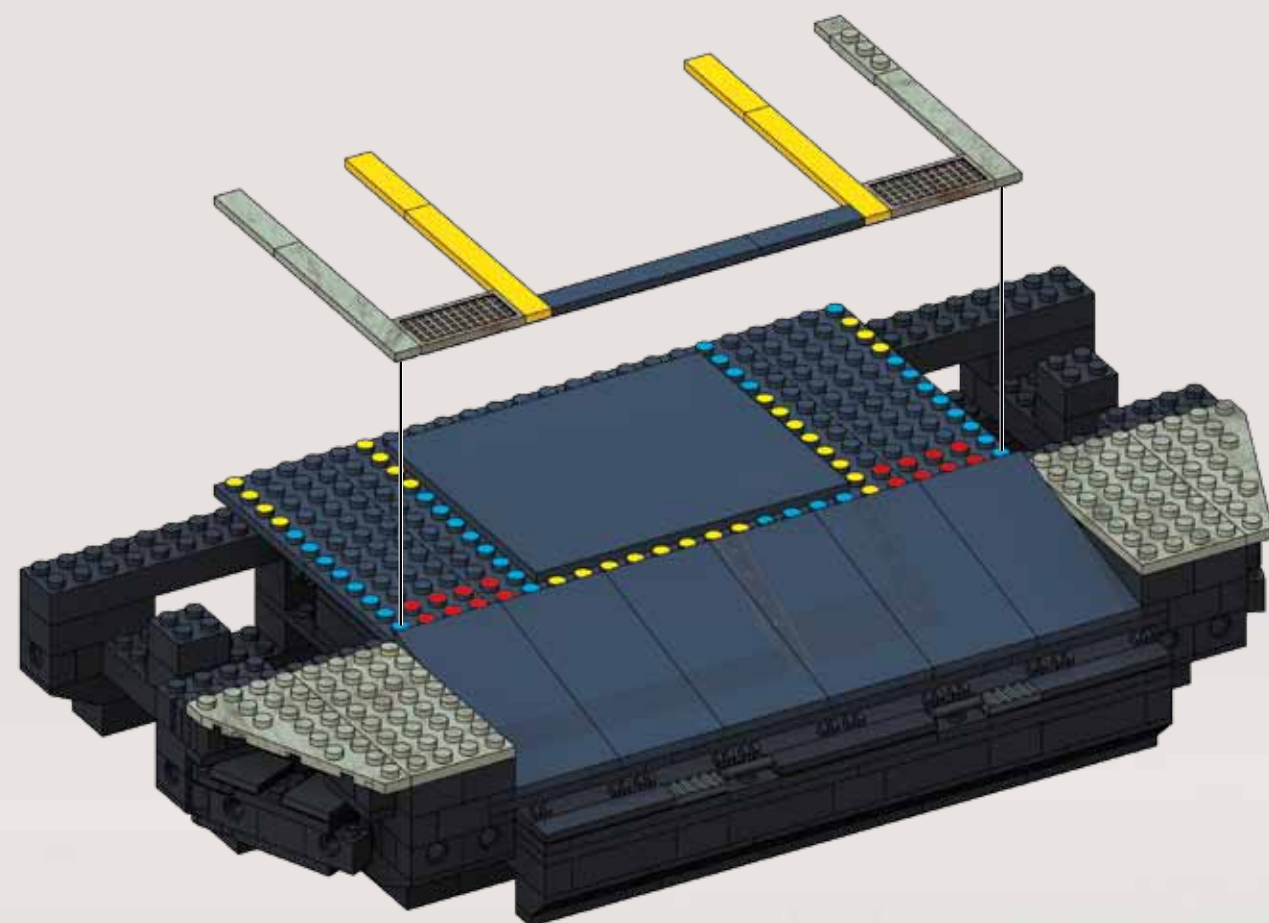
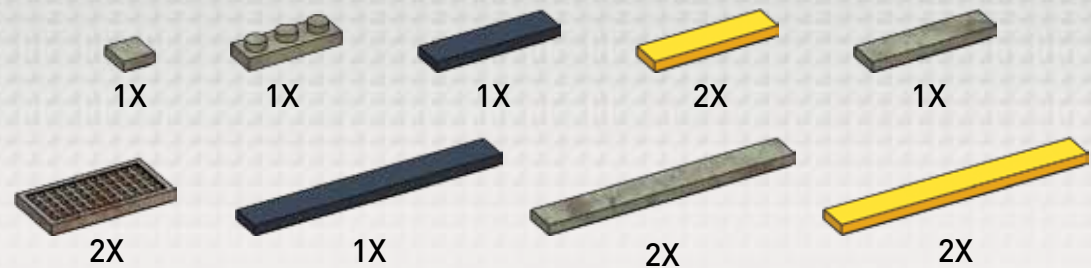

1

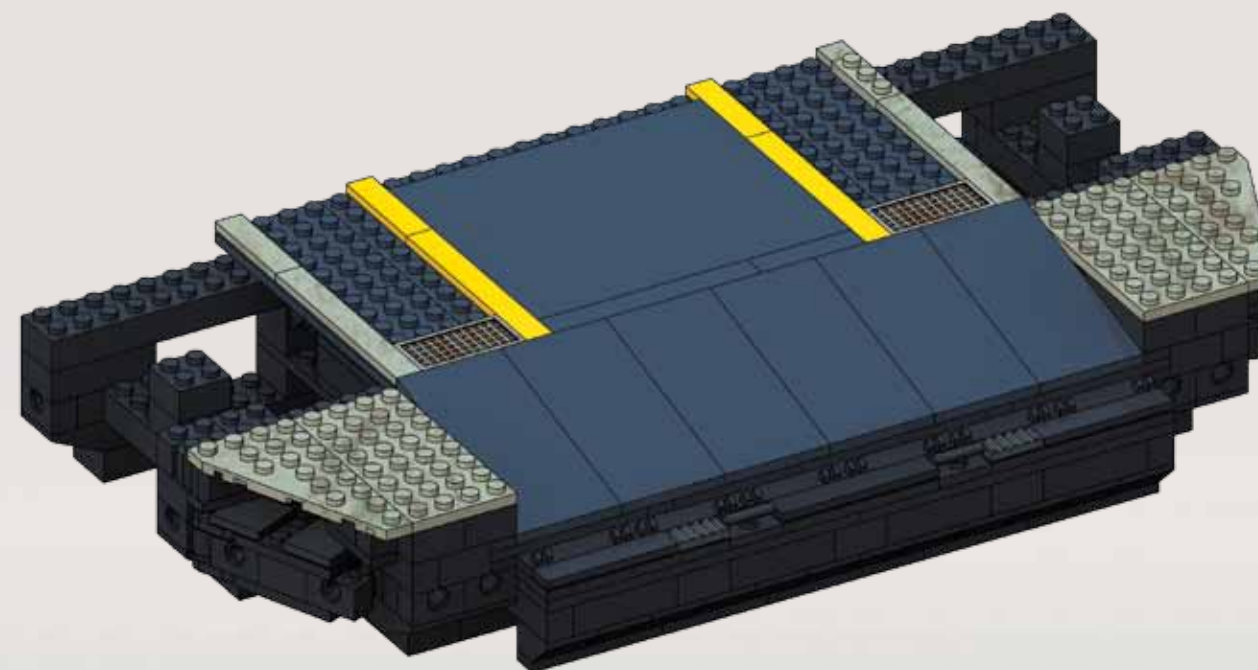

2



1

21



14X

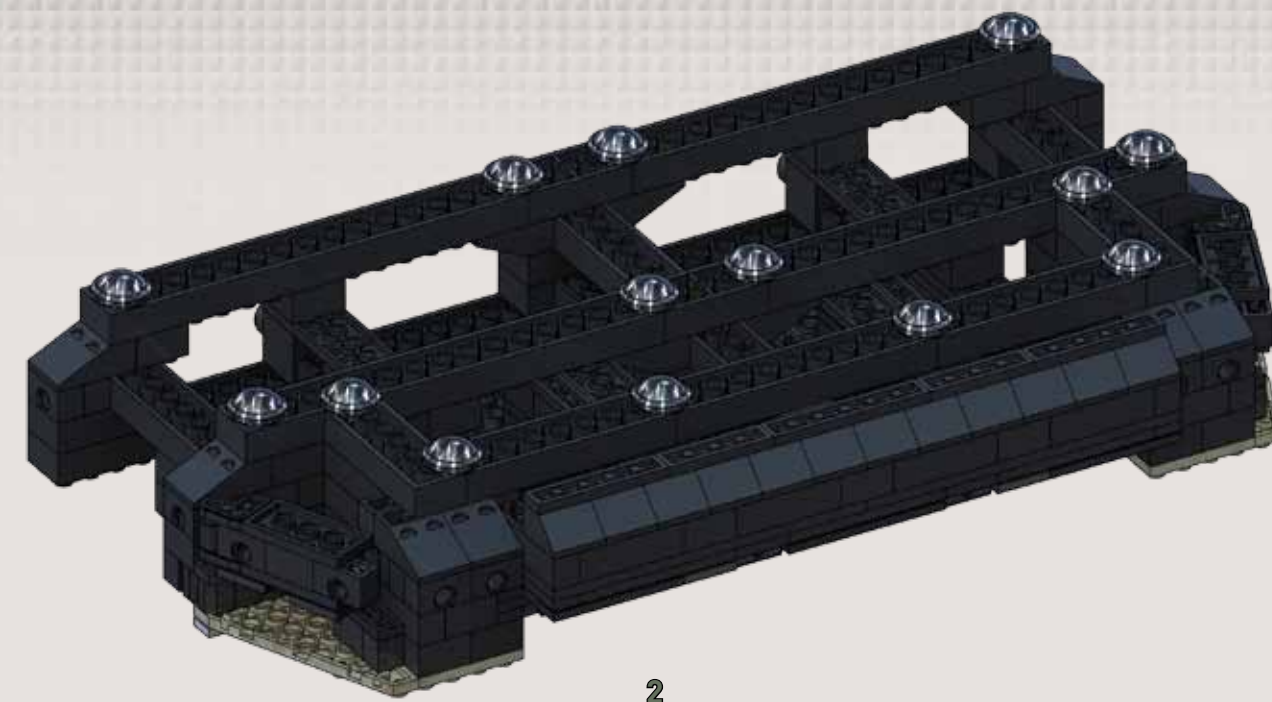
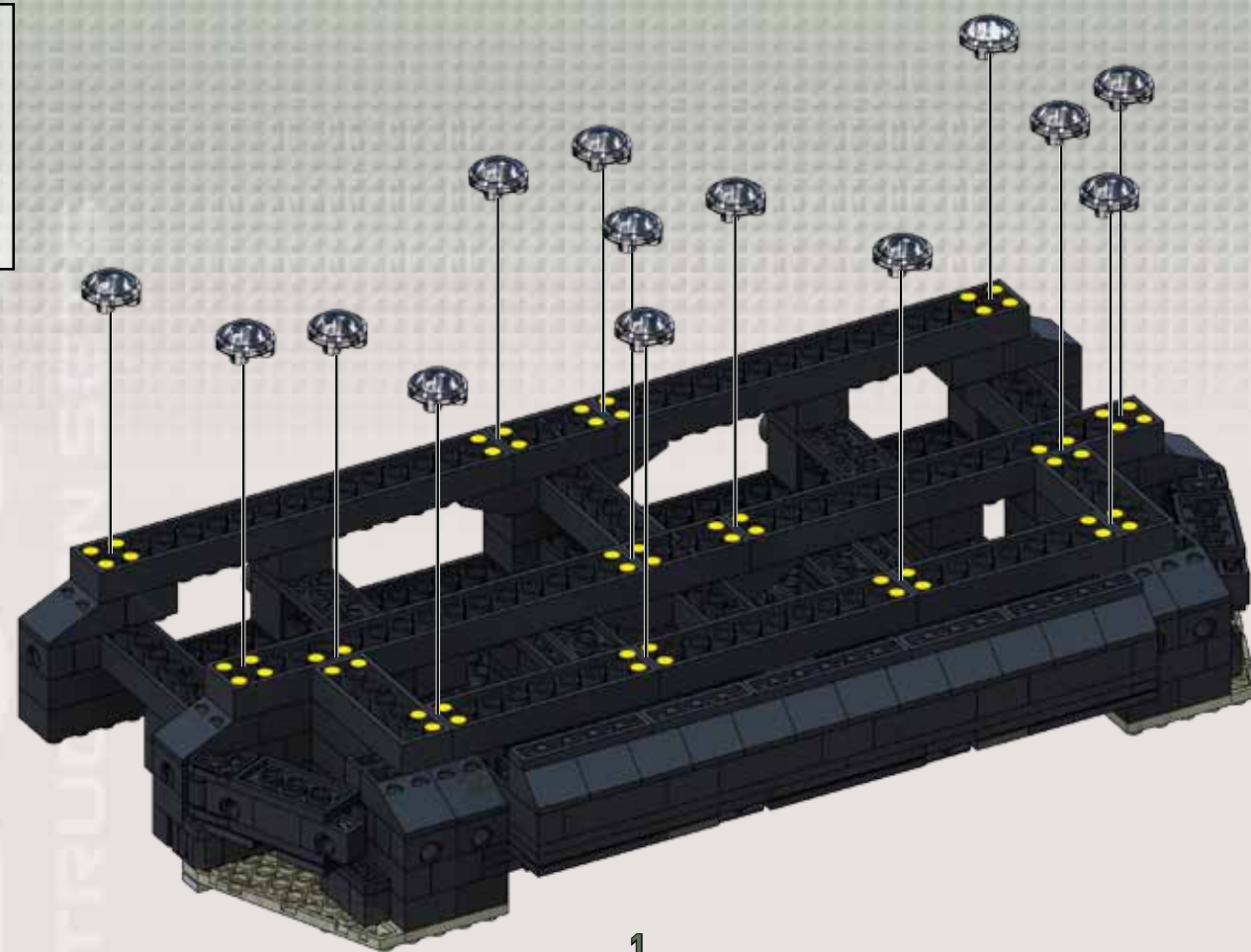

22

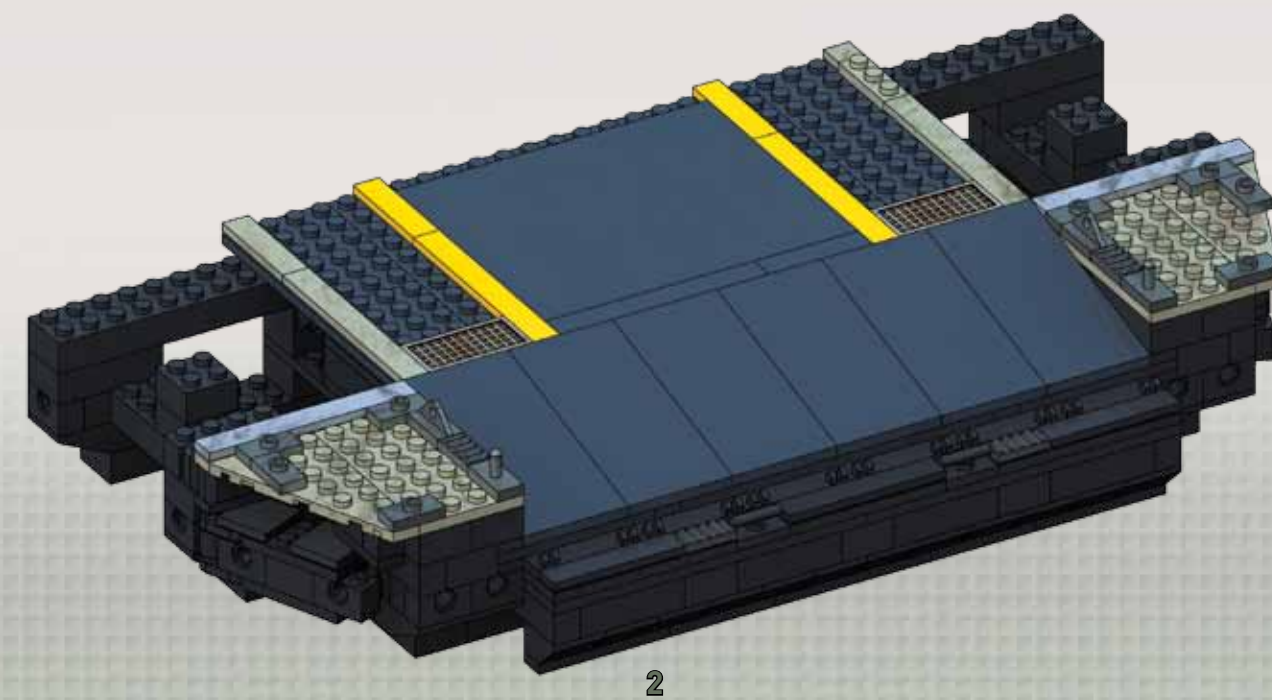
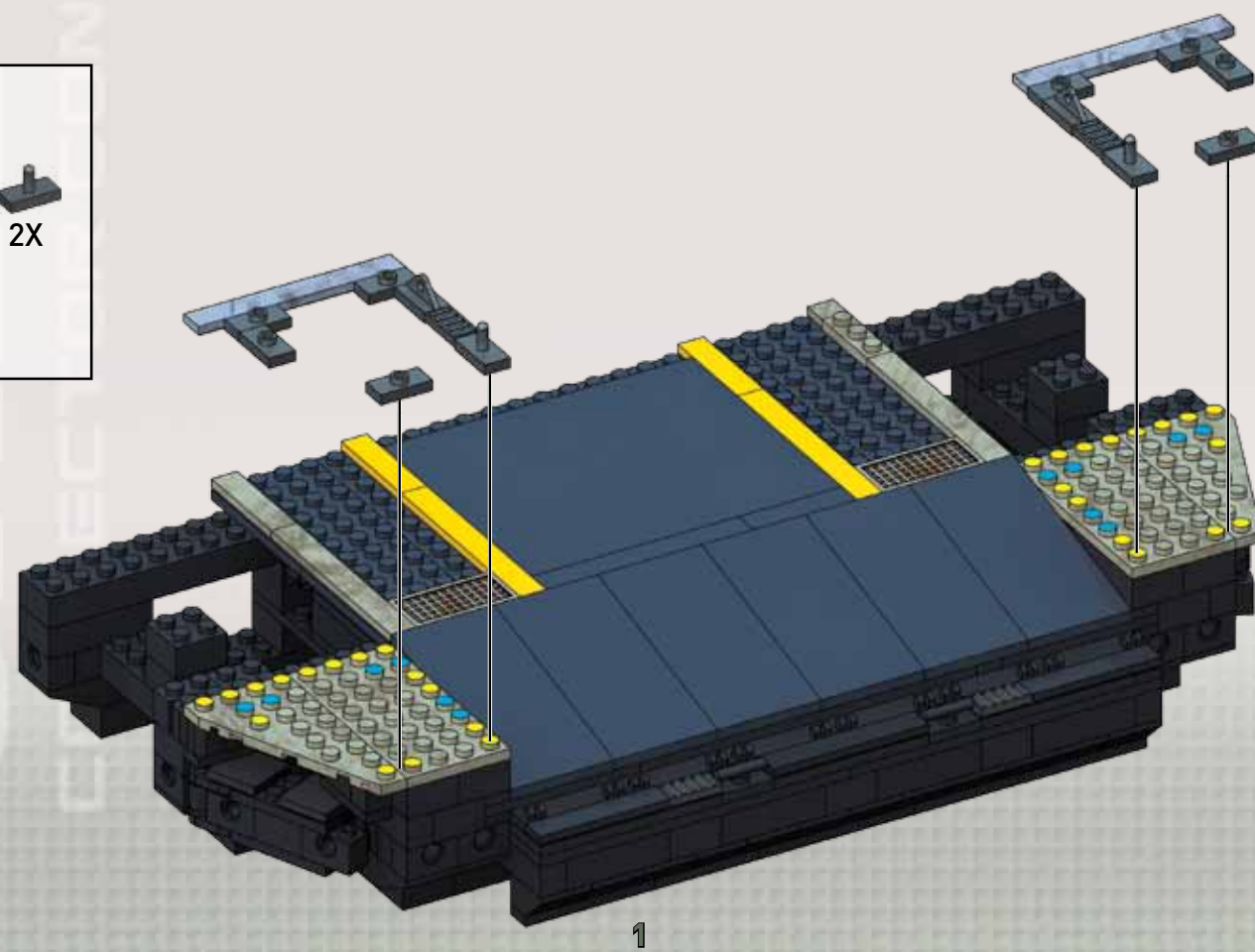
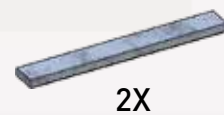



23

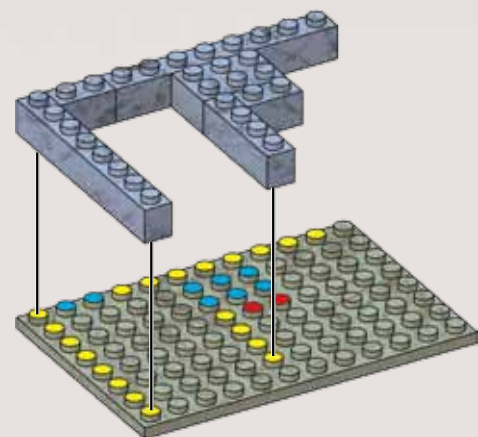
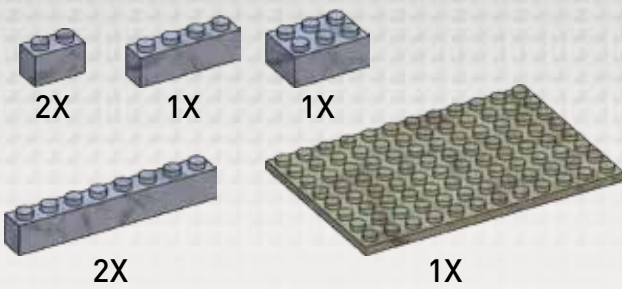

24

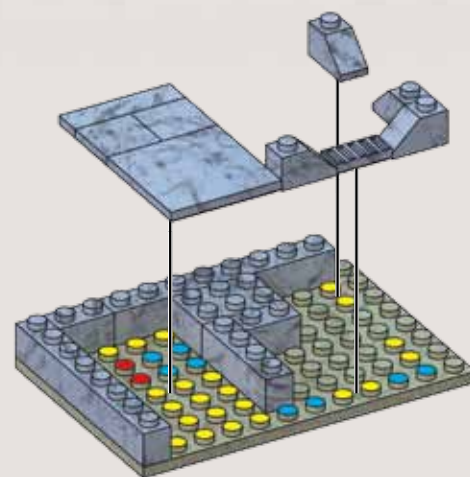
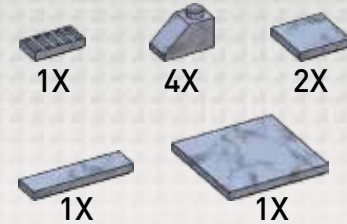

25

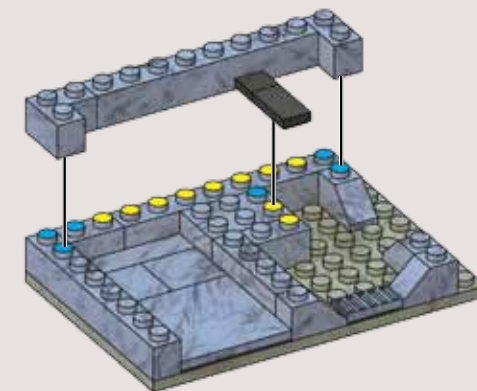
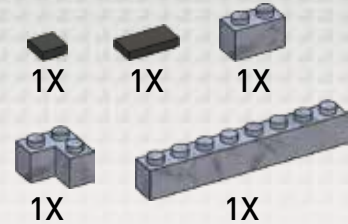

26

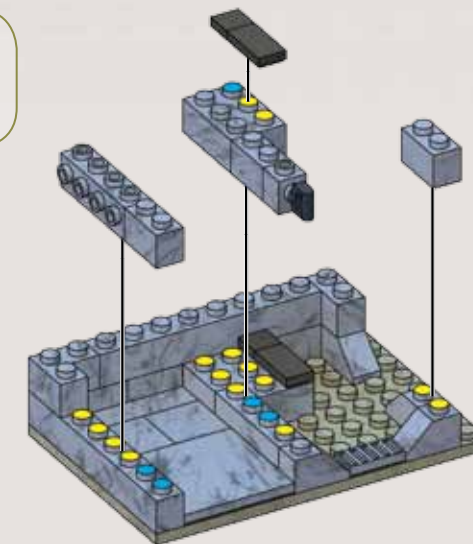
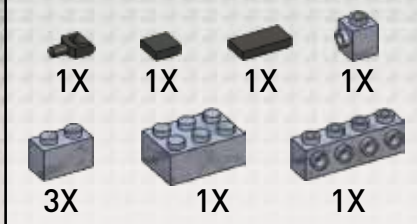

27

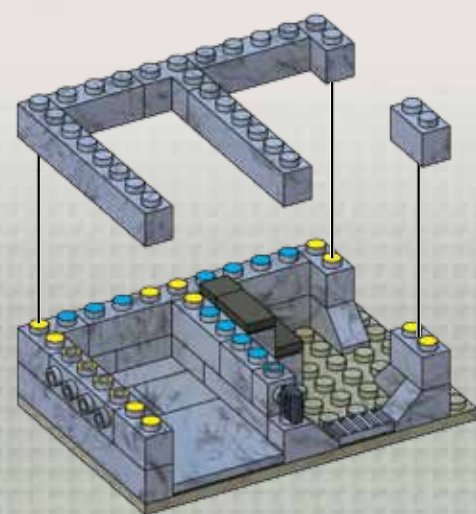
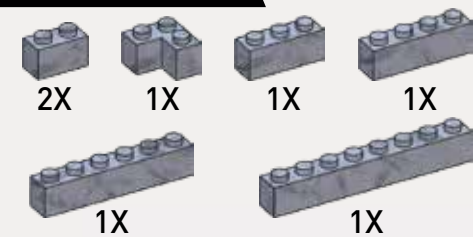

28

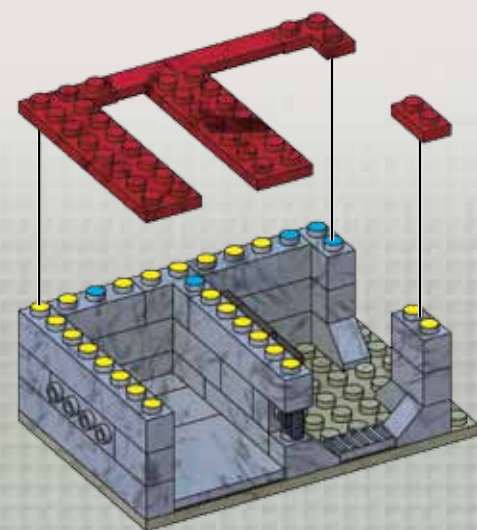
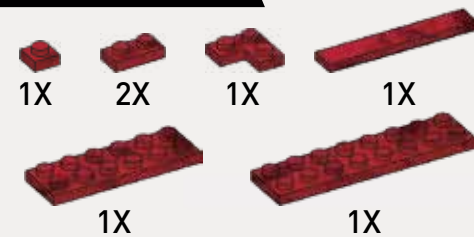

29

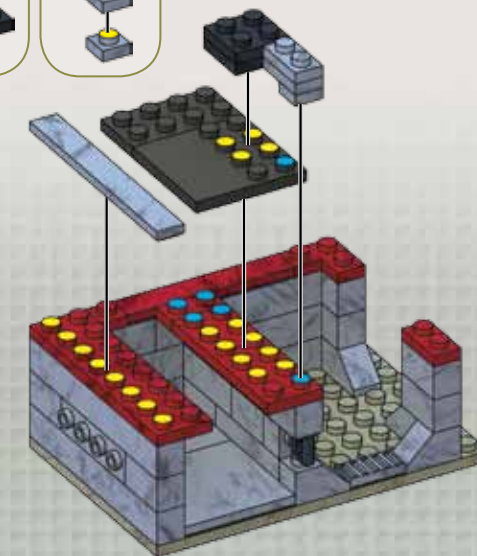
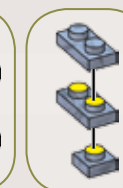
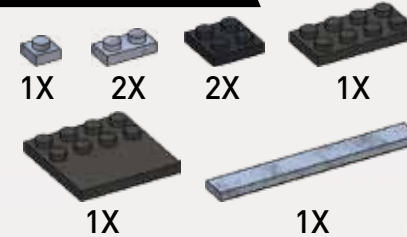

30

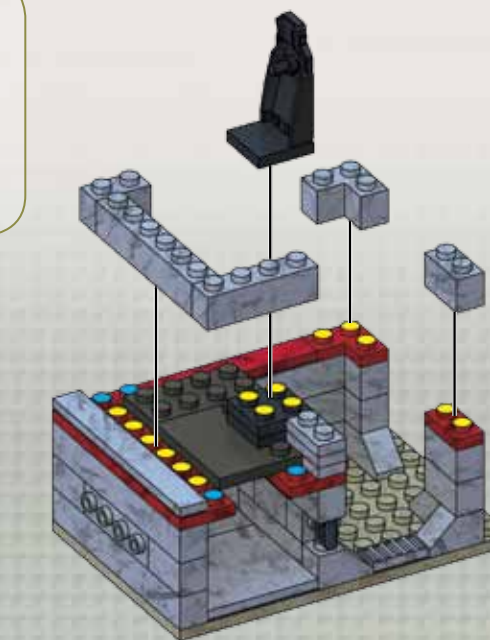
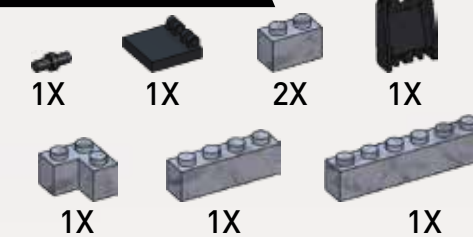

31

1X 1X 1X 3X
1X 1X 1X

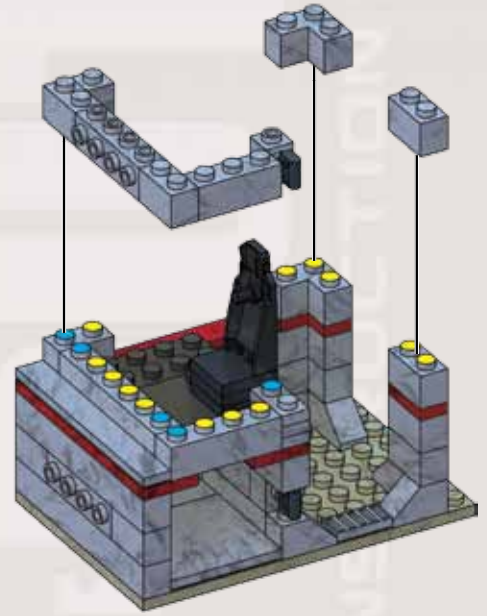

32

1X 2X 1X 4X
1X 1X 2X

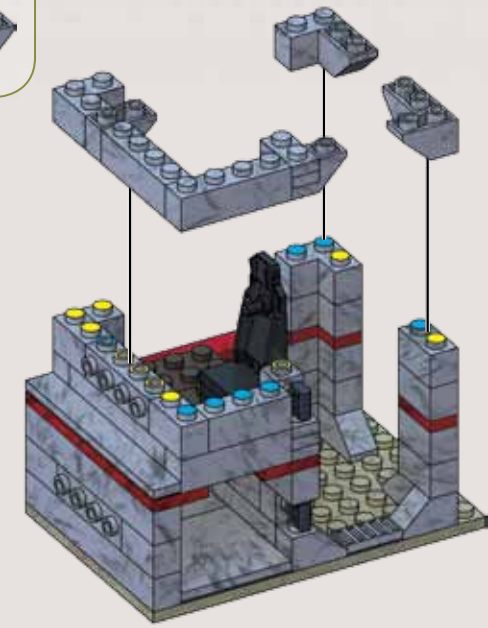
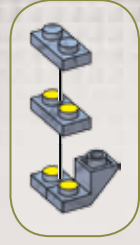

33

2X 1X 1X 1X
1X 1X 1X

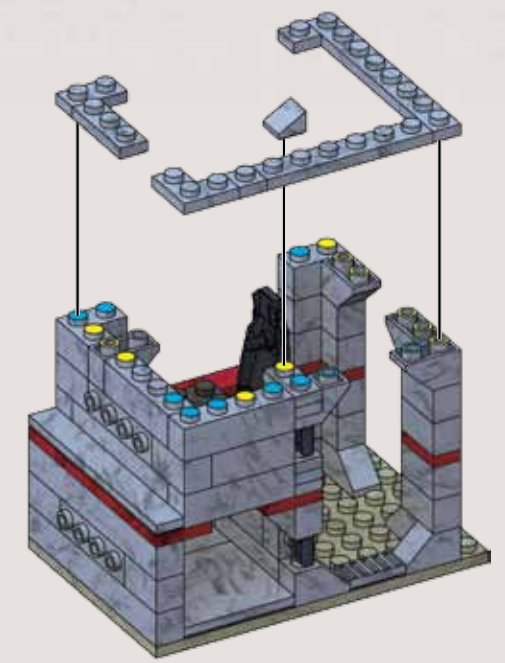

34

1X 1X 1X 2X 1X 1X
1X 1X 1X 2X

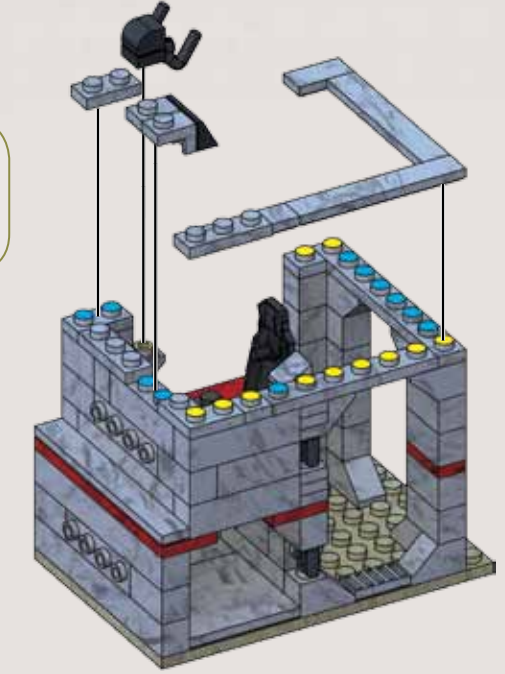

35

2X 1X 3X 2X 3X

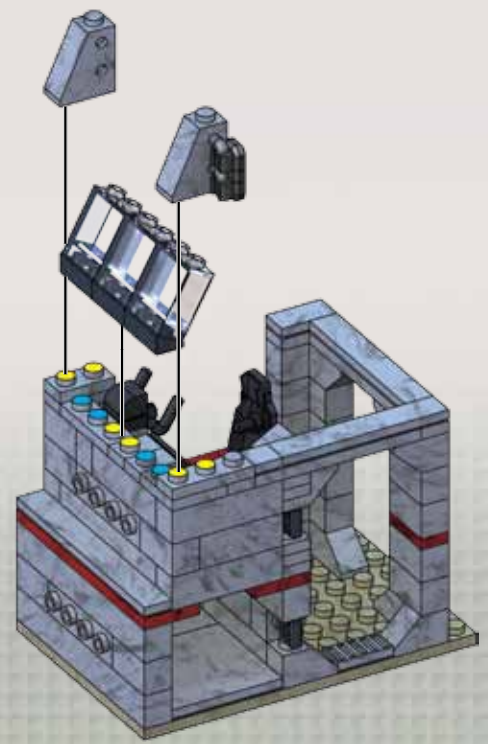
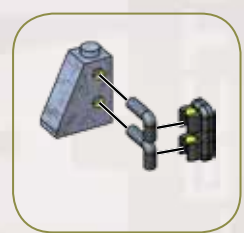

36

2X 1X 2X 1X 2X

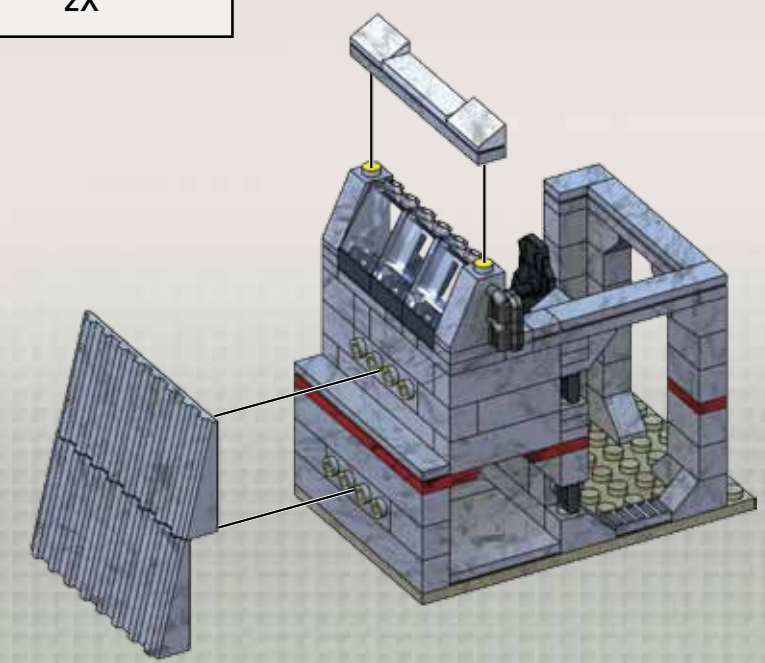
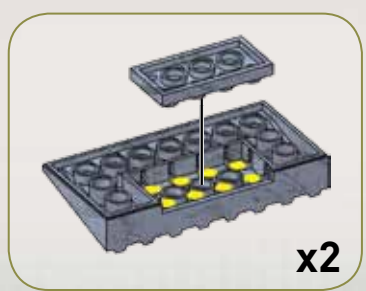
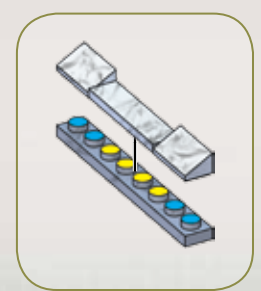



37

- 2X [1x1 Slope]
- 1X [1x2 Slope]
- 2X [1x2 Slope]
- 1X [1x2 Slope]
- 2X [1x2 Slope]
- 2X [1x2 Slope]
- 1X [1x4 Technic Beam]
- 2X [1x4 Technic Beam]
- 1X [1x6 Technic Beam]
- 3X [1x6 Technic Beam]

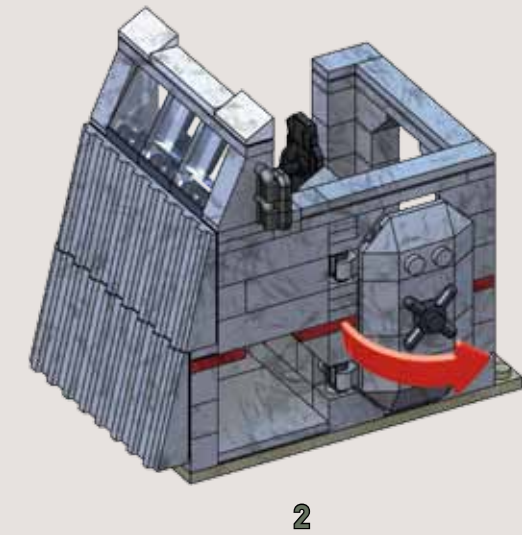
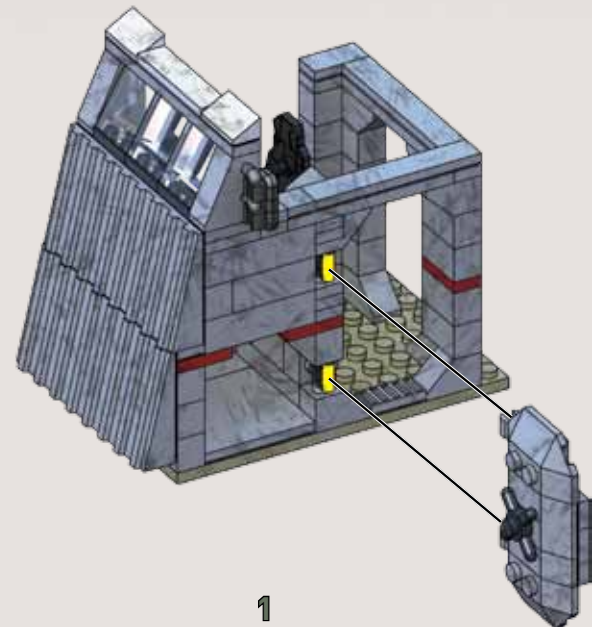
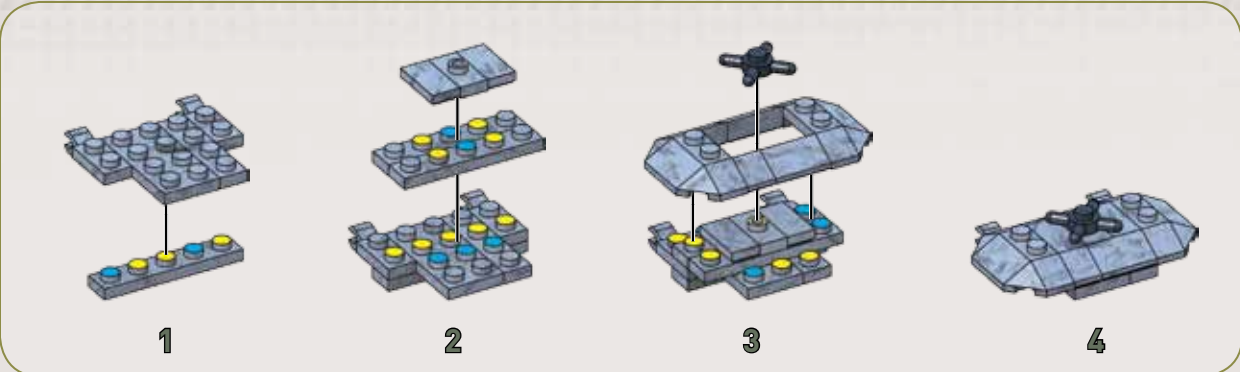

38

- 1X [1x1 Slope]
- 1X [1x2 Slope]
- 1X [1x2 Slope]
- 1X [1x2 Slope]
- 4X [1x1 Slope]
- 1X [1x4 Technic Beam]
- 1X [1x6 Technic Beam]

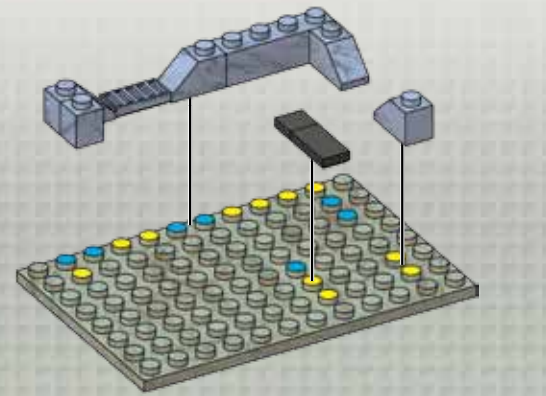

39

- 1X [1x1 Slope]
- 1X [1x2 Slope]
- 1X [1x2 Slope]
- 2X [1x4 Technic Beam]
- 2X [1x6 Technic Beam]

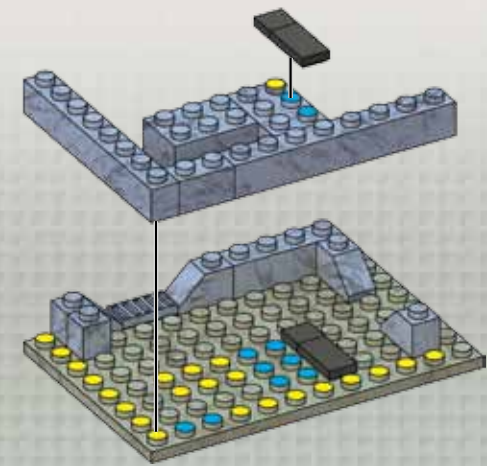

40

- 1X [1x1 Slope]
- 1X [1x2 Slope]
- 1X [1x2 Slope]
- 3X [1x4 Technic Beam]
- 2X [1x6 Technic Beam]
- 2X [1x6 Technic Beam]
- 1X [1x6 Technic Beam]
- 1X [1x6 Technic Beam]

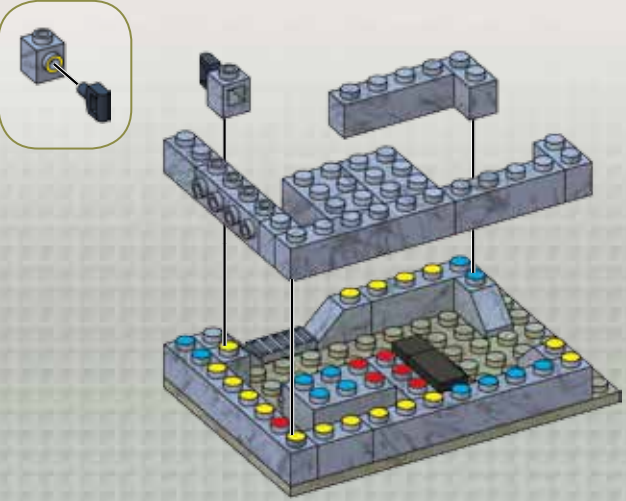

41

- 1X [1x1 Slope]
- 1X [1x2 Slope]
- 2X [1x4 Technic Beam]
- 1X [1x4 Technic Beam]
- 2X [1x6 Technic Beam]

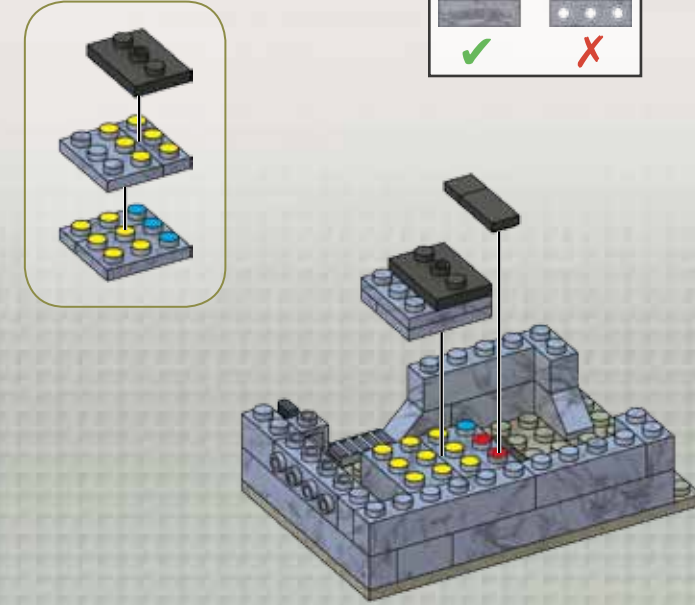
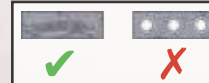

42

2X 2X 1X
1X 1X 2X

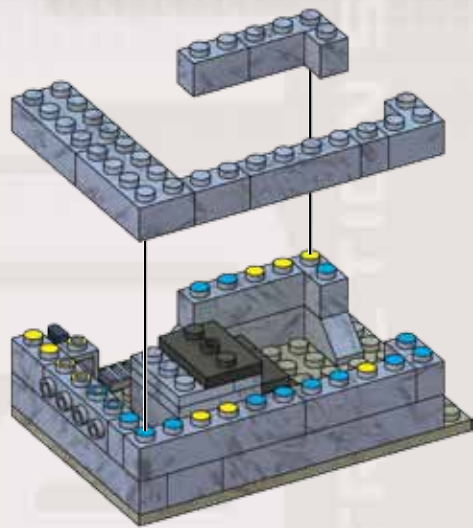

43

2X 1X
1X 1X

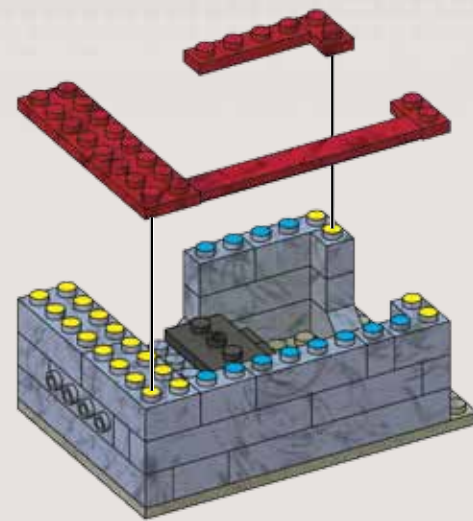

44

1X 1X 1X 1X
1X 1X

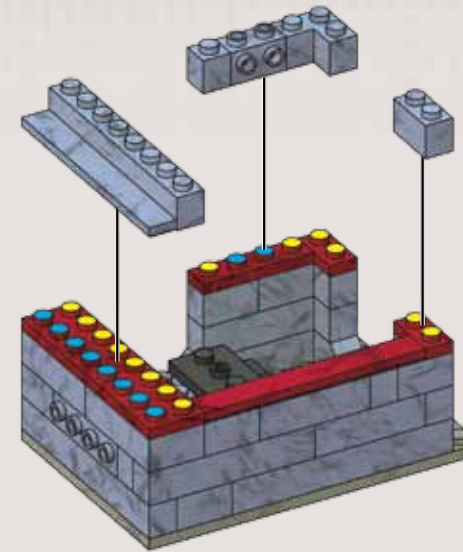

45

1X 1X 3X
1X 1X

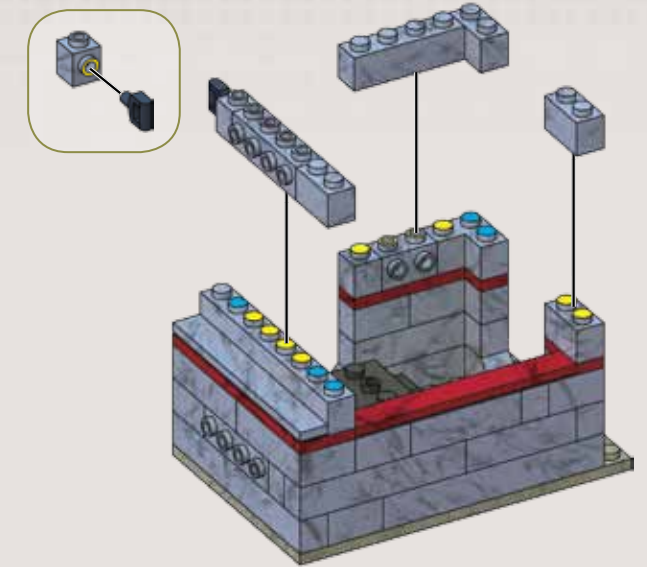

46

1X 2X 3X 1X 1X 1X 1X

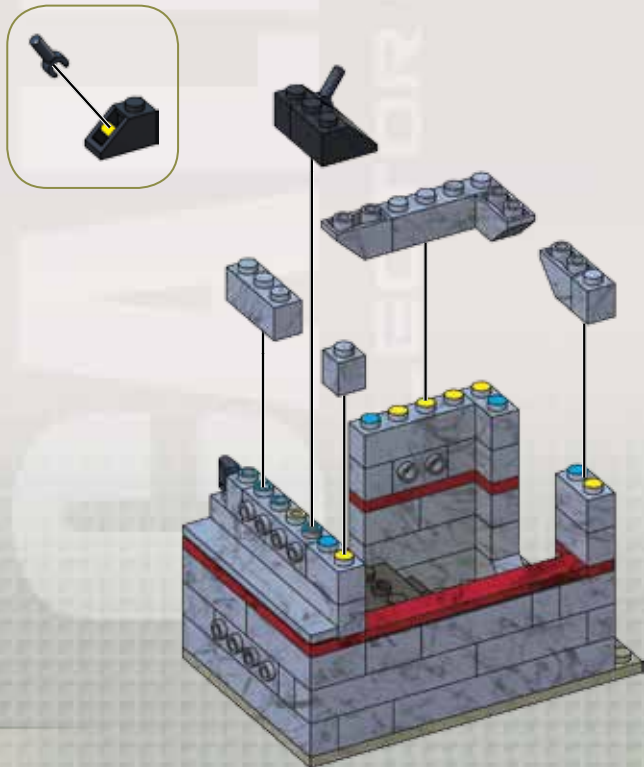

47

2X 1X
2X 1X

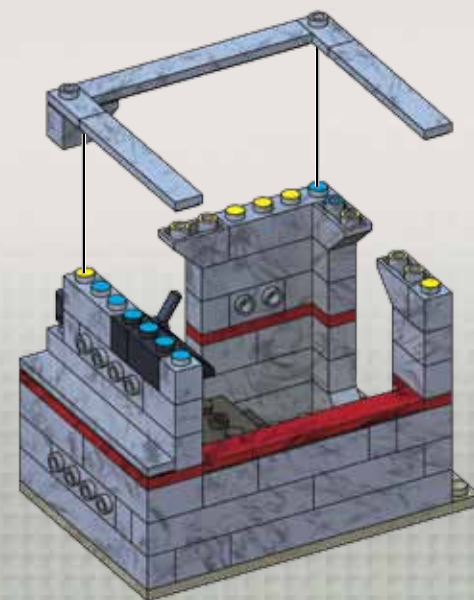
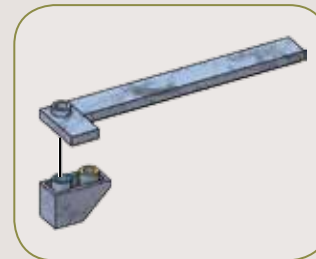

48

2X 1X 2X

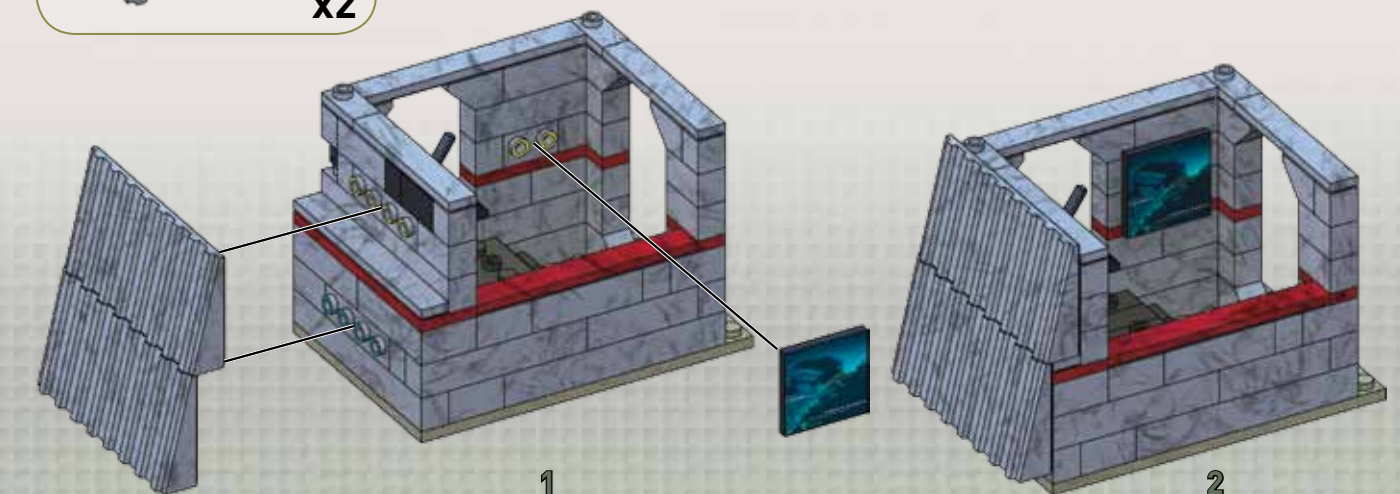
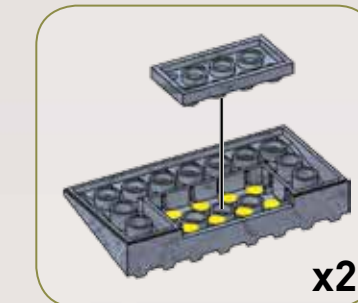



49

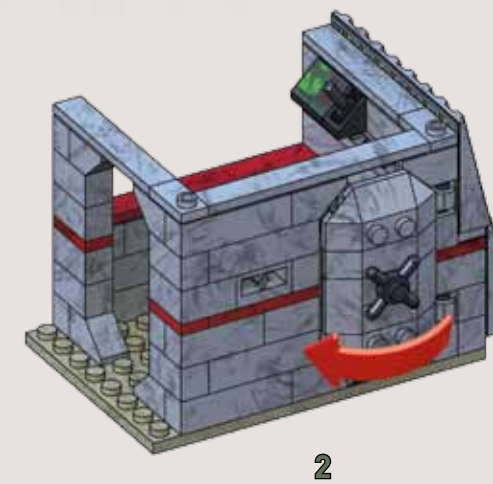
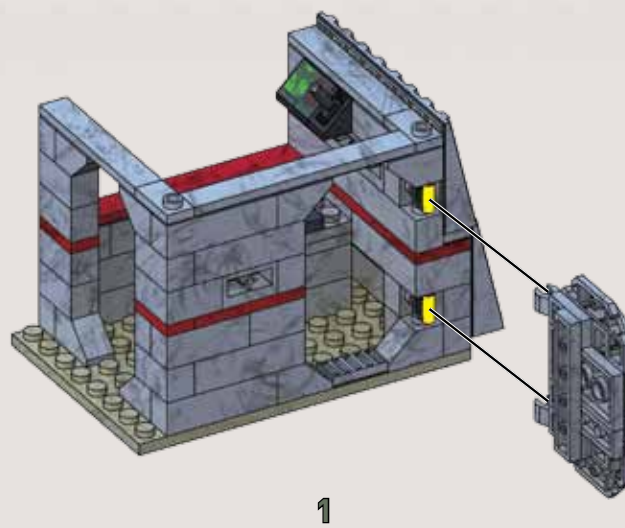
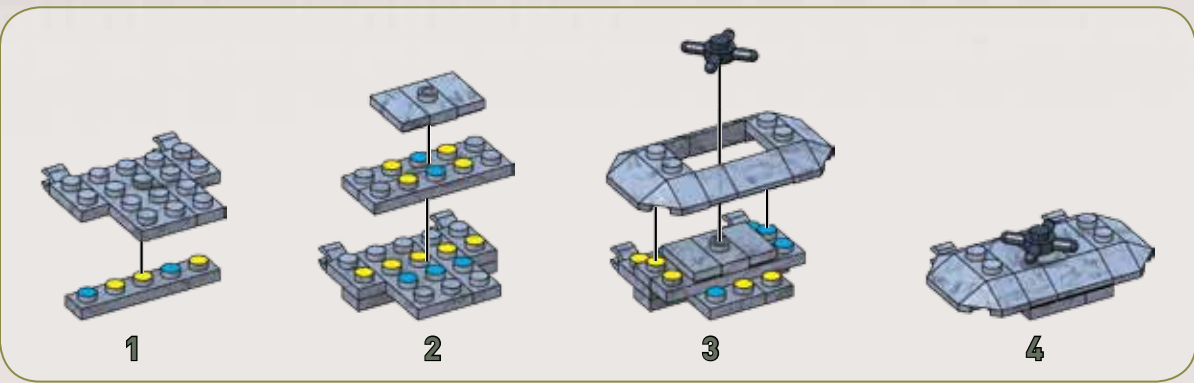
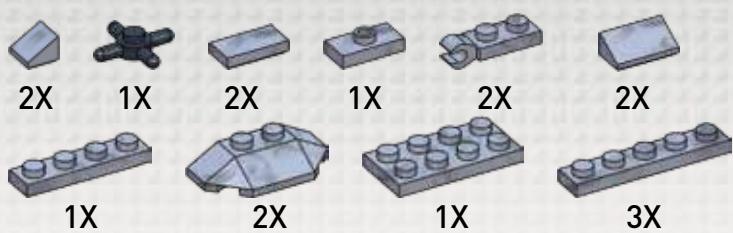

50

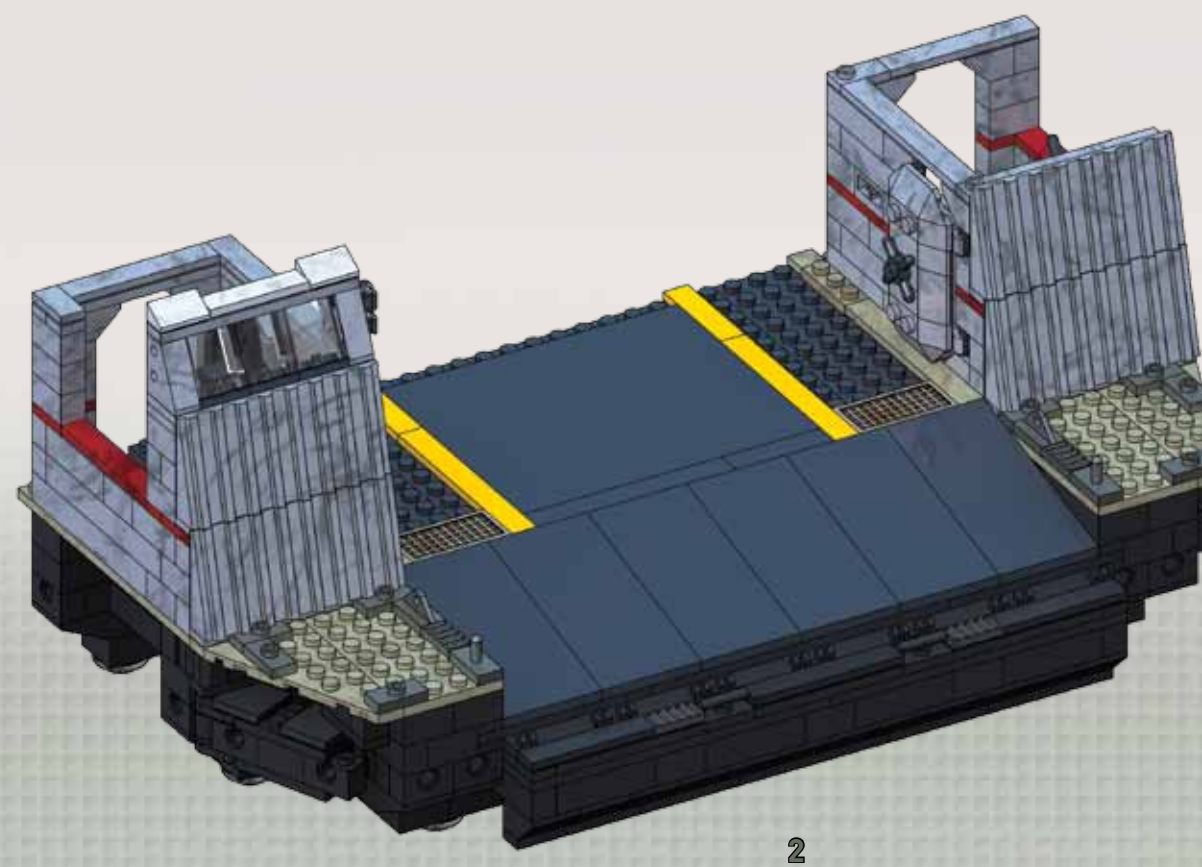
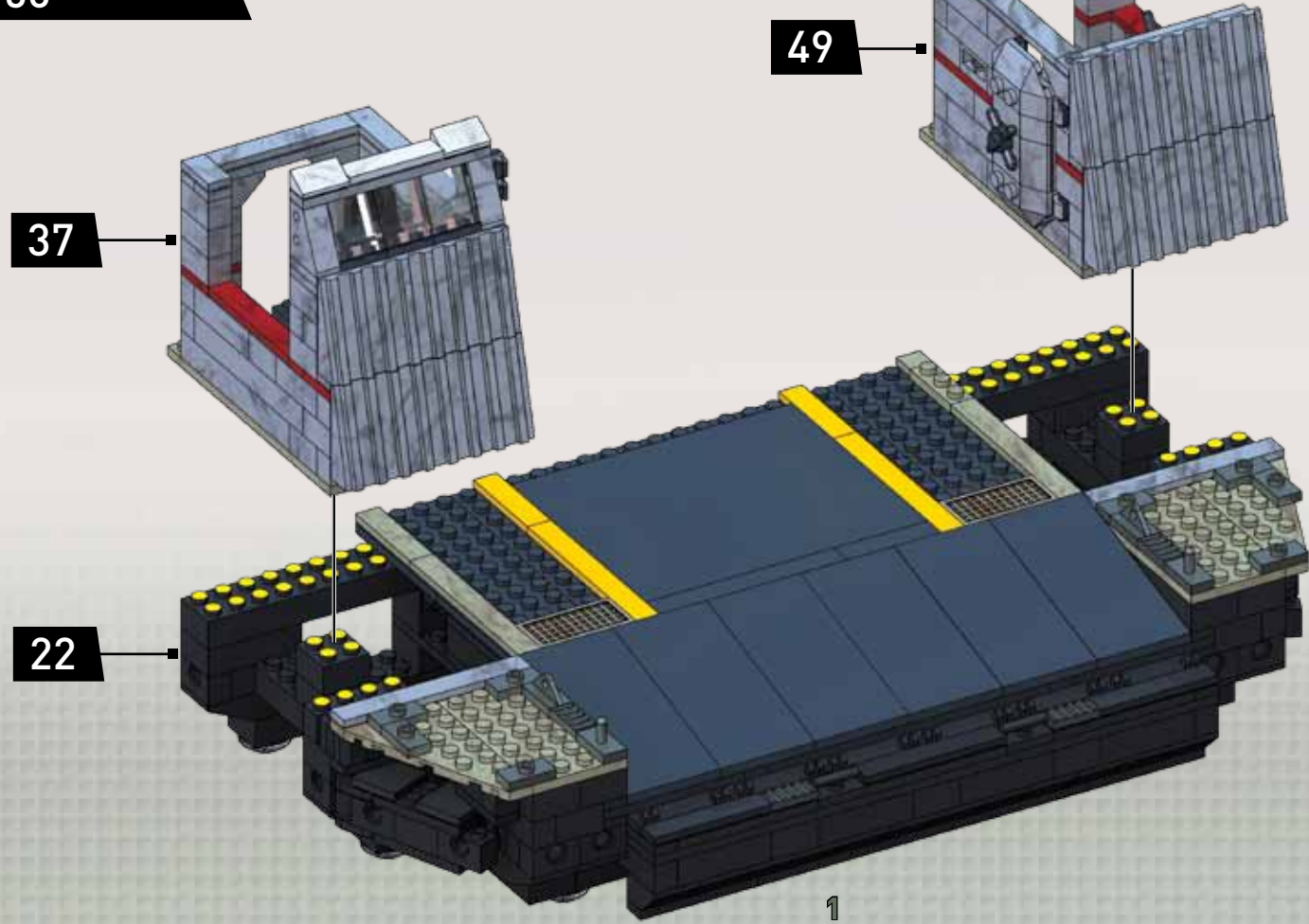

51

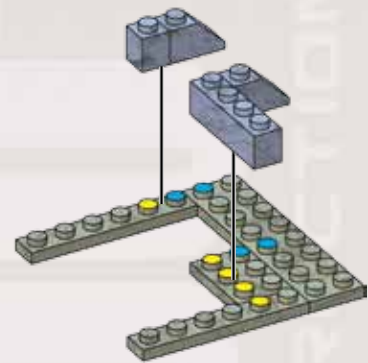
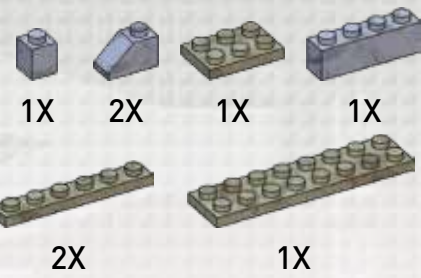

52

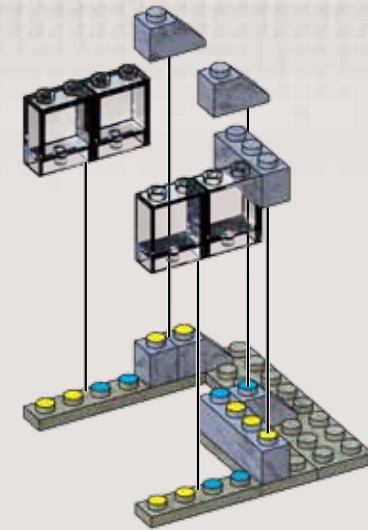
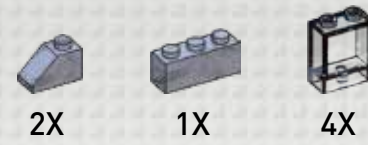

53

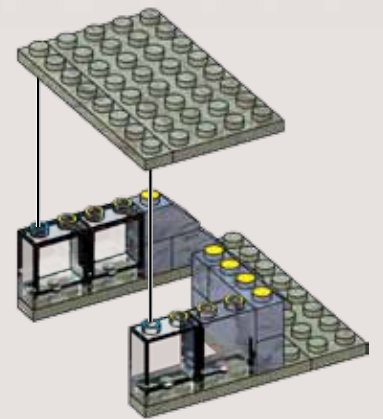
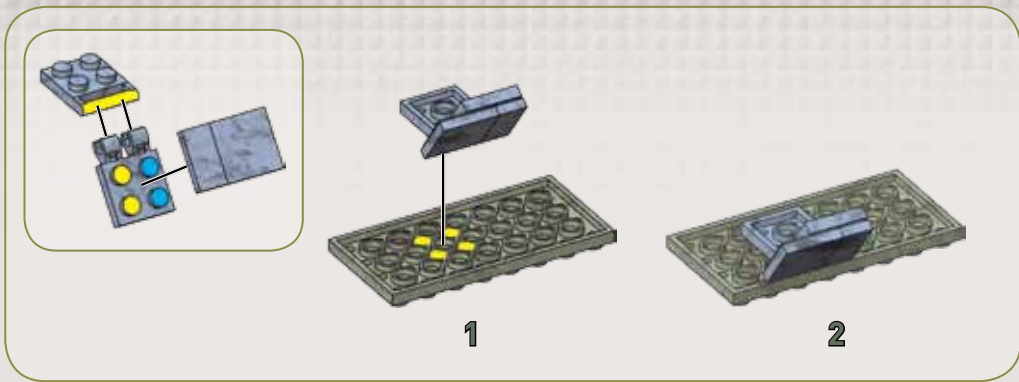
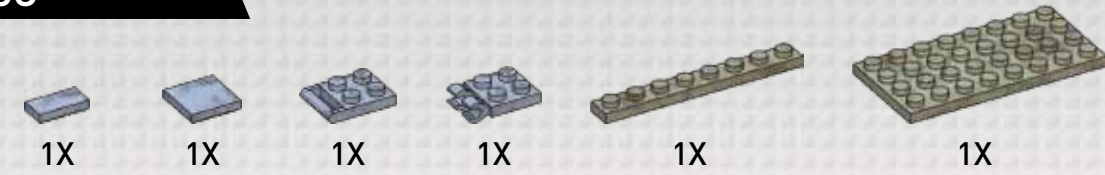

54

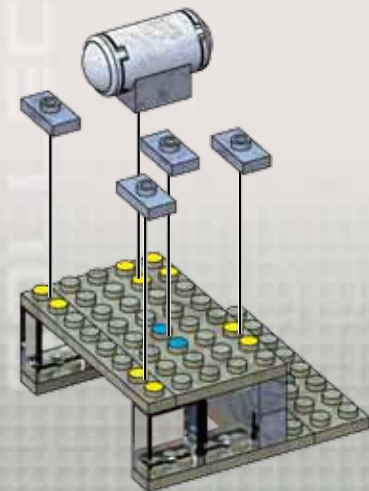
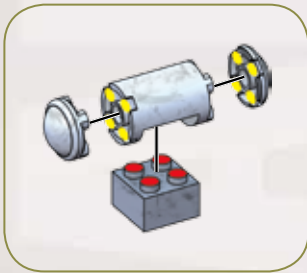

55

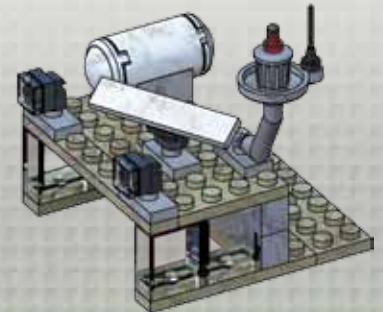
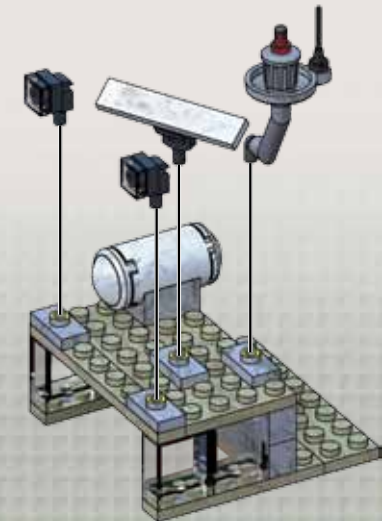
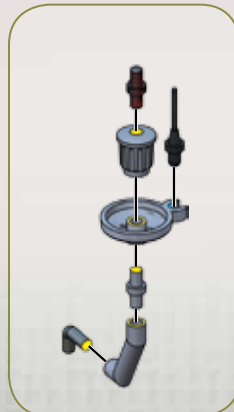
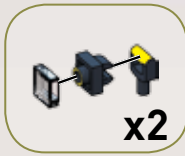
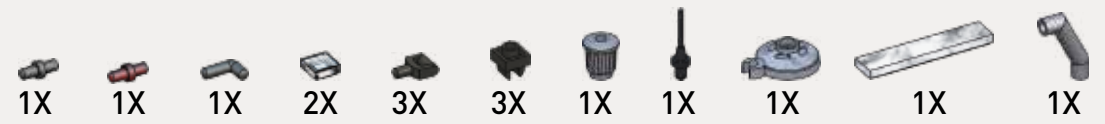



56

1X 1X 1X

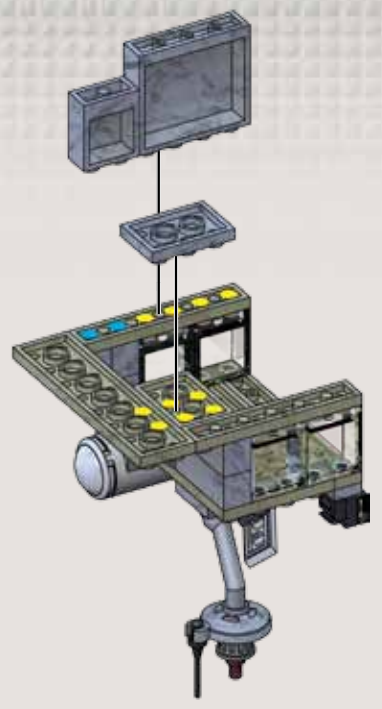

57

1X 2X

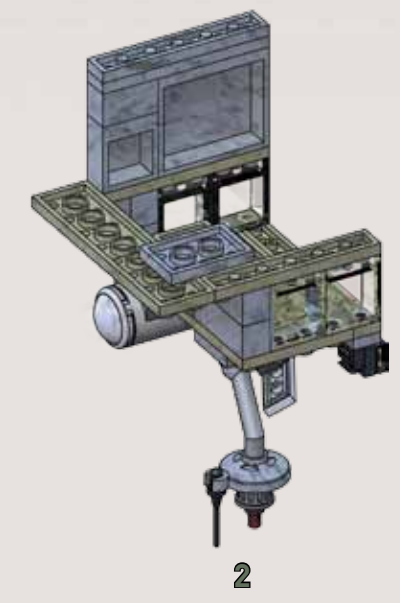
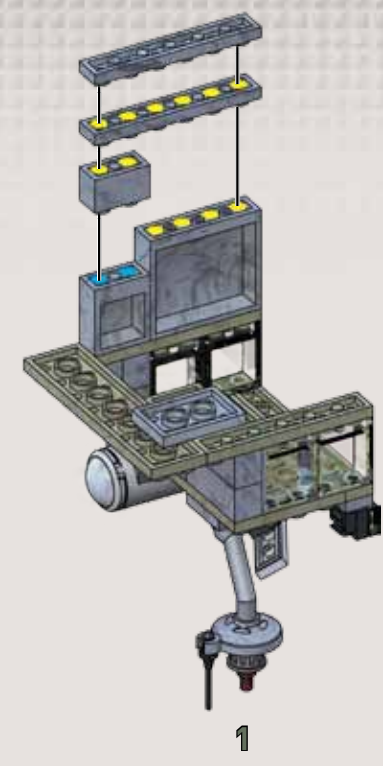

58

2X 2X 1X 2X

1X 1X

2X 1X

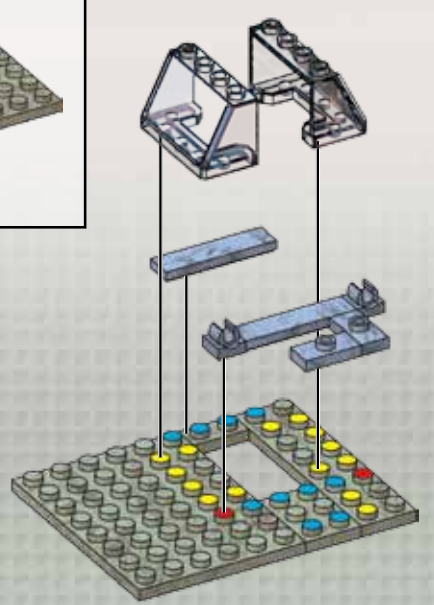

59

1X 1X 1X 1X 1X 1X 1X 2X 1X

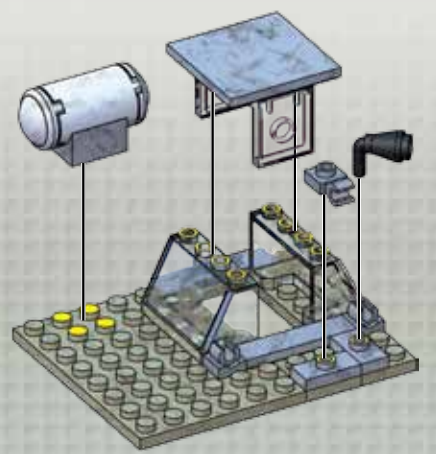
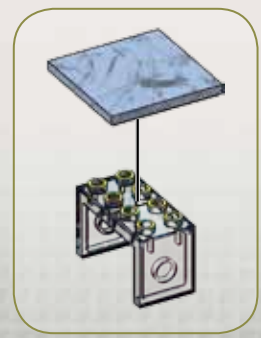
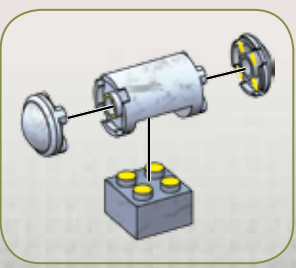

60

3X 3X 3X

X ✓

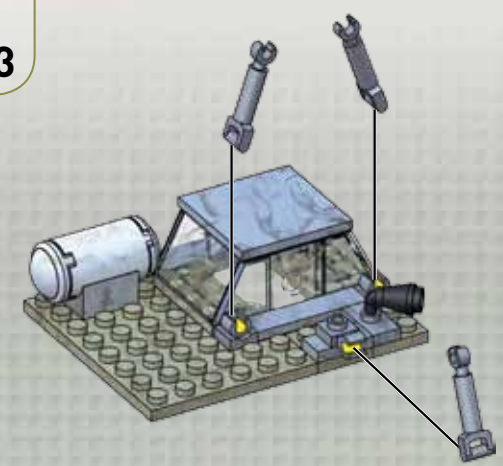
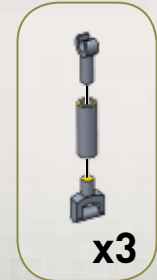

61

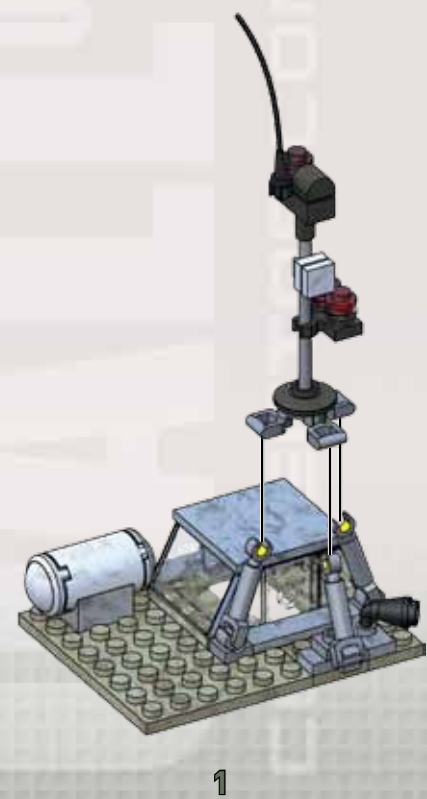
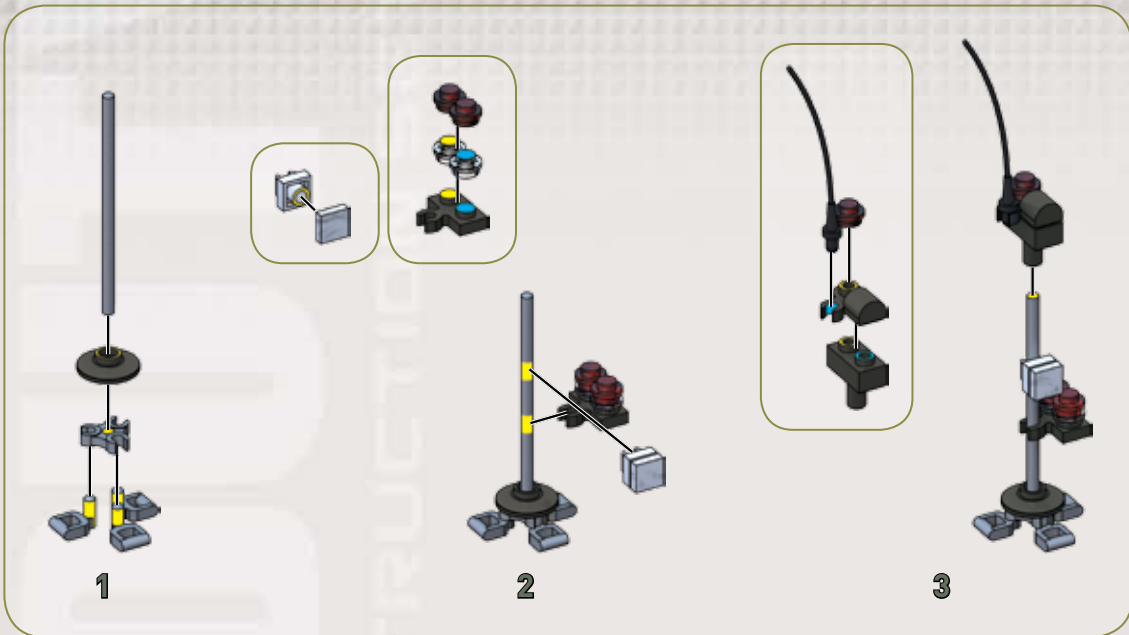

62

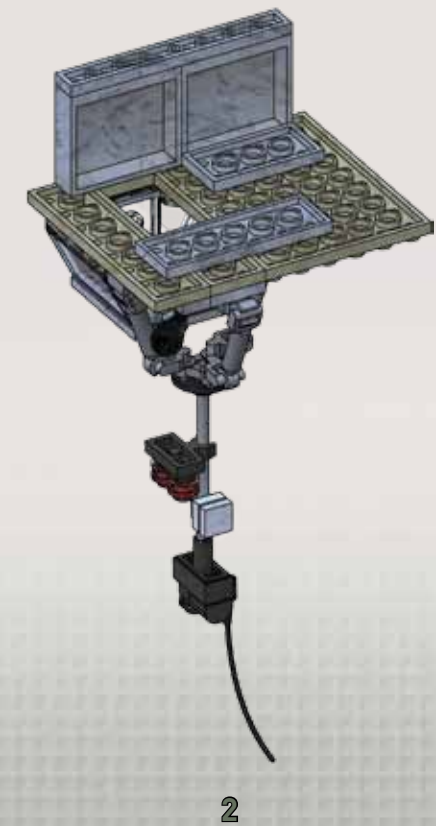
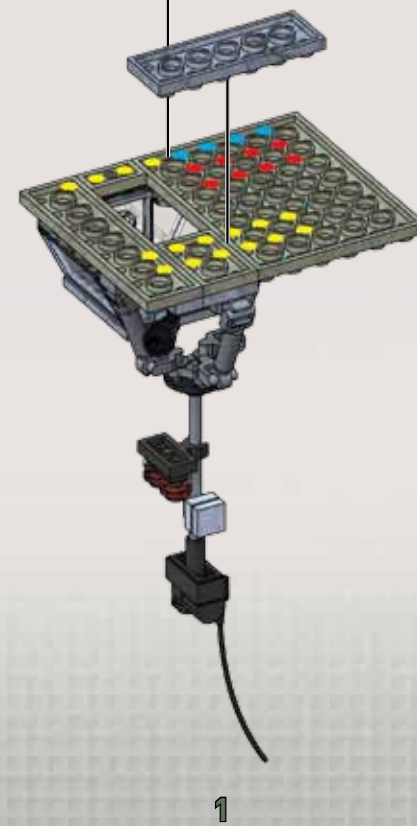
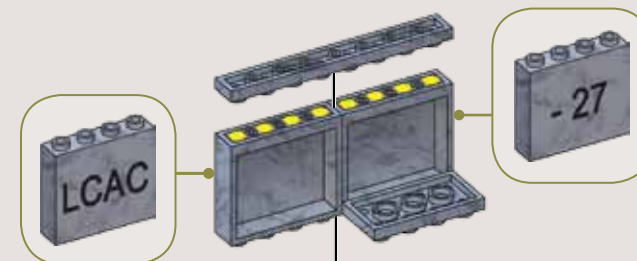
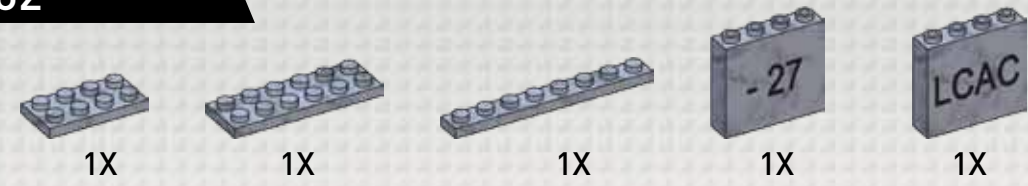



63



1X

64

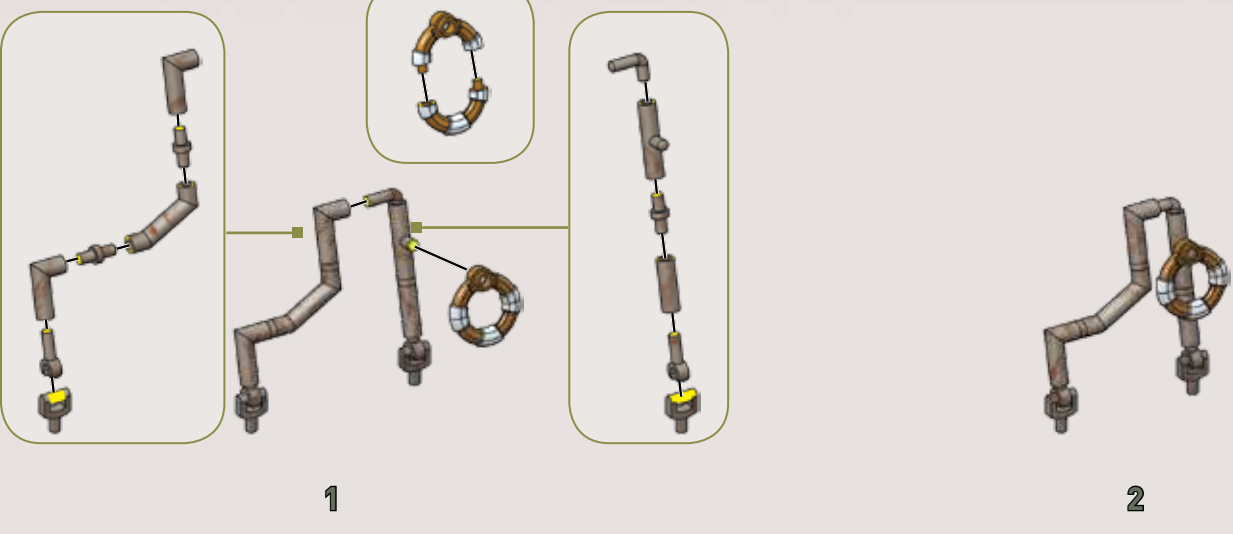
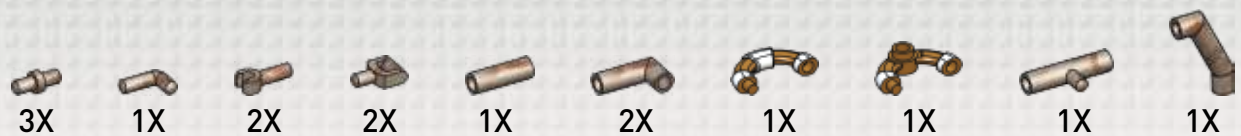

65

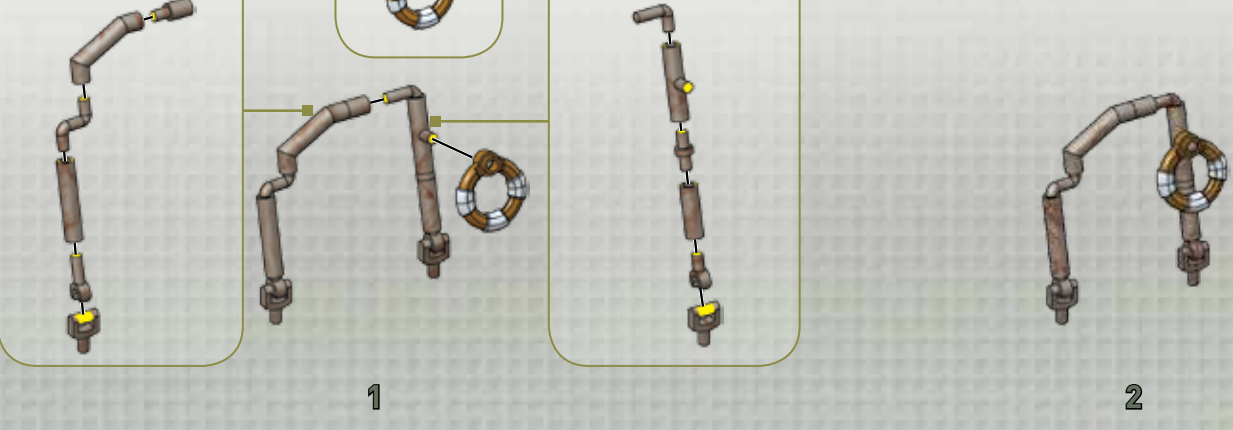
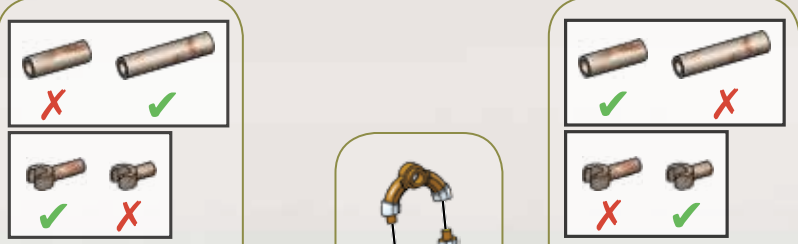
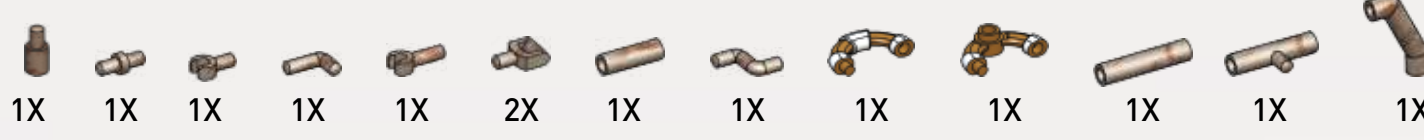

57

62

50

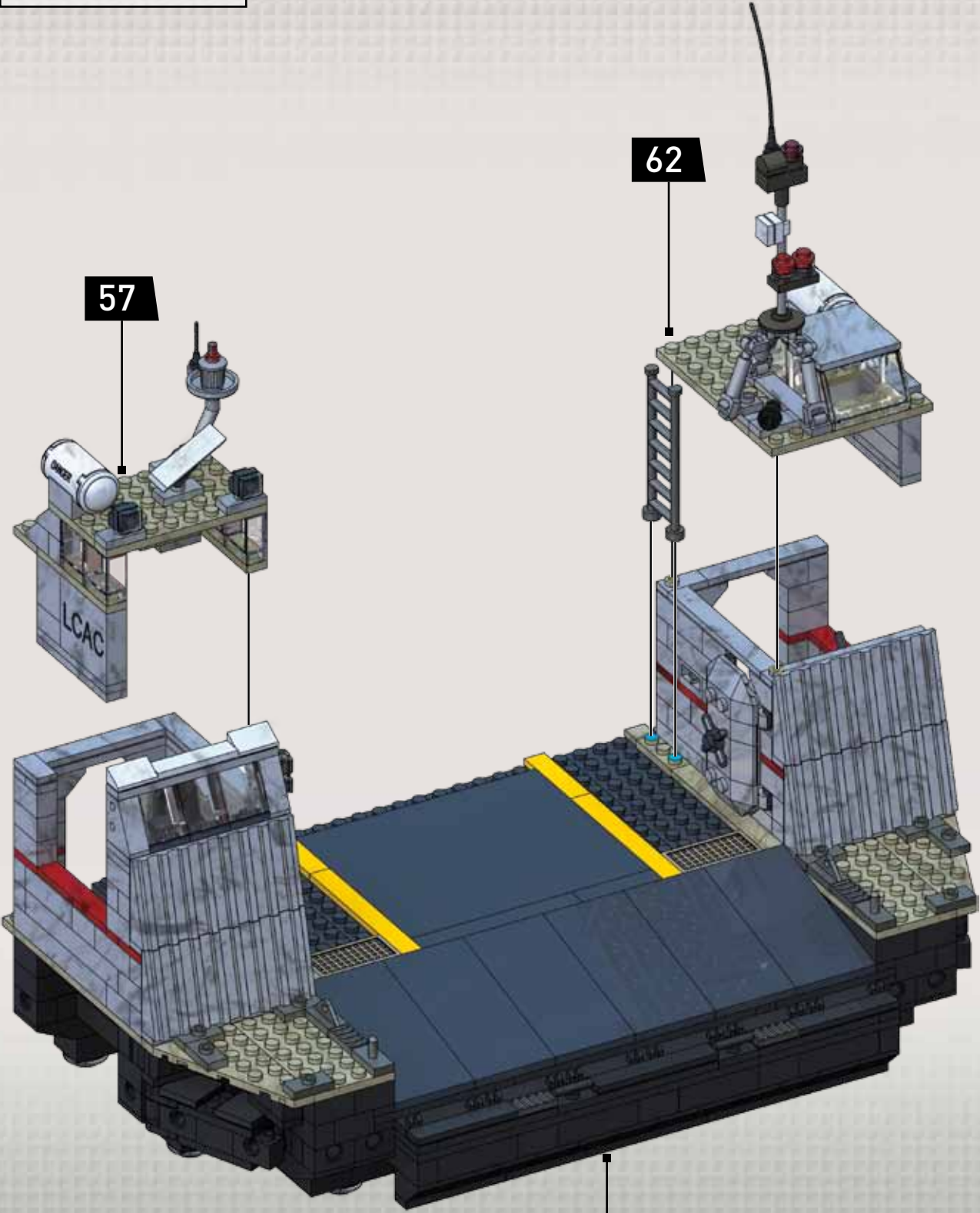



- 4X
- 4X
- 4X
- 6X
- 4X
- 2X
- 4X

x2

1

2

3

x2

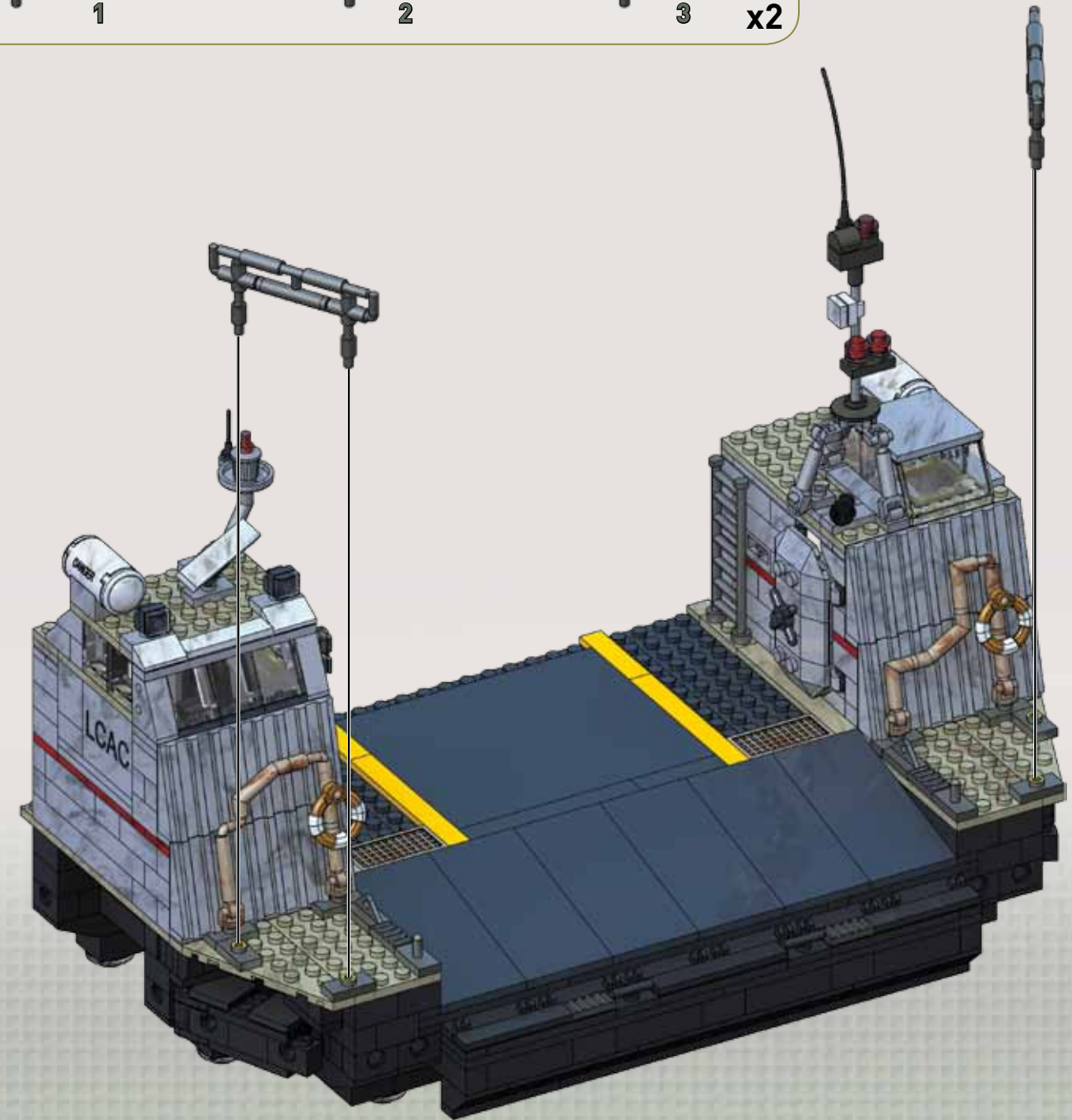

68

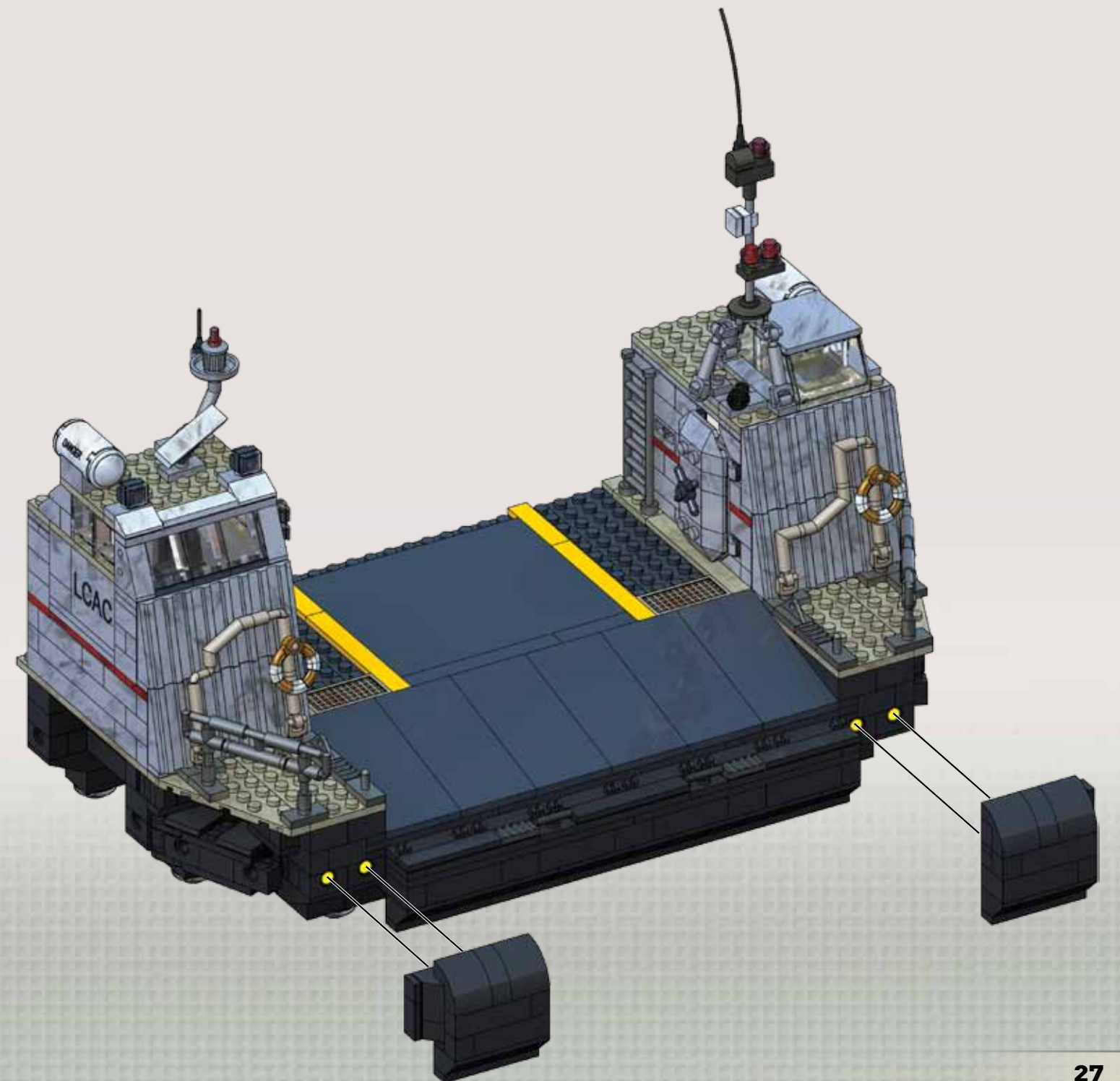
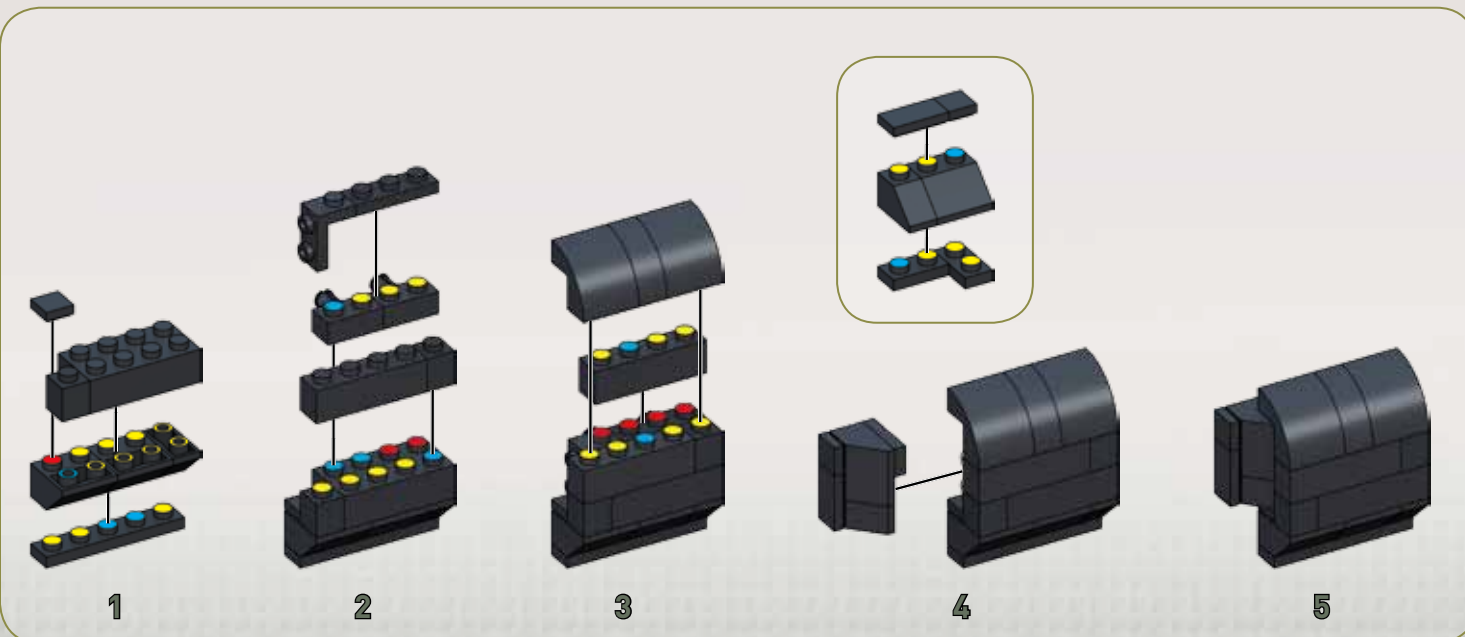
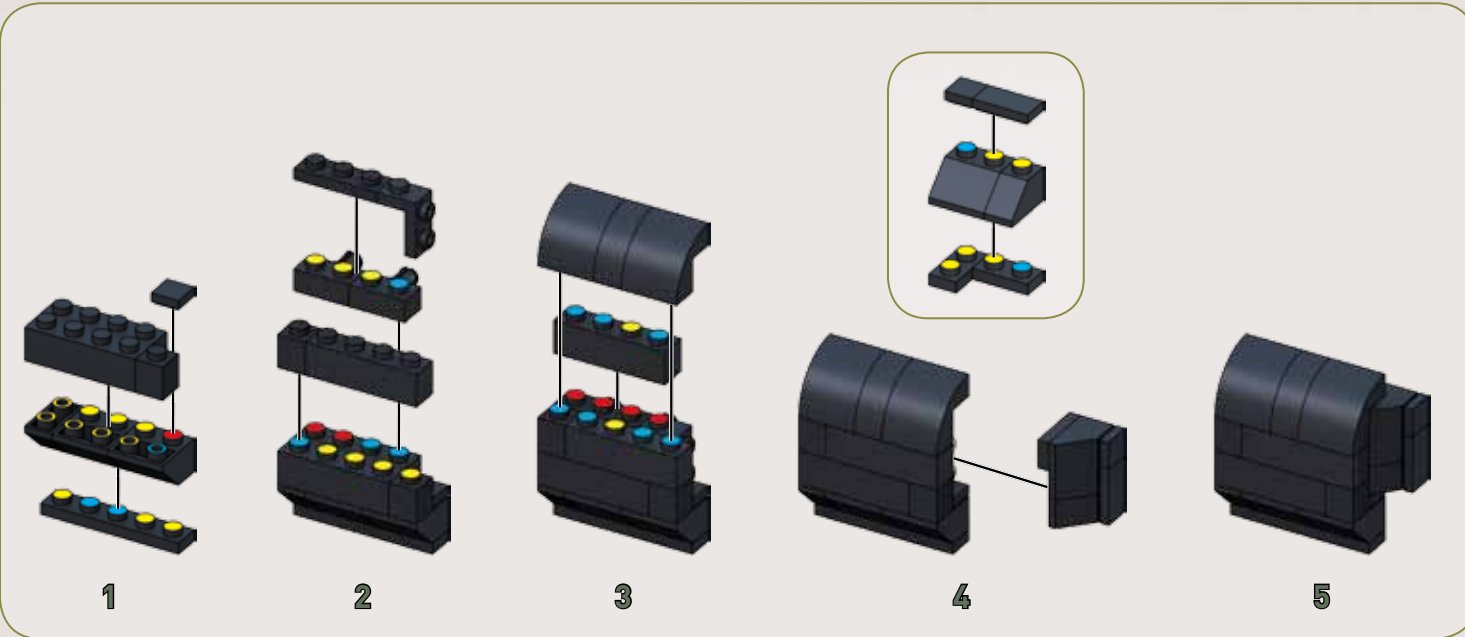

1

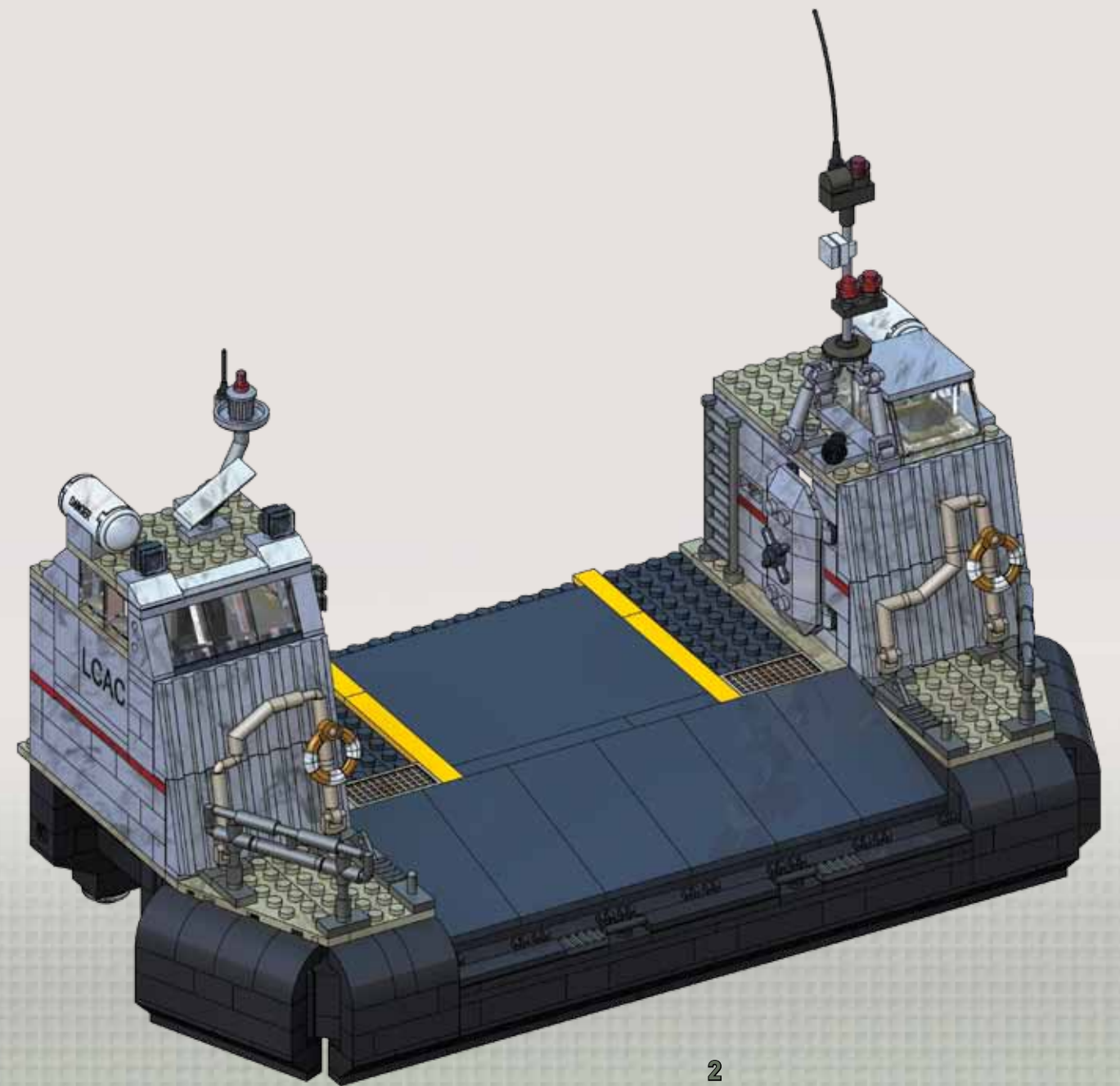
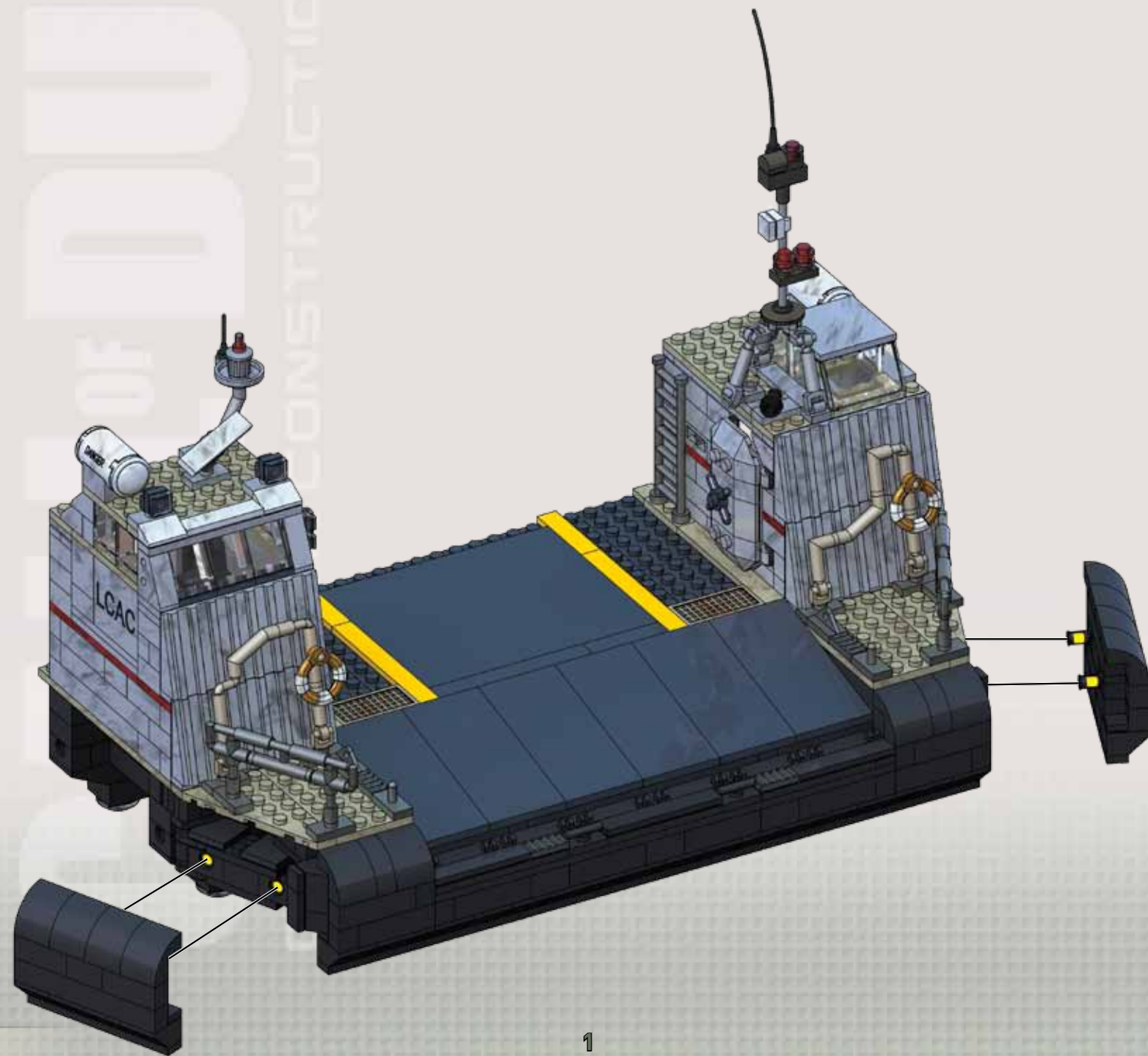
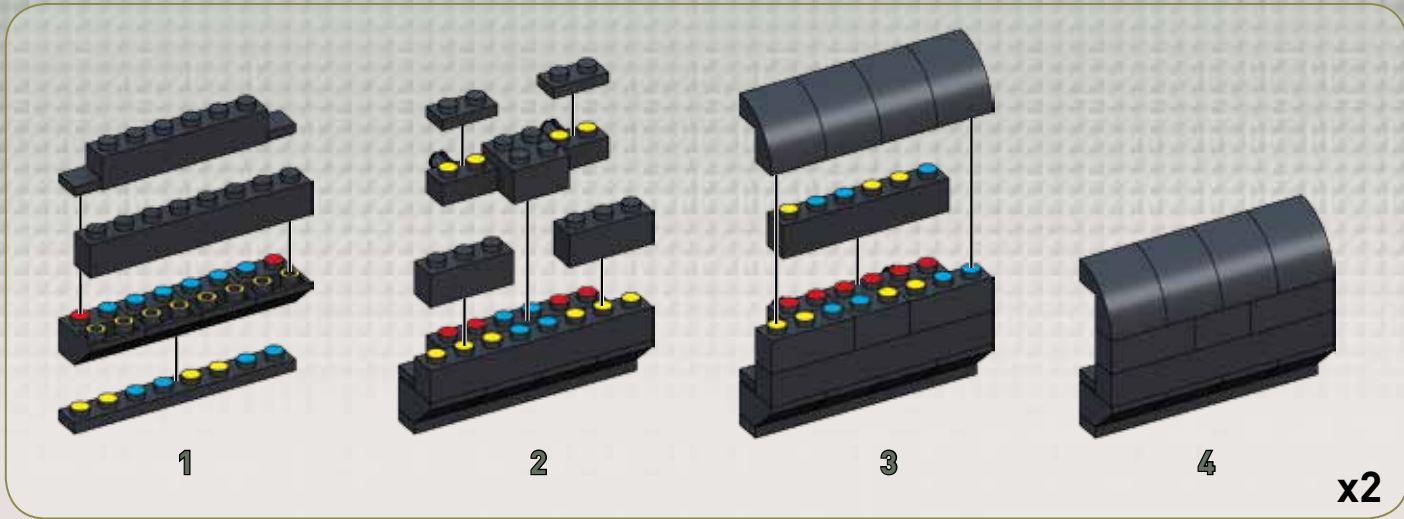



70

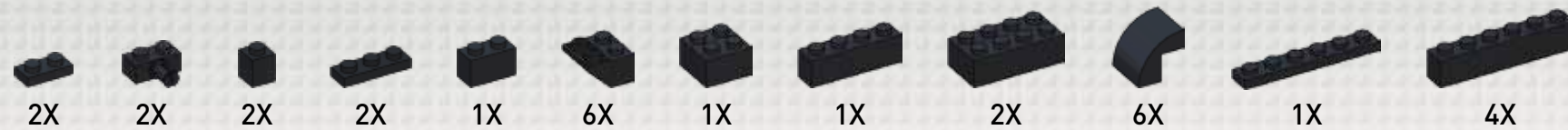

1



2

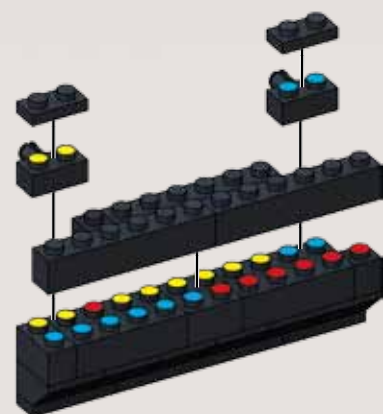

3

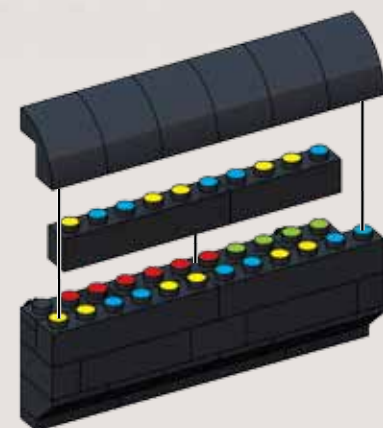

4

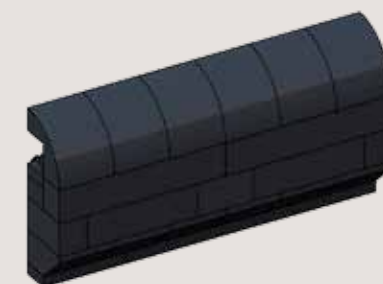

5

71

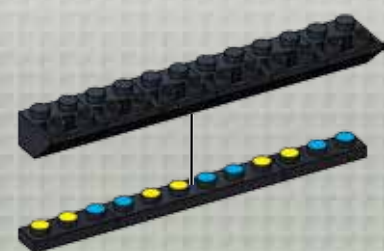

1

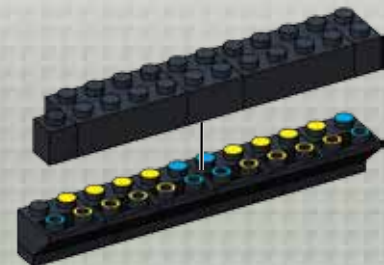

2

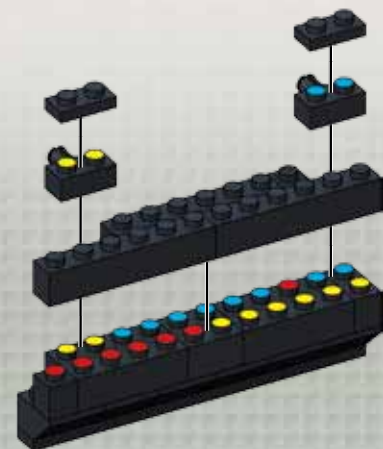

3

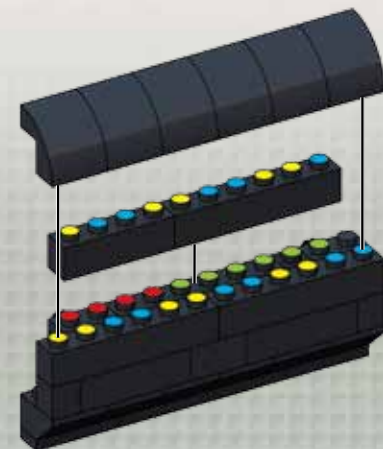

4



5



6X

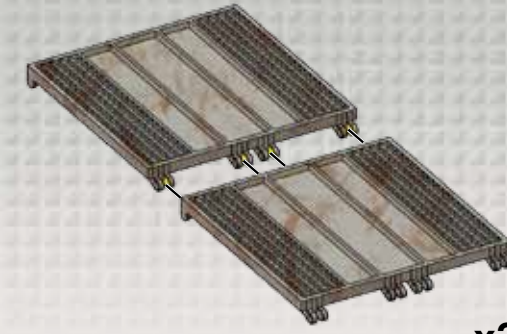

x3

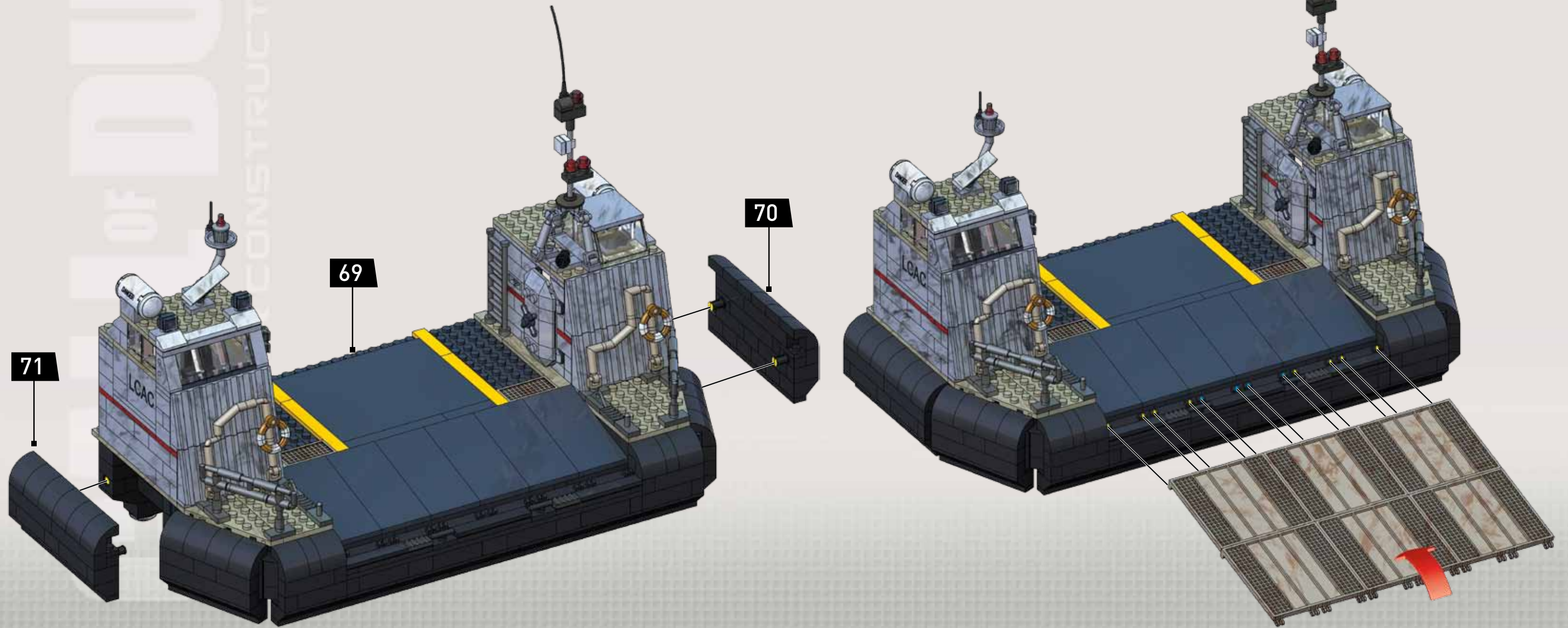



74



2X

2X



2X



2X

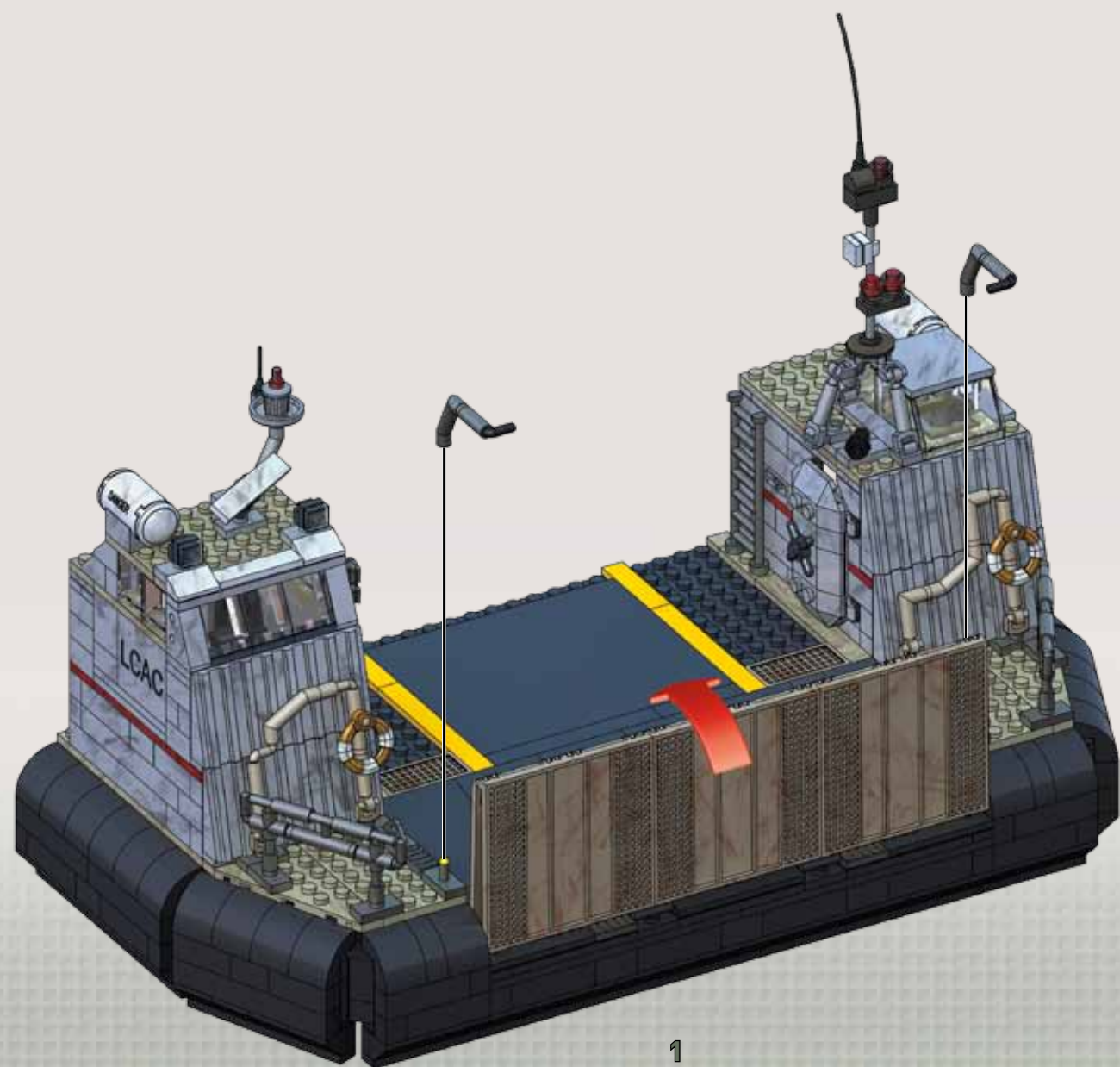

1

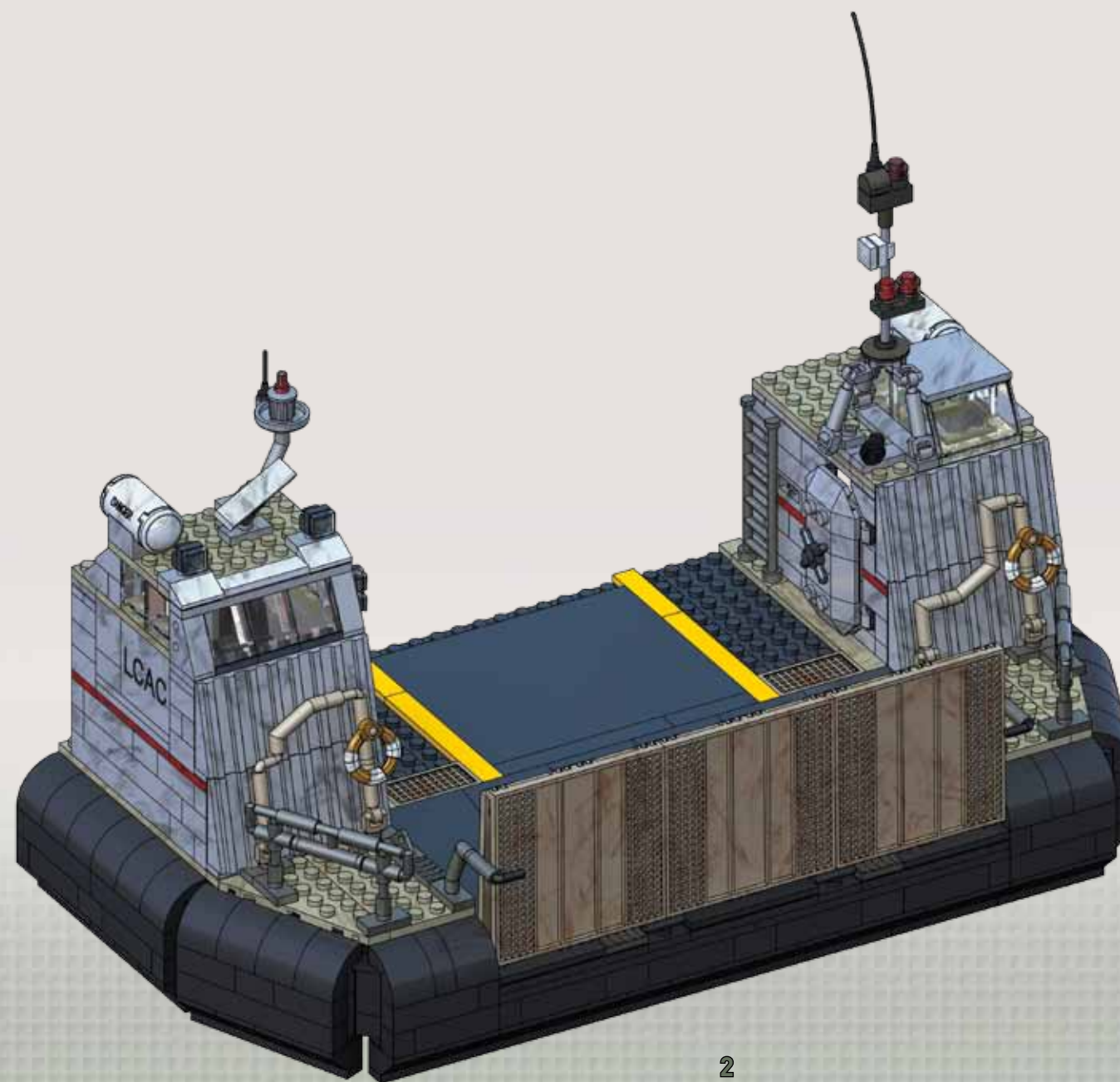

2

LCAC-2745138 

2

Section • Sección • Section
Abschnitt • Sectie • Sezione • Secção

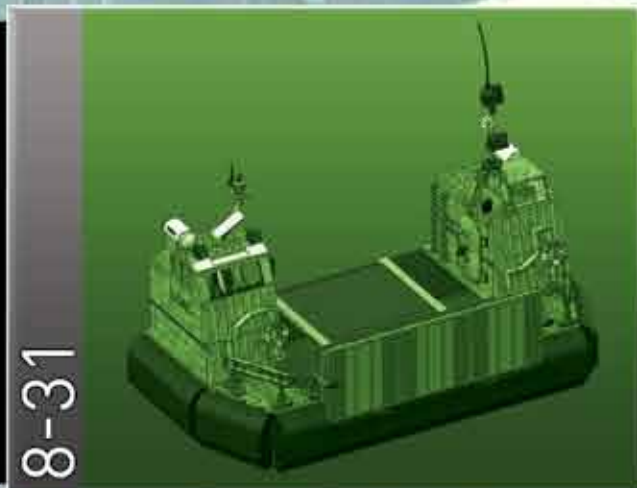

8-31

1

Section • Sección • Section
Abschnitt • Sectie • Sezione • Secção

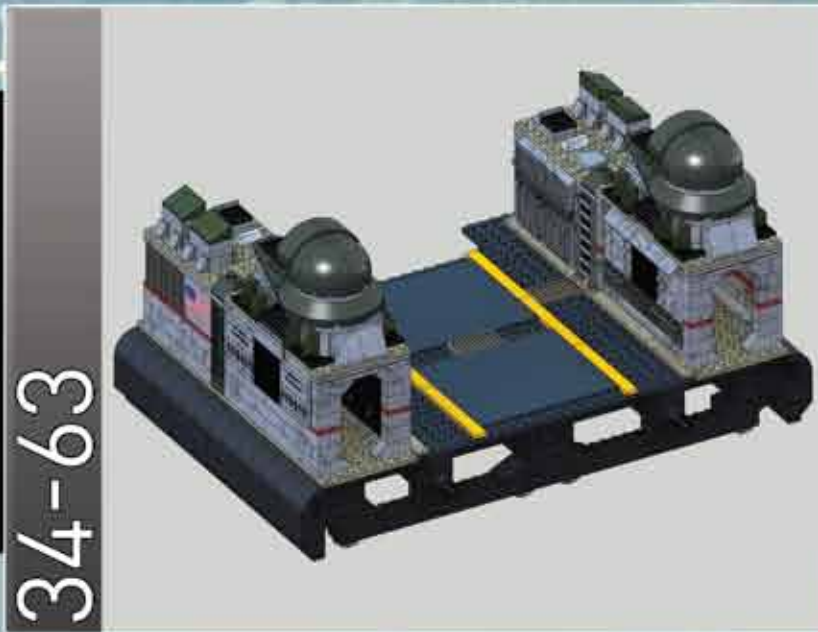

34-63

2

Section • Sección • Section
Abschnitt • Sectie • Sezione • Secção



66-79

3

Section • Sección • Section
Abschnitt • Sectie • Sezione • Secção



82-86

4

Section • Sección • Section
Abschnitt • Sectie • Sezione • Secção



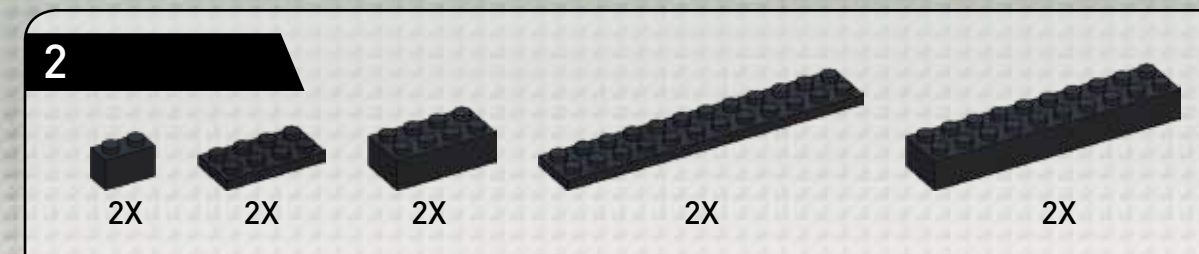
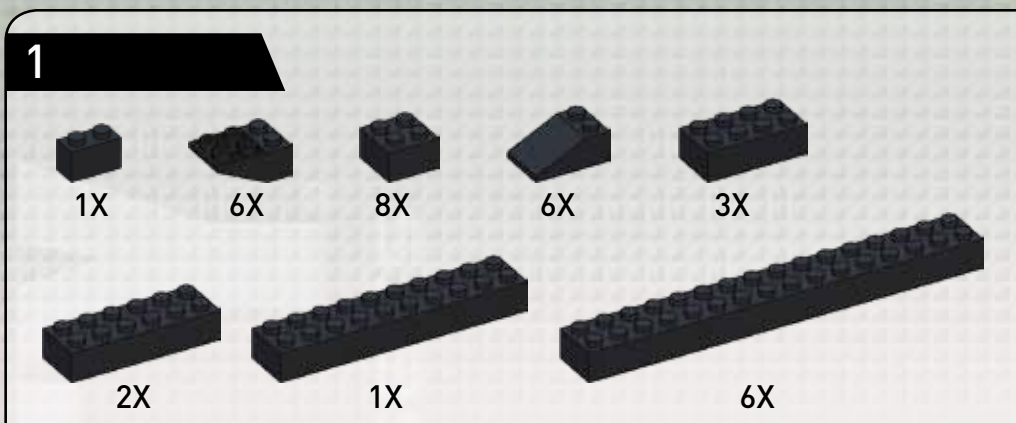

2

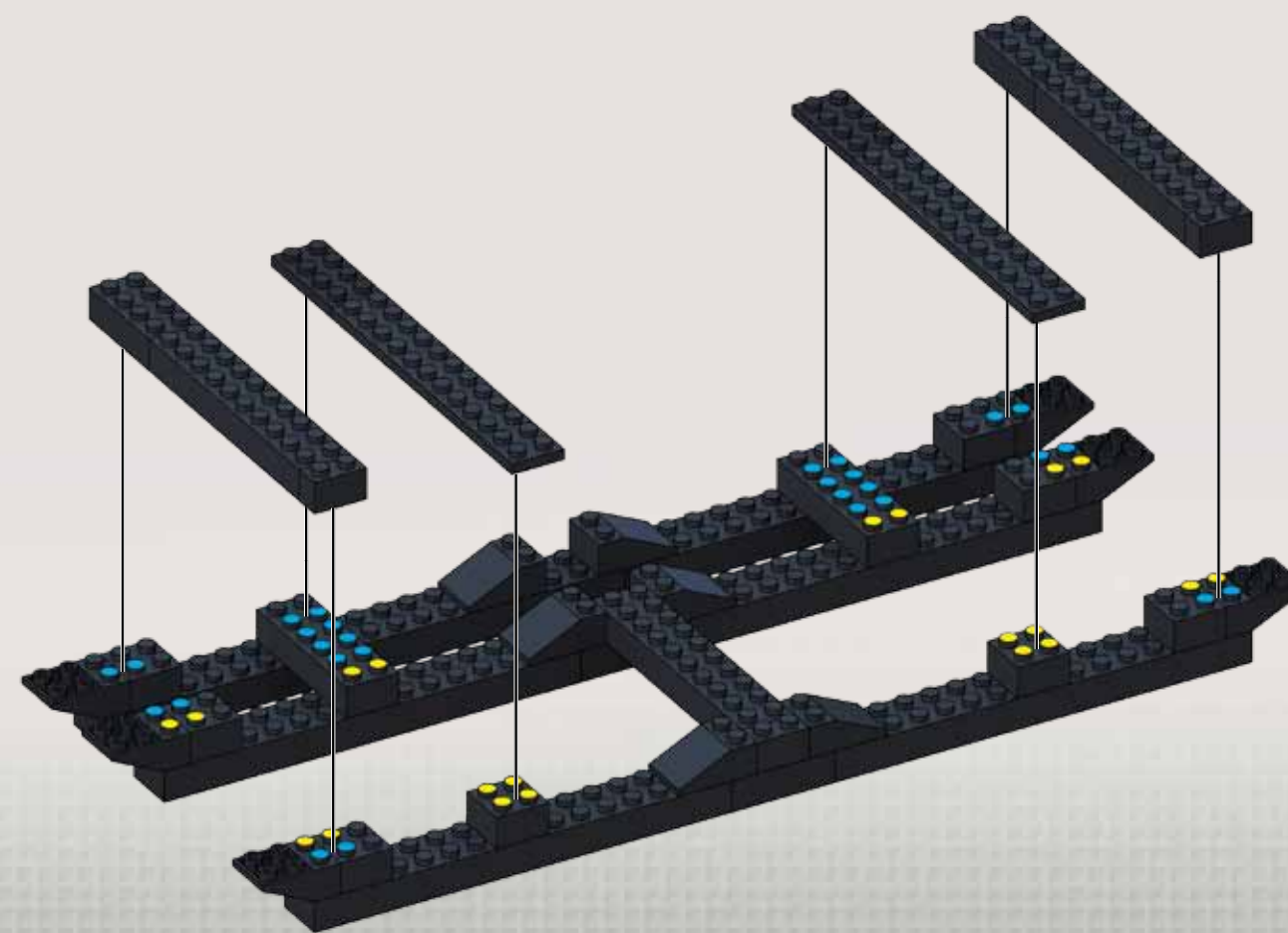
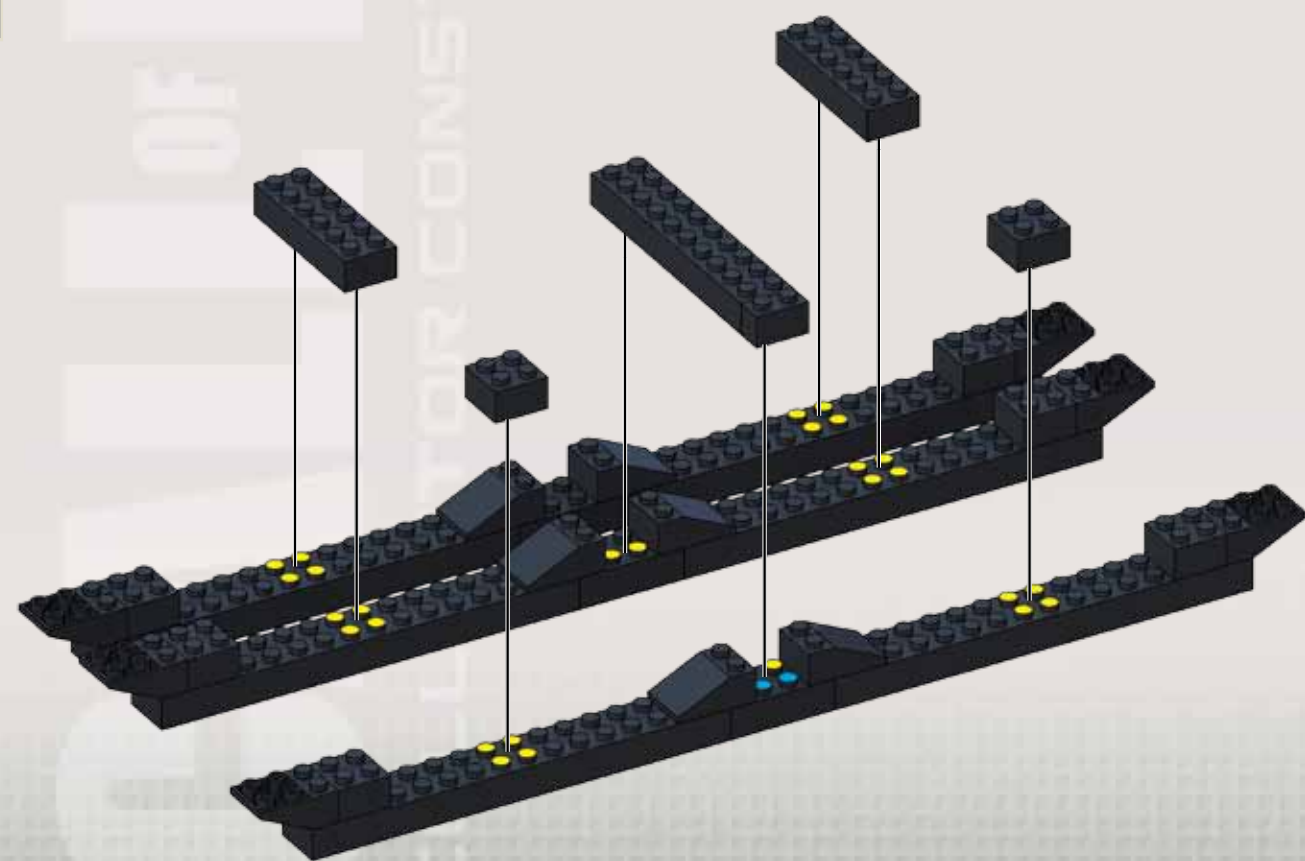
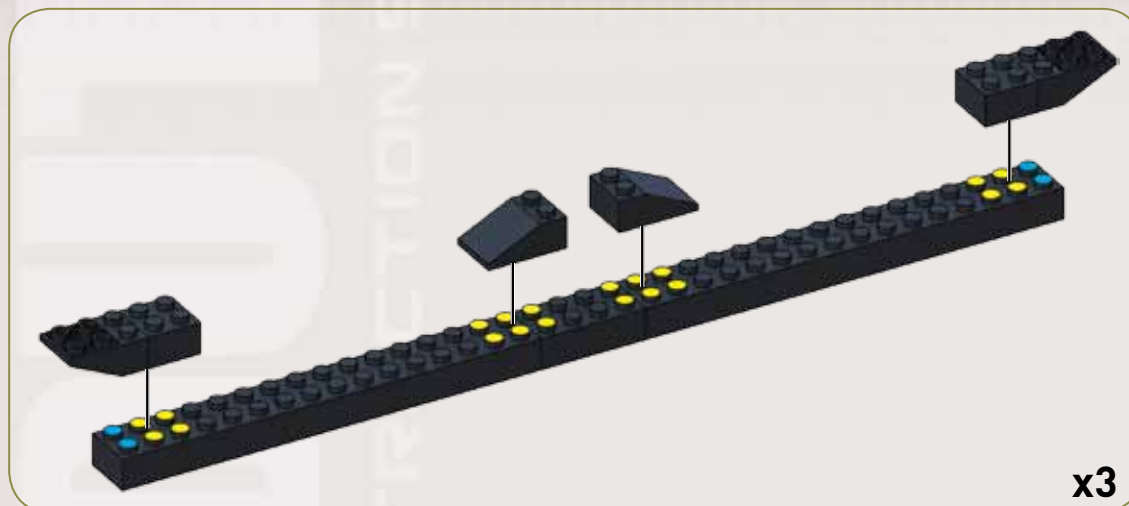

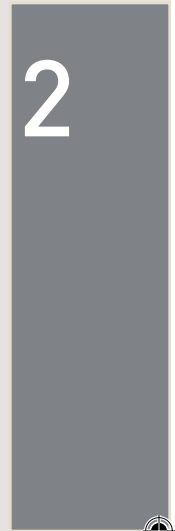
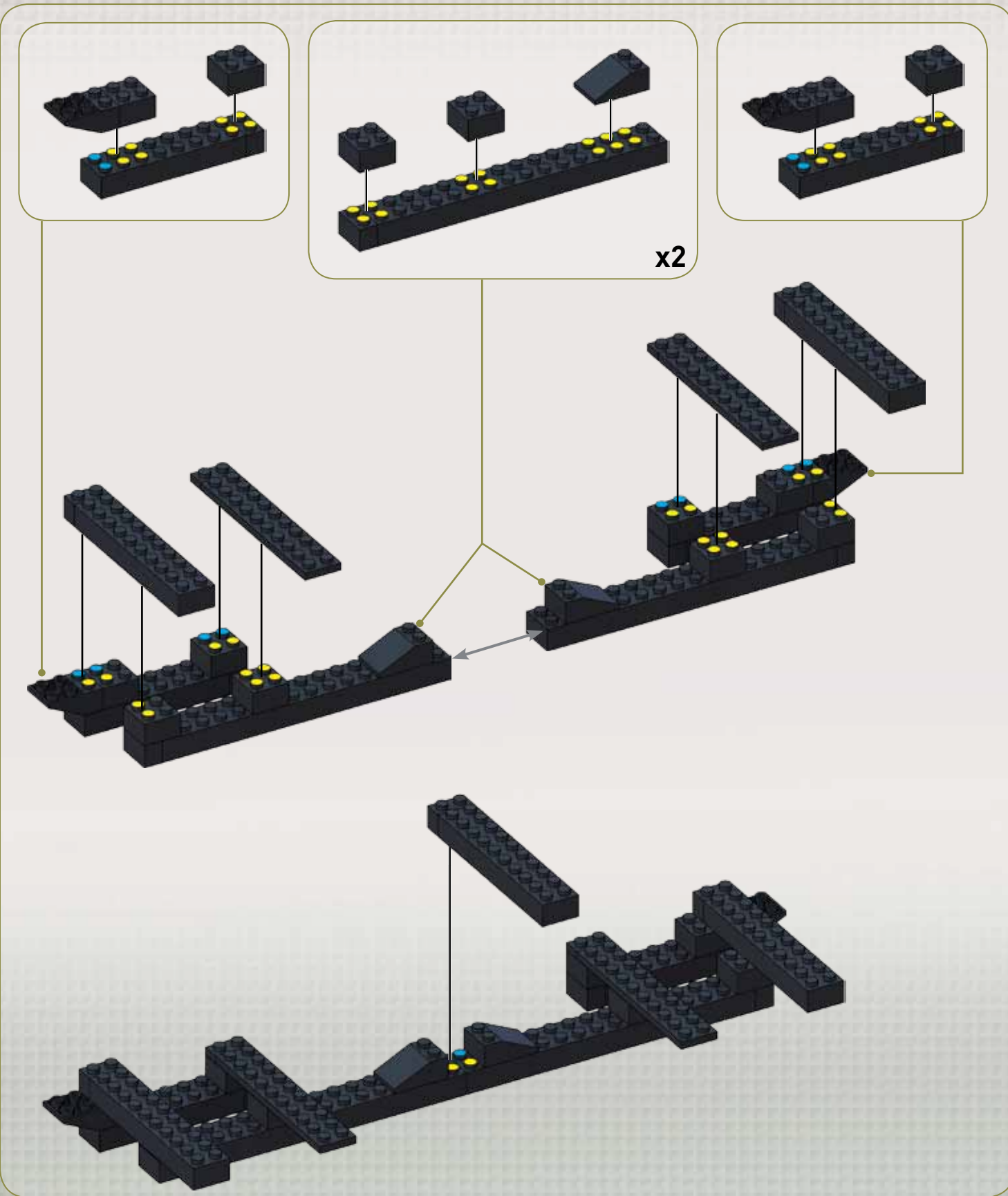



4



5



2

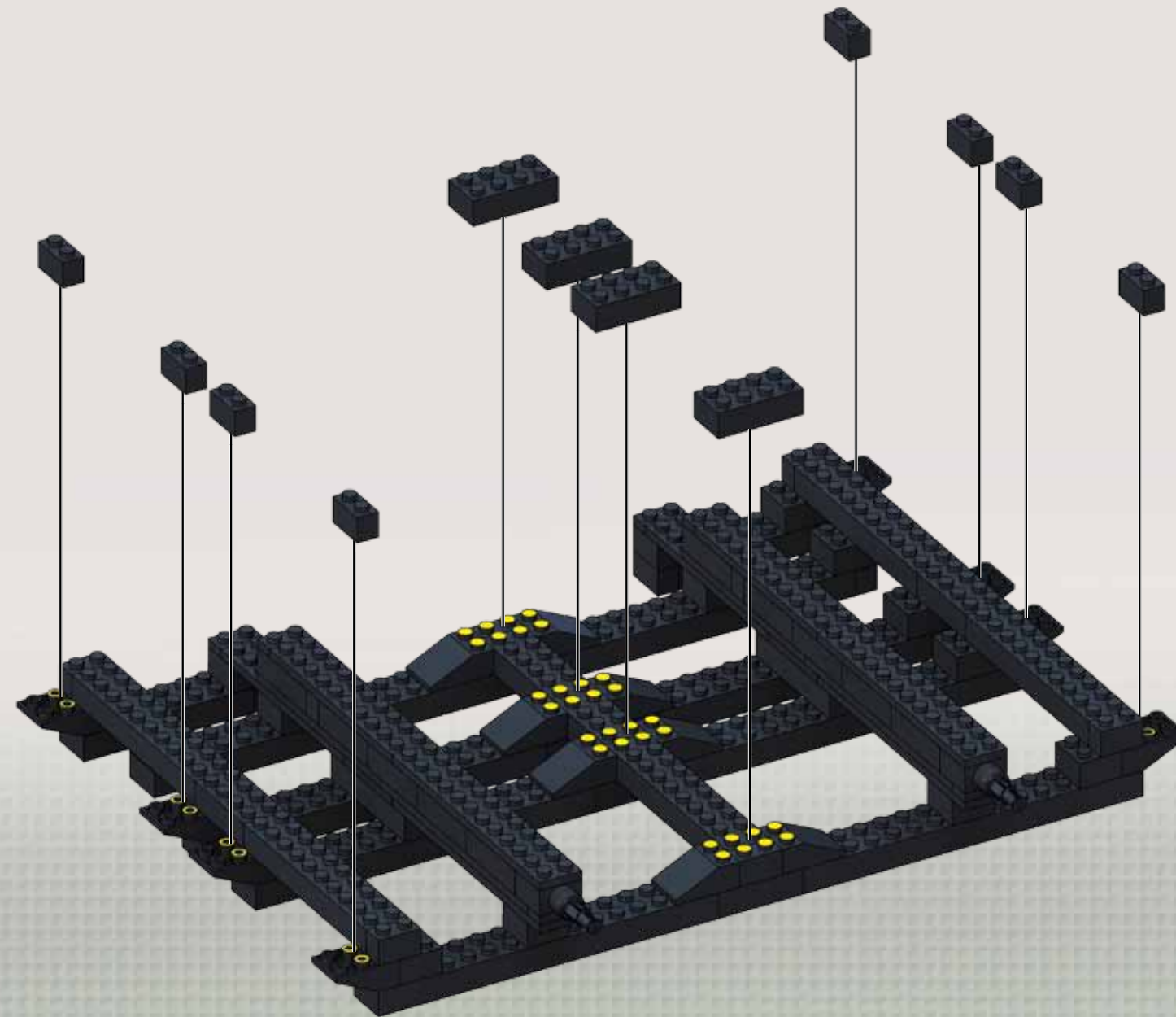
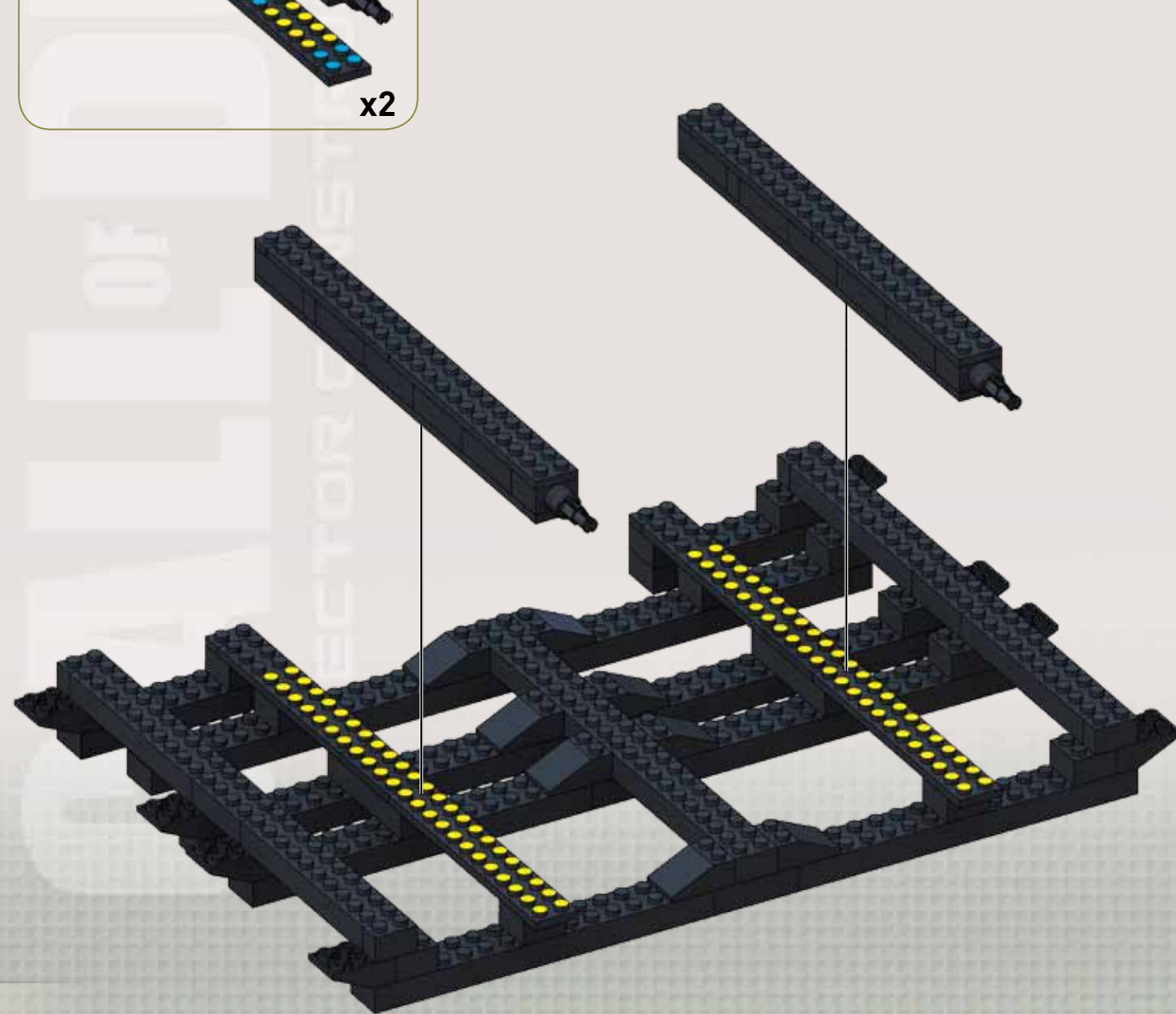



6



7



2

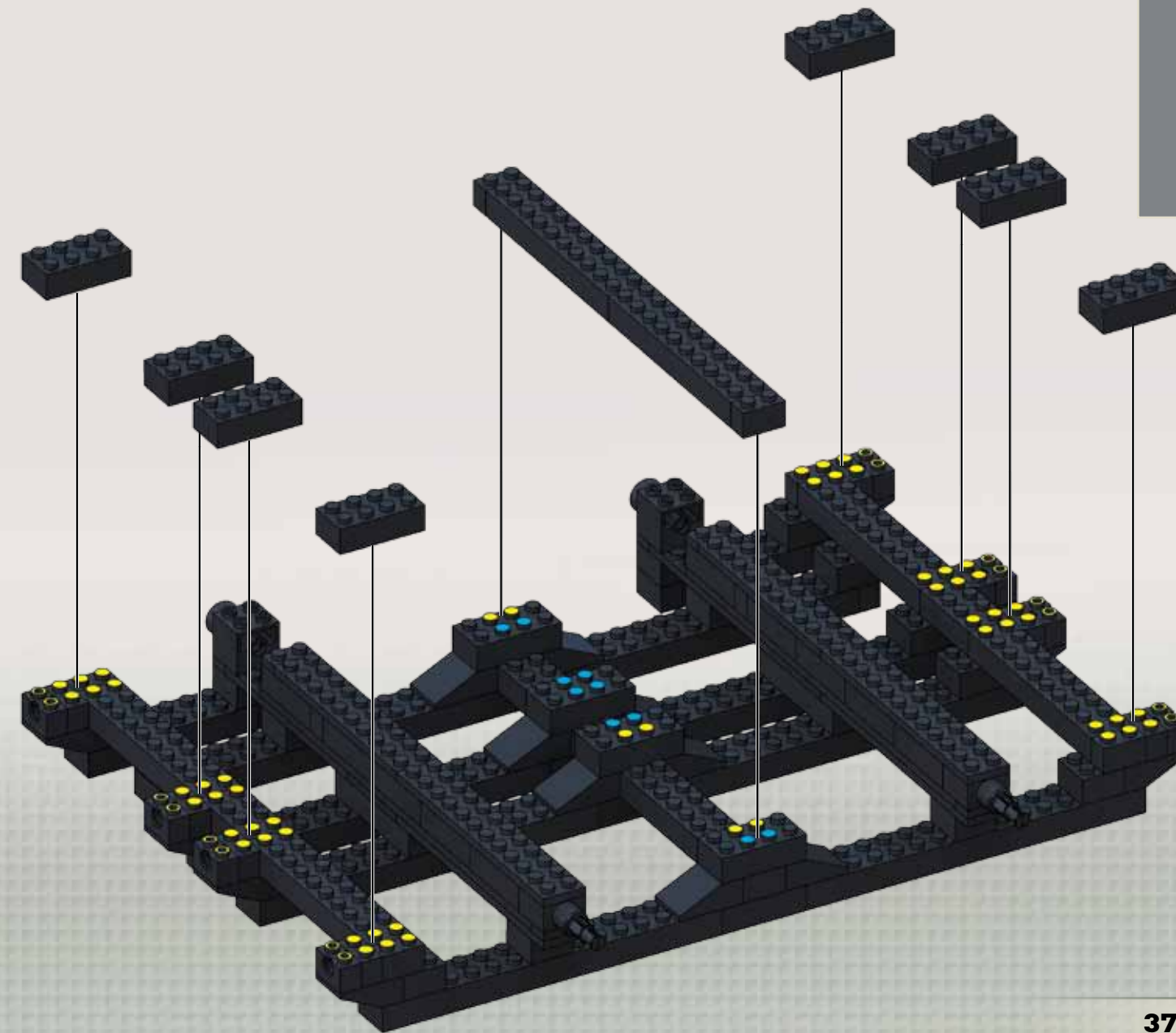
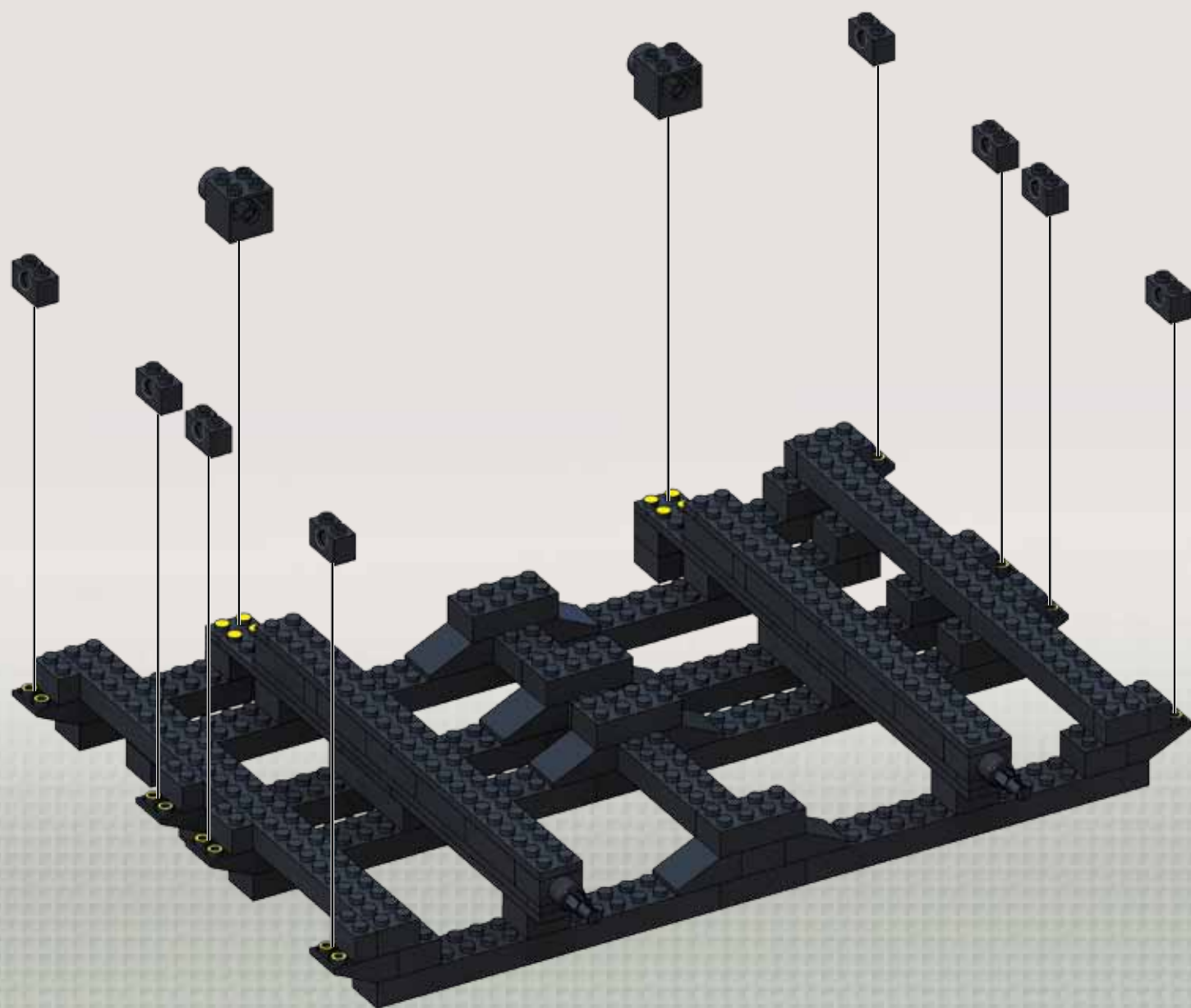

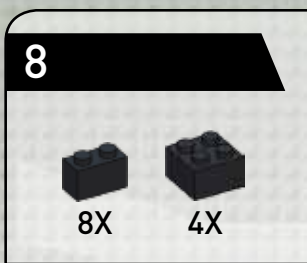

2

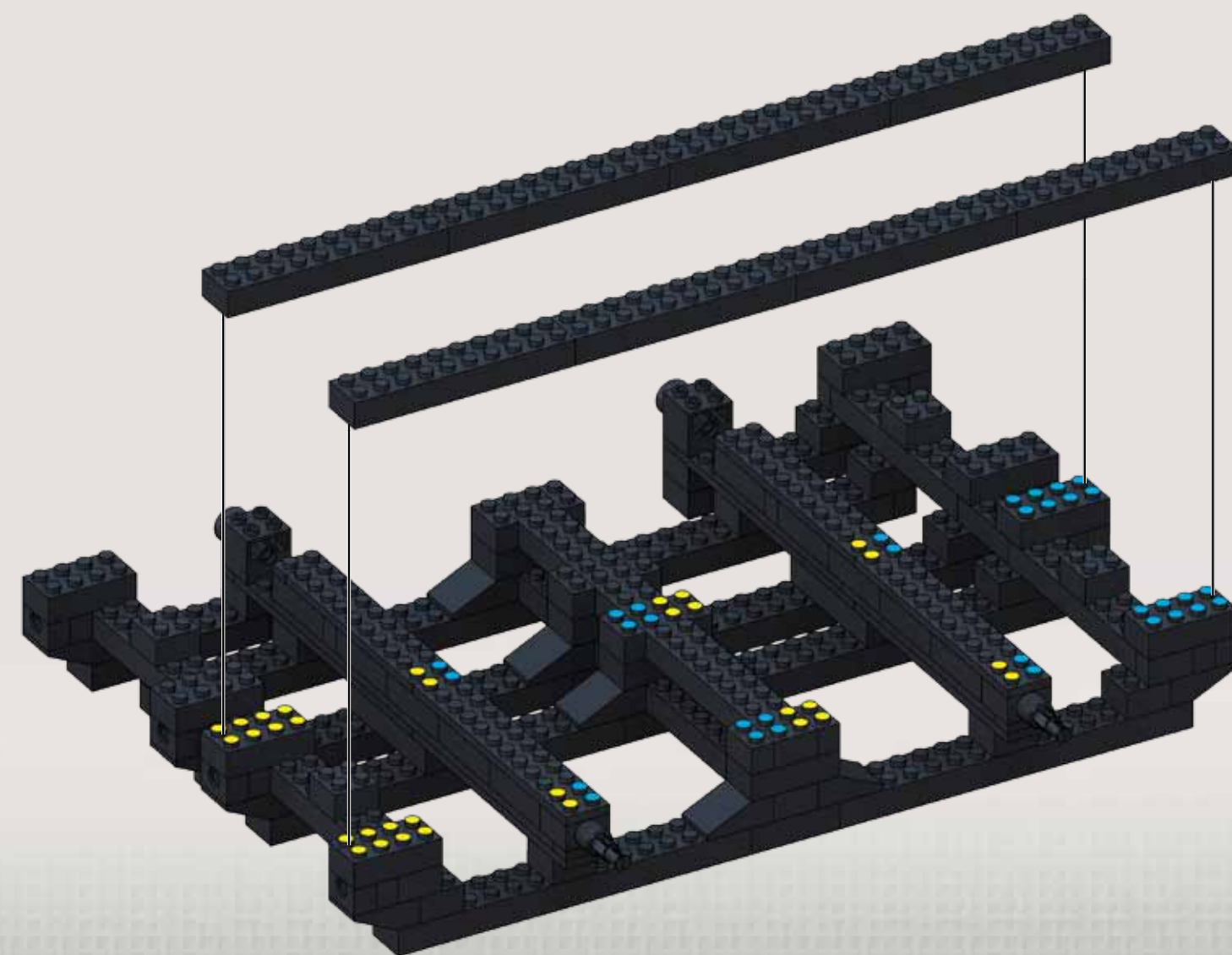
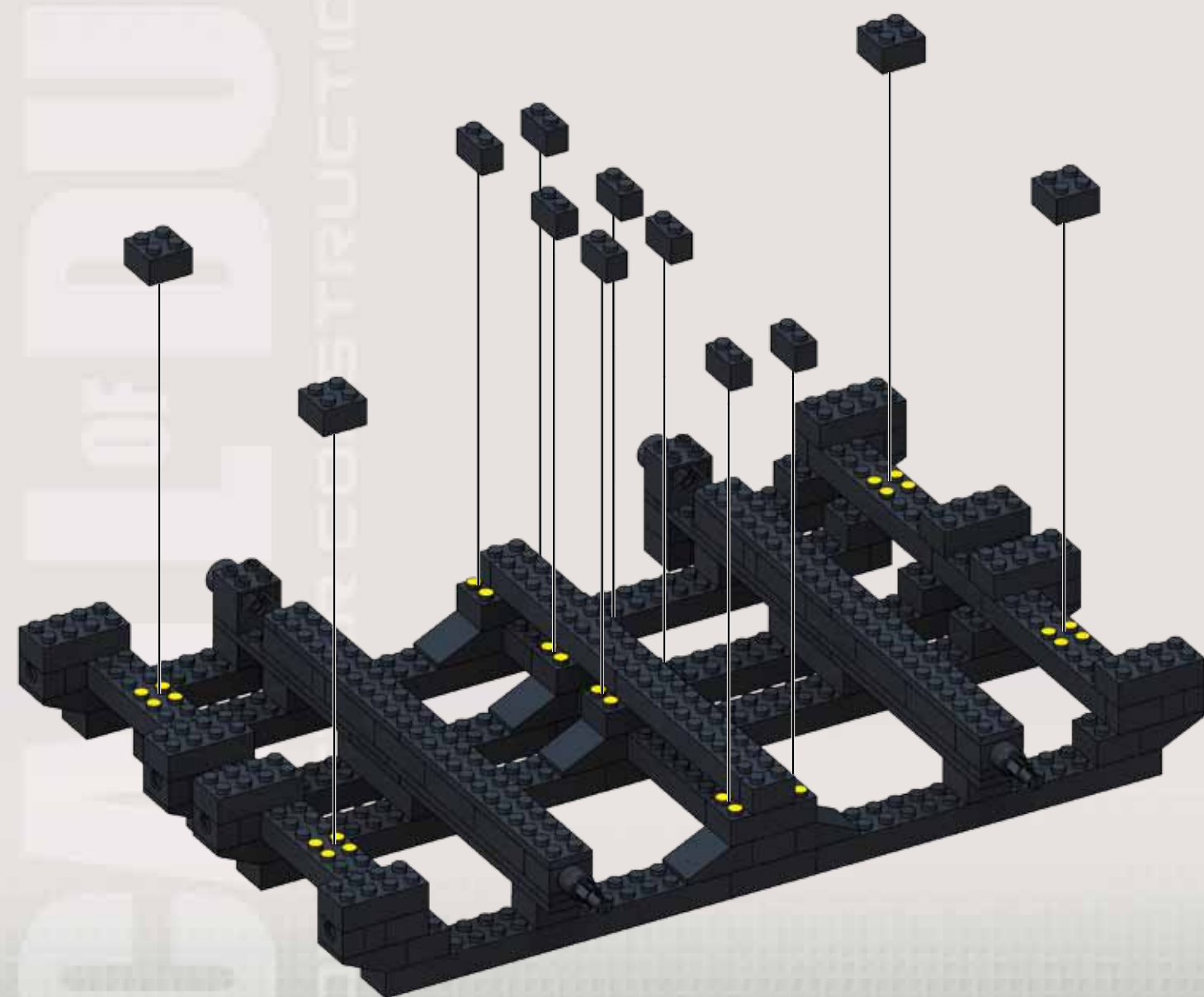



10



6X

11



7X

1X

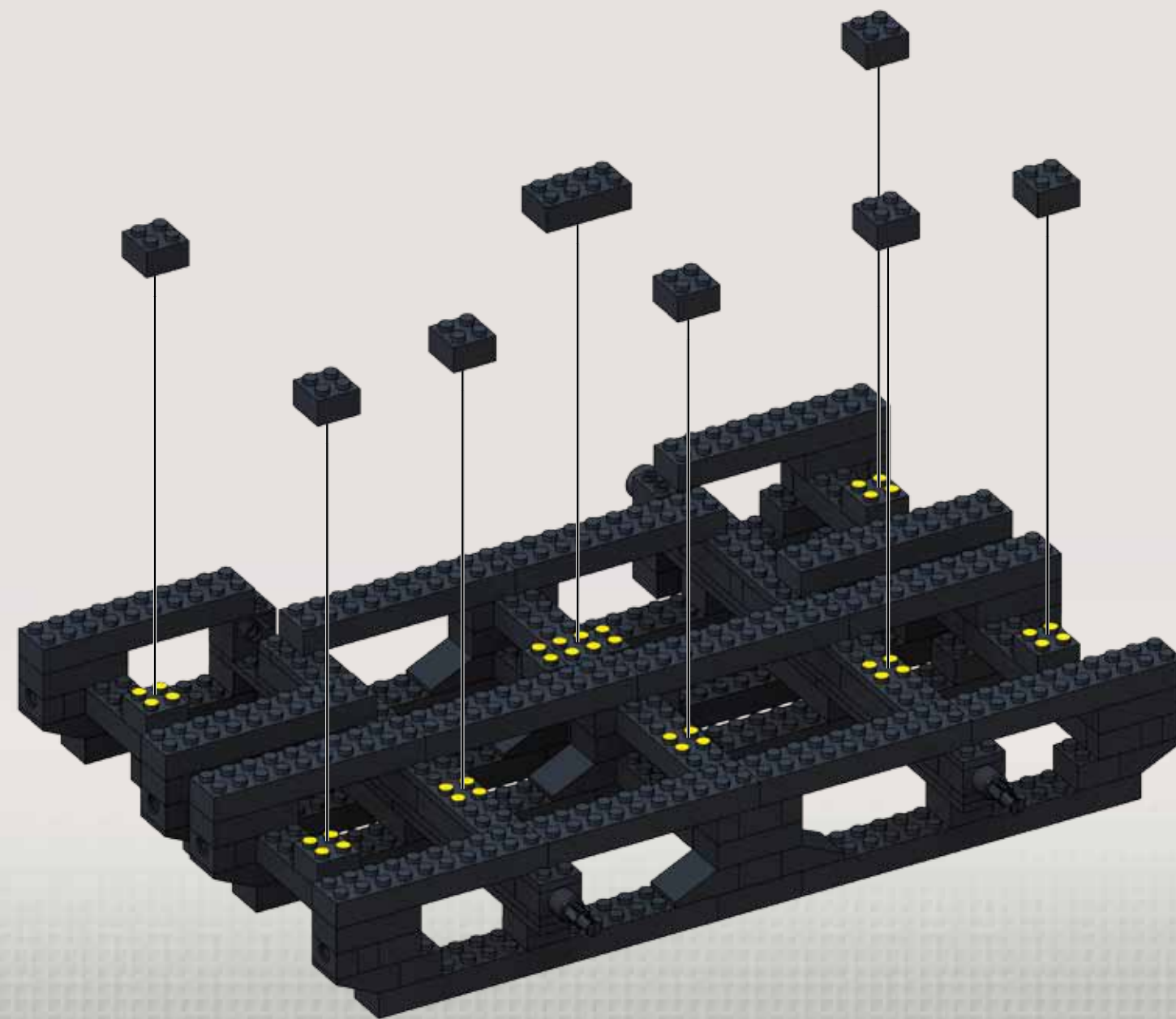
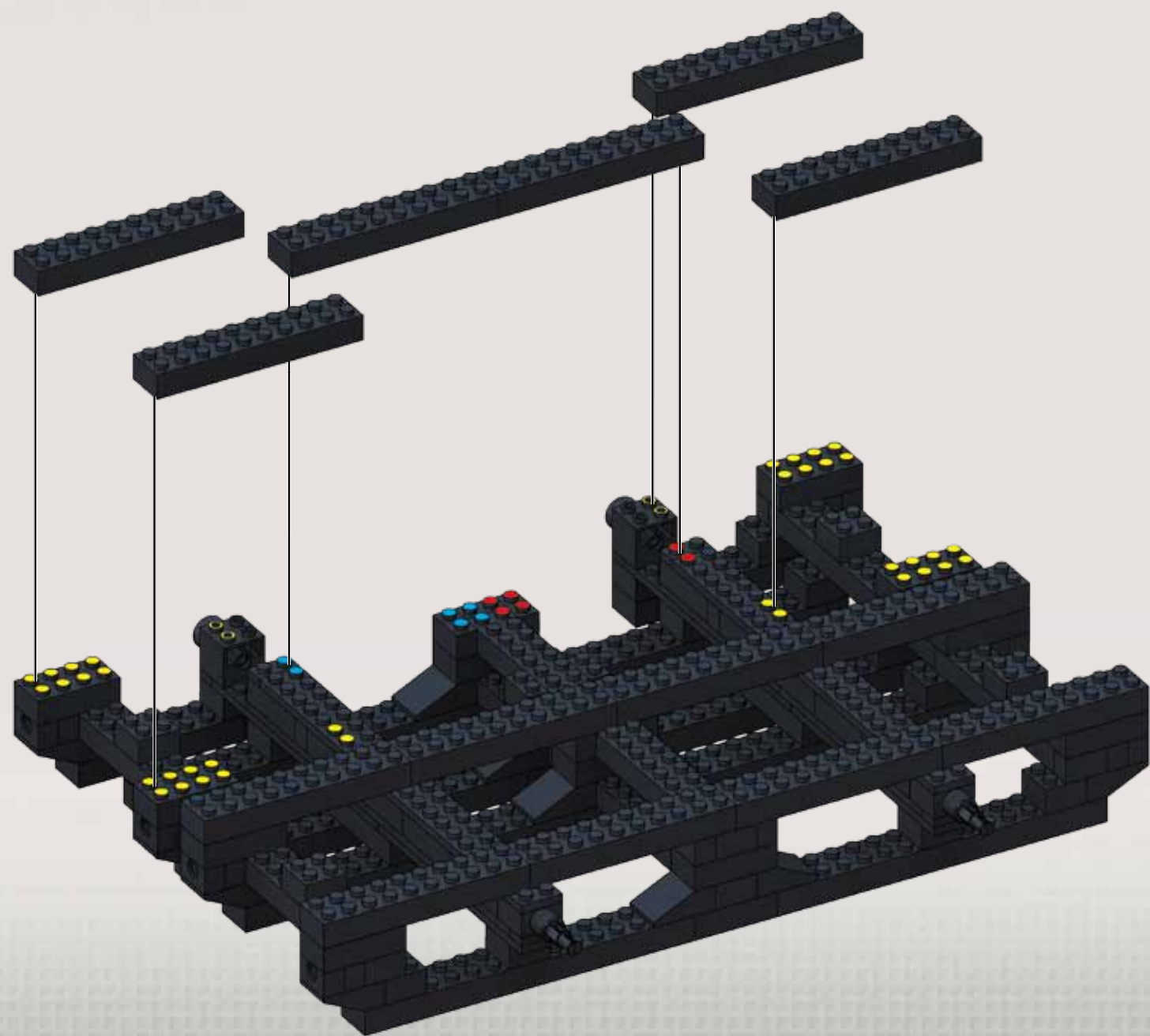

2



12

8X

13

4X 4X 2X

2

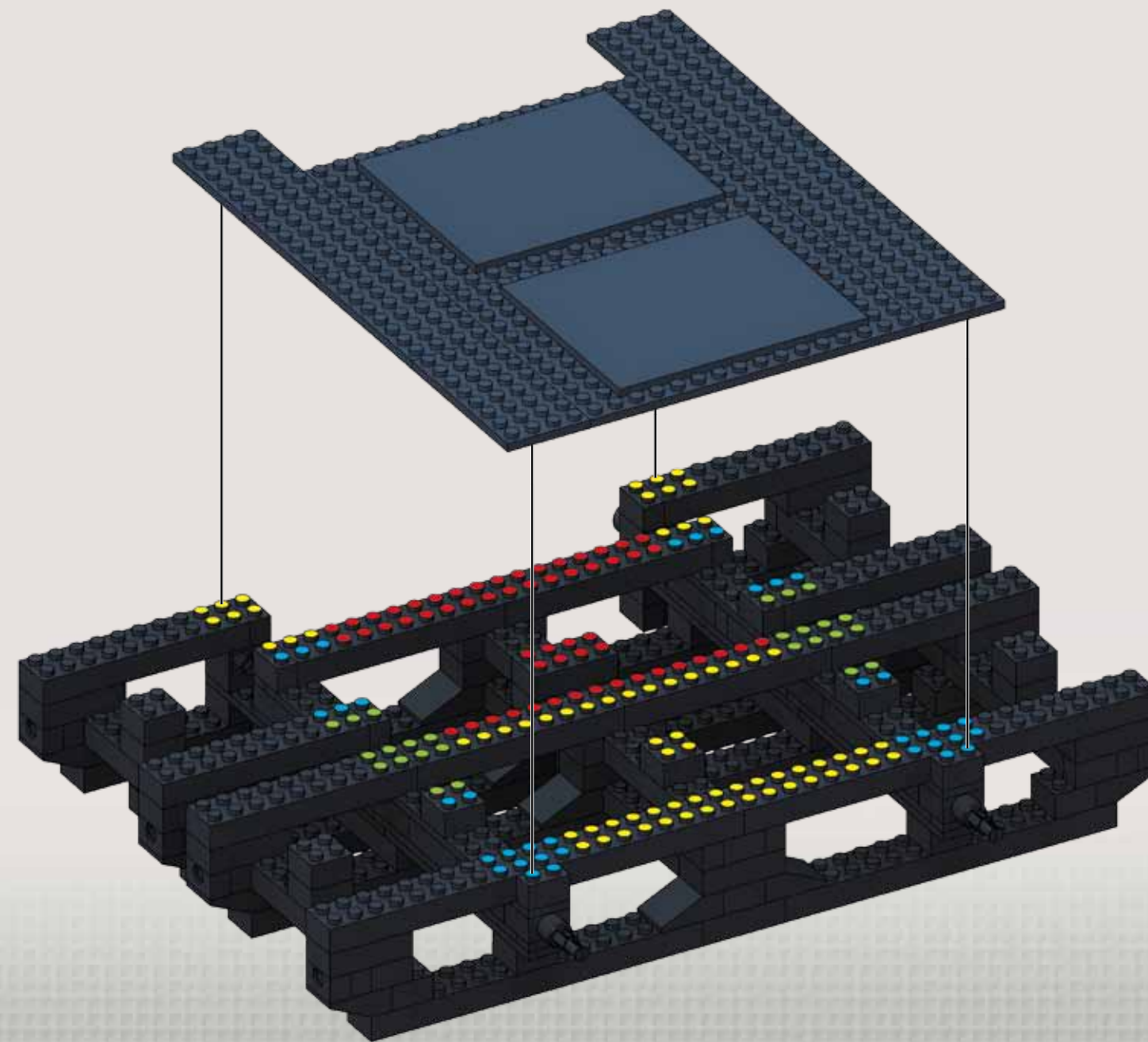
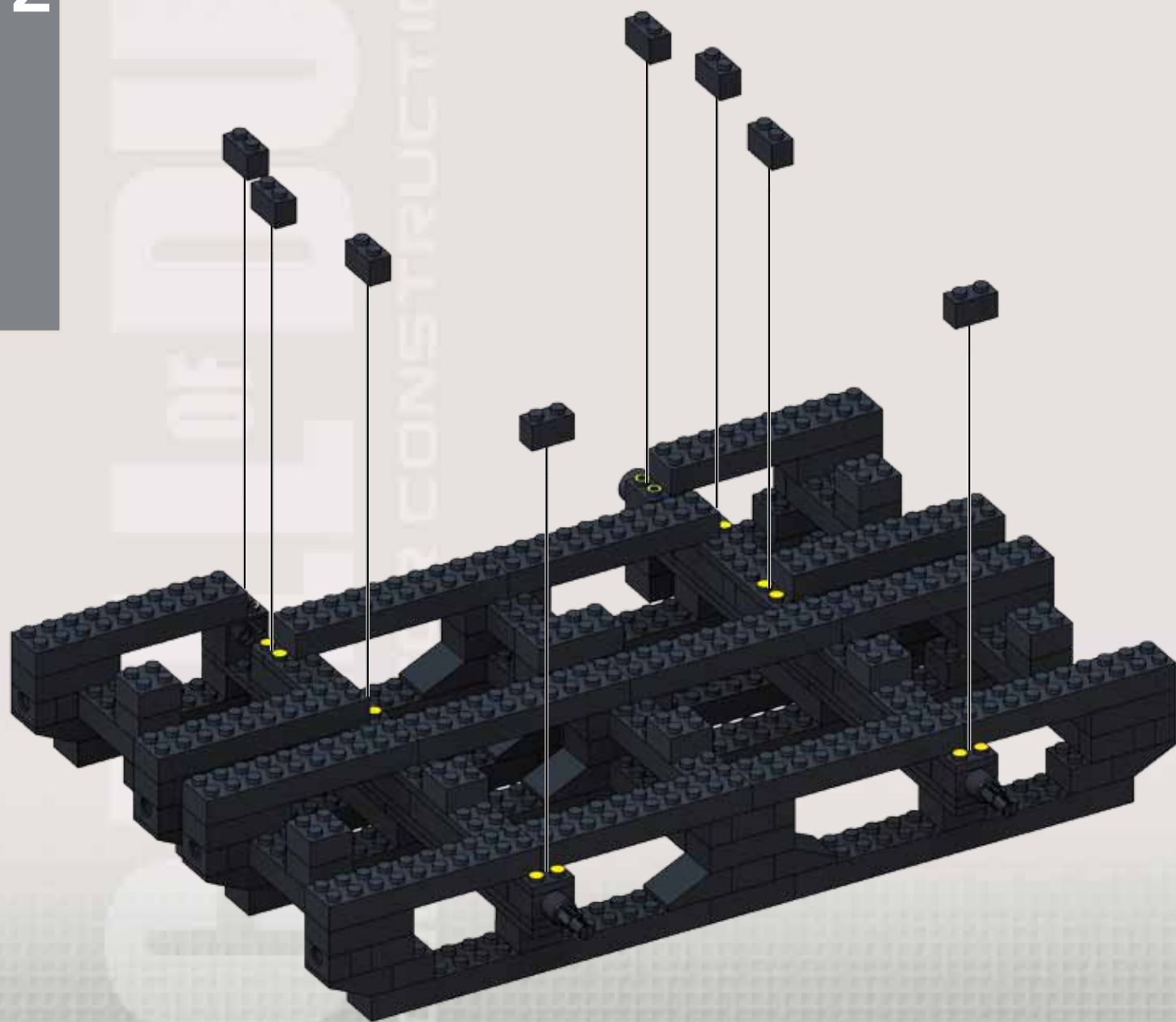



14

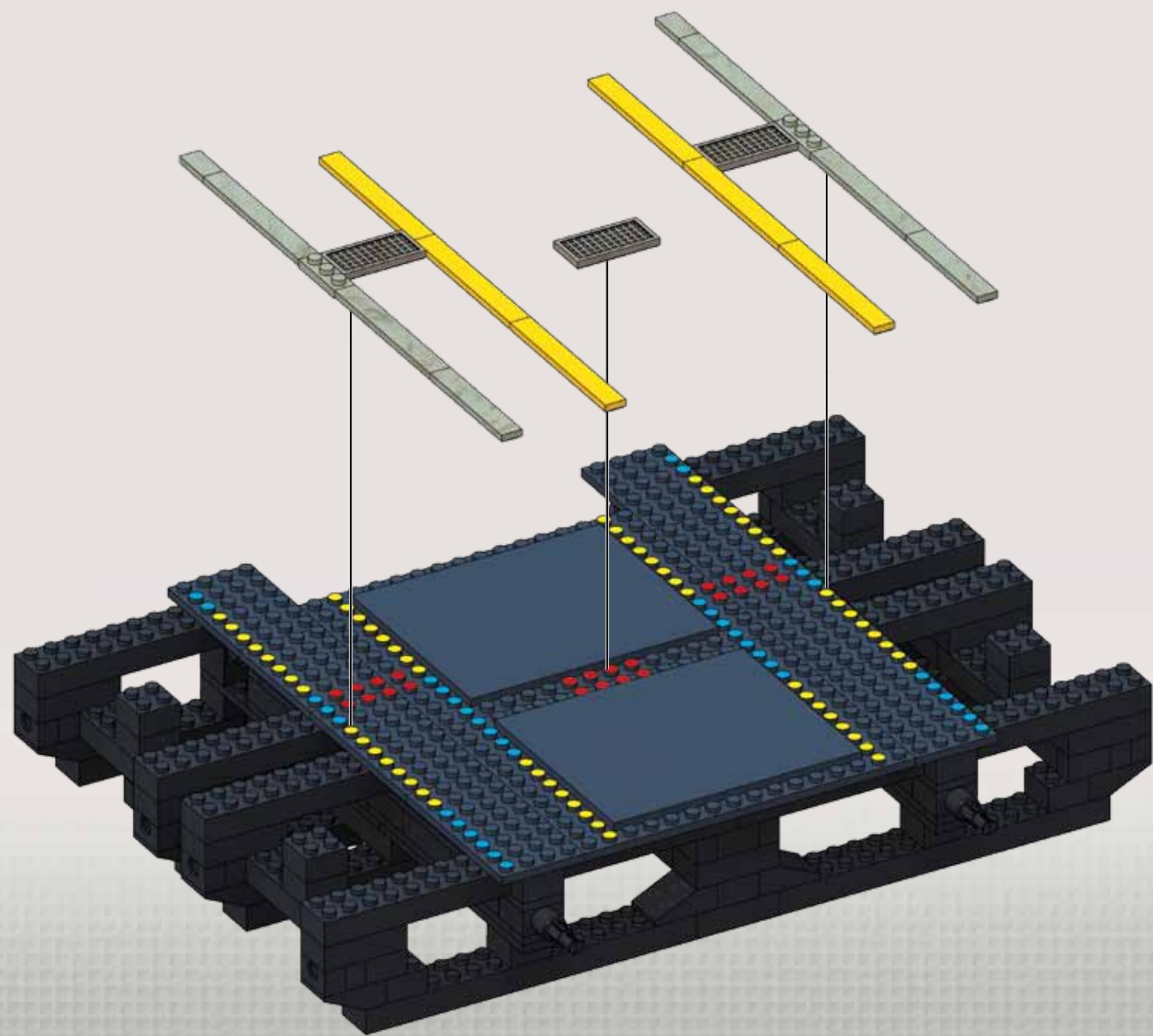
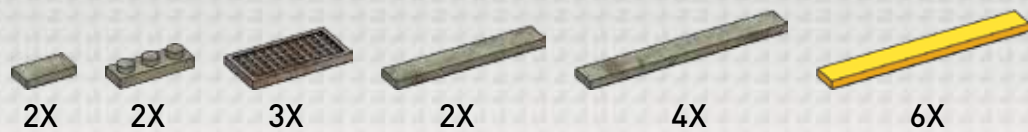

1

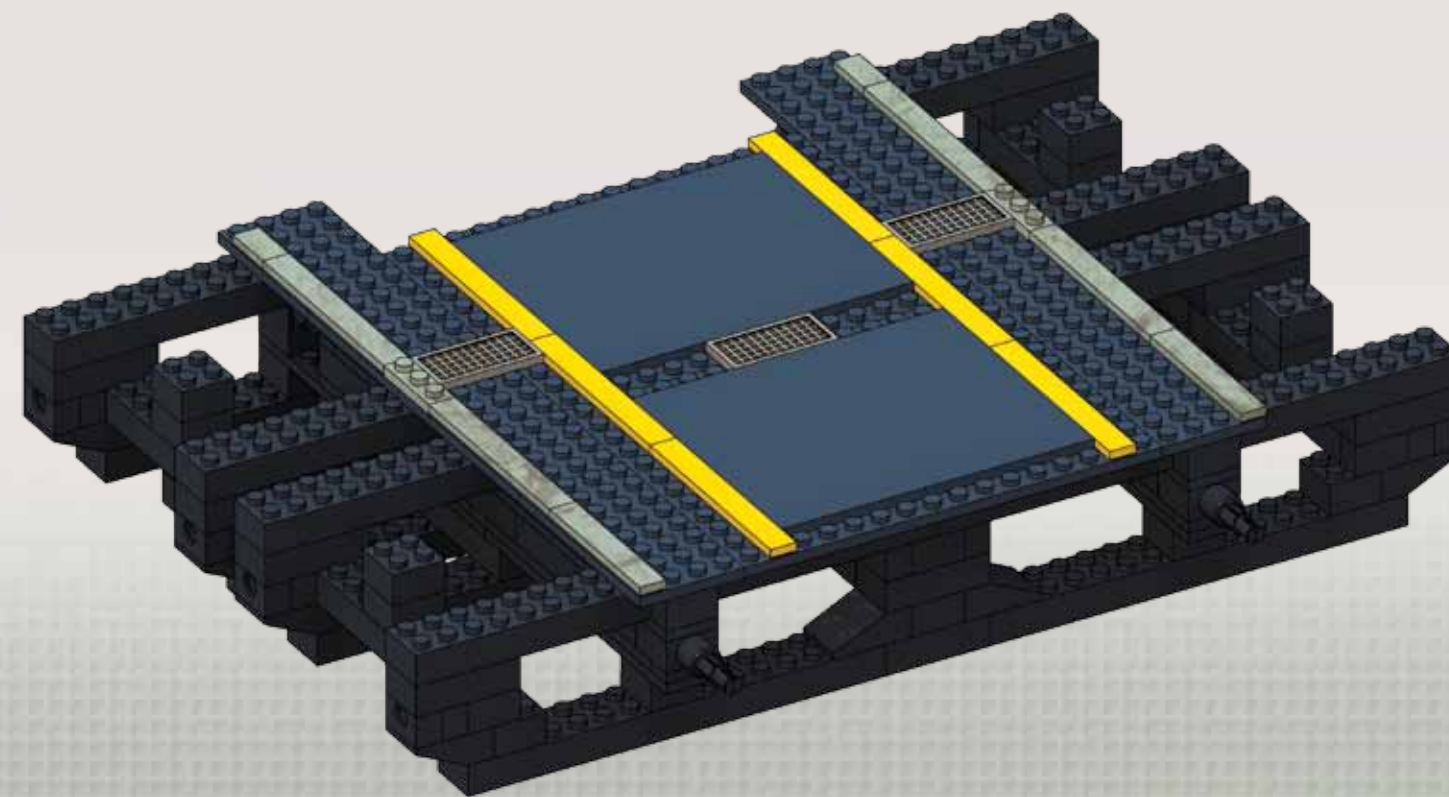

2

2

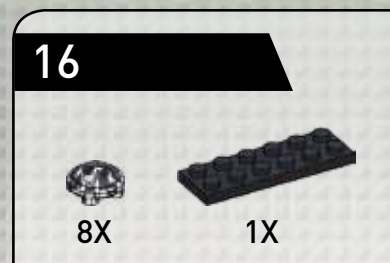

2

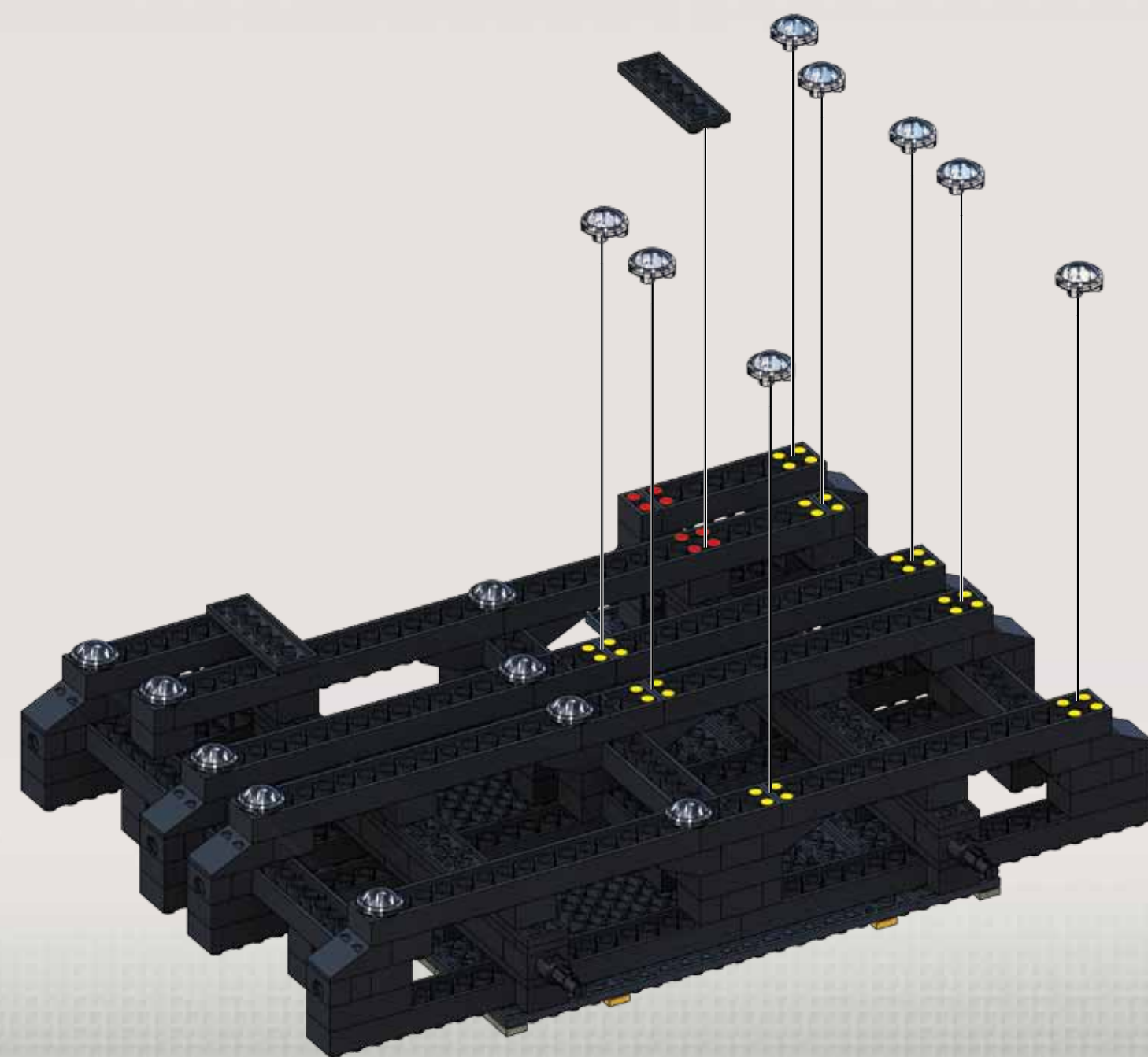
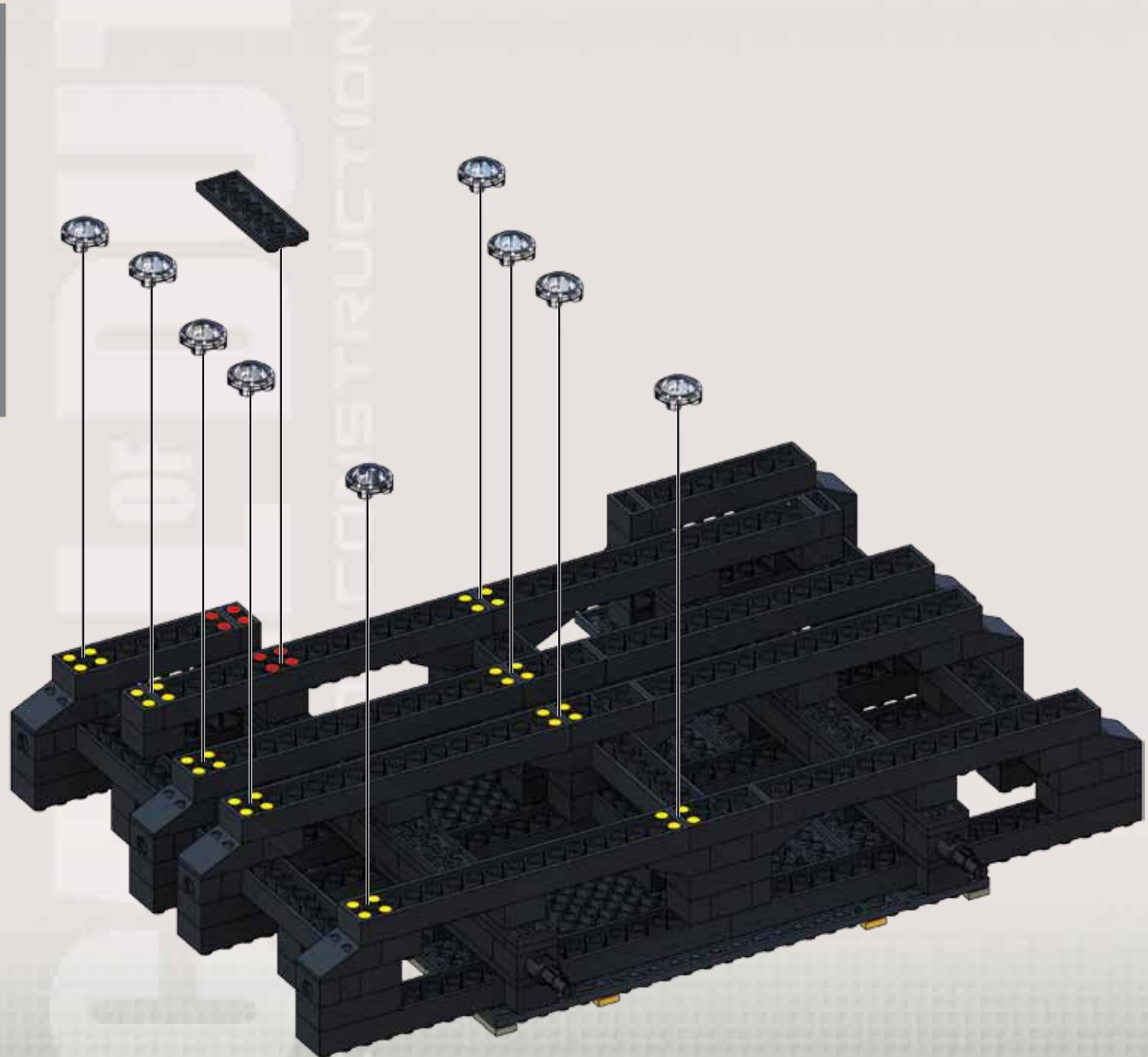



17

18

2

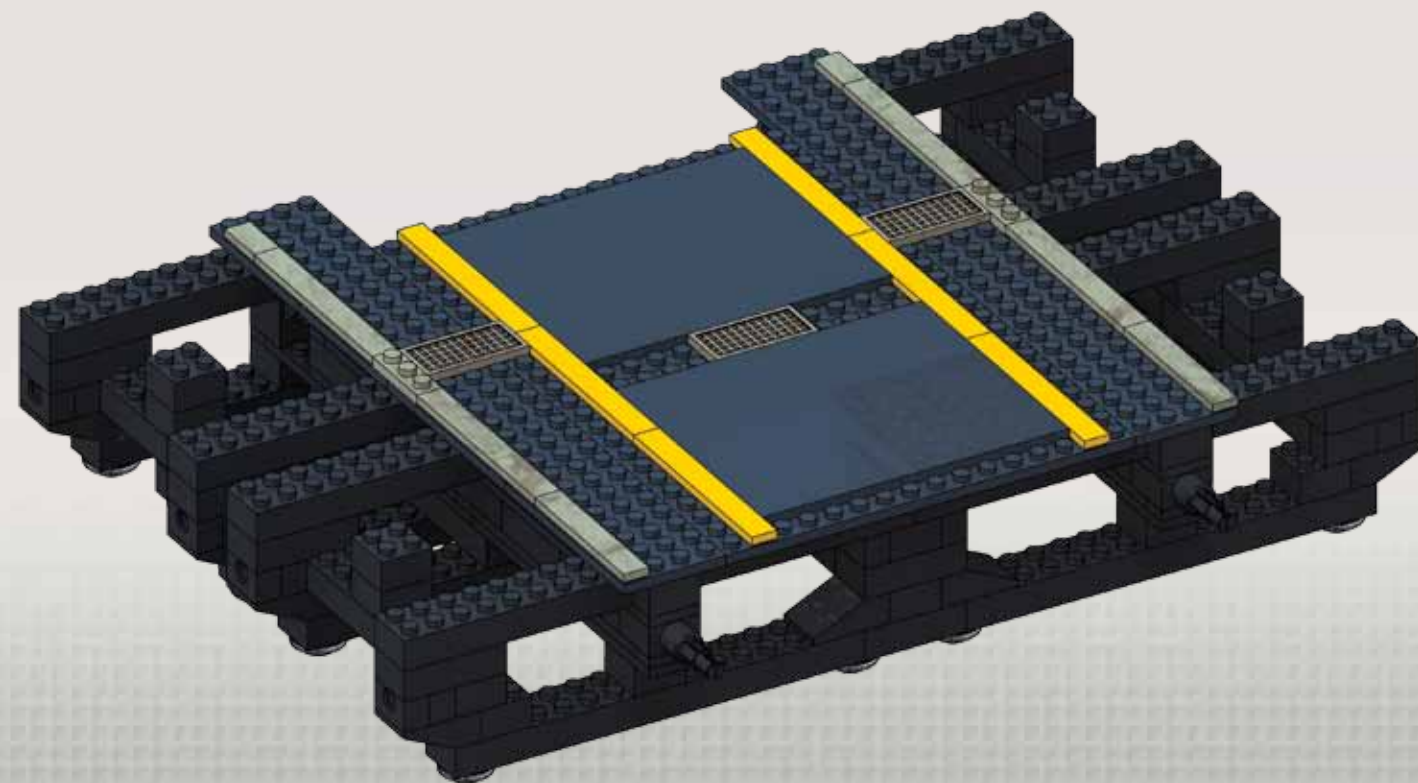
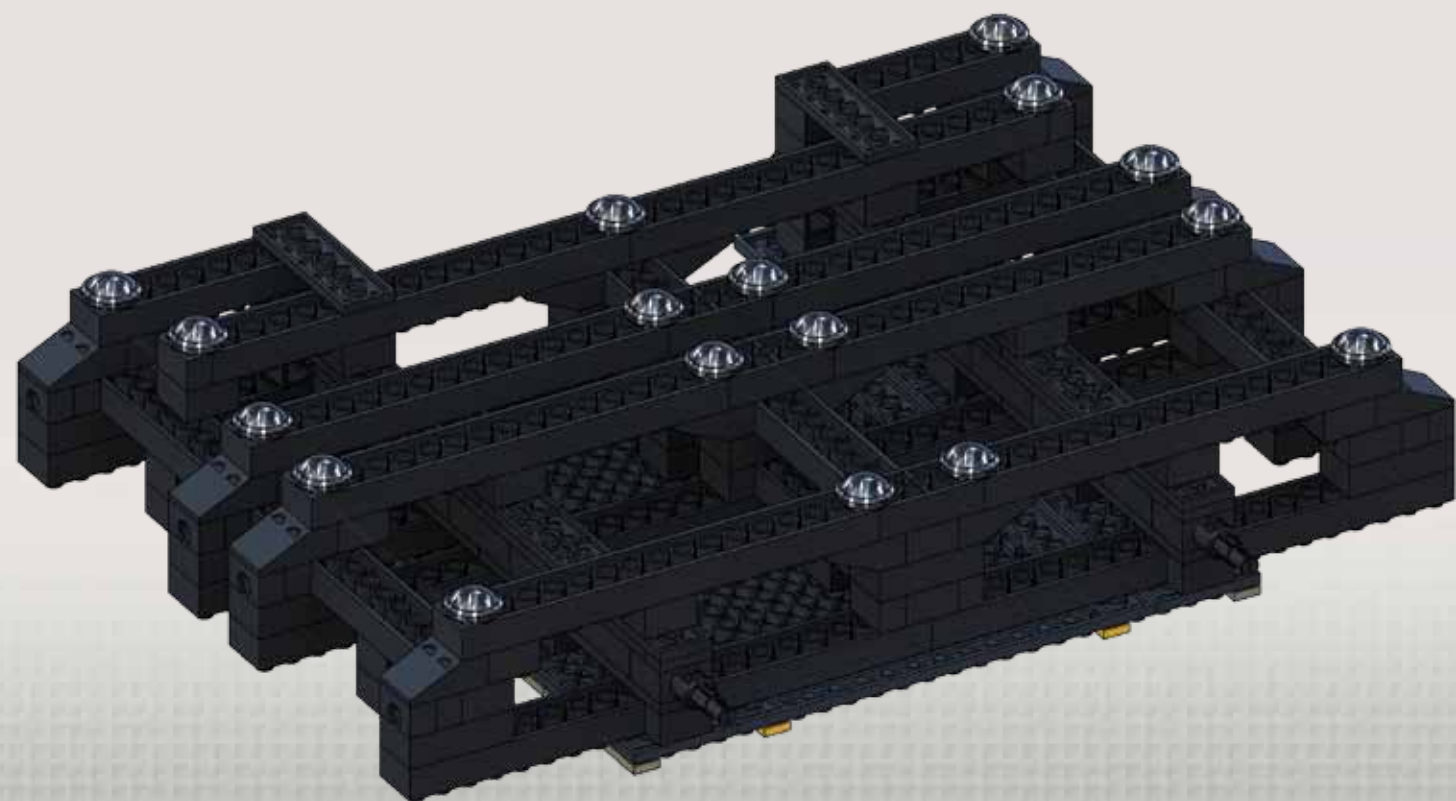



19

2X 2X 1X

1X 1X

20

4X 2X 2X 1X

2X 1X

21

2X 4X 1X

1X 1X

22

2X 2X 1X 1X

2

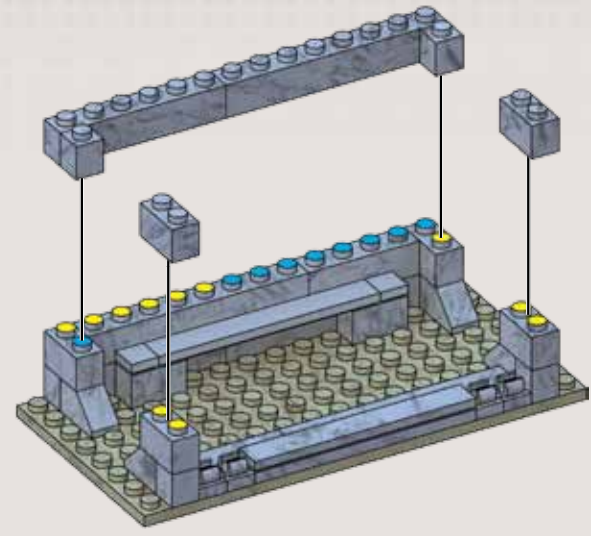
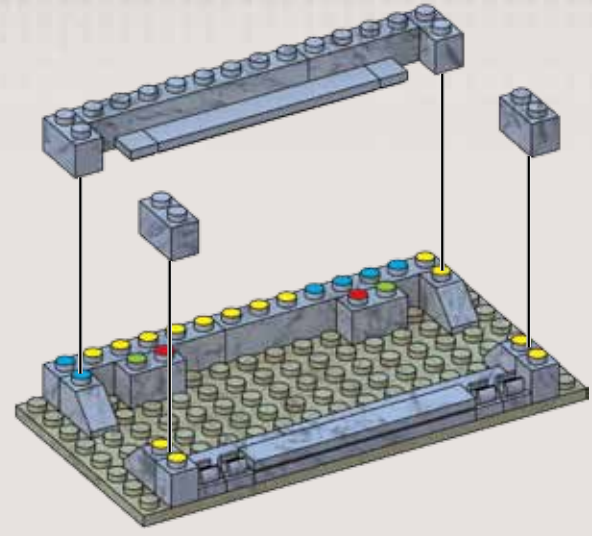
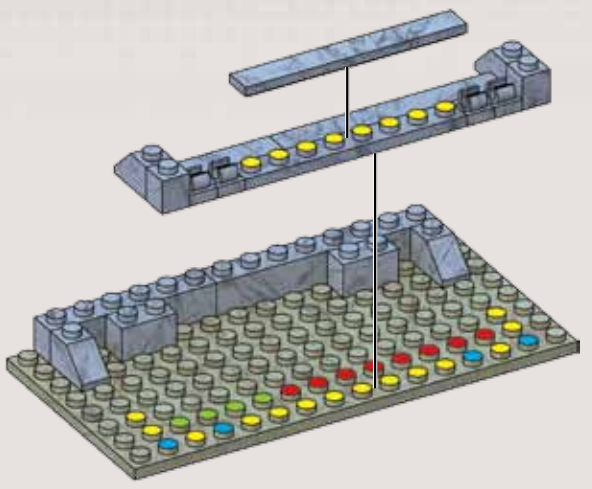
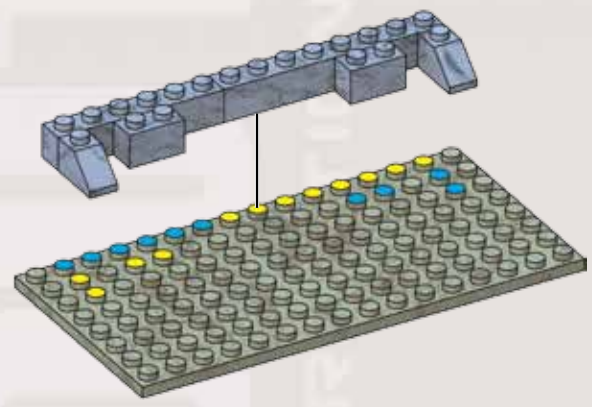

23

4X 5X 2X

24

4X 2X

25

1X 1X 4X 4X 4X 1X

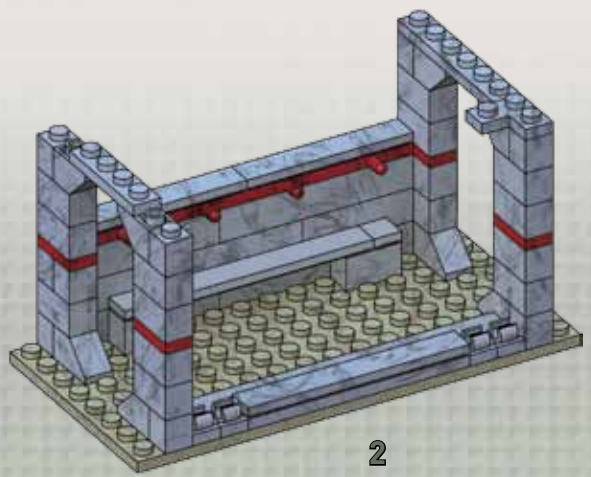
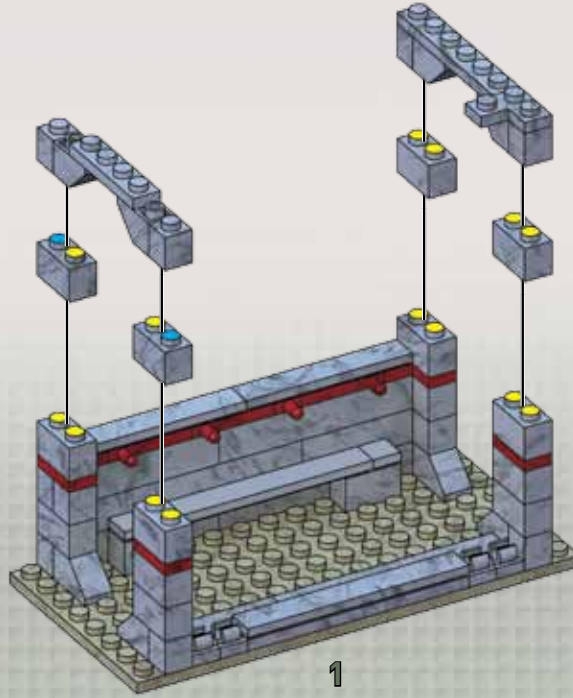
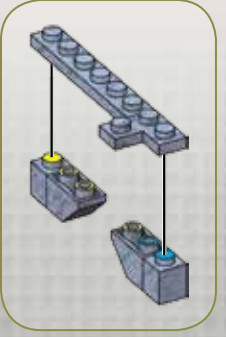
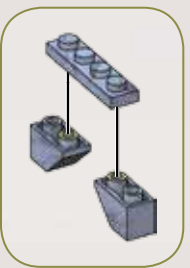
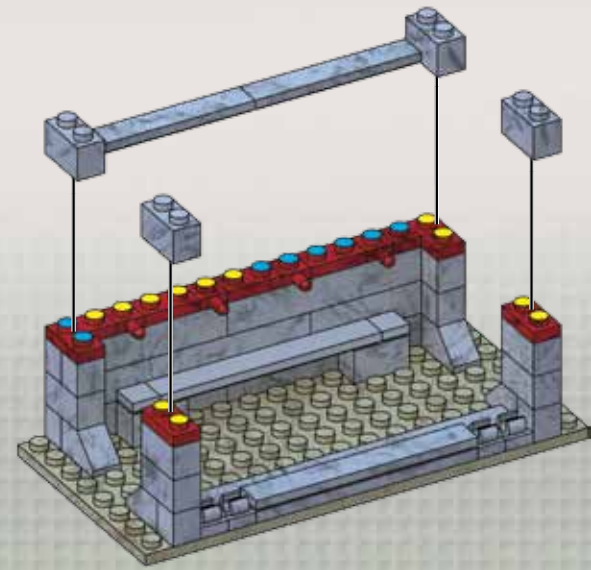
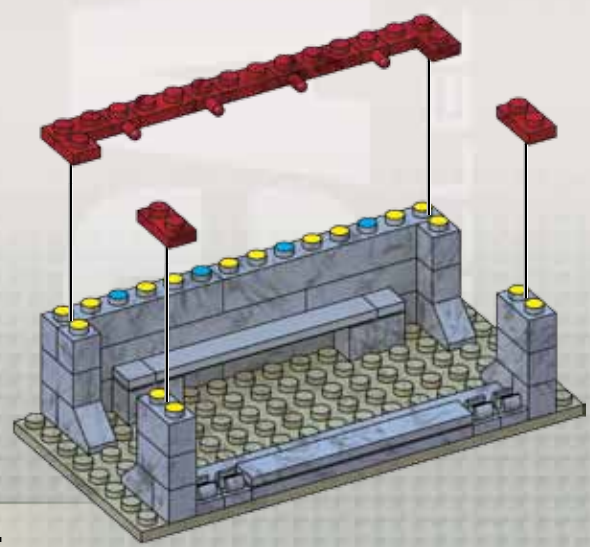



26

2X 4X 2X

1X

27

2X 3X

28

1X 2X 5X 1X 2X 1X

29

1X 2X 1X 1X 2X 1X

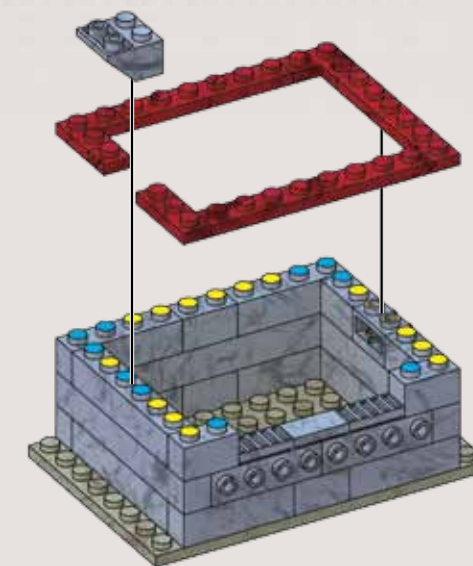
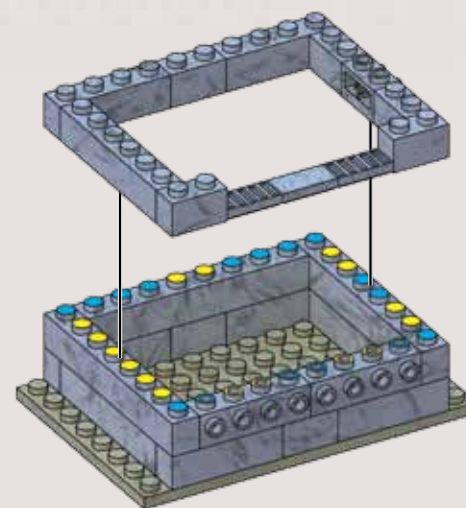
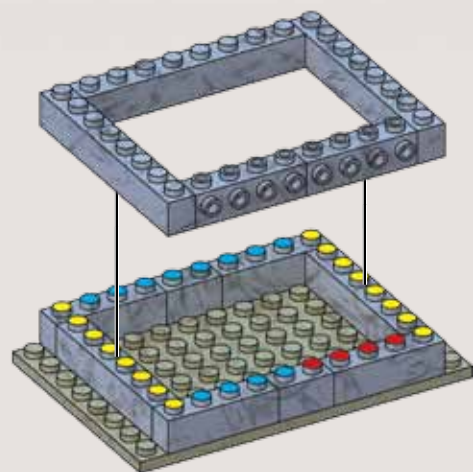
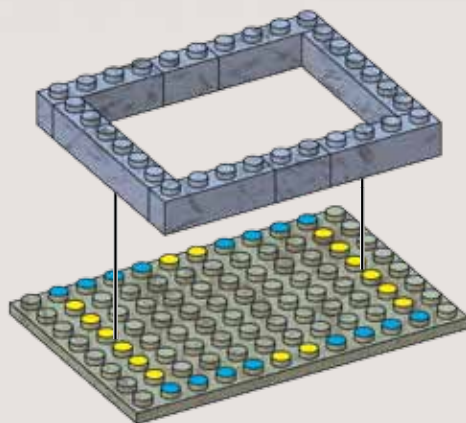

2

30

1X 5X 1X 1X 1X 1X 2X 1X 1X 1X 1X 2X 1X 2X 2X 1X 1X 2X 2X 1X 2X



1 2 3 4 5

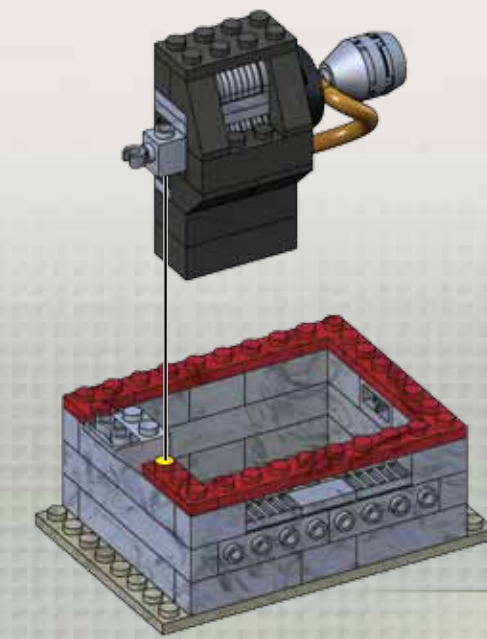

45



2

31

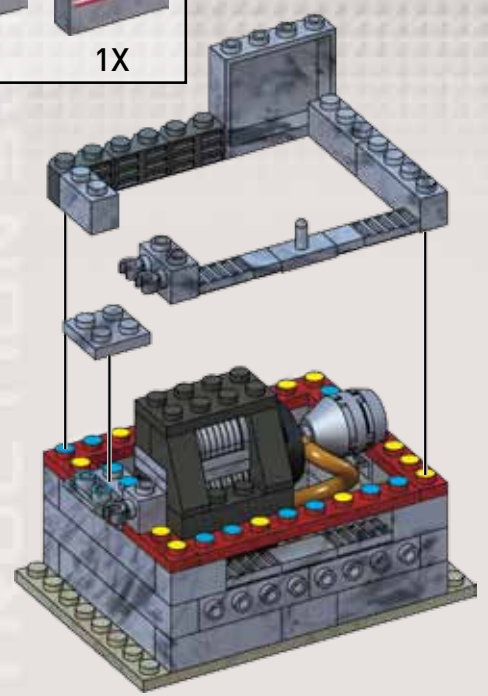
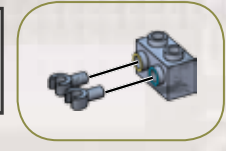
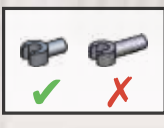
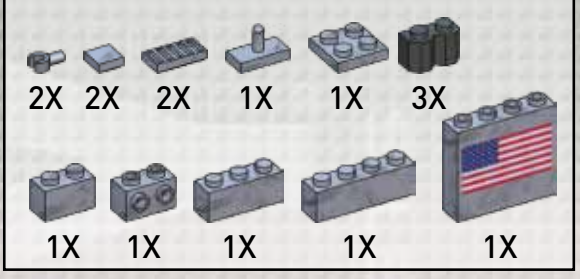

32

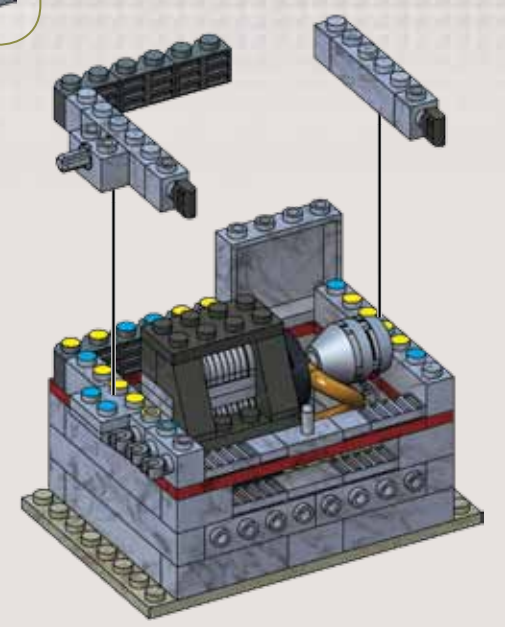
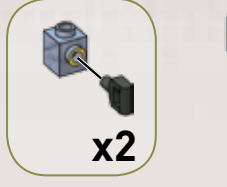
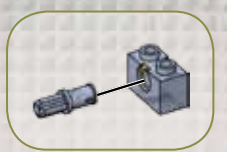

33

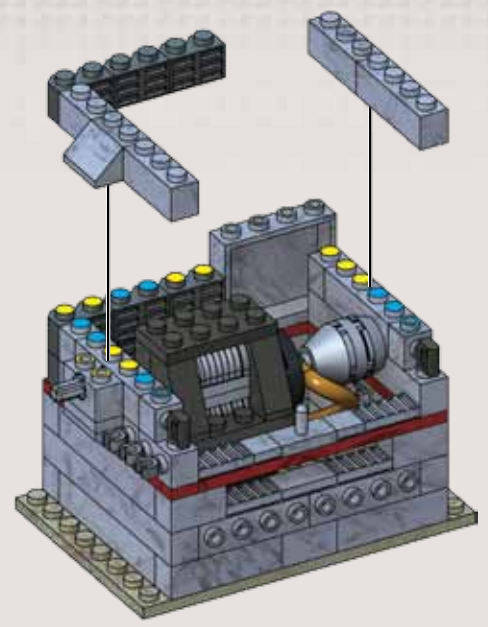
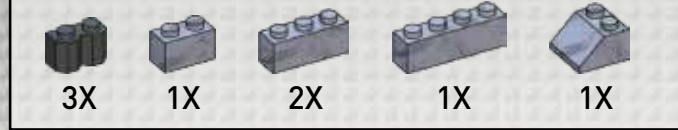

34

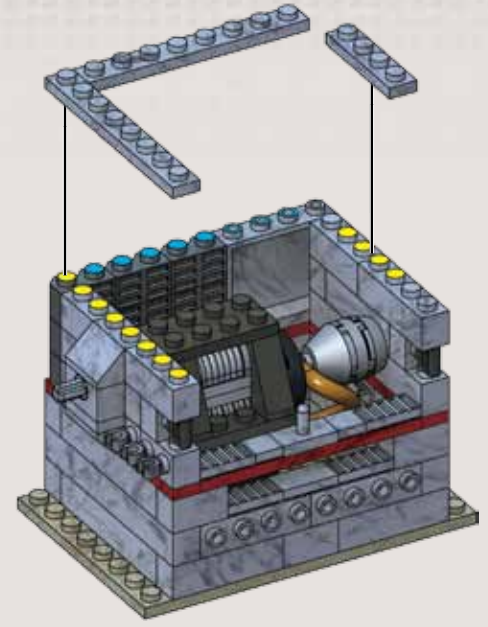

35

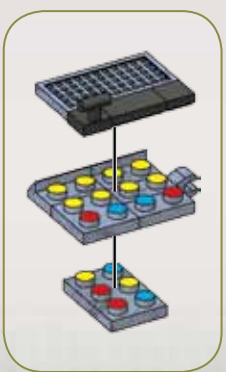
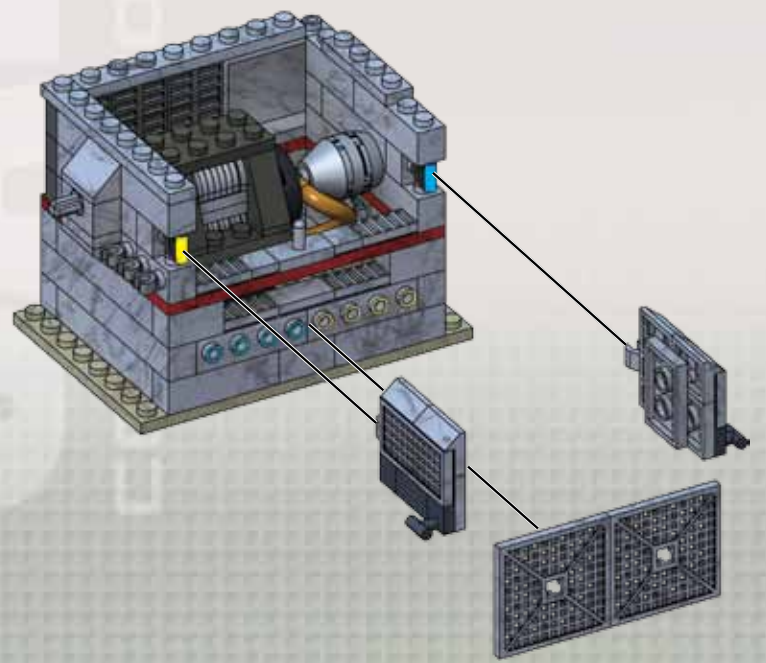
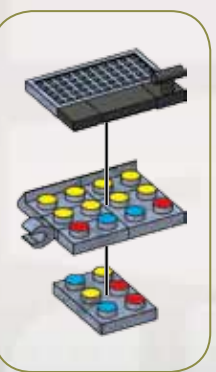
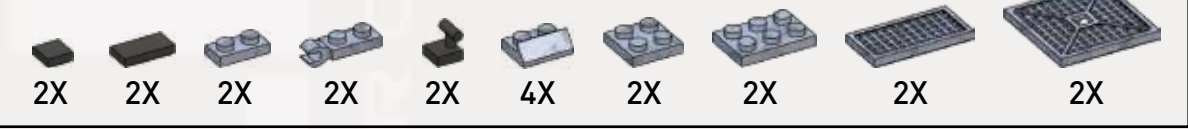

36

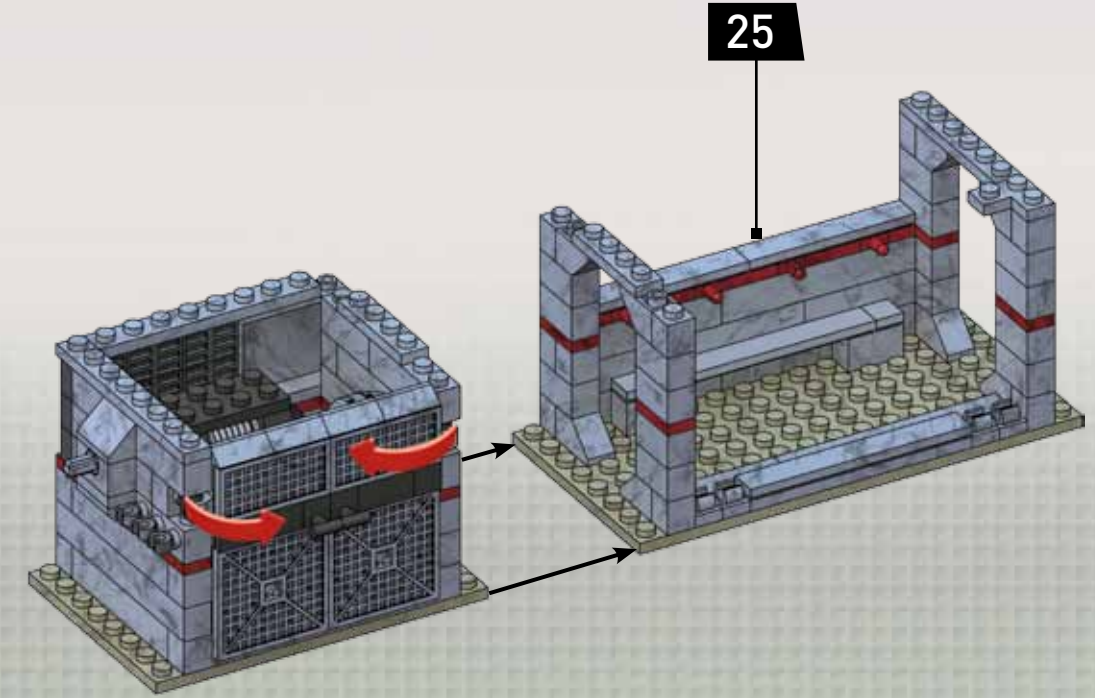



37

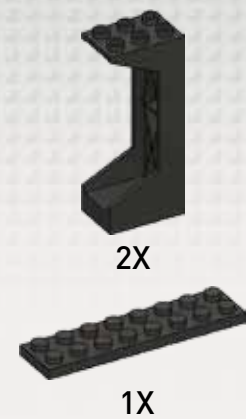

2X

1X

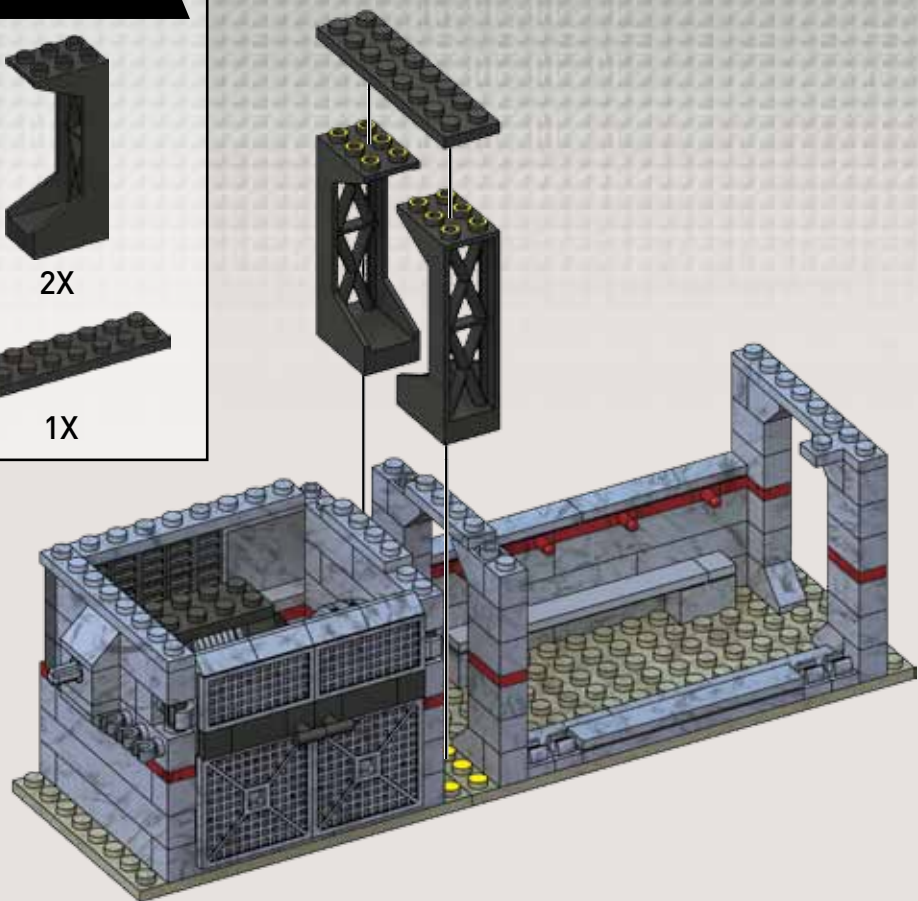

38



1X

1X

1X

1X



1

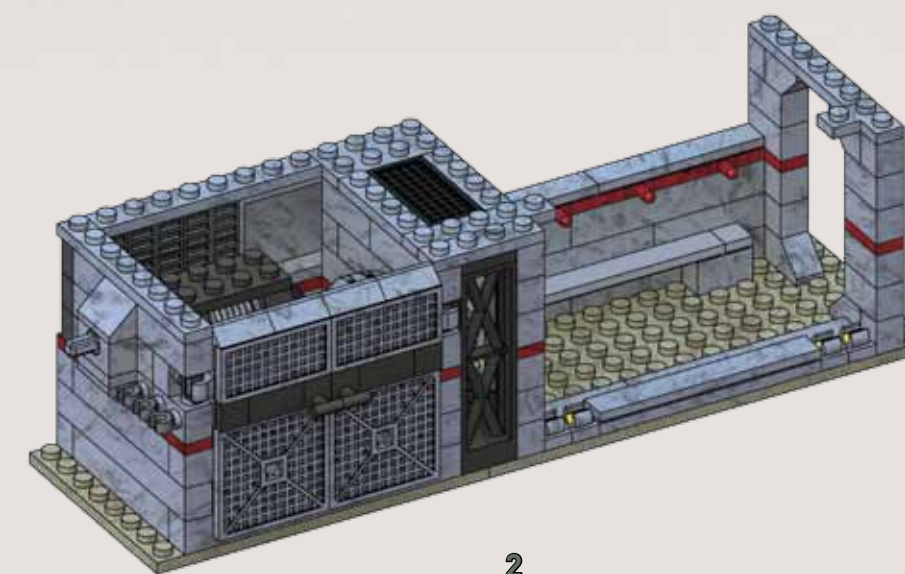

2

2

39

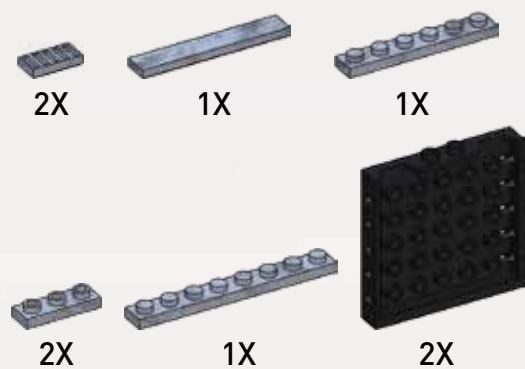

2X

1X

1X

2X

1X

2X

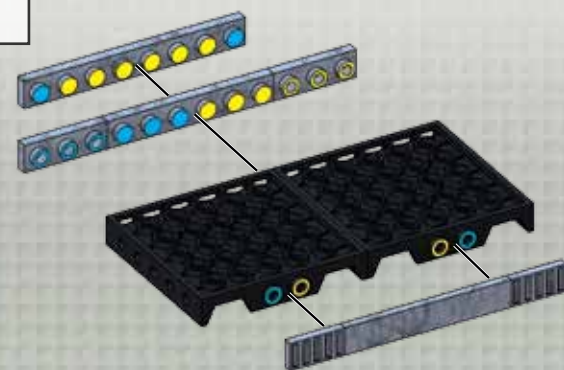

40



6X

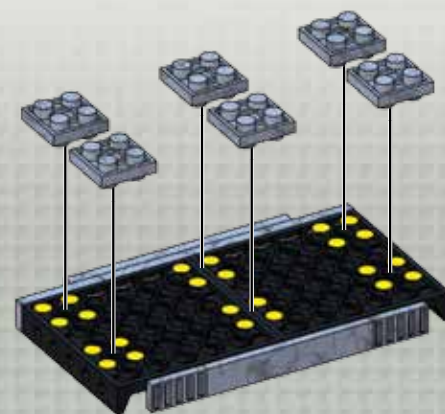

41



4X

2X

2X

4X

2X

2X

1X

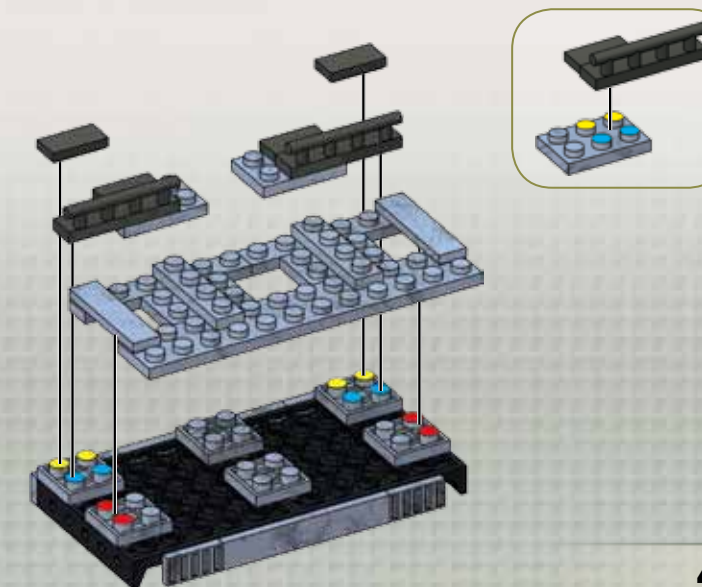
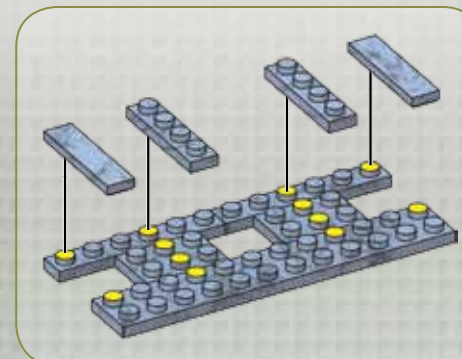
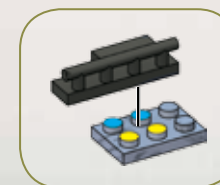

47



42

4X 2X

43

2X 4X 5X

44

11X 4X



2

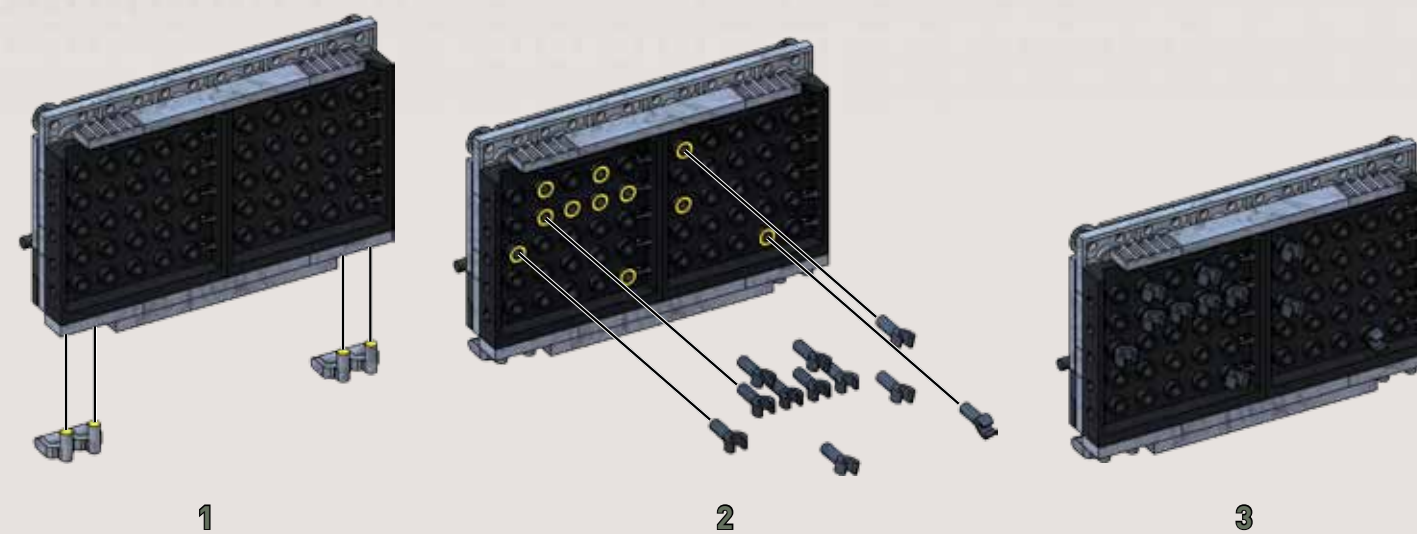
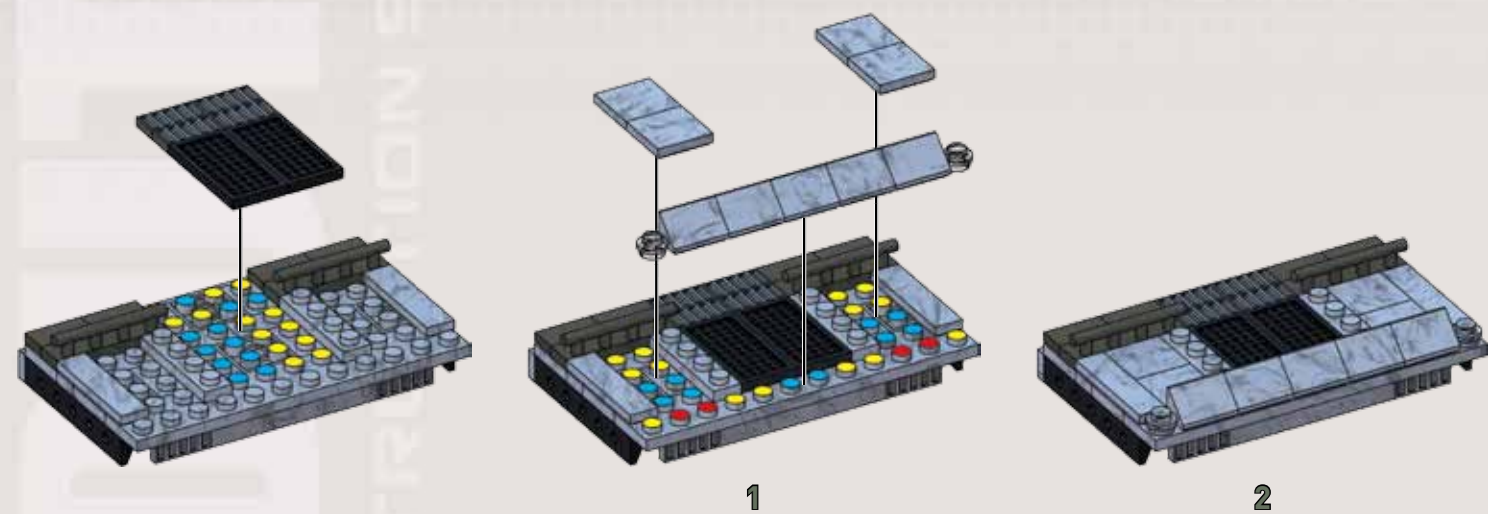

45

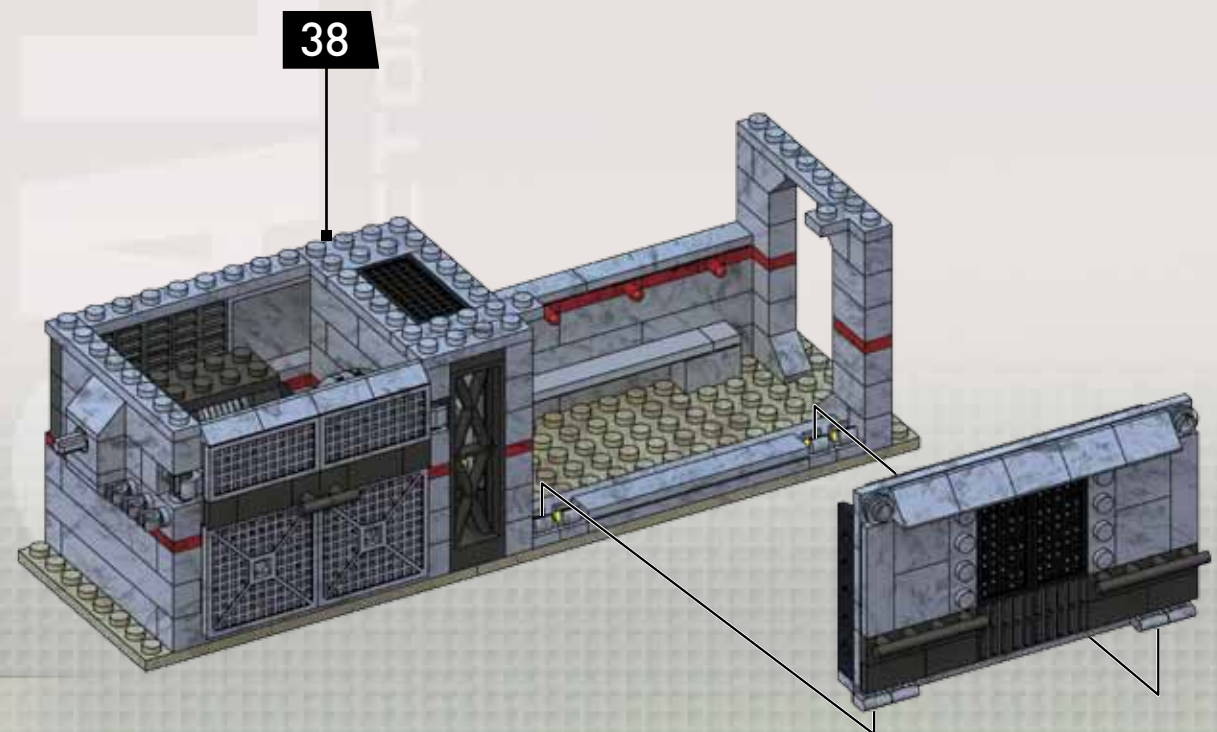

46

2X 2X 2X 2X

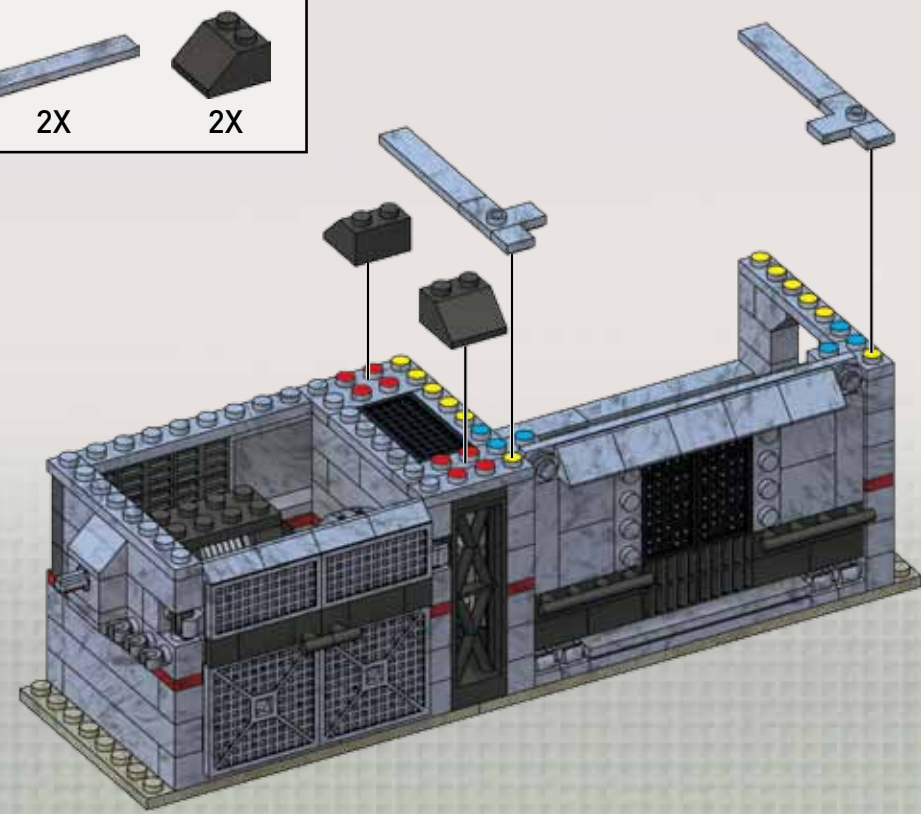

48



47

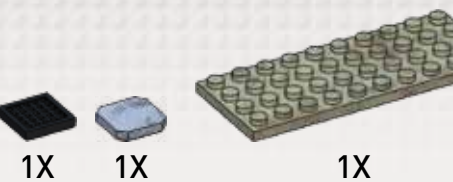
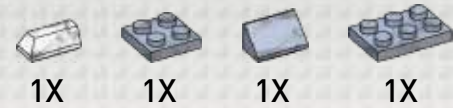

48

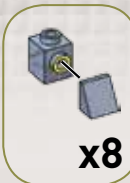
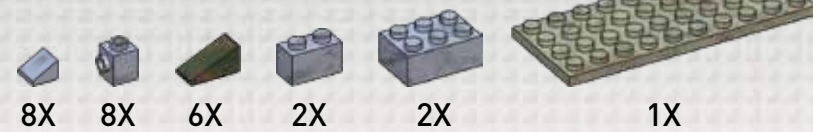

49

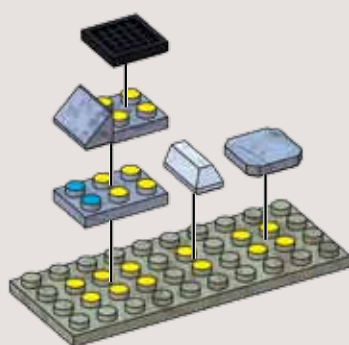
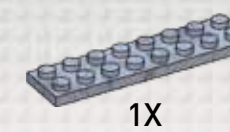

1

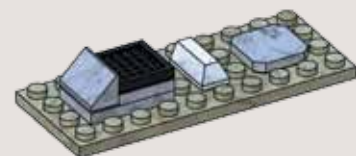

2

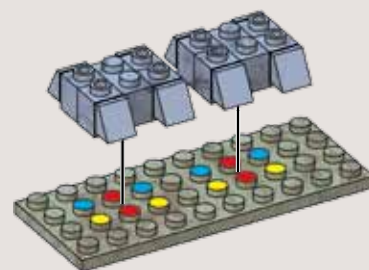

1

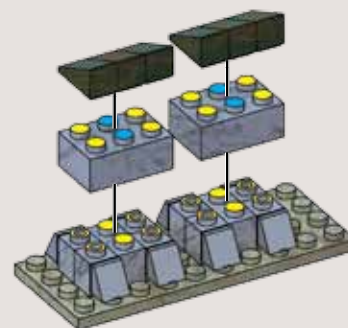

2

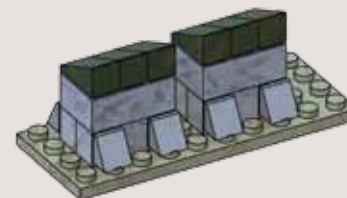

3

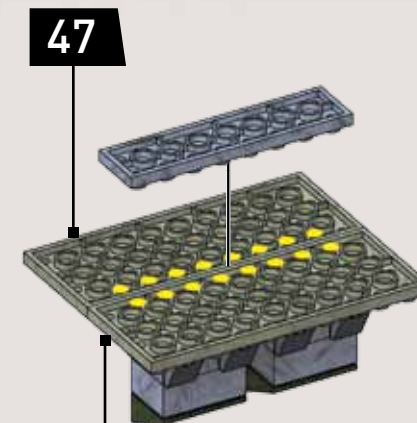

47

48

1

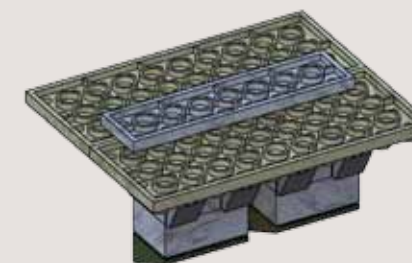

2

2

50

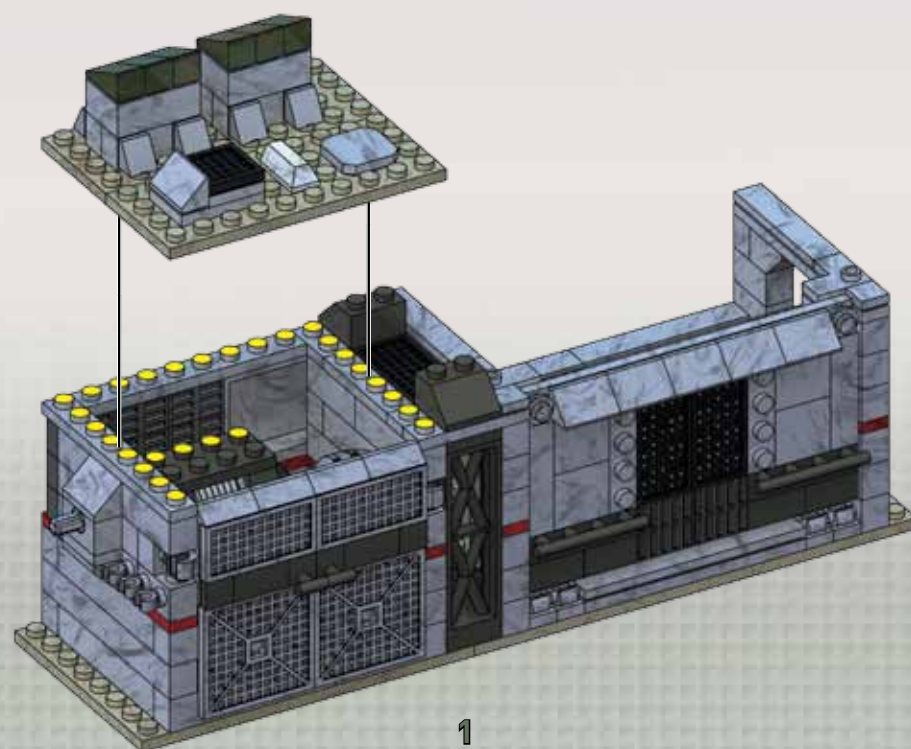

1

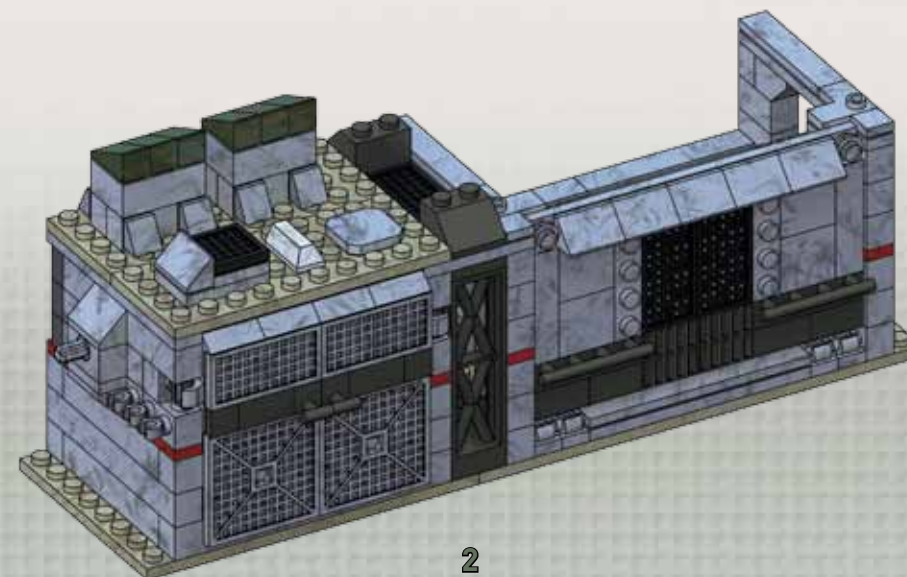

2

49



51

2X 2X 1X

1X 1X

52

4X 2X 2X 1X

2X 1X

53

2X 4X 1X

1X 1X

54

2X 2X 1X 1X

2

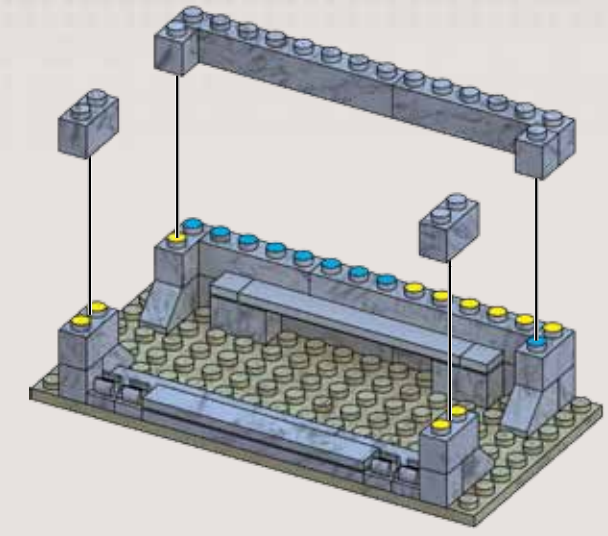
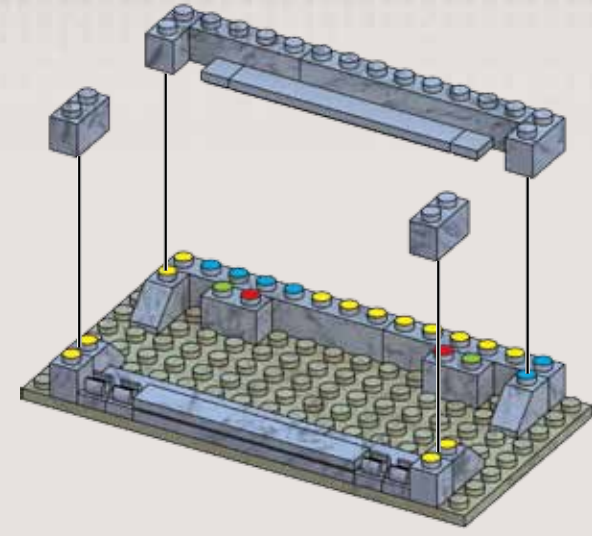
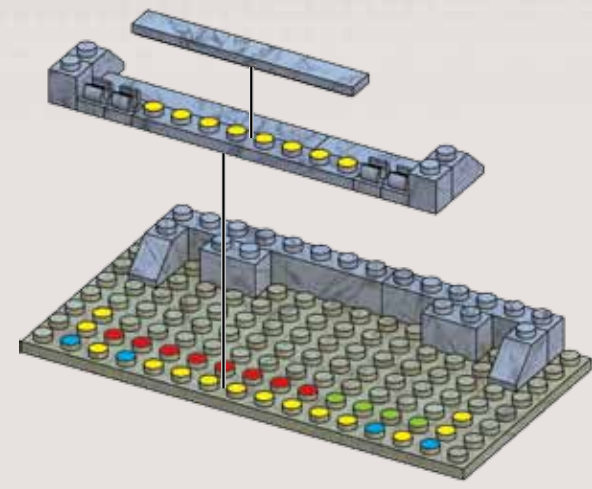
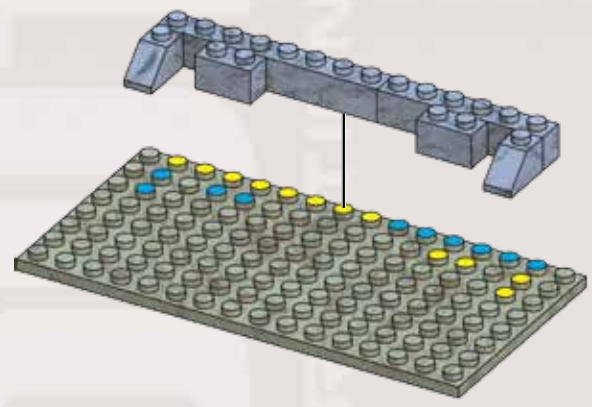

55

4X 5X 2X

56

4X 2X

57

1X 1X 4X 4X 4X 1X

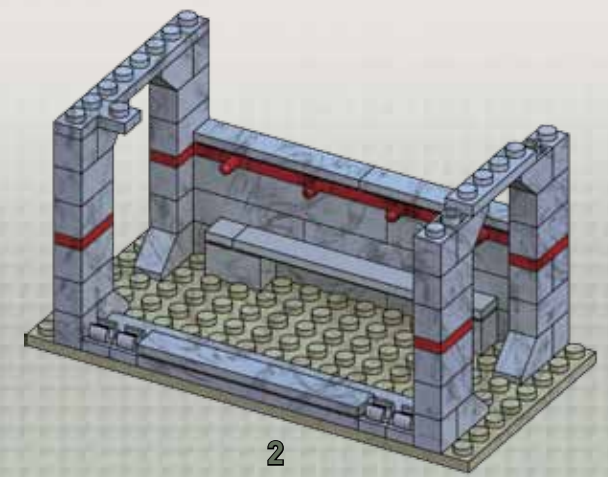
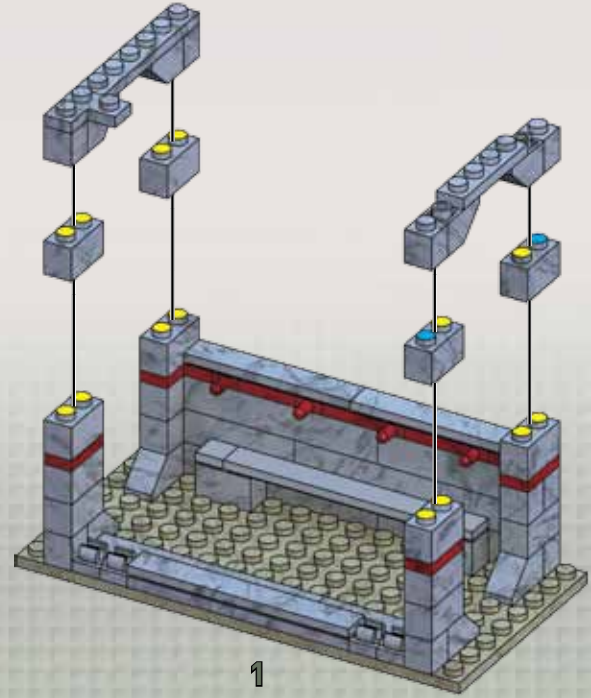
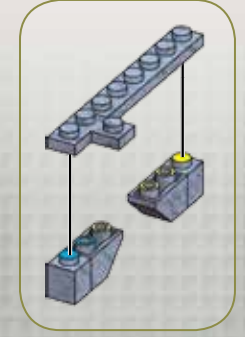
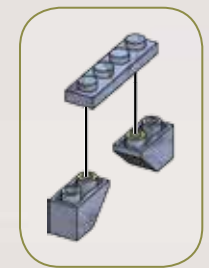
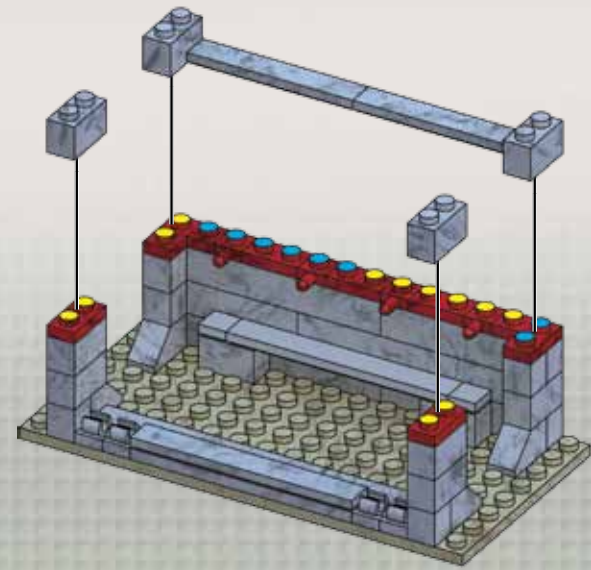
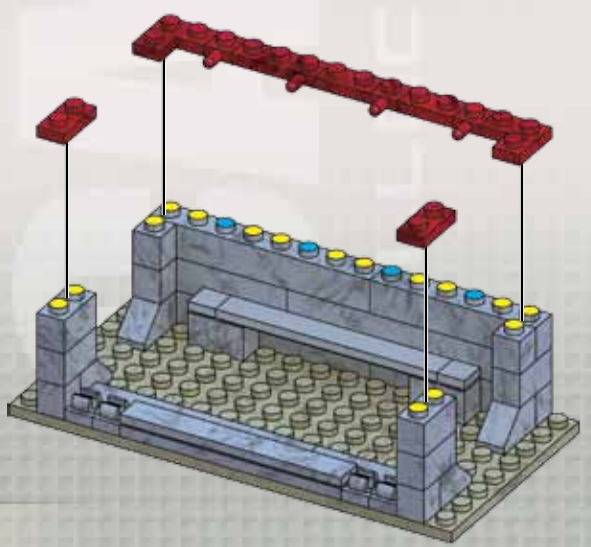



58

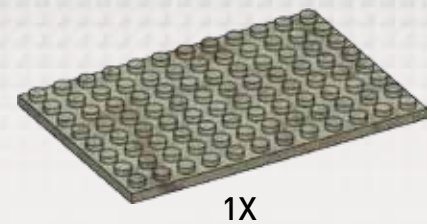
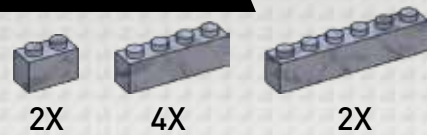

59

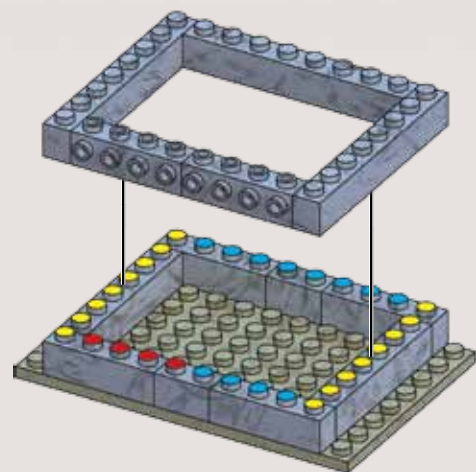
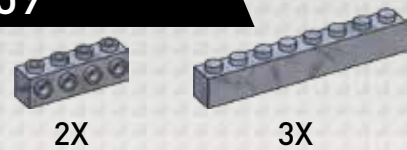

60

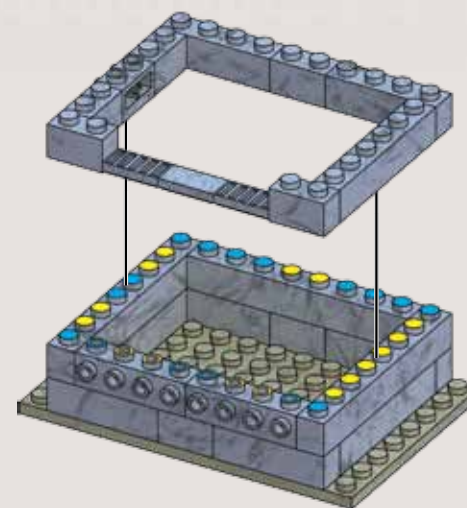

61

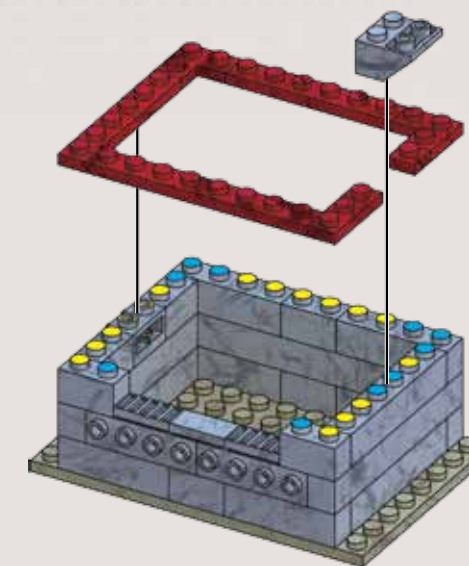

2

62

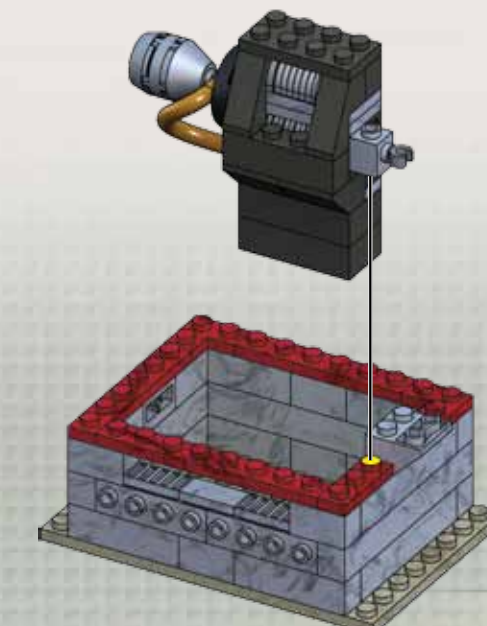
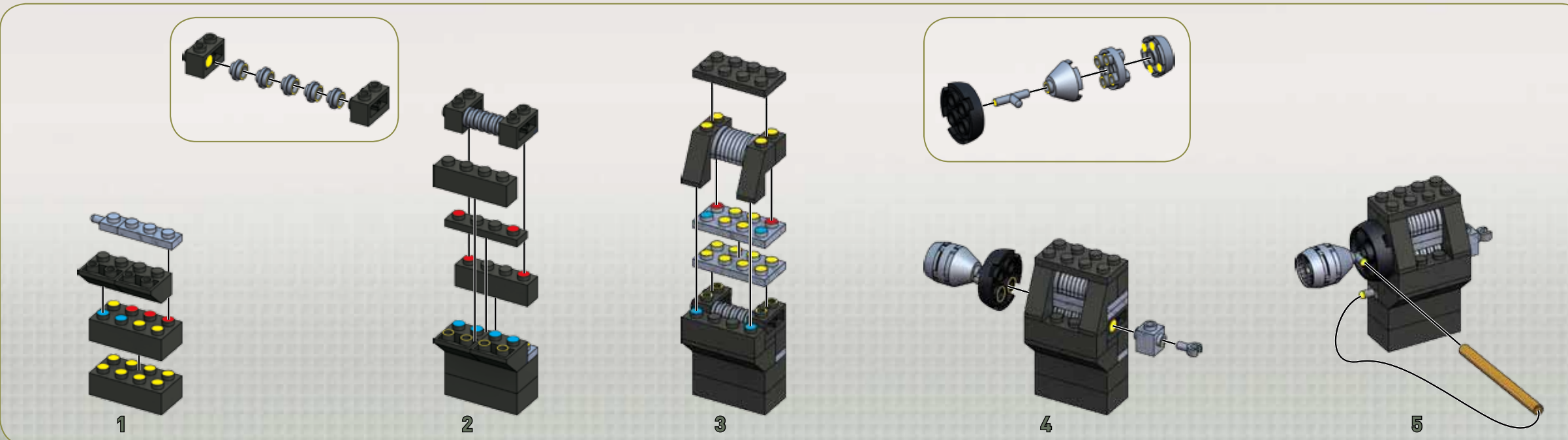

51



63

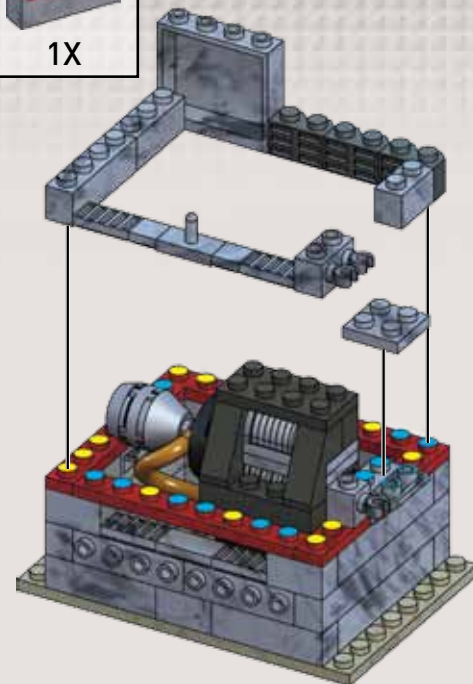
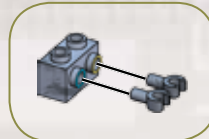
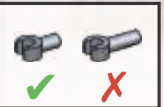
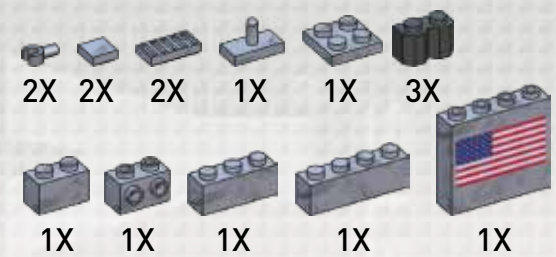

64

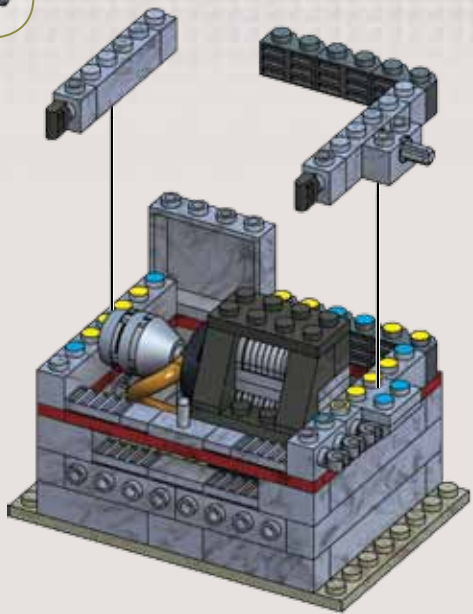
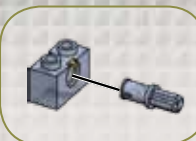

65

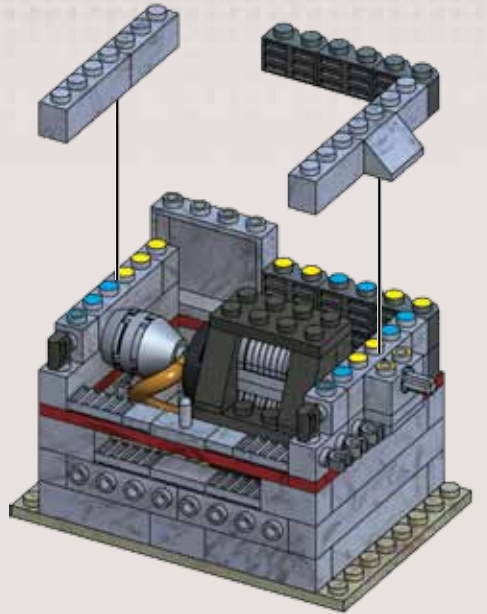
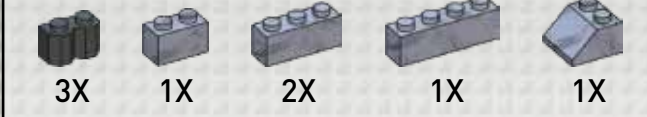

66

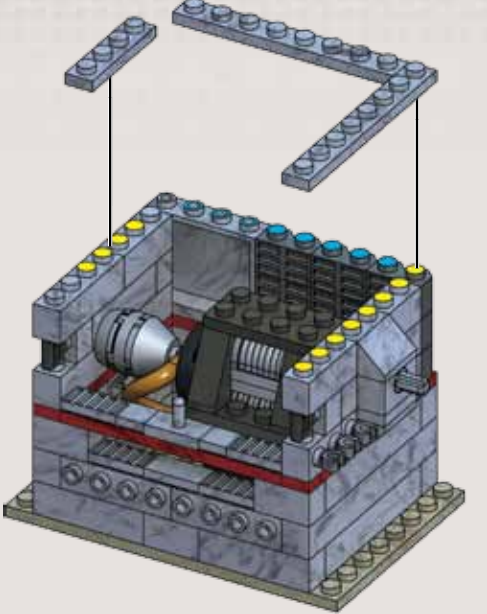
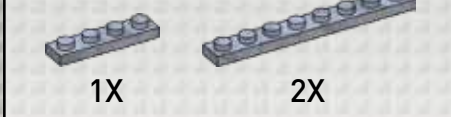

2

67

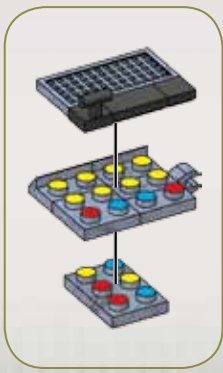
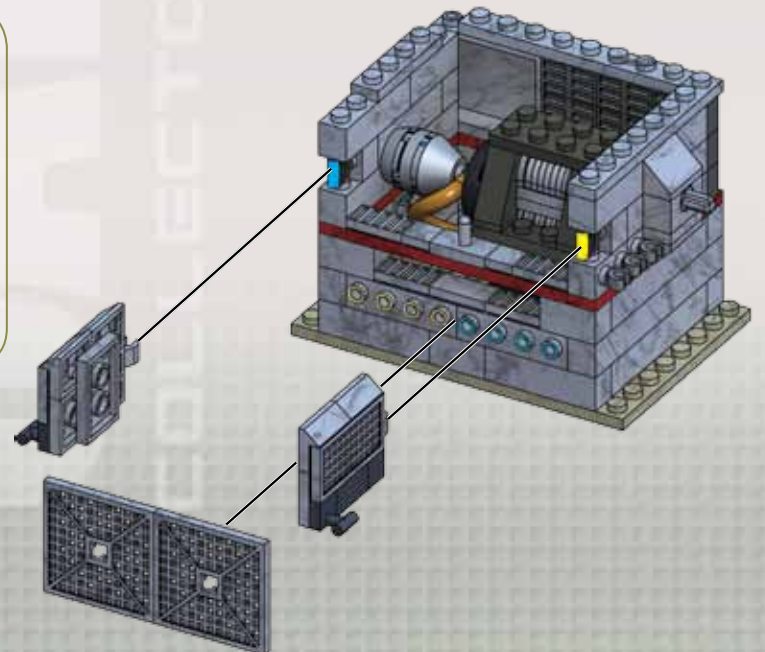

68

57

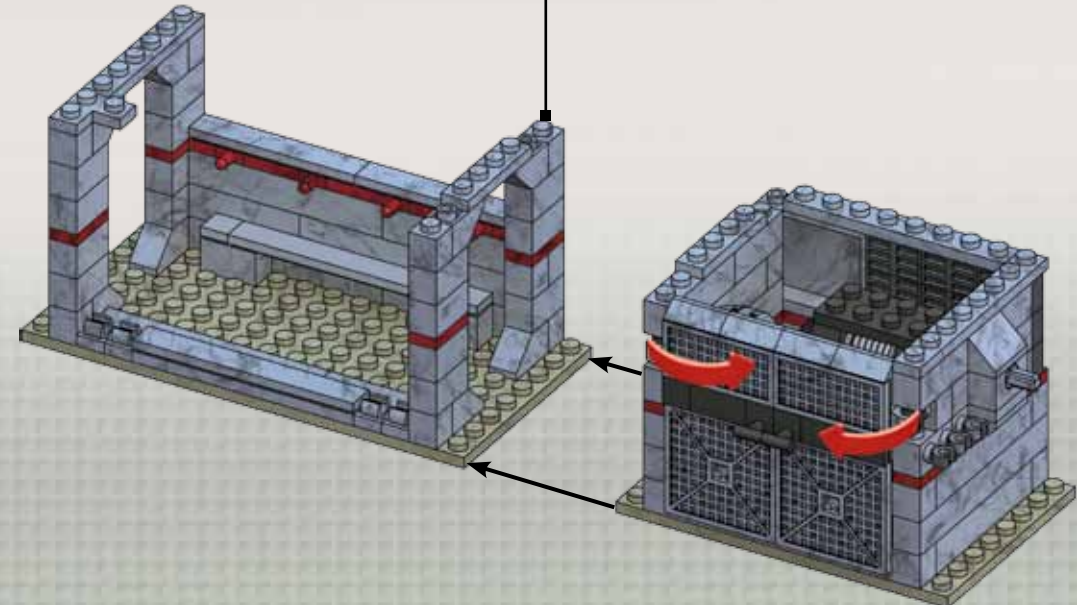



69

1X 2X

70

1X 1X 1X 1X

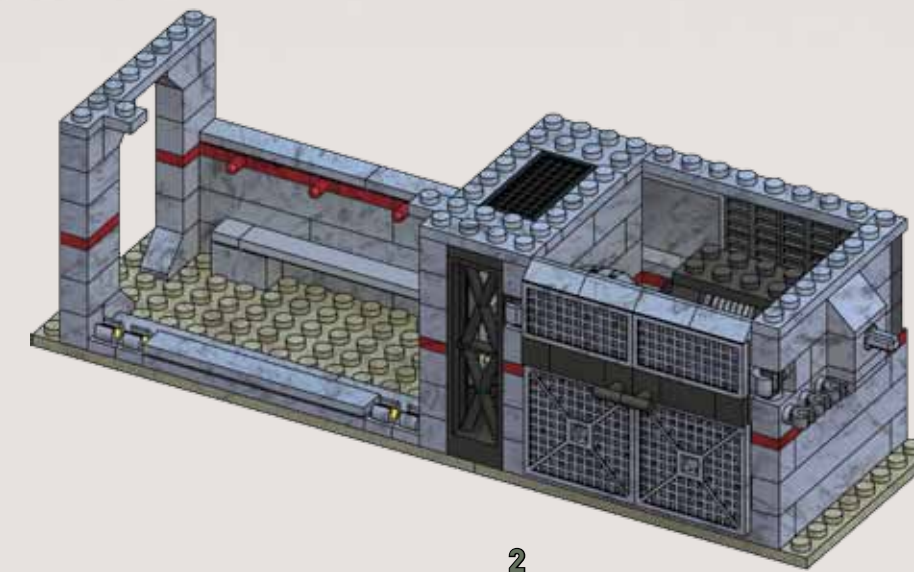
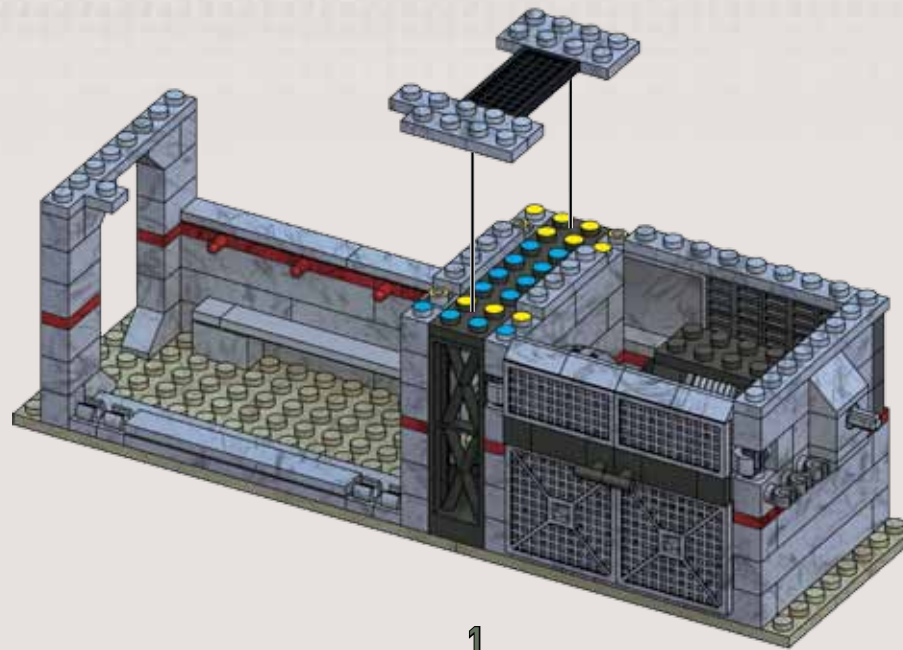
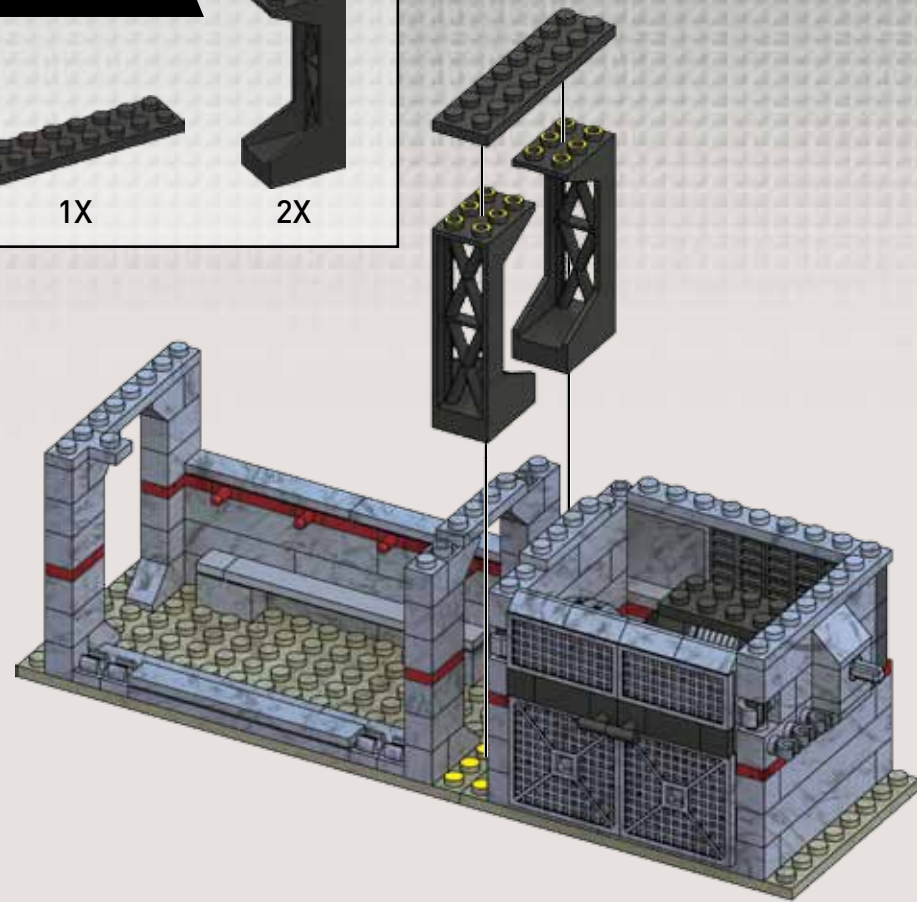

2

71

2X 1X 1X
2X 1X 2X

72

6X

73

4X 2X 2X 4X 2X 2X 1X

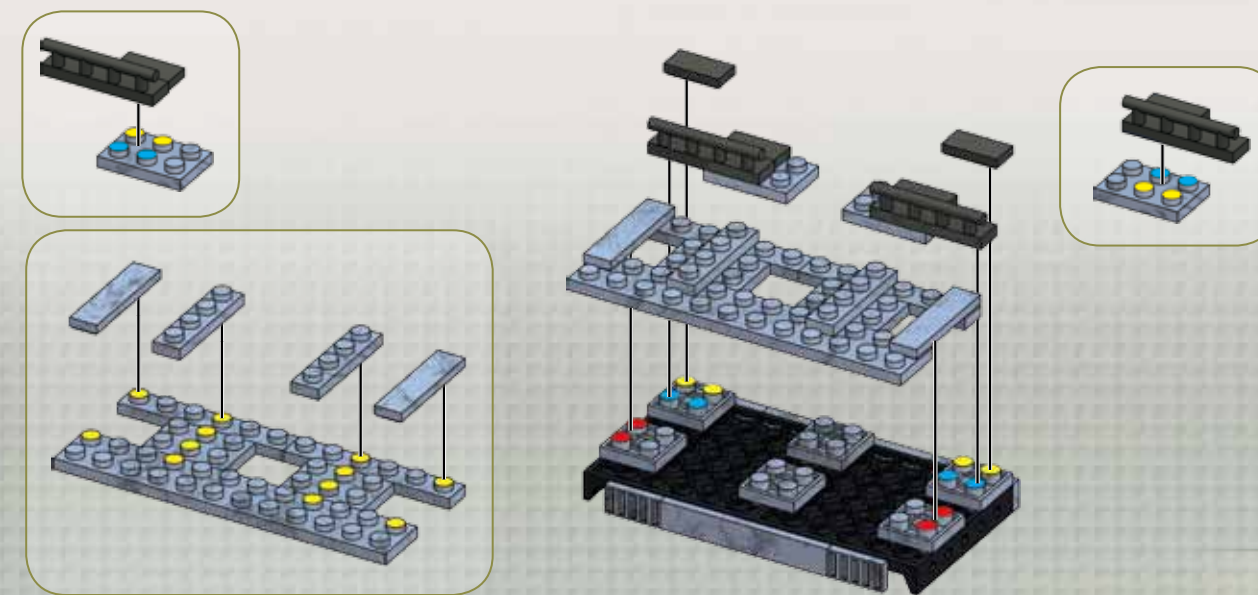
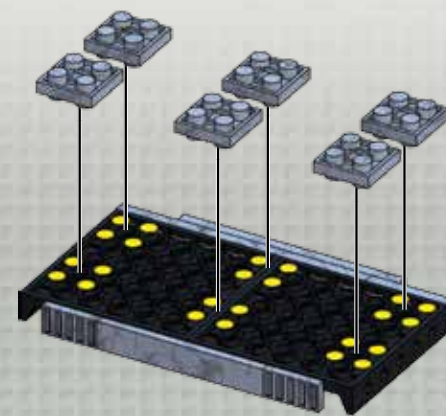
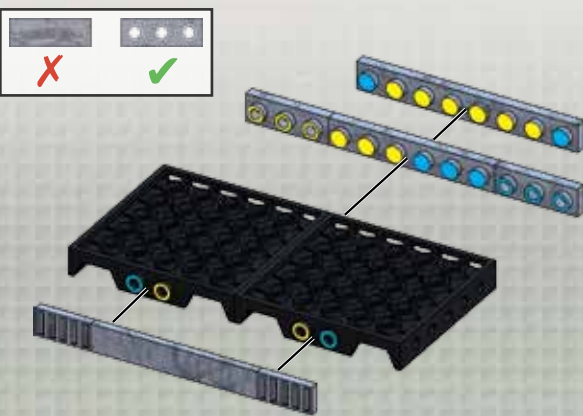



74

4X 2X

75

2X 4X 5X

76

11X 4X



2

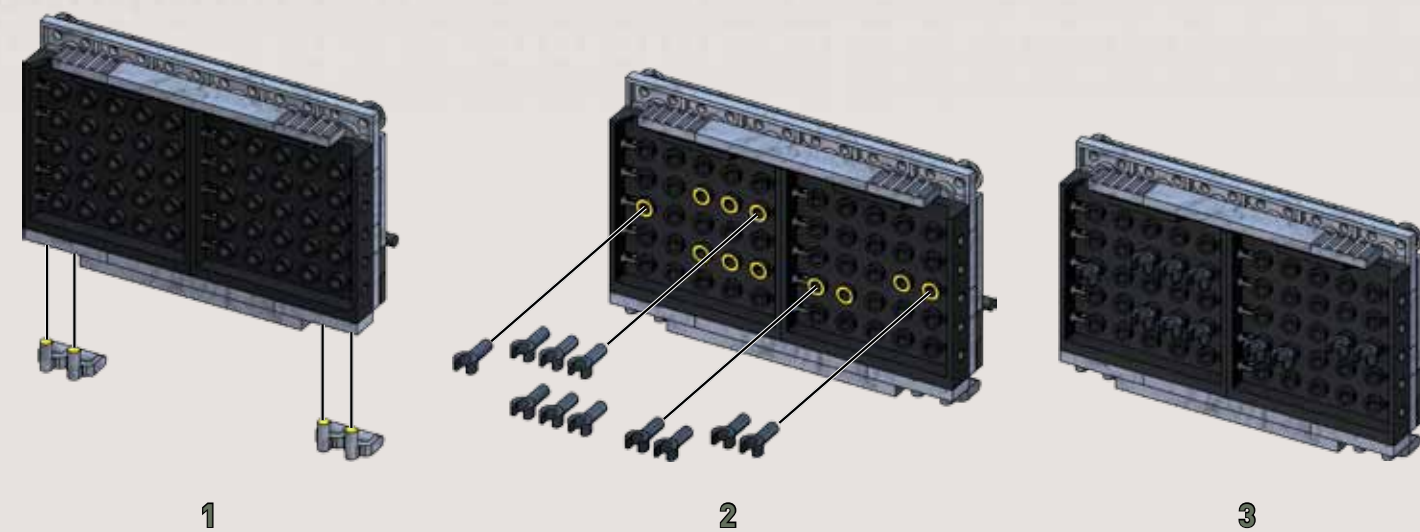
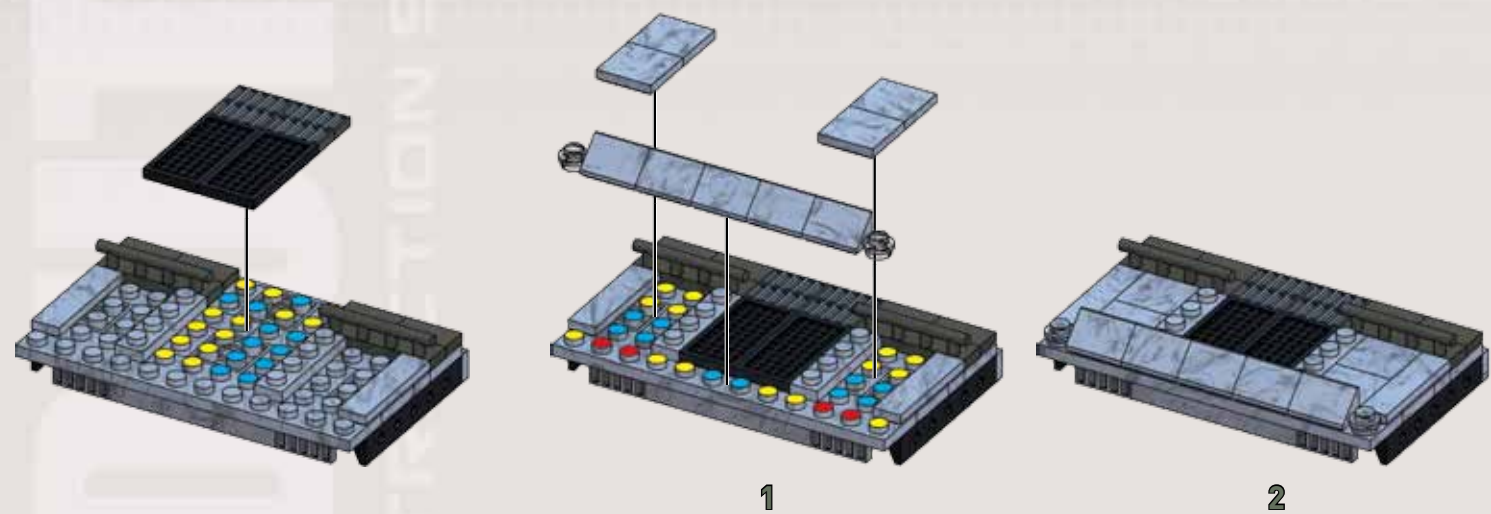

77

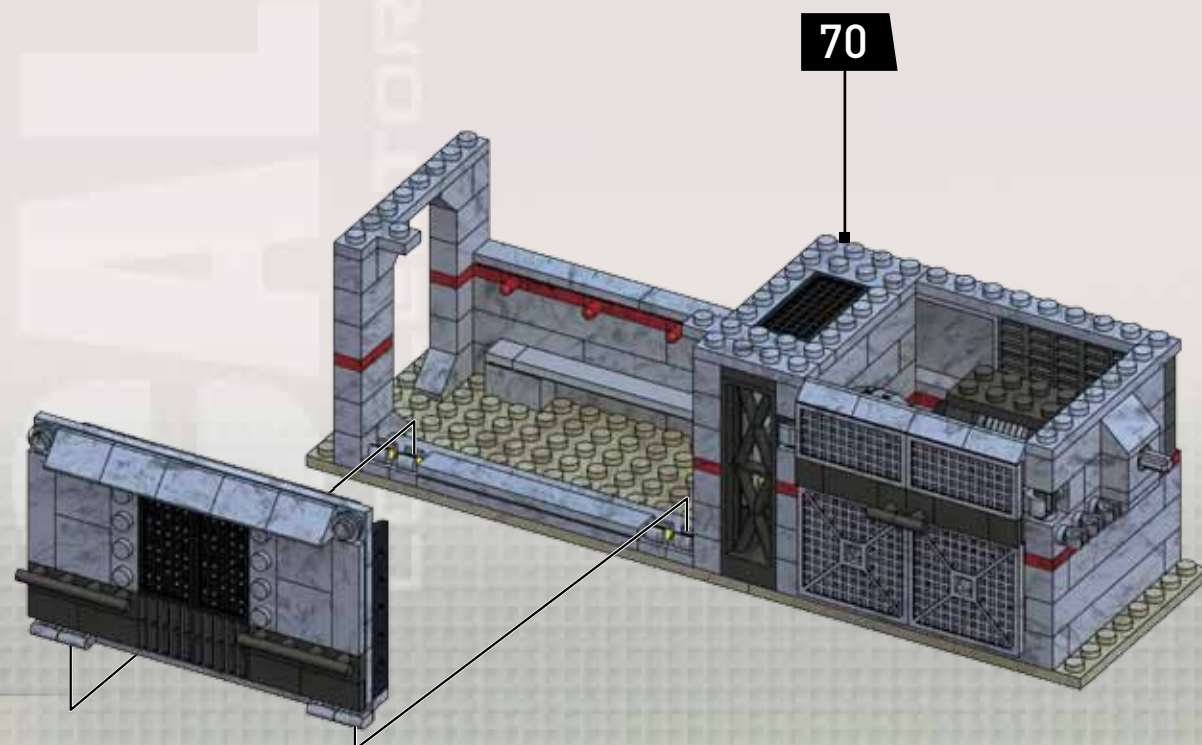

78

2X 2X
2X 2X

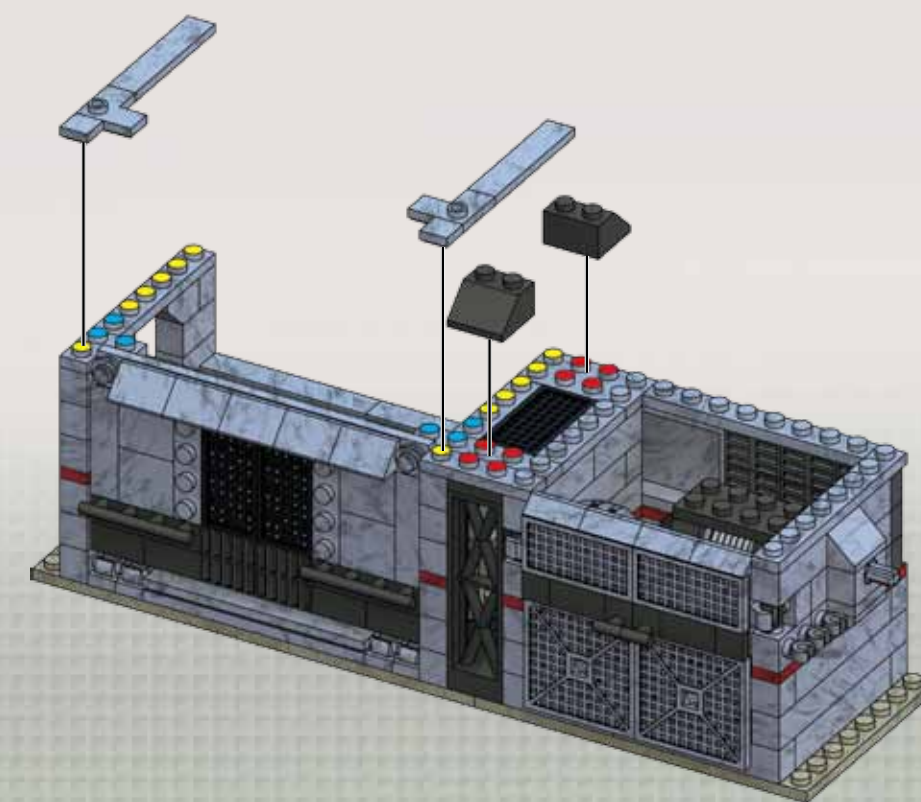

54



79

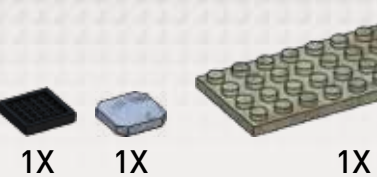
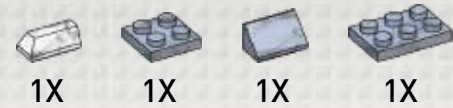

80

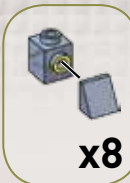
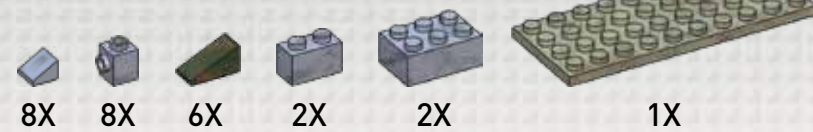

81

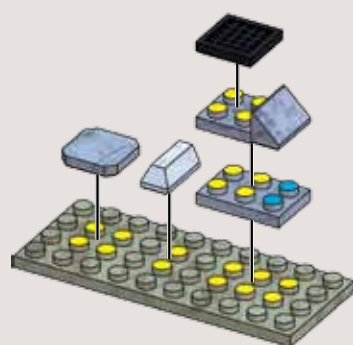
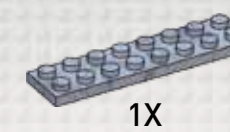

1

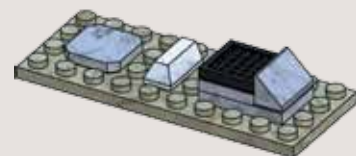

2

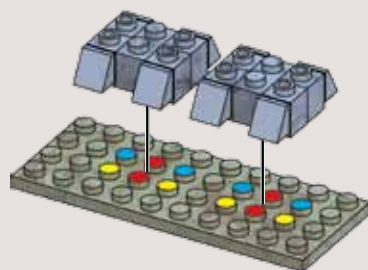

1

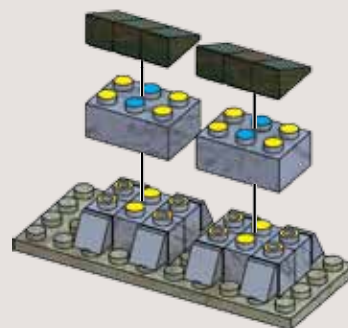

2

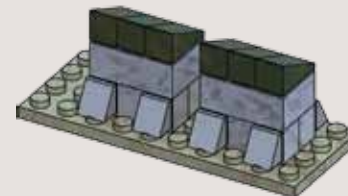

3

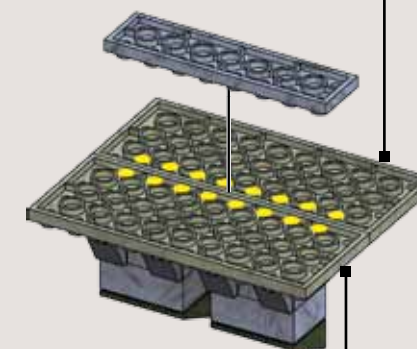

1

79

80

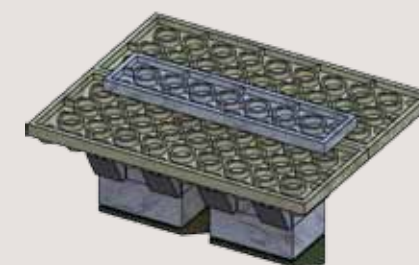

2

2

82

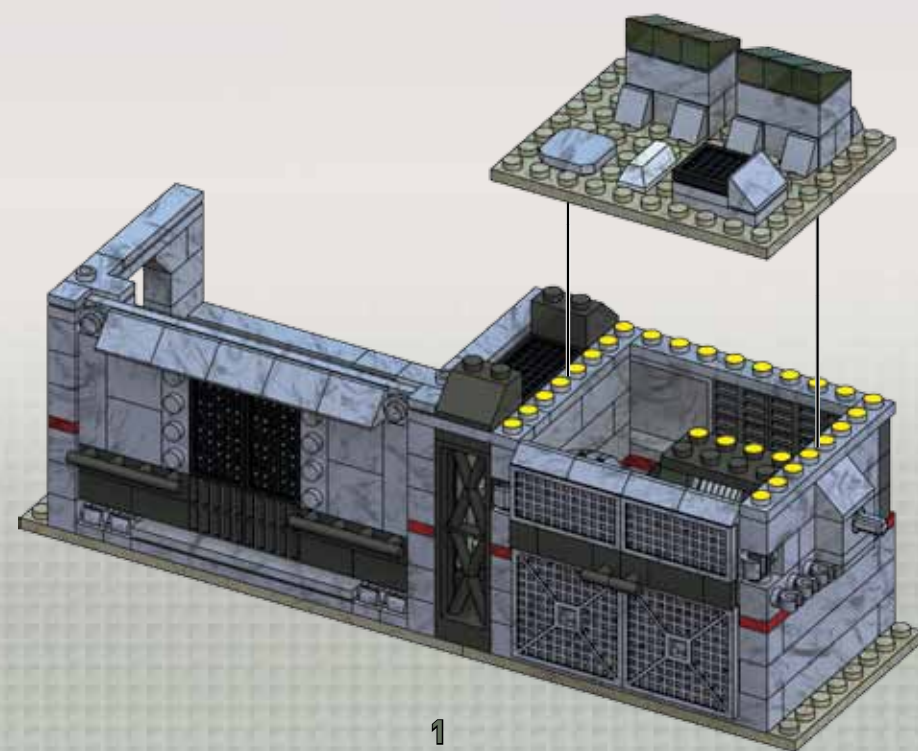

1

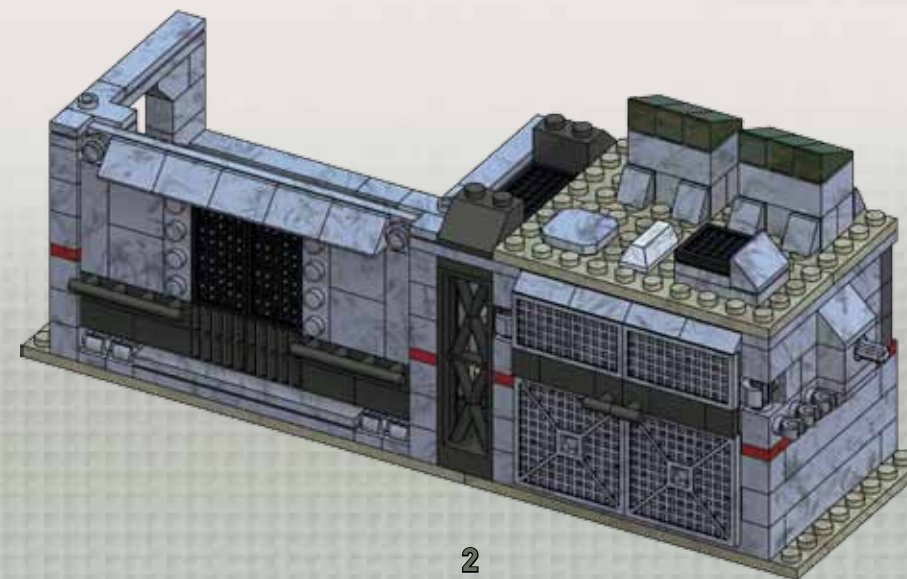

2

55



83

2

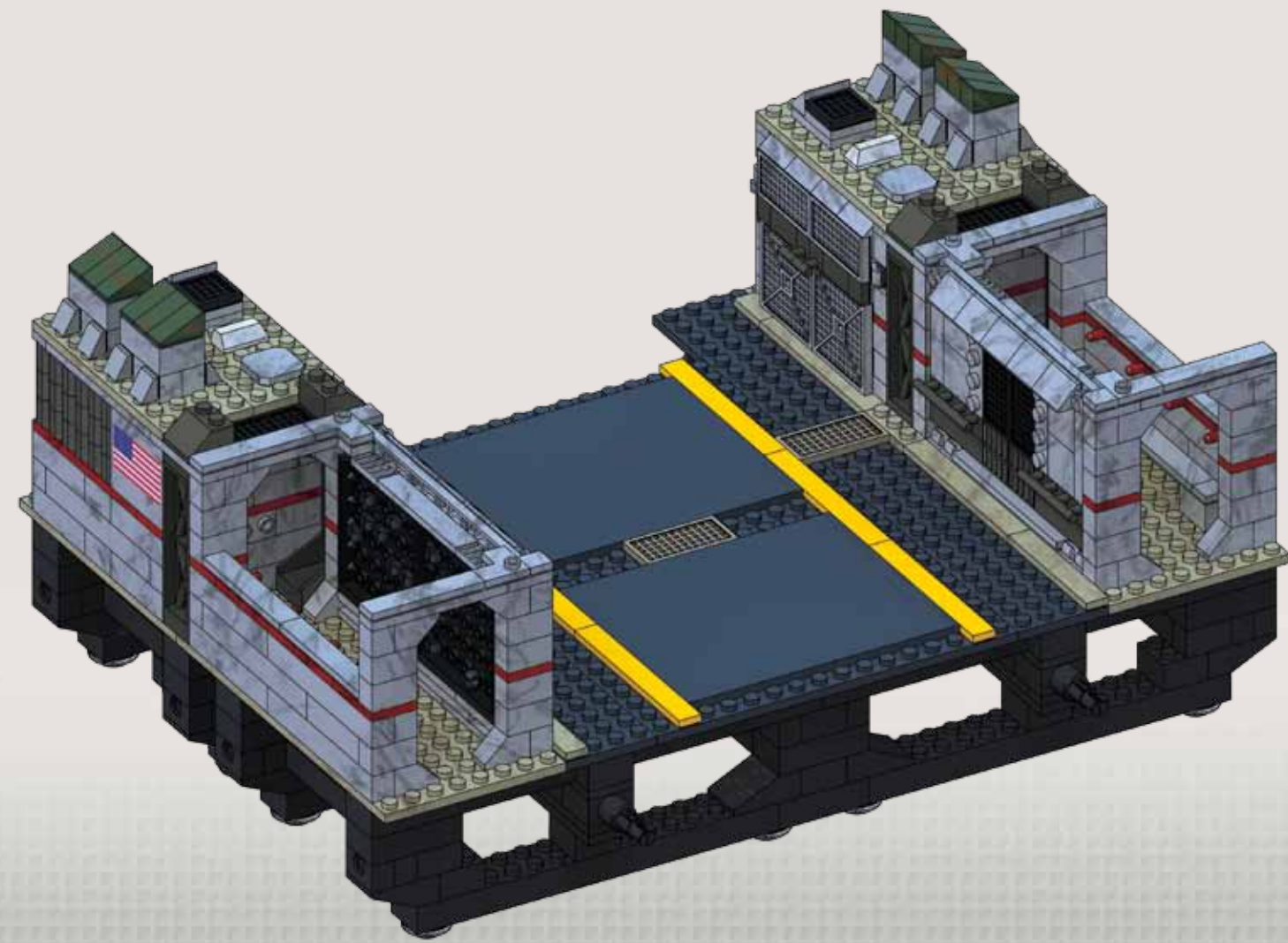
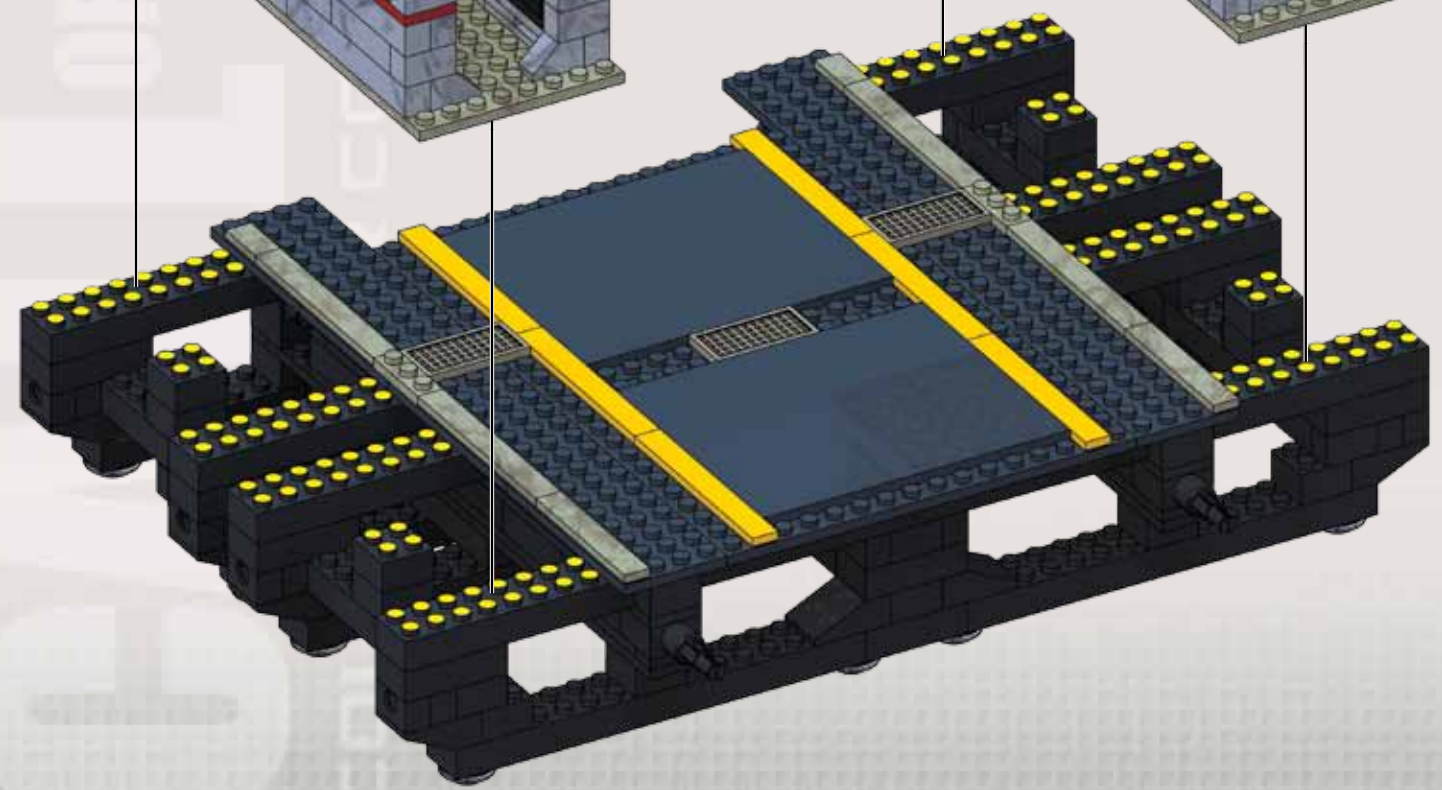
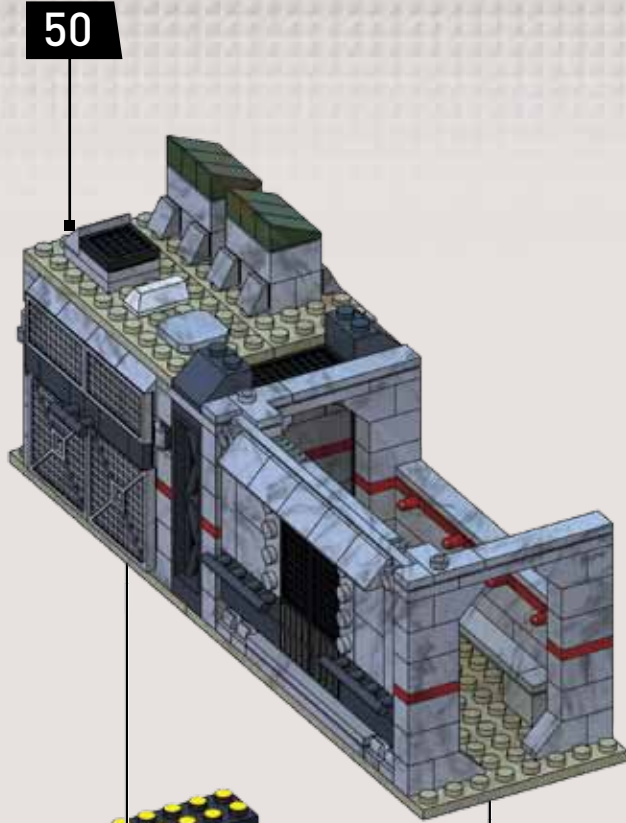
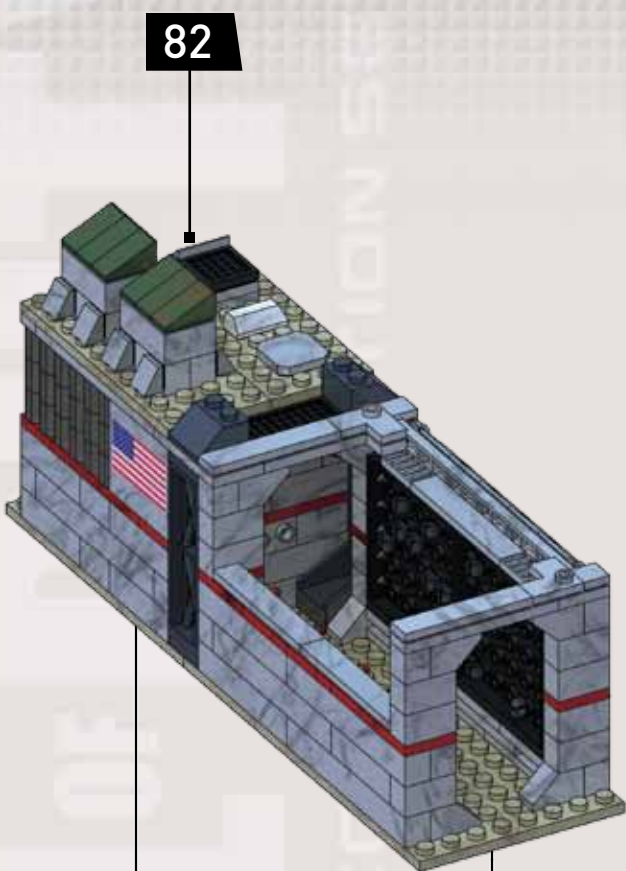



84

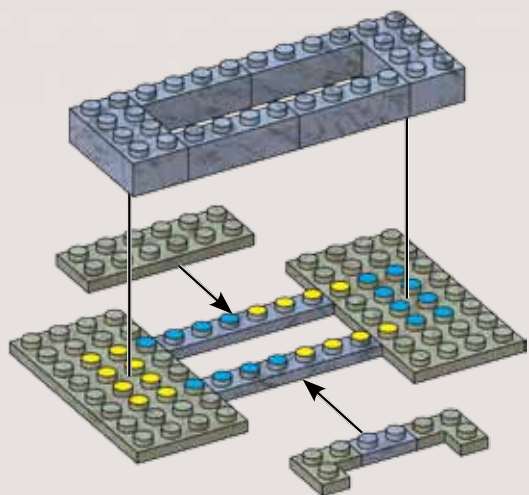
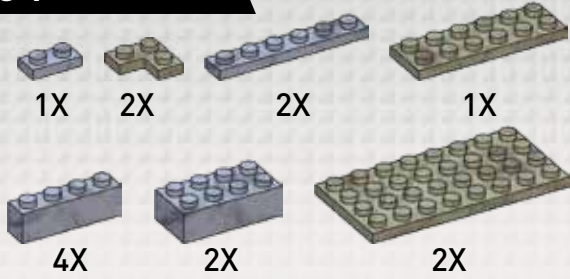

85

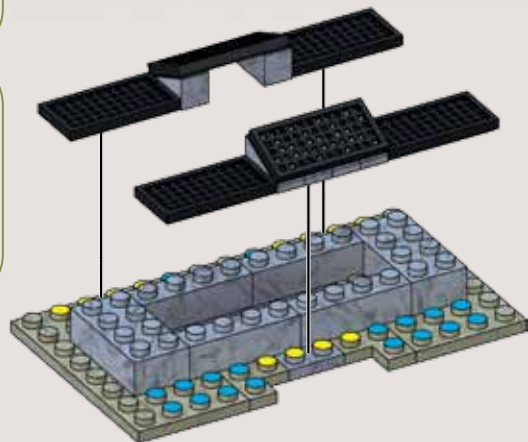
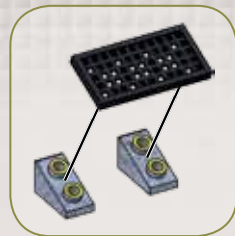

86

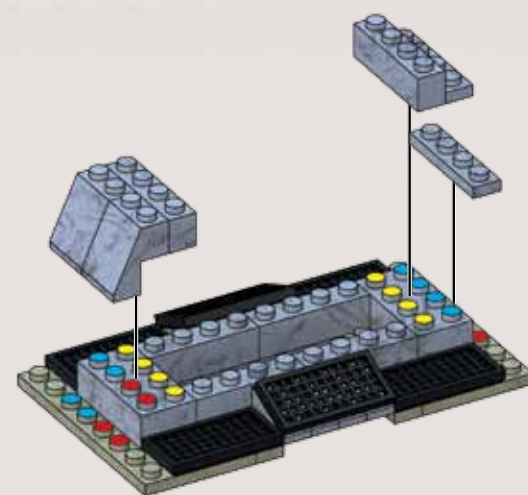
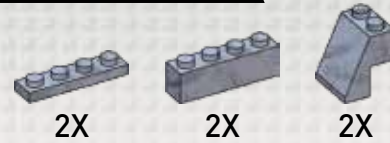

87

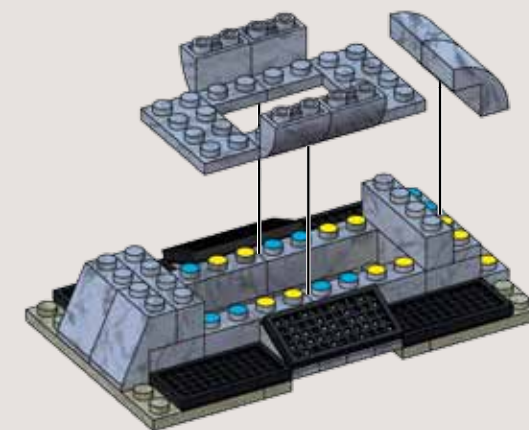
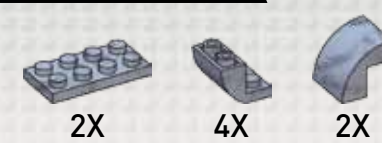

2

88

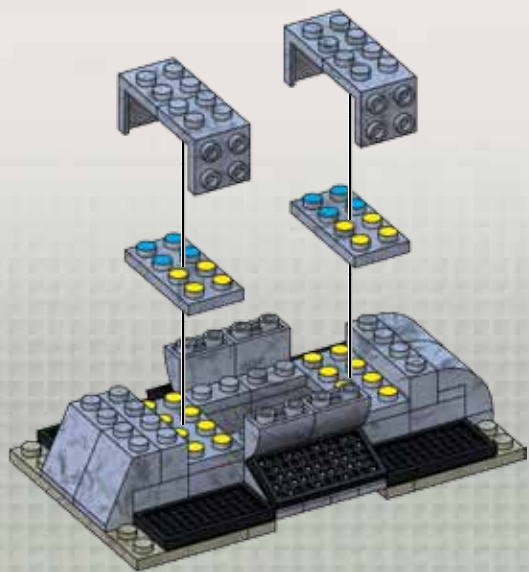
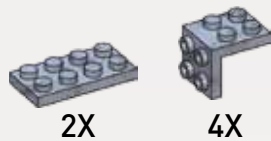

89

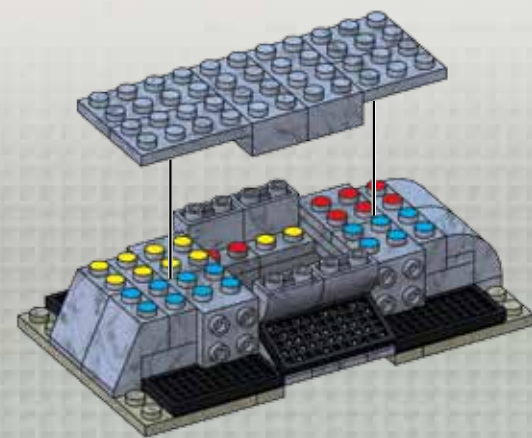

90

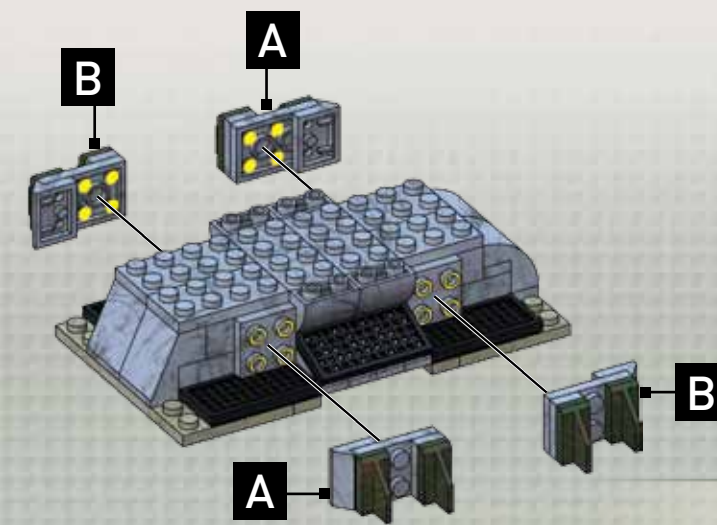
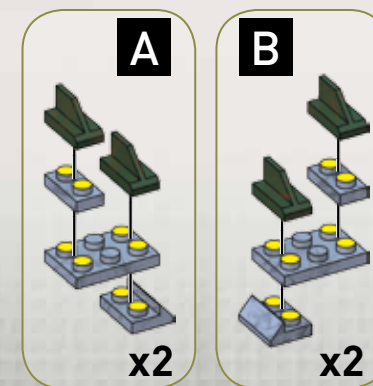



2

91

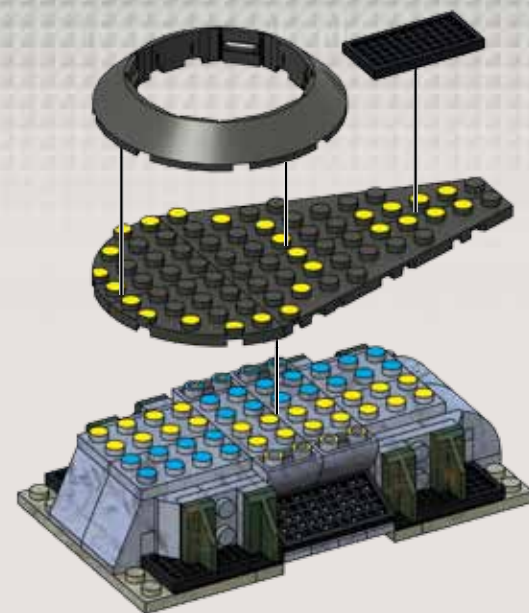
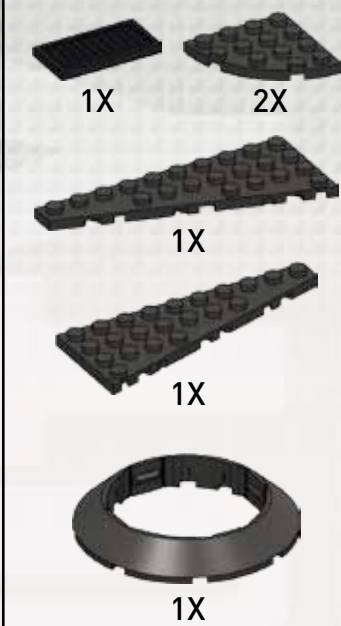

92

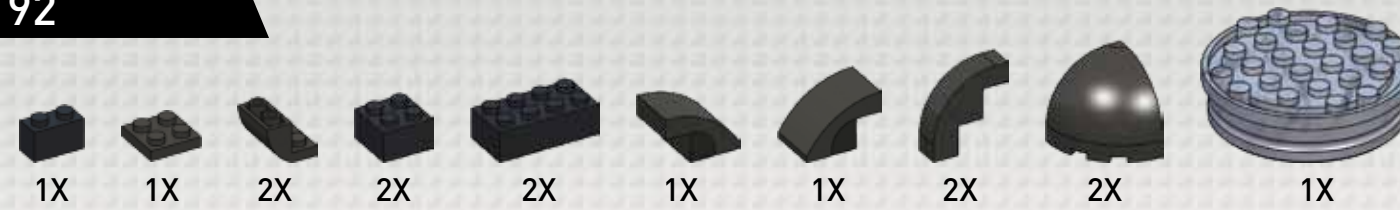

93

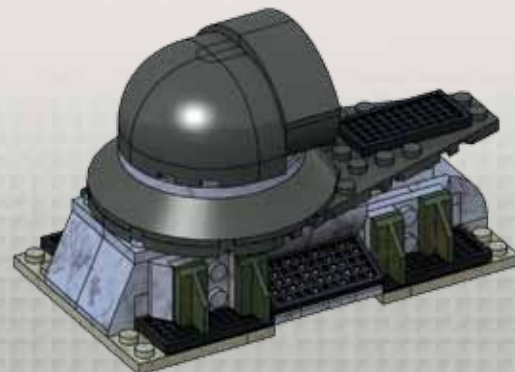

94

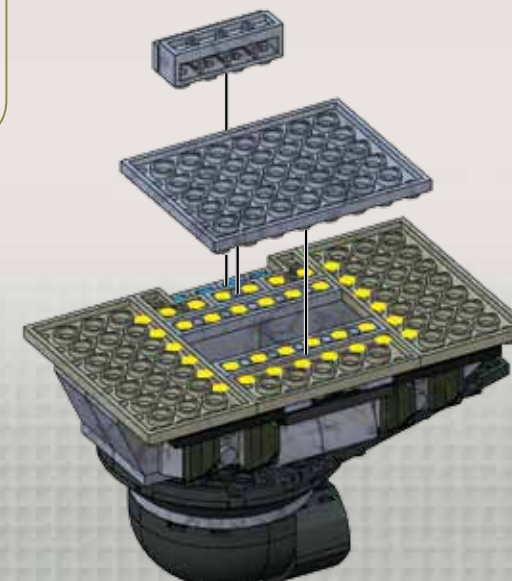
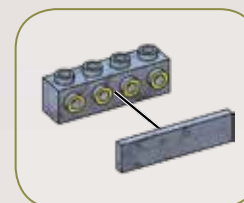
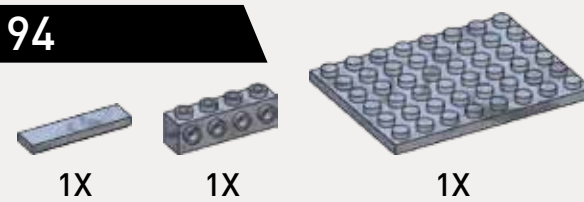

95

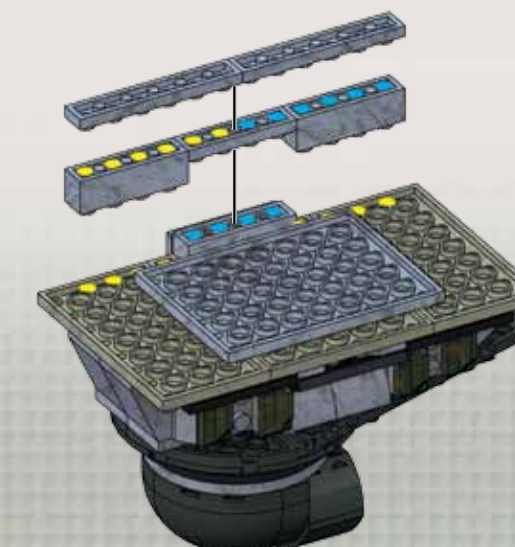
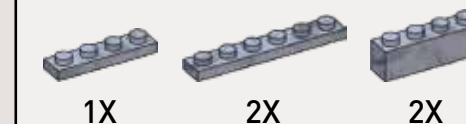



96

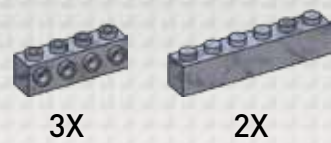

1

97

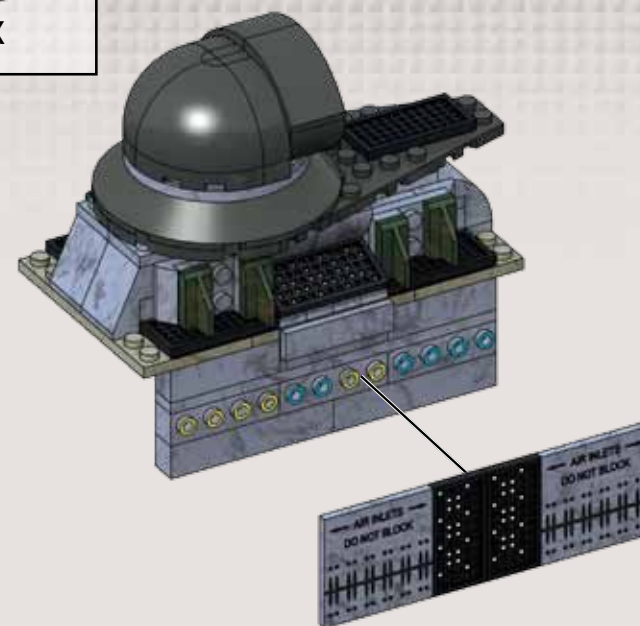

1

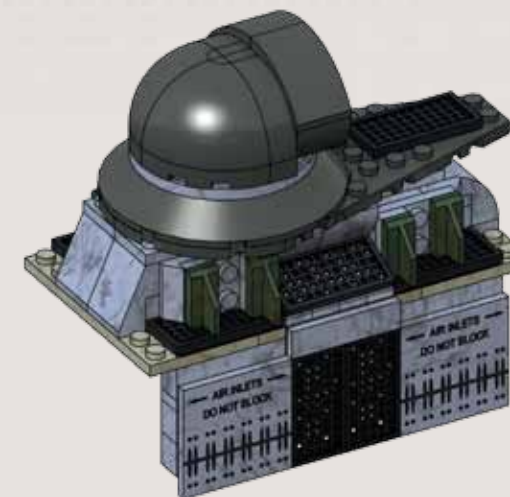

2

2

98

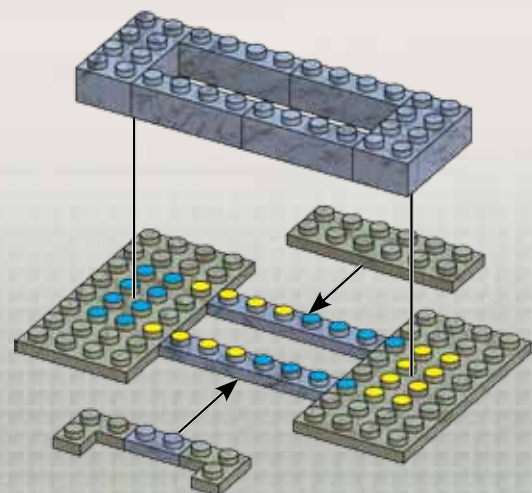
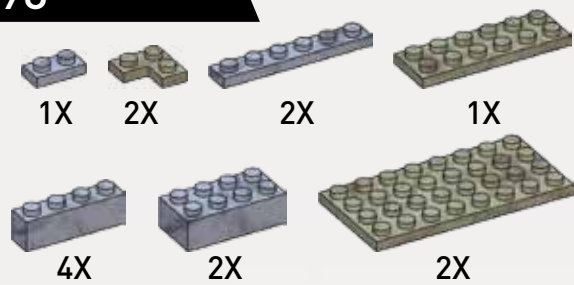

99

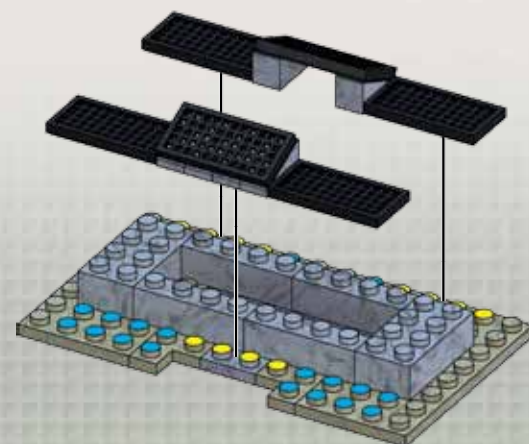

100

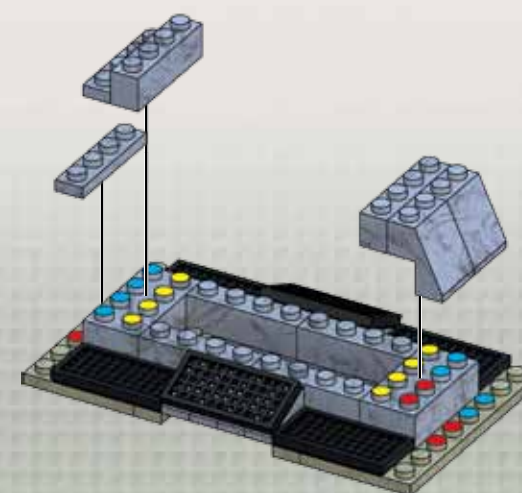
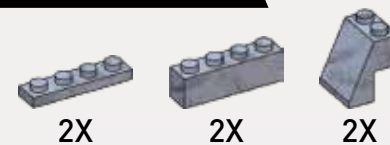

101

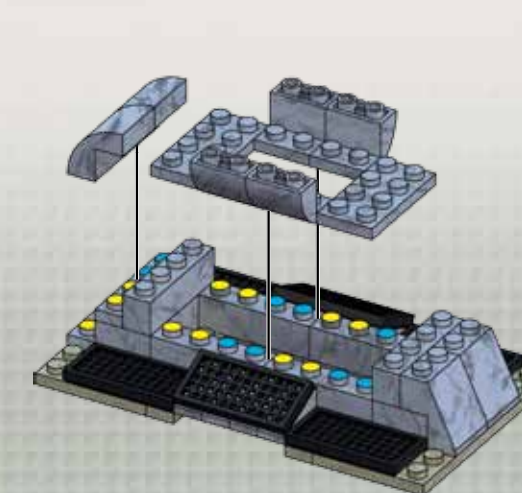
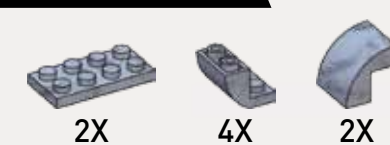



102

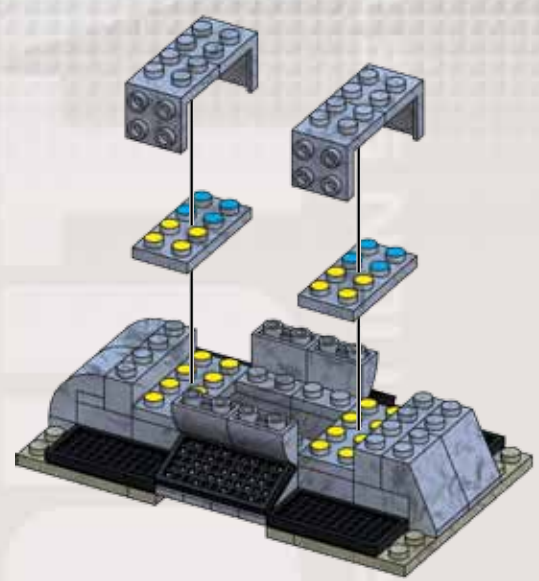
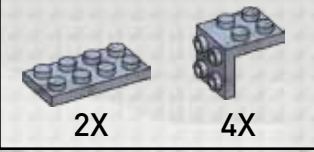

103

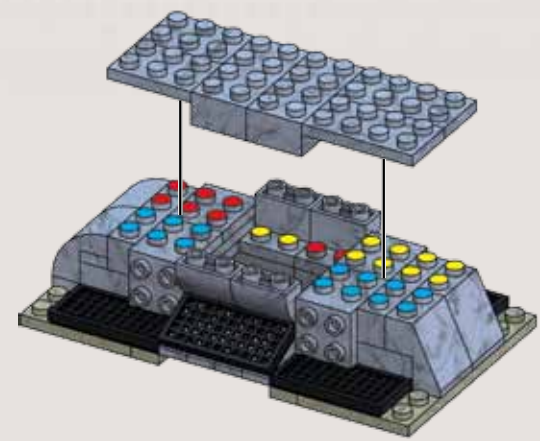

104

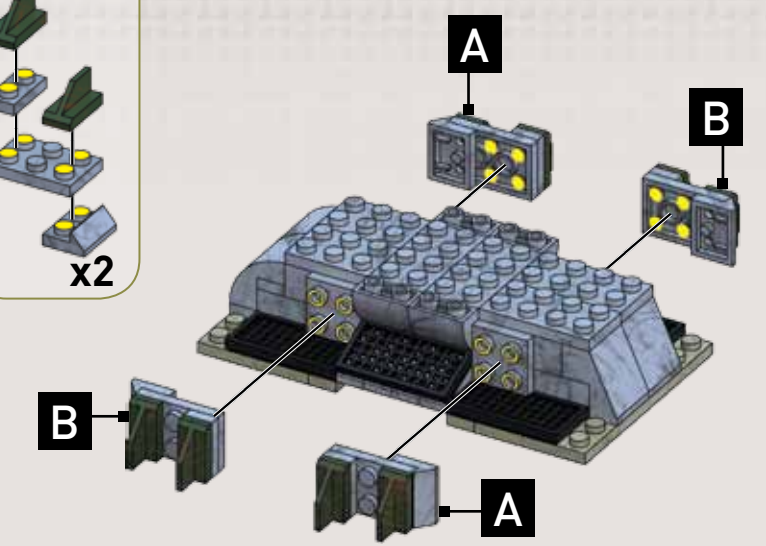
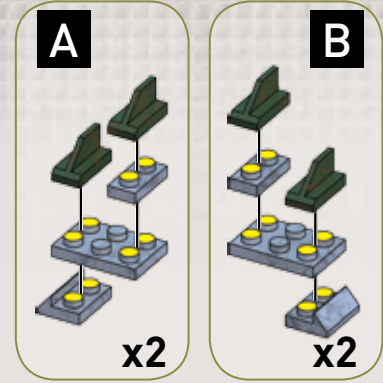
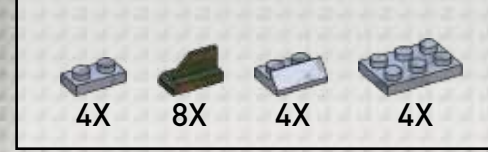

2

105

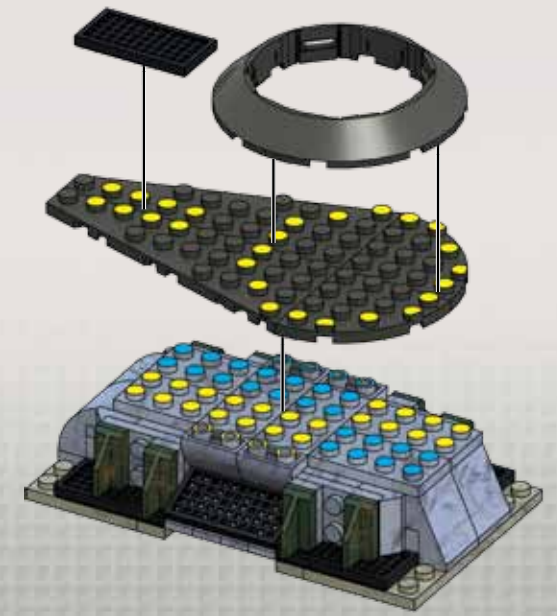
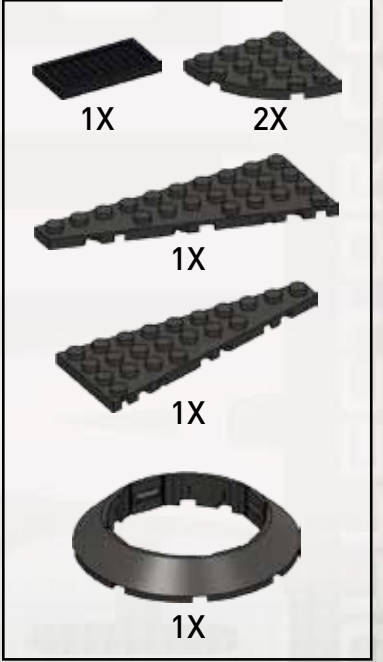

106

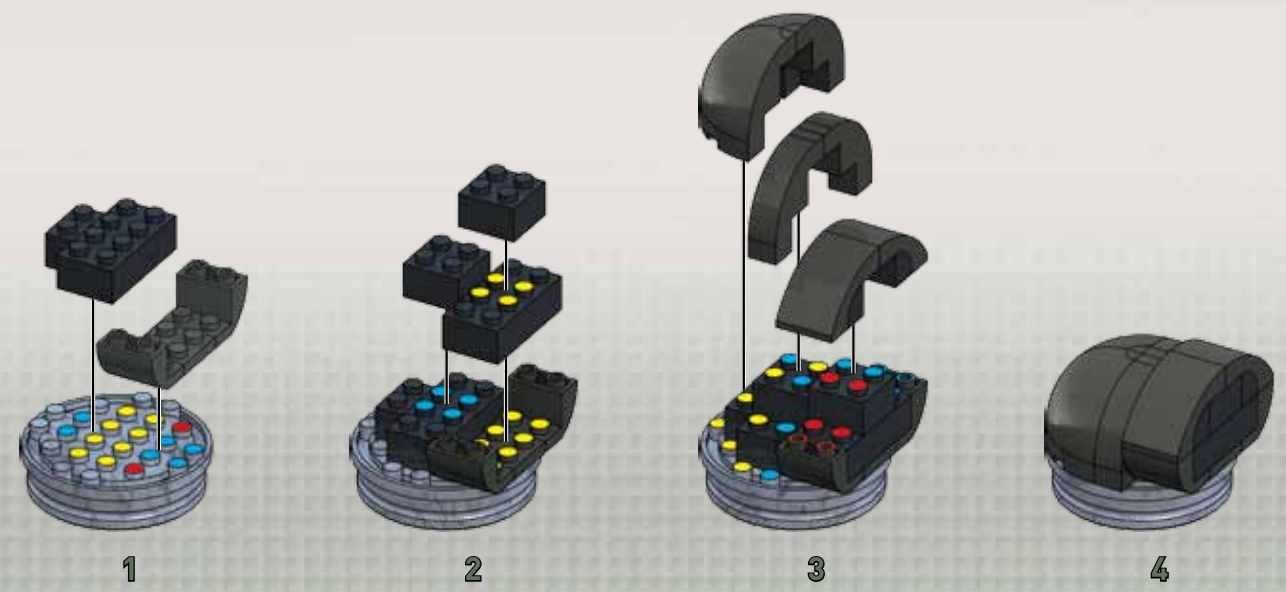
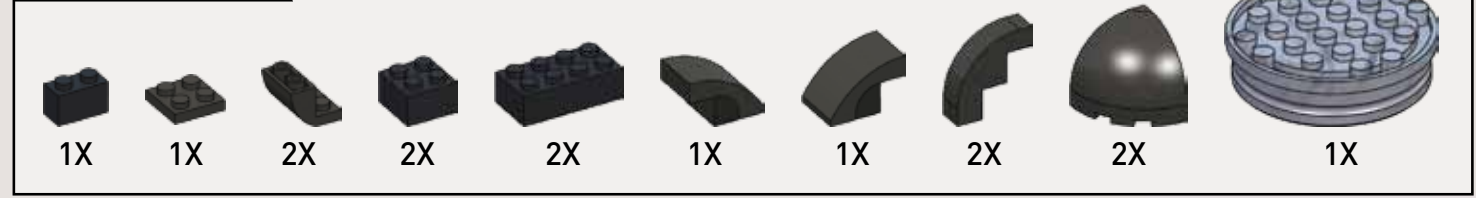



107

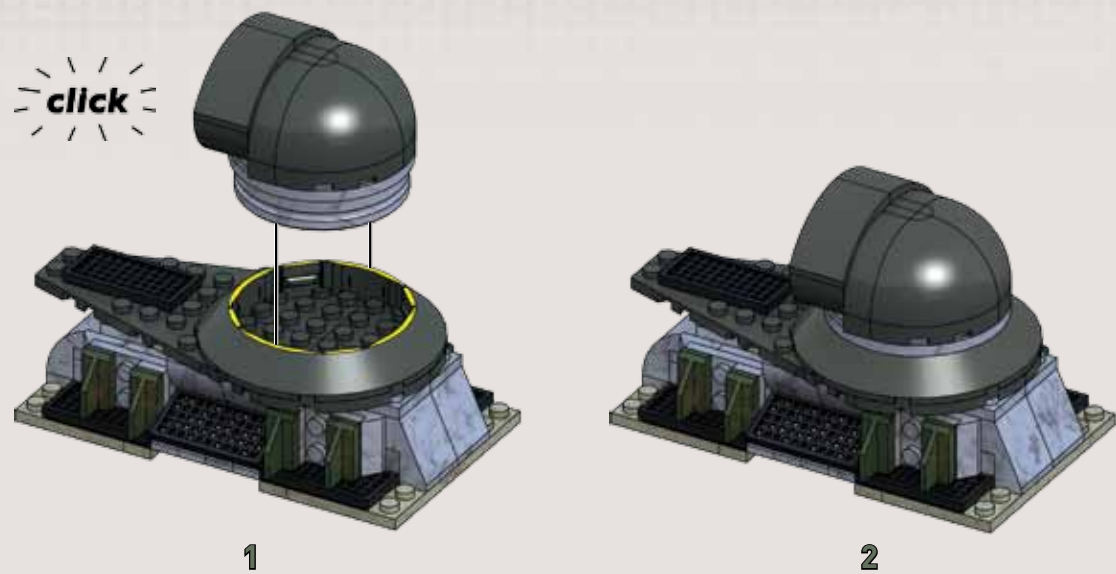

108

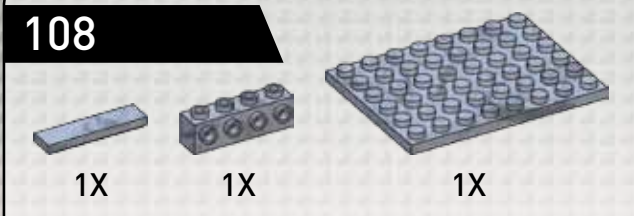

109

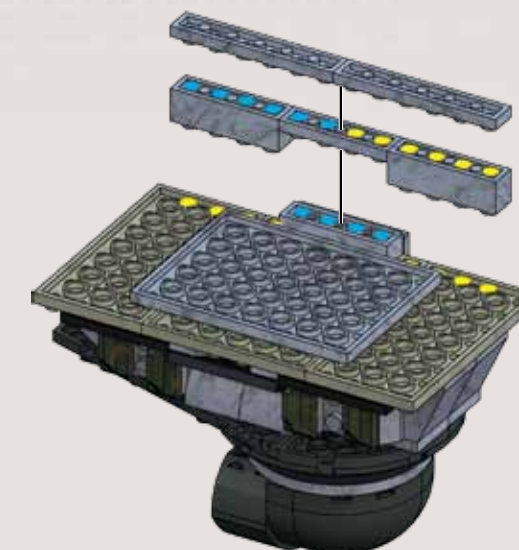
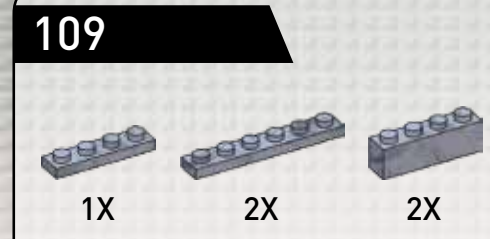

2

110

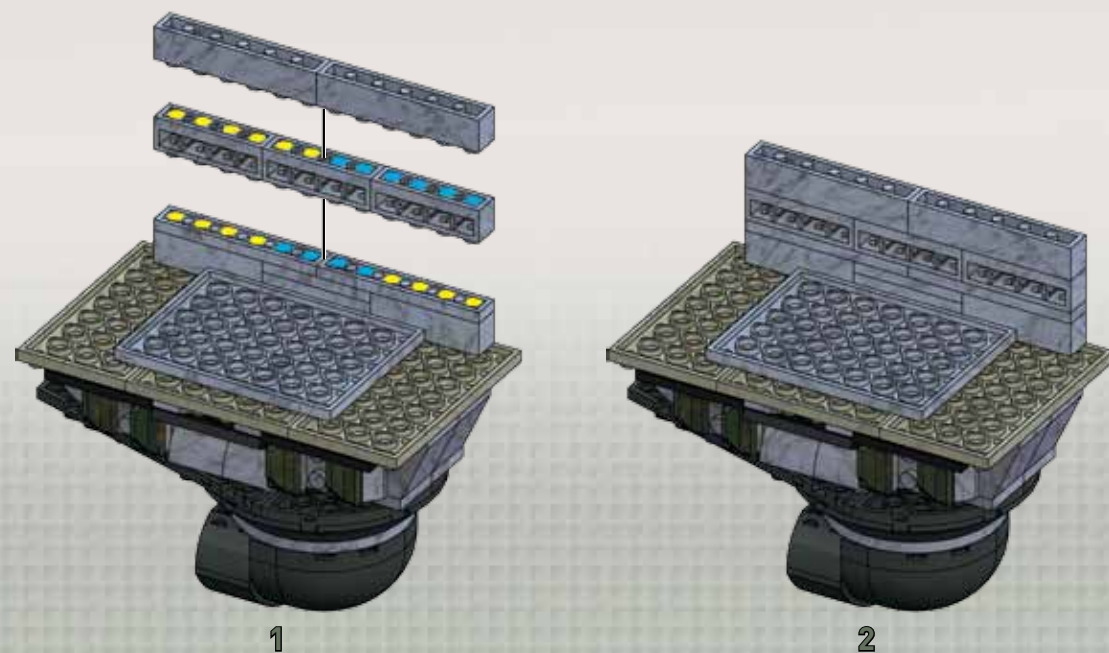
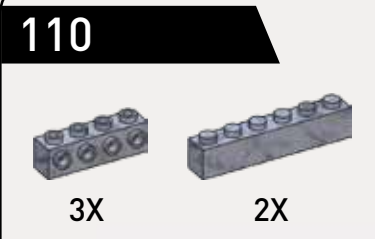

111

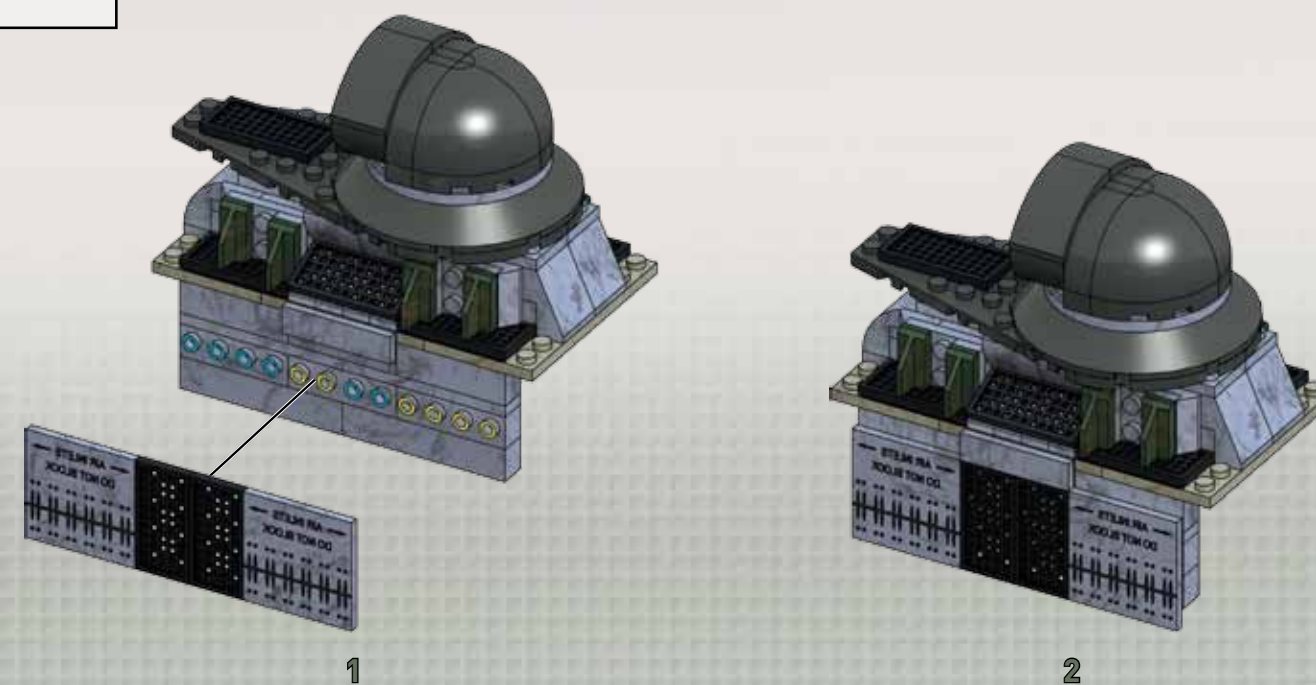



112

2X

113

8X 8X 4X 8X 8X 28X 4X 12X 16X 28X

2

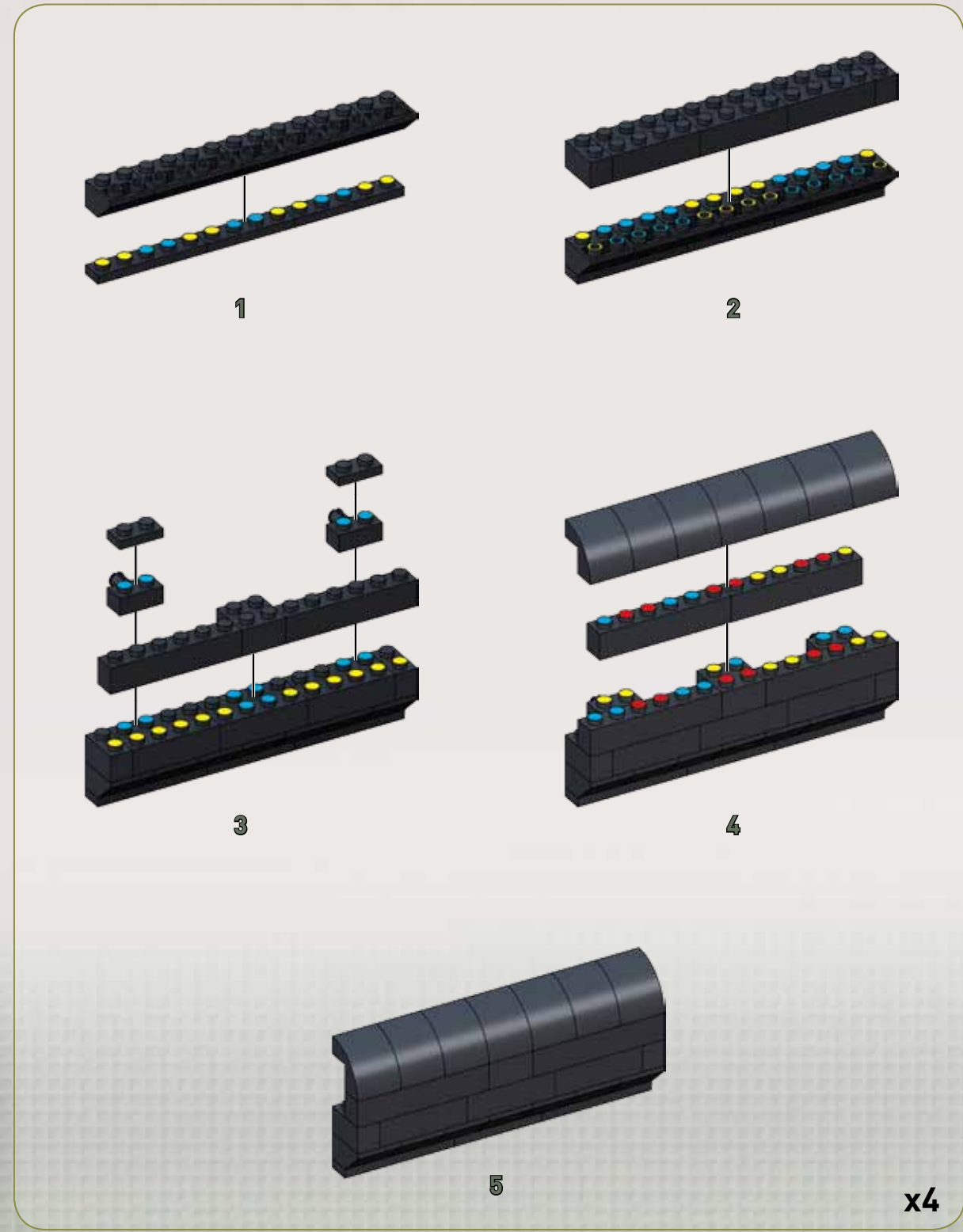
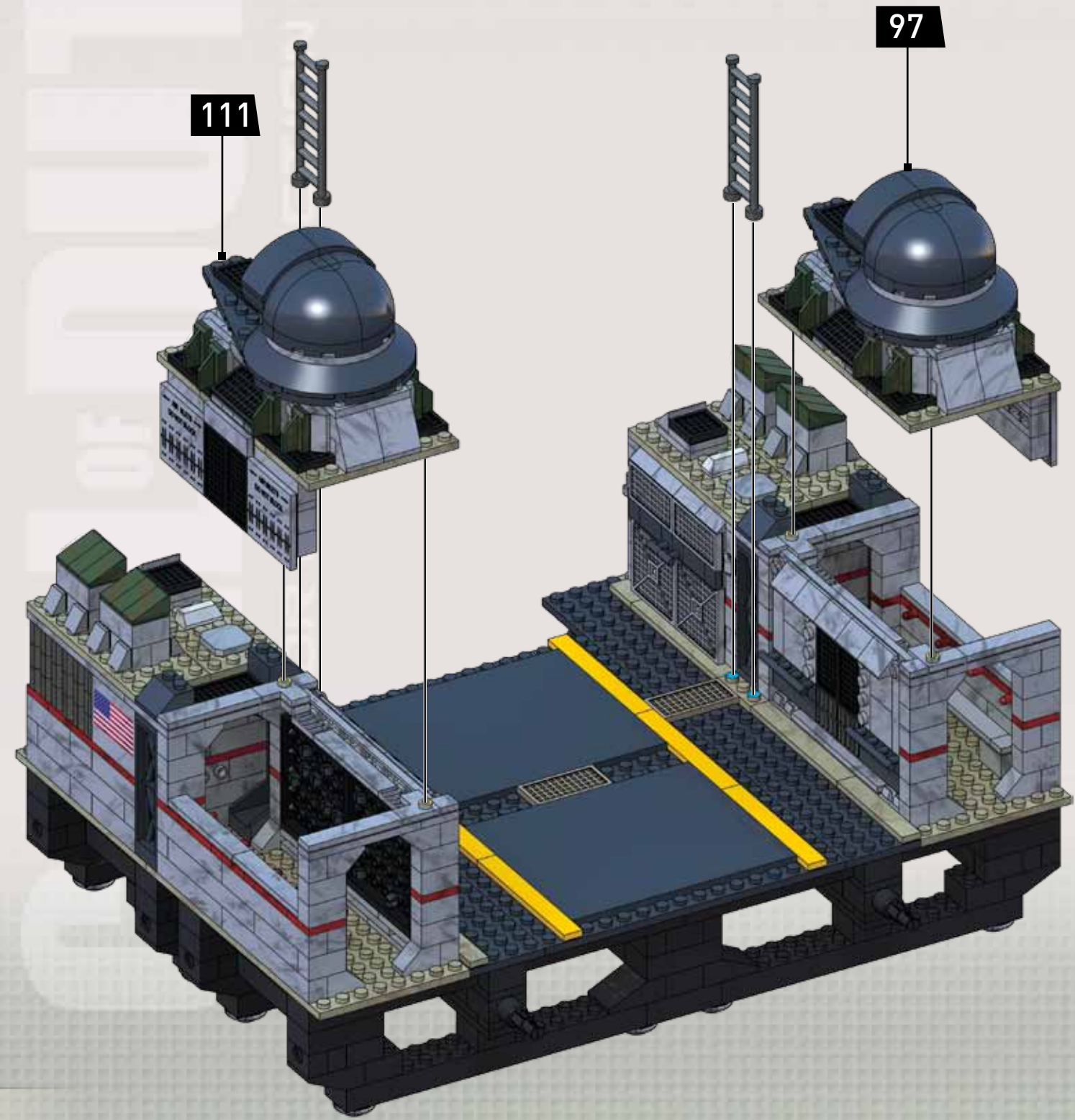



114

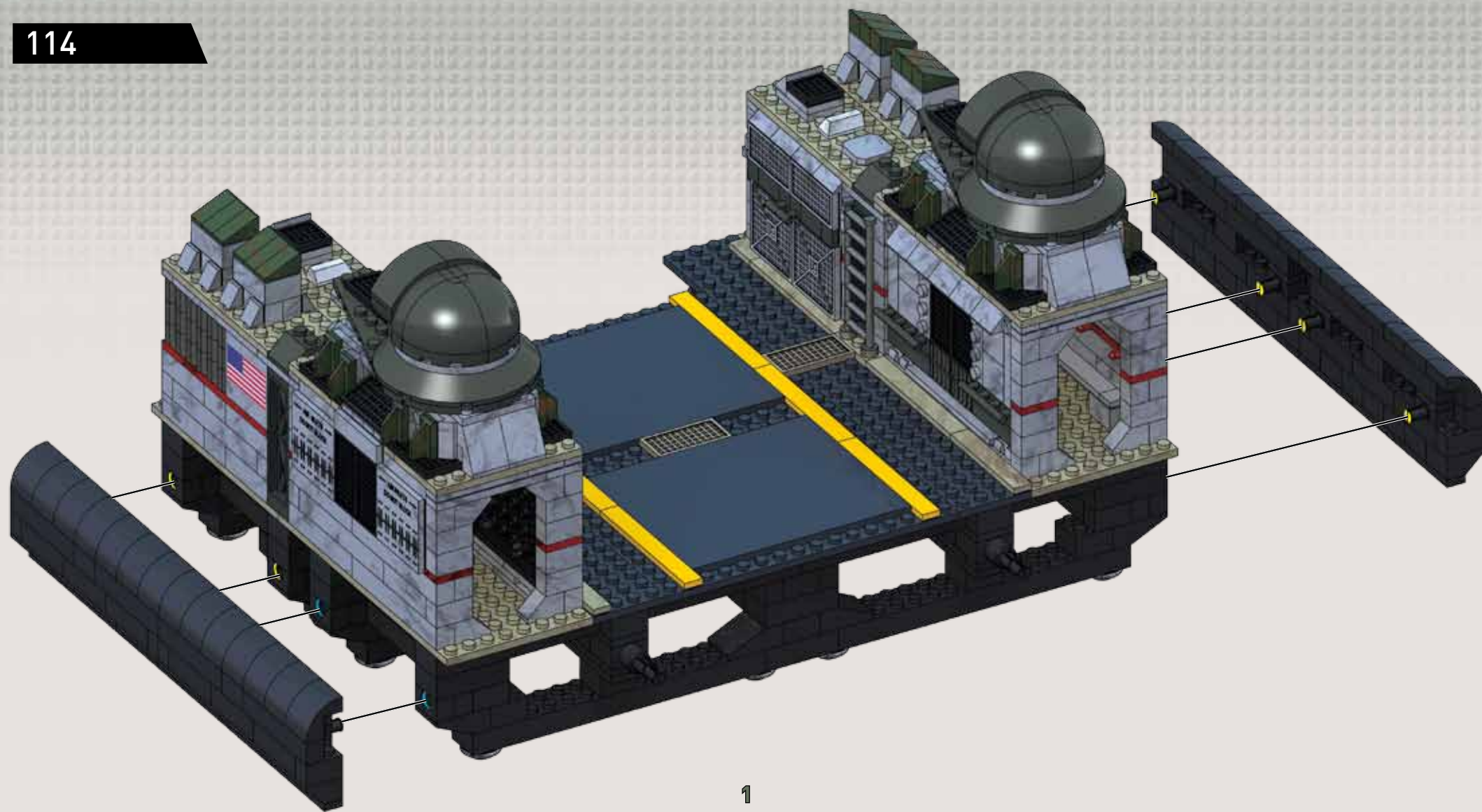

2

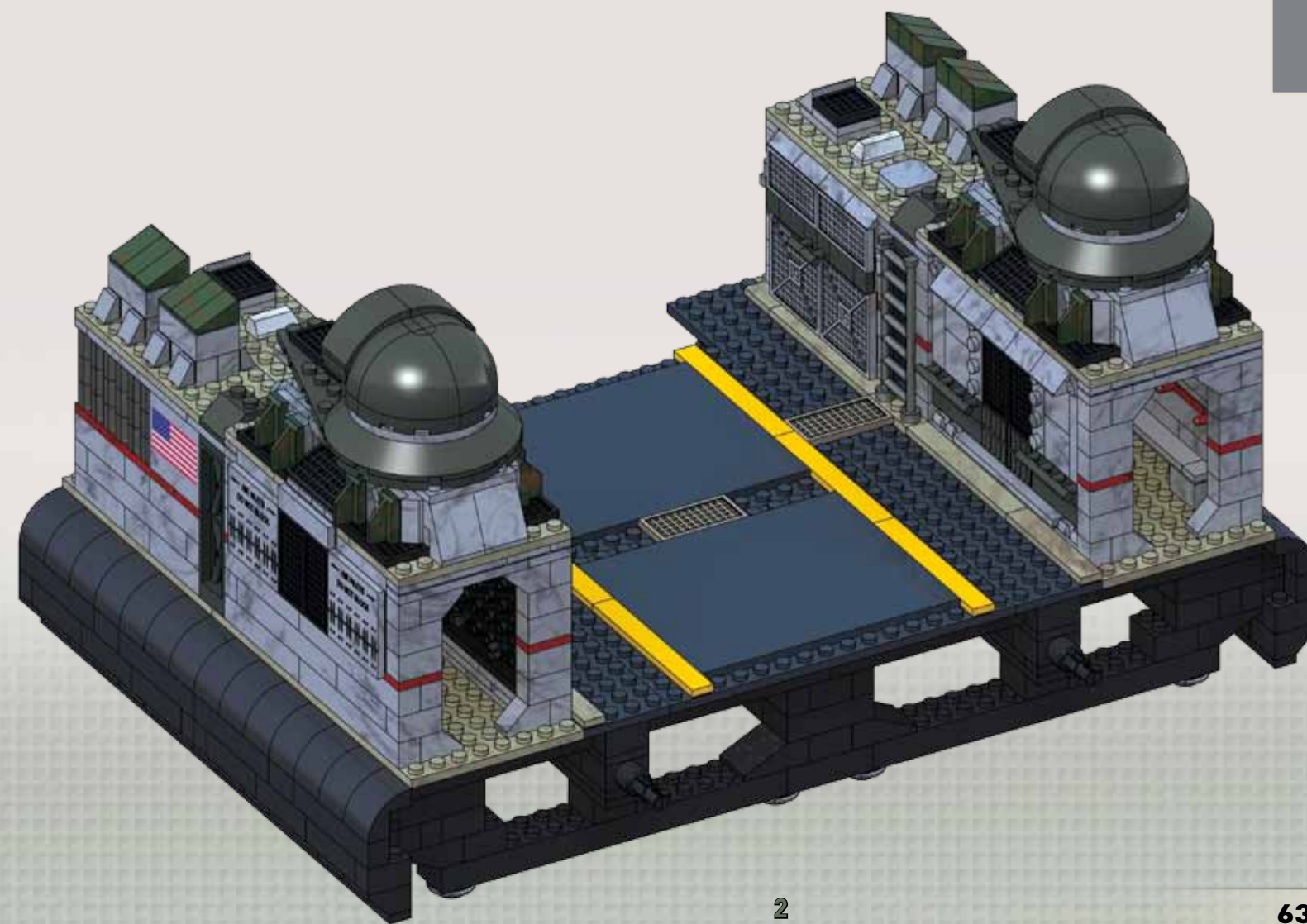

LCAC-2745138 

3

Section • Sección • Section
Abschnitt • Sectie • Sezione • Secção

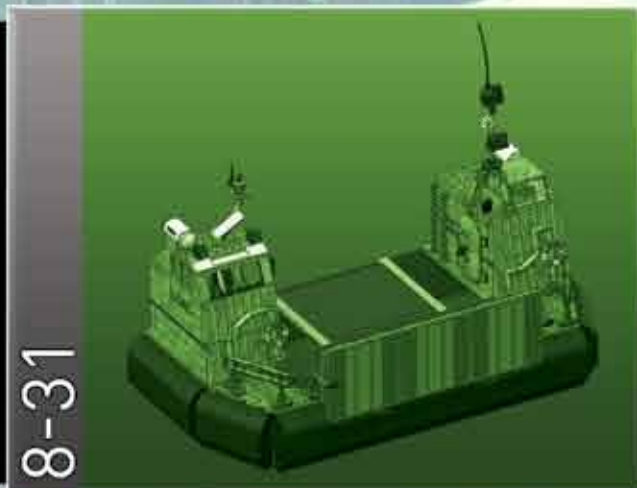

1
 Section • Sección • Section
 Abschnitt • Sectie • Sezione • Secção

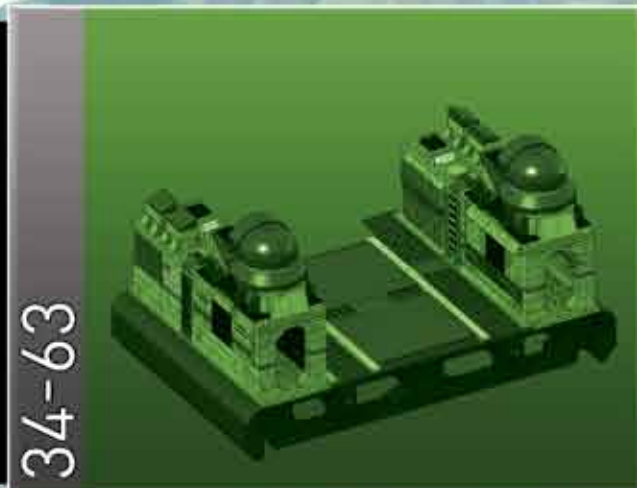

2
 Section • Sección • Section
 Abschnitt • Sectie • Sezione • Secção



3
 Section • Sección • Section
 Abschnitt • Sectie • Sezione • Secção



4
 Section • Sección • Section
 Abschnitt • Sectie • Sezione • Secção



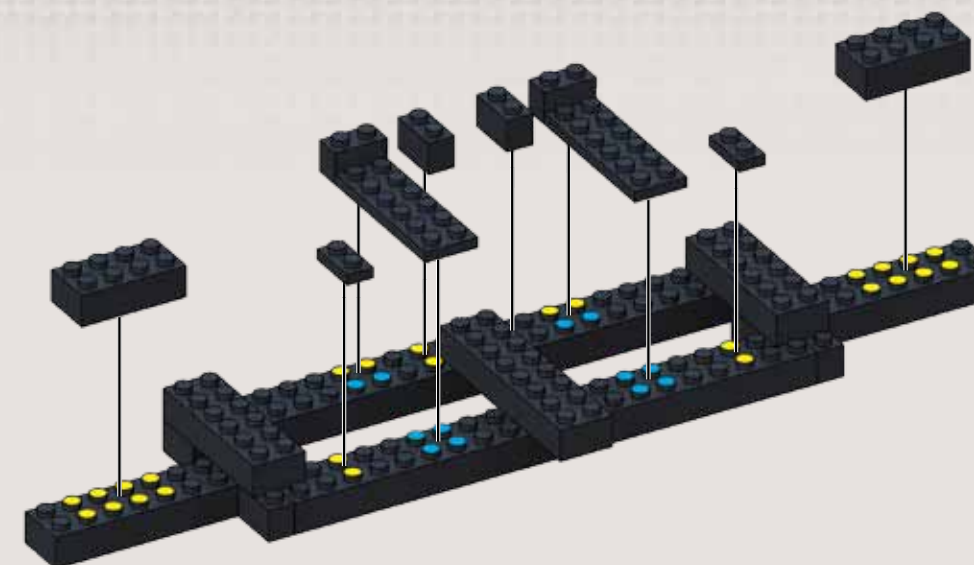
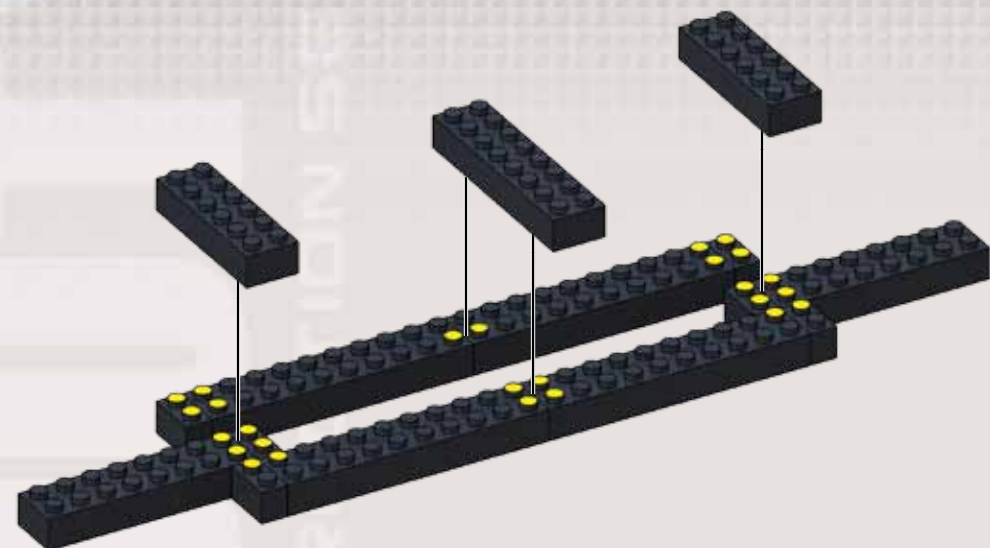
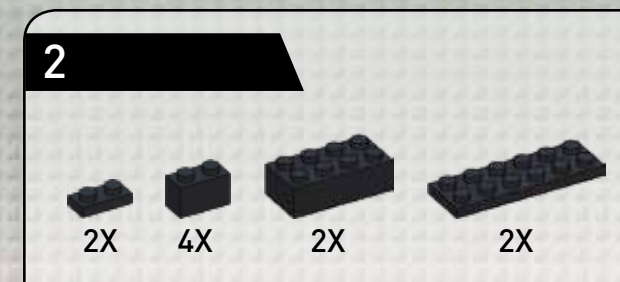

3

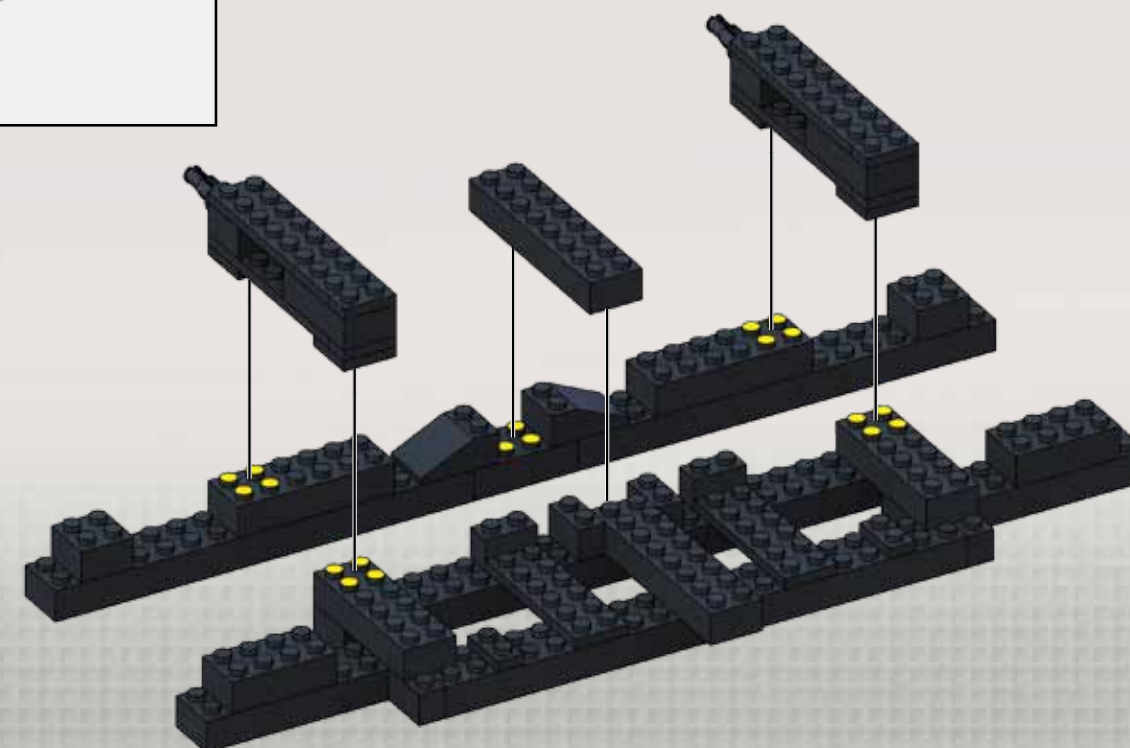
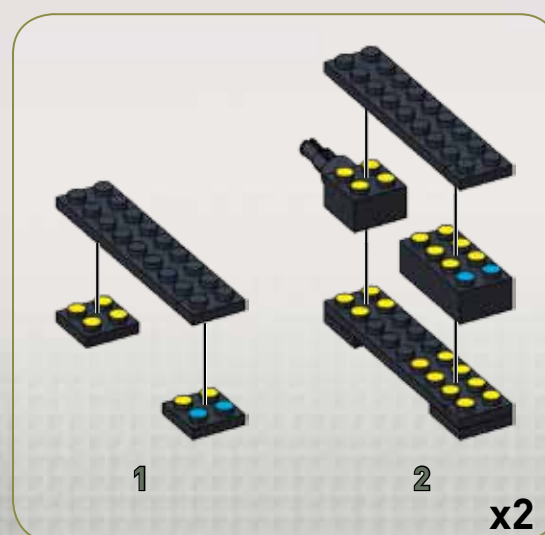
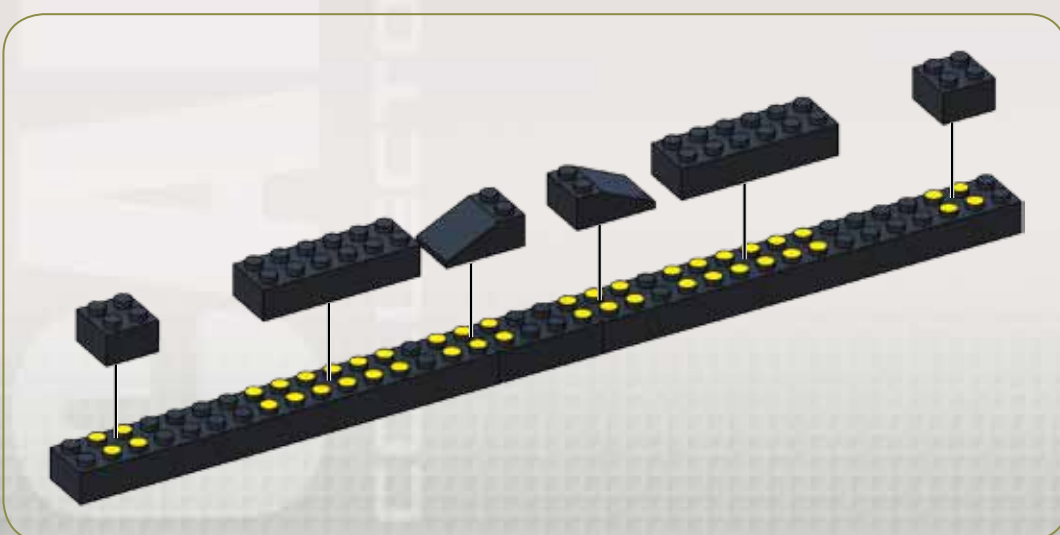
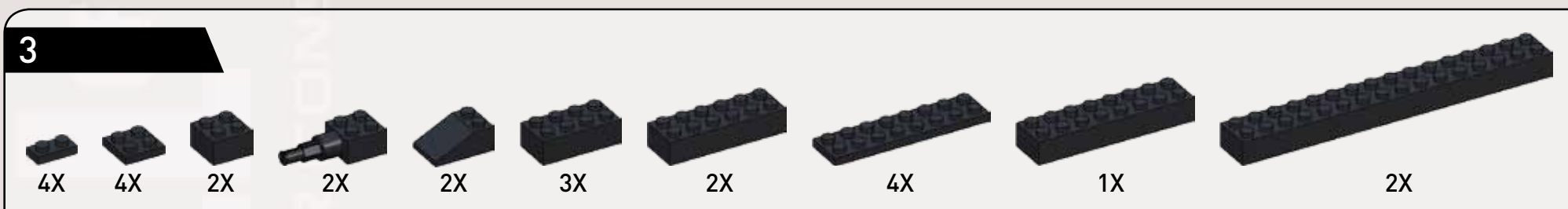



4

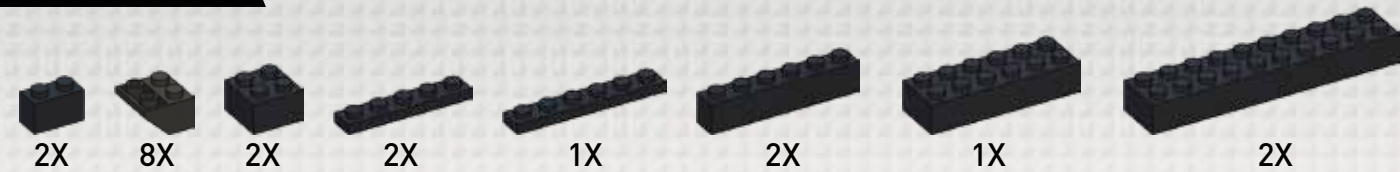

5

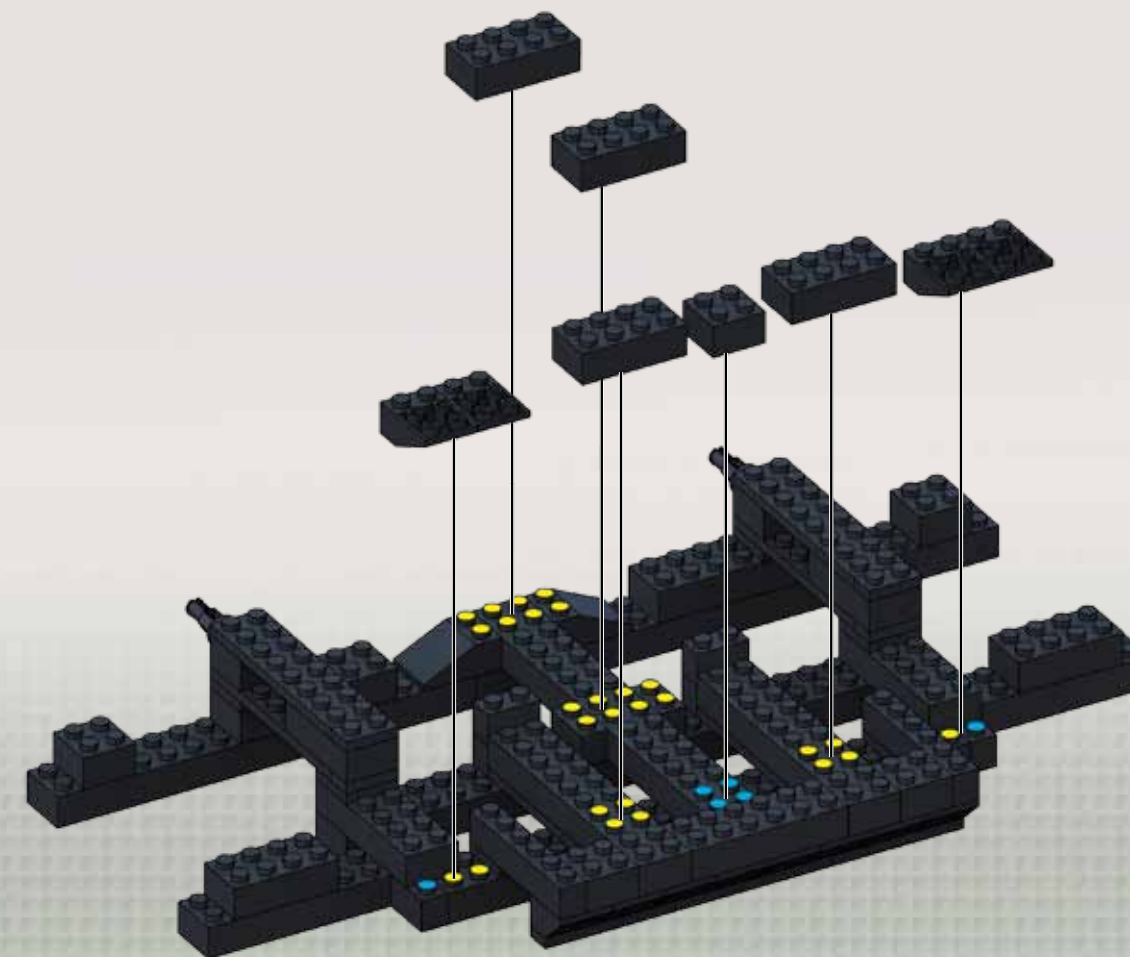
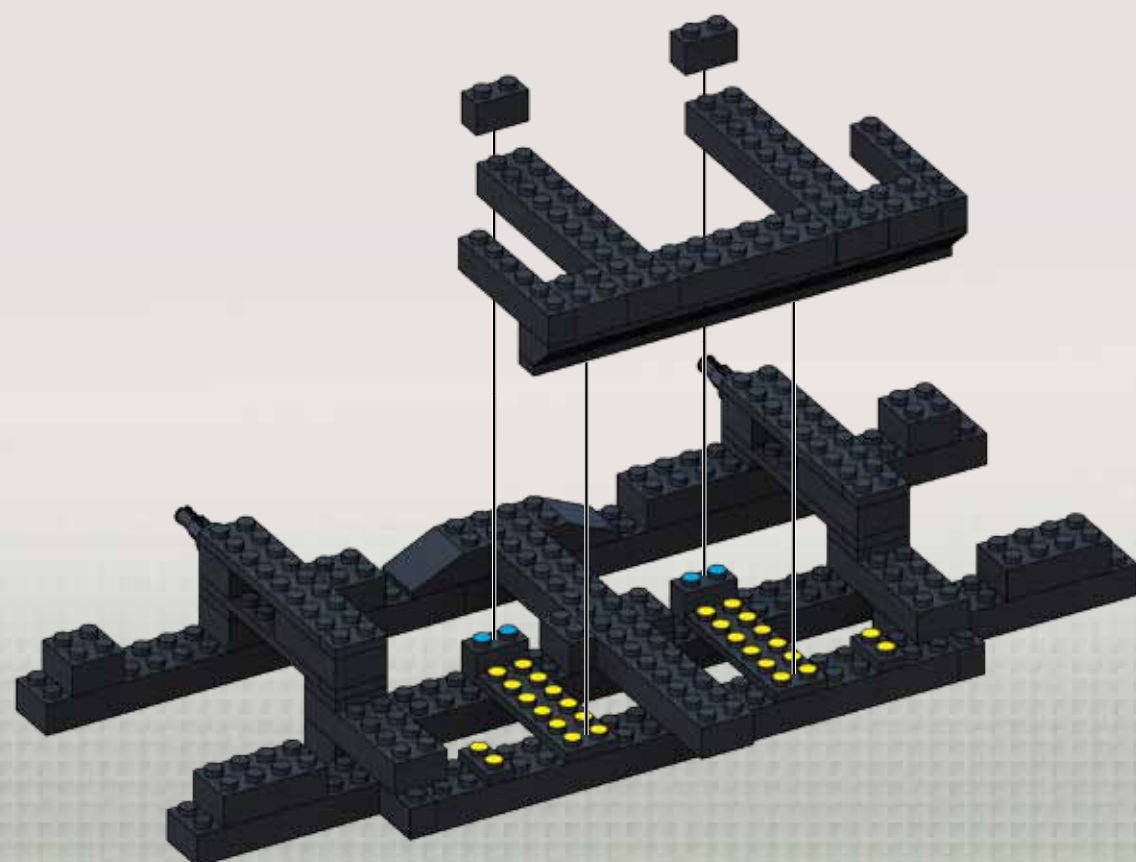

3

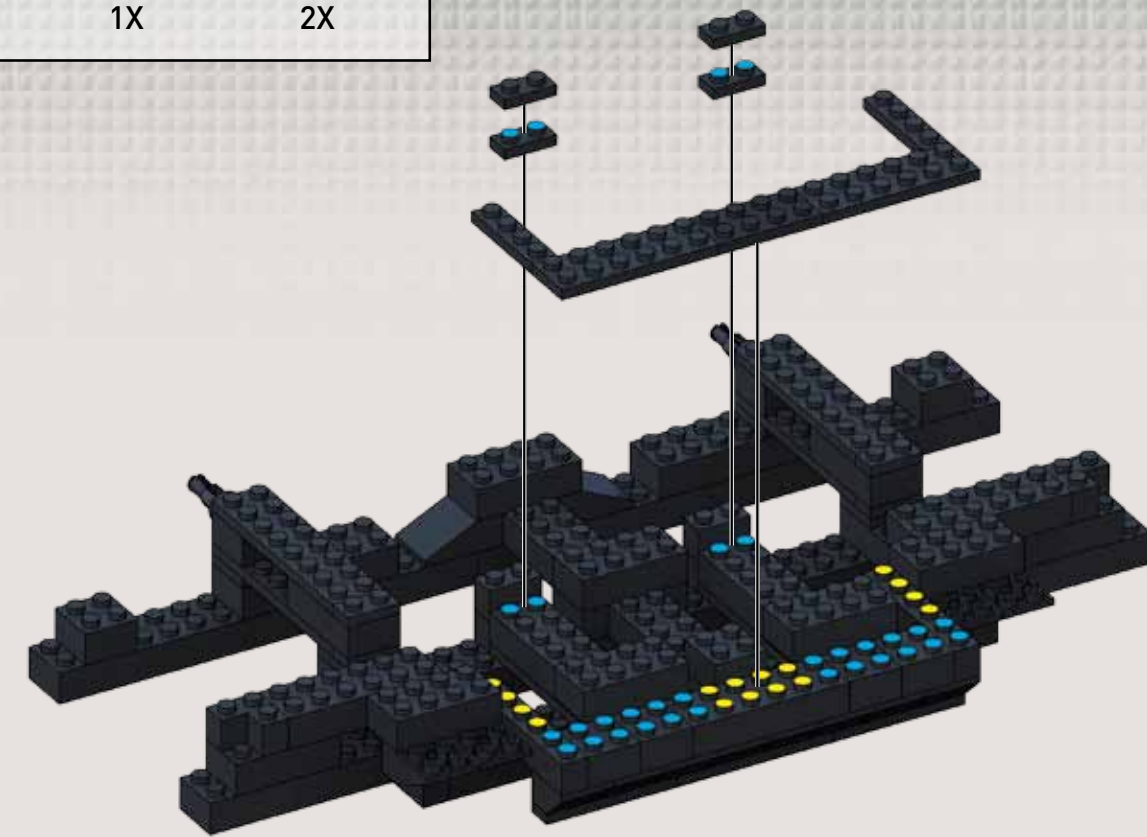
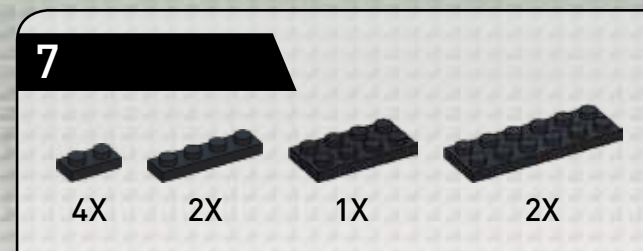
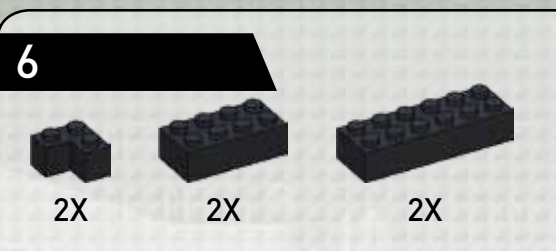

3

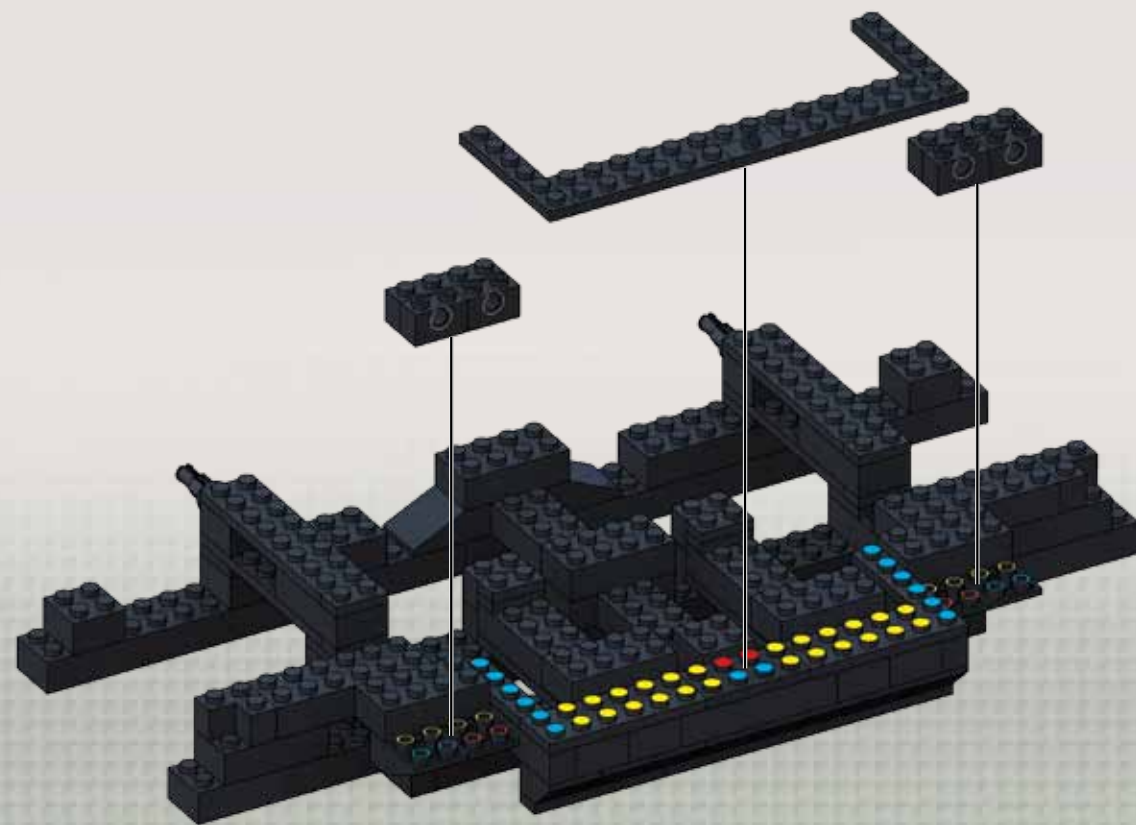
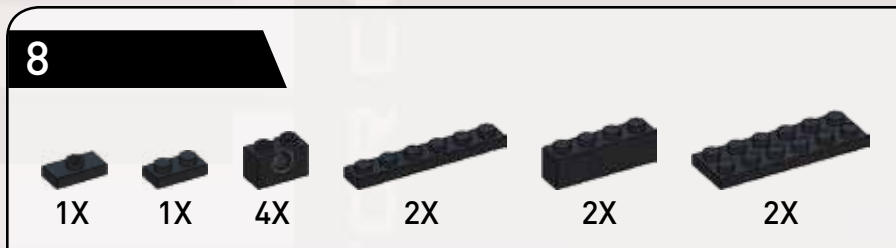



9



10

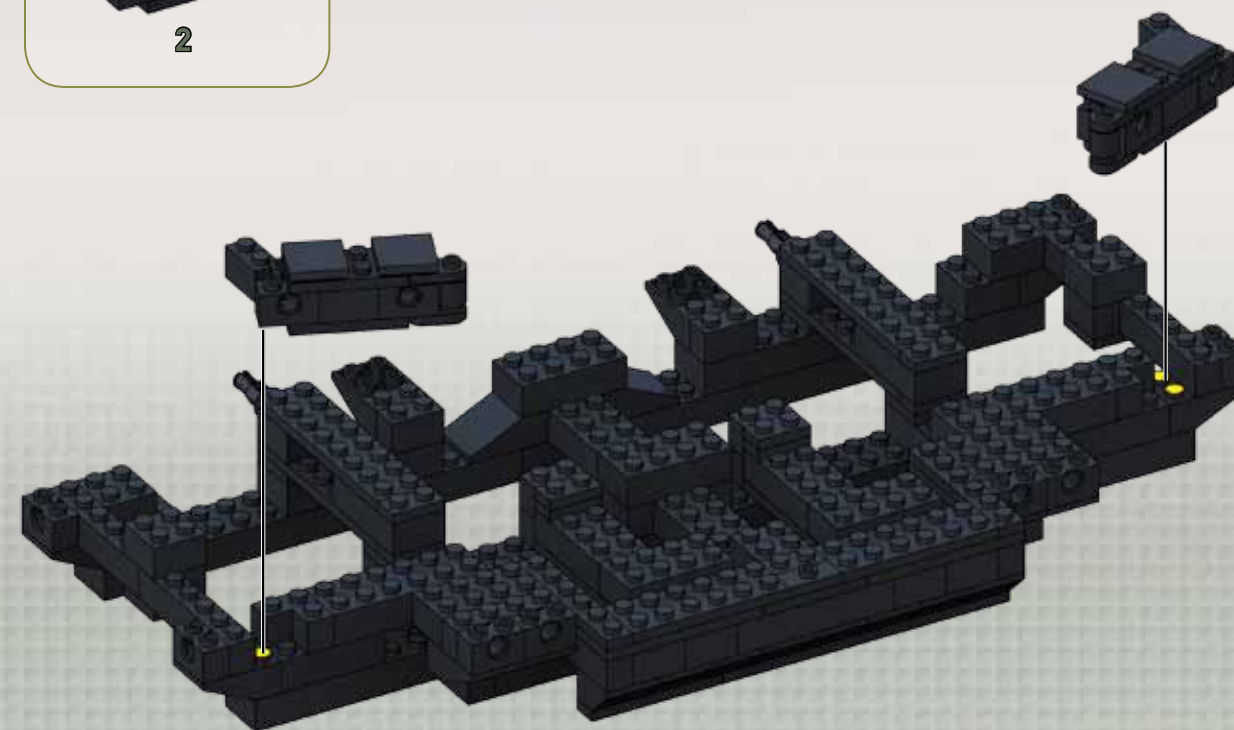
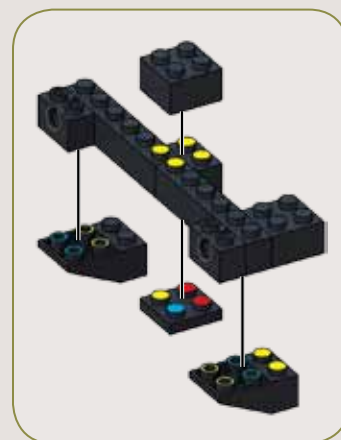
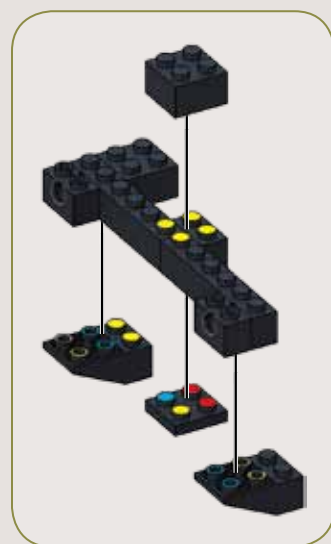

3



11

1X 2X 1X 2X 4X 2X 2X

12

3X 8X 1X



3

13

2X 2X 2X
2X 4X 2X

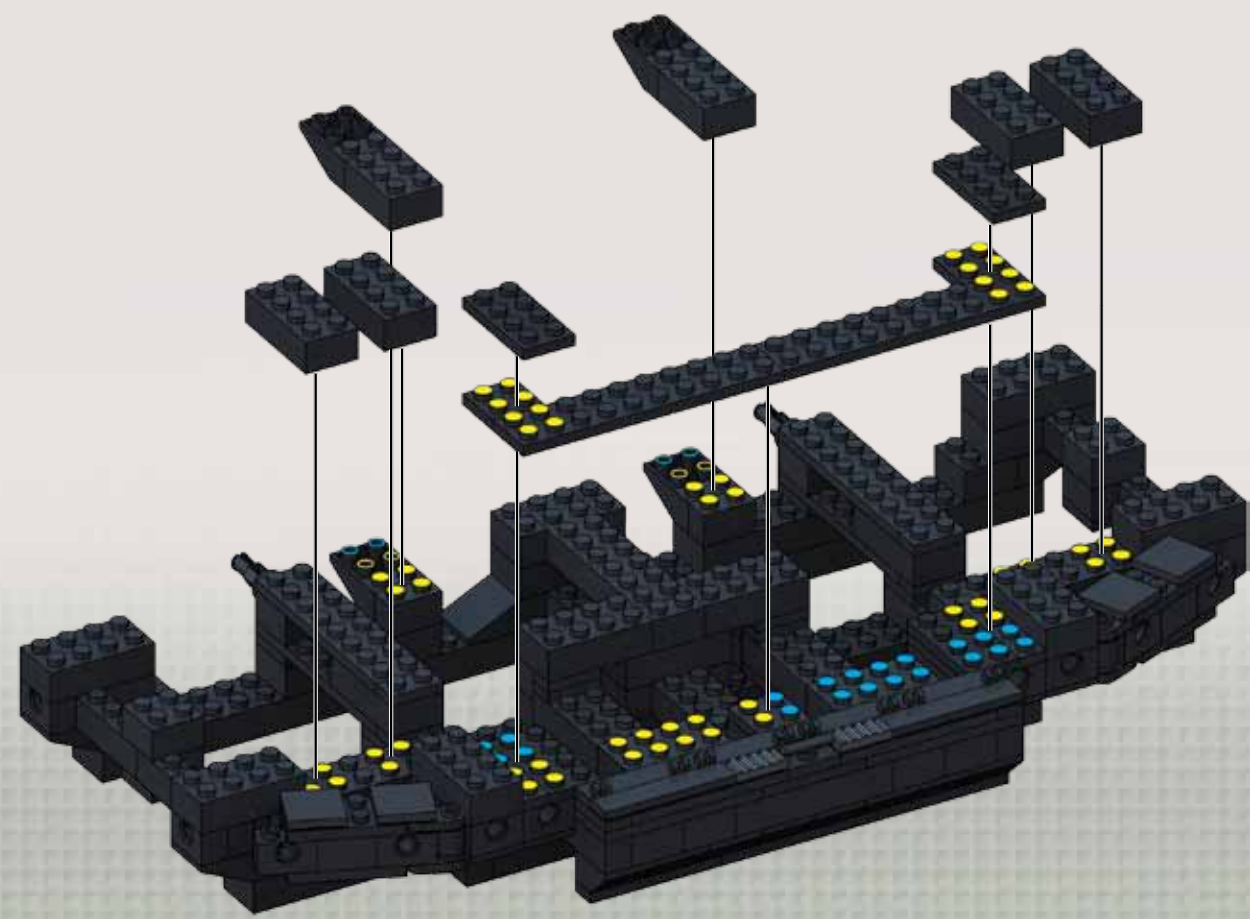



14

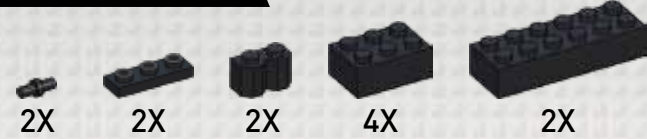

15

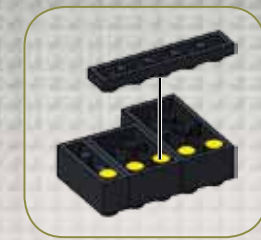

16

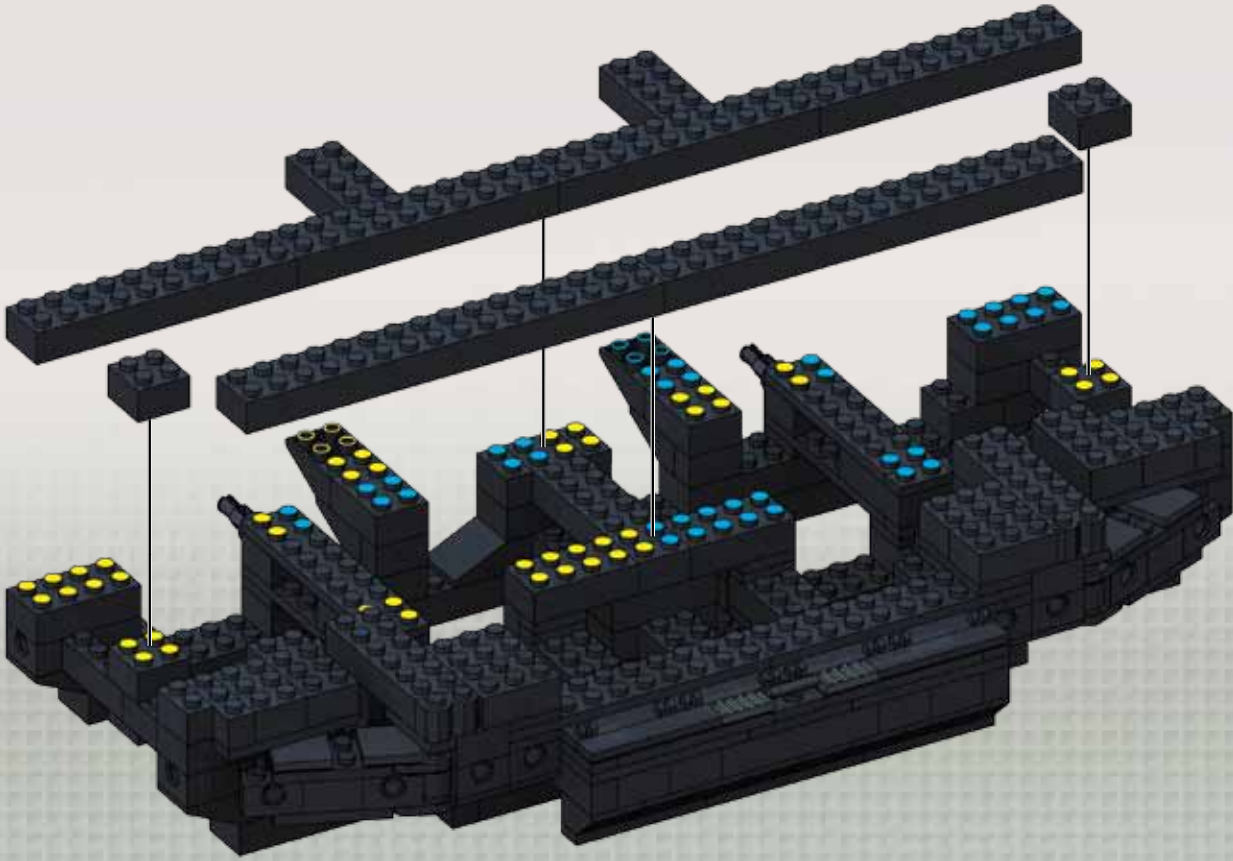
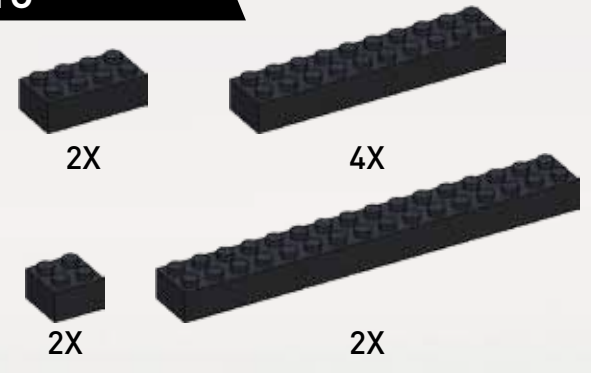

3



17

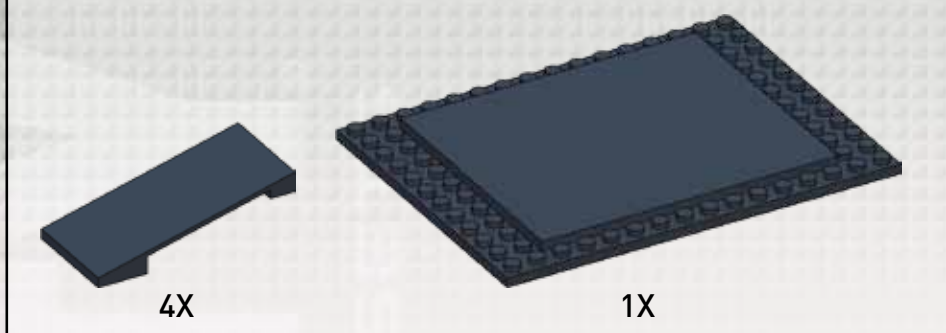

18

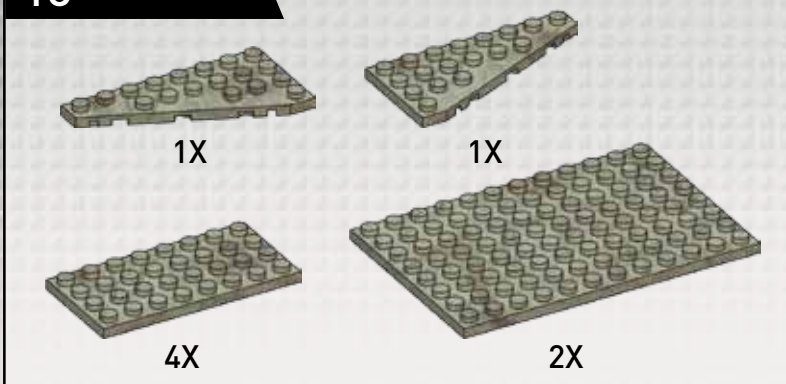

3

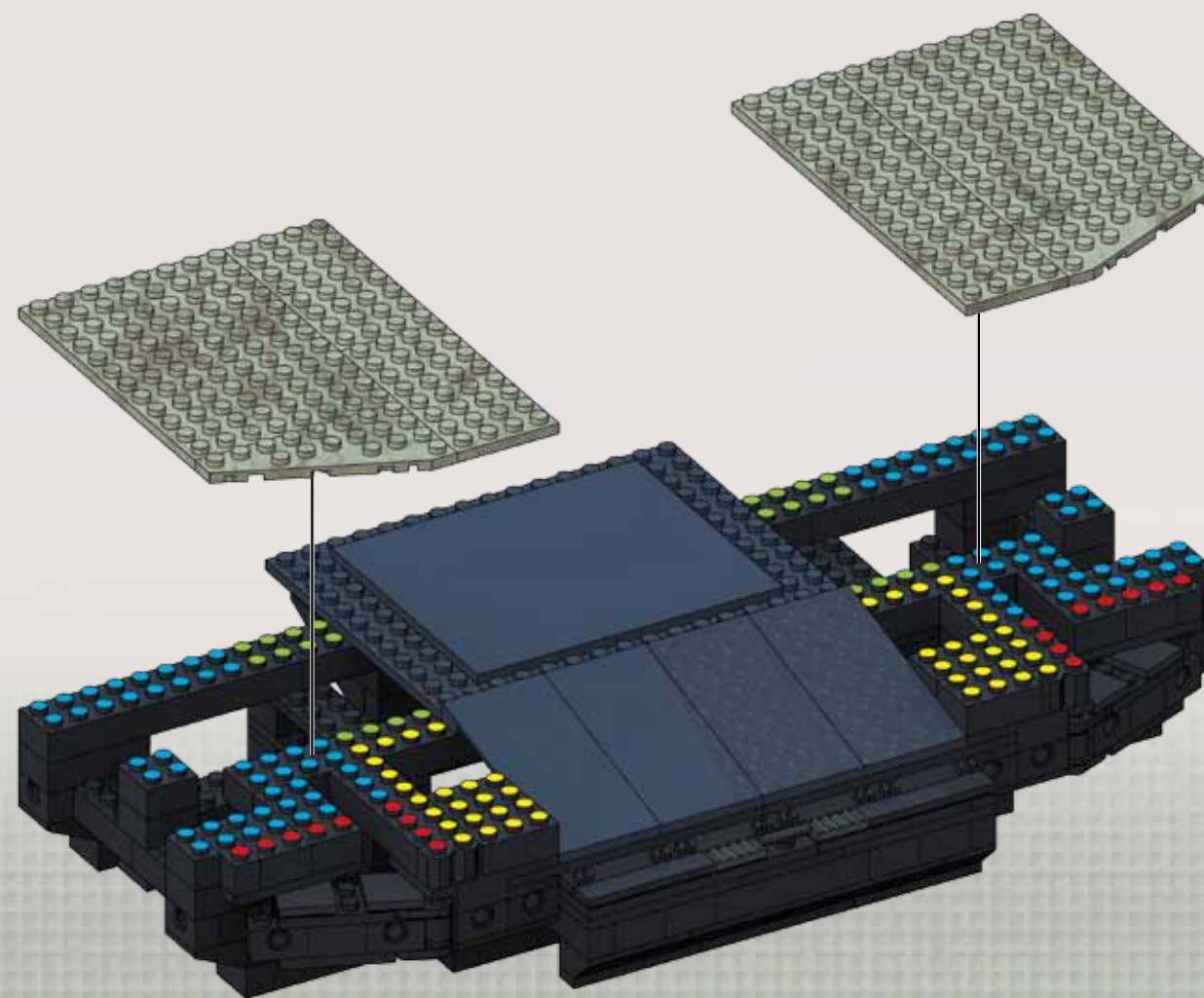
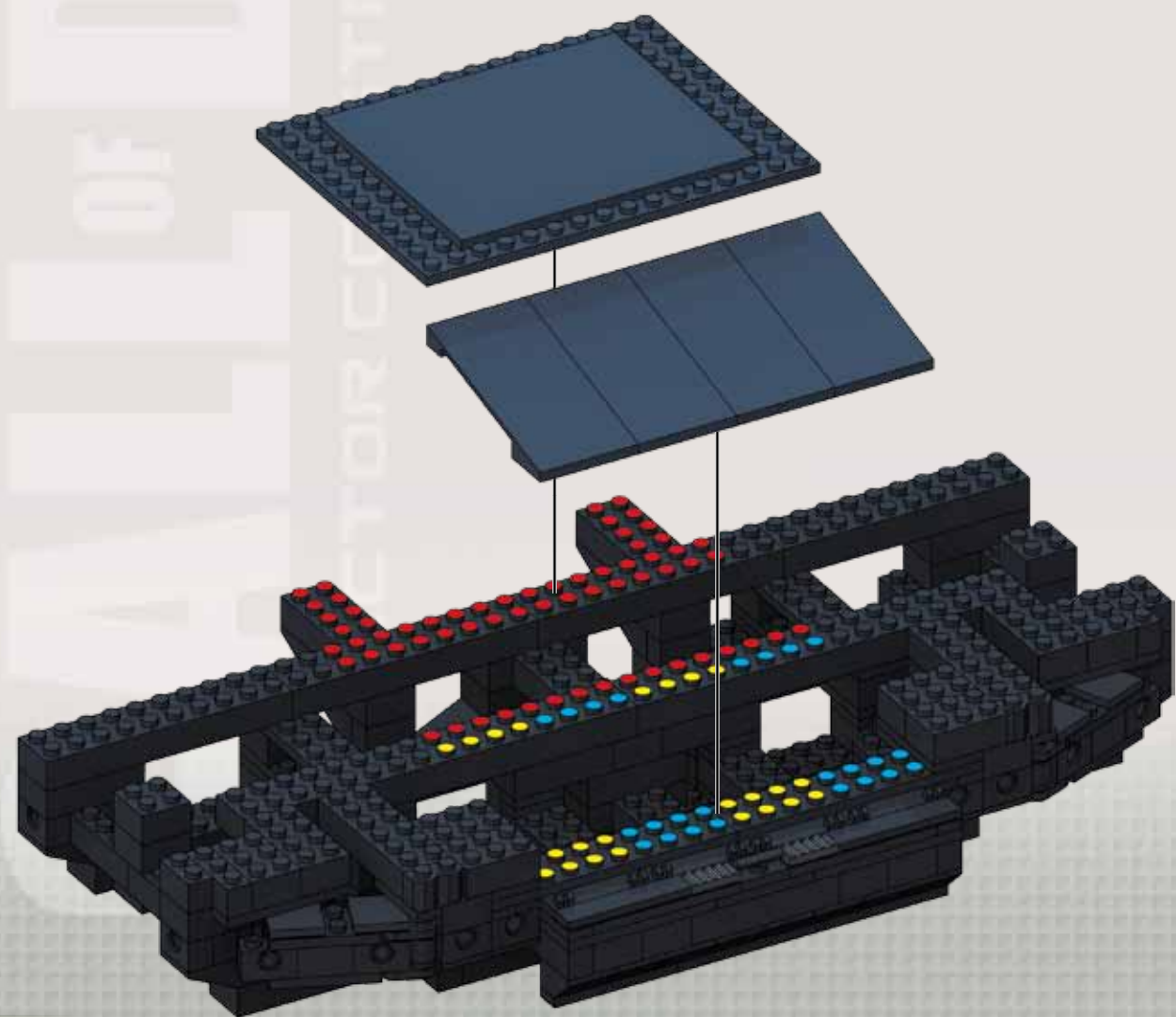



19

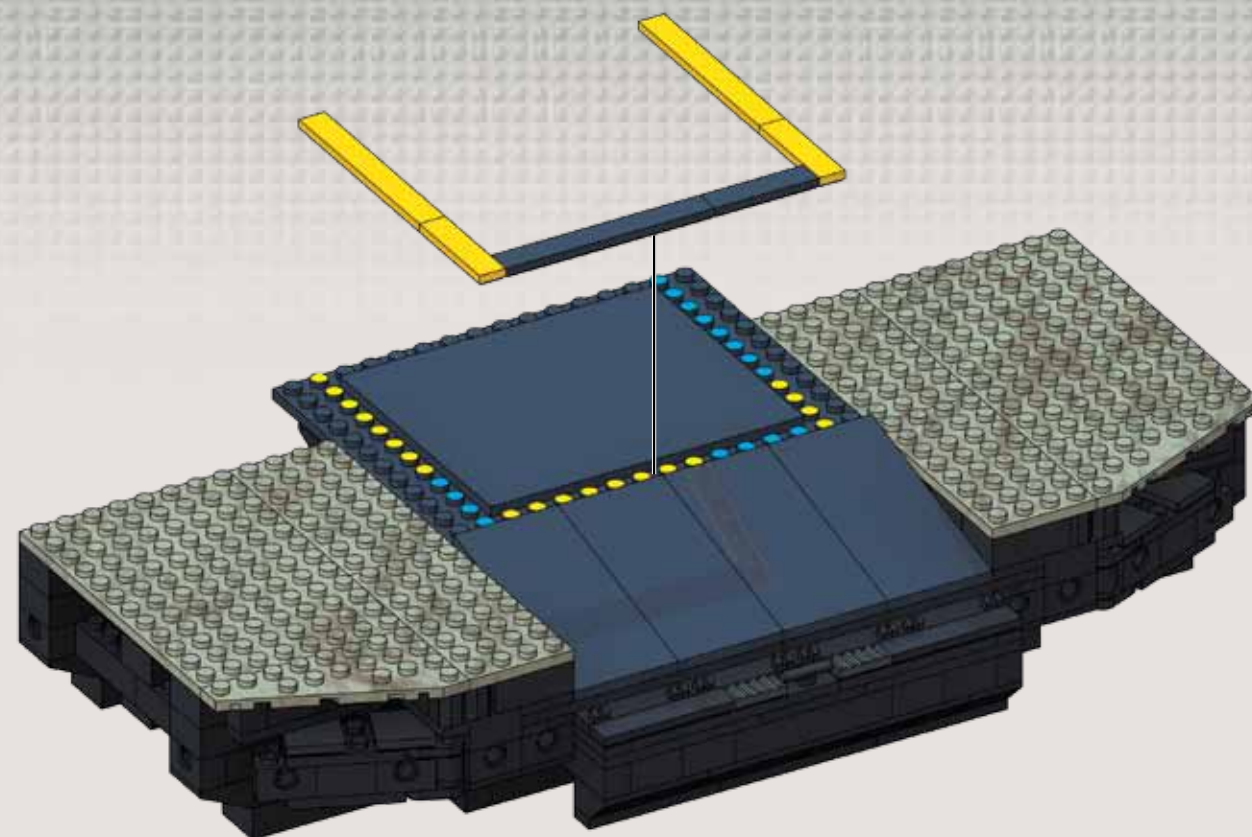

20

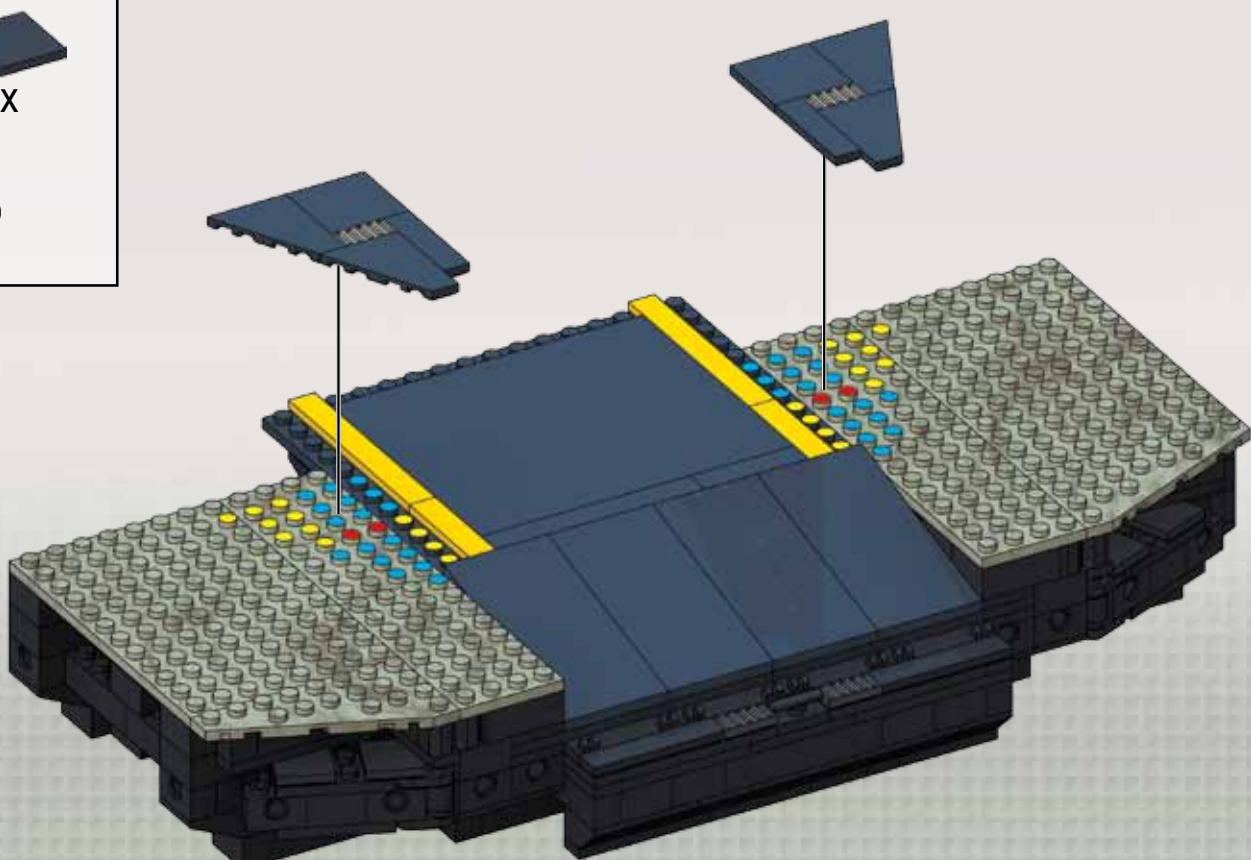
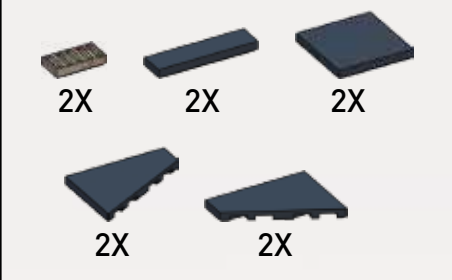

1

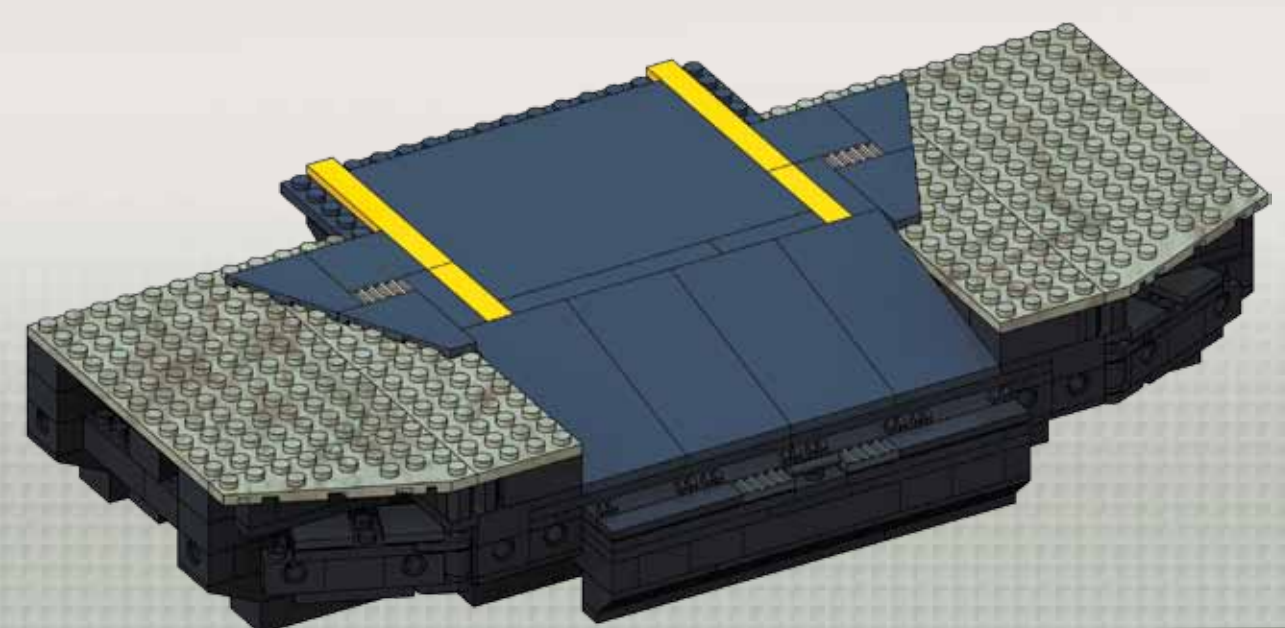

2

3

73



21



12X

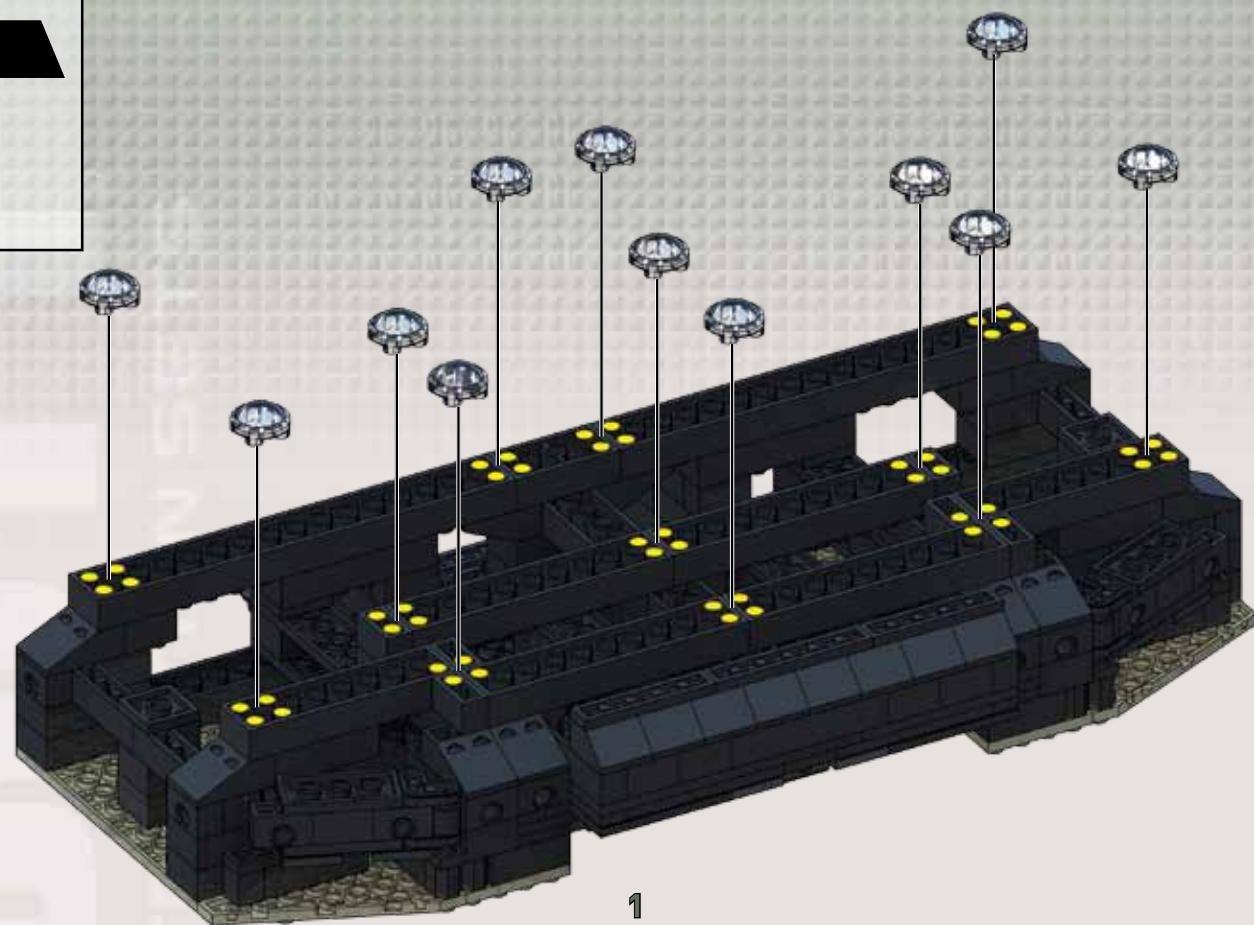

1

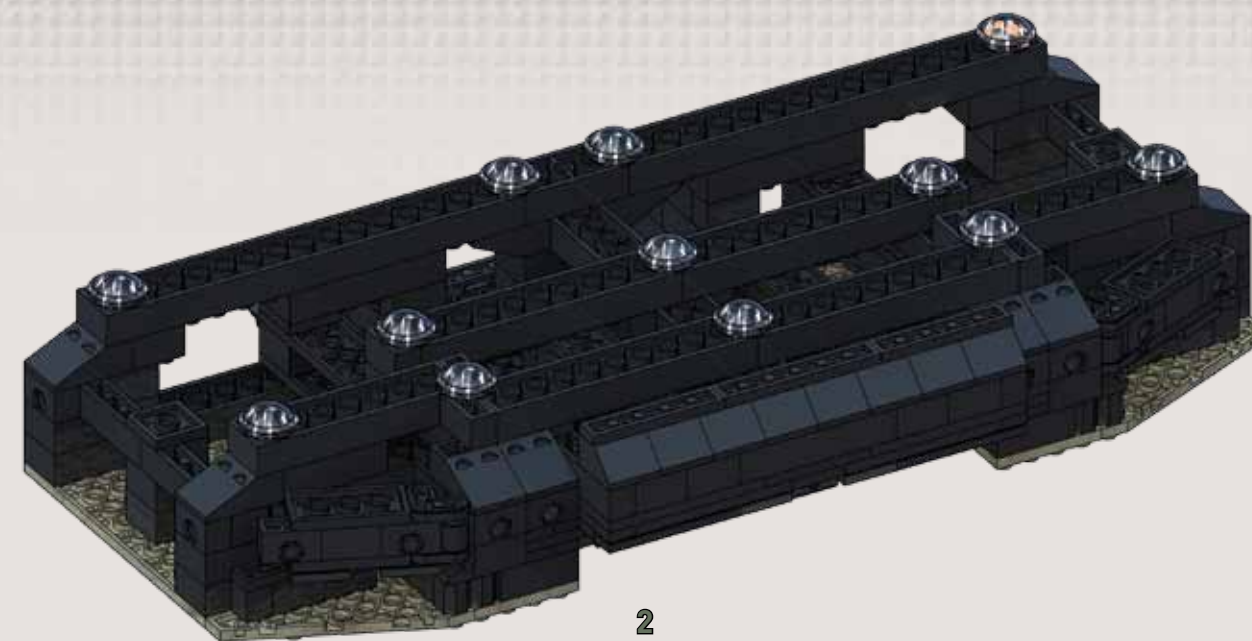

2

3

22



2X

4X

2X

2X

2X

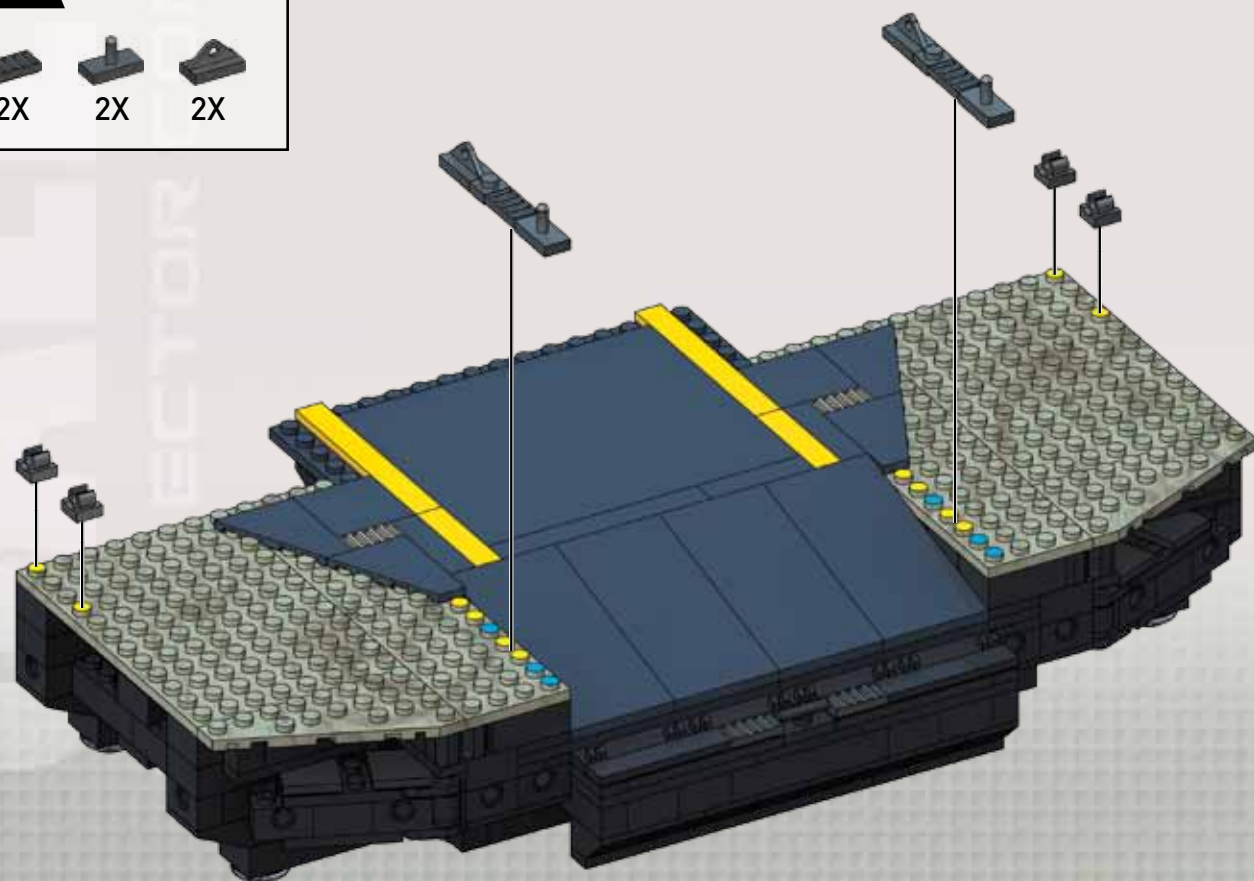

23



4X

2X

4X

6X

4X

2X

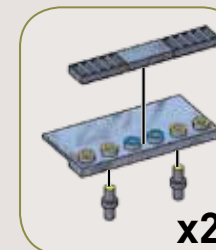

x2

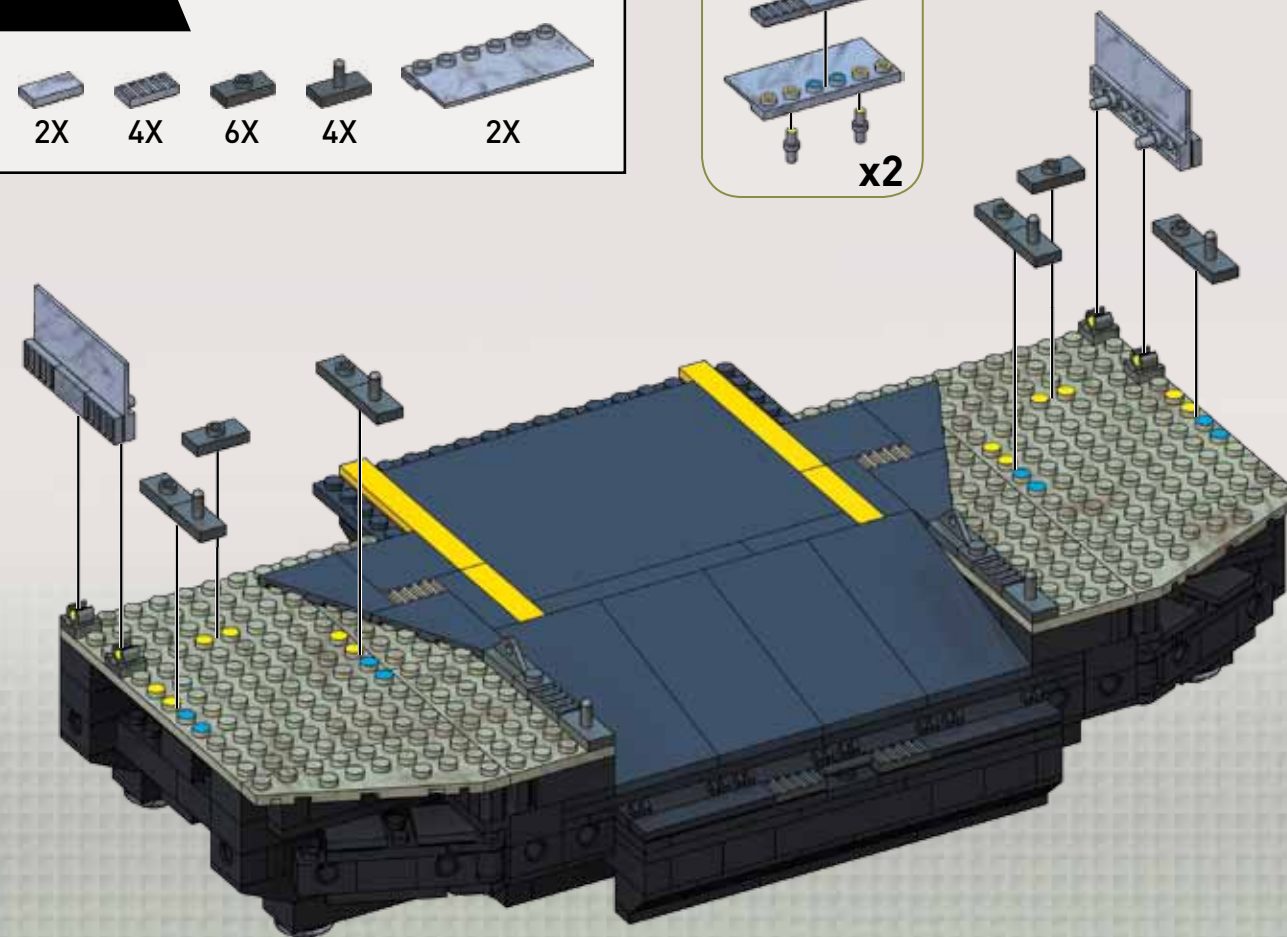



24

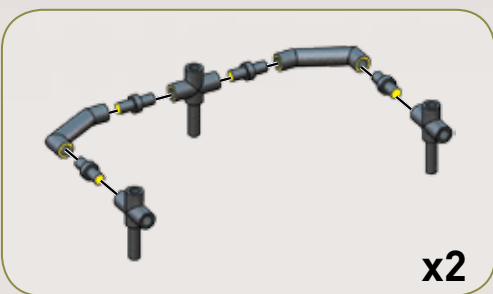

25

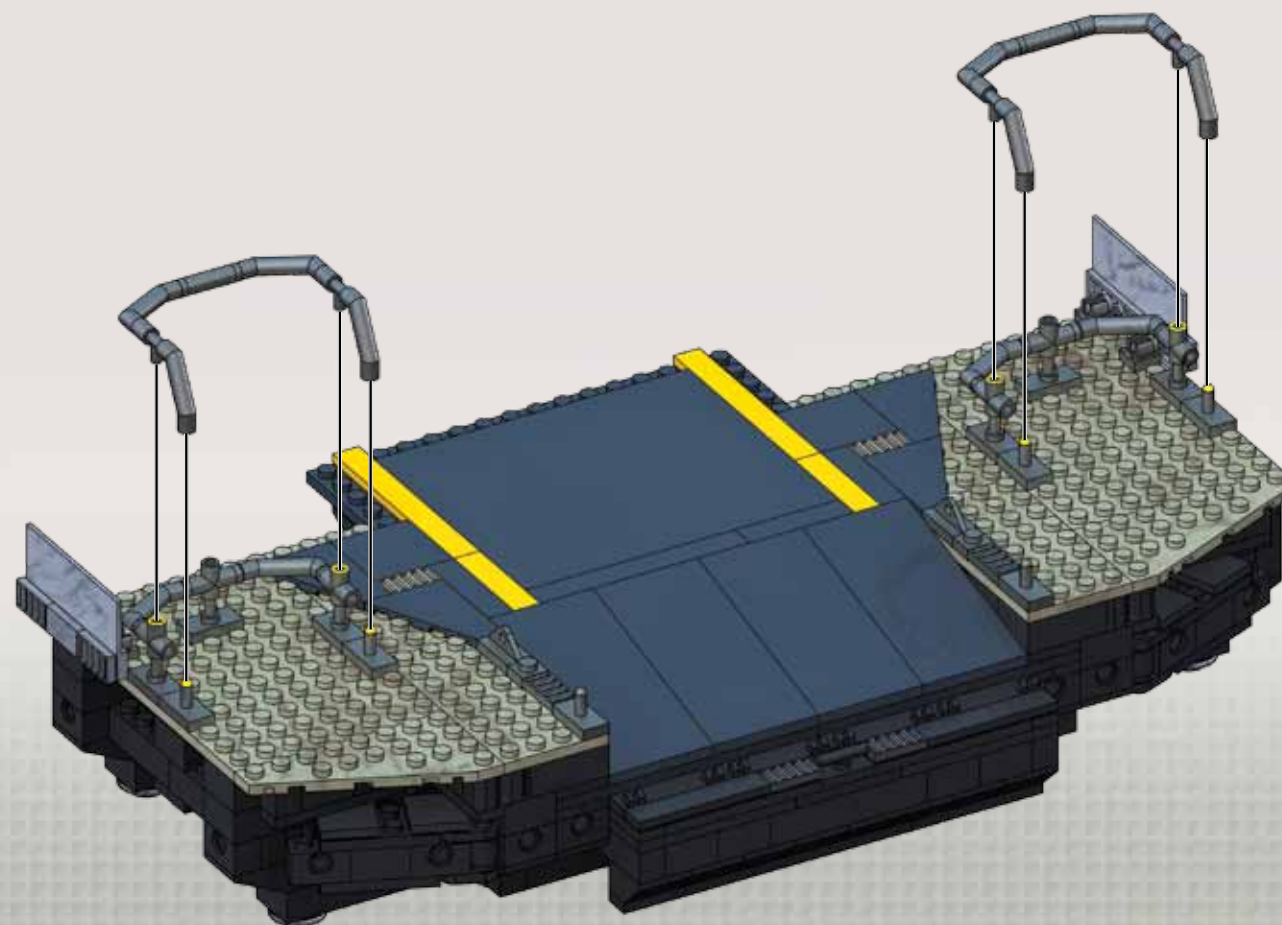
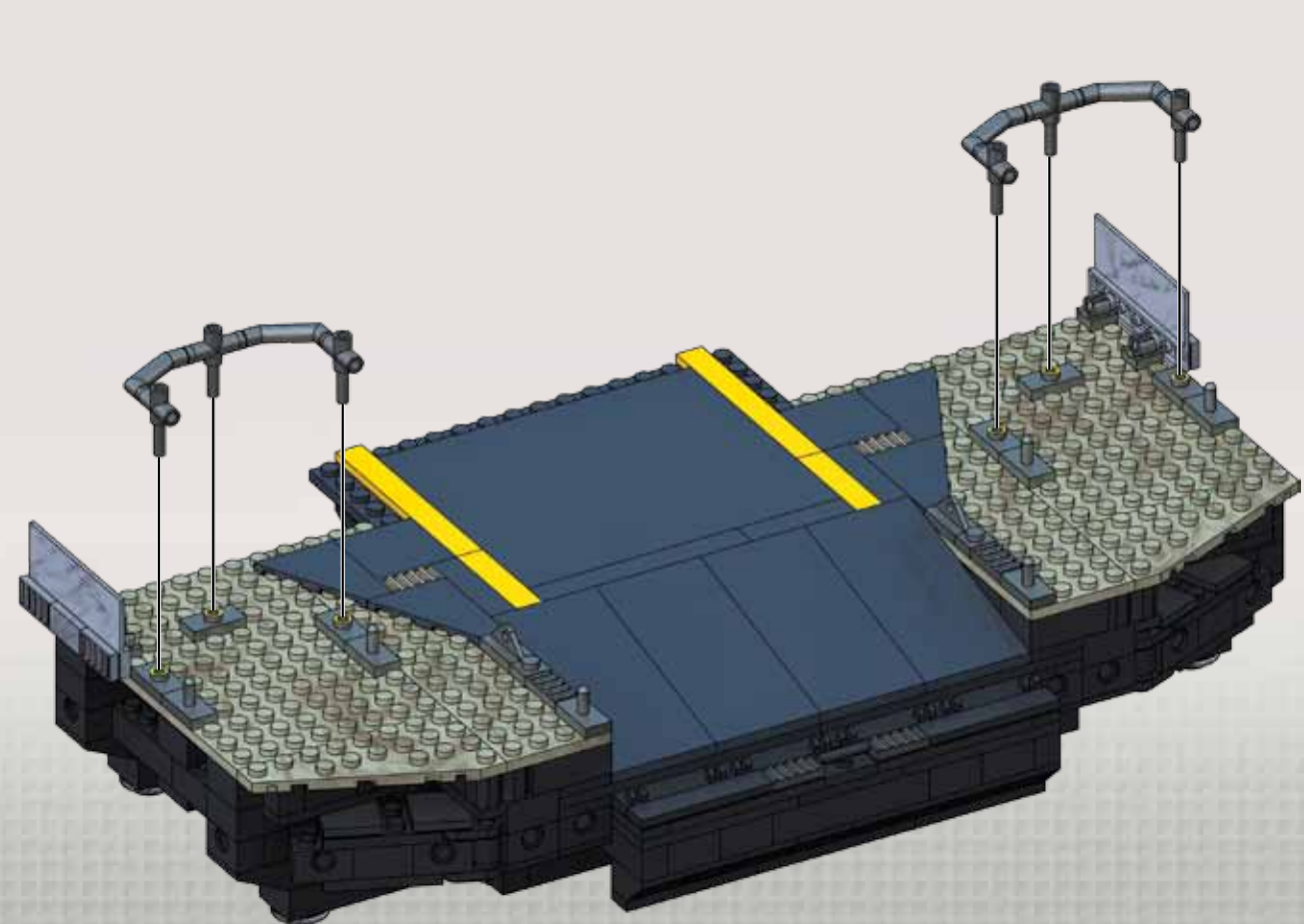
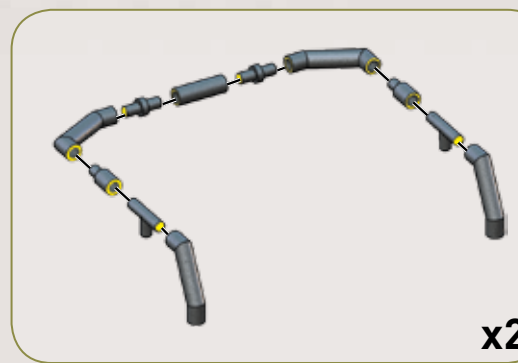
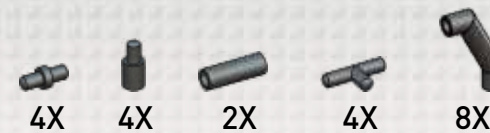

3

75



26

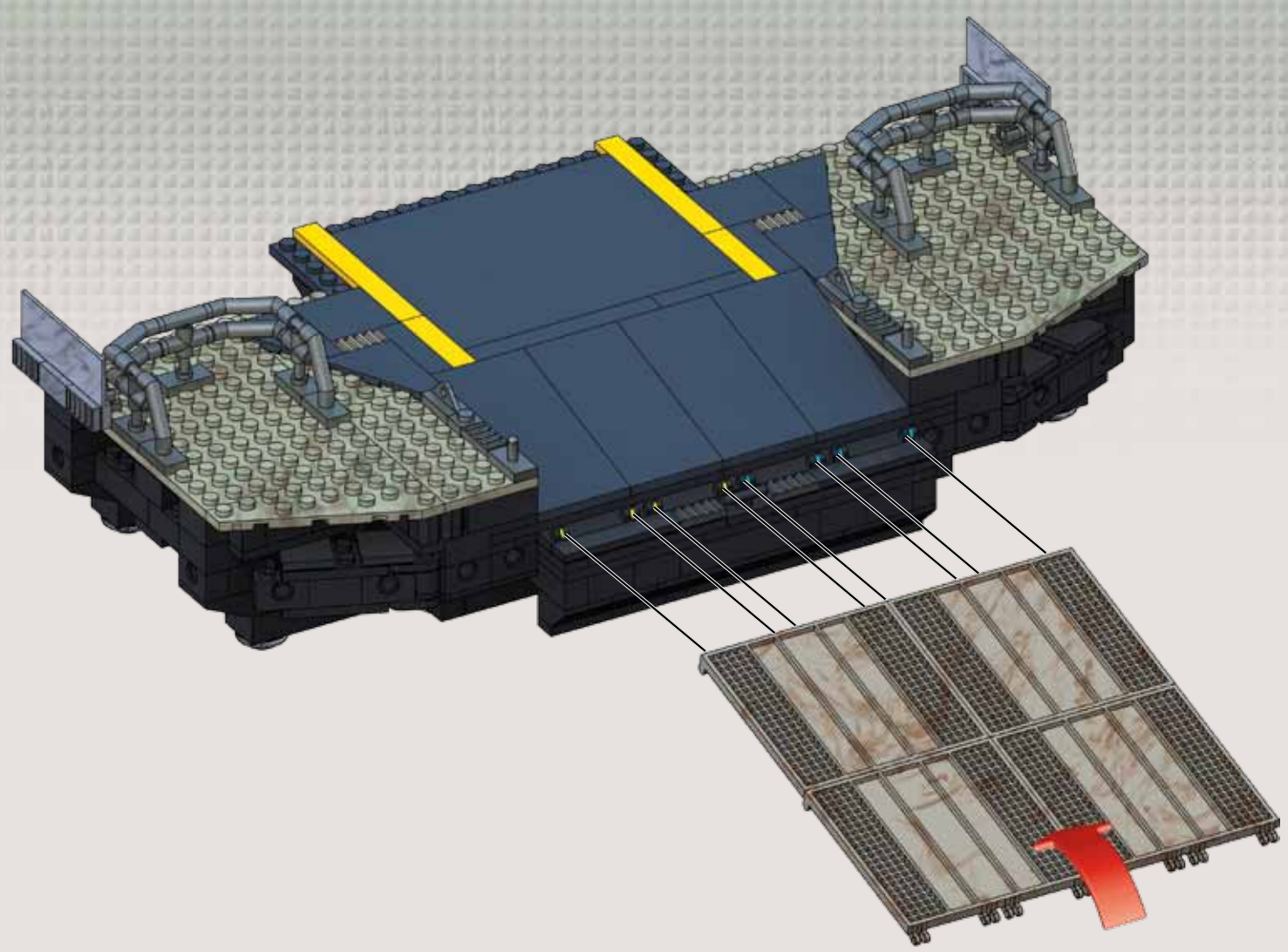
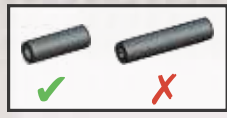
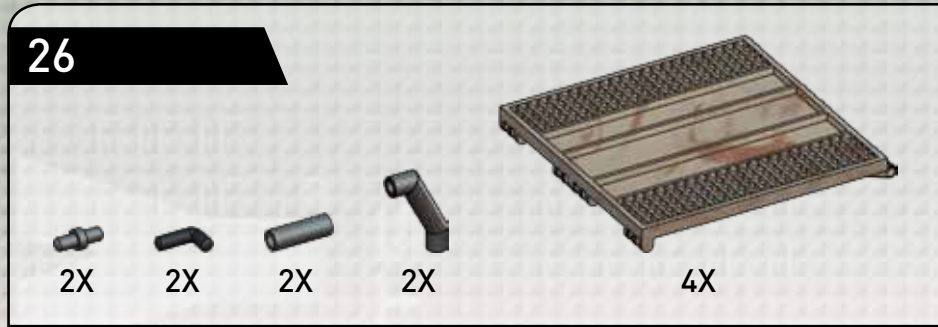

3

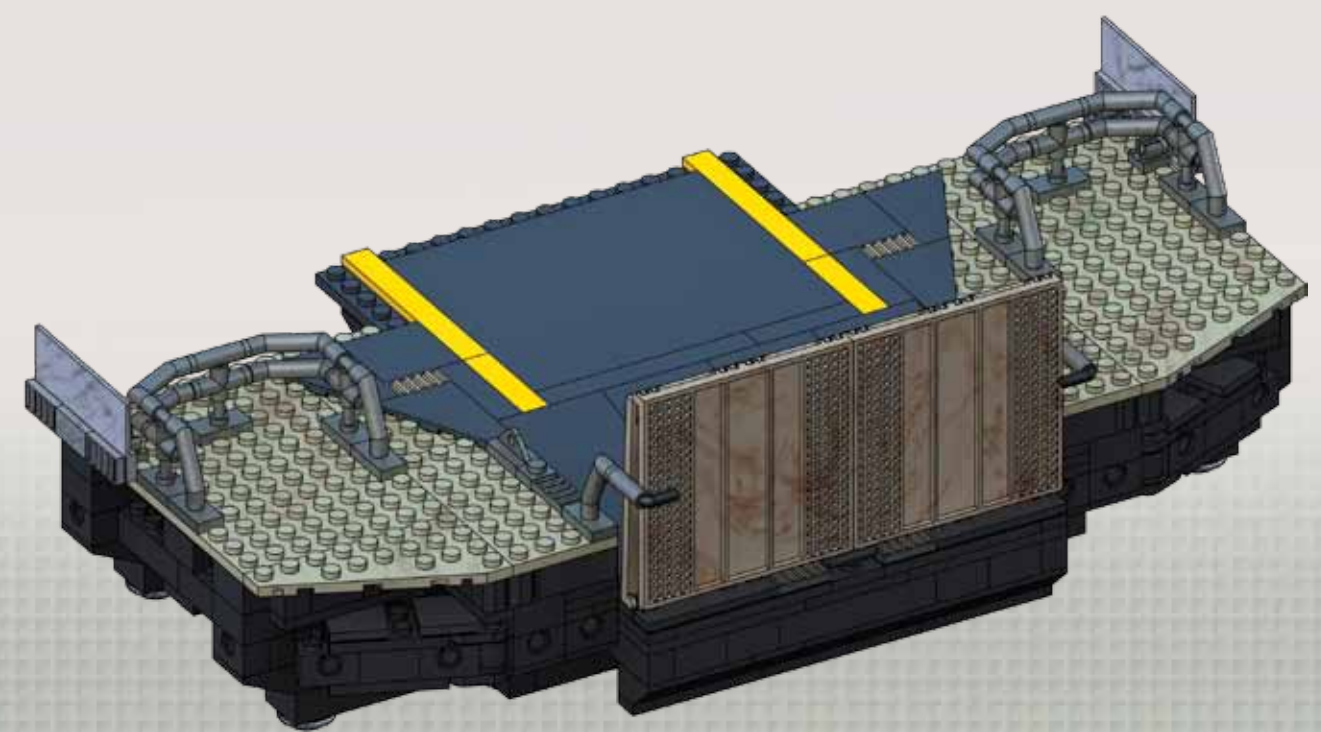



27

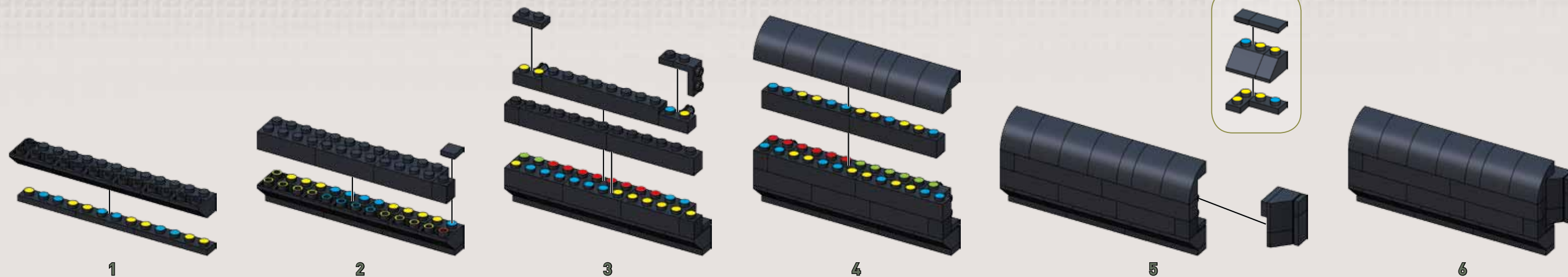

28

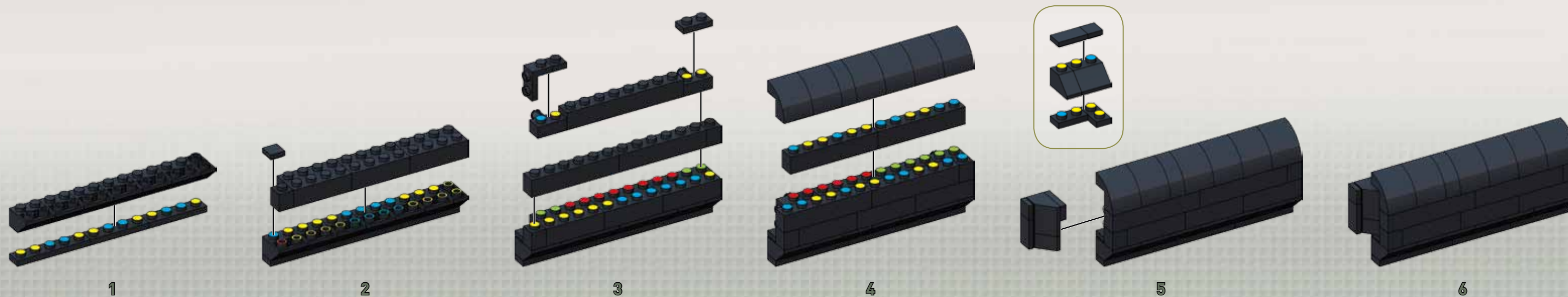

3



29

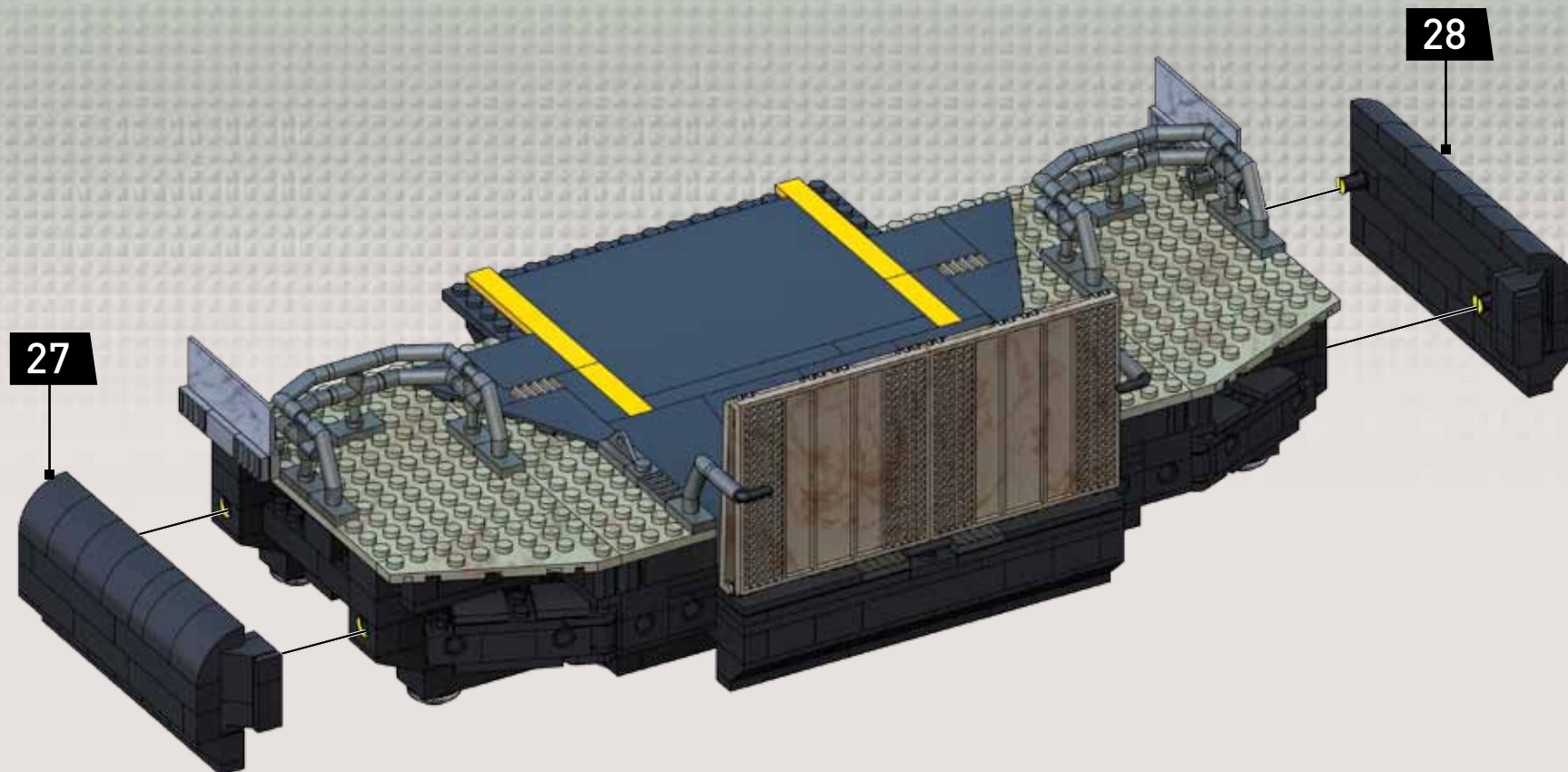

3

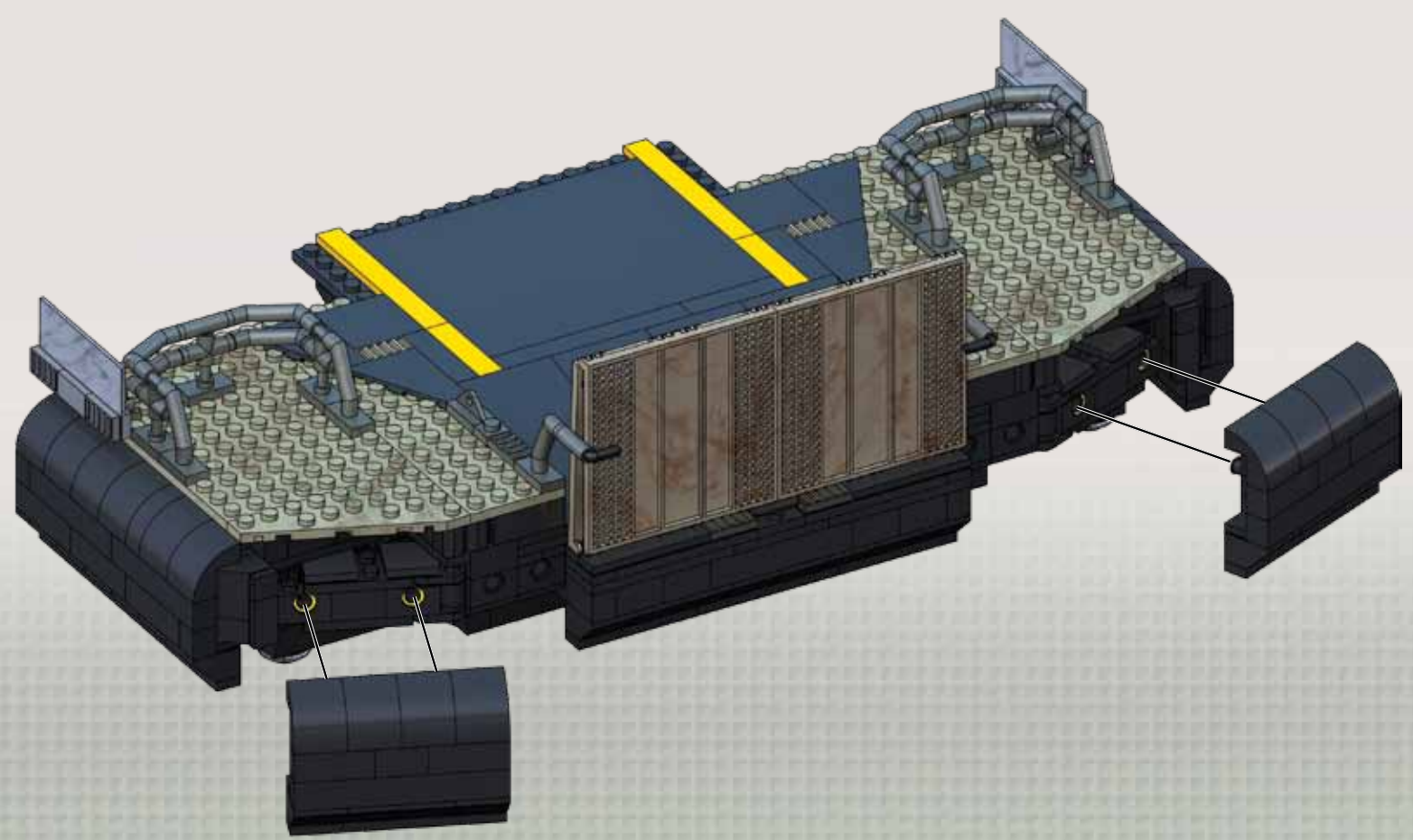
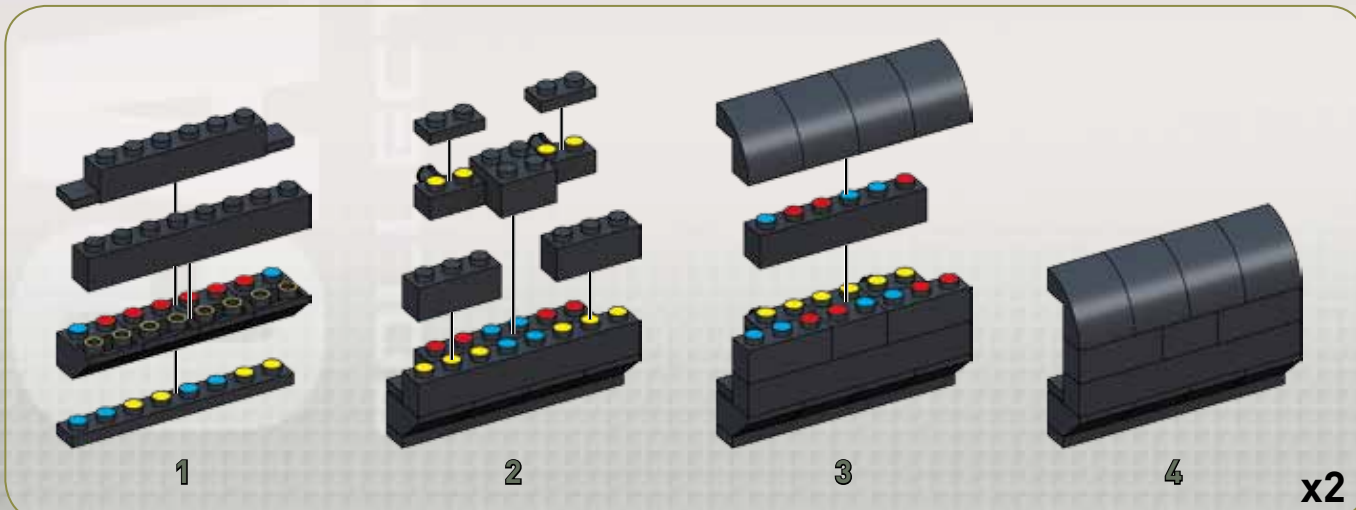
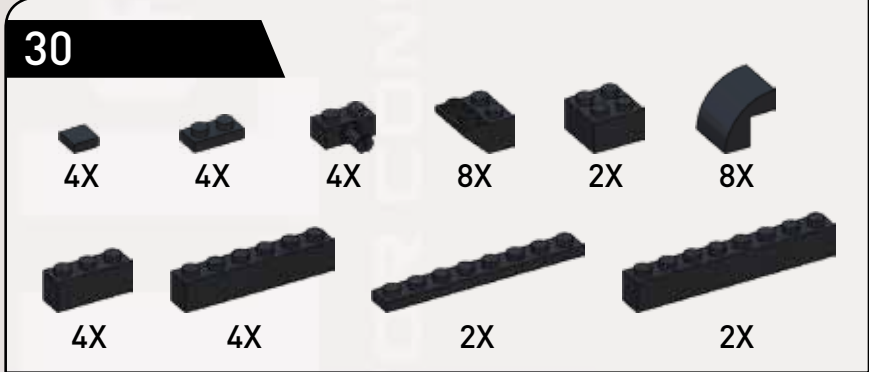

78



31

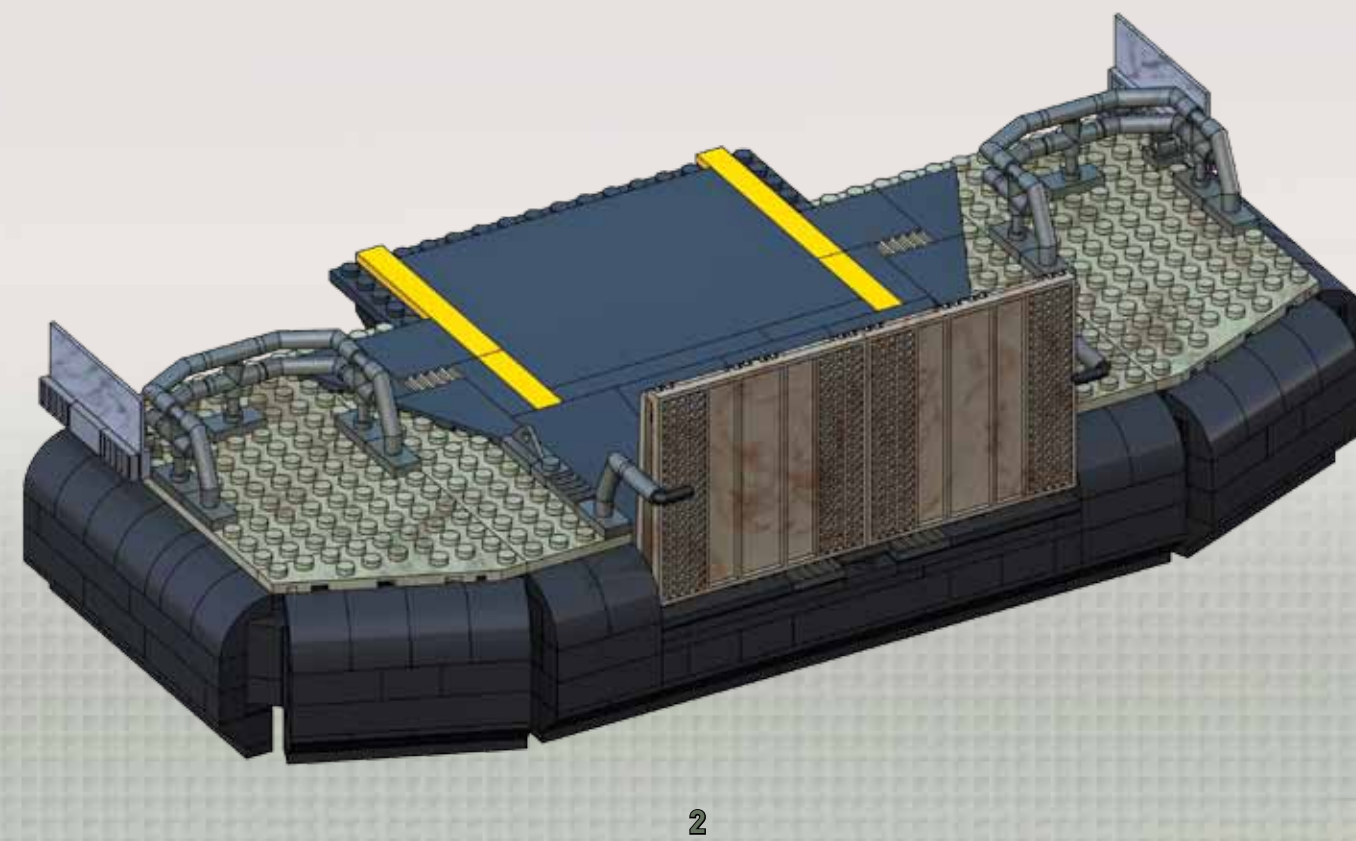
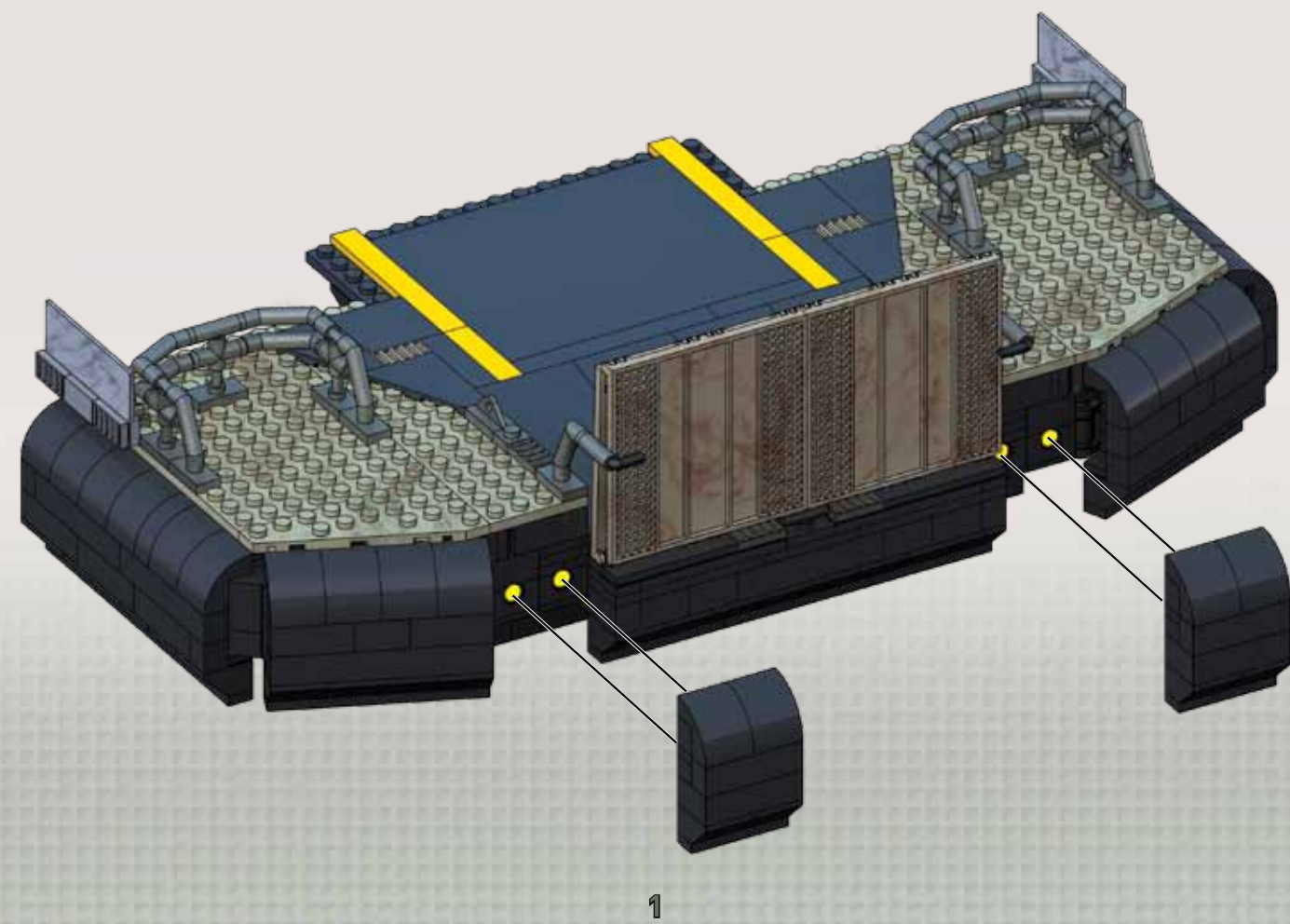
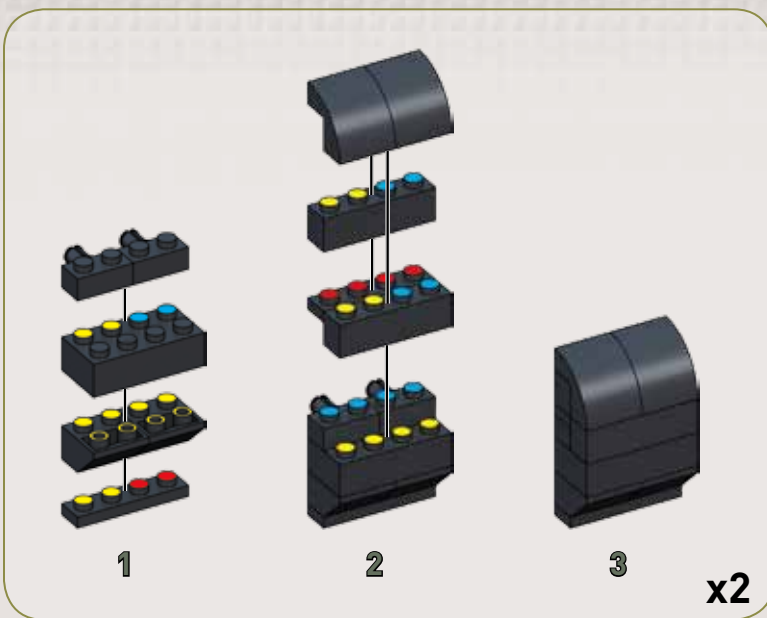

3

79

LCAC-2745138 

4

Section • Sección • Section
Abschnitt • Sectie • Sezione • Secção

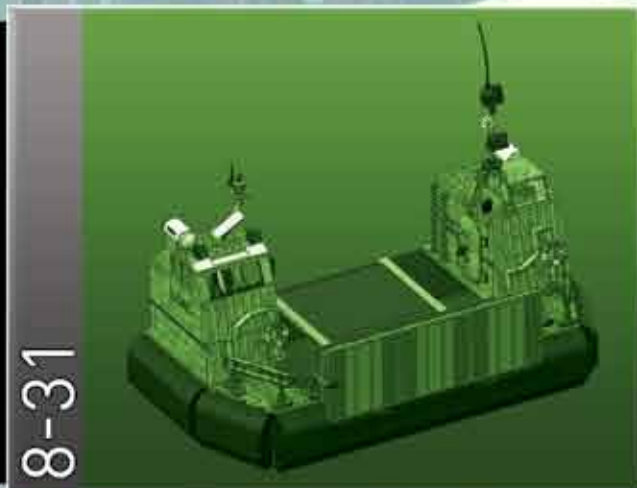

8-31

1

Section • Sección • Section
Abschnitt • Sectie • Sezione • Secção

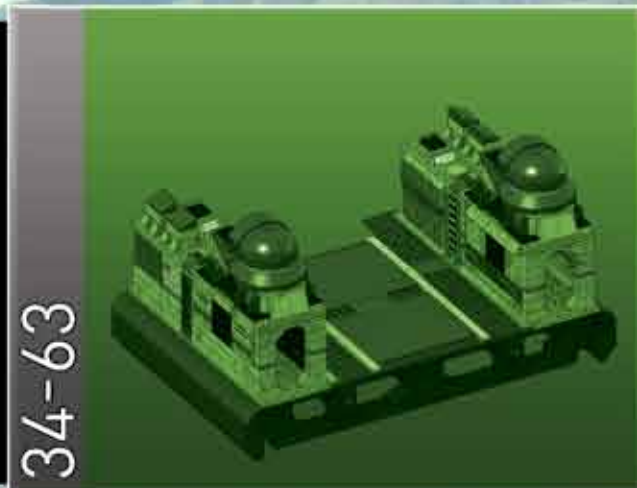

34-63

2

Section • Sección • Section
Abschnitt • Sectie • Sezione • Secção

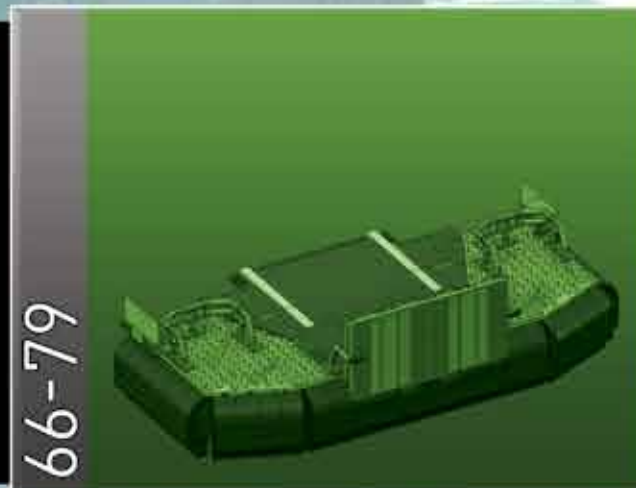

66-79

3

Section • Sección • Section
Abschnitt • Sectie • Sezione • Secção



82-86

4

Section • Sección • Section
Abschnitt • Sectie • Sezione • Secção





1

1 SECTION • SECCIÓN
SECTION • ABSCHNITT
SECTIE • SEZIONE • SECÇÃO

2 SECTION • SECCIÓN
SECTION • ABSCHNITT
SECTIE • SEZIONE • SECÇÃO

3 SECTION • SECCIÓN
SECTION • ABSCHNITT
SECTIE • SEZIONE • SECÇÃO

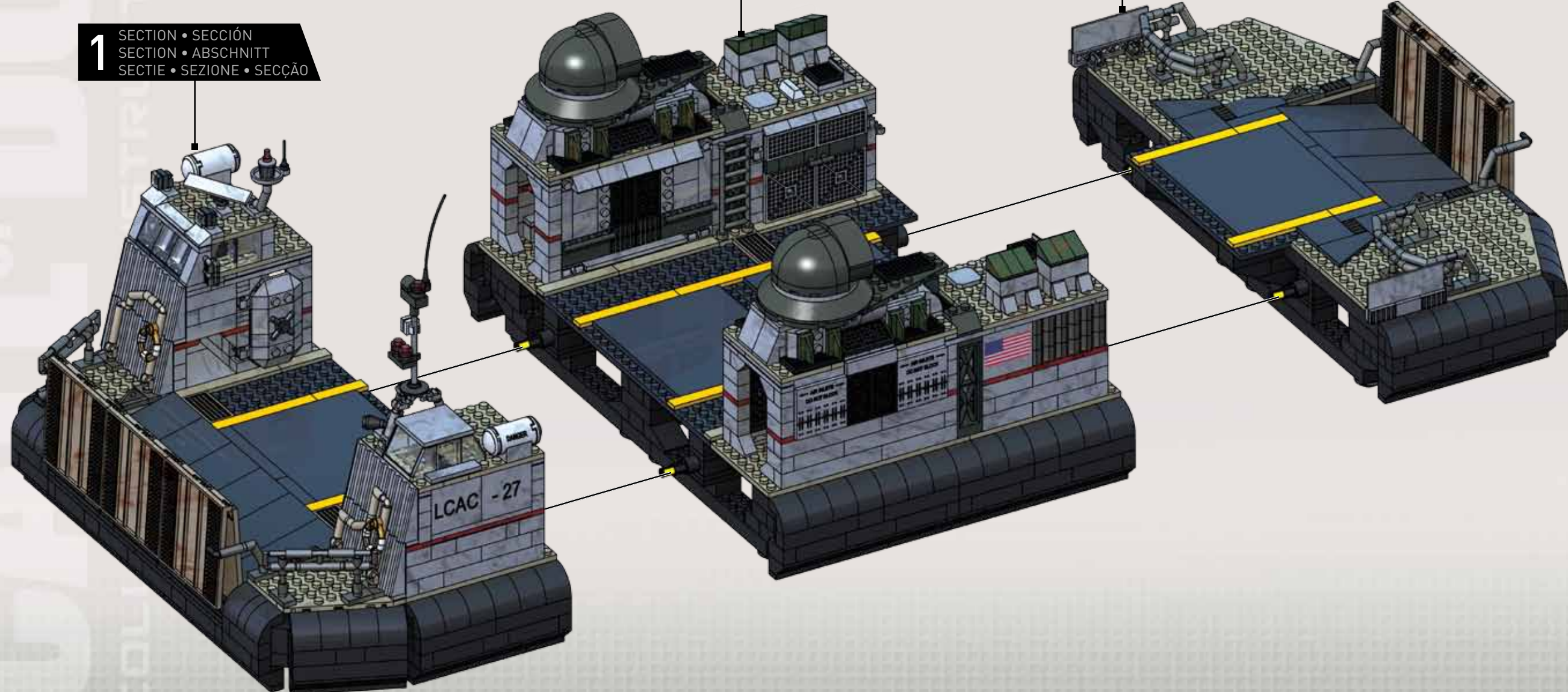

4

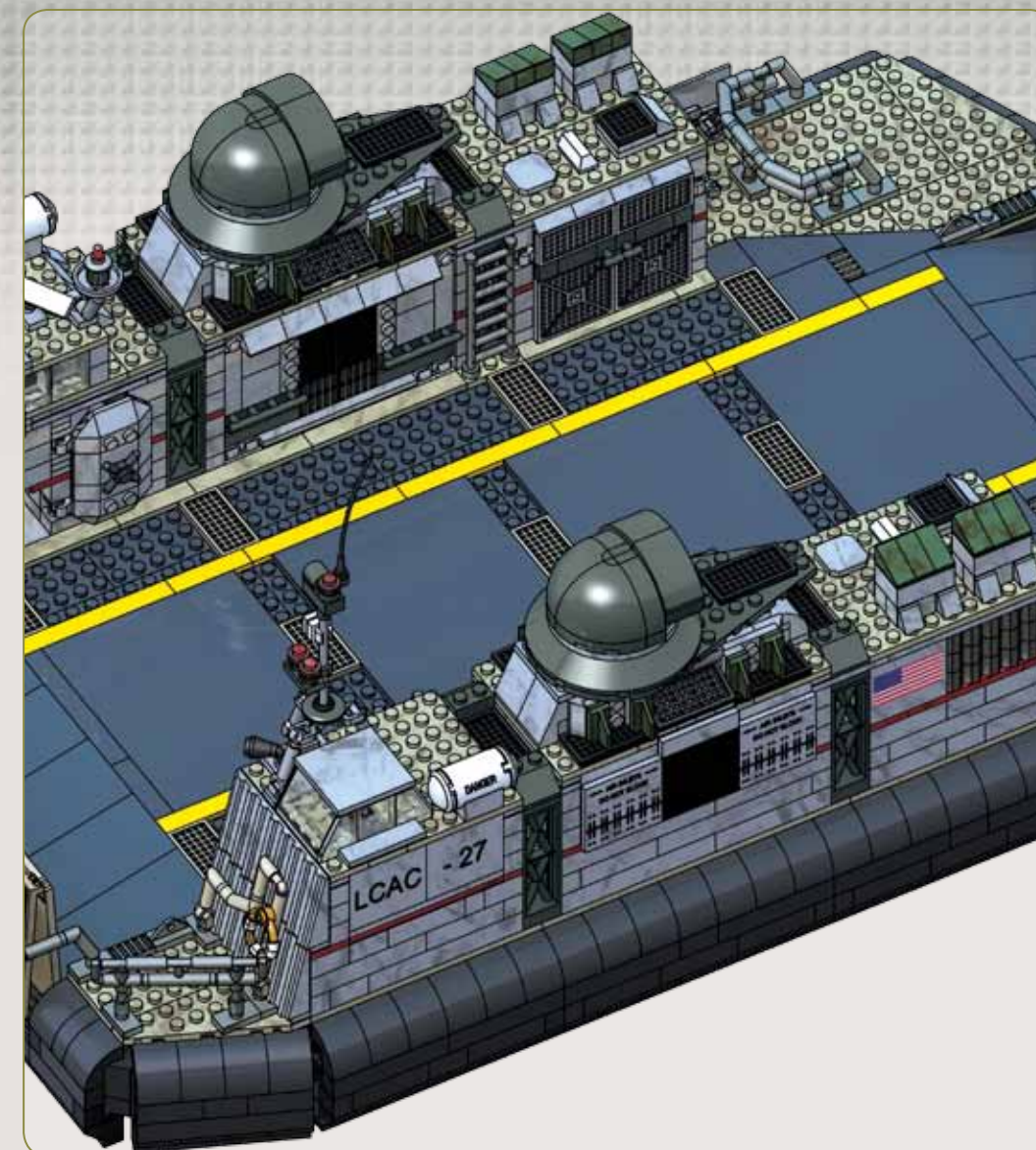
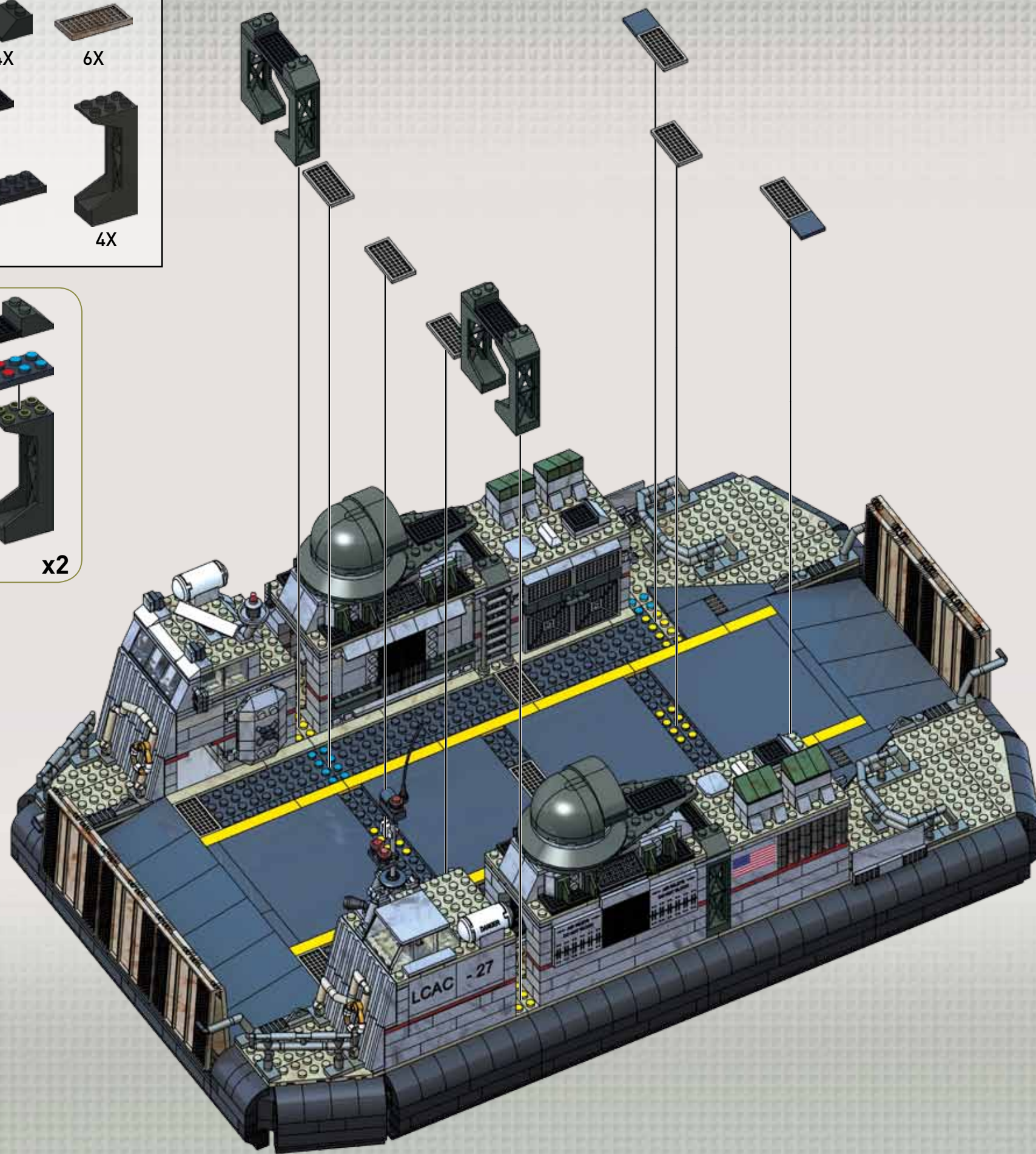
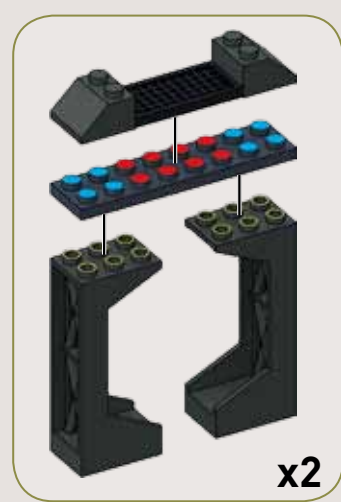
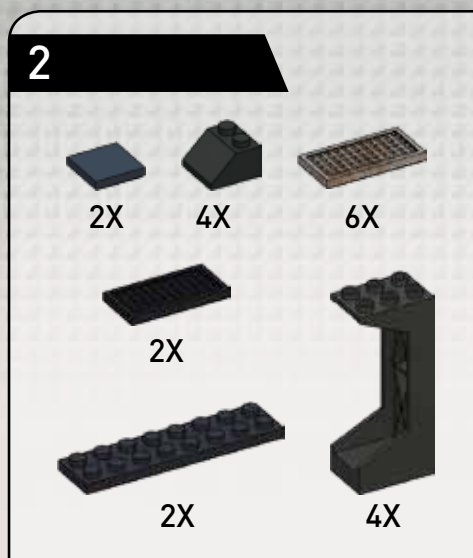



3

16X



2X



x2

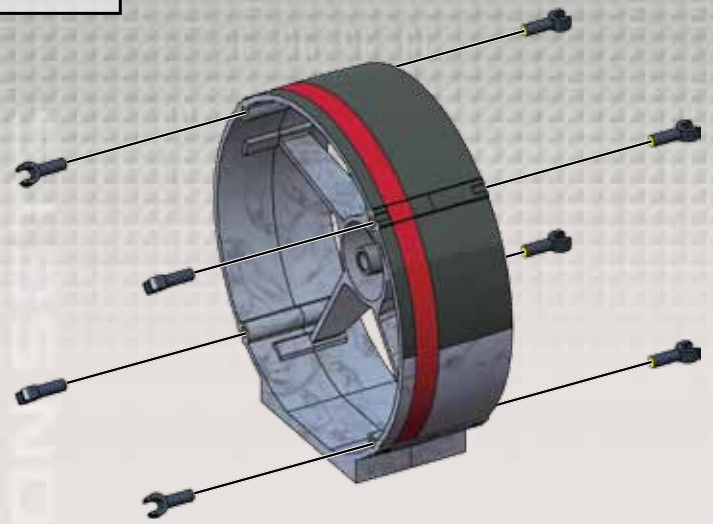

4

2X 2X 4X 2X 2X



x2

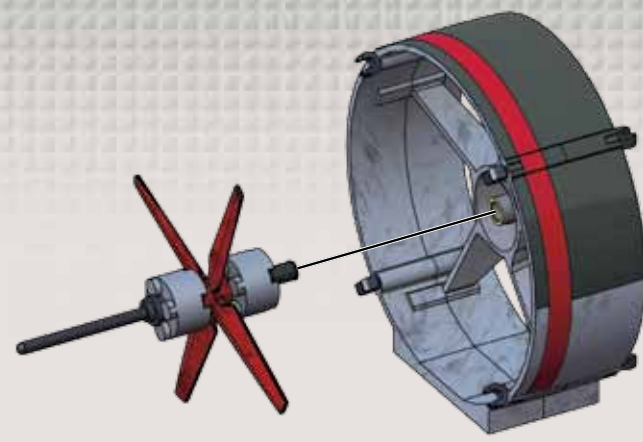
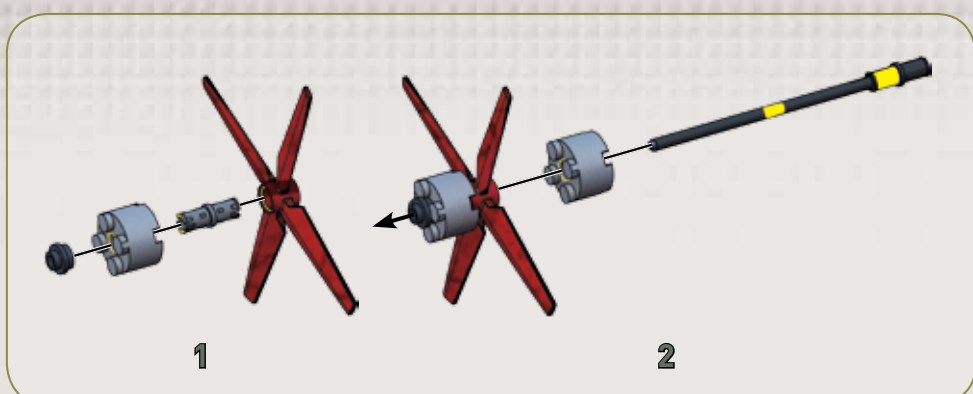

5

6X 6X 2X

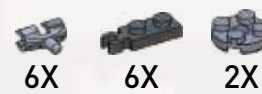

2X 2X 8X



x2

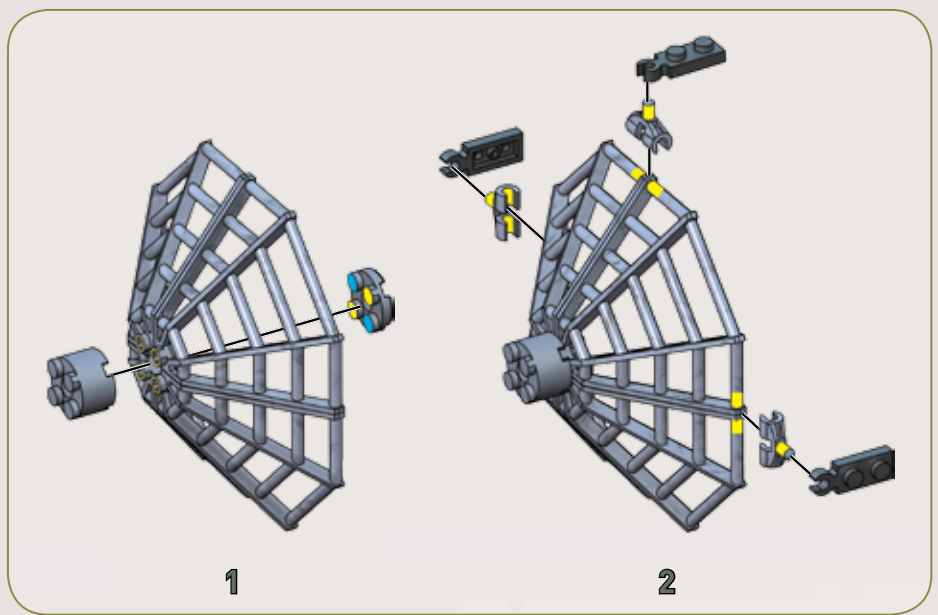

6

8X 4X 8X 4X 2X 4X 8X

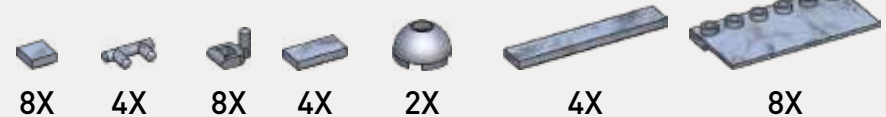

x2

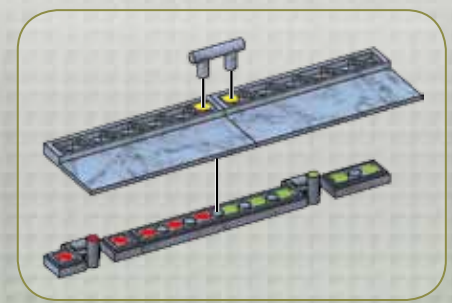
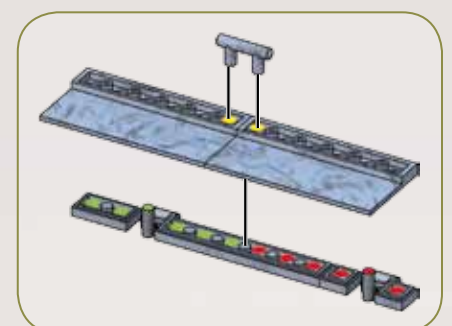
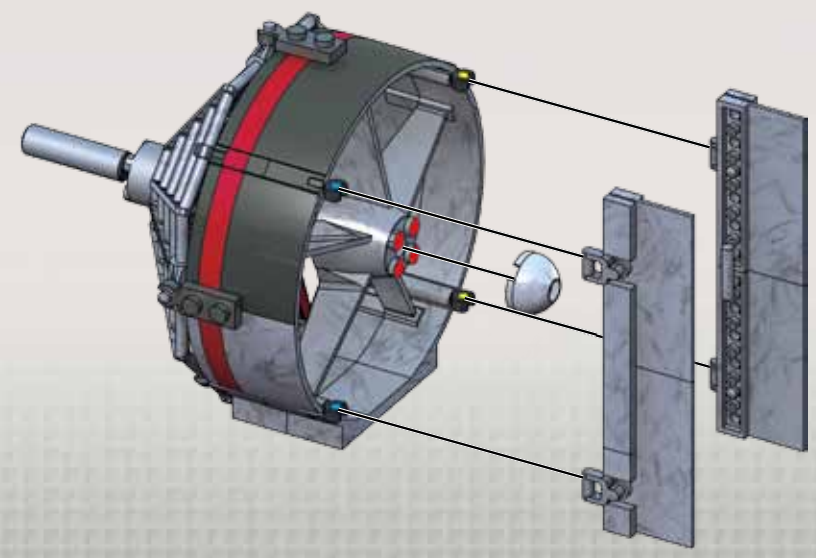

4

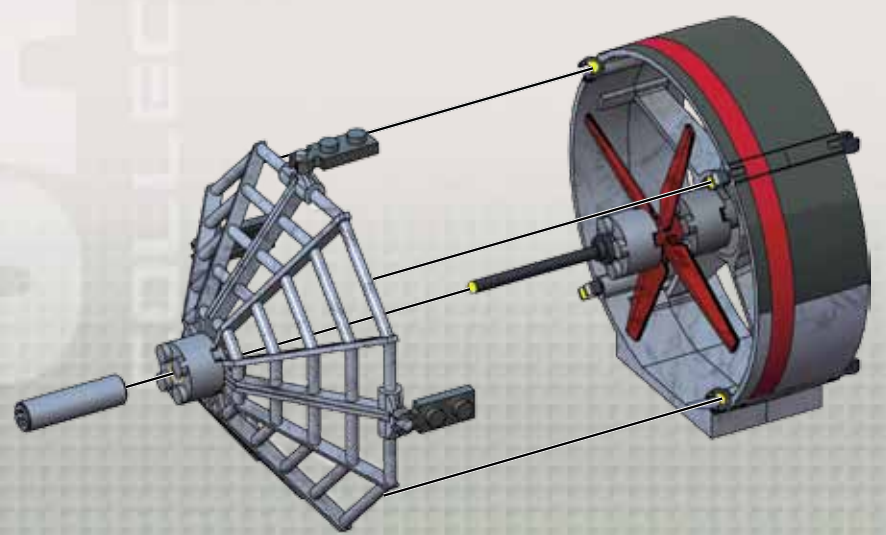



7

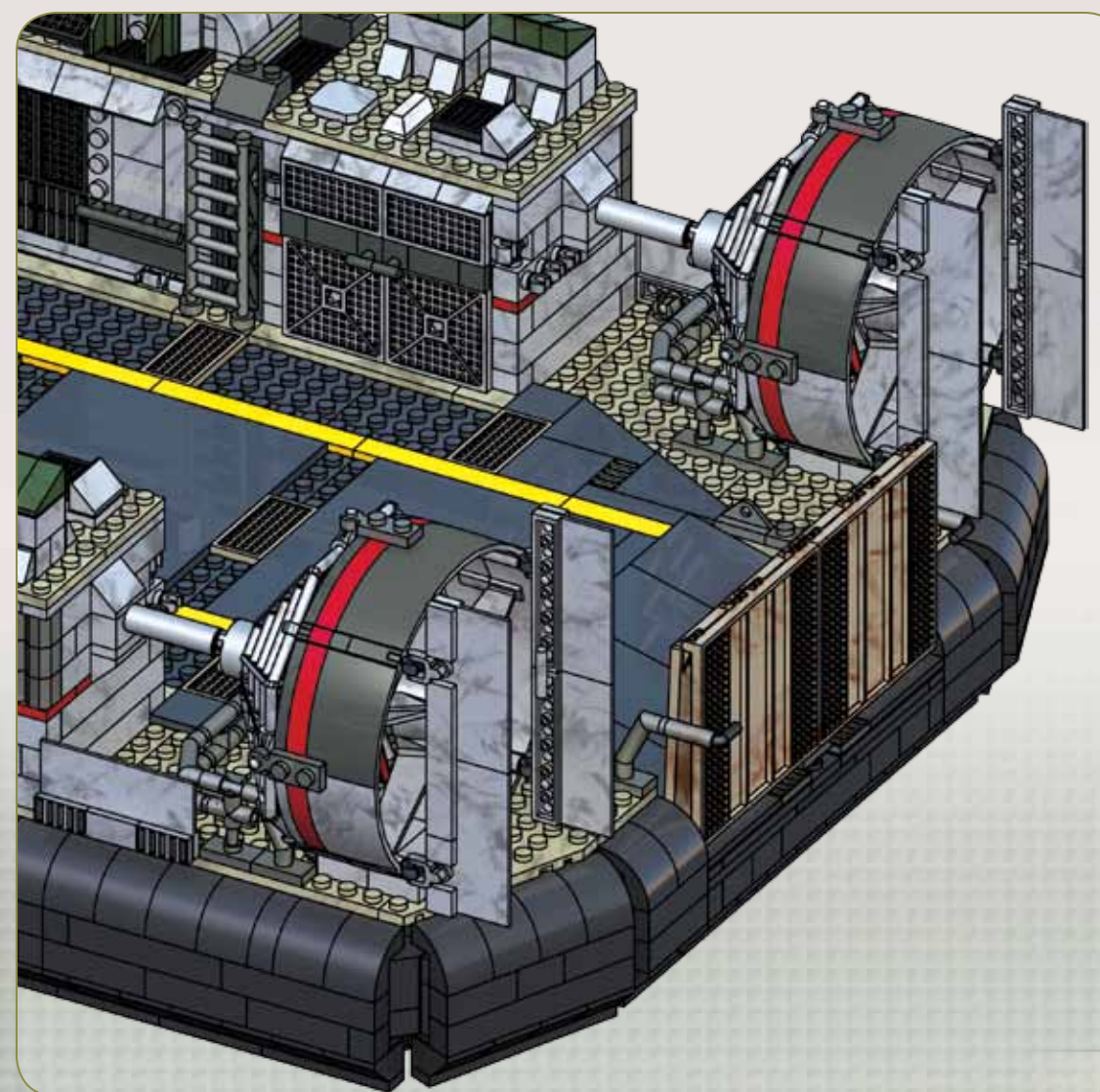
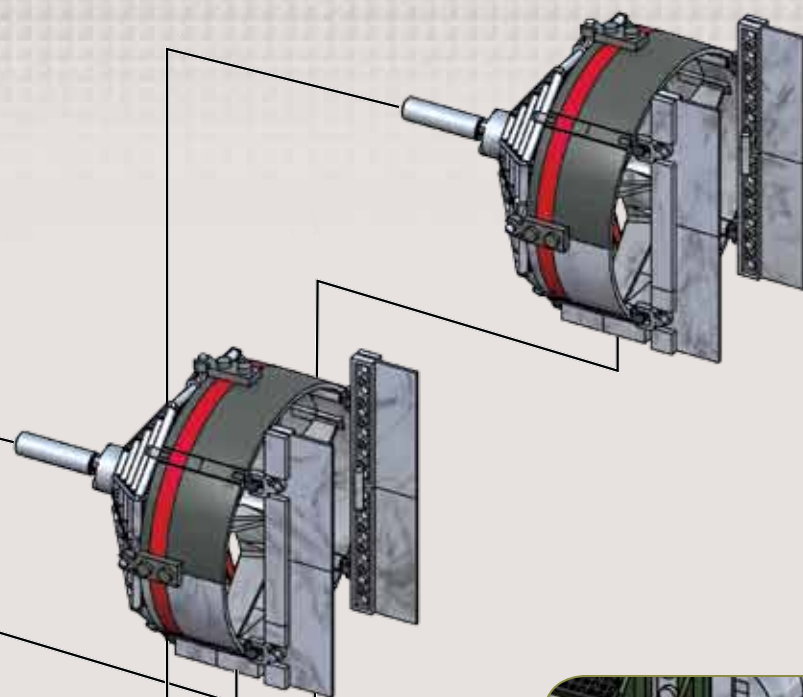
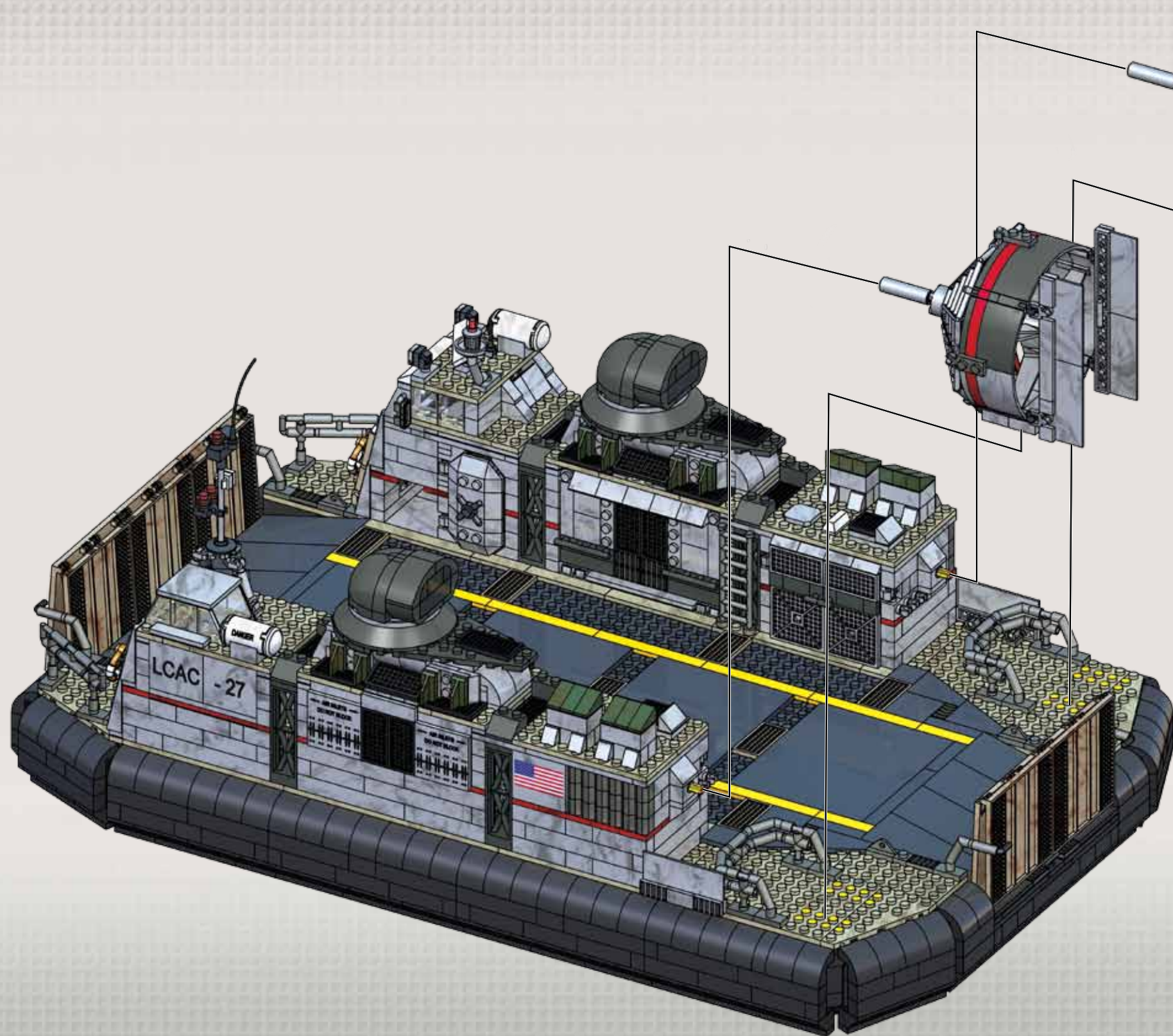

4

85



8

4X

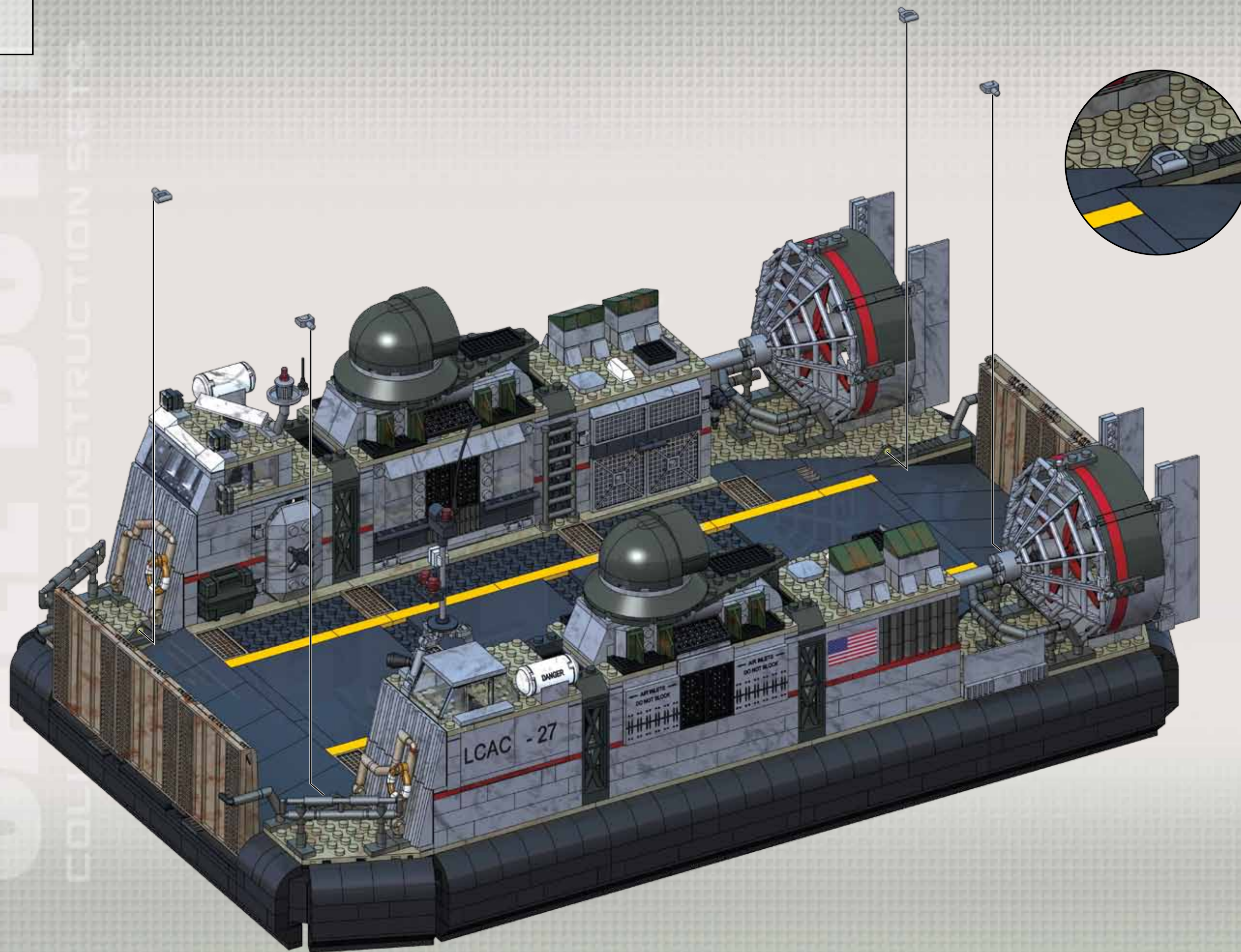

4

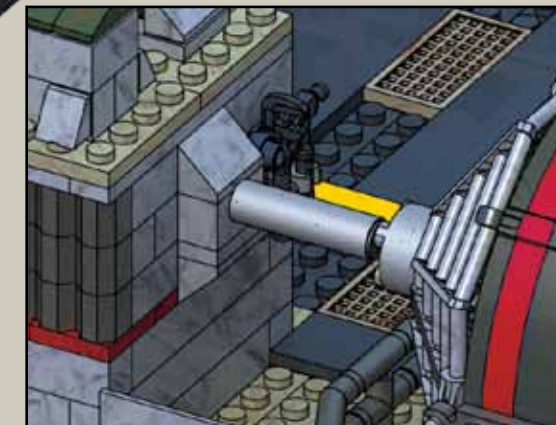
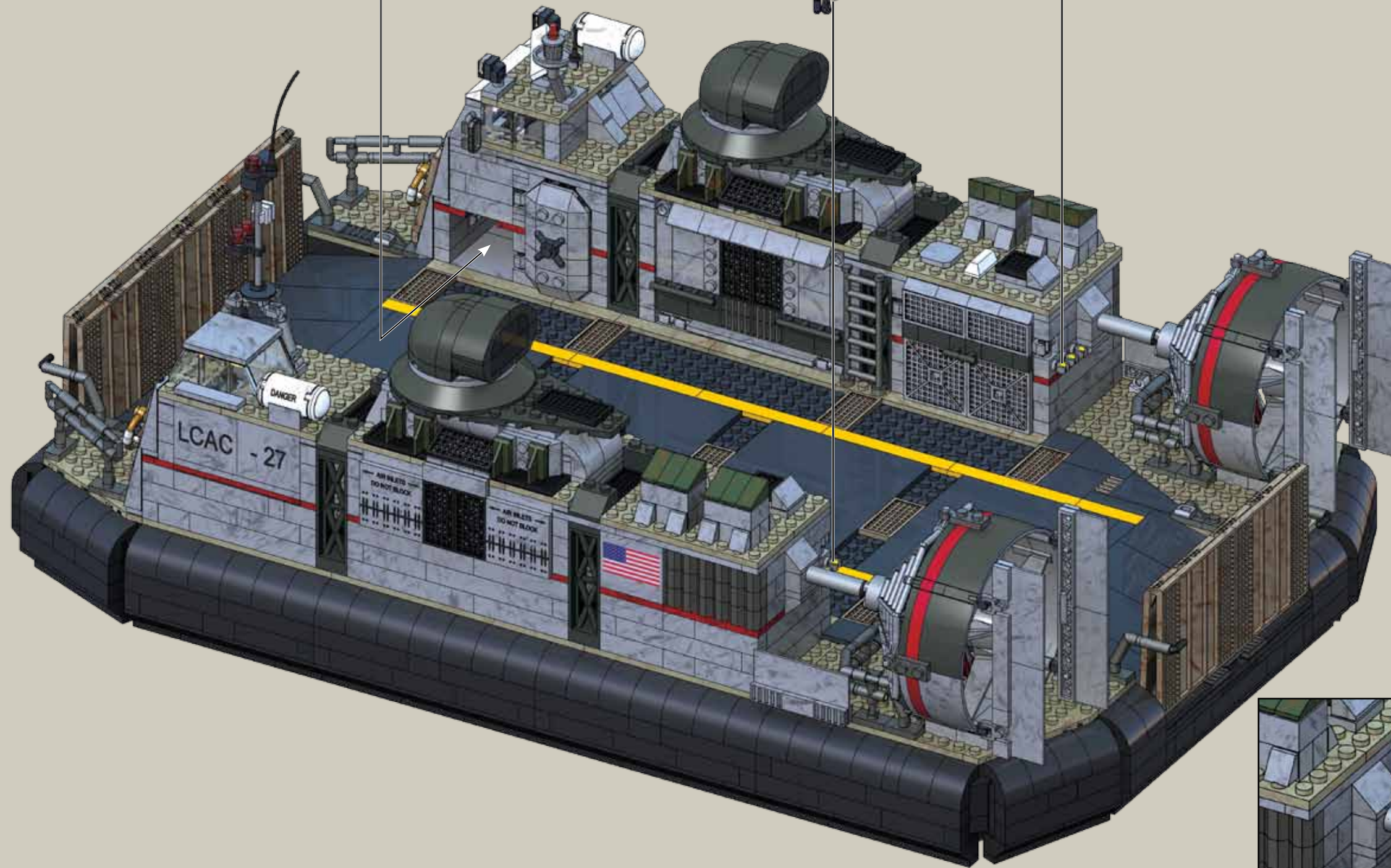
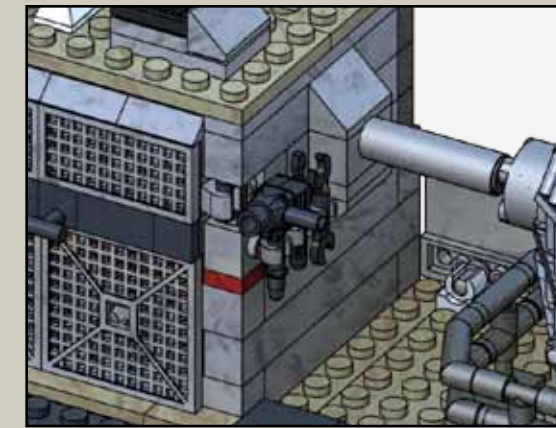
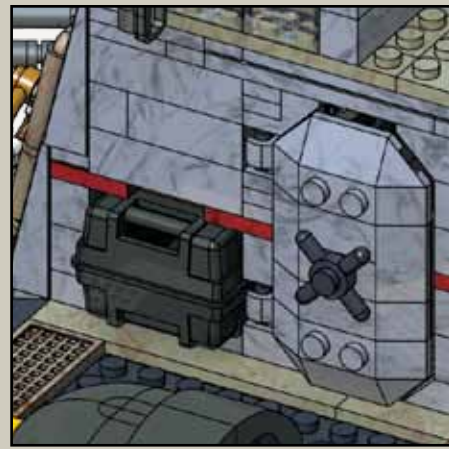

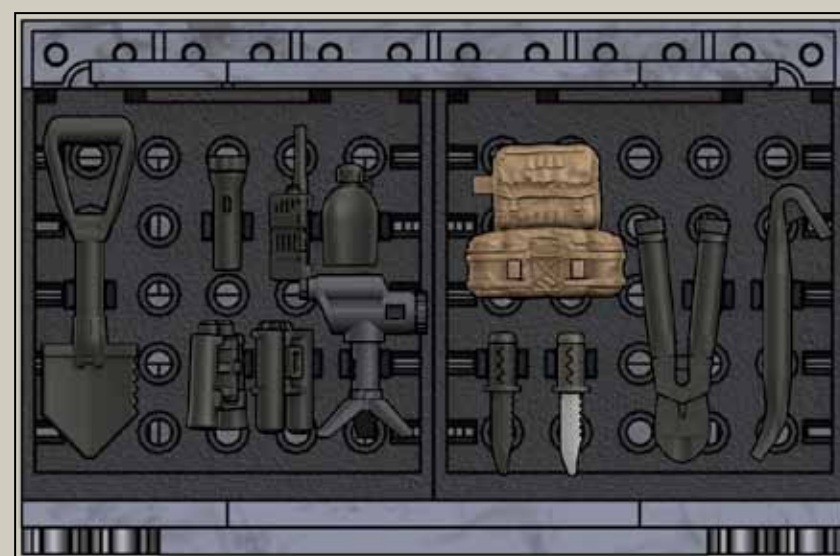
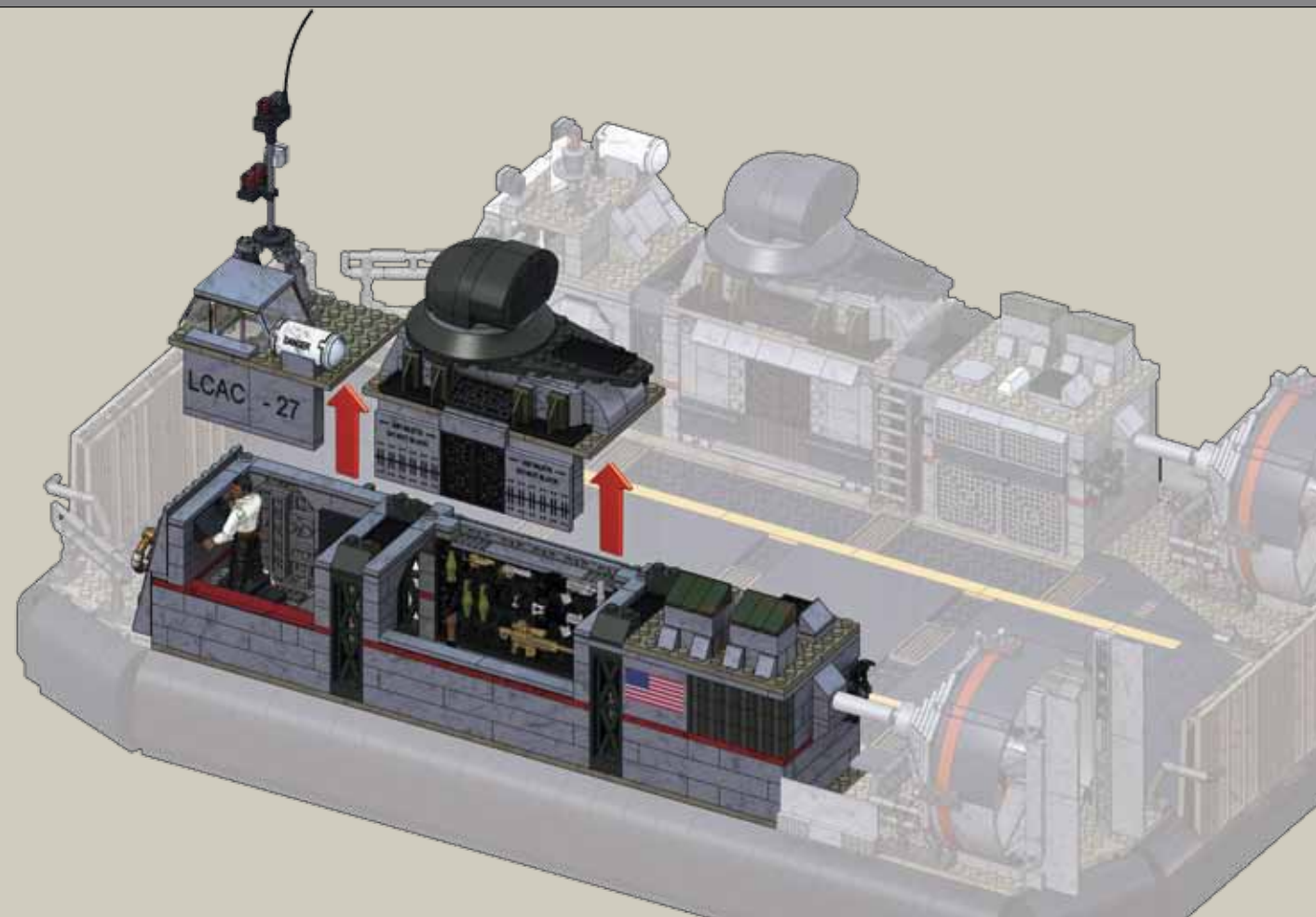
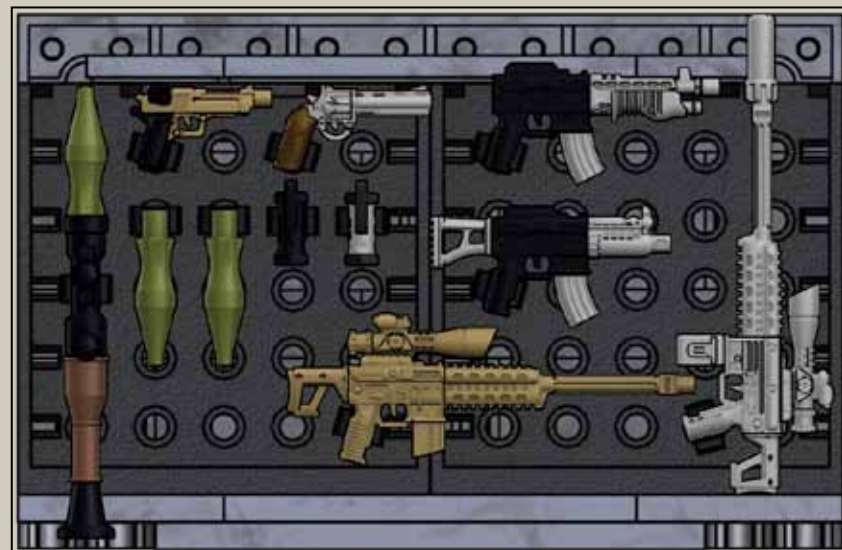

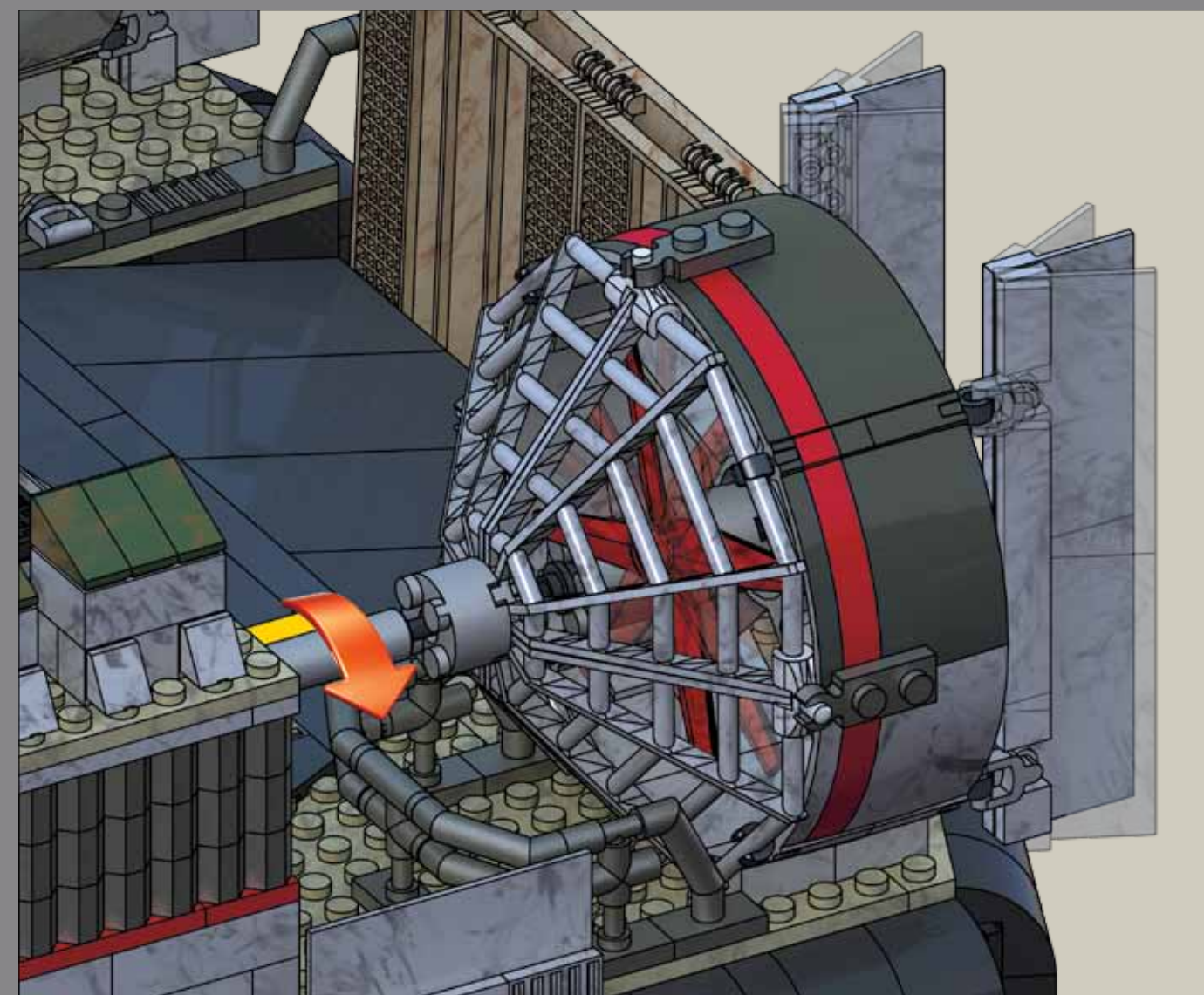
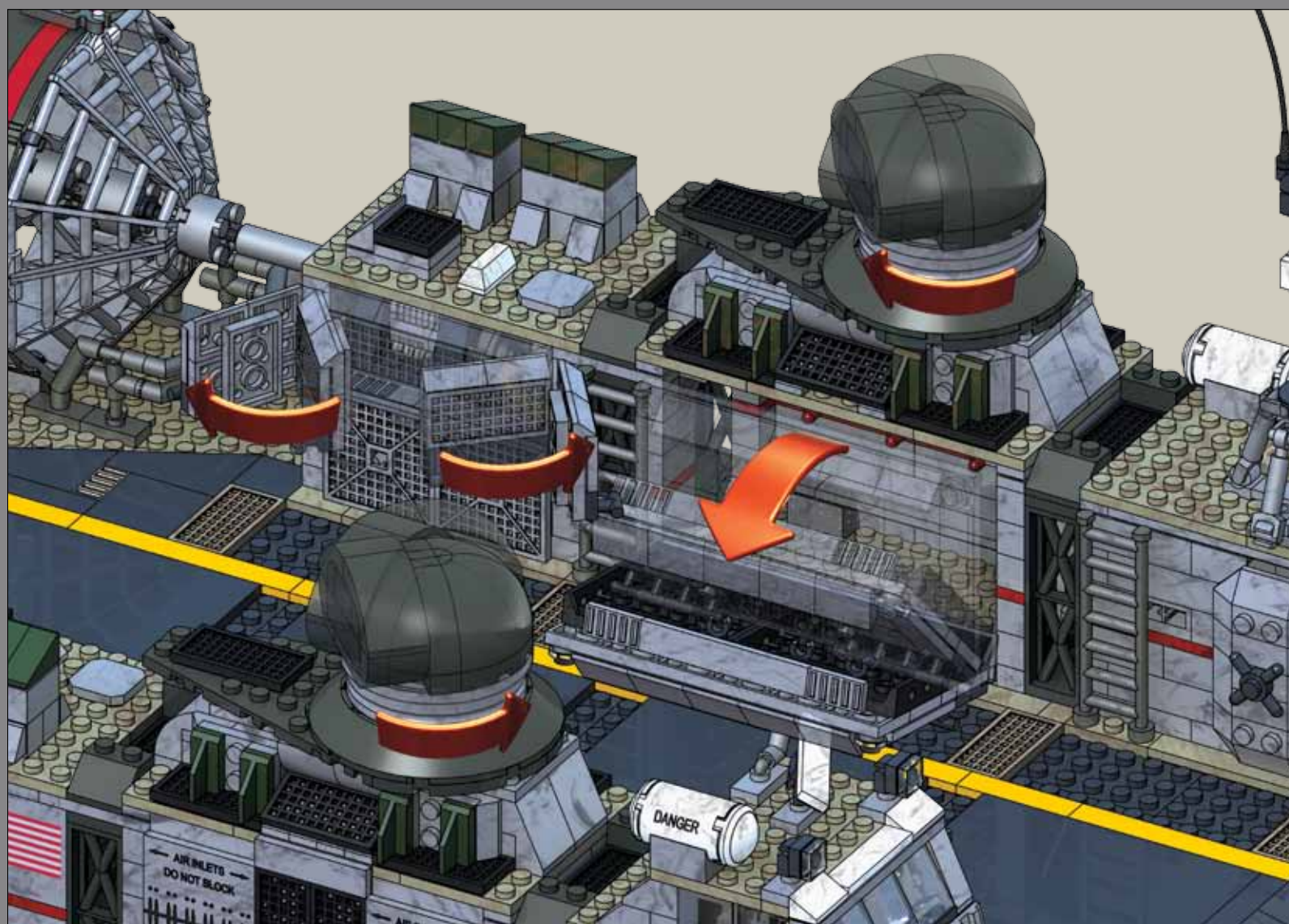
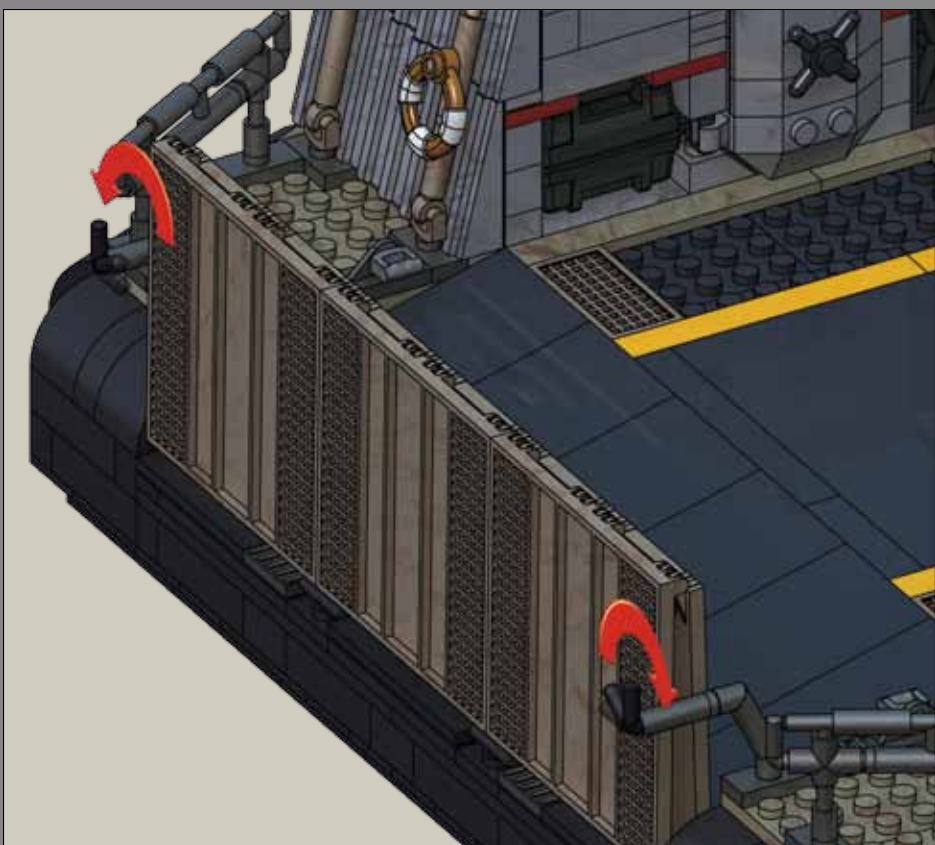

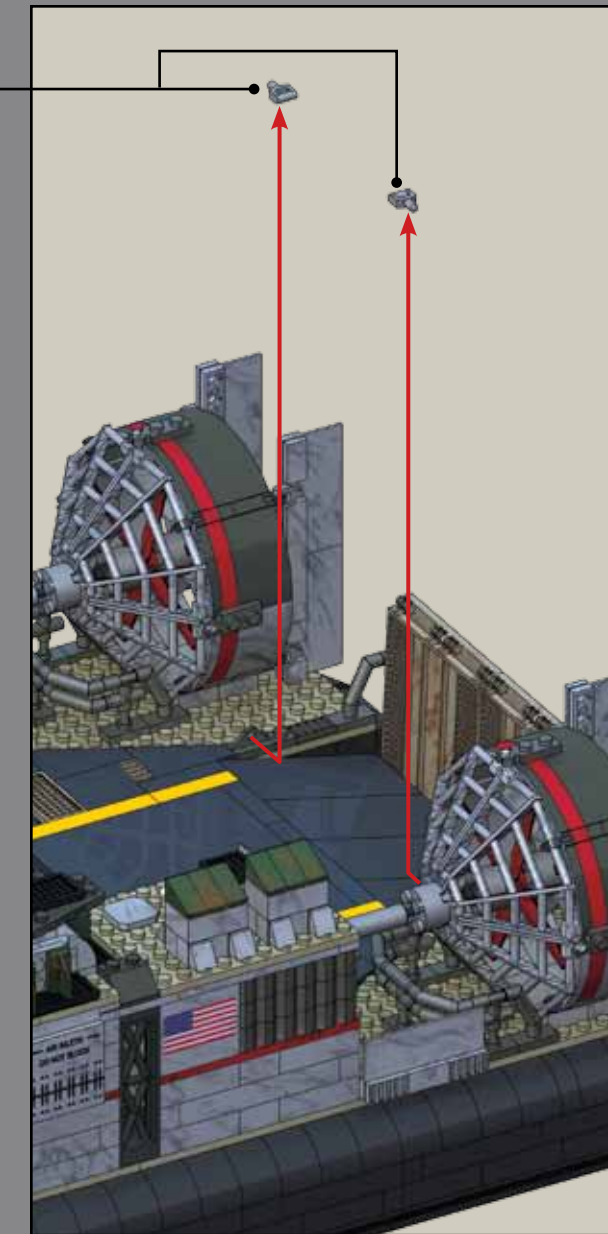
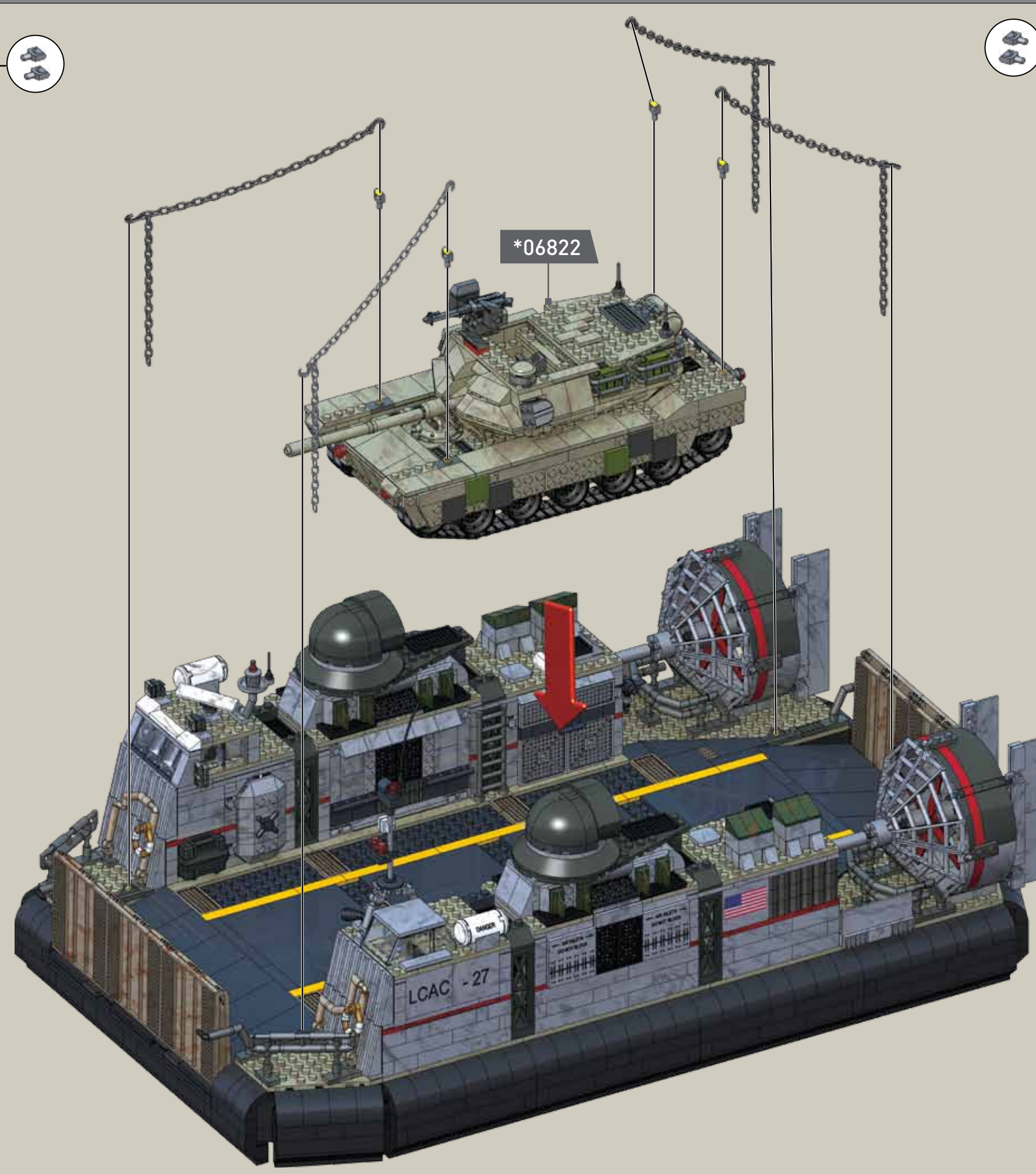
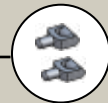
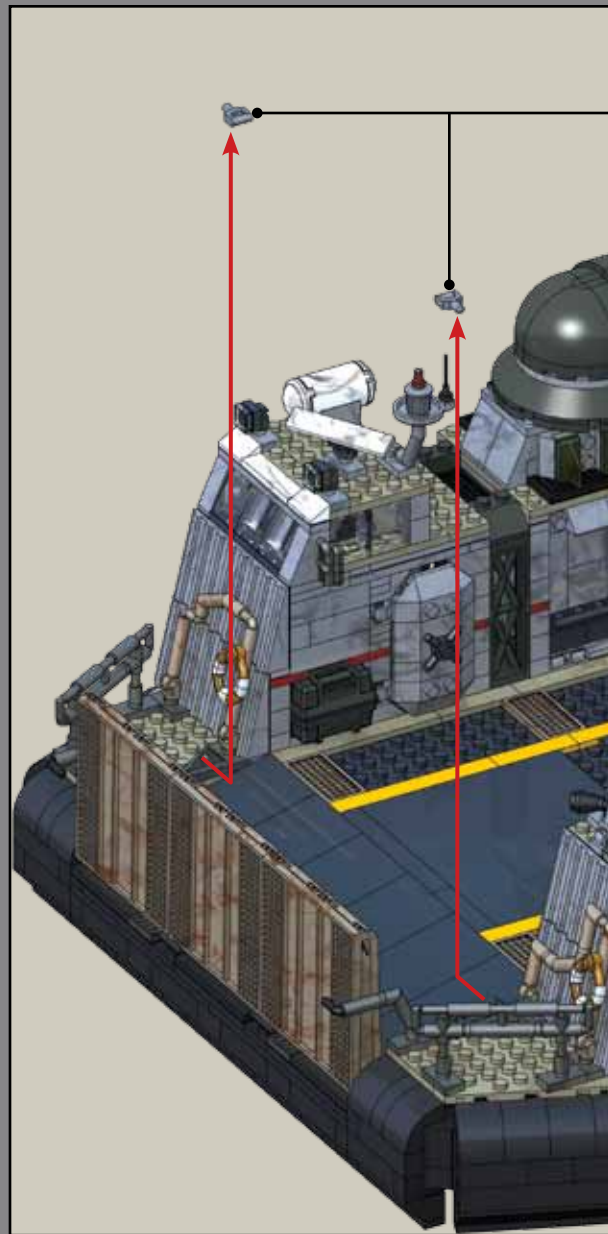

x4

*Additional purchases required to collect all elements shown. / Para coleccionar todos los elementos mostrados se precisa realizar unas compras adicionales. / Des achats additionnels sont nécessaires afin d'obtenir tous les articles de la collection illustrés. / Um alle dargestellten Elemente zu sammeln sind zusätzliche Käufe erforderlich. / Verdere aankopen zijn nodig om alle afgebeelde artikelen te verzamelen. / Acquisti supplementari necessari per collezionare tutti gli elementi illustrati. / Compras adicionais são necessárias para coleccionar todos os elementos exibidos.

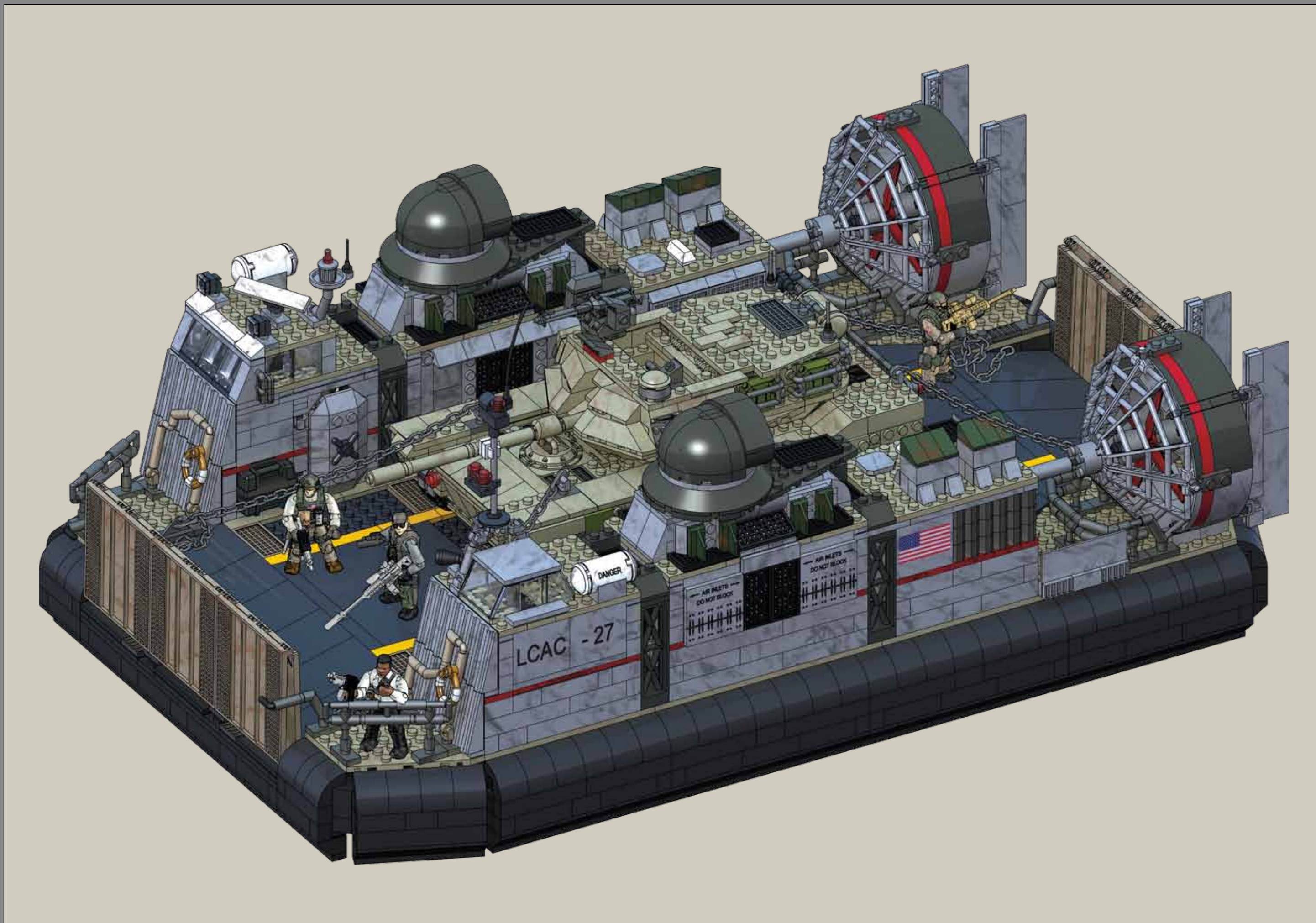

3x M1113X
6x M1113W
2x AM18560KM
10x MA1113APG
4x MA17003AJK
20x MA17003MM
5x MA17003F
1x M17003X
5x MA17003AGV
1x AM17062AJK
1x AM74397AJK
8x AM74397MM
6x AM17062AGV
2x AM19392AJK
7x AM19392MM
5x AM19392RH
2x M07223W
9x MA07223KM
1x MA07223AKQ
4x MA07223BLG
17x MA07223AJW
16x MA07223F

1x MA07223AUK
2x MA03328F
4x MA03328AJW
3x MA03328AJV
2x MA03328MM
21x MA17127AJW
1x AM16980KM
1x AM17787F
8x AM02641MM
4x AM76060AJK
7x AM76060AGV
11x AM76060KM
3x AM19617AGV
3x AM19617AJK
39x AM19617KM
19x AM19650AGV
10x AM19999AJW
4x AM19999MM

1x AM18623AKQ
3x AM18623KM
4x AM15486KM
1x AM74415AJW
1x MA12251KM
1x AM19900AGV
2x MA1140AGV
8x MA1140AJV
1x MA19328F
2x MA04428AJW
2x AM18287AGV
10x AM18287MM
3x AM18287F
4x AM18597AJW
1x AM73904AJK
2x MA17506AJK
10x MA17506MM
3x MA17506AGV
2x AM73534BDG
2x AM19774AJW

6x AM18260AJW
2x AM74645AJK
1x AM72249F
1x AM72233AJK
2x AM72233MM
2x AM18256AJK
1x AM09216KM
1x AM08412RH
4x MA0910F
1x AM16303AGV
29x MA1086AJW
14x MA1086F
4x MA1086KM
24x MA07629AJW
2x AM17507AJW
1x AM74414KM
4x MA17201F
16x MA09198MM

18x MA09198AJW
2x MA09198AJK
2x MA09198AJV
14x MA022501AJW
4x MA022501F
2x MA022501AUK
17x MA022501KM
14x MA07590MM
8x MA07590AJW
3x MA07590F
2x AM73758AJW
14x MA09393AJV
53x MA09393F
1x MA09393AUK
20x MA09393AJW
1x AS0685915
2x MA18549AKQ
4x MA18549AJW

3x AM18272KM
2x AM18232AKQ
16x MA09835AJW
8x MA16975AJW
6x AM72917MM
1x AM19660KM
1x AS0687905
8x AM17070MM
2x AM17070AJW
4x AM18596MM
16x AM18269AUL
2x AS0682933
2x AS0682932
1x AM72569F
10x AM75511MM
1x MA17522AJW
12x MA04430AUL

12x MA04429AJW
12x MA03019AJW
1x AM18660F
20x MA1322AJW
4x MA1322F
6x MA1417F
16x MA1417AJW
1x AM74272KM
32x MA11101F
4x MA1133F
18x MA1133MM
92x MA09013F
79x MA09013AJW
32x MA07658F
2x MA07658AJW
4x MA17502KM
5x MA17502AJW

4x AM09624F
4x AM09625F
2x AM74657AJK
1x AM74657AGV
16x AM74657MM
4x MA16682F
1x AM03872AJW
7x AM03872AGV
2x AM74150AJW
4x AM18658KM
1x AM74656F
2x AM09893AGV
2x AM03103AKQ
2x AM17057AKQ
43x AM17057AGV

2x AM19380APG
2x AM17010APG
8x AM16972F
4x AM74428AJW
9x MA15484AJV
4x MA15484AUK
3x MA15484AJW
2x AM18543AJW
2x AM18525RH
11x MA0948AJW
10x MA0948LP
13x MA03773F
8x MA03773AJW
2x MA03773KM
1x MA09268F
12x MA1146AJW
1x MA18329AJW
1x MA18328AJW

1x AM02050AJW
2x AM01404APG
2x AM18266AGV
6x AM04217AGV
8x MA08482AJW
4x MA08482KM
2x MA17153F
7x MA17153AJW
8x MA10273KM
1x AS0685916
4x MA10273F
2x MA10273AJW
4x MA1154KM
2x MA1154AJW
96x MA1154F
2x AM17019APG

2x MA09023AJW
70x MA09023F
76x AM08481F
4x AM08481AJW
4x AM18562AJW
2x AM16681AGY
8x MA1141AJW
4x AM72600AJW
4x AM72600F
2x MA1314AJV
3x MA1314AUK
6x MA1314AJW
8x MA1314F
11x MA16384AJW
16x MA16384F

29x MA03772AJW
4x MA03772F
2x MA03772AUK
1x AM17509KM
14x MA04497F
29x MA1139F
10x MA03873AJW
16x MA03873F
4x AM72088F
2x AS0685904
2x AS0685914
2x AS0685913
2x AM18615LP
1x AS0685909
4x AM72257KM

2x AM72240RH
4x MA09838FM
11x MA09838AJW
1x MA09838AKQ
1x MA09838AUK
4x MA09838LP
22x MA09593F
1x MA09593AJV
18x MA09593AJW
2x MA09593KM
10x MA1389F
2x AM19775AGV
4x AM01847KM
18x MA1087F
4x MA1087KM
50x MA1087AJW
16x MA17503AJW
26x AM18276RH

11x AM18276AJK
4x AM18276AJW
18x MA09493F
25x MA09493AJW
3x MA09493KM
4x AM18736AJW
2x MA04434LP
2x MA04433LP
4x AM17285F
4x MA09033KM
110x MA09033F
10x MA09033AJW
2x AM07013AGY
4x AM19781KM
4x MA74680KM

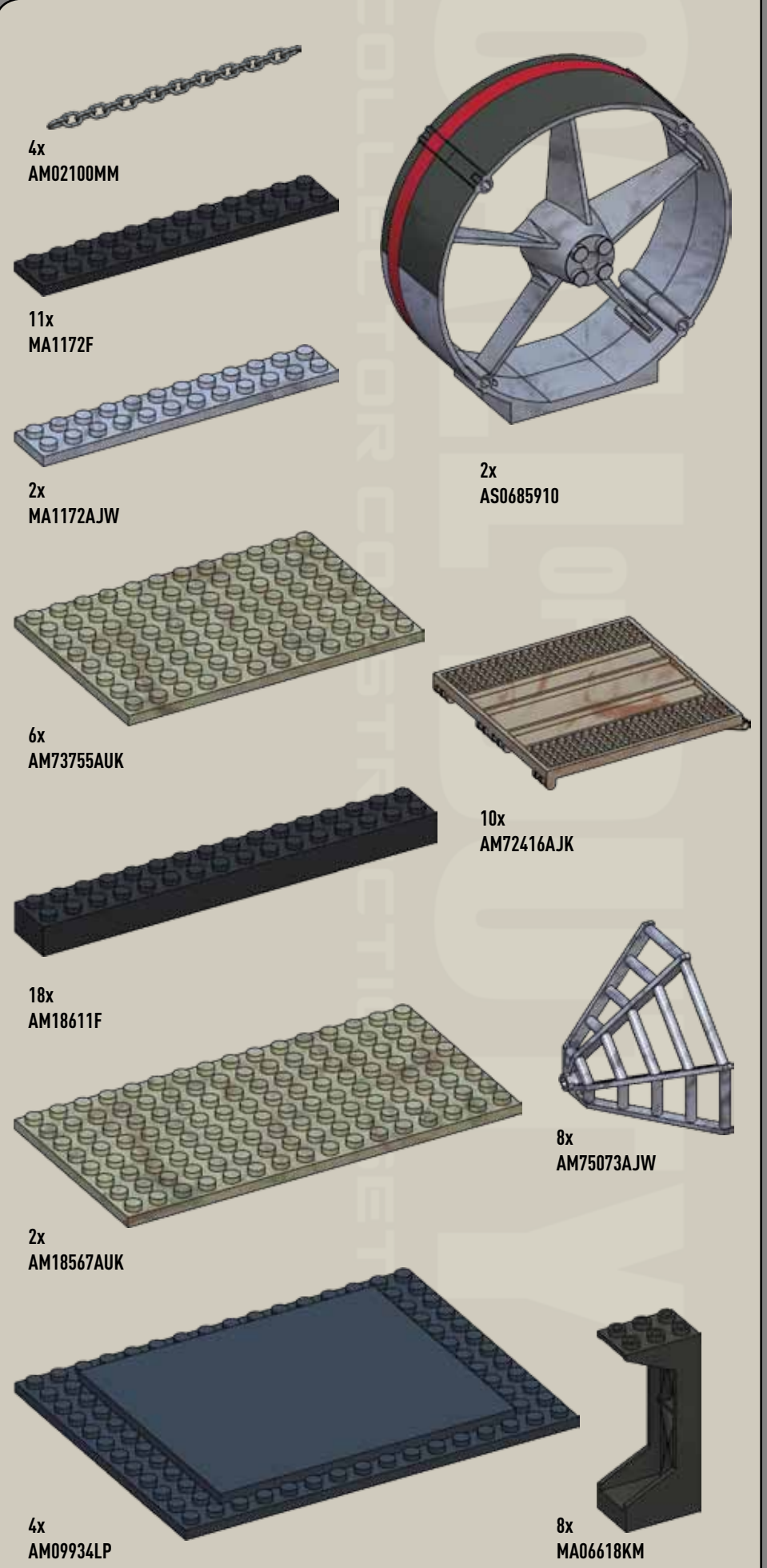
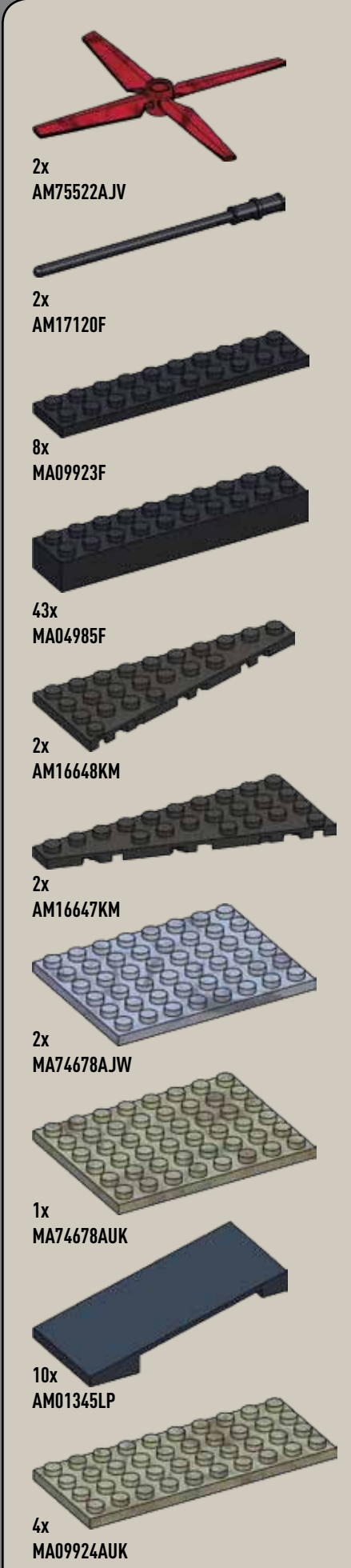
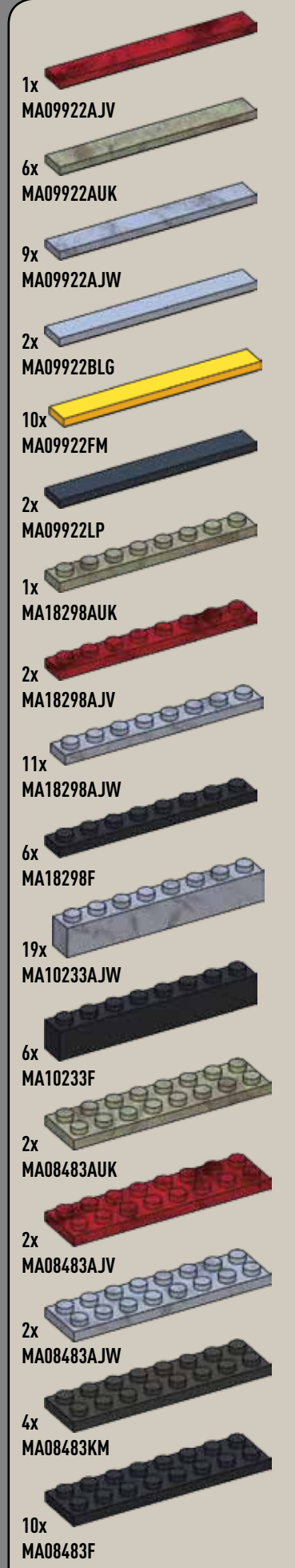
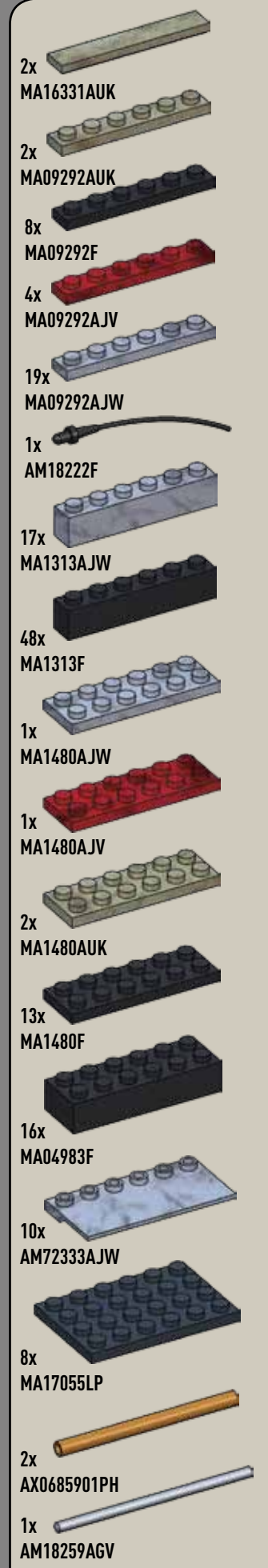
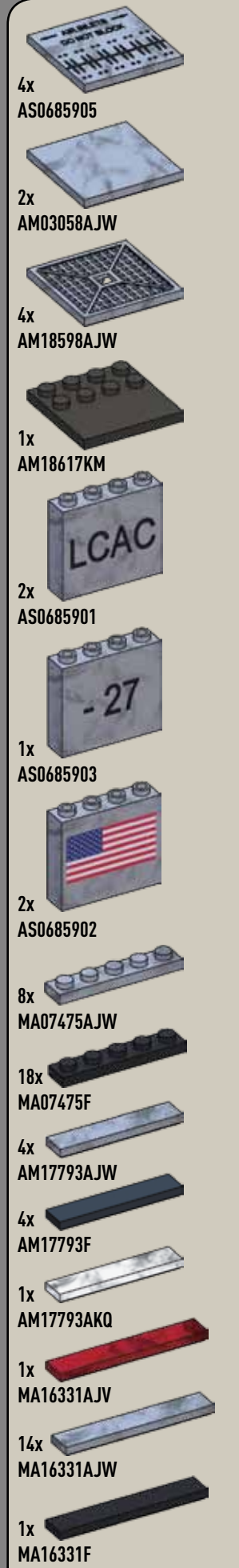

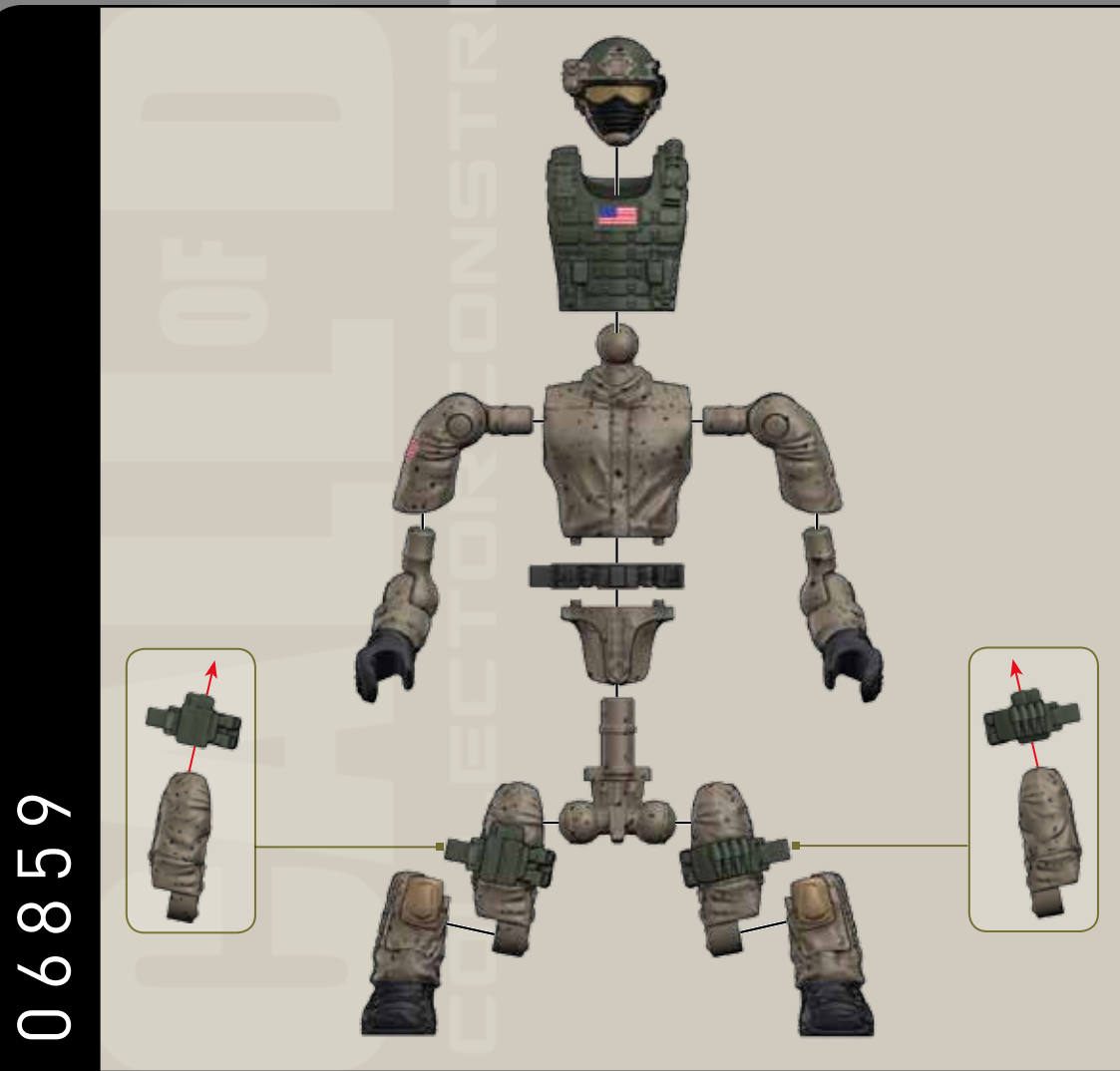

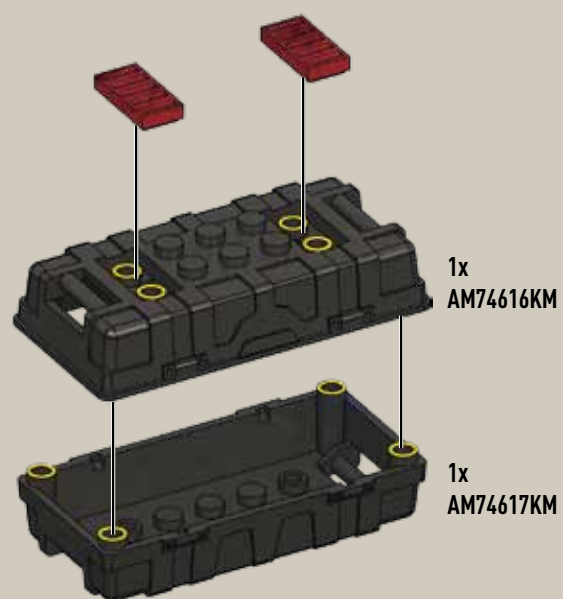

1x
AM74616KM

1x
AM74617KM

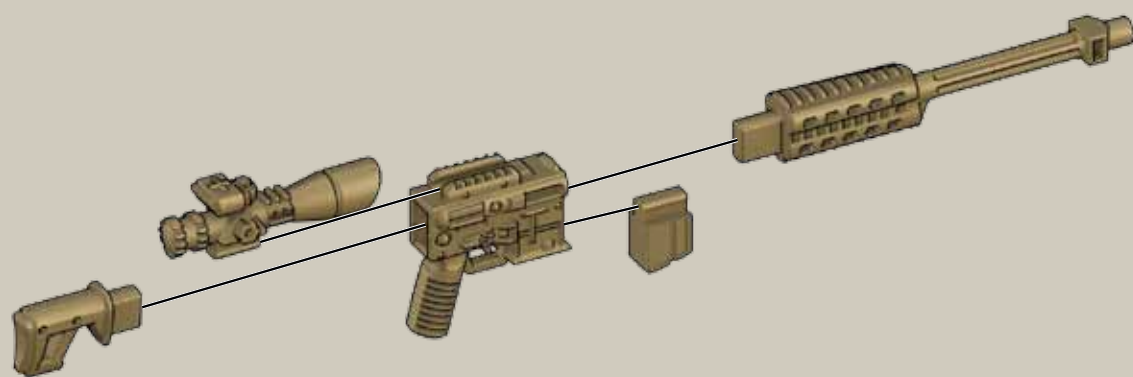

- EN Please read these instructions carefully before first use and keep them for future reference.
- FR Il est recommandé de lire attentivement ce feuillet avant la première utilisation et de le conserver pour référence future.
- ES Leer estas instrucciones cuidadosamente antes de la primera utilización y guardarlas para referencia futura.
- DE Die Gebrauchsanleitung bitte durchlesen und aufbewahren.
- NL Wij raden u aan deze handleiding zorgvuldig te lezen en te bewaren voor eventuele raadpleging op een later tijdstip.
- IT Leggere le istruzioni prima di cominciare ad usare il gioco e conservarle per referenze future.
- PT Leia as instruções antes do primeiro uso e guarde-as para futura referência.
- PL Proszę uważnie przeczytać instrukcję obsługi przed pierwszym użyciem, a następnie zachować ją na przyszłość.
- DA Vær venlig at læse disse instruktioner omhyggeligt inden ibrugtagning og opbevar dem til fremtidigt brug.
- EL Διαβάστε αυτές τις οδηγίες προσεκτικά πριν χρησιμοποιήσετε το προϊόν για πρώτη φορά και φυλάξτε τις για μελλοντική αναφορά.
- FI Lue nämä ohjeet huolellisesti ennen ensimmäistä käyttöä ja säilytä ne myöhempää tarvetta varten.
- NO Les disse instruksjonene nøye før første gangs bruk, og ta vare på dem for fremtidige oppslag.
- SV Läs noggrant igenom dessa instruktioner innan du använder produkten för första gången och spara dem för ev. framtida frågor.
- JA 初めてご使用になる前に、この説明書をよくお読みください。また、本書は将来いつでも参照できるように保管してください。
- ZH 请在初次使用前仔细阅读这些指示，并保留它们以便未来参考。
- AR يرجى قراءة هذه التعليمات بدقة قبل البدء بالاستعمال والاحتفاظ بها كمرجع للمستقل

EN ⚠ WARNING :
CHOKING HAZARD. - Small parts.
Not for children under 3 years.

FR ⚠ ATTENTION :
DANGER D'ÉTOUFFEMENT. - Présence de petits éléments.
Ne convient pas aux enfants de moins de 3 ans.

ES ⚠ ADVERTENCIA :
RIESGO DE ASFIXIA. - Contiene piezas pequeñas.
No recomendado para niños menores de 3 años.

DE ⚠ ACHTUNG :
ERSTICKUNGSGEFAHR. - Enthält kleine Teile.
Nicht für Kinder unter 3 Jahren geeignet.

NL ⚠ WAARSCHUWING :
VERSTIKKINGSGEVAAR. - Bevat kleine onderdelen.
Niet geschikt voor kinderen onder de 3 jaar.

IT ⚠ AVVERTENZA :
PERICOLO DI SOFFOCAMENTO. - Contiene piccole parti.
Non indicato per bambini sotto i 3 anni.

PT ⚠ ATENÇÃO :
PERIGO DE ASFIXIA. - Contém peças pequenas.
Não é concebido para crianças de menos de 3 anos.

PL ⚠ OSTRZEŻENIE :
ZAGROŻENIE ZADŁAWIENIEM. - Małe elementy.
Nie nadaje się dla dzieci poniżej 3 lat.

DA ⚠ ADVARSEL :
FARE FOR KVÆLNING. - Indeholder smådele.
Ikke til børn under 3 år.

EL ⚠ ΠΡΟΕΙΔΟΠΟΙΗΣΗ :
ΚΙΝΔΥΝΟΣ ΠΝΙΓΜΟΥ. - Περιέχει μικρά αντικείμενα.
Όχι για παιδιά κάτω των 3 ετών.

FI ⚠ VAROITUS :
TUKEHTUMISVAARA. - Sisältää pieniä osia.
Ei alle 3-vuotiaille lapsille.

NO ⚠ ADVARSEL :
KVELNINGSFARE. - Inneholder små deler.
Kun for barn over 3 år.

SV ⚠ VARNING :
KVÄVNINGSRISK. - Innehåller små delar.
Inte för barn under 3 år.

JA ⚠ 警告 :
のどにつまる危険 小さな部品が含まれています
3歳以下の子供には与えないで下さい。

ZH ⚠ 警告 :
噎住危险。包含有小部件
不适合3岁以下的小孩玩。

AR ⚠ تحذير :
خطر الاختناق - قطع صغيرة.
غير صالحة للأطفال أقل من 3 سنوات.

WARNING !
ATTENTION !
ADVERTENCIA !
ACHTUNG !
WAARSCHUWING !
AVVERTENZA !
ATENÇÃO !
OSTRZEŻENIE !
ADVARSEL !
ΠΡΟΕΙΔΟΠΟΙΗΣΗ !
VAROITUS !
ADVARSEL !
VARNING !
警告 !
警告 !
تحذير !



COLLECTOR SERIES
SERIE DI COLLETTORI
SÉRIE DO COLETOR
SERIA KOLEKTOR
COLLECTOR SERIES
SÉRIE DE COLLECTIONNEUR
SERIE DE COLECCIONISTA
SAMMLER SERIE
COLLECTOR SERIES

CALL OF DUTY®

COLLECTOR CONSTRUCTION SETS
JUEGO DE CONSTRUCCIÓN DE COLECCIONISTA
ENSEMBLES DE CONSTRUCTION DE COLLECTION
SAMMELBAUSÄTZE
BOUWSETS VOOR VERZAMELAARS
RACCOGLITORE SET DI COSTRUZIONE
JOGOS DE CONSTRUÇÃO DO COLETOR
KOLEKCJONERSKIE ZESTAWY KONSTRUKCYJNE

ACTIVISION®

© 2014 Activision Publishing, Inc. ACTIVISION, and CALL OF DUTY are trademarks of Activision Publishing, Inc.



* EACH SOLD SEPARATELY
* SE VENDEN PNE SEPARADO
* VENDIS SEPARATEMENT
* VERKÖPPT SEPARAT
* КАЖДОЕ ПРОДАЕТСЯ ОТДЕЛЬНО

SUPER POSEABLE MICRO ACTION FIGURES
FIGURAS PEQUEÑAS DE MÚLTIPLES POSICIONES
FIGURINES SUPER ARTICULÉES

СУПЕР-ГЕВЕРЛИКЕ ФИГУР | FIGURINJE KAN IN ALLENLEI
STANKE WURDEN GESET | PERSONAGGI SUPER
POZICIONABILI | FIGURA SUPER ARTICOLATE

INCLUDES 48 AUTHENTIC ACCESSORIES
INCLUYE 48 ACCESORIOS AUTÉNTICOS
COMPRENDE 48 ACCESSOIRES AUTHENTIQUES

INKLUSIVE 48 AUTHENTISCHE ZUBEHÖR
OMVAT 48 AUTHENTISCHE ACCESSOIRES
COMPRENDE 48 ACCESSORI AUTENTICI
INCLUI 48 ACESSÓRIOS AUTÉNTICOS

