

MEGA
BLOKS

MACHINES

THRASHER!



Ages / Anos

Pieces / Piezas

5+

130

 **WARNING:**
CHOKING HAZARD – Small parts.
Not for children under 3 years.

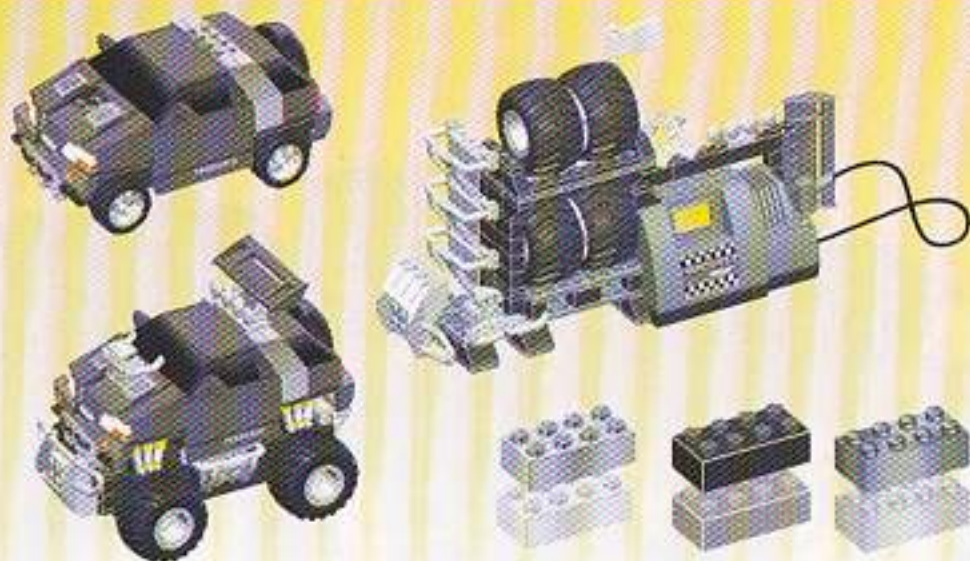

Color chart.

Charte de couleurs.

Cuadro cromático.

**Diagramma
colorimetrico.**

Färgtabell.

Kleurkaart.

カラーチャート

彩圖

Active step / Étape active / Etapa activa / Istruzione attuale
Aktiv skede / Folgende stap / 現在の段階 / 現段階

Previous step / Étape précédente / Etapa precedente / Istruzione
precedente / Föregående skede / Vorige stap / 前の段階 / 前段階



Adult assistance is required. / L'aide d'un adulte est requise. / Necesita ayuda de un adulto. / L'aiuto di un adulto è richiesto. /
Hjälp av en vuxen är nödvändigt. / Hulp van volwassenen is gewenst. / 大人の補佐が必要です。 / المطلوب المساعدة من الكبار / 小零件有窒息危险。

⚠ WARNING:

Choking hazard— Small parts.
Not for children under 3 years.

⚠ AVERTISSEMENT:

Risque de suffocation. Ne convient pas à
un enfant de moins de 3 ans - contient de
petits éléments.

⚠ ADVERTENCIA:

Peligro de asfixia. No recomendado para niños
menores de 3 años—contiene piezas pequeñas.

⚠ AVVERTENZA:

Rischio di soffocamento. Non adatta ad un
bambino di età minore ai 36 mesi. Contiene parti
piccole - non ingerire.

⚠ VARNING:

Risk för kvävning. Ikke egnet til barn under
3 år - inneholder smådeler.

⚠ WAARSCHUWING:

Stikgevaar. Niet geschikt voor kinderen onder
3 jaar - i.v.m. kleine onderdelen.

⚠ 注意:

飲み込むと危険です。
小さいパーツがあるので、
3歳以下の幼児には
与えないでください。

⚠ 不适于三岁以下儿童。



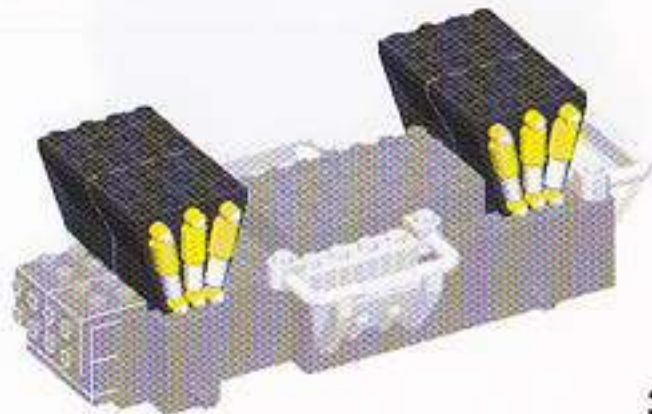
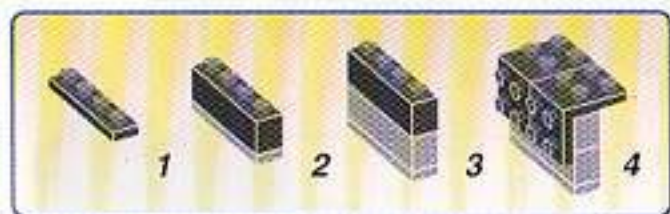
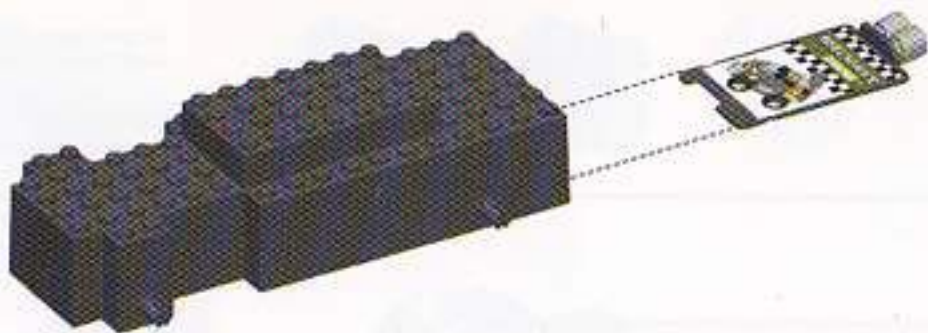



Active step / Étape active / Etapa activa / Istruzione attuale
Aktiv skede / Folgende stap / 现在的手续 / 现阶段

Previous step / Étape précédente / Etapa precedente / Istruzione precedente
Föregående skede / Vorige stap / 以前的手续 / 前阶段

4



1x



1x



1x



1



2



5



3x

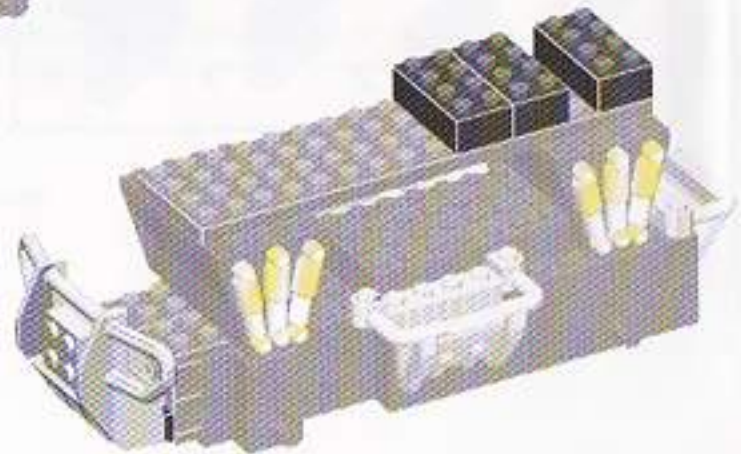

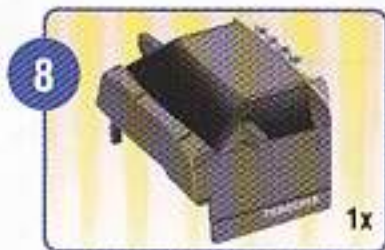
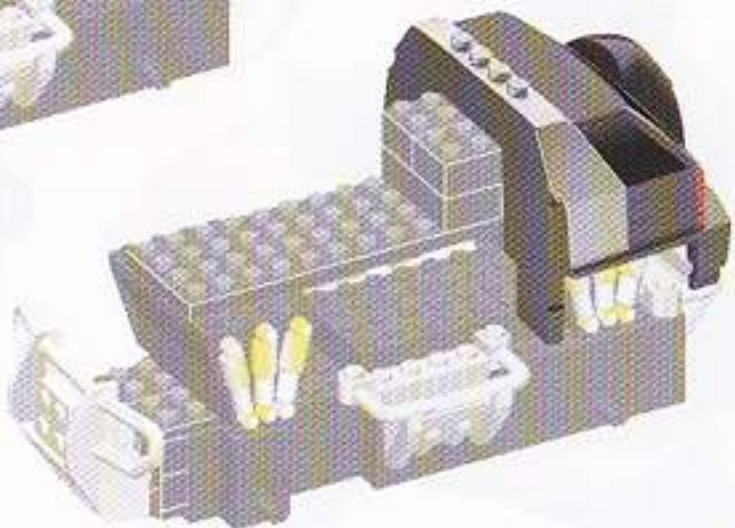
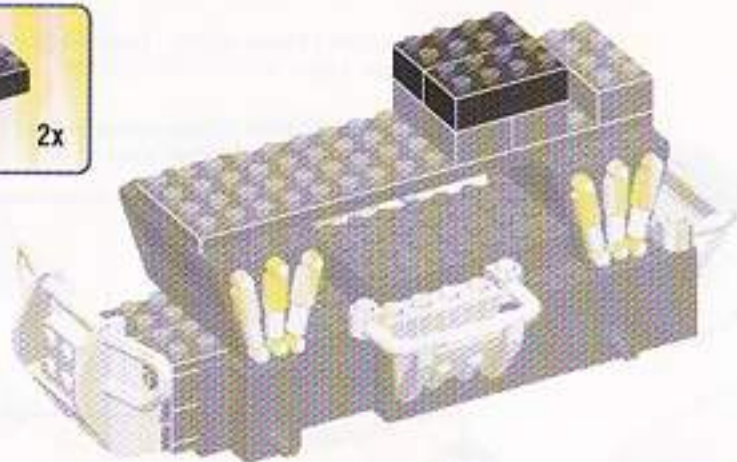



Active step / Étape active / Etapa activa / Istruzione attuale
Aktiv skede / Folgende stap / 现在的步骤 / 现阶段

Previous step / Étape précédente / Etapa precedente / Istruzione precedente
Föregående skede / Vorige stap / 以前的步骤 / 前阶段

9



2x



1x

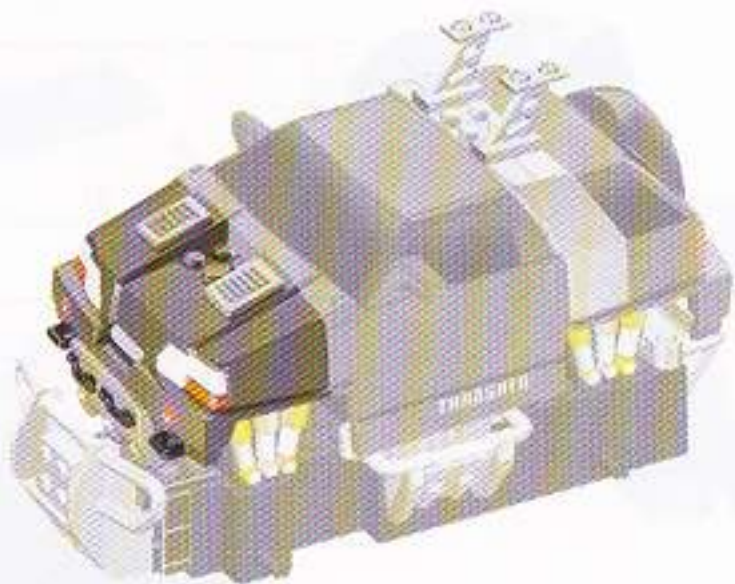

10



1x



1x



1x



1x



1x



1



2



3

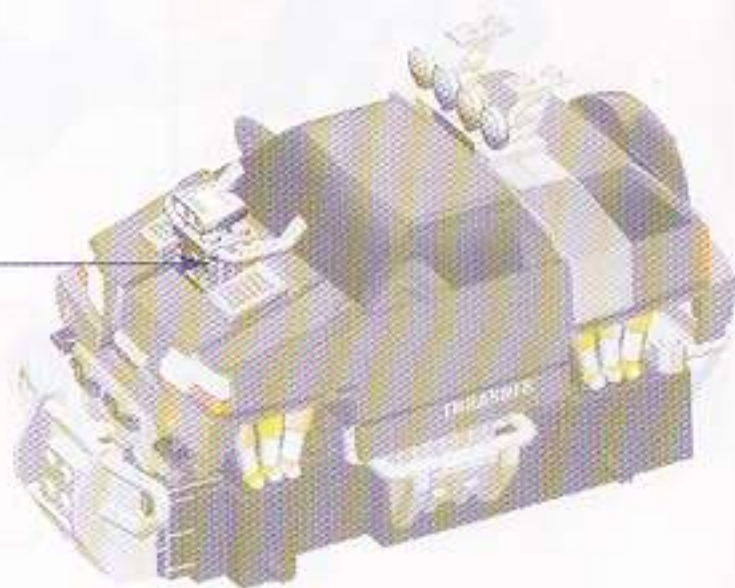

11



2x



2x



1x

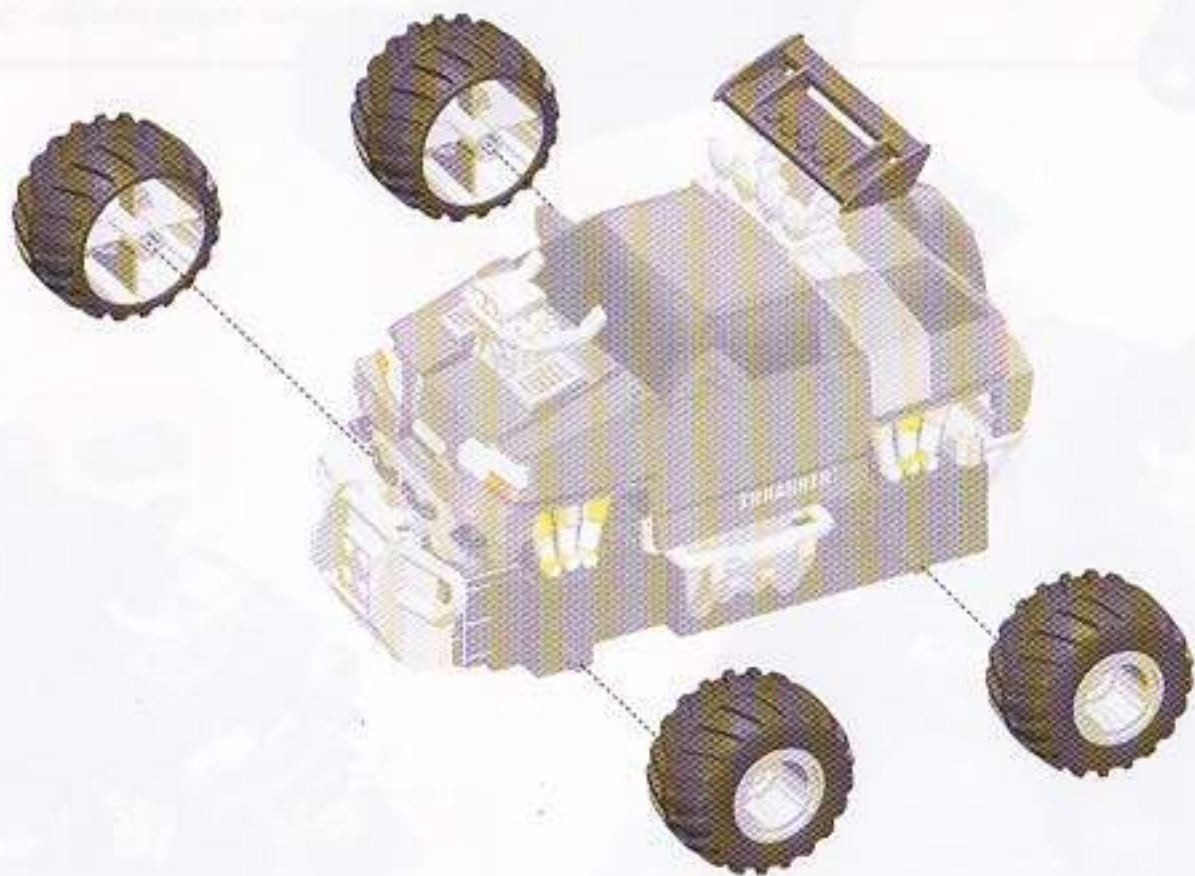



Active step / Étape active / Etapa activa / Istruzione attuale
Aktiv skede / Folgende stap / 此步为步骤 / 观段階

Previous step / Étape précédente / Etapa precedente / Istruzione precedente
Föregående skede / Yorige stap / 此步为前步 / 前段階

12



13



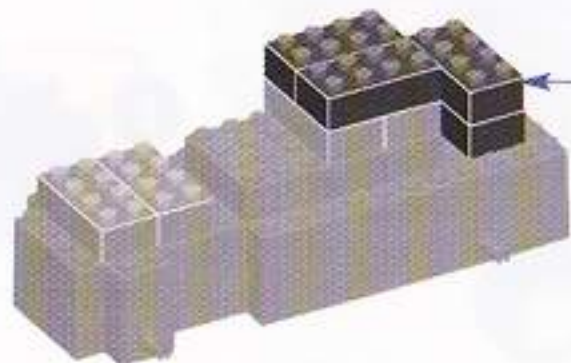
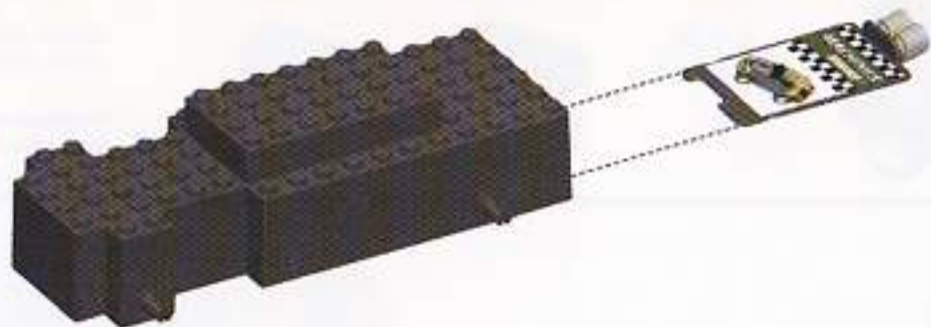



Active step / Étape active / Etapa activa / Istruzione attuale
Aktiv skede / Volgende stap / 現在の手順 / 现阶段

Previous step / Étape précédente / Etapa precedente / Istruzione precedente
Föregående skede / Vorige stap / 从前的步骤 / 前阶段

4

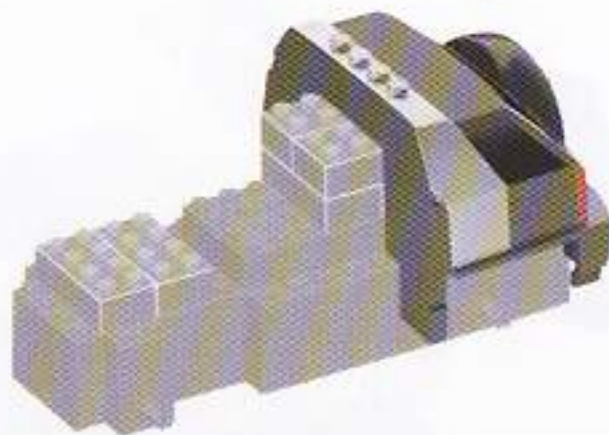

5

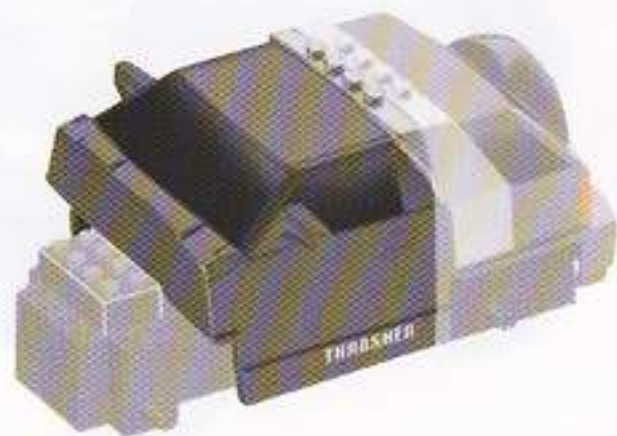

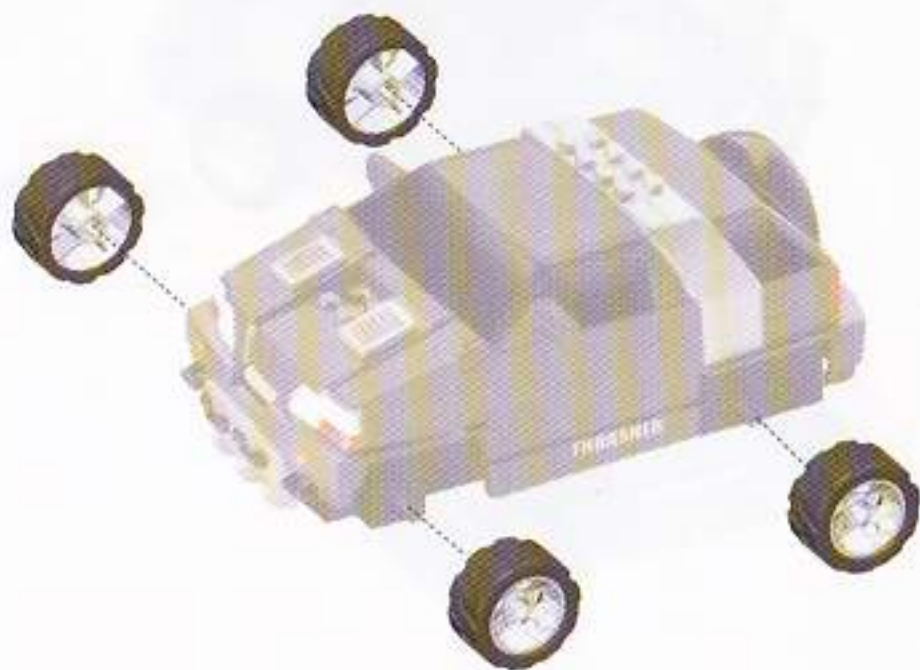
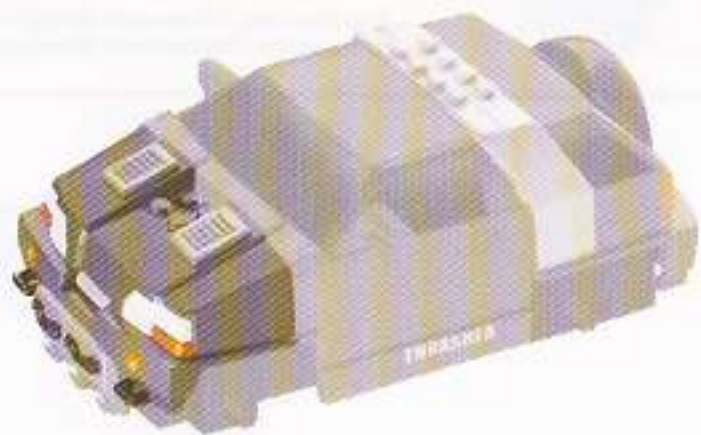



Active step / Étape active / Etapa activa / Istruzione attuale
Aktiv skede / Folgende stap / 現在のステップ / 現段階

Previous step / Étape précédente / Etapa precedente / Istruzione precedente
Föregående skede / Vorige stap / 以前のステップ / 前段階

8



9



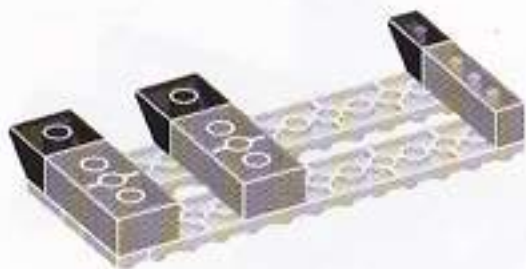
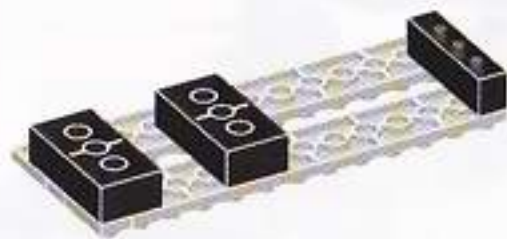
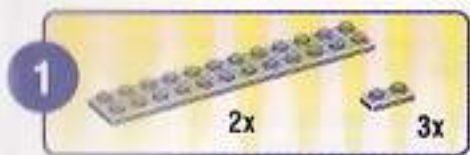

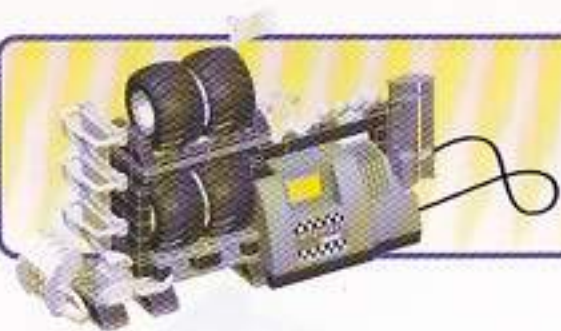

Active step / Étape active / Etapa activa / Istruzione attuale
Aktiv skede / Folgende stap / 現在のステップ / 現段階

Previous step / Étape précédente / Etapa precedente / Istruzione precedente
Föregående skede / Vorige stap / 前のステップ / 前段階

5



6

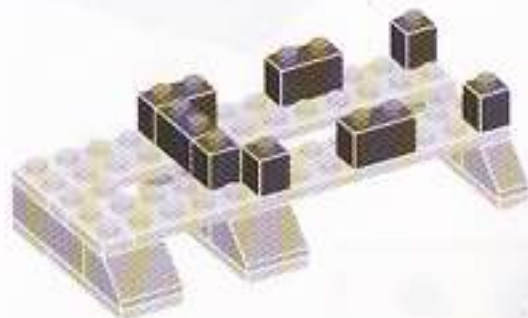

7

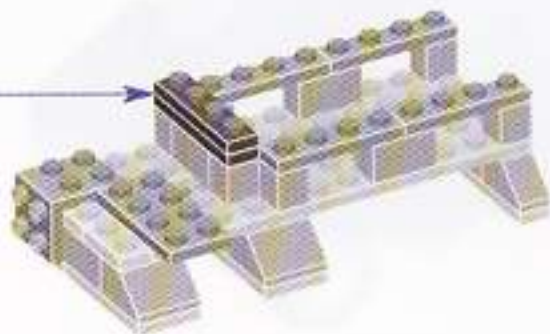

8

1x 1x 1x 2x

1

2

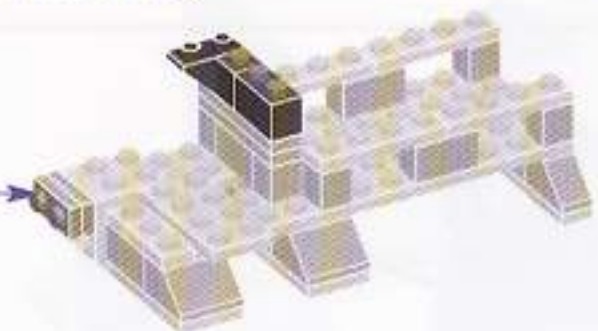

9

2x

1

2

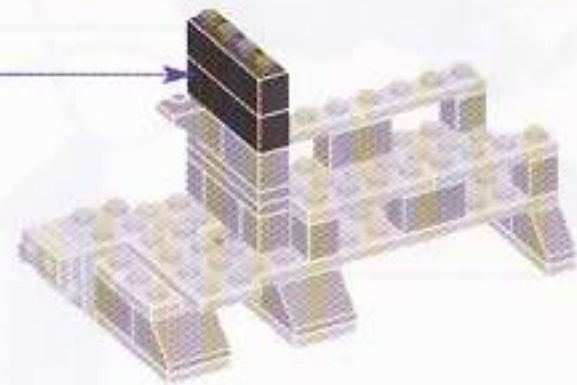

10

1x 1x 1x

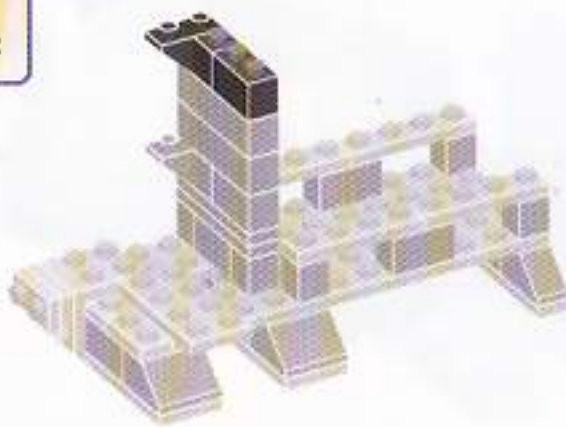

11

1x





Active step / Étape active / Etapa activa / Istruzione attuale
Aktiv skede / Folgende stap / 活のステップ / 現段階

Previous step / Étape précédente / Etapa precedente / Istruzione precedente
Föregående skede / Vorige stap / 前のステップ / 前段階

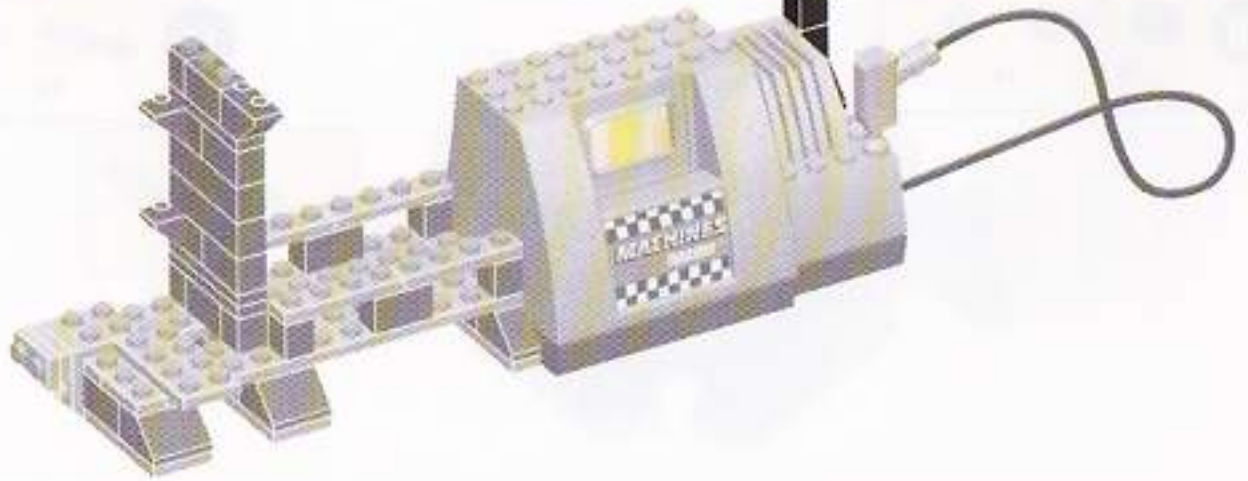
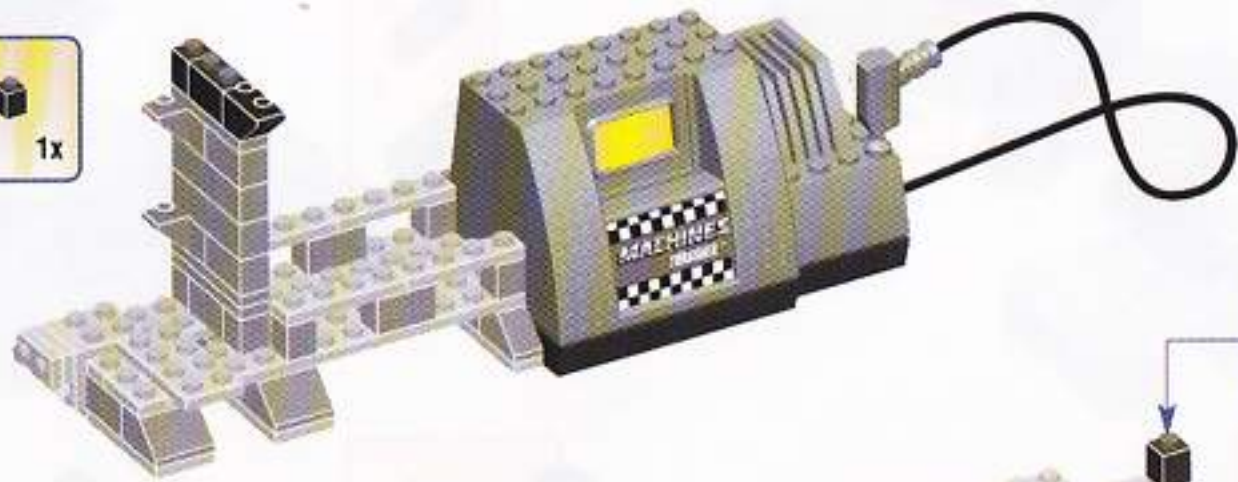

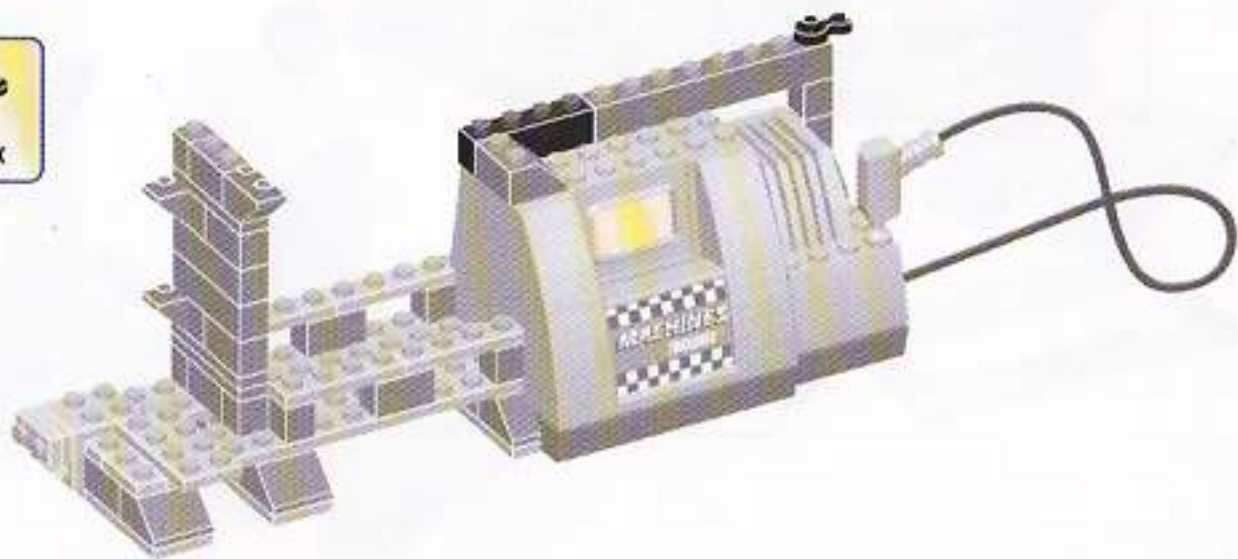
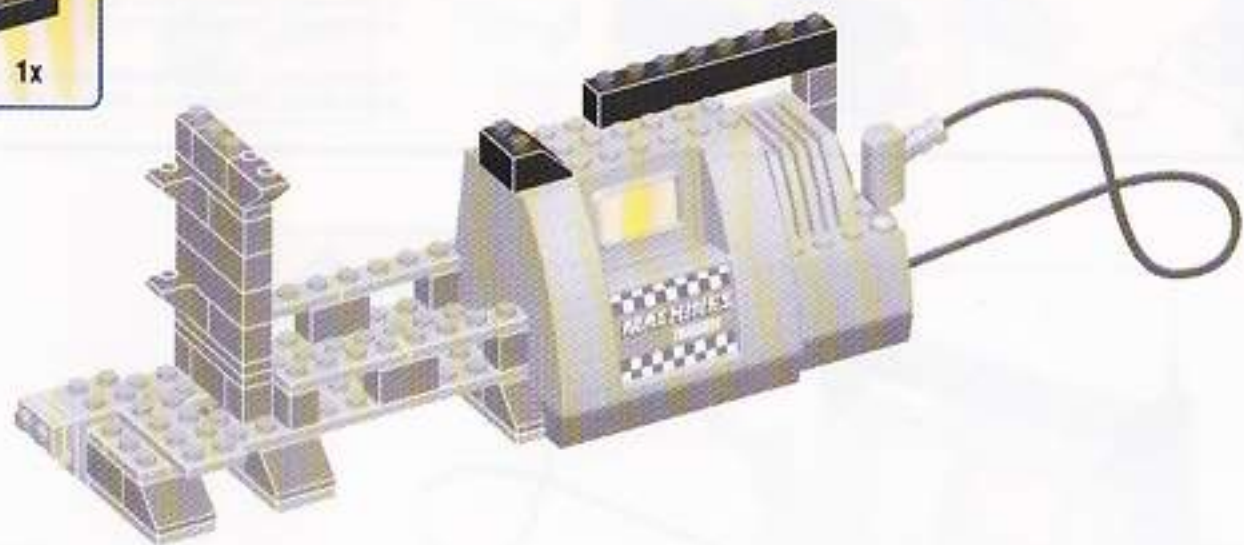

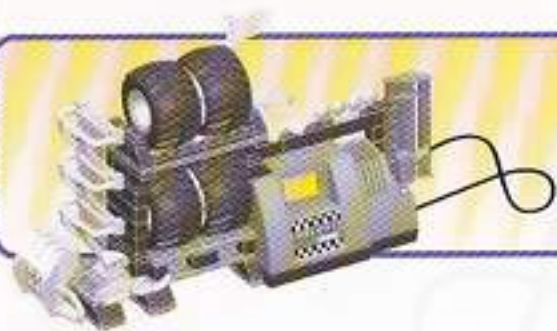

Active step / Étape active / Etapa activa / Istruzione attuale
Aktiv skede / Folgende stap / 下一个步骤 / 现阶段

Previous step / Étape précédente / Etapa precedente / Istruzione precedente
Föregående skede / Vorige stap / 上一个步骤 / 前阶段



16

2x



1

2

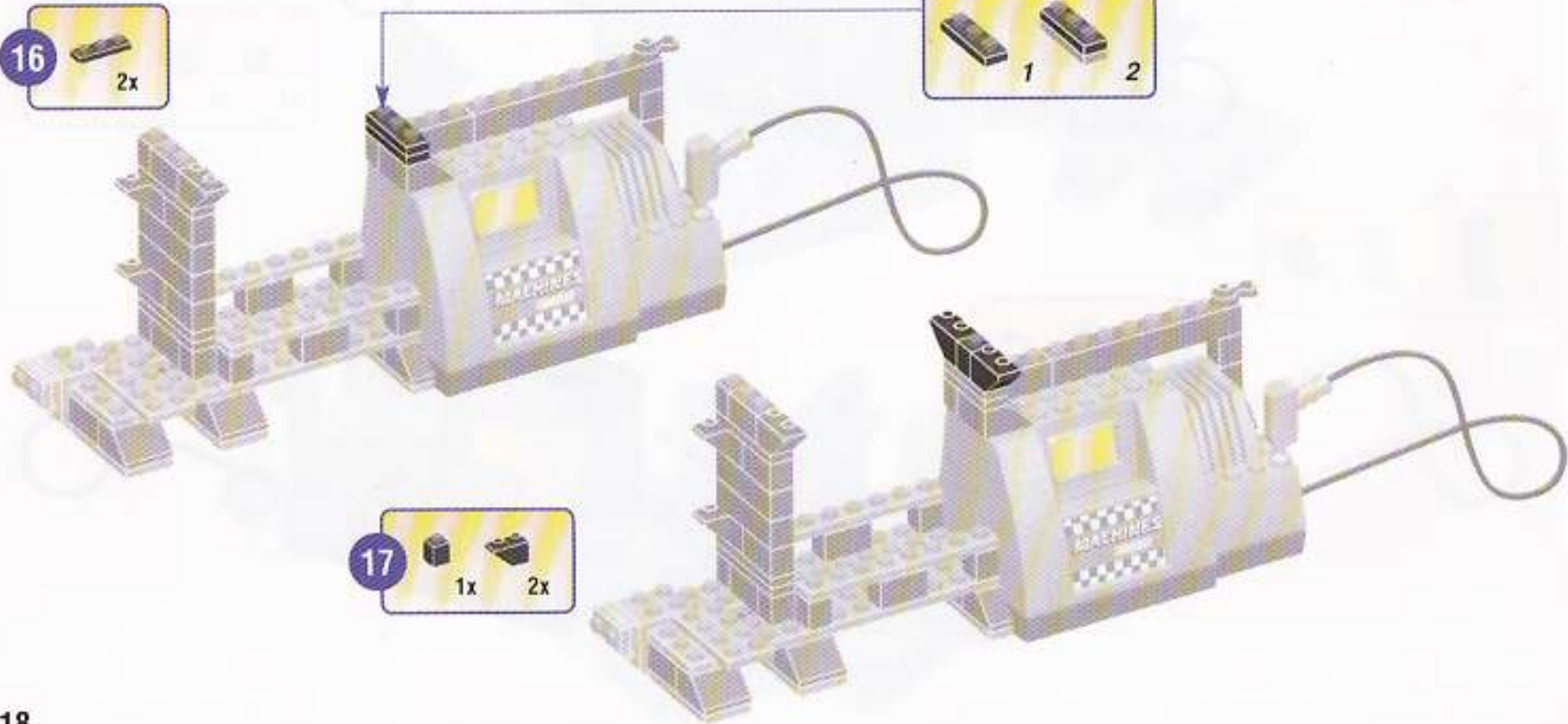

17

1x

2x

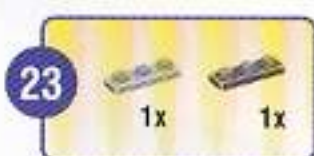
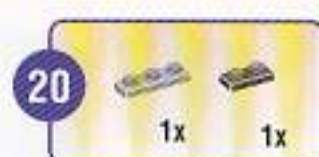
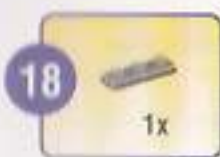



Active step / Étape active / Etapa activa / Istruzione attuale
Aktiv skede / Folgende stap / 10, 11, 12, 13, 14, 15, 16, 17, 18, 19

Previous step / Étape précédente / Etapa precedente / Istruzione precedente
Föregående skede / Vorige stap / 1, 2, 3, 4, 5, 6, 7, 8, 9

26



2x



27



4x



28

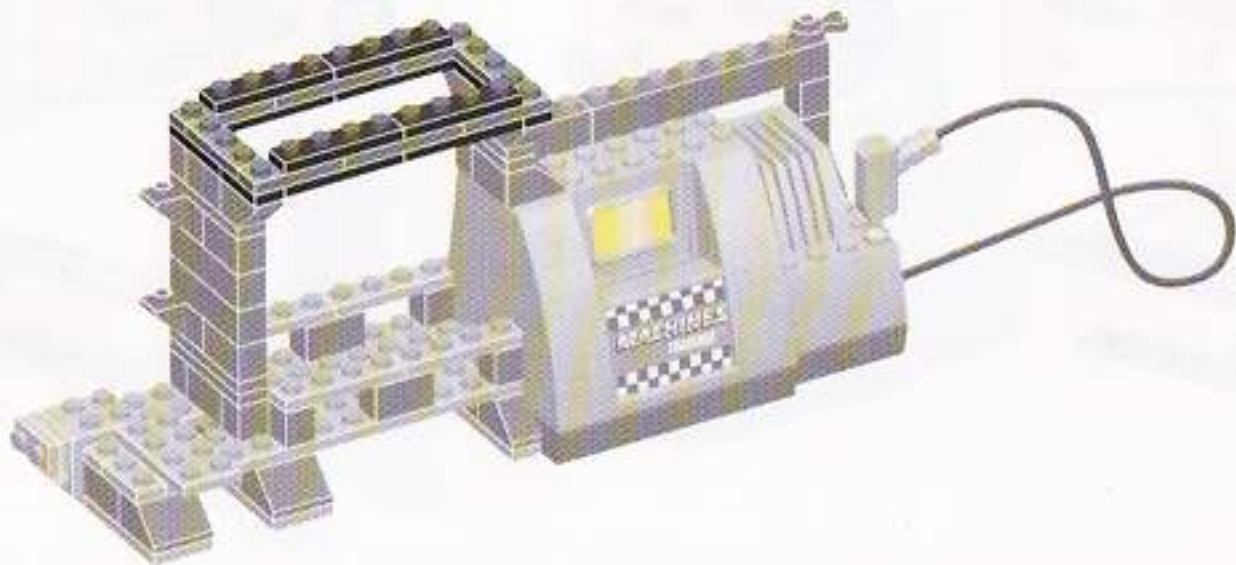

29

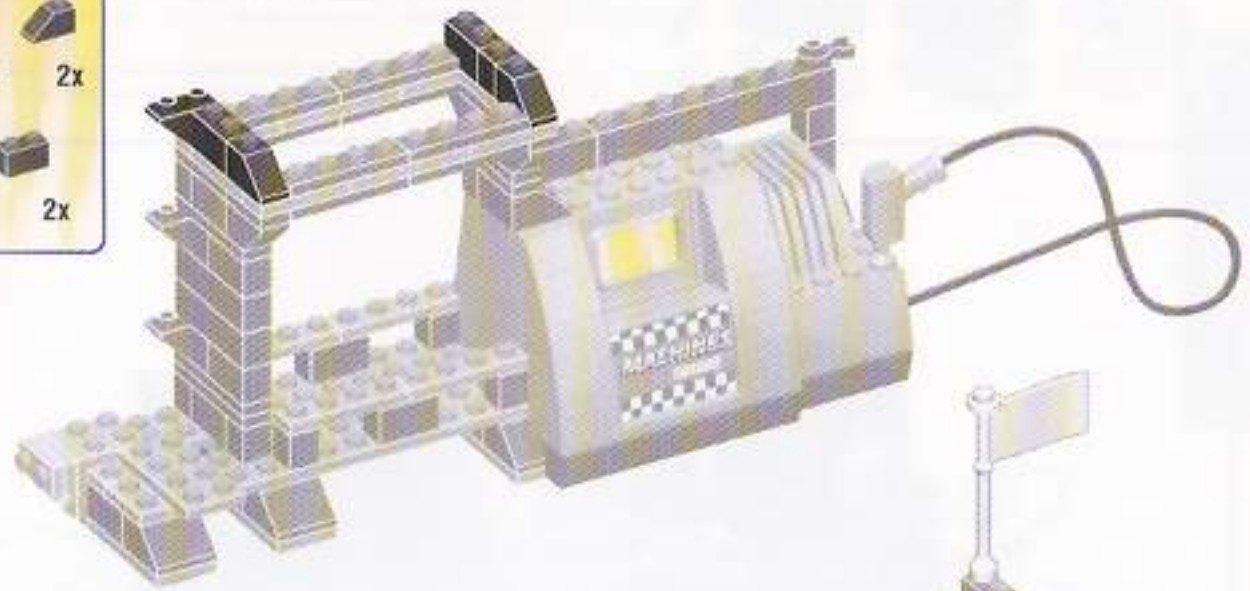

30

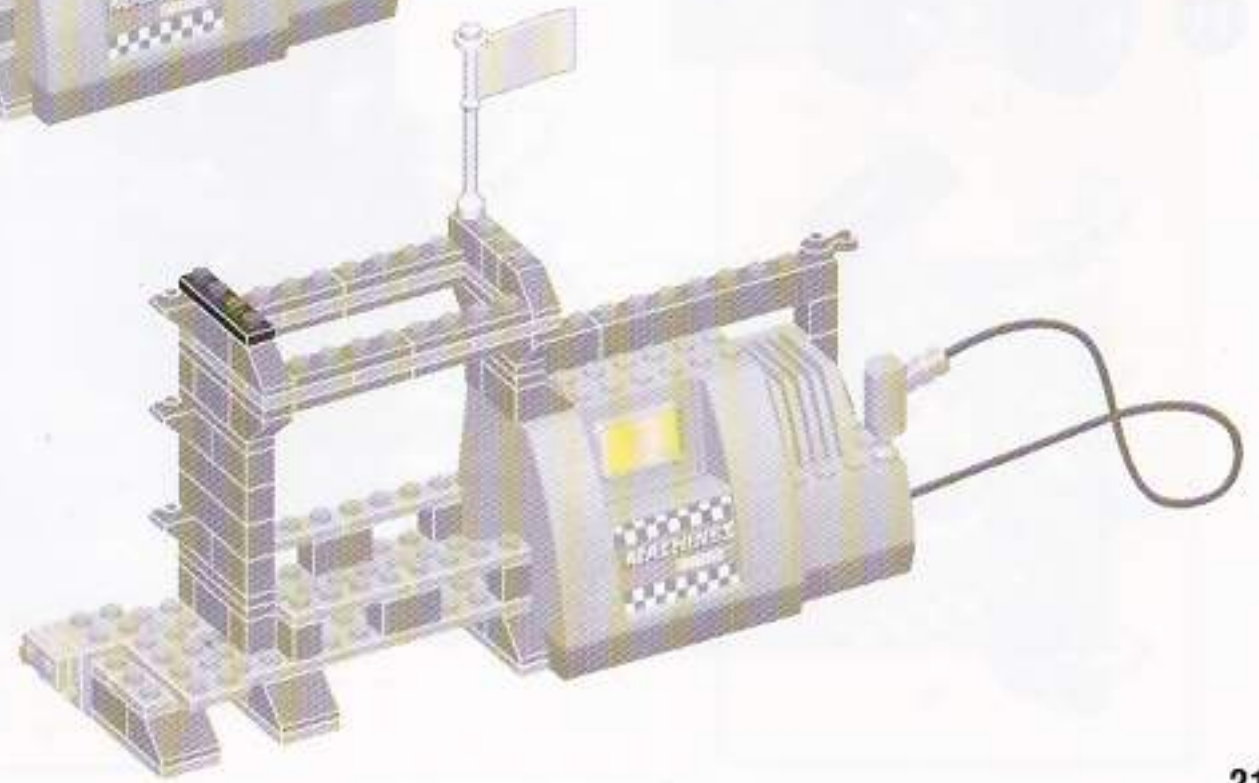



Active step / Étape active / Etapa activa / Istruzione attuale
 Aktiv skede / Folgende stap / 現段階 / 現段階

Previous step / Étape précédente / Etapa precedente / Istruzione precedente
 Föregående skede / Vorige stap / 前段階 / 前段階

31

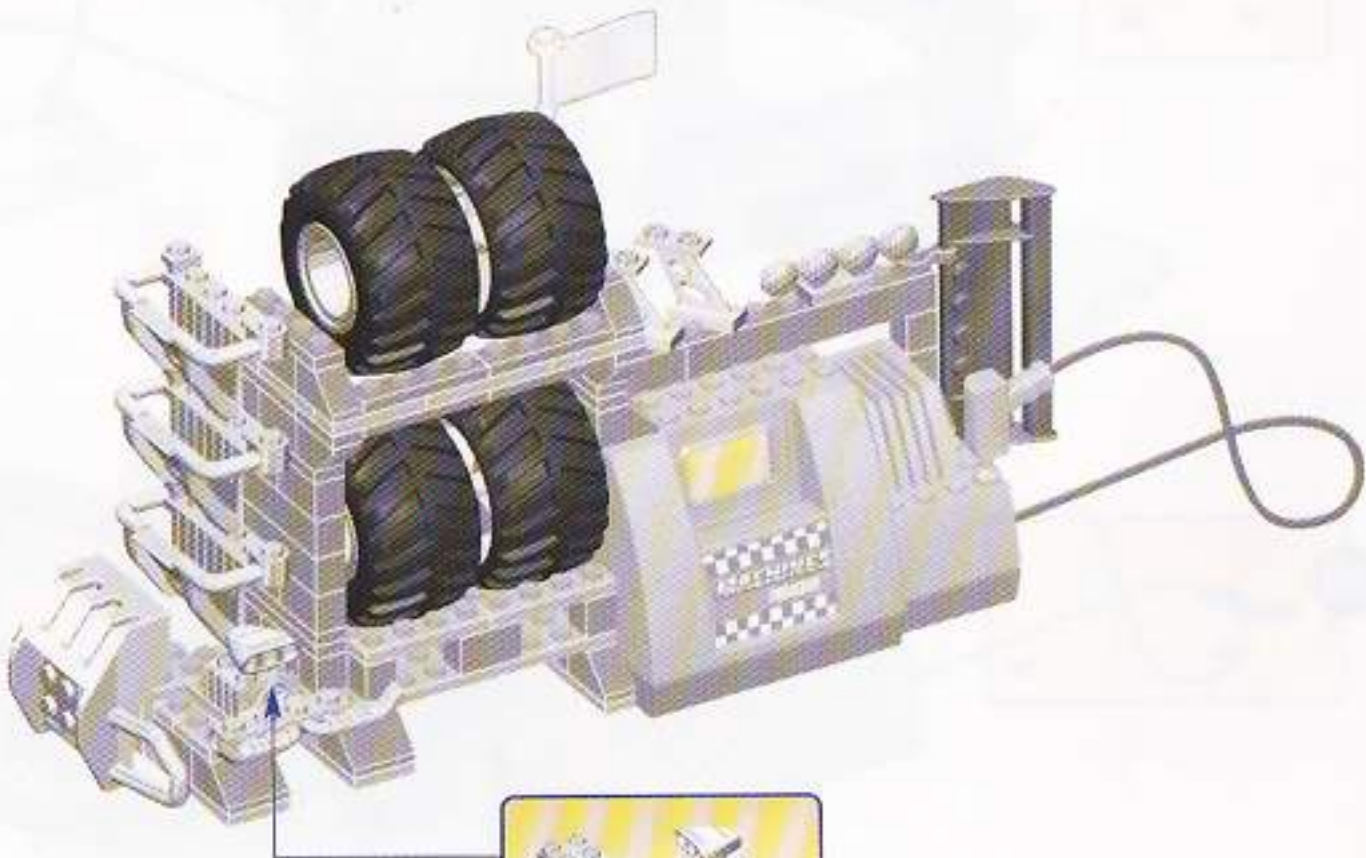

32



1x

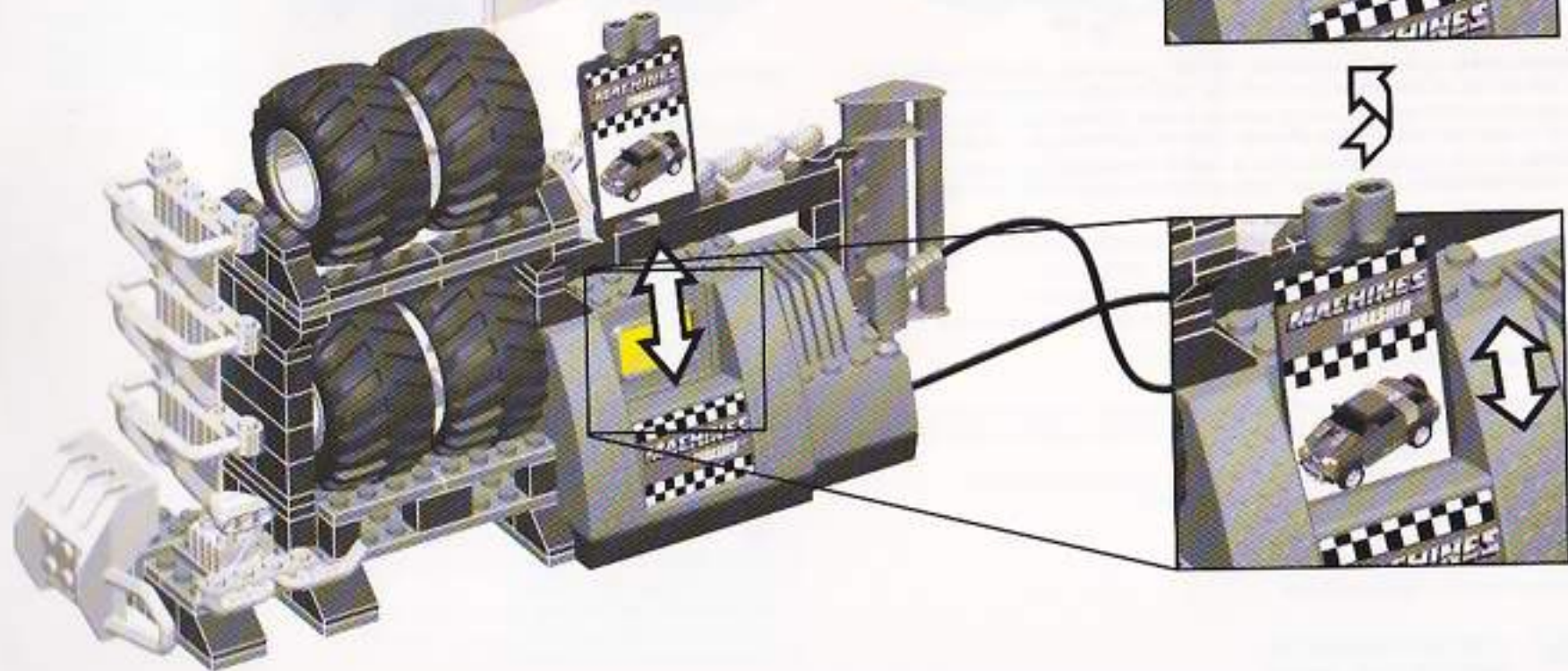

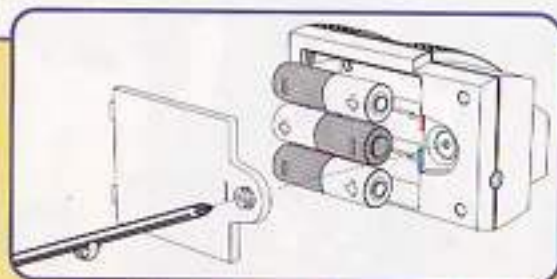

- Batteries included with this toy are for demonstration "TRY ME" purpose only. In order to get the best performance from this toy, we recommend that 3 fresh "AA" alkaline batteries be inserted prior to use.
- Les piles incluses avec ce jouet ne servent que pour activer le mode de démonstration. Afin de maximiser le rendement de ce jouet, nous recommandons d'installer 3 piles AA alcalines neuves avant de l'utiliser.
- Las pilas incluidas con este juguete permiten activar el modo de demostración únicamente. A fin de lograr un funcionamiento óptimo, cámbielas por 3 pilas AA alcalinas nuevas antes de utilizar el juguete.

- Requires (3) 1.5V (AA, R-6, SUM-3) Batteries. 4.5V \approx 0.15A. Non rechargeable batteries included.
- Fonctionne à l'aide de trois (3) piles 1,5 V (AA, R-6, SUM-3). 4.5V \approx 0,15A. Piles comprises. Les piles fournies dans le jouet ne doivent pas être rechargées.
- Requiere (3) pilas de 1,5 V (AA, R-6, SUM-3). 4.5V \approx 0,15A. Incluye pilas no recargables.

CAUTION: TO AVOID BATTERY LEAKAGE:

1. Be sure to install the batteries correctly (see diagram) and always follow the toy and battery manufacturers' instructions.
2. Do not mix used and new batteries together. Do not mix alkaline, standard (carbon zinc), or rechargeable (nickel cadmium) batteries. Only batteries of the same type are to be used.
3. Always remove exhausted or dead batteries from the product and always remove batteries before extended storage.
4. Rechargeable batteries are only to be charged under adult supervision (if removable).
5. Non rechargeable batteries are not to be recharged.
6. The supply terminal is not to be short circuited.
7. Batteries are to be inserted according to the correct polarity. (see diagram)
8. How to remove and insert replaceable batteries. (see diagram)



AVERTISSEMENT: POUR ÉVITER LA FUITE DES PILES:

1. S'assurer d'installer les piles ou accumulateurs correctement (voir le diagramme) en suivant toujours les instructions du fabricant du jouet et des piles.
2. Ne pas mélanger des piles neuves et usagées. Ne pas mélanger des piles alcalines, standards (carbone-zinc) ou rechargeables (nickel-cadmium). Seuls des piles ou accumulateurs de type recommandé ou d'un type similaire doivent être utilisés.
3. Les piles et accumulateurs usagés doivent être enlevés du jouet, avant le rangement pour une longue période.
4. Les accumulateurs doivent être enlevés du jouet avant d'être chargés et les accumulateurs doivent être chargés que sous la surveillance d'un adulte.
5. Ne jamais recharger des piles (non-rechargeables).
6. Les bornes d'une pile ou d'un accumulateur ne doivent pas être mises en court-circuit.
7. Les piles et accumulateurs doivent être mis en place en respectant la polarité. (voir le diagramme)
8. Comment enlever et mettre en place les piles ou accumulateurs remplaçables. (voir le diagramme)

ADVERTENCIA: PARA EVITAR QUE LAS PILAS SE SULFATEN:

1. Asegúrese de colocar las pilas correctamente (ver diagrama) y de seguir las instrucciones de los fabricantes del juguete y de las pilas.
2. No mezclar pilas nuevas con pilas usadas ni tampoco acumuladores (níquel cadmio) o pilas de tipos diferentes (alcalinas, carbono zinc). Siempre utilice pilas del mismo tipo.
3. Siempre retire las pilas agotadas o gastadas del juguete, especialmente si piensa guardarlo por tiempo prolongado.
4. Un adulto debe recargar las pilas recargables (siempre que las pueda retirar).
5. No recargue pilas que no sean recargables.
6. No origine cortocircuitos en los bornes del compartimiento de las pilas.
7. Coloque las pilas respetando la polaridad correcta. (ver diagrama)
8. Cómo sacar e introducir las pilas reemplazables. (ver diagrama)

PROBLEMS? PLEASE DO NOT TAKE THIS TOY BACK TO THE STORE. / VOUS AVEZ DES PROBLÈMES? ON VOUS PRIERAIT DE NE PAS RETOURNER VOTRE JOUET AU MAGASIN. / ¿TIENE PROBLEMAS? NO DEVUELVA EL JUGUETE AL COMERCIO DONDE LO ADQUIRIÓ.

CONTACT US / CONTACTEZ-NOUS / COMUNIQUESE CON NOSOTROS

1-800-465-MEGA
INFO@MEGABLOKS.COM

Ritvik

© 2001, RITVIK HOLDINGS INC.
PRINTED IN CHINA D092631